

EX LIBRIS

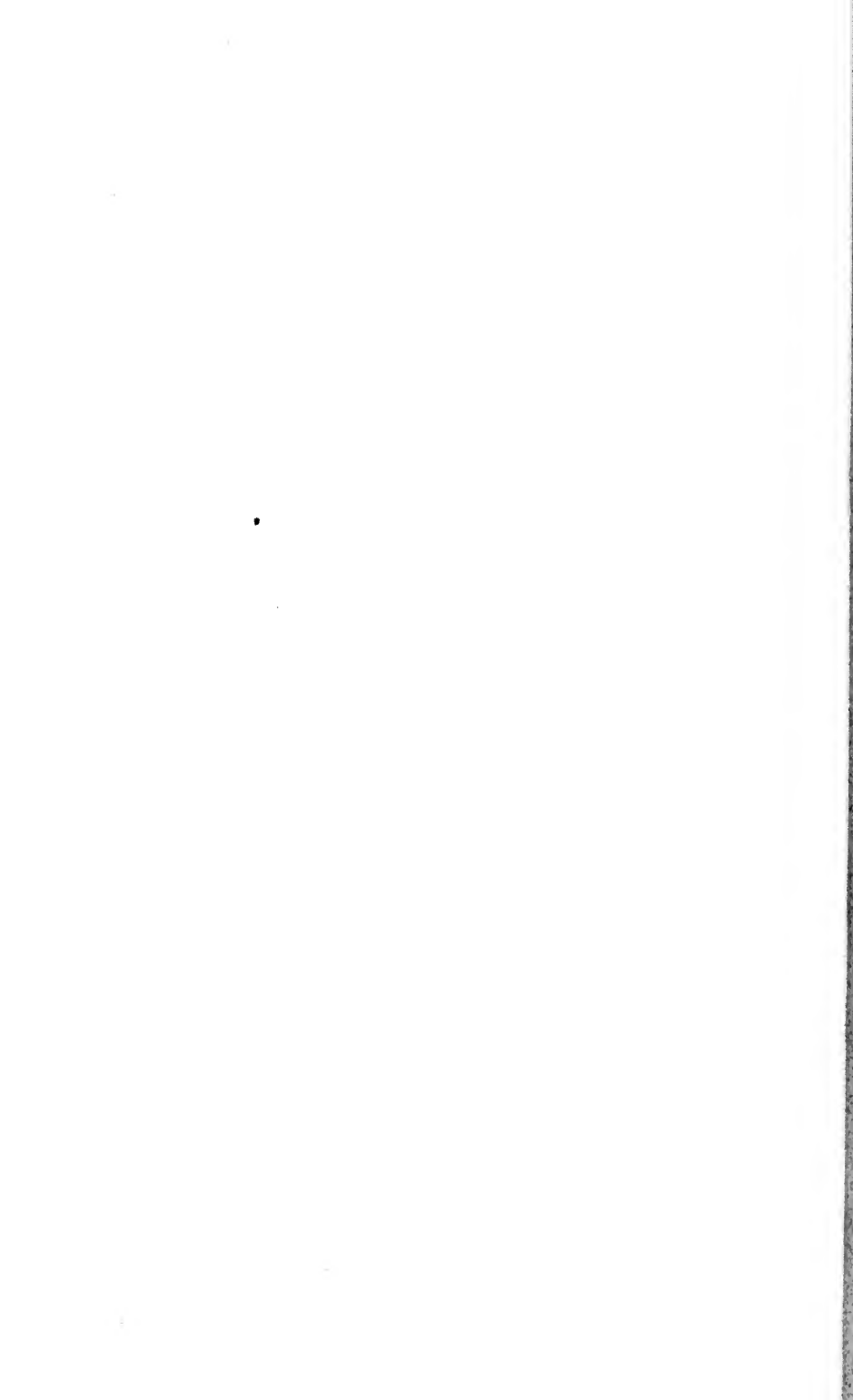









A PRACTICAL MANUAL

OF

MINERALS, MINES, AND MINING.





# A PRACTICAL MANUAL

OF

# MINERALS, MINES, AND MINING:

COMPRISING

SUGGESTIONS AS TO THE LOCALITIES AND ASSOCIATIONS  
OF ALL THE USEFUL MINERALS,

FULL DESCRIPTIONS OF THE MOST EFFECTIVE METHODS FOR BOTH THE  
QUALITATIVE AND QUANTITATIVE ANALYSES OF  
EACH OF THESE MINERALS,

AND

HINTS UPON THE VARIOUS OPERATIONS OF MINING, INCLUDING  
ARCHITECTURE AND CONSTRUCTION.

BY

PROF. H. S. OSBORN, LL.D.,

AUTHOR OF "THE METALLURGY OF IRON AND STEEL."

ILLUSTRATED BY ONE HUNDRED AND SEVENTY-ONE ENGRAVINGS.



PHILADELPHIA:  
HENRY CAREY BAIRD & CO.,  
INDUSTRIAL PUBLISHERS, BOOKSELLERS, AND IMPORTERS,  
810 WALNUT STREET.

LONDON:  
E. & F. N. SPON,  
125 STRAND.  
1888.

TT 145  
08

---

COPYRIGHT BY  
HENRY CAREY BAIRD & CO.,  
1887.

---

43239

---

COLLINS PRINTING HOUSE,  
705 Jayne Street.

## P R E F A C E .

---

THE object of this manual is to place before the practical mineralogist and miner all the important help which may be derived from the present state of knowledge as it bears upon the departments of useful mineralogy, mining, and mines. We have intended to make use of the best results, not only of experiment, but of successful work, and, therefore, only the best methods have been, in most cases, presented. Nevertheless, it frequently happens that a method adopted in one condition, or under certain circumstances, must be modified under other conditions, and there may be sound reasons for adopting another method to attain the same result. Hence, where it is difficult to pronounce upon one method, we have given an alternative.

In chemical analyses and reductions, especially in the methods of detection or determination, we have confined ourselves to that method which was simplest in treatment. In practical and most technical work much depends upon the manipulation—indeed, more depends upon the neatness and the judgment of the chemist than upon his method or the process he has adopted.

This work is divided into two principal parts and one subordinate. The FIRST PART treats of the useful minerals—their physical properties, geologic positions, local occurrence, and associations; their methods of chemical analysis when we wish to determine their natures and richness; their furnace or dry assay; and their probable present commercial values and uses;

together with such cautions which long experience has proved that the miner and practical mineralogist should observe in his researches. The SECOND PART describes the various methods of excavating and of timbering. It includes all brick and masonry work during driving, lining, bracing, and other operations included in general or special mining architectural work.

Following, Part II., the practical work of digging and boring artesian and other deep wells is fully described, with notices of the tools used and how to provide for the accidents and difficulties sometimes met with in these operations.

OXFORD, OHIO,

December 15, 1887.

# CONTENTS

## PART I.

### MINING MINERALOGY, AND ECONOMIC TREATMENT AND HISTORY OF THE USEFUL MINERALS.

#### MINING MINERALOGY.

##### PRELIMINARY PRINCIPLES AND PREPARATIONS.

	PAGE
Necessary requirements for the successful study of mining mineralogy . . . . .	17
Crystallization, and importance of a knowledge of it . . . . .	18
Hardness of minerals an important characteristic in their determination . . . . .	19
Cleavage; Fracture; Color; Streak . . . . .	20
Specific gravity; Explanation of; Great importance of, in mineralogy; Method for determining . . . . .	21
Practical uses of to miners and artisans . . . . .	26
The blow-pipe; Description of, and manner of using it . . . . .	27
Collection of materials for blow-pipe practice . . . . .	28
Preparatory practice; Hints for beginners . . . . .	29
For practice in assaying . . . . .	30
Directions for removing the bead . . . . .	32
Magnetism; Application of, in determining minerals; Cupellation . . . . .	33
Muffle; Substitute for . . . . .	34
In review . . . . .	35
Chemical analysis; Elementary principles of chemistry; The elements . . . . .	36
Combining weights of elementary bodies; Table of atomic weights . . . . .	38
Note, explanatory of the foregoing table . . . . .	39
The practical use of the table of atomic weights . . . . .	39
The groups; Grouping of compounds forming a convenient classification for the student, in their relation to the action of reagents:	
First. Metallic oxides not precipitated from their solutions by sulphuretted hydrogen, hydrosulphuret of ammonia, or alkaline carbonates—the alkalis proper . . . . .	42

	PAGE
Second. Metallic oxides not precipitated from their solutions by sulphuretted hydrogen, but precipitated by hydrosulphuret of ammonia only under certain circumstances, as salts, and also precipitated by alkaline carbonates—the alkaline earths . . . . .	42
Third. Metallic oxides not precipitated by sulphuretted hydrogen but precipitated as oxides by hydrosulphuret of ammonia . . . . .	42
Fourth. Metallic oxides not precipitated from their acid solutions by sulphuretted hydrogen but completely precipitated by hydrosulphuret of ammonia as sulphurets . . . . .	42
Fifth. Metallic oxides completely precipitated from their solutions, whether acid, alkaline, or neutral, by sulphuretted hydrogen, their sulphurets being insoluble in alkaline hydrosulphurets . . . . .	42
Sixth. Metallic oxides completely precipitated from their acid solutions by sulphuretted hydrogen but not from their alkaline solutions, their sulphurets being soluble in alkaline sulphurets . . . . .	43
Reagents; Water . . . . .	43
Alcohol; Hydrogen . . . . .	44
Chlorine . . . . .	45
Bromine and Iodine . . . . .	46
Oxygen; Iron . . . . .	48
Zinc; Tin; Hydrochloric acid . . . . .	49
Nitric acid; Aqua regia; Sulphuric acid . . . . .	50
Hydrosulphuric acid gas . . . . .	51
Acetic acid; Oxalic acid; Succinic acid; Tartaric acid . . . . .	52
Sulphurous acid or anhydride; Carbonic dioxide; Molybdic acid; Potassa . . . . .	53
Soda; Ammonia; Lime-water; Alumina; Litharge . . . . .	54
Oxide of copper; Nitrate of potassium; Sulphate of potassium; Carbonate of potassium; Black flux . . . . .	55
Chlorate of potassium; Permanganate of potassium . . . . .	56
Sulphocyanide of potassium; Chloride of sodium; Sulphuret of sodium . . . . .	57
Sulphite of sodium; Carbonate of sodium; Borax; Phosphate of sodium; Acetate of sodium; Succinate of sodium . . . . .	58
Nitro prusside of sodium; Chloride of ammonium; Hydrosulphide of ammonium; Molybdate of ammonium; Acetate of ammonium . . . . .	59
Oxalate of ammonium; Neutral succinate of ammonium; Chloride of barium; Nitrate of barium; Carbonate of barium . . . . .	60
Chloride of calcium; Sulphate of Magnesium; Nitrate of silver . . . . .	61
Litmus paper; Red litmus paper; Salt of lead paper; Microcosmic salt . . . . .	63
Cautions and suggestions; Selecting a room for a laboratory . . . . .	63
Sand bath; Assay furnace; Construction of, illustrated and described . . . . .	64
Analytical scales; Requirement for . . . . .	67
How to use reagents and glassware . . . . .	68
Caution; The use of reagents; Heating glassware . . . . .	69

	PAGE
Heating flasks and beaker glasses; Water . . . . .	70
A list of usual chemical apparatus . . . . .	71
List of chemicals . . . . .	72
Folding filter papers; Inverted cone of platinum foil in a filtering funnel .	73
Filtering apparatus, illustrated and described . . . . .	75
Platinum crucibles; Brasque . . . . .	77
Fuming nitric acid and its use . . . . .	78
Sodium disulphate and its use with powdered assays . . . . .	79

### ECONOMIC TREATMENT AND HISTORY OF THE USEFUL MINERALS.

Treatment of the important minerals; Comparative standard of the hardness of a mineral . . . . .	81
Table of comparative hardness of minerals . . . . .	82

### GOLD.

Occurrent condition and form in nature; Native; Hardness and specific gravity; Color; Ductility and malleability; Composition . . . . .	83
United States localities . . . . .	84
Mines of South America and Mexico . . . . .	86
Total annual production of gold in the United States . . . . .	87
Geology of gold and its associations; Its combinations with sulphur . . . . .	88
European localities where gold has been found; Australian deposits . . . . .	89
Gold in gravels and sands of rivers; Its occurrence in rocks; Chemical action in gold mines of North Carolina . . . . .	90
Gold deposits of North Carolina . . . . .	91
Native gold; Great variety in the fineness of . . . . .	92
Alloys of gold with silver; Assay of California gold by Parisian chemists . . . . .	93
The characteristics of the gold of North Carolina, California, Colorado, and other American localities; Australian gold, variations of and classification of mines; Study of the natural alloys and accompaniments of gold . . . . .	94
Two curious facts connected with gold affinities and alloys; Gold extracted from galena found in Bucks County, Pa. . . . .	95
Methods of treating gold alloys; Refining of gold in the United States Mint; Pettenkofer's statement regarding platinum found in extracted gold . . . . .	96
Best admixture for smelting gold with saltpetre; Best size of quantity to be melted in one operation . . . . .	97
Pettenkofer's recommendation for extracting gold and platinum from the slag . . . . .	98
Re-melting gold containing osm-iridium . . . . .	99
Treatment of gold containing osm-iridium at the mint in St. Petersburg; Melting the dross resulting from the treatment of Californian and Australian gold containing gold, silver, and osm-iridium; Separation of, according to d' Hennin; Extraction of palladium from argentiferous gold . . . . .	100

	PAGE
Use of cast iron in "parting" gold; Platinum vessels in parting gold by means of sulphuric acid; Platinum vessels at the mint in Munich; Treatment of auriferous silver at the mint in Munich . . . . .	101
Extraction of gold at St. Petersburg with cast iron vessels; The discovery of and proving gold ores, necessity of "an eye for color" in exploitation for gold; The simplest instrument for the discovery of gold in fine dissemination through sand or dirt . . . . .	103
Gold cradle or rocker, illustrated and described . . . . .	104
Sluice system of washing dirt with mercury; Description of the wooden troughs; Difficulty of amalgamation or combination of gold with other substances . . . . .	105
Wurz's process of forming a hard amalgam; Crookes's process of forming a hard amalgam . . . . .	106
Poorer ores containing gold; Treatment of poor ores . . . . .	107
Hungarian process . . . . .	108
Necessary precautions in the treatment of gold . . . . .	109

SILVER.

Occurrent form or appearance in nature; Native silver, characteristics of; Hardness, gravity, color, ductility, composition . . . . .	111
Localities, geology, and associations; Kongsberg Silver Mine, Norway . . . . .	112
Silver mines in the United States; Arsenical iron or mispickel . . . . .	113
Appearance of the principal ores of silver; Antimonial silver or dysracite . . . . .	114
Bismuth silver; Freieslebenite; Stephanite; Argentite . . . . .	115
Ruby silver or pyrargyrite; Separation of the silver in the dry way; Preliminary assay as described by Makins . . . . .	116
Mitchell's preliminary assay; Actual assay . . . . .	117
Assay of shopsweepings; Scorification; Makins's operation in . . . . .	118
Cupellation of the noble metals . . . . .	120
Cupel furnaces, requirements of; Caution in working silver with lead . . . . .	121
Wet process or humid assay of silver; Process of Haidlen and Fresenius for separating silver from copper; Process where gold is in association . . . . .	122
Caution; Recommendation of Rose, Gay Lussac, and Liebig on treatment of silver; To separate silver from lead . . . . .	123
Separation of silver from cadmium and bismuth; From mercury . . . . .	124
Silver from sulphurets . . . . .	125

COPPER.

Native copper as a true ore, locations of, in the United States . . . . .	125
Copper, characteristics of; Hardness; Behavior before the blowpipe; Geological position; Usual compounded ores . . . . .	126
Blowpipe and other detection of copper; By dry method . . . . .	127
Wet method; Caution . . . . .	128
Copper sulphides, decomposition of, and separation of sulphur . . . . .	129
Caution . . . . .	131



## NICKEL.

	PAGE
Nickel, characteristics of; Ductility and tenacity; Nickel glance (Gersdorffite) . . . . .	132
The Speiss; Oxides of nickel; Chloride; Sulphides . . . . .	133
Alloys of nickel; Separation of constituents in a nickel ore . . . . .	134
Deville's method of obtaining pure nickel; Ores of nickel found in the United States; Decline in the price of nickel . . . . .	135
Use of nickel for culinary utensils; For crucibles in chemical operations; Consumption of nickel in the United States . . . . .	136

## IRON.

Characteristics of iron; Malleability, ductility, tenacity, etc.; The chief ores of iron; The magnetic ores; Magnetite . . . . .	137
Distribution and association of magnetic ores . . . . .	138
Hematite or red hematite (specular ore); The largest source of iron in the United States; Occurrence, characteristics, etc. . . . .	139
Brown hematite (limonite); Distribution, characteristics, and peculiarities	140
Limonite as a bog ore in the United States; Spathic ore . . . . .	142
Dry assay of iron . . . . .	143
Caution . . . . .	144
Choosing samples for experiments from an ore bed . . . . .	145
Wet method of assaying iron . . . . .	147
Wöhler's method of obtaining corroborative proof and accuracy . . . . .	150
Examination for phosphorus; In iron sesquioxide . . . . .	151
Parry's method for precipitating phosphorus . . . . .	152
Deduction of pure iron in the assay . . . . .	154
Cautions . . . . .	155
Examination for sulphur . . . . .	156
Caution; Determination of manganese . . . . .	158
Spathic ore; Kipp's apparatus for determining carbonic dioxide, illustrated and described . . . . .	162
Titanic acid (rutile); Dark-colored iron sand containing titanic acid; Where found, and treatment . . . . .	164
Volumetric determination . . . . .	166
Preparation of the reagents and of the test iron . . . . .	167
Preparation of the ore for assay . . . . .	170
Changing a ferric solution into a ferrous . . . . .	171
Exhaustion of iron-ore deposits in the United States; Remarks of Major Powell, Director of the Geological Survey . . . . .	173

## TIN.

Characteristics of pure tin . . . . .	174
Occurrent form; Stream tin . . . . .	175

	PAGE
Localities and geology . . . . .	176
Greisen; Block tin . . . . .	177
Tinstone; Where found; Wood tin; Analysis of an ore—Dr. F. A. Genth—from the Temescal tin mines, California; Mineralogical appearance . . . . .	178
Behavior before the blow-pipe . . . . .	179
Extraction for detection . . . . .	180
Estimating the quantity of tin in any compound . . . . .	182

## ZINC.

Occurrent form; Hardness; Gravity; Color; Ductility . . . . .	183
Melting point; Impurities; Localities; Zinc sulphide found in isolated small pieces . . . . .	184
Silicate; Carbonate of zinc; Zinc sulphide or blende; Under the blow-pipe . . . . .	185
Carbonate of zinc; Silicate of zinc . . . . .	186
Distilling zinc; Apparatus illustrated and described; Treatment of calamine or blende in the large way by the English method . . . . .	187
Belgian and Silesian processes; Oxide of zinc; Characteristics of . . . . .	189
Proportion of metallic zinc in the oxide of zinc; Pure metallic zinc . . . . .	190
Separation of metallic oxides of groups five and six . . . . .	191

## LEAD.

Lead; Properties of; Galena; Galenite . . . . .	194
Geological horizons and occurrence; Geographical distribution of in the United States . . . . .	195
Working the ore on the large scale . . . . .	196
Dry assay without iron; Wet method . . . . .	197
Composition of lead sulphate . . . . .	198
• Constituents of the fumes passing off from lead ores; "Exhausters" of gaseous fumes; Experiments with the Sturtevant blower . . . . .	199
Pattinson's process for separating silver from lead . . . . .	200
Parkes's process; Hoffman's remarks on the use of Parkes's process in the United States . . . . .	201
Lead characteristics . . . . .	202
Wet assay and methods of detection . . . . .	203
To determine lead quantitatively; Mascazzino's method of assaying lead ore . . . . .	204

## MANGANESE.

Manganese; Characteristics of; Fusing with a blow-pipe; Associations . . . . .	206
Its uses in the arts and manufactures . . . . .	207
Its importance in the manufacture of steel; Its effect upon building stone . . . . .	208
Analysis for manganese by the wet process; Process of detecting minute traces of manganese . . . . .	209

## PLATINUM.

	PAGE
Platinum and the combinations in which it is found; Characteristics; Hardness; Lustre; Color and streak . . . . .	209
Geology and occurrence; Where found in the United States in small quantities . . . . .	210
Analysis of California ore; Wet process of analysis . . . . .	211

## IRIDIUM.

Its associations and characteristics; Hardness; Lustre; Malleability . . . . .	214
Table of a general view of the analytical process of separating the metals associated in the ores of platinum . . . . .	215
Geographical distribution of iridium; Its occurrence in the United States; Iridium ore in gold dust and the manner of separating . . . . .	216
John Holland's important discovery in the melting of iridium; Uses of iridosmine . . . . .	217
Iridosmine and iridium; Relative values of . . . . .	218

## MERCURY.

Occurrent forms and associations; Hardness, gravity, color, ductility, composition; Boiling and evaporating points . . . . .	218
Localities; Geology and associations; Rocks affording the metal and its ores; The strata of the Almaden mines, etc. . . . .	219
Chemical characteristics; Dissolution of with acids; Combining with metals; Oxides of . . . . .	220
Ores; Almaden mines in Spain and in California; Cinnabar ore and its chemical affinities; Treatment of the ore . . . . .	221
Retort process; Roasting the ore; Rumford's cylinder furnace; Hüffner & Scott's shelf furnace . . . . .	222
Roasting fine ores with brick or adobes; Intermittent furnace used at New Almaden, California . . . . .	224
Rumford lime-kiln with its improvements explained by Saml. B. Christy; Characteristics of mercurial compounds; Testing insoluble substances for mercury; Testing soluble bodies; Action of stannous chloride; Of potash, soda, or ammonia . . . . .	225
Action of hydrochloric acid; Of sulphide of hydrogen, or of ammonium sulphide; Makins's accurate method for determining mercury in compounds . . . . .	226

## ANTIMONY.

Characteristics and occurrence of; Hardness; Gravity; Associations . . . . .	227
Stibnite; Valentite; Red antimony or kermesite; Occurrence of stibnite, action before the blowpipe; Antimony associated with cinnabar in California . . . . .	228

	PAGE
Stibnite deposits in Utah; Deposits in foreign lands . . . . .	229
Extraction of antimony from its ores; Crocus of antimony; Uses and estimation of antimony . . . . .	230
Composition of antimony; To distinguish antimony from Bismuth; Makins's method of estimating antimony . . . . .	231
Caution in passing hydrogen sulphide through the hydrochloric solution . . . . .	232

### BISMUTH.

Occurrence and characteristics; Hardness, gravity, lustre, streak, and color; Brittleness; Malleability; Crystallization . . . . .	232
Fusing point, and effect upon melting points of other metals; Burning at a high temperature; Effect of acids upon; Expansion on cooling after fusion; Detection of bismuth; Its salts; Action of dyhydric sulphide or ammomo-hydric sulphide; Action of the alkalies, potash, soda, or ammonia; Action of potassic chromate; To distinguish bismuth from lead . . . . .	233
Behavior under the blowpipe; Occurrence of bismuth in the United States; Its use in alloys and amalgams; Subnitrate as an enamel in porcelain, etc. . . . .	234

### CHROMIUM.

Chrome iron or iron stone; Composition of; Chromite; Hardness, gravity, lustre, streak, color; Action before the blowpipe . . . . .	235
First notice of its occurrence in the commercial way; Deposits in Maryland and Pennsylvania; Decomposing the ore; Deposits of chrome ore in North Carolina, Virginia, and California . . . . .	236
Quantitative analysis of chrome iron ore . . . . .	237

### COBALT.

Cobalt generally associated with nickel; Cobalt glance, and smaltine; Zaffre; Preparation of the metal . . . . .	238
Color, specific gravity, fusibility; Localities of cobalt minerals; The only use of cobalt; Inability to plate with; Value of cobalt and of cobalt oxide; Detection of its compounds by the blowpipe . . . . .	239
Separation of cobalt from nickel . . . . .	240

### CORUNDUM AND EMERY.

Corundum and Emery; Simply alumina with various degrees of associated iron oxide; Corundum in its purest crystalline state; Color, hardness, gravity, lustre; Action under the blowpipe; Solution in borax and salt of phosphorus; Color produced by long heating with a cobalt solution; Association with crystalline rock; Emery at Chester, Mass. . . . .	241
--	-----

Corundum in North Carolina, Georgia, and other States; Guide or sign in searching for; Uses of corundum and emery; Preparation of; To test the abrasive power of a corundum sample . . . . .	242
Exports and imports of emery, 1883, 1887 . . . . .	243

## PUMICE STONE.

Deposit of, near San Francisco; Composition of pumice stone imported from the Lepari Islands; Gravity, color; Value of imports, 1883, 1887 .	243
Rotten stone, Tripoli, description and statistics of; To gain a knowledge of pumice and of rotten stone . . . . .	244

## INFUSORIAL EARTH.

Composition of; Analysis of by J. M. Cabell; Deposits found in the United States; Uses of this earth in the manufacture of polishing powder, sand soap, etc. . . . .	244
--	-----

## GRINDSTONES.

Description of principal source of supply; Stone found near Grindstone City and near Marquette; Statistics of total imports and of home production . . . . .	245
--	-----

## BUHR STONES.

Leading localities in the United States; Æsopus stone . . . . .	245
Cocalico found in Lancaster County, Penna.; Berea Grit, found in Summit County, Ohio; Uses of the American stone and of those imported; Substitution of rollers for buhr stones; Statistics; True buhr stone .	246

## THE DIAMOND.

Diamonds found in the United States . . . . .	246
Association of minerals generally with the North Carolina diamonds; Dr. Genth's description of the <i>débris</i> ; Hardness, gravity, lustre, color, and general appearance of <i>monazite</i> . . . . .	247
Composition of and behavior under the blowpipe; Xenotime, characteristics and general appearance of; <i>Octahedrite</i> , hardness, gravity, lustre, color, streak, and composition of; Behavior before the blowpipe; Color produced by fusion with an alkali or alkaline carbonate; <i>Rutile</i> . . . . .	248
Diamonds found in Georgia, California, Idaho, Wisconsin, Montana, and Arizona; Gravity; General appearance when found . . . . .	249
One of the best tests of a diamond; Appearance of the diamond in the rough state; Their ability to scratch glass no proof of their distinctive value as diamonds; Other glass-scratching stones . . . . .	250
Diamonds found in clay in the diamond fields of Africa . . . . .	251

## PART II.

MINING WORK AND ARCHITECTURE, INCLUDING VARIOUS SUGGESTIONS,  
WITH DESCRIPTION OF ASSOCIATED APPARATUS AND MACHINERY.

## MINING CONSTRUCTION AND MACHINERY.

	PAGE
Introduction . . . . .	255
Some explanation of terms; A gangway or gallery, illustrated and described; German, Austrian, English, and American names . . . . .	256
Preliminary work and considerations; To make trial shafts or excavations	257
Employment of borings by proper machinery; Examinations for drainage; Protection of the excavations and supply of timber or of masonry; Ac- cessibility to market one of the most important elements of successful mining . . . . .	258
Importance of drainage; Grade or descent necessary to prevent overflow; Construction of the main gallery . . . . .	259
Location and size of the galleries; Opening a gallery from the side of a hill, illustrated and described; To begin the galleries when opening upon a vein or lode; Working a mineral vein upward from the floor of a drift gallery . . . . .	260
Inclination of galleries running at right angles to drifts; Sinking a slope from the top of a hill, illustrated and described; When the gallery is entirely in the lode to be worked out; While the gallery is partly in the rock and partly in the lode; Putting the gallery outside when the lode is weak; Putting the gallery within the lode when the rock is strong; When the rock is not in horizontal strata . . . . .	261
Building a gallery at a distance from and parallel to the pay rock, illus- trated and described . . . . .	262
Leading off the water from mines, illustrated and described; Where expedi- tion is required, illustrated and described . . . . .	263
Vertical distances between galleries built over each other; Extracting water when the lowest gallery runs beneath the level of the water out- side; Names of the galleries; Recommendations to be observed when making oreways into the shaft, between the usual lifts; Economic use of pumping machinery . . . . .	264
Shaft method when entrance upon mineral lodes cannot be made by drifts; Possible forms of Mining when rock is to be penetrated; Shafts intended for entrance of light . . . . .	265
Proper position of the "sumpt" or drain reservoir; Advantage of the slope over the perpendicular shaft; Cross-section of shaft framing, illus- trated and described . . . . .	266

	PAGE
Use of a straight and vertical shaft for experimental and permanent purposes, illustrated and described; Shaft when the ore seam appears of an undetermined angle, illustrated and described . . . . .	267
Slope in the coal beds, illustrated and described; Opening of the shaft in rock or soil, illustrated and described . . . . .	268
Sinking of side-pits when the roof is weak, illustrated and described; Timbering; Depth and width of the dumping-floor . . . . .	269
Leading off the water from side walls, illustrated and described . . . . .	270
On the opening of mines . . . . .	270
Important rules to be observed in opening or exploring a mine; The most important changes in ore veins; Splitting, forking, or scattering of a vein; Compression or pinching of the vein . . . . .	271
Shifts or faults; When a vein divides into several branches; When a vein becomes pinched or thin; When a vein or lode is intersected by another and the continuation of the one in progress cannot be found in the same direction . . . . .	272
Distinction to be made between the gangue and ore in opening a deposit of mineral, illustrated and described; Special consideration of the rise or inclination of the ore in opening a lower foot drift, illustrated and described . . . . .	273
To locate the opening of a deposit when the mountain is steep and the strike of the vein is parallel with the slope of the mountain; When the strike of vein is across the strike of the mountain ridge; When the deposit is greatly inclined or strikes under a plain; When the deposit is nearly horizontal . . . . .	274
Opening of large irregular deposits; Guidance for mining when nests or kidneys of ore lie separate from each other; Requirements of well-conducted, scientific, systematic mining; Advantage of going to the lower parts of the deposit as soon as possible . . . . .	275
Requirements of systematic mining both during the opening and the actual working of the mine; Value of transverse galleries, cross-clefts and fissures . . . . .	276
Final preparations and working of mines . . . . .	277
Stopping out the ore; Division of the deposits by levels, drifts, etc.; When a mine is said to be exposed; Establishing a correct relation between the preparatory work and the extracting of the ore . . . . .	277
Judicious treatment of the exposed ore; To make an average between the higher and lower, richer and poorer ores; Evil results from "robbing a mine" . . . . .	278
Regulations for locating the work and employment of hands; Provisions for drainage, ventilation, security of the mines and lives of the miners . . . . .	279
Veins and lodes; How prepared and mined . . . . .	279
Mining the ore if the vein be not over twelve feet thick, illustrated and described . . . . .	279

	PAGE
Commencing the final work of exhausting the mine . . . . .	280
Mining overhead, or by ascending steps, illustrated and described . . . . .	281
Method of working downwards, illustrated and described . . . . .	283
Working when the vein has a selvage or partition rock; When the vein is firmly attached on both sides to the rock; Advantages and disadvantages attendant upon each method of mining . . . . .	284
Working when the ore is not uniformly rich, or is deposited in small detached masses, illustrated and described; When lodes are more than two or three fathoms in thickness, illustrated and described . . . . .	285
Treatment of the breast when it reaches the wall or is abandoned; Opening of a second story immediately over the first, illustrated and described	286
Working when a large mass of barren rock is met in the deposit, illustrated and described . . . . .	287
Preparation and working of stratified deposits and beds . . . . .	287
Working of beds of great inclination; When the inclination is less than forty degrees; Long wall system or post and stall workings . . . . .	287
Detailed working of the long wall system, illustrated and described . . . . .	288
When the long wall method is used; Use of the post and stall method; Preparatory work for the post and stall method, illustrated and described	289
Taking out the pillars; Operation when the roof is brittle; Cutting levels and drifts in coal-beds, illustrated and described . . . . .	290
In coal-beds of different layers and benches illustrated; In beds of very great thickness, illustrated and described; Supporting the roof or walls; Spontaneous combustion, generally supposed cause of, and the most effective mode of prevention . . . . .	291
Preparation and working of mineral deposits that occur in large masses . . . . .	292
Mining large deposits possessing some degree of regularity; Deposits with little or no regularity in form; Preparing a deposit to work from below upwards, illustrated and described; When the deposit has been discovered by means of an adit or tunnel . . . . .	292
When the deposit has been discovered by a shaft; Arrangement of the floor and pillars; Position of the miners when at work; Operation when a vault becomes too large or in danger of crushing in, or the ore-mass is composed of hanging and lying ore-veins; To gain masses of inferior ores difficult of extraction . . . . .	293
To gain valuable ore after the mine has crushed in; Rock-salt works containing salt in large and almost pure masses, operation, illustrated and described . . . . .	294
Gaining the salt in a mine by dissolving it; Running of gangways with rectangular branches conveying water, illustrated and described; Rock blasting; Method used in progressing against a breast in a gangway of a salt mine, illustrated . . . . .	295
Preparation and working of nests, cores, or pockets . . . . .	295
Surface or day working . . . . .	296



	PAGE
Class of deposits to which it is applied; Stripping, quarrying, and buddling	296
Open quarrying when the mass is loose, illustrated and described; When solid rock is to be quarried; Obtaining large regular building and mill stones; Obtaining small irregular pieces; Opening seams in rocks by means of dry woodpins	297
Tunneling to avoid removal of a very thick covering and be able to work during the winter; Practice at the iron mines near Hokendauqua; Buddling; Simple method employed in steep mountain valleys	298
Use of washboard for minerals found in coarse grains, as gold; When the mineral particles are very fine; Where a sufficient head of water can be obtained and the soil is loose	299
Assorting the ore in the mine	300
Transportation	300
Classification	300
Transportation through galleries and drifts having an inclination of more than $10^{\circ}$ and less than $30^{\circ}$ , illustrated and described	301
Transportation through shafts, illustrated and described; Transportation by shutes, illustrated and described	302
Transportation by windlass, illustrated and described	303
When greater weight is to be raised from an unusual depth; Tarring the hemp ropes; Use of chains in mines where the water is not acid	304
Use of buckets in shafts; To prevent material from falling into the shaft; Effective machines for shafts of more than one hundred and twenty feet in depth; Horse whim, illustrated and described	305
To equalize the weight and velocity of ascending and descending buckets; Arrangement to empty the bucket without tilting it	306
To prevent a loaded car from jumping the track; Principal parts of a water whim, illustrated and described; The brake attachment, illustrated and described	307
Another method with the water whim, illustrated and described; Equalizing the weight of the buckets	308
Proper location of the whim, illustrated and described; Use of turbine wheels; Form and curvature of the blades, illustrated and described; Placing the wheel and shaft, illustrated and described	309
Steam engine, illustrated and described	310
Use and description of the eccentric	312
Engines arranged for reversing the action of the wheel, illustrated and described	313
Transportation on steep inclines	314
Arrangement of the cars, illustrated and described	314
Dumping the material from overhead workings; Use of cages, illustrated and described; To prevent lateral motion and falling of the cage; Emptying and preservation of vessels	315

	PAGE
Ladders for ingress or egress of workmen, illustrated and described; Platforms worked by machinery, illustrated and described . . . . .	316
Timbering and masonry . . . . .	317
When the rock of a mine is not perfectly firm; If the spaces are to be self-supporting; Pillars of native rock; Artificial pillars . . . . .	317
Conditions to be considered before deciding upon timbering or masonry . . . . .	318
Mining carpentry . . . . .	318
Selection, preparation, and placing of the timbers . . . . .	318
To secure greater durability in timbering, illustrated and described . . . . .	319
To support only one overhanging or underlying wall in a drift, illustrated and described; When the side and roof need support, illustrated and described . . . . .	320
Placing the cross-beam when the pressure is equal on all sides; When the side pressure predominates; When the pressure is very great, illustrated and described; To prevent displacement of the posts; To give the frame still greater strength, illustrated; To form caps and posts in salt mines . . . . .	321
Use of ground sills when the floor is loose and soft; Sills when the frames are near each other—When some distance apart; Long sills illustrated and described; Wedge braces for great pressures upon sills and posts; Position of the frames according to the pressure; Lining with slabs or split logs if the rock be liable to crumble; Sizes of timber when the ground is altogether crumbling, or reopening of old works; Timbering when a loose face or breast of a gallery is to be opened . . . . .	322
Timbering when the sides are firm and only the roof is brittle or soft, illustrated and described; When opening a drift gallery from another and timbered gallery; When the floor of a gallery is to be prepared for transportation and drainage; Placing of cross-beams in timbered and untimbered galleries . . . . .	323
Timbering when the vein pitches considerably, illustrated and described; Position and direction of the floor; Testing the floor before nailing the boards; Floors for transportation . . . . .	324
Timbering of shafts . . . . .	324
Commencement of the timbering, illustrated and described . . . . .	324
Temporary timbering through insecure rock, illustrated and described; Preparing a firm foundation for permanent timbering, illustrated and described . . . . .	325
Construction of the lining of shaft timbering, illustrated and described . . . . .	326
Timbering when all the sides of a shaft do not need it, illustrated and described; Pile driving, illustrated and described; Timbering perpendicular shafts having several divisions . . . . .	327
Complete timbering of the transporting gallery, illustrated and described . . . . .	328
Timbering of inclined shafts (slopes) . . . . .	329

Supports for the roof, illustrated and described ; Platforms for the partition through which the miners pass, illustrated . . . . .	329
Tramway or rail-track for transporting vessels having wheels, illustrated ; Partition in transporting shafts, illustrated ; Need of a shed at the mouth of a shaft . . . . .	330
Timbering necessary for working in mines . . . . .	330
Preparing a timber ceiling for working overhead, illustrated and described	330
Timbering for working downwards, illustrated and described ; When taking the ore from large deposits . . . . .	331
Renewing timbering . . . . .	331
Replacing single frames, shaft timbers, illustrated and described . . . . .	332
Masonry . . . . .	332
Classification of the walls of the gallery . . . . .	332
Requirements of durable masonry ; Most suitable building stones ; Preparation of good common mortar ; Of hydraulic mortar ; For proper joining of stones . . . . .	333
Preparations before beginning a wall ; Elements of strength in the wall ; Building the wall, illustrated and described ; Arched masonry for great strength and durability . . . . .	334
Proportions of the arch, illustrated . . . . .	335
Semi-circular arch, illustrated and described ; An elliptical arch, illustrated and described . . . . .	336
Construction of an egg-shaped arch, illustrated and described ; Construction of an arched tunnel, illustrated and described . . . . .	337
To prepare the bedding for an arched wall ; Treatment of the segments when the work on the arch is interrupted, illustrated and described ; When water is found behind the wall ; Comparative value of dry and of mortar walls . . . . .	338
Protecting arched walls against water ; Illustrations of the various forms of arches suited to the conditions of the pressures from roof, sides, etc. ; Drainage canal or sluice in main galleries . . . . .	339
Joists for the tramway, illustrated ; Masonry for shafts ; Temporary timbering in perpendicular shafts preceding the masonry ; Main arches for the walls, illustrated ; Arches for partition walls, illustrated . . . . .	340
Masonry of shafts in swamp lands ; Masonry of inclined slopes or shafts ; Strength of arches for walls of extended spaces ; Draining from the sides of shafts . . . . .	341

## APPENDIX.

## SINKING ARTESIAN WELLS.

	PAGE
Apparatus for sinking artesian wells; Height of derricks used in sinking wells; Weight of the tools used at the present time; Sizes of timber used in making derricks . . . . .	343
Precautions to be used by the workmen; Blasdell's method of sinking artesian wells . . . . .	344
Description of pipes or tubing used in sinking artesian wells; To connect the pipes together in boring . . . . .	345
Use of the reamer or combination auger to enlarge the hole; Twist or spiral auger; Iron rods furnished with male and female socket joints; Description of the sand pump and manner of using . . . . .	346
To hold the rods while disconnecting them; Description of levers used to force the pipe down; Valve sockets or "catchalls" for catching the rods; Use of steel dogs . . . . .	347
"Wrench bar;" "Boulder-cracker;" "Spring catch;" "Hooks;" "Lifter;" Attaching a line to the catchall; To commence an artesian well . . . . .	348
Methods of overcoming obstacles as sand gravel, boulders, etc.; To obtain a supply of water . . . . .	349
Artesian wells in the vicinity of Philadelphia; Obtaining water from fissures and crevices in rocks . . . . .	350

## OIL AND GAS WELLS.

Necessary tools in sinking an oil or gas well; To start a well where the soil overlies the rock . . . . .	350
Connecting the tools to commence drilling; Use of the reamer; "seed-bag" . . . . .	351
Sizes of the wells drilled . . . . .	352
INDEX . . . . .	353

PART I.

MINING MINERALOGY,

AND

ECONOMIC TREATMENT AND HISTORY OF THE  
USEFUL MINERALS.

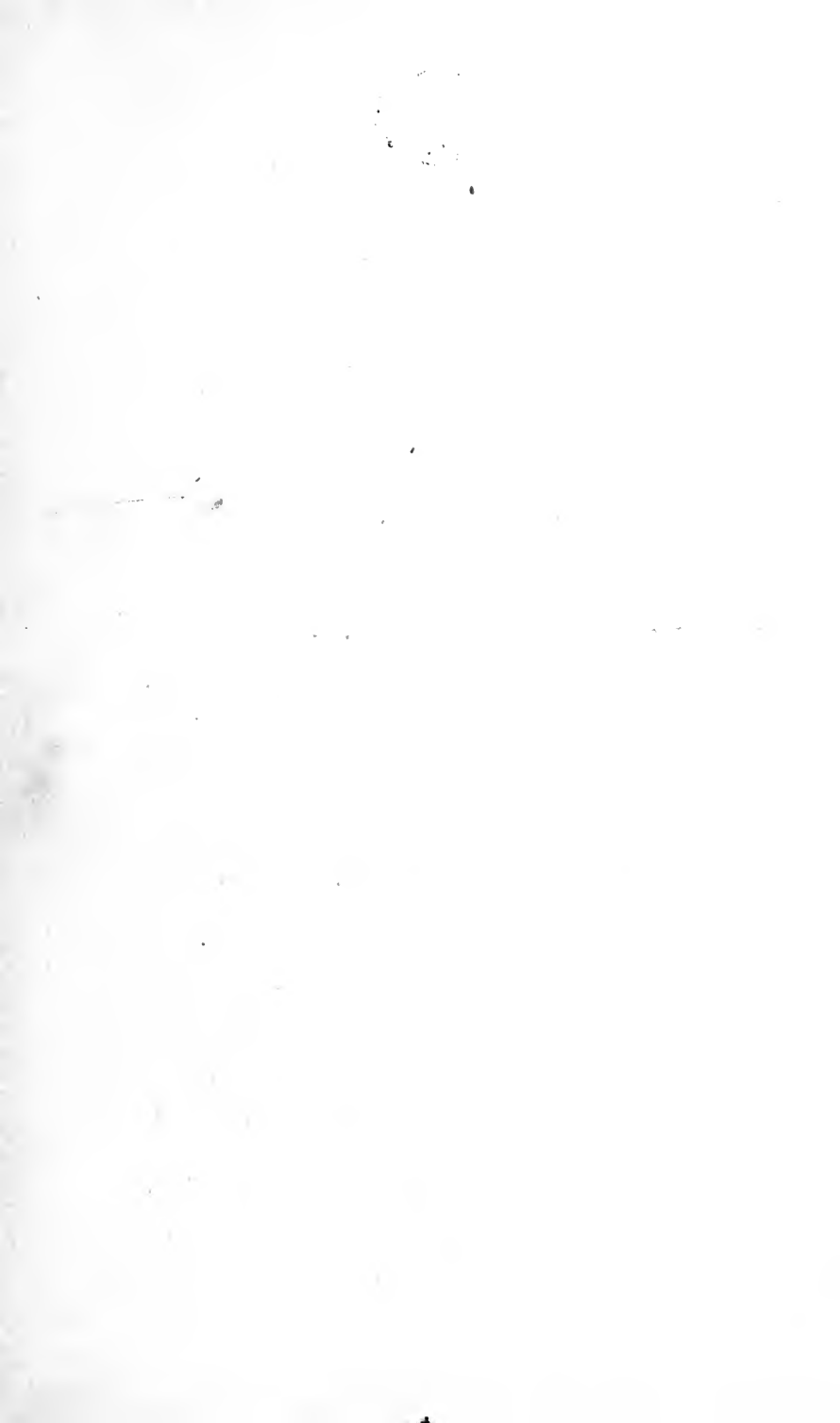



# A PRACTICAL MANUAL

OF

# MINERALS, MINES, AND MINING.

---

## MINING MINERALOGY.

### PRELIMINARY PRINCIPLES AND PREPARATIONS.

IN the successful study of mining mineralogy it is necessary to become thoroughly informed upon certain physical properties. A correct recognition of minerals does not, however, demand a perfect knowledge of any one science, as, for example, that of crystallography, or that of the chemical composition of even those minerals with which one may nevertheless become unmistakably familiar. Skill in determining may depend, in a very large degree, upon the experience we may acquire by repeated examination of well-known varieties of the same species. This experience, however, demands that some one shall have preceded us with a thorough knowledge of chemistry, in order that the analyses may decide that certain crystallized forms in minerals, with certain specific gravity, hardness, color, cleavage, lustre, and some other physical properties, are of a certain specified or characteristic composition. Chemical analysis alone can decide the latter fact, although we may know that

certain mineralogical compounds never crystallize otherwise than in certain forms, with a certain hardness, specific gravity, etc.

*For Example.*—We may meet with a crystal which is clear as glass, and has six long sides, forming what is designated by the name “prism;” this six-sided prism, however, terminates with a six-sided end or point, the other end of the prism may be attached to a rock. Now minerals of this form have been analyzed and always found to be composed of substances called silicon and oxygen, in the proportion of one of the former to two of the latter, and as this compound and no other crystallizes in this form, we know it by this specific form and call it “quartz.”

Again, we may meet with an equally transparent substance which, when in crystalline form, presents itself with two edges, each forming an acute angle, and two an obtuse, and as a whole mass appearing under that figure called, in geometry, a rhomb. Its analysis shows it to contain only lime and carbonic acid (dioxide). The fact, therefore, that any transparent mineral presents such angles makes it almost certain that it is a lime carbonate. A knowledge of the crystalline forms under which certain chemical compounds present themselves frequently saves us the trouble of analysis.

CRYSTALLIZATION, therefore, is a physical property of minerals which, while it does not always determine the nature of the substance before us, is frequently of immense importance. The mineralogist may find a set of crystals which, while they have six sides and are transparent, have



had their ends broken off so that he cannot certainly know that they are quartz; for lime carbonate may appear very rarely in six-sided crystals, but never in six-pointed crystals. In this case the mineralogist is forced to resort to his acquaintance with other physical properties, such as we shall presently introduce.

As an illustration of how important this subject is, we may state the following. In 1876, in Jefferson Co., N. Y., several thousand tons of excellent red hematite ore were condemned because of the appearance of large quantities of supposed minute quartz crystals in the ore. When visiting the mines we discovered that the six-sided crystals had three-sided terminations, which quartz never has, in place of the six which quartz always has. They were therefore lime carbonate, which is an advantage in the furnace treatment, while quartz is an injury. This distinction between three- and six-sided terminations led to the immediate sale of the ore. If, however, the terminations could not have been seen, or we wished to corroborate what the crystalline structure indicated, we must have proceeded to the consideration of other properties.

**HARDNESS** as a characteristic comes in to help in the determination of many minerals. In the illustration given in the last paragraph, the crystals would have betrayed their composition by their softness as compared with quartz. The point of a knife or needle would readily scratch them, showing that in hardness they could not be quartz. And so in many cases this property adds greatly to the probability based upon the crystallization.

Again, there are certain lines of direction along which

the difference of its weight in and out of water, and the quotient will be the specific gravity of the mineral.

Of course, the more delicate the scales, the less in size need be the mass and the more accurate will be the specific gravity found. It will sometimes occur that the mineral, especially if it be rough, retains some bubbles of air upon its surface materially altering the weight in water. To prevent this, dip the mass in alcohol (if not soluble in it, in any way) and, afterward, in the water which is to be used for determining the specific gravity. Care should be had in suspending the mineral by very light threads, silk threads, horse-hair, or human hair, or fine copper wire according to the size and weight of the mineral. Practice will give the operator such great skill in determining the specific gravity of minerals, that where the mass is of the size of the fist, and can be readily poised in the hand, its weight and specific gravity may be closely approximated. Thus the mineral barytes (sulphate), or barite, frequently appears in masses, white, somewhat crystalline, and to the inexperienced resembling lime carbonate, but a piece taken into the hand is immediately suspected by its great weight, being in some varieties twice as heavy as lime carbonate. There is no better method, at least none more accurate, for determining the bulk of a body than by weighing the water displaced, as it matters not how irregular the mass may be in surface, the water will register accurately all irregularities. Thus, if it is desired to ascertain the bulk or volume of the hand, take a glass jar or other vessel, and fill it with water to the extreme edge of the rim. If the glass be about 7 inches high

and 12 inches in circumference outside, it will hold about 1350 grammes of rain-water, and be a convenient size for the trial. Remove it from the scales, after carefully weighing, and introduce the hand to about the lower edge of the wrist bone. This will cause an overflow of water equal in volume to that of the hand. Remove the hand, wipe the glass outside and replace the glass in the scales with its remaining water, and weigh it again. Subtract the latter weight from the former and you have the exact amount of water displaced and the bulk of the hand as introduced. Now if you know the weight of a cubic inch of that water displaced, divide the cubic inch weight into the weight of the bulk displaced, and you have the exact size or bulk of the hand. As an example in an actual case of a medium hand of a man whose height was medium—

Glass full of water =	·	1338 grammes
Glass after introduction of the hand =		942 “
		396 grammes
	loss	

= weight of the hand volume of water. The volume of this amount may be found thus:—

252.432 grains of pure rain-water = 16.359 grammes = weight of one cubic inch of water at 60° F. and 30 inches height of barometer. We need not be so accurate in this case, so we may say that a cubic inch of pure rain-water weighs 16 grammes, therefore 396 grammes divided by 16 gives 24 cubic inches, accurately 24.7 cubic inches, as the cubical size of the hand. Now, as human flesh and bone is only a little over the specific gravity of water, we may con-

sider the hand as 1.1, or one-tenth heavier than the same bulk of water, so that, as  $396 + 39.6 = 435.6$  grammes, and as the latter amount in grains, at 15.432 grains to one gramme, equals 6722 grains, and as 437.5 grains are equal to one ounce avoirdupois, we shall have 15.36 ounces as the weight of a man's hand, or nearly  $15\frac{1}{2}$  ounces in this case. The medium hand of a child displaces about 222 grammes, and is about 8 ounces and nearly six-tenths of an ounce. This is only approximate in the details, but exhibits the method and suggests some uses.

When great accuracy is required, it is necessary to obtain carefully distilled water; make the temperature  $60^{\circ}$  F. and make corrections of barometer for any variation from 30 inches of height, for it is seldom that the barometer is at that height. In most cases the latter variation is not very important, and indeed attention to it may be entirely neglected except where standard trials and corrections of standards are to be made, and the same is true in regard to water; good, clear, and pure rain-water may be used for most trials at any temperature between  $50^{\circ}$  and  $75^{\circ}$ , without much inaccuracy, for it is seldom that any two minerals of even the same species are of exactly the same specific gravity, or, so nearly the same as to require the accurate determination with distilled water, temperature  $60^{\circ}$  and barometrical height of 30 inches.

If we take the specific gravity of water in a thousand grain-bottle, which is the best for ordinary delicate scales, at  $52^{\circ}$  and at  $80^{\circ}$ , the difference will be but small; thus, with an extremely delicate pair of Becker & Son's scales, we took the specific gravity of 1000 grains good rain-water at  $52^{\circ}$

and its weight was found to be 64.775 grammes. The water was again taken in a few minutes at 79° F., when it was found to be 64.604, being a difference of not quite 0.28 per cent., not quite three-tenths of one per cent. On heating to 95° F., the weight decreased to 64.378 grammes or 0.62 of 1 per cent., and on continuing heating to 99°, we may say 100° (as the temperatures were not taken till immediately after the weight was taken), the weight was then decreased to 64.333 grammes, equal to about 0.69, or nearly 0.7 of one per cent. In all these trials the barometer remained at the same height, namely, 28.27 inches.

Now, if we take the same water, we may find the difference more important when we wish to find the specific gravity of a mineral or metal, under differing degrees of temperature. The following actual experiment will illustrate the variations. A piece of native silver from mines near Ontonagon, Lake Superior, was introduced into the water at a temperature of 40° F. at first, and the following table will show the variations afterward as the temperature was increased:—

Water at	Specific gravity		Increase.	Per cent. of increase.
40°	7.775			
61°.	“ “	7.817	.042	.540
79°	“ “	8.077	.260	3.326
105°	“ “	8.639	.562	6.958

We have taken temperatures at about 20° F. increase for each experiment, and it will readily be seen, that after 60°, the increased temperature of the water rapidly increases the specific gravity. The piece of native silver had a little native copper in its irregular and rugged sides which de-

creased the specific gravity. When the native silver is entirely free from other metals its specific gravity is generally 9.5 to 10, and when pure, 10.5.

It is plain that care must be taken in proportion to the degree of accuracy desired and, from the above remarks and illustrations, the student may be able to form his own judgment as to the degree of care to be taken in finding any specific gravity.

A practical knowledge of this subject becomes, on some occasions, of very great importance to the miner and artisan, or builder. A block of stone or marble, lump of coal, ore, etc., may be weighed without scales, for if we know the specific gravity of the material we can compare the cubic contents of the mass we wish to weigh, with the same mass of water and we shall learn its weight. Thus, I have a rectangular block of marble five feet long and three feet high, being three broad, or wide, sides all straight: now  $5 \times 3 = 15 \times 3 = 45$  cubic feet. I find that the specific gravity of that marble is 2.5, that is it is more than twice as heavy as water by 0.5. Now a cubic foot of pure water weighs very nearly  $62\frac{1}{2}$  pounds, and twice and a half  $62\frac{1}{2}$  pounds are 156.25 pounds to every cubic foot of the marble, which weight multiplied by  $45 = 7031$  pounds weight for that block of marble. Different specimens of the same species of ore may vary in specific gravity, in which case a small piece may be broken off and its specific gravity determined, from which the weight of the mass may be determined. But the sides of the block may be uneven and greater care must then be taken in measuring.

## THE BLOWPIPE.

Another very important aid in determining mineral substances is that furnished by the BLOWPIPE.

The philosophy of its action depends largely upon the fact that the usual candle flame, and somewhat similar flames, may, by means of the blowpipe, be directed upon an assay in minute pieces, so that either that part called the inner flame, or that called the outer flame, may, at will, be brought to bear upon the mineral to be assayed. The inner flame, generally that of blueish hue, is the deoxygenating flame, the outer, the oxygenating flame. It also depends for its efficiency upon the chemical fact that some minerals are readily altered, under certain conditions, in color, form, or composition, according to the nature of the flame directed upon them.

Blowpipes should be neat and small, or light and not complicated. Any practicer can, and should, learn to blow without introducing any saliva into his blowpipe. This result can always be accomplished; hence, all bulbs, reservoirs, etc., upon the blowpipe, are unnecessary complications. Charcoal should be cut from pieces made from young branches of any wood which is hard and close grained and may be cut in blocks an inch square and as thick, or into slips or rods, two or three inches long and half to three-quarters inch wide, and half as thick; one end to be covered with paper, pasted on, or wrapped around after being wet, and then gummed along an edge. The square blocks may be wired, or, in travelling, held on the point of a wire, or

knife blade. We are now regarding strictly the simplest efficient collection of materials for blowpipe practice.

A candle is sufficient, or a little tin lamp for either alcohol or sweet oil; a cork, with a hole in the cork, and fitting over the wick tube, will answer the demands, even with alcohol, pretty well. A glass stopped alcoholic lamp is larger and better looking and preferable, if it is to be used at home, or can be safely kept in the box of the travelling student, or mineralogist.

Common sal-soda, which has stood exposed to the air till it has effloresced, is a very good soda salt and, though not always pure, may be obtained so nearly pure as to serve for most purposes as a soda carbonate.

Borax should be pulverized, so that it may be picked up by the loop of the platinum wire.

Platinum wire should be nearly as thin as an ordinary horse-hair, or thinner, and may be wrapped around a little hard wood stem for a handle, as large round as an ordinary match, and, indeed, the loop at the end may be formed by placing the end of the wire against a round match and rolling both round between finger and thumb, and, when the loop has been formed, the match may be drawn away through the wire, leaving the loop.

Microcosmic salt, the usual name of phosphate of soda and ammonia, may be made by gently heating together (in distilled water) 100 parts, by weight, of crystallized phosphate of soda with 16 parts chloride of ammonium, or clean sal ammoniac, filter and evaporate and preserve the crystals in



a bottle. This salt, when heated, has the power of dissolving almost every chemical compound.

The above, with four or five inches of small hard glass tubing, the size of a large goose-quill, comprise the essentials for beginning the experiments with the blowpipe, and, indeed, for the usual work of the student it would be better to get nothing more until he is expert in the use of these alone.

### PREPARATORY PRACTICE

with the BLOWPIPE demands more or less time with different individuals; but apparent lack of skillfulness at first use is no proof that the practicer will not become an expert.

HINTS.—Any strange taste invites saliva; after awhile the presence of the blowpipe becomes no longer singular, but easy and natural, and the student may use for hours an instrument without any trouble from saliva, and his practice be clean and taste perfectly natural.

A small loop picks up so much of the reagent as can be easily managed under the usual blowpipe flame and practice which should be adopted at the time of the first experiments. Too large a "bead" results from too large a loop, and this fatigues the operator not only, but the reduction of the mineral cannot, in the same time, be so perfect, and, hence, not so satisfactory, *especially to the beginner*.

Learn to blow easily and continuously. The only method we can suggest to aid in learning this art is, first, to take the mouth full of water and, holding it, breathe regularly entirely through the nose by inhalation and exhalation.

Next, discharge the water and do the same with the mouth full of air, allowing a *very* little to escape all the time. Next is the supplying of air to this reservoir of mouth and cheek. This is an art so concealed in the mouth that no teacher can exactly instruct any student to accomplish the work so well as he can learn by a little practice. After a while the strange lesson becomes perfectly easy. Continuous blowing, or rather a continuous stream of air, is necessary in some experiments for keeping the inner, or deoxygenating flame constantly on the object to be deprived of its oxygen, or, as we shall call it, the "assay," for, if the outer flame touches the assay, it will again be oxygenated, and, *vice versa*, the rapid oxygenating of an assay requiring constant blowing without intermitting. For this and other reasons the ability to blow a constant flame is desirable.

FOR PRACTICE.—Upon an even part of a close-grained piece of charcoal, place, with the end of a pen-knife, a little common litharge (lead oxide) and the same amount of carbonate of soda. Turn the inner flame (hereafter written I. F.) very gently upon it, and you will soon succeed in reducing it to metallic lead, and, for practice, see if the lead can be kept in a metallic globule by continuing the I. F. Turn the outer flame (hereafter written O. F.) upon it and volatilize the lead, and partly by changing it back into lead oxide, leaving an outer rim or border upon the charcoal of a dingy yellowish brown (lead oxide). Study this color as the "lead-orange."

Place upon a similar piece of coal in a similar way a piece of metallic zinc. Turn the O. F. upon it; notice the pecu-

liar flaky specks and minute detachments; notice, also, the peculiar canary-yellow which the flaky masses assume and retain *while hot*, and which become changed to pure white *on cooling*; notice, also, the peculiar phosphorescence which the flaky mass or oxide of zinc assumes when strongly heated. Try a little tin and notice that although it leaves a white oxide, it is the same, hot or cold, and has no phosphorescence. Take the platinum wire; make a loop, heat the loop bright red-hot, and quickly dip it into powdered borax; turn the flame (either O. or I.) upon the mass; notice the intumescence due to escaping of the "*water of crystallization*;" blow till the bead becomes pure and entirely transparent and absolutely colorless. If there is the slightest tinge the borax bead is impure, and the cause must be sought for—if in the borax, a fresh supply of better borax must be got.

Dip the platinum loop (newly provided with a clear borax bead, as last mentioned, or heat the same bead last made, if clean and clear) into a little charcoal dust, or blow a little smoke of the flame upon it; then turn the O. F. upon it and burn it clean and clear, and remember that any organic matter may be thus burned, or oxidated by the oxygenating flame (O. F.), until the black entirely disappears. Heat the bead once more to a red heat; have prepared beforehand a speck of black oxide of manganese, about the size of the point of a pin, upon a piece of glass, or, better, broken porcelain plate; quickly press the red-hot bead upon the speck of oxide of manganese, turn the O. F. upon it, watching sharply the red-hot, or white-hot, bead, and notice that the

circulating oxide is gradually becoming mixed with the borax, and the bead has a peculiar homogeneous dark reddish appearance; stop and hold before a white sheet or wall, or up to a strong light; the color is amethystine; this is the "*characteristic color*" of manganese, if not too much adulterated with iron or other metals: study this color. Then turn the I. F. (deoxygenating flame) upon the same bead; watch the bead in the flame; it acquires a kind of reddish transparency, and a little attention will enable the student to see a decided change, and, if the deoxygenation has taken place, then, on cooling, the bead will be perfectly colorless. Now heat red hot, as at first, but with the O. F., and after a short time the color returns; touch the red-hot ball to another speck of manganesian oxide and thoroughly oxygenize. On cooling it is darker; repeat the process of adding till the bead, after cooling, from the O. F. is almost black; heat, now, red hot, and, while hot, mash the bead flat against the glass plate, or any hard surface, and with the stem of the blowpipe. Hold it up to the light and notice that, although apparently black, it is now transparent and deep violet or amethystine: remember this process for future beads.

To remove the bead, notice which part of the loop has the end of the wire, turn that end uppermost, then, holding the wire stem firmly with the left hand, and pinching the cold bead firmly between the finger and thumb of the right hand, draw the bead away from the left hand, while, at the same time, the thumb and finger of the right hand are turned over from the left to the right, the loop will thereby be

opened, and the wire will leave the bead in the grasp of the fingers while the wire is being straightened out. A little practice will enable the pupil to become expert in removing the beads, which may be preserved in a little clear glass dram vial for reference. If not desired for the future, and there is no haste to rid the wire of them, the beads may be either melted and instantly jarred off or the wire may be dropped into a glass of water, and in about fifteen or twenty minutes the bead will dissolve off.

Lenses are frequently necessary, either in the form of pocket single lenses of half an inch, or one inch, focus (the latter power is most used), or the finer style of compound lenses in brass or other metal case. Caution: Never reduce a metal upon platinum wire, as the heat will cause the metal to alloy with the platinum, and the *alloy* will melt and the wire be injured. In using borax the reduced metal may sometimes be kept off the wire, as when the experiment with litharge was made, but it is not safe. Use charcoal.

MAGNETISM is a help in determining some minerals, and the most convenient method of applying it is by means of a little pocket compass, or a magnetized pocket-knife blade, by which any small specks of supposed magnetic sand, or other ore, may be determined instantly, at home or wherever the mineralogist may be travelling.

We would advise the learner to experiment, as above directed, until quite expert before trying to proceed upon the blowpipe indications hereafter stated.

CUPELLATION.—This strictly belongs to the separation of some metals, but the practical mineralogist frequently needs

the knowledge of the process, and he may make great use of it in determining the nature and comparative value of some ores. Even with the blowpipe the process is frequently useful.

A cupel is the common name for a circular block of bone-ash with a small depression in the upper surface. It may be of any size or shape, but for usual assay purposes a cupel is generally an inch or more in diameter and half an inch thick, and cupels may be obtained so readily at any manufacturing chemist's salesroom that it is not economy to make them, and they can be sent and received by mail. When these cupels are sufficiently heated (red hot) with a little lead they have the property of absorbing the lead, which is changed into the form of a liquid lead oxide. At the same time any melted gold or silver which was in the lead remains upon the surface of the cupel in the shape of a bright ball or button, which brightened instantly when the lead had entirely disappeared from its surface.

It is necessary, therefore, to have a furnace prepared to receive an arched clay box, or small chamber called "a muffle," which shall be fitted to receive the cupels, so as to protect them from the surrounding fire when the muffle is heated to a low red heat.

Of course, in the convenience of the laboratory and at home the best method is to obtain the small clay furnace already prepared for this purpose. But where this furnace cannot be had a cylindrical sheet-iron stove will answer; line it with even the common red bricks; put the draft door below and the grate just above it, with a hole (ten or twelve

inches above the grate) sufficiently large for the entrance of the muffle, and a small hole broken, before lining, in the brick lining opposite the hole, with sufficient length upward of the sheet iron to allow the covering of the muffle above with coal to a height of at least four inches, and have a movable cover to the stove. This extemporized furnace will, with a practical operator, produce all that can be desired. We have for years used such a furnace with excellent results. The figure of a larger furnace for crucible work as well as for cupelling is given at the close of the description of reagents.

When, however, the assay is very small and the mineralogist chooses to use his blowpipe, he may make a little cavity in his charcoal and fill it with bone-ash, moistened and pressed neatly down, and upon this he may separate gold or silver from the lead, and with a little pure nitric acid in a test-tube dissolve the silver, leaving the gold deposit as minute dark powder at the bottom of his test-tube, to be washed, dried, and returned to the charcoal, and melted to a globule of gold.

#### *In Review.*

The reader should know that we have presented only that which shall be of most practical use in general, but particular applications will be given hereafter. Still it is, for more rapid progress, better that the suggestions already made should be followed out in actual work. No amount of instruction can take the place of actual experiment. A little practice will remove apparent difficulties. Especially

are the experiments with the blow-pipe to be made, until a degree of expertness is acquired before attempting to proceed to the subsequent parts of this work.

For specific gravity a pair of scales may commonly be used which may be loaded to the amount of six or eight ounces, and sensitive to a grain. In delicate analyses one more sensitive must be employed. No time, at first, is lost by attempting various experiments and other work, since expertness in the use of apparatus conduces to accuracy and rapidity when useful and necessary work is undertaken, and such expertness is to be acquired only by practice.

Out of the vast number of crystal-forms only comparatively a few are of importance to the mining mineralogist, and these forms are best studied from actual specimens.

But after all knowledge of the facts stated in the preceding pages many minerals are found which require other treatment before they will disclose their compositions, either as to quality or quantity. We shall, therefore, proceed to the study of what is called chemical analysis, stating at first certain principles a knowledge of which will render it more easy to study the practice.

All material substances are composed of a limited number of what are supposed to be simple or uncompounded bodies called *elements*. At present, discovery announces only about 66. In useful mineralogy there is special interest in only about 40.

But the most important fact connected with these elements is that they combine with each other in certain definite and unalterable proportions. For example, iron as an



element is not only purely and simply iron, but when it combines with the element oxygen, it does so in a proportion of 56 of iron to 16 of oxygen, never in less proportion than 56. If more iron combines with oxygen it will combine only as twice 56 or 112 to a multiple of 16, in this case three times 16 or 48, or if in any other combination it always acts as though 56 was its characteristic number. So it is with oxygen and the number 16, and so it is with every one of the elements and a definite number. Each element has its own unchangeable combining number, or "atomic weight."

It is, therefore, a matter of the highest value to determine the combining number of the elements, and chemists have in some cases devoted much time to this work.

Taking the same example of iron and oxygen, the union of the two in a compound mass of iron, called iron oxide, is precisely as though the mass were made up of 56 parts of iron and 16 parts of oxygen. If this be so in any one mass, it becomes very easy, by finding the amount of one element in that mass, to determine the amount of the other. Suppose I find that the element iron is present in the mass of pure oxide of iron to the amount of a certain number of grains or pounds, then the oxygen is easily found, and the per cent. of pure iron to the mass, as we shall show hereafter.

Chemists have abbreviated the names of elements by symbols for convenience sake, and these symbols appear in the table which follows. Combining weights are sometimes called atomic weights or equivalents, or combining numbers.

*Combining Weights of Elementary Bodies.*

Those in brackets are not as yet applied to any useful purposes.

Aluminum . . . . Al	27.5 (?)	Molybdenum . . . Mo	92 ? 95.5
Antimony . . . . Sb	122.(?)	Nickel . . . . Ni	58 7 ? 57.9
Arsenic . . . . As	75.	[Niobium] . . . Nb	93.8
Barium . . . . Ba	137.	Nitrogen . . . . N	14.
Bismuth . . . . Bi	208.	[Osmium] . . . Os	199.2 ? 198.5
Boron . . . . Bo	11.	Oxygen . . . . O	16.
Bromine . . . . Br	80.	Palladium . . . Pa	106.6 ? 105.7
Cadmium . . . . Cd	112.	Phosphorus . . . Ph	31.
Cæsium . . . . Cs	133.	Platinum . . . . Pt	197 ? 194.4
Calcium . . . . Ca	40.	Potassium . . . K	39.13? 39.01
Carbon . . . . C	12.	[Rhodium] . . . Rh	104.0
Cerium . . . . Ce	92.	[Rubidium] . . . Rb	85.4
Chlorine . . . . Cl	35.5	[Ruthenium] . . . Ru	104.
Chromium . . . . Cr	52.5	[Scandium] . . . Sc	44.
Cobalt . . . . Co	59.	[Selenium] . . . Se	79.
Copper . . . . Cu	63 5	Silicon . . . . Si	28. 28.2
[Didymium] . . . Di	96.	Silver . . . . Ag	108. 107.7
[Erbium] . . . . E	?	Sodium . . . . Na	23.
Fluorine . . . . Fl	19.	Strontium . . . . Sr	87.5
[Galium] . . . . ?	?	Sulphur . . . . S	32.
[Glucinum] . . . Gl	9.	[Tantalum] . . . Ta	182.6
Gold . . . . Au	197.	[Tellurium] . . . Te	129 ? 128
Hydrogen . . . . H	1.	[Thallium] . . . Tl	203.
[Indium] . . . . In	74 ? 113.4 ?	[Thorium] . . . Th	233.4
Iodine . . . . I	126.8	Tin . . . . Sn	118. 117.7
Iridium . . . . Ir	198 ? 192 ?	Titanium . . . . Ti	50 ? 48
Iron . . . . Fe	56(55.91)	Tungsten . . . . W	183.
[Lanthanum] . . . La	92 ? 138.5.	Uranium . . . . U	237 ? 238
Lead . . . . Pb	207. 206.4	[Vanadium] . . . V	137 ? 51.2
[Lithium] . . . . Li	7.	[Ytterbium] . . . Yb	172.8
Magnesium . . . Mg	24.	[Yttrium] . . . . Y	89.8
Manganese . . . Mn	55(53.9 ?)	Zinc . . . . Zn	65.
Mercury . . . . Hg	200.	[Zirconium] . . . Zr	89.4

*Note.*—Some of the atomic weights in this list are taken from the most recent edition of Fresenius, as found in his quantitative tables in the recent edition by Johnson. But the editor of that treatise doubts the weights of aluminum and antimony, and thinks that they should be 120 and 27.2 respectively, but as they have been used as 122 and 27.50, these numbers are retained. Where numbers are not in accordance with recent discovery we have added the more recent.

Comparatively few of the 66 elementary bodies have had their atomic weights, or what might more correctly be called their combining weights, certainly determined. Perhaps those which have been accurately determined are only hydrogen, oxygen, nitrogen, chlorine, bromine, iodine, lithium, potassium, sodium, silver, and thallium, as follows: H 1, O 15.9633, N 14.0210, Cl 35.3700, Br 79.7680, I 126.5570, Li 7.0073, K 39.0190, Na 22.9980, Ag 107.6750, Tl 203.7150. Manganese has recently been determined as 53.9 rather than 55 as in Fresenius, and molybdenum 95.5 instead of 92. The weights, as given in the recent edition of the *Enc. Brit.*, “*Chemistry*,” are, in many cases, at variance with more recent examinations. Our list is as nearly accurate as can be determined at present with the corrections we have suggested above.

#### THE PRACTICAL USE OF THE TABLE OF ATOMIC WEIGHTS.

The student may as easily learn to compute his “sought” elements from his “found” by using the table of atomic weights, as by the use of any other table, provided that he

be careful in his calculations. He may proceed as follows:—

Suppose he has found 20 grains to be the weight of peroxide of iron in an assay (ferric oxide)  $\text{Fe}_2\text{O}_3$ , and he seeks for pure iron. In the table, Fe is 56,  $\text{Fe} \times 2 = 112$ . O is 16, and  $\text{O} \times 3 = 48$ . Therefore the atomic weight of  $\text{Fe}_2\text{O}_3$ , as a whole, is  $112 + 48$  or 160; this number is the theoretic whole, and is equivalent to the 100 per cent. of which 100 per cent.  $\text{Fe}_2$  is the part sought. So the proportion is  $160 : 112 :: 20 : 14$  grains for actual *weight* of iron; or  $160 : 112 :: 100 : 70$  for simply the *per cent.* of iron.

Again, the per cent. of any one compound of an assay, if known, makes it easier to calculate the composition of the whole assay. This per cent. the assayer might readily calculate from the table, thus:  $\text{Fe}_2\text{O}_3$  is the ferric oxide found of which he has 20 grains.  $160 : 112 :: 100 : x$ ; here 160 is the theoretic whole, 112 is the theoretic iron in that 160 parts. Taking 160 as the 100 per cent., or the actual whole,  $x$  is the per cent. iron sought. Multiply the second and third terms of the proportion,  $112 \times 100 = 11,200$ , and divide by the first term 160 and we have 70 as the per cent. sought. So that  $\text{Fe}_2\text{O}_3$  always has 70 per cent. iron. If 70 per cent. is iron, then 30 per cent. must be oxygen. Let us test this latter element merely to prove the first. Then  $160 : 48 :: 100 : y = 30$ ; now as  $70 + 30 = 100$  the proportion is proved, 70 p. c. iron + 30 p. c. oxygen = 100. Let us now take a very complicated illustration. Thus, suppose the compound found is a hydrous ammonium salt of magnesia, which has been precipitated when we wish to find phosphoric acid, or

phosphorus in an iron ore, as described hereafter under Iron. The precipitate is composed of  $\text{NH}_4\text{MgPO}_2 + 6\text{H}_2\text{O}$ , and is ammonium magnesium phosphate, a white crystalline powder. When obtained it is heated to redness to drive off all the volatile parts, which are ammonia and water, and the changed remaining salt is weighed as  $2\text{MgO},\text{P}_2\text{O}_5$ , from which we wish to get the P and the Mg. We will suppose we have found 20 grains, and the P and Mg are to be found from  $2\text{MgO},\text{P}_2\text{O}_5$ . MgO is  $24 + 16 = 40$ ,  $2\text{MgO}$  is therefore  $40 \times 2 = 80$ ;  $\text{P}_2$  is  $31 \times 2 = 62$ ; and  $\text{O}_5$  is  $16 \times 5 = 80$ ;  $62 + 80 = 142$ . The whole, therefore, is  $80 + 142 = 222$ .  $222 : 62 :: 100 : 27.92$  phosphorus. Of Mg the proportion to the whole is 80 to 222, or 36.04 per cent., for  $222 : 80 :: 100 : 36.04$ . Of  $\text{P}_2\text{O}_5$ , or phosphoric acid,  $222 : 142 :: 100 : 63.96$ ; that is, the per cent. of phosphoric acid is 63.96. Now, as 20 grains were found, of which 27.92 per cent. is P,  $20 \times 27.92 = 5.58$  grains, these are P. From these examples the student may understand how to find the weight of any salt or compound. It would be well for the assayer to make a table of per cent. for the chief elements in which he is interested and keep it before him. Having the per cent. he has only to multiply his found weight by the per cent. to get the weight of the element sought. Thus, as we shall hereafter see, we frequently have  $\text{Fe}_2\text{O}_3$  in our assays, therefore note that this means 70 per cent. iron (Fe) and 30 oxygen. So treat all formulas we usually obtain. If we get say 20 grains of  $\text{Fe}_2\text{O}_3$ ,  $20 \times .70 = 14.00$  grains Fe. And so use the per cent. of P and Mg, when we get  $2\text{MgO},\text{P}_2\text{O}_5$ , and any other precipitate usually formed in course of work

hereafter. Form a table and use it without calculation afterward.

### THE GROUPS.

The groupings of compounds may form very convenient classifications, which it is well for the student to study in their relations to the action of reagents.

FIRST GROUP.—Metallic oxides not precipitated from their solutions by sulphuretted hydrogen, hydrosulphuret of ammonia, or alkaline carbonates. These are the alkalis proper: *Potassa, soda, lithia, ammonia.*

SECOND GROUP.—Metallic oxides not precipitated from their solutions by sulphuretted hydrogen, but precipitated by hydrosulphuret of ammonia only under certain circumstances, as salts, and also precipitated by alkaline carbonates. These are the alkaline earths: *Baryta, strontia, lime, magnesia.*

THIRD GROUP.—Metallic oxides not precipitated by sulphuretted hydrogen, but precipitated as oxides by hydrosulphuret of ammonia. *Alumina, glucina, chromium oxide, thorina, yttria, oxides of cerium, zirconia, titanac acid, tantalac acid.*

FOURTH GROUP.—Metallic oxides not precipitated from their acid solutions by sulphuretted hydrogen, but completely precipitated by hydrosulphuret of ammonia as sulphurets. *Oxide of zinc, oxide of nickel, oxide of cobalt, protoxide of manganese, protoxide and sesquioxide of iron, and sesquioxide of uranium.*

FIFTH GROUP.—Metallic oxides completely precipitated

from their solutions, whether acid, alkaline, or neutral, by sulphuretted hydrogen, their sulphurets being insoluble in alkaline hydrosulphurets. *Oxide of lead, oxide of silver, oxides of mercury, oxide of bismuth, oxide of cadmium, oxide of copper, oxide of palladium, sesquioxide of rhodium, oxide of osmium.*

SIXTH GROUP.—Metallic oxides completely precipitated from their acid solutions by sulphuretted hydrogen, but not from their alkaline solutions, their sulphurets being soluble in alkaline sulphurets. *Oxide of antimony, oxide of arsenic, oxide of tin, oxide of platinum, oxide of iridium, oxide of gold, oxides of selenium, tellurium, tungsten, vanadium, and molybdenum.*

As the student proceeds he may readily derive great help from the study of the preceding characteristics of metallic oxides, and we shall have reason to refer some oxides to these groups when speaking of the effect of certain reagents upon them.

#### THE REAGENTS.

WATER.—Formula  $H^2O$ . Atomic weight 18. Only the purest water should be used for the finest analyses. Rain water falling from a metallic roof, or from a shingle or slate roof, after it has been thoroughly washed, may be used under precautions: 1st, that it is not near the sea-shore; *impurity, sea salt*, tested by silver nitrate; 2d, that it has no organic matter in it, this impurity interferes by keeping some salts in solution which should precipitate, and otherwise tested by adding a few drops of pure sulphuric acid to the water in a

medium-sized test tube, then add a solution of permanganate of potassium, and gradually heating to 150° F., if this discolors the permanganate then it contains organic matter; 3d, in another test tube of the water, let fall a drop or two of hydrosulphide of ammonium—it should remain a clear straw tint. Any other appearance indicates some metallic salt. Distilled water is the best; steam from an engine may contain grease or oil. Rain water, as above tested, is next to distilled water.

ALCOHOL.—The usual alcohol of the drug store is 85 per cent., and is used in chemical work both for burning and for assays. Absolute alcohol is generally considered free from water, but this is seldom quite true, and it is seldom used. Methylic alcohol is cheaper and answers well for burning and blowpipe purposes.

HYDROGEN, H, atomic weight 1. It may be prepared for common use by using granulated zinc and dilute sulphuric acid. Add about one part acid to five or six parts water, and pouring slowly upon the zinc in a bottle which will bear a little heat, as the acid gives off heat when the water is added to it. Zinc may be granulated by melting it in a Hessian crucible and pouring it from a little height into a bucket of cold water. Hydrogen is sometimes used in reducing finely powdered iron ore to iron. In such a case it should be dry, and to obtain it thus it is passed through a glass tube filled with chloride of calcium. If needed very pure, the zinc must be pure. By passing it through a solution of caustic potash it may be rendered purer, and Mallet



recommends additionally the passage through a solution of bichloride of mercury.

If a small quantity is needed, absolutely pure, it may be collected over sodium, or by the galvanic decomposition of water between platinum electrodes as in the usual way by using a battery.

CHLORINE, Cl, 35.5. By subtracting H from hydrochloric acid we have the chlorine. This is best done by treating a mixture of peroxide of manganese to hydrochloric acid in a flask. As the chlorine is exceedingly disagreeable and injurious to breathe, the acid should be poured into the flask through a safety-tube bent in the form here shown at *B*. The manganese and acid are put into *A*, the latter being

Fig. 1.

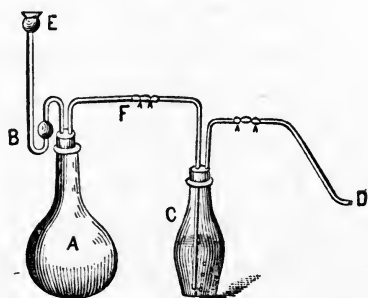

poured into *E*; there will always be some acid at *B* preventing any chlorine from escaping. The chlorine passes over to *C*, and if the water in the bottle *C* is cold it will absorb rapidly, but if driven over from *A* too fast, it will escape from *D*. When saturated pour it into a glass stopped bottle, put it in a cool place out of light, and generally upside down, since in that position the gas is less likely to escape.

The covering of bottles is always most efficient if we use thick pasteboard cylinders of just sufficient height and diameter to slip over the bottle easily, for if a closet is used the evaporations from various solutions, saturations, and reagents in some degree combine or deposit, and may create an unpleasant odor and injure reagents, and, moreover, every exposure to light in order to use one reagent affects all the rest within the closet, and it is no more trouble to remove the cover than to open the closet, and very few reagents need be kept in the dark. Black bottles are inconvenient, as we cannot tell the condition of the reagent.

Chlorine may sometimes be used simply as a gas. Toward the close of the operation it will be well to heat the flask gently by the spirit-lamp, placing the latter under the flask and drawing it away soon to prevent too sudden heat, then replacing again; or, better yet, place a close wire netting on the stand (14 to 15, or more wires to the inch), and set the flask upon that before applying the lamp. It would be well to join the tubes at *F* by a piece of rubber tube; sheet rubber is a poor thing to keep in the laboratory, unless kept in a tin tube, as it soon becomes weak, but when new it may be of service. Tie (with a soft cotton thread) your connections by rubber tube or rubber sheet.

BROMINE AND IODINE, Br, 80 and I, 127 (126.8).

Both of these are used as deoxygenating reagents. As sold, by good druggists and chemists, they are generally pure enough. Br must be kept very closely in well stopped bottles. It is used in three forms: (1) as free bromine; (2) as a bromine water which holds, at ordinary temperature, about

three per cent. of Br; (3) as solution in hydrochloric acid which dissolves about twelve per cent.

Sulphides (as iron pyrites), even in crystals, are readily decomposed by Br. Sulphur is more readily oxidized by Br than by nitric acid; and precipitated sulphides are thus easily broken up, and brought to a state fit for weighing, without the necessity of burning the filter in order to get the weight of particles often so entangled in the filter that burning becomes necessary, as we shall see in some processes hereafter described. The presence of ammoniacal salts (with which Br liberates nitrogen) hinders the formation of peroxides in acid solutions of cobalt, nickel, and manganese, but does not interfere with that in the like solutions of iron, tin, and mercury (Mallet and Fresenius). It is superior, in some respects, to chlorine water as an oxidant. Mallet finds that Br and iodine together act more energetically in breaking up cast-iron, for liberation of its carbon, than either alone; and Br, through which chlorine has been passed, acts more rapidly than that element alone.

Br is bought in liquid form, and of very dark brown, and iodine in tabular flakes, somewhat crystalline. The fumes of Br should be avoided, although very slight inhalations of either I or Br are not necessarily injurious. Stains upon the hands disappear after a while.

Bromine may be prepared by mixing the crystals of bromide of potassium with peroxide of manganese, and diluted sulphuric acid, three-quarters water, the former two in about equal parts, and adding the dilute acid so as to cover the mass in the retort, fastening in tightly, by clay luting, a glass

tube which is wrapped and kept wet with very cold water, better with ice, and thus the vapors condense into bromine liquid in an ice-cold receiver. Very gentle heat may be applied if the Br is slow in passing.

OXYGEN, O, 16. Oxygen is obtained by various processes, but the neatest is by heating chlorate of potassium with iron carbonate—the cheap so-called drop carbonate of iron is quite good enough. Usually, peroxide of manganese, the “black oxide,” is recommended, which is good, but much more uncleanly and harder to wash out in cleaning the retort. With the carbonate of iron the escape of gas may be regulated, or even entirely arrested, by withdrawing the lamp, and the remaining chlorate be used again. The peroxide of manganese and the iron carbonate are not decomposed, but simply, by their presence, they facilitate the decomposition of the chlorate. If the oxygen is to be extremely pure, chlorine traces must be eliminated after manganese peroxide is used, or carbonic anhydride ( $\text{CO}_2$ ) after the carbonate of iron, but it is rarely that the oxygen is not sufficiently pure with either. The little sparkling which sometimes occurs in the retort, due to some small organic matter, is of no injurious consequence in any way unless very dirty material is used in the peroxide.

IRON, Fe, 56. This is sometimes used for standardizing for volumetric analyses. The purest iron is generally obtained in piano wire. It is said to contain only four one-thousandths of impurity, and is consequently  $\frac{9996}{10000}$  pure iron. But this is not always so, and the wire must, for volumetric analysis, be analyzed, and the amount of pure iron deter-

mined, and allowance made for it. After a wire has been analyzed in part, the remaining part may be considered to be the same in purity as the section analyzed. It may then be kept in short pieces in a bottle free from dust and rust, being marked as to fineness.

**ZINC, Zn, 65.** This is used in various operations, besides simply for hydrogen. In volumetric analysis we require that it should be pure, and it can be distilled into water from an iron crucible with iron cover and tube fitted. It can be had from the chemical ware-stores in thin plates an eighth of an inch thick, nearly, if not quite, chemically pure.

**TIN, Sn, 118.** This is used by some in thin slips for determination of phosphorus and for the preparation of chloride of tin. The grain tin of commerce may be employed.

**HYDROCHLORIC ACID, HCl, 36.5.** Pure acid is colorless. Color indicates free chlorine, or ferric chloride, and the test is, that it turns blue immediately on the addition of a little paste of starch and iodide of potassium. Test it for the presence of sulphuric acid by diluting it twice or thrice its volume with water, and adding three or four drops of chloride of barium; a cloudy appearance indicates its presence. But the ordinary shop hydrochloric acid is also used, especially in making chlorine and for other purposes, and when the only impurity present is chlorine, it is good for gold solution and for the precipitation of silver. The presence of iron may be proved by the precipitation of the peroxide of iron on addition of ammonia to a diluted small amount of the acid; till the ammonia can plainly be smelled, let it

stand, and if no brown precipitate occurs after gentle heat and rest, iron is either entirely absent or extremely small in amount.

**NITRIC ACID,  $\text{HNO}_3$ , 63.** This is employed in two conditions, concentrated nitric acid, usually colored, and ordinary nitric acid which is less concentrated, and, when pure, colorless. It ought not to show presence of sulphuric acid (the test is the same as in hydrochloric acid), and it also should have no free chlorine; it may be tested by nitrate of silver, a drop of which will cause a white cloudy precipitate of chloride of silver, dense in proportion to the amount of chlorine present.

**AQUA REGIA.**—This is the name given to a mixture of nitric and hydrochloric acids, one volume of the former to three or four of the latter. It is better to make this when you use it for dissolving gold.

**SULPHURIC ACID,  $\text{H}_2\text{SO}_4$ , 98.** When pure it is colorless. The presence of any organic matter, a piece of cork, straw, etc., for instance, will darken the whole. Hence, no corks should be used. It has little effect upon beeswax stoppers, but glass stoppers are to be preferred. A current of hydro-sulphuric acid (sulphuretted hydrogen) should produce no precipitate in the pure dilute acid. When diluted with twice or thrice its volume of water, it should not decolor a drop of a solution of permanganate of potassium let fall into it, either immediately, due to the presence of  $\text{SO}_2$ , or after long contact with a slip of pure zinc, due to the presence of nitric acid. Arsenic, if present, is indicated in its precipitation by sulphide of barium, which brings down the

arsenic, and any excess of sulphide is converted into insoluble sulphate, and this latter method may be used for purifying  $H_2SO_4$  from this element (*Dupasquier*).

HYDROSULPHURIC ACID GAS, or sulphuretted hydrogen, or dihydric sulphide,  $H_2S$ , 34. This is formed by the action of sulphuric acid, or dilute hydrochloric acid, on sulphide of iron. Hydrochloric acid is preferable, since sulphuric acid crystallizes with the iron too easily. The apparatus shown in the section upon chlorine may be used. Into the flask put some small pieces of sulphide of iron and pour upon them diluted  $H_2SO_4$  or  $HCl$ ; convey the gas into some water (a wash-bottle) to collect any impurities which may come over, and by means of another tube bent down, it may be conveyed into an assay solution when we wish it to be saturated. For this purpose we may cheaply buy the sulphide of iron, or by heating a bar of iron white hot in a blacksmith's fire and pressing it against a roll of brimstone; the iron combines and drops off as sulphide and may be caught in water. Or a mixture of three parts of iron filings with two parts of flowers of sulphur projected into a Hessian crucible heated red hot, covered until well melted, and then the contents poured out upon an iron plate, or a stone surface, will supply all the sulphide needed. After using the apparatus, wash all out, and the remains of sulphide of iron may be kept in the flask for the next time. As there is no need to heat the bottle, any glass bottle, with a wide mouth for fitting in the cork and tubes, may be used, and kept for that purpose only, thus releasing the flask for more important service.

ACETIC ACID,  $C_2H_4O_2$ , 60. The usual acetic acid of commerce, containing about thirty per cent. of normal acid, is generally used. It is pure enough when it leaves no residuum upon evaporation from a platinum slip.

OXALIC ACID,  $C_2H_2O_4 + 2H_2O$ , 126. This acid is used to standardize solutions of permanganate of potassium. It is pure when no residuum is left upon a strip of platinum foil. But if not pure, it must be re-crystallized by nearly dissolving a mass of crystals in hot water in a porcelain basin, and when no more crystals will dissolve pouring all the solution upon a filter paper and filter into another basin and set by, in a warm place, to crystallize. The mother liquor is poured off from the crystals and returned to the former mass, and the crystals drained and laid on filter paper to dry, and then bottled in a wide-mouth bottle for use. Test some of it upon a clean piece of platinum foil. More crystals can be formed from the remaining solution until the mother liquor becomes of little quantity, and then it is generally seen to be impure, and should be thrown away. By use of this salt and carbonate of ammonium, and by crystallization, the assayer may make chemically pure oxalate of ammonium, as a reagent, for separating lime in his assays.

SUCCINIC ACID,  $C_4H_6O_4$ , 118. This acid is preserved in colorless crystals, and is used in making the reagent succinate of ammonium. It should not leave any residuum upon platinum foil.

TARTARIC ACID,  $C_4H_6O_6$ , 150. A solution of this acid in water is apt to mould, but it is said that if a small lump of camphor (gum) is dropped into the bottle it will remain



without mould. Mallet says that if the solution is made with boiling pure water, and the solution decanted, without filtering, into the bottle, it will keep a long time.

SULPHUROUS ACID or ANHYDRIDE,  $\text{SO}_2$ , 64. This is prepared by the action of sulphuric acid upon metallic copper. The apparatus is the same as for chlorine (see Chlorine), except that a strong heat is applied under the flask or retort. Pour into the flask, or retort, four parts sulphuric acid to one of copper strips, or wire, and apply heat—better with a wire gauze or netting under the flask—heat gradually at first and cautiously to prevent bubbling over. Pass the gas into the assay solution intended to be saturated, or, if intended for keeping in solution, pass it into stoppered bottles with cold distilled water, cork up tightly and remove to a cool dark place.

CARBONIC DIOXIDE, or carbonic acid gas,  $\text{CO}_2$ , 44. This is easily made by the action of hydrochloric acid upon pieces of marble; the acid seizes upon the lime of the lime carbonate and the  $\text{CO}_2$  is set free, thus  $\text{CaCO}_3 + 2\text{HCl} = \text{CaCl}_2 + \text{H}_2\text{O} + \text{CO}^2$ .

MOLYBDIC ACID,  $\text{MoO}_3$ , 144. This is used in the preparation of molybdate of ammonium. As sold, it is sufficiently pure.

POTASSA,  $\text{KHO}$ , 56. Pure caustic potass is sold in sticks. There is a caustic potass which cannot be used because of its impurities; it is called a lime potass. The so-called pure stick potass frequently contains some silica and perhaps a little lime and iron from which it should be free. It is best to test it and determine from a known weight just the per

cent. of these impurities it possesses, and then in assaying to allow for the amount found. It should be kept from the air, or it will absorb both moisture and  $\text{CO}_2$ . It may be tested as follows: a watery solution of  $\text{KHO}$  neutralized by hydrochloric acid should not be affected by hydrosulphide of ammonium, nor a precipitate be formed by oxalate of ammonium.

**SODA,  $\text{NaHO}$ , 40.** What has been said of potass equally applies in this case.

**AMMONIA,  $\text{NH}_3$ , 17.** Used as ammonia water, which is a solution of the gas, should be colorless, and should evaporate from the platinum foil without leaving a stain. It may be prepared by passing the gas over into a receiver, the latter in a freezing mixture. The gas is obtained from sal ammoniac, crude muriate of ammonium of commerce, when heated in company with lime powder, and it may be made of very great strength if the solution of the water be very cold and the gas be passed over for a long time. It should be free from  $\text{CO}_2$ ; the test is lime water; this should present no cloudiness. But it should be kept in small bottles, as it absorbs  $\text{CO}_2$  from the atmosphere.

**LIME-WATER,** solution of calcium hydrate,  $\text{CaO} + \text{H}_2\text{O}$ , is obtained by digesting slacked lime with cold water in excess, and decanting the clear water from over the lime. It must be kept from the air, or a pellicle of lime carbonate will form on the surface and become troublesome.

**ALUMINA,  $\text{Al}_2\text{O}_3$ , 105.** This is employed in fluxes for the dry method. Good common clay is used as sufficiently pure.

**LITHARGE,  $\text{PbO}$ , 223.** Pure litharge may be known by

its freedom from reddish spots of red lead ( $\text{Pb}_3\text{O}_4$ ), and also from any particles of lead. Passing it through a sieve will free it from the latter. It is used only in dry assay.

**OXIDE OF COPPER,  $\text{CuO}$ , 79.** The black, or peroxide of copper, is used either in powder, or finely granular state, the latter when used for making oxygen from chlorate of potassium in place of black oxide of manganese, or iron carbonate (see Oxygen). It is also used in the quantitative analysis of iron to determine the carbon by its combustion into  $\text{CO}_2$ .

**NITRATE OF POTASSIUM,  $\text{KNO}_3$ , 101.** The nitre of commerce, by one or two crystallizations, becomes pure enough for usual purposes.

**SULPHATE OF POTASSIUM,  $\text{KHSO}_4$ , 136.** If pure, hydrosulphide of ammonium should occasion no precipitate which would indicate the presence of alumina, or some metallic salts.

**CARBONATE OF POTASSIUM,  $\text{K}_2\text{CO}_3 + 2\text{H}_2\text{O}$ , 174.** The solution of this salt in pure water should be perfectly clear, and, when neutralized by hydrochloric acid, should give no precipitate and none with chloride of barium, showing absence of sulphates, and also none with hydrosulphide of ammonium, showing absence of metallic salts and of alumina. The solution evaporated to dryness in a capsule should leave nothing insoluble, showing absence of silica and other elements. But for some assays (dry) potassium carbonate need not be required of such purity, as in the making of black flux.

**BLACK FLUX.**—This is a mixture of the last-mentioned salt and finely divided charcoal. It is made by mixing one part of saltpetre and two parts of crude tartar (acid tartrate

of potassium) or argol, which, when purified, is so-called cream of tartar. This mixture is put into an iron vessel or pot, and set fire to by a piece of lighted charcoal and when burned out is broken up and put into a box in a dry place.

CHLORATE OF POTASSIUM,  $\text{KClO}_3$ , 122.5. It is sufficiently pure as sold in the drug-stores, and may be proved as the nitrate is, or, if not pure, recrystallized. (See under Oxygen.)

PERMANGANATE OF POTASSIUM,  $\text{K}_2\text{Mn}_2\text{O}_8$ , 316. Furnished sufficiently pure in the crystals to be had at the chemical shops. Generally the larger crystals are the purest. It may very easily be formed by the following process: Take 4 parts finely powdered black oxide of manganese (or a purer form of peroxide, which is also the binoxide), intimately mix it with  $4\frac{1}{2}$  parts of chlorate of potassium and 5 parts of hydrate of potass dissolved in a very little water. The pasty mass is dried, and heated to dull redness for some time (half hour) in an iron pot or clay crucible. The oxygen derived from the chlorate of potassium converts the binoxide of manganese into manganic acid, which combines with the potash of the hydrate. On treating the whole mass with water, the manganate of potash is dissolved, forming a dark green solution. This is diluted with water, and a stream of carbonic dioxide ( $\text{CO}_2$ ) passed through it as long as any change of color is observed; the  $\text{CO}_2$  combines with the excess of potash, the presence of which conferred stability upon the manganate, which is then decomposed into permanganate of potash and binoxide of manganese. The latter is allowed to settle, and the clear red solution poured off and evaporated to a small bulk. On cooling, it deposits

prismatic crystals of the permanganate of potash, which are red by transmitted light, but reflect a dark green color. Draw out the crystals and dry upon a porous tile.

Permanganate of potassium has great coloring power, and the readiness with which it loses this color in the presence of organic matter gives it great importance. Sulphurous acid, or a ferrous salt, deprives it of its color, and hence this property is utilized in the volumetric analysis of iron.

SULPHOCYANIDE OF POTASSIUM,  $KCNS$ , 97. Is only made use of in the quantitative determination of the persalt of iron. One part of the salt to 10 or 15 of water is the proper strength of solution. (See Volumetric Analysis.)

CHLORIDE OF SODIUM,  $NaCl$ , 58.5. It should be free from sulphates; the test is barium chloride. Pure table salt, dry, is sufficiently pure for most experiments. It is used in the quantitative determination of sulphur in the dry way, in order to reduce the intensity of the action of the saltpetre with which it is used.

SULPHURET OF SODIUM, or sodium sulphide.  $Na_2S + 9H_2O$ , 240. The usual crystal in which it may be found in the shops is pure enough. It is used in the volumetric determination of zinc. It should be kept in well-stopped bottles, as it deliquesces. A solution is made thus: Make a lixivium of pure caustic soda, divide it into two equal parts, through one of which pass hydrosulphuric acid gas to saturation, then reunite both parts, adding, if necessary, a little solution of caustic soda, to remove completely the odor of the hydrosulphuric acid, and then filter to obtain a clear liquid.

SULPHITE OF SODIUM,  $\text{Na}_2\text{SO}_3 + 10\text{H}_2\text{O}$ , 306. The solution should be clear, and after heating with sulphuric acid to expel the sulphurous anhydride it should not be affected by hydrosulphide of ammonium.

CARBONATE OF SODIUM,  $\text{Na}_2\text{CO}_3 + 10\text{H}_2\text{O}$ , 286. It is to be tested as in the case of carbonate of potassium, with which it is used to break up those bodies which are insoluble in acids, and thereby render them soluble. The two mixed in the proportions of 13 parts carbonate of potassium and 10 parts carbonate of sodium are found more efficient than either separately, and thus it is called "sodic carbonate of potassium."

BORAX, ordinary borax, unheated, is a baborate of sodium with 10 parts of water of crystallization. This water may be driven out with advantage to the operator with the blow-pipe, and then it is called the "*glass of borax*." It is used as a flux in dry assays. It is sufficiently pure as sold in the shops.

PHOSPHATE OF SODIUM,  $\text{Na}_2\text{HPO}_4 + 12\text{H}_2\text{O}$ , 358. One part of sodium phosphate in ten of water is the proper solution. No residue should be left in the solution, if the salt is pure, and no effect should be produced by ammonia even when the solution is warm.

ACETATE OF SODIUM,  $\text{C}_2\text{NaH}_3\text{O}_2$ , 136. The solution should be clear, and no effect should follow the addition of oxalate, or hydrosulphide, of ammonium.

SUCCINATE OF SODIUM,  $\text{C}_4\text{H}_4\text{Na}_2\text{O}_2 + 6\text{H}_2\text{O}$ , 270. This is preferred to succinate of ammonium only because it is easily

had in commerce; but the latter leaves no insoluble residue. Tests are the same as for the acetate.

**NITRO-PRUSSIDE OF SODIUM**,  $\text{FeNa}_2(\text{CN})_5\text{NO} + 2\text{H}_2\text{O}$ . This is only used in qualitative analysis. It may readily be had at the chemical stores. It is valuable with the blowpipe for some assays of sulphur to be hereafter mentioned.

**CHLORIDE OF AMMONIUM**,  $\text{NH}_4\text{Cl}$ , 53.5. It should leave no residue on platinum foil. It should be colorless, and give no precipitate with hydrosulphide of ammonium. Employ five parts of water to one of the salt. Sal ammoniac of commerce (ammonium muriate) is tolerably pure, excepting a little iron on outside pieces.

**HYDROSULPHIDE OF AMMONIUM**,  $(\text{NH}_4)\text{HS}$ , 51. This is obtained by supersaturating aqua ammonia with hydrosulphuric acid gas. It is also best to have a solution not quite supersaturated, and both should be kept in well-stopped bottles away from both heat and light. Though this may be had in the stores, it is better to make it in the laboratory, for it is easily made of the strength desired, either as *colorless* or *yellow*, as they act differently according to amount of sulphur. (See under Zinc, in a different part.)

**MOLYBDATE OF AMMONIUM**,  $(\text{NH}_4)_2\text{MoO}_4$ , 196. This reagent is employed usually in solution in nitric acid; one part of molybdic acid is dissolved in eight parts of aqua ammonia and twenty parts of nitric acid. It is filtered. It is used both in qualitative and quantitative analyses.

**ACETATE OF AMMONIUM**,  $\text{C}_2\text{H}_3(\text{NH}_4)\text{O}_2$ , 77 (tested as in the case of the carbonate), is used as we have said (acetate of sodium) in the place of the sodium acetate, as it does not

contain fixed matters, but it is a little more expensive for industrial purposes.

OXALATE OF AMMONIUM,  $C_2(NH_4)_2O_4 + H_2O$ , 142. One part to twenty-four of water. May be tested as in the previous ammonium salts. It is valuable as a reagent for lime.

NEUTRAL SUCCINATE OF AMMONIUM,  $C_4H_4(NH_4)_2O_4$ , 152. The commercial crystallized succinate of ammonium is the acid succinate  $C_4H_5(NH_4)O_4$ , 135, but the neutral is prepared directly from the succinic acid and ammonia, till the solution is neutral, as tested by litmus paper. Or it may be prepared from the acid succinate above mentioned by saturating with ammonia till neutral.

CHLORIDE OF BARIUM,  $BaCl_2 + 2H_2O$ , 244. Used in solution with ten times its weight of water should be completely soluble and show no precipitate with hydrosulphide of ammonium.

NITRATE OF BARIUM,  $BaN_2O_6$ , 261. Make the solution of fifteen parts water to one of the salt. Its test for purity is the same as in the chloride.

CARBONATE OF BARIUM,  $BaCO_3$ , 197. This is made in the following way: Dissolve chloride of barium in a large quantity of warm water, heat the solution, and as soon as it begins to boil, pour in gradually a solution of carbonate of ammonium or of sodium, until precipitation takes place, then let the fluid settle, protected from dust; decant the clear fluid and repeat the washing by decantation with warm water till the supernatant fluid gives no precipitation with nitrate of silver. The carbonate of barium should remain



suspended in as much water as will form a cream, and be preserved in that state in a stoppered bottle.

CHLORIDE OF CALCIUM,  $\text{CaCl}_2$ , 111. As this salt is used only to absorb moisture and because of its ready deliquescence, it need not be pure. It is prepared by the action of hydrochloric acid upon fragments of white marble until the acid is saturated with the marble, and then the solution evaporated in a porcelain dish till it becomes pasty, porous, and perfectly dry. In the latter condition it is better than when fused. Break it up into fragments and preserve it in a well-stopped bottle, remembering that it absorbs moisture rapidly from the air.

SULPHATE OF MAGNESIUM,  $\text{MgSO}_4 + 7\text{H}_2\text{O}$ , 246. This salt is used to precipitate phosphoric acid, and it must, when mixed with chloride of ammonium, be not affected either by ammonia, or by its oxalate, nor by hydrosulphide of ammonium, even after an hour's repose. It may be prepared for use thus: Prepare a solution of one part of crystallized sulphate of magnesium and one part of chloride of ammonium in eight parts of water; add four parts of ammonia, let it rest for some days and then filter. The common name for sulphate of magnesium is Epsom salt.

NITRATE OF SILVER,  $\text{AgNO}_3$ , 170. The usual commercial salt in clear crystals is usually pure enough. One part to twenty parts of pure water is the proper dilution. If no organic particles exist in the solution, it may be kept in the light without any loss of clearness. Dust settling around the stopper may cause some degree of blackening, but it is generally a matter of little consequence, and occasional care

in dropping will prevent any important results from exposure to light. (See further reference to this salt at the close of these remarks on Reagents.)

A very convenient method of making pure nitrate of silver in crystals may be adopted as follows: Take a silver coin (25 cts.) and dissolve completely in common nitric acid (free from chlorine); a little dark powder may remain, this is gold; filter and the gold powder may be reduced under blowpipe, or mashed against a piece of steel or smooth iron surface with another hard surface, and the metallic gold color will appear. Into the clear solution pour slightly diluted hydrochloric acid or sodium chloride, till no further white precipitate falls. Drop several pieces of granulated zinc into the vessel, and, if acid enough, the acid will immediately act upon the zinc and hydrogen will be set free, which, uniting with the chlorine of the silver chloride, will soon begin to leave the silver as a pure metal, changing the white chloride into a dark gray mass of pure silver powder. After the silver has been entirely reduced and no specks of white chloride remain, the zinc may be removed, if not already dissolved, and the mass of spongy silver well washed by decantation from the blue copper solution of the coin and from the zinc and chlorine which may be in solution. Pure nitric acid may now be gently poured on till all the silver is dissolved. It may then be poured into an evaporating dish and gently heated till crystals appear, which may be removed and dried after cooling. If carefully managed, the crystals are pure nitrate of silver in very perfect form.

**LITMUS PAPER.**—Digest one part of commercial litmus in six parts of water, filter the deep blue liquid and divide it into two equal parts; into one drop carefully some very dilute sulphuric acid until the blue color just begins to show a tinge of red; unite the two parts in a sufficiently large dish and dip in some sheets of unsized paper; dry the sheets by hanging them where no acid vapors can reach them; when dry cut them into strips half inch wide and put them into a wide-mouthed bottle closed from dust.

**RED LITMUS PAPER,** for testing alkaline solutions, may be made by adding some drops of sulphuric acid to the blue solution until the color is changed to pink, then dipping the paper into this reddened solution and drying and cutting into strips as in the former case.

**SALT OF LEAD PAPER.** This paper is used only in the volumetric analysis of zinc by sulphide of sodium. Glazed paper, or note paper dipped in a solution of acetate of lead and dried, will detect the presence of sulphides in solution.

**MICROCOSMIC SALT,** or salt of phosphorus,  $(\text{HNaNH}_4)\text{PO}_4$ , if in crystals +  $8\text{H}_2\text{O}$ . Used with blowpipe. Boil 6 parts of sodium phosphate and 1 part ammonium chloride in 2 parts water, for a few seconds, then cool and crystallize. Recrystallize after addition of some aqua ammonia.

#### CAUTIONS AND SUGGESTIONS.

In selecting a room for a laboratory, especially in a house used for other purposes, choose an upper room or one aside or on the corner of the house with a north window. Have

the light, if there is plenty of it, on only one side, or at best have no cross lights, except in a large room where cross lights do not interfere with ready examination of assays. Place the assay table near the light. It is important to use front or side lights in determining shades of color and precipitations. North windows are always the best if they can be had. If possible, cut off one small room for the assay balances to keep them from dust and fumes of the laboratory.

For a private laboratory a sand-bath may be made by filling a sheet iron pan made two or three inches deep, with clean sand. The sand may be washed by being shaken, or stirred, in a bucket of water till the water comes off clean, then drained and placed in the pan to dry. This made firm upon the stove, if it has a flat top, will serve all the purposes. If a hood can be placed over this sand-bath leading, by a sheet-iron stove-pipe, into the chimney, it will be very useful in carrying off vapors of all kinds.

An assay furnace may readily be made, as we have suggested elsewhere (see Iron, Dry Assay), by using fire-bricks or even common red bricks; the latter burn out sooner; but where the former cannot be had the latter will answer, placed in a sheet iron cylinder. It may be arranged for a cupelling furnace at the same time, as we have already mentioned, but we give the plan in outline here.

The diameter of the sheet iron cylinder should be at least 17 inches, better 20, with a bottom swagged upon it tightly, the top open and fitted with a flanged heavy sheet-iron cover *E E*. Place this cylinder as in the figure where it is

permanently to be, and upon a hearth of common brick *F F F*. Begin by laying one round of bricks and fitting them in tightly leaving an opening at *C* for draft. The next point will be the grating, which, if it cannot be had of

Fig. 2.

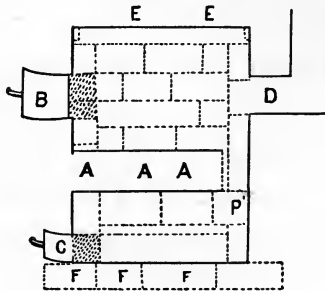

sufficient diameter at a stove store, may be made from  $\frac{3}{4}$  inch by  $1\frac{3}{4}$  inch wrought iron, cut in lengths to suit, with  $1\frac{1}{2}$  inch between bars. If wrought iron must be used it should be heavy to keep from sagging under heat. Better to put your carpenter to work to make a pattern of that size and have it cast. The pattern need not be very true nor neatly finished for this work, and cast iron always outlasts wrought iron. But generally a grate may be had from the stove dealers and the brick work accommodated to the grate. A wood pattern allows you to renew the grate whenever burned out. Continue building up the brick, filling up the interstices with smaller pieces, and perhaps mortar or cement, until *A A A* is reached; at *P* place a brick projection, for a muffle to rest upon as described under iron, silver, and gold assays, having previously had an opening at the

front, both in the sheet-iron case and the brick lining. The muffle should be bought before and the hole and shelf brick projection fitted to the muffle. Proceed in raising the lining inside the curve, leaving a neat hole for the pipe *D*, and door *B*. At the door top lay a flat bar from one side to another in order that the bricks may be laid over the opening, and thus finish till the lower edge of the flange is reached. Let all stand for a day and then kindle a small fire with chips and let the stove slowly heat until all is dry. The cover *E E E* should be laid on so that it can easily be removed, and when used as a furnace for crucibles, it can be taken off entirely when drawing out the crucibles. An important matter is the draft; there should be a good draft, and a plug of brick fitted at *A* to close the stove up when the muffle is not used, and when used the muffle should be put in only when the fire is started and the coal level with the muffle bottom, then other coal added until all the muffle is covered. If the case is about 17 in diameter and the bricks 4 inches (fire brick) wide, unless the end edges are knocked off the fire pot, or inside space, will be only 9 inches, unless the brick be placed flat side against the iron case which will answer very well. But if a larger size is wanted for the space inside, calculations therefor are easily made. We have had one furnace 20 inches in diameter with common brick laid on edge which has worn with one relining for over a year in good order. Anthracite will cut through quicker than coke, or charcoal, but it is a more lasting fire and must be used where much evaporation is

carried on running through the night, otherwise coke may be used, or even soft coal (bituminous).

As for analytical scales for quantitative analyses, one that turns at less than a milligramme is sufficiently delicate, the advantage in sensitive scales being that labor, time, and money are saved to the assayer, for if his scales will not allow of accurate weighing small quantities, he must take more of the assay, and use more of the reagents, and take more of his time. The more delicate the weighing, therefore, the less quantity of assay need be taken to arrive at the same results which might be obtained by greater trouble. Never weigh hot articles or assays, ascending currents always making the weighing inaccurate. If your scales are covered with a tight case and in a dry room, nothing need be put within the case to absorb moisture, but if you suspect any moisture a little unslaked lime or dry chloride of calcium may be placed in a saucer or cup within and back of the scales or in a corner. Never handle small or large weights in fine scales with your fingers, use the nippers or weight tongs. Filter papers may be burned in porcelain crucibles as well as in the platinum. Cut your papers to the size of five or seven inches diameter, having a circular piece of tin as a constant measure; take two pieces of one size and let them soak in pure water a half hour, and then drain them, and, when perfectly dry, roll them up, or cut one up, so that it will go into the crucible, and then burn it to a uniform white, all the carbon being burned out; let the crucible cool perfectly, then weigh and note this weight; treat the other piece in the same way and weigh; if they are very nearly

the same in weight, take the average weight and make record of it, on a similar piece of paper, as the ash weight of that particular size minus the weight of the crucible in which you must heat the filter paper. Always cool and weigh before placing the filter paper in to burn; the weight of the crucible taken from the weight of crucible and ash, gives the ash weight of that size and of that kind of filter paper. By this means we can calculate the weight of precipitations which have been left in too fine a powder to be separated from the paper in filtration.

#### HOW TO USE REAGENTS AND GLASSWARE.

In testing with silver nitrate a slovenly assayer will use ten or fifteen drops upon the assay in a test tube, when two drops are sufficient. Neatness requires but one drop skillfully squeezed out by lifting the stopper a little way up, then turning the bottle over and gradually pressing in the stopper. So it is with all reagents, use no more than is necessary. By a little practice you may always drop one drop, lift the stopper to let the reagent fall back, then push your stopper in. Do all this with one hand, except perhaps to draw the stopper out at first. Beside the economy you can always more quickly judge as to how your analysis and washing when filtering are proceeding, by always using the same amount of reagent. Practise on one drop. Keep all things cleanly. Using reagents "in excess," means that in using, for instance, an alkali, you must make the liquid decidedly alkaline when it was previously acid. This is tested by either smell, as in ammonia, or by red litmus paper. So, also, in



using an acid "in excess," only in such case it is in the reverse, using the blue litmus or testing by absence of any smell.

**CAUTION.**—Very frequently in using ammonia and some other reagents, the inexperienced operator may find that to the smell and to the sight, and by the test, an assay may seem to be what it is not, because attention has been drawn only to the surface, when by stirring the solution it may be found that only the surface to some small depth has been acted upon. Therefore, before decision has been made, stir well the solution, mixing the top and bottom, and then make your inference upon the whole.

A small glass rod, one-quarter of an inch in diameter, is generally sufficient for solutions; but a tube hermetically sealed at the end, or both ends, is stronger than a solid rod of the same diameter. A platinum wire of one-eighth inch thickness, or smaller, and several inches long, is of greater service, especially in heated alkaline mixtures or solutions in the platinum and porcelain crucibles, but such a short rod is not fit for large solutions.

**HEATING GLASSWARE.**—Some begin carelessly as to heat, and they are apt to continue, to their great discomfort, loss, and cost, to the end. Glassware is made, or intended, to stand heat, but it does not always answer the end nor the intentions for which it was made. In the hands of a careful operator it seems as if the glass becomes annealed after use. At any rate in the same operating room one operator will break by heat, as well as by carelessness in other ways, one-third more of his stock than his neighbor. In beginning,

great care in heating and using brittle-ware will, as a habit and "way of doing things," stick to the man as sharply and closely as the other habit, and time will be gained as well as cost avoided.

Flasks and beaker glasses containing solutions may be heated by a spirit lamp more safely by avoiding the placement of the sharp upper end of the flame against the bottom of the vessel. Push, or hold, at the beginning, the lamp so that the flame is cut off half way, and then, moving the flame around the bottom for a few seconds, withdraw a second or two, and then, returning the lamp, perform the heating in the same way for a minute or so, according to the bulk of solution to be heated, taking care (especially when the liquid gets hot) that the wick of the lamp does not touch the glass; any good glassware may always allow the boiling of the solutions without any danger of cracking even in the coldest room, if treated in this way. Some glassware breaks more readily than others. Preserve that glass flask or beaker which has stood the heat for more important assays, and test your new flasks, etc., with water (required to be used boiling) or with some other work which, in case of the fracture of the glass, will occasion no loss worth regretting.

WATER pure enough for usual work may be caught, as we have already said, from a roof which has been cleansed by sufficient rain. If not near the seashore, this may answer well as it is, but it may contain a little free carbonic dioxide ( $\text{CO}_2$ ), which however is extremely small, and, after considerable rainfall, entirely unimportant. The water may be kept in a glass or sheet copper vessel with a cover for general

supply. But a small copper box with a pipe leading from the top long enough to enter a receiver, which may be kept cold summer or winter, will furnish sufficient pure water for particularly delicate operations. All water used for assay purposes should be evaporated upon a clean platinum strip for the detection of any permanent salts, and should be tested for chlorine (by silver nitrate) and for  $\text{CO}_2$  (by lime water or acetate of lead), if no stain is formed after evaporation, and no effects from the reagents just mentioned, it may be used instead of distilled water. When the wind blows from the direction of the ocean the salt may be detected in water falling even 60 miles from the coast, and during such rains the water should not be collected until the storms or rains come from other directions.

*A List of usual Chemical Apparatus.*

For a private laboratory the following apparatus is necessary:—

Beaker glasses, one nest.

Several flasks, from 8 to 16 oz. Three with flat bottoms called matrasses.

Half dozen test tubes, medium sizes, with a test tube stand.

Porcelain dish, two sizes. 6 to 8 inches across top.

Half dozen porcelain crucibles with covers, of about 1 oz. volume.

One pipette. Two or three feet of glass tubing  $\frac{1}{4}$  inch bore.

Glass funnel, medium size. The sides must be straight not bulging.

One dozen glass stopped narrow-mouthed bottles, half of them 6 oz. size.

Half dozen wide-mouthed glass bottles from 6 to 8 oz. size.

One nest Hessian crucibles for dry assay.

The following chemicals:—

Nitric acid, hydrochloric acid, sulphuric acid.

Caustic soda, caustic potass, aqua ammonia, alcohol, one ounce litmus, molybdic acid, silk bolting cloth from the miller. Pure filtering paper.

The following may be bought or made in the laboratory: oxalate of ammonium, chloride of ammonium, sulphate of magnesium, phosphate of sodium, chloride of barium, nitrate of silver, sulphide of iron, permanganate of potassium, hydrosulphide of ammonium, and for any other reagents beyond these the preceding list may be consulted. But the above are necessary for the beginner.

To the above apparatus we may add the alcoholic lamp which may be of glass with ground-glass top, or of metal made by the tinner with a perforated cork for a cap for the wick. But for the laboratory, where gas is not ready at hand, one of the most useful lamps is the alcoholic blast lamp which is used for heating, to redness, refractory ores and other assays in the crucible, and for drying and calcining assays, bending tubes, etc.

Where the beginner does not choose to make his own stand for holding his evaporating dishes, etc., over the flame, he may purchase either the wooden or iron stands as seen in

the catalogues of the chemical goods and apparatuses of any dealer. So, also, as to test-tube holders, etc.

We have given the above list and directions as presenting about the smallest stock with which the student in analysis can begin, and to this we should add the platinum crucible, which, after a while, he will have to purchase, with its capsule, and it would be well if he added among the necessaries the blowpipe.

To those articles which we have mentioned above, the beginner may add as he progresses, but he should keep in mind the fact that some of the best analysts in Europe and America have met with their greatest successes while using very simple appliances in kind and very few in number beyond those which were of their own manufacture or invention.

IN FOLDING FILTER PAPERS the simplest way is to fold them half over and then quarter and so on until the pleats are about quarter to half inch, and then opening them part way, push the whole down into the funnel through which the filtration is to be performed. Always before using a filter paper hold it up to the light and examine if there be any thin spots where there may be an opening and reject it if the appearance is very nearly that of a hole, as frequently, under these conditions, the paper is likely to let the whole assay down at once.

WHERE THE LOWER PART OF THE INVERTED CONE of the funnel is as wide as a half inch, or a little less, it is advisable to make a little inverted cone of platinum foil just large enough to cover the hole and let the sharp end of the filter

paper fit into the cone. This will act as a brace to the paper and the filtrate will pass through just as well as before. Nothing must be filtrated over this which would dissolve any of the platinum (as aqua regia or nitro-muriatic acid) but generally where filtrates are rapidly made and weakened very soon, this evil result is seldom to be apprehended.

In order to make the platinum cone fit well, a neatly fitted small, or miniature, funnel may be made of writing paper dampened and closely pressed up against the glass sides of the funnel in that part for which the platinum is to be fitted. Then prepare a thick cream of plaster of Paris with some two or three drops of gum-arabic solution in water with which the cream is made, the amount of plaster being only enough to fill the bottom part of the funnel where the paper is. Pour, when well mixed, this mixture into the funnel very slowly till it begins to set, or stiffen, which it will not do for some minute or two, because of the gum-arabic solution. Pour all in and let it harden, thrusting into the mixture a small rod of wood, three or four inches long by which to draw it out when hard. Let it stand for an hour, draw it out, remove the damp paper, and when quite hard it is ready to mould the platinum upon. In order to do this, make a paper funnel of the exact size wanted, then laying this upon the platinum carefully mark out the size and cut the platinum and fit it upon the plaster cone which when dry will be found nearly as hard as a piece of marble. Burnish it down, fitting it neatly, then place it in the funnel

and it will exactly fit and will allow a great pressure upon the filter paper without breaking the paper.

If a jar have a large cork fitted nicely into the top, and a hole be cut into which this funnel may fit air-tight, and another hole cut for another tube bent at an angle and fitted in air-tight, we shall now have an apparatus for rapid filtering. If when filtering is going on through the funnel, the mouth be applied to the second tube and the air drawn out the water will run through the filter with a rapidity proportioned to the vacuum formed in the jar.

Two thin sheet copper cans, of the size of half gallon jars, may be made to make the vacuum desired for rapid filtering and after this contrivance:—

Fig. 3.

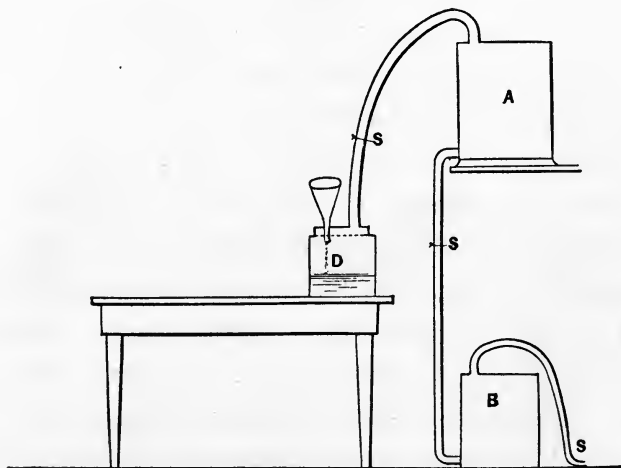

*A* and *B* are the two copper, or tinned copper, cans connected by a rubber tube. *D* is a glass jar used for this

method of filtering. Use pinch stops, or clips, at  $S S S$  to arrest the flow when such arrest is necessary; open the tube at the lowest  $S$  and that near  $A$ , and the water will flow into the lowest reservoir  $B$  and create a partial vacuum in  $A$ . Open the tube at  $S$  nearest to  $D$  and a similar vacuum is formed in  $D$  and the filtration begins and proceeds rapidly in proportion to the perpendicular distance of the two reservoirs. When the lower one is filled, exchange place and tubes and the process is renewed. In order to separate the rubber connection from the filter jar, the tin or glass tube in the jar should be very nearly of the size of the opening of the rubber tube, so that it may slip off easily; it may be wrapped with a cotton thread if it is not sufficiently tight. Of course stopcocks of a small size costing more would be more convenient and indeed they must be used where great pressure is adopted, since, in that case, stronger rubber tubes must be used, so strong and thick that pinch-stops would not close the tube. The operator must consult his own judgment as to the pressure desired. Ten feet apart for the cans is sufficient distance for ordinary use, and less will be a great saving in time expended in washing, or filtering, and, with a little care and ingenuity, small wide-mouthed flasks may be used, but a glass jar is strong and may readily be emptied of its contents despite the shoulder, provided the angle of the shoulder is not too nearly that of a right angle. The use of the wash bottle, or pipette, will aid in the clearing out any remains of the filtrate where that is to be transferred from the jar to the beaker glass. A block of wood may be fitted into a jar with rubber band around the



edge, so as to make an air-tight joint, and it may be easily removed and as easily replaced.

PLATINUM CRUCIBLES should not be too thin, and should be heated over an alcohol lamp, but as little as possible with the ordinary city gas, as that induces roughness and incipient corrosion. Although caustic alkalies (potash and soda) must sometimes be heated to red heat in the platinum crucible, and thereby some wearing away by corrosion of the crucible takes place, this cannot be avoided, and the only alternative is to weigh the perfectly clean crucible frequently to notice the decreased weight so as to keep an accurate account for such assays as must be weighed with the crucible, and the weight of the crucible subtracted. The action of alkalies treated in the way above described might cut holes in the porcelain crucible, hence they should not be used, except where the destruction of the crucible and the additional impurity of the substance of the crucible are of no importance in the result desired.

*Brasque* is the term used to express the condition of a crucible, usually Hessian, which has been lined inside with charcoal. In order to perform this work it is best to mix some powdered charcoal with molasses to the consistency of thick paste and with a paddle-formed stick line the sides thoroughly, leaving no part unlined. In some cases where the crucible is small it is well to fill it full with the mixture, pressing it down hard, and then cutting the hole out with a pointed knife. After gradually heating till all the vapor and gas from the molasses has passed off, and, smoothing inside, the crucible is ready for work. When covered

tightly over by a piece of tile or brick (luted), ores may be reduced under great heat, and neither the slag nor metal can attack or injure the crucible, and slag can be separated easily from the crucible which, without the brasque, would cut holes into the sides.

*Fuming nitric acid* is sometimes of great use in the reduction of stubborn sulphides and in some other operations. It is easily made from dry and broken up saltpetre (potassium nitrate). Use a pint or quart tubulated glass retort placed in a retort stand. Put in only about half a pound of saltpetre, and pour over the saltpetre enough undiluted sulphuric acid to cover the contents. Introduce the beak of the retort into a glass stopped bottle, which should better be surrounded by ice or cold water. After everything is arranged apply heat by either an alcoholic flame or coal oil light set so as not to smoke the glass. The acid soon comes over and is condensed in the bottle. After all condensation ceases, withdraw the bottle, introduce the stopper, and set the yellowish-looking fuming acid away out of light and in a cool place. The residue in the retort may be purified by recrystallization and used as disulphate of potash in assays as directed in the text. But as a flux for some very stubborn ores, as those of chromic iron and aluminous minerals, where it may be used for making them soluble in acids, the following additional preparation is necessary: Test some of the recrystallization for lead, or arsenic, which may have existed in the sulphuric acid used. Recrystallization will render it sufficiently pure. Then mix 87 parts (weight) crystals (dry) with 49 parts pure sulphuric acid, and heat to

low redness until the mass is in limpid fusion. A platinum crucible should be used, and the work repeated, if the crucible is small, to obtain sufficient quantity. Pour out the melted mass on a porcelain plate or fragment. After cooling break the mass into pieces and keep in a bottle for use.

While some chemists advise the use of potassium disulphate, others (J. Lawrence Smith, for instance) think that sodium disulphate is much more soluble in water after the same ore treatment.

SODIUM DISULPHATE is used with powdered assays in the same way as the disulphate of potassium, but is considered much more soluble in water, after the ore or assay treatment.

The preparation is similar to that of potassium disulphate only that Glauber's salt (sulphate of soda) of the shops is used and purified by crystallization exactly as in the previously mentioned disulphate of potassium. The salt should be heated at a gentle heat to drive off its water of crystallization. Then 7 parts of salt to 5 parts pure sulphuric acid should be heated to low redness in a platinum crucible or dish, and all treated as in the case of the potassium disulphate.



## ECONOMIC TREATMENT AND HISTORY OF THE USEFUL MINERALS.

---

IN the following pages we shall treat of all the important minerals in order. We have proceeded upon the principle of stating that which most recent discovery or experiment has shown to be most probable in the economic history or most efficient in the treatment of that particular mineral under consideration, and generally omitting unimportant statements and suggestions, however recent or novel, excepting where such statements and suggestions might render clearer what has already been stated.

Especially in the analysis or the determination of a mineral we have frequently had reason to feel that one good method skilfully pursued was followed by better results than another which, although better in some degree, was attended with certain complications or requirements which rendered it uncertain as to results or unnecessary.

The student who has made himself acquainted with the work and suggestions of the previous pages, will find little difficulty in understanding the references in the following pages.

The hardness of a mineral is always compared with that of the diamond rated at ten, and the scale of descent, in

degree, may be formed by comparison with the following substances, which may be obtained from any mineral collection, or salesman, remembering that the samples must be as pure as can be obtained, preferably in crystal form, and also that there may be a slight difference in degree in hardness even in the same species, so that determinations must be left, in some small degree, to the judgment of the mineralogist.

10. Diamond.

9. Corundum (pure emery).

8. Spinel, topaz.

7. Quartz (rock crystal), Beryl 7.5, Zircon crystal 7.5.

6. Pyrite, marcasite, massive red hematite, cassiterite, garnet 6.5, feldspars 6 to 7.

5. Leucopyrite, mispickel (arsenopyrite) 5.5, fibrous limonite homogeneous specimen, apatite.

4. Zinc blende (sphalerite) 3.5 to 4, fluor spar 4, zincite (red oxide) 4.5.

3. Calcite (crystalline specimens) common 2.5 to 3.5, pyrrhotite 3.5, Barite (Barytes sulphate) 2.5 to 3.5.

2. Sulphur (native) (brimstone), galena 2.5, salt (common) in mass or crystals 2.5, mica (phlogopite) 2.5, anthracite 2 to 2.5.

1. Graphite, "black lead," native, realgar 1.5, sal ammoniac 1.5, gypsum 1.5 to 2, copal.

## GOLD.

## OCCURRENT CONDITION AND FORM IN NATURE. NATIVE.—

If crystalline, generally in that pyramidal form known as the octahedral or eight-side figure, similar to that which would result from joining together, at their bases, two equilateral four-sided pyramids. Frequently the gold occurs in arborescent forms, and in one specimen, in the author's possession, the octahedral form occurs only at the termination of the arborescent mass. Also in irregular masses called nuggets, in flattened scales, in particles called dust, and in various intermediate shapes, appearing as though the gold had been melted and conformed to the substances in which it cooled. It is, however, very improbable that all such gold was melted, certainly some masses have once been in solution in some liquid anterior to the time when they assumed the shapes they now retain.

**HARDNESS AND SPECIFIC GRAVITY.**—Hardness from 2.5 to 3; grav. from 15 to 19.34, the latter when quite pure (Rose).

**COLOR** varies from dark yellow, when quite pure, to light yellow, according to amount of silver in composition.

**DUCTILE AND EXTREMELY MALLEABLE.**

**COMPOSITION.**—Native gold seldom, if ever, occurs pure. The usual alloy is silver, but sometimes copper, palladium, rhodium, and iron. Judging from a large number of analyses, native gold always contains silver, very seldom any more than a trace of copper and iron. Dana mentions (see under gold) one analysis showing traces of tin, lead, and cobalt, and

one having a trace of bismuth, both foreign specimens. In the cases of alloys with palladium and rhodium, of the former 10 per cent., of the latter 34 to 43 per cent. They were rare and foreign specimens, and not worthy of further mention.

UNITED STATES LOCALITIES.—Gold is widely distributed, and occurs where it is so minutely diffused that it would be a loss of time and money to attempt to gather it. It is not surprising, therefore, that gold may be frequently found where no useful results follow the finding. From various authorities, including Dana, Whitney, Silliman, and others, we gather the following summary showing the distribution, the associations, and geologic horizons of gold as generally met with in the United States and Territories. There are numberless mines along the mountains of Western America, and others along the eastern range of the Appalachians from Alabama and Georgia to Labrador, beside some indications of gold in portions of the intermediate Azoic region about Lake Superior. They occur at many points along the higher regions of the Rocky Mountains . . . in New Mexico, near Santa Fe, Carillos, etc., in Arizona, in the San Francisco, Wauba, Yuma, and other districts; in Colorado abundant, but the gold is largely in auriferous pyrites; in Utah and Idaho. Also along ranges between the summit and the Sierra Nevada, in the Humboldt region, and elsewhere. Also in the Sierra Nevada, mostly on its western slope (the mines of the eastern being principally silver mines). The auriferous belt may be said to begin in the California Peninsula. Near the Tejou Pass it enters California, and beyond,



for 180 miles, it is sparingly auriferous, the slate rocks being of small breadth; but beyond this, northward, the slates increase in extent, and the mines in number and productiveness, and they continue thus for 200 miles or more.

Gold occurs also in the coast range in many localities, but mostly in too small quantities to be profitably worked. The regions to the north in Oregon and Washington Territory are at many points auriferous, and productively so, though to a less extent than in California. Gold occurs in Virginia, North and South Carolina, and Georgia, or along a line from the Rappahannock to the Coosa in Alabama. But the region may be said to extend north to Canada; for gold has been found at Albion and Madrid in Maine; Canaan and Lisbon in New Hampshire; Bridgewater, Vermont; Dedham, Mass. Traces also occur in Franconia Township, Montgomery Co., Pennsylvania. In Virginia, the principal deposits are in Spotsylvania Co., on the Rappahannock; at the United States mines and at other places to the southwest; in Stafford County ten miles from Falmouth; in Culpeper County, on Rapidan River; in Orange, Goochland, Louisa, and Buckingham counties. In North Carolina, chiefly in Montgomery, Cabarrus, Mecklenburg, and Lincoln; in the alluvial soil in the counties of Burke, McDowell, and Rutherford. In Georgia, in Habersham County, and in Rabun, Hall, Lumpkin, at Dahlonega, and in Cherokee County. In South Carolina, the principal gold regions are the Fairforest in Union District and the Lynch's Creek and Catawba regions, chiefly in Lancaster and Chesterfield Districts, also in Pickens District, adjoining Georgia. (Dana.)

Prof. Frank H. Bradley, after speaking of the copper mines at Ducktown, Polk Co., Tennessee, writes that: "On both sides of the copper leads, but most abundantly to the south, there are gold-bearing schists, in which small operations have been carried on for many years. The only point in Tennessee which has attracted special attention is on the head waters of Coca Creek. The 'placer' deposits are but moderately rich and of rather limited area. Gold-bearing quartz veins have been found at two or three points, but little work has been done in them. Farther south, in Georgia, the decomposition of the rocks has gone on to greater depths, more material has been concentrated, and valuable placer properties are known at several points; at two or three points, hydraulic mining is carried on successfully, as in the region about Dahlonega. I think that there is every reason to believe that there are as rich mines in Georgia and North Carolina as any in California. The Tennessee deposits have been but little known thus far; but there are geological reasons for expecting that good mines will yet be developed there."

The Gold Hill mines in Rowan Co., North Carolina, have produced not less than \$2,000,000. The King's Mountain mine in Gaston Co., N. C., is said to have produced over \$1,000,000, and that of the Portis mine in Eastern North Carolina, in about fifty years, over \$1,000,000.

The mines of South America and Mexico were estimated by Humboldt, over sixty years ago, to yield annually \$11,500,000, which much exceeds the present product. The yield of California in 1849, the first year after the discovery

of the gold, was \$5,000,000. The yield in 1853 was nearly \$60,000,000. Since then it has diminished, and the amount in 1866 was \$27,000,000. Montana, Colorado, Idaho, and Nevada raised the total from the United States for the year 1866 to \$86,000,000. The same fact of decrease may be shown in connection with the gold yield of Australia, from \$60,000,000 for a number of years it fell to \$30,000,000 in 1863, 1864, 1865, the sum being an average for each of these years. This fact of decrease of the gold yield in mining districts after a series of years, inversely considered, suggests the probability that large amounts of gold were derived from the mines of ancient times, and, in that virgin period of gold hunting, the metal far exceeded in quantity any amount which in these latter days has been revealed.

From *The Mineral Resources of the United States* (Williams), 1885, the total annual production of gold in the United States from the year 1867 (\$53,000,000) decreased to 1875 (\$32,000,000), when it increased to 1878 (\$51,000,000), and then decreased till 1883 (\$30,000,000), since which time it has been on the increase. The greatest annual production was in 1853, \$65,000,000. In 1884, December 31, it was reported as \$31,000,000; for 1886 it is given by the Director of the Mint at \$35,057,889.

One of the practical suggestions derived from the fact that estimates of the above nature cannot always be relied upon, is that there are many private enterprises the reports of whose profits are not made public. There are small firms or companies, and even individuals, content to make comparatively small sums, who, by less outlay and more toil, have actually

done better than large companies. These have never reported.

Alaska is growing rapidly into a gold producing country, although in 1884 the product, \$200,000, was a third less than in 1883. But in 1881 it was only \$15,000, in 1882 \$150,000, in 1883 \$300,000, in 1886 \$446,590.87.

The annual output of gold and silver in the United States is about the same in value as that of pig-iron at present prices, but far below the value of the coal production. (Williams, 1885.)

GEOLOGY OF GOLD AND ITS ASSOCIATIONS.—There is no positive evidence that gold exists in nature in any other than the metallic state, although it is believed by some to exist as a sulphuret in some varieties of pyrites. (Bloxam.) And, in behalf of this view, it may be offered that the free gold in many places has evidently resulted from the oxidation of the iron pyrites and the consequent unclenching of the native gold embedded in the pyrites. If some auriferous pyrites be treated carefully with nitric acid, particles of gold are left in the native state, although there was apparently no possible method, by comminution or any other physical treatment, of discovering the gold, even by the microscope. This has been tried in specimens taken from the Columbia mines near Helena, Montana, in which the gold appears to be almost chemically combined with the pyrites as a sulphide of gold.

Nevertheless, gold will combine with sulphur in the laboratory, to form two GOLD SULPHIDES: (1)  $Au_2S$ , *Aurous sulphide*, formed as a dark brown, almost black precipitate,

when hydrogen sulphide is passed into a boiling solution of auric chloride; (2) *Auric sulphide*,  $\text{Au}_2\text{S}_3$ , is precipitated in yellow flocks when hydrogen sulphide is passed into a cold dilute solution of *auric chloride*.

The extent to which gold is distributed in small quantities is remarkable, for there are few countries where it may not be found, but, in many cases, in such finely disseminated condition as to offer no inducement to those who are wise and do not desire to lose money to collect it. So that the discovery of gold is by no means a proof that, commercially speaking, there is any value added to the land where the gold has been found, or that, in any true sense, a working on that land may be called a gold mine.

Gold has been found in Cornwall, England, in the same alluvial deposits wherein tin ore occurs, and in Königsberg the metallic gold is disseminated through sulphuret of silver; in Edelfors in Smoland, Sweden, it is associated with pyrites. The sands of the Rhine contain minute quantities (eight million parts of sand to one of gold), and yet it is worked when other work is scarce. (Bloxam.) The sands of the Danube, Rhone, Tagus, and many other European rivers afford gold and have been, at different periods, worked for this metal.

Veins of pyrites containing gold are found in a *granite rock* at the foot of Monte Rosa. (Bloxam.) Siberia yields gold distributed through *horn stone*.

In Australia it is found deposited upon pipe clay under the alluvium.

But the gold of the world has been mostly gathered from

the gravels and sands of rivers, and the sand of any river is worth washing for the gold it contains, if it will yield 24 grains in a hundred weight; and provided, always, that labor is cheap. The sand of the African rivers, however, often yields sixty-three grains of gold dust in not more than five pounds weight.

Gold occurs in rocks of various ages, from the Azoic to the Cretaceous or Tertiary, but the *in situ* or original rock is the metamorphic in which veins of quartz are found traversing the metamorphic and charged with gold in strings, plates, scales, and masses of crystals. (Dana.) Many theories are offered for its appearance which are not important, but gold is generally found in the crystalline rocks, or is derived from such rocks, after these rocks have through ages become disintegrated and carried away by means of the transporting agency of water.

It is plain, therefore, that the mineralogist should be largely guided by the geologic intimations in his explorations for this metal.

Very frequently the strata which bear gold are not distinctly defined or separated from those strata, or parts of strata, which are entirely barren. So that nothing in the nature of the rock can, in all cases, determine it as gold-bearing. This is frequently illustrated in North Carolina, where, according to Dr. Genth, "it (the gold) has been acted upon by chemical agencies, dissolved and precipitated again, and has assumed a crystalline structure; it has accumulated in strings which sometimes form lenticular and more highly auriferous masses in the beds, and is associated with crystal-

line quartz, pyrite, chalcopyrite, galenite, blende, mispickel, etc.”

In King's Mountain mine, of Gaston Co., N. C., the gold is, to a great extent, contained in a quartzose limestone, and is associated with very small quantities of pyrite, galenite, chalcopyrite, but also with the very rare tellurides of lead; altaite, and with nagyagite, a telluride of gold and lead. In some places this ore bed is over thirty feet in thickness, and has been worked to a depth of 200 feet, but, longitudinally, only to a very small extent, not over 250 feet. (Journal of the Franklin Institute, January, 1872.)

In North Carolina, the gold, though originally found in nuggets, is now generally found in grains and in fine dust, its average fineness being 825 thousandths, and is associated with platinum, diamond, zircon, xenotime, menazite, and many other minerals. (Genth.) At the Portis mine, in the eastern part of the State, the gold is generally about 985 thousandths fine, and in the gravel beds.

Those deposits which have been formed from a decomposition of gold-bearing rocks, which has been carried on through ages, are the most valuable, as nature has concentrated the nuggets or particles at the bottom of the sand, gravel, or loose material, and, in some instances, has given an additional power of gravitation to the gangue rocks which held gold, so that they have parted companionship with fragments which were barren. The most extensive gravel deposits exist in the South Mountains, on the head waters of the first and second Broad River, Muddy Creek, and Silver Creek, in the counties of Rutherford, McDowell, Burke;

Caldwell, also in Polk and Cleveland, embracing an area of over 200 square miles (Genth). Even the soil and clay, which cover these beds in some places, are more or less auriferous, although poorer than the gravel beds.

A peculiarity in the North Carolina gravel beds is found in that the attempt to work the gravel, as a mass, for gold, by crushing it, was a failure, inasmuch as the fine or small quartz veins were the gold-bearing veins, and not the large quartz veins; this fact, with that derived from that which has already been stated as to natural concentration, explains the cause of failure.

In Montgomery County there are gravel deposits in the slate formation, some of which have proved highly important, yielding nuggets and crystalline flat pieces with very little fine grained gold.

The average fineness of California native gold, as deduced from thousands of assays at the Philadelphia Mint, is  $88\frac{1}{2}$  parts gold, and  $11\frac{1}{2}$  parts silver in 100 parts.

For the following additional remarks we are indebted to the late Wm. E. Du Bois, chief assayer of the U. S. Mint, Philadelphia, Pa.

*Native* gold, or silver, does not occur absolutely pure, yet sometimes so near it that it would be called such, commercially. Gold grains have resulted 998. Silver will more nearly approach 1000: still there is something between it and the chemist's refinement. In fact it is a pretty high attainment of our art to make these metals chemically pure, and fit for proofs.

We have found a wide diversity, and a vast variety in the



fineness of California gold. It has resulted as low as 812, and as high as 957, the general average is probably 880 to 885.

The alloying metal is silver and the two *together* will, after melting, generally show 995 parts of precious metal, the remaining 5 parts being the oxide of iron, which covers and permeates every grain. It is this which gives such high and deceptive coloring to the native gold. It is quite surprising to see the same gold, before and after melting; being so much paler in the latter case.

There is however before melting a larger association than that of base matter; for in the melting there is a removal of  $2\frac{1}{2}$  to 4 per cent. of the original weight; the 5 thousandths just spoken of still remaining in the alloy as a trace. In the parting process this last trace disappears.

In the earlier days of California gold a few samples were assayed by eminent chemists in Paris, and they actually asserted a union of gold and silver in atomic proportions. A larger experience, it might be said a little reflection, would have convinced them of the absurdity of such an idea. And yet that statement is seen copied from one book to another, even down to a very recent work on assaying by a high authority.

Gold and silver are found together in every possible grade of proportion. It is only in the very rare case of a natural crystalline structure that the proportion can be supposed to be atomic, so that this affirmation should not be copied, although made even by so high an authority (if we mistake not) as Boussingault.

The gold of North Carolina has to a large extent the same range of fineness as that of California; but in an extreme case (mentioned by Mr. Frederick Eckfeldt to Mr. Du Bois) it came out 991. Its average is lower than that of California. Georgia, Tennessee, and Alabama, on the other hand, are considerably higher. In Nova Scotia there are two general classes, one of them quite high, the other below our standard.

The differences in the gold of Australia are very marked. They classify their mines as Northern, Western, and Southern. In the first, the range has been found from 654 to 962, with an average below 900; the Western mines run from 915 to 960; the Southern 928 to 983. We have considered Australian gold to find an average at 960; doubtless from Southern mines. To all these classes, in which gold preponderates, the new chlorine refining and parting process, invented and perfected by F. Bowyer Miller, Esq., of the Melbourne (formerly of the Sydney) Mint, is admirably adapted. He was at the U. S. Mint, Philadelphia, in 1871, and exhibited his process of working it [by passing chlorine through the melted metal].

The gold of Colorado is generally pale; that of Montana is higher in per cent., but of so varied grades that the average can hardly be better stated.

The natural alloys and accompaniments of gold present a large and curious study. Can any plausible reason be given why *silver* is always in company with gold, and copper almost never? And yet, when we come to make a mixture artificially, gold takes to copper more keenly than silver

does. The following is a note of an experiment by Mr. J. R. Eckfeldt made some years ago.

A *prise* of 900 parts gold + 100 copper; and another of 900 silver + 100 copper, were made upon the the assay-beam, wrapped in lead foil, and placed in cupels side by side. They were subjected to a high heat in the oven. When taken out the *gold* button was found to retain 23 parts copper. The *silver* lost all its copper.

While speaking of gold affinities and alloys two other curious facts must be noticed. One is, that gold in its natural condition is usually found in the motherly embrace of *iron* in some mineralized form, say oxide or sulphide. And, yet, an attempt to unite them in a crucible will be unsuccessful. They will not mix, except in an imperfect, heterogeneous way.

But the other more curious fact, which, like many others, warns science rather to seek for facts than to attempt to account for them, is found in this, that lead, in its native mineral form, is sure to contain both silver and gold, yet, chiefly, in infinitesimal proportions. Spanish pig lead, which of all the commercial leads is the freest from silver, has been found containing one-third of an ounce to the ton; and when that silver was dissolved, it was found to contain gold.

A very remarkable case was that of galena found in New Britain, Bucks County, Pa., where Mr. Eckfeldt found  $2\frac{1}{4}$  grains of gold, say ten cents' worth, to the ton of lead.

Now, by what imaginable process of nature do these

atoms of silver and gold find place in this base metal, and in such proportions?

#### METHODS OF TREATING GOLD ALLOYS.

In a foreign periodical we find the following statements which contain much which is important in the refining of gold.

In the Mint of the United States, ferruginous gold is melted with a mixture of sulphur, and carbonate of potash and soda; tin, antimony, and arsenic are removed by melting with borax, soda, and saltpetre, or according to Warington, tin and antimony may be extracted by melting the gold for half an hour with one-tenth of its weight of oxide of copper and some borax. Lead may be removed by melting with saltpetre and sand, or a little chloride of mercury enveloped in paper is repeatedly thrown into the mass, fused with saltpetre and borax, until a sample taken shows sufficient ductility. 0.02 per cent. of lead renders gold brittle.

Pettenkofer states that almost all extracted gold contains a small amount of platinum, from which it may be freed as oxide of platinum and potash by melting with saltpetre. This amount of platinum not only retains silver in gold, but causes a considerable loss of gold when melting it with saltpetre. Whilst finely divided gold when melted with saltpetre oxidizes with more difficulty than platinum, it oxidizes most readily in the presence of platinum, forming slags containing as much as 19 or 20 per cent. of gold and  $2\frac{1}{2}$  or  $3\frac{1}{2}$  per cent. of platinum. If the gold also contains silver, the silver protects the platinum from oxidation, and the

platinum then enters the argentiferous gold. All the platinum will enter the slags if the gold contains not more than 0.5 per cent. of silver, and not more than 0.3 per cent. of platinum. Besides the potash of the saltpetre, the slags contain all the metals which were attacked at the previous treatment with sulphuric acid, and transformed into insoluble salts (sulphate of lead, sulphide of copper, basic sulphate of iron); some components of the crucible (silica, alumina, lime) also enter the slags, and metallic oxides formed by the reaction of the saltpetre upon the metals (oxides of gold, platinum, palladium, osmium). Some fine gold and some silver grains are also mechanically included, owing to the great viscosity of the slags.

Experience shows the best admixture for smelting to be 16 parts of gold with 1 part of saltpetre, when the resulting slag will weigh about as much as the saltpetre employed. The average loss of gold by the slag is 1 per cent. when using saltpetre in that proportion; an addition of borax renders the slag more liquid.

The whole of the small amount of platinum in the gold usually enters the slag.

The amount of gold grains in the slag depends chiefly on the quantity of gold smelted. If larger quantities of gold are melted in one charge, the relative and absolute amount of gold in the slag will always be much larger than when melting the same quantity in different operations; it is best to melt exactly 10 lbs. in one operation, as when employing crucibles of equal size the trough slag stands higher in the crucible than when melting smaller quantities. The higher

the slag stands in the crucible the more the sinking of the gold grains is impeded. Sometimes a skin, consisting of fine grains of metallic gold, is formed on the lower side of the slag, caused by the sinking of gold grains after the temperature has decreased below the melting point of gold, whilst the slag is kept liquid; the gold grains cannot then unite either with each other or with the gold below. When melting small quantities of gold the slag formed is also proportionally thinner, retaining for that reason fewer grains of gold. The crucible is liable to corrosion by the potash present when trying to render larger quantities of slag more fluid by a continued firing.

The reverse takes place with any silver in the slag. The particles of silver still contained in the gold remain suspended in the slag together with some gold, owing to the light specific gravity and the fine distribution of silver, and they sink more slowly the thinner the slag is. Therefore one and the same quality of gold alloy will yield gold of greater fineness (by 0.001 or 0.002) when melted in larger quantities than when melted in smaller lots.

To extract gold and platinum from the slag, Pettenkofer recommends that they should be mixed with water to a thin paste, and then added to a mixture of two parts of litharge, one part argol, four parts soda, and two parts pulverized glass to every eight parts of dry slag. "The mass is thoroughly mixed and then dried in an iron or copper pan, and melted in a crucible previously heated red-hot. The resulting raw lead is cupelled, yielding brightened silver, which is granulated and treated with aqua regia in a glass

cucurbit.\* After solution, heat is continued to expel the nitric acid; chlorides of silver and lead are filtered off, and the gold is precipitated from the liquid by iron vitriol; it is then washed, dried, and fused with saltpetre in a Hessian crucible. The remaining liquid contains the platinum, and is warmed with iron, thus precipitating various metals; these are boiled with nitric acid, leaving platinum as a residue. This platinum is dissolved in aqua regia, and extracted by ammonia, etc.”

This method of extracting gold and platinum, partly in the dry way, is preferable to employing the wet way exclusively.

When re-melting gold containing osm-iridium, the osm-iridium will sink to the bottom, owing to the great specific gravity; therefore Californian gold, containing about 0.1 per cent. of osm-iridium, is melted, at the mints in Philadelphia and New York, with two or three parts of silver, thus lessening its specific gravity; the specific gravity of the resulting gold alloy is from twelve to thirteen, whilst that of osm-iridium is nineteen. On stirring the fused mass for some time the osm-iridium will settle to the bottom; the contents of the crucible (8 or 10 lbs.) are ladled out till within one inch from the bottom, and granulated. The remaining metal, rich in osm-iridium, is repeatedly melted with silver, thus concentrating the osm-iridium more and more; 60 lbs. of silver are added at each of the last four or five meltings; after stirring, the mass is allowed to settle for some minutes

\* [A flask, sometimes shallow, and with a wide mouth, or neck. It must be capable of bearing heat.]



and ladled out, leaving 10 lbs. of metal in the crucible, from which the silver is extracted by sulphuric acid, whilst the separated gold is washed out, leaving the osm-iridium. As gold containing osm-iridium entails more working expenses it is sold at a cheaper price.

Gold containing osm-iridium from Bogoslowk is melted at the mint in St. Petersburg, in a large plumbago crucible; the gold is carefully ladled out to within one or one and a half inches of the bottom, and the remainder contains the osm-iridium, amounting to about 5 lbs. from several meltings. These 5 lbs. are then melted in a small plumbago crucible with a narrow bottom, and after cooling the lower part of the metal regulus, consisting of osm-iridium with a little gold sticking to it, is cut off; this gold is dissolved in aqua regia, which does not attack osm-iridium.

The dross resulting from the treatment of Californian and Australian gold, containing gold, silver, and osm-iridium, is melted with a reducing and purifying flux containing litharge, thus producing raw lead, which is cupelled, yielding an alloy from which the silver is extracted; an alloy remaining of gold and osm-iridium.

According to d'Hennin, the separation is best effected by smelting 12.5 parts of dross with 15 parts of black flux, 14 parts of chalk, 2.5 or 3 parts of arseniate of soda, 20 parts of borax and carbon, and some litharge and argol. Auriferous and argentiferous lead then result, and on the top a mass, consisting of arsenic, iron, and osm-iridium, which can be easily separated from the lead and cupelled.

Palladium may be extracted from argentiferous gold by means of nitric acid.



## USE OF CAST IRON IN "PARTING" GOLD.

The parting of gold by means of sulphuric acid has been greatly developed by the employment of platinum vessels, though on account of their great expense they are at present but little used, and cast-iron vessels are almost universally employed. Platinum vessels resist perfectly the reaction of hot concentrated sulphuric acid, but being very expensive to make and to repair, and being liable to considerable waste from the friction of the granulated metal on their sides, they require to be treated most carefully. At the moment when the finely divided gold, in contact with the platinum, is exposed to the influence of the boiling acid, the gold cakes and sticks so fast to the platinum that it must be dissolved with dilute aqua regia, if slight blows on the outside of the vessel are not effective. This operation requires much dexterity. Above all, platinum must not be exposed to contact with lead and tin, as they readily alloy with it at the temperature of boiling sulphuric acid. The platinum vessels are usually placed in iron jackets or frames.

At the mint in Munich, platinum vessels about  $9\frac{3}{4}$  inches high, furnished with a platinum head 5 inches high, and  $9\frac{1}{2}$  inches in diameter, were formerly used; these vessels were placed in an iron frame; at present iron vessels are used. Eighty-two and a half lbs. of auriferous silver, containing about  $15\frac{1}{2}$  per cent. of gold, are treated in three platinum vessels, each containing  $26\frac{1}{2}$  lbs., with 173 lbs. of concentrated sulphuric acid. The vessels are heated first with wood and afterwards with turf. Two and a half times as

much sulphuric acid is employed as there are silver and copper in the alloy. The heads of the vesels communicate with a leaden tube, partially filled with water, in which any escaping sulphuric acid condenses. The surplus sulphurous acid is conducted into the chimney by means of a leaden tube.

The solution is finished in three hours when some dilute sulphuric acid of  $55^{\circ}$  B. is added to precipitate the suspended particles of gold; after slightly cooling in a tilting apparatus the greater part of the sulphate of silver is poured into a platinum vessel, leaving the gold at the bottom.

If the solution is not quite clear it is reheated with an addition of dilute sulphuric acid and finally poured into the leaden precipitation pan, which is filled to one-third with water. The last auriferous muddy liquid is put into a smaller lead pan and decomposed by means of copper, the resulting silver, alloyed with gold, is then smelted and added to the next extraction. The gold remaining in the solution vessel is boiled three or four times with sulphuric acid, and the acid of the last boiling is used for dissolving auriferous silver. The gold is washed, dried, and melted without any addition; the washing water is filtered into the precipitation pan. The lixivium of silver vitriol is concentrated to about  $25^{\circ}$  or  $27^{\circ}$  B. and decomposed by copper, 100 parts of silver requiring 30 parts of copper-plate. The precipitated silver is washed, dried, and melted in a Hessian crucible standing within a plumbago crucible; some saltpetre is added to each spoonful of charged precipitated silver. The resulting silver has usually a fineness of 995.5. The resulting lixivium of copper vitriol is concentrated to  $32^{\circ}$  or  $34^{\circ}$  B. and allowed

to crystallize, the remaining mother liquor is boiled down to 36° B. and recrystallized, and the second mother liquor is boiled down to 56° B. in a leaden pan, and to 66° B. in a platinum pan, when it is suitable for dissolving auriferous silver.

At St. Petersburg platinum vessels were formerly used, four parts of sulphuric acid were added to every three parts of silver contained in the alloy. One extraction was performed in from six to ten hours. The resulting gold was boiled once more with sulphuric acid and contained when smelted 99.666 per cent. of gold, and the silver was of a fineness of 99.15. Cast-iron vessels are now used there.

#### THE DISCOVERY OF AND PROVING GOLD ORES.

Simple as the assertion may seem to one possessed of a merely theoretic knowledge, yet one of the most important and useful accomplishments for gold exploitation, is "an eye for color." There is a peculiar color which native gold possesses which is readily recognized, although that gold may be alloyed with silver or copper, and its color will in an instant distinguish it in the eye of the expert from any condition of pyrites, whether iron or copper pyrites. This remark relates strictly to native metal, especially as found in finely comminuted particles. Nothing but familiarity with the metal will lead to the possession of an eye for color and the power of an instant recognition of the metal.

The simplest instrument for the discovery of gold in fine dissemination through sand or dirt is a common iron pan or

dish. Some dirt is thrown in and water poured on the whole mass and by adroit shaking and by turning the pan over slightly to one side until the finer particles are left above the edge of the water, the small particles of gold are left because of their gravity almost on the extreme edge of the dirt and will be instantly recognized by an "eye for color." It is not only the "color," but quickness to discover the actual presence of the particle, which is included in the art of using the pan, and we have known experts recover considerable gold from pan washings which had been by others supposed to be exhausted. However, a certain adroitness is essential in handling the pan by which some will expose every particle of a handful of "pay dirt" in a few minutes and will not leave two dollars to the ton. This, where water can be had, is the most efficient instrument a man can travel with in his gold-seeking journeys.

Where four or five join to work a place that is supposed to pay, the cradle or rocker is more rapid, even if the pan must be used afterward. There are several ways of putting a cradle together, but the principle depends upon separation of the larger barren pieces with greater ease and rapidity. Hence the usual form is that of a long trough as represented in Fig. 4, wherein *A* is the handle for rocking the cradle, *D* is the upper slatting for receiving the coarse

Fig. 4.

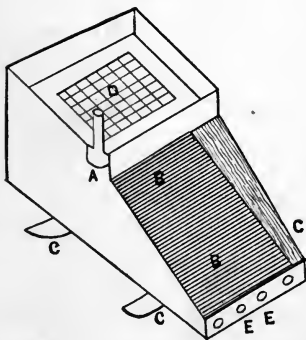

dirt and catching larger stones and material to be thrown out by hand, *BB* the false bottom which should be made movable and raised about an inch or two above the true bottom and which consists of slats placed closely to one another and nailed to a strong frame so as to be removed and replaced easily. *CC* are the rockers. The water and dirt thrown in at *D* are rocked through to *BB*, excepting the larger pebbles, etc., and the finer pebbles and dirt pass over the riffle-bars *DD* out at *EE*. The clean sand with gold will be found in the bottom and must be removed as soon as the sand touches the bottom of the "riffle-bars," else thin particles of gold will be lost.

But in spite of all care much gold escapes under this process and therefore the sluice system of washing dirt with mercury was introduced. This depends upon the fact that mercury (quicksilver) readily amalgamates with gold even in the smallest particles. So a series of wooden troughs, all on an inclined plane, are made perfectly tight and occasionally fitted with cross-bars made tight enough to hold quicksilver. The descending material holding gold is somewhat checked at these little reservoirs of quicksilver, and the gravity of the gold causes it to come in contact with the metal with which it is immediately caught and the rest of the material passes on. Success depends upon the length of the line of troughs, the proper inclination, the sufficient supply of water, and sufficient quicksilver.

But sometimes the gold is so combined with other substances, especially sulphur, also arsenic and tellurium, that the amalgamation is found difficult. For this there has

been found a remedy in mixing the quicksilver with a small per cent. of sodium. Wurtz, of New York, who claims, with Crookes, of London, this discovery, uses about 4 per cent. of sodium which combines with quicksilver to form a hard amalgam. Crookes uses zinc and tin as in the following proportions: 77 quicksilver to 3 of sodium and 20 of zinc, and 77 quicksilver, 3 of sodium, 10 of zinc, and 10 of tin. Of this hard amalgam only one part to 100 of quicksilver, or even less, is quite sufficient. The writer has kept it in bottles for months, but the tendency, if exposed to the air, is partially to decompose, but even after partial decomposition its efficiency is considerable.

When the quicksilver has been sufficiently loaded with gold, it is removed, squeezed, and put into a flanged iron crucible, covered with an iron cap with an iron tube leading from it, and, after thoroughly tightening, the end of the pipe is submerged in water and fire applied to the retort, or crucible. Great care must be taken not to heat the crucible, or retort, beyond the heat sufficient to volatilize the quicksilver, which is then caught in the water for use again. The gold is left in a spongy mass. In some places a canvas tube is attached to the end of the tube and passes under the water with a view to prevent the water from running back into the retort in case a vacuum is formed, but we have found no such results where ordinary care has been taken.

But the largest quantities of gold are not free, but occur in the rock and quartz, and this requires the use of machinery to crush the rock, which work is done by rollers, stamps, and mills.

## POORER ORES CONTAINING GOLD.

But beside those forms in which gold is found, native or as placer gold, and of which we have spoken, there are other and poorer ores in which the gold does not appear to the eye as in the ores which we have described.

These ores are such as bear a large proportion of silver, tellurium, lead, iron, and copper in the form of sulphides, and they appear also with other associations. The mineralogist cannot detect the gold in these ores without experiments in proving them, and yet some of them are very important ores. With care a few of them may be analyzed with the blowpipe and the gold detected, but even then the analyst must finally resort to the use of nitric acid to separate the silver, or to the use, on the charcoal base, of some bone dust to absorb the lead which may be combined with the gold. The better way is to use the crucible and fuse the supposed ore with lead or litharge, or even with plumbic sulphide (galena). But it is necessary, in some cases, to concentrate the ore before you are ready to combine it with lead, especially if it be a lean ore, and this may be done in several ways. If it be an iron, or pyritic ore, it is well to break it down into smaller particles (not powder), and roast it in a low red heat to drive off some of the sulphur. If the ore has quartz in it which cannot be separated, it may be mixed with about a quantity of powdered lime equal to the bulk of quartz and heated, after the slow roasting. The lime and quartz, forming a slag, allow the metallic portion to settle and concentrate, and when cooled, the metal and slag can be

separated, or more ore and lime added and treated as before until the gold in the ore is still further concentrated and fitted for more efficient treatment with lead as above stated. The lead then takes up the gold and subsides with it under a layer of ferric sulphide.

Where the ore appears to be chiefly iron pyrites ( $\text{FeS}_2$ ) and quartz, the crushed ore with lime, to flux the quartz, is fused in a crucible, when the pyrites loses half its sulphur ( $\text{FeS}$ ), fuses, and sinks below the slag, carrying with it all the gold. If this product be roasted so as to convert the iron into an oxide, and be then again fused with a fresh portion of the ore, the oxide of iron will then flux the quartz while the fresh portion of the sulphide of iron will carry down the whole of the gold contained in both quantities of ore, and this operation may be repeated, until the sulphide of iron is rich in gold, and it is then ready to be fused with a certain quantity of lead. This is called the Hungarian process.

The gold lead is now ready to be cupelled, a work which leaves only gold, if only gold without any silver is present. But if silver is also in the ore, then the mass, or "button," must be removed—flattened, or chipped, so as to be more easily acted upon—placed in a glass vessel and treated to pure nitric acid which will dissolve the silver (and copper if there be any), and leave behind a dark sediment which, if filtered off, washed and dried, may be shown to be metallic gold in fine powder. This is readily done by either mashing the powder upon a hard smooth surface by means of another hard surface as that of a piece of agate, or even the blade of a pen-knife; or the powder may be placed upon a charcoal



block with a little borax and the blowpipe flame turned upon it, when it will show its color as the particles unite in melting.

In the above we have to some degree entered upon the work of the metallurgy of gold, because the practical mineralogist very frequently needs to test his ore to the extent we have illustrated, and because with only the simple apparatus suggested he may satisfy himself sufficiently as to the value of the ore he has discovered or has received from others, without entering any further upon the more intricate work of the metallurgy of gold.

There are some precautions, however, which experience has taught as well as the science itself, in the treatment of gold. It is necessary that the nitric acid used should be colorless, or, in other words, chemically pure. For as gold is not soluble in pure nitric acid, but always in the presence of free chlorine, any admixture of the latter element in the nitric acid causes loss of gold. If, however, we desire to dissolve the gold we use one-fourth muriatic acid ( $\text{HCl}$ ) which containing chlorine ( $\text{Cl}$ ) combined with hydrogen, furnishes the element for the purposes in the nitro-muriatic combination, which therefore in its best condition is muriatic acid three parts, nitric acid one part, or one-fourth of the volume nitric acid.

If there is reason for suspicion that the nitric acid contains any chlorine, a drop of silver nitrate will by its milky-white precipitate show its condition.

But another caution must be heeded in dissolving an alloy of gold, silver, and copper, for instance: The gold in the

mass must not bear too large a proportion, for if it predominates, the action of the nitric acid is rendered inefficient, and hence generally silver is added so as to be about three times that of the gold, and this act of adding is called *quartation*. If, however, the gold is known to be very small no further trouble is taken. All silver coin contains gold, and old English silver plate contained so much gold that it paid well to extract the gold. With a fine pair of scales even the gold in a ten-cent coin may be detected and weighed.

Another precaution should be taken in using crucibles in melting gold and some other metals. The fine French crucibles should always be used in preference to even the small Hessian, of both of which we have spoken in the introductory remarks to this part of our work. But even the former occasion much trouble in melting small quantities of gold, because of the adherence of the gold to the sides of the crucible. This may be prevented by previously dipping the crucible into a strong solution of borax in water and drying the crucible before use.

In using nitric acid upon a mass of metal containing gold, if the mass contains much silver, the dissolving process should be begun without heat and the heat increased slowly, else there may be a sudden commotion which may cause either breakage, or loss, by overflow, since great heat is sometimes created by the rapid combination of metal and acid.

In making assays where the mass is to be dissolved in an acid, especially if there be a large quantity, it is well to pour the melted mass into a vessel containing water; it thus becomes granulated and is more readily acted upon by the acid.

## SILVER.

## SILVER. OCCURRENT FORM OR APPEARANCE IN NATURE.

NATIVE, massive and isometric, or monometric—that is, crystallized in octahedrons, cubes and forms modified or altered from these forms—sometimes compressed, or in small crystals joined together in linear or lateral directions, sometimes distorted. Coarse or fine thread-like, arborescent—in thin and irregularly formed plates, in very fine fissures—presenting, on edge, the appearance of minute lines in very flint-like or jasper-like rock.

HARDNESS=2.5 to 3, being harder than gold, but softer than copper.

GRAVITY=10.1 to 11.1. When pure, 10.5.

COLOR, that of ordinary silver coin, except where much tarnished by contact with sulphur in vapor or solution, or when mixed with some other metal, as gold or copper. With sulphur, dirty brown or black, with gold, very light to straw yellow, or pale brass yellow; with copper, slight tinge of copper red, but may contain some copper without any apparent change; when it does change color, it is more properly copper with silver.

DUCTILITY. Very malleable and ductile, may be hammered into leaves 0.00001 of an inch in thickness, and one grain of silver may be drawn out into a wire 400 feet long. It admits of being welded. (Bristow.)

COMPOSITION. Native silver occurs in a state nearer absolute purity than is the case with native gold, but, nevertheless, it

is, perhaps, never found absolutely pure. (See remarks under gold.) It is usually alloyed with gold and copper. At Kongsberg, Norway, a yellow alloy is found which contains silver, with more than one-fifth of its weight of gold. An amalgam of silver with mercury is found in large quantity in the silver mines of Coquimbo, Chili. (Bloxam.) More rarely it has been found with platinum, antimony, bismuth, and traces of arsenic. (Dana.) The splendid crystals of native silver found at Kongsberg, Norway, are supposed to owe their beauty, in some measure, to the presence of a small amount of mercury. (Sœmann.) It sometimes contains as much as 3 per cent. of antimony, arsenic, and iron, and is sometimes associated with grey copper ores. (Authorities in Crooks and Röhrig.)

#### LOCALITIES, GEOLOGY, and ASSOCIATIONS.

It occurs in masses and in veins traversing gneiss, schist, porphyry, and other rocks.

Kongsberg silver mine, Norway, 43 miles W. S. W. of Christiania, which was discovered in 1623, is the most important in the kingdom, and, though nearly abandoned in 1805, was again worked in 1816, and is flourishing since 1830. The region immediately around this mine is gneiss and mica-schist, and between the Cambrian on the west and lower Silurian on the east. (Dumont.)

From this mine several very large masses of silver have been taken; one weighing more than 5 cwt., and more recently (1868), two, one weighing 238 and the other 436 pounds. One specimen from Southern Peru, mines of Huantaya, weighed over 8 cwt. But all these are surpassed

by one "mass discovered in Sonora, which Wilson states weighed 2700 pounds and was the subject of a suit brought on behalf of the king, who thought to recover it on the plea that it was a curiosity, and belonged to the Crown." (Lamborn, Metallur. Silver, p. 52.)

In the United States, in Michigan, Lake Superior, in 1873, in masses of several pounds weight, perfectly free from all other metals; also with the copper of Lake Superior copper mines; also with silver sulphides on the northern shore at Silver Inlet, and at the latter place with galena most intimately mixed in one mass at the Chicago Exposition, 1873, and weighing, perhaps, forty pounds. Near Ontanagon in films in sandstone; Dana (mineralogy) says that it has been observed at a mine a mile south of Sing Sing Prison; at the Bridgewater copper mines, New Jersey; in interesting specimens at King's mine, Davidson Co., North Carolina; rarely in filaments with barytes at Cheshire, Conn. In Idaho, at the "Poor Man's lode," large masses of native silver have been obtained; rarely in the Comstock lode and mostly in filaments, and rarely in the Ophir mines; in California, sparingly in Silver Mountain district, Alpine Co.; in the Maris vein, in Los Angeles Co.

Native silver generally occurs in veins of calcareous spar, or quartz, traversing gneiss, slate, and others of the older rocks. (Bristow.) It may also be invisibly disseminated through native copper.

Many have been deceived by a mineral called arsenical iron or mispickel, which has a silvery appearance and is found in quartz and other mineral associations. Near Mid-

dletown, Conn., some money was wasted several years ago upon a place where it occurred and it has caused much deception elsewhere. This ore, mispickel, may be distinguished from native silver by its brittleness and the arsenical fumes it gives off under the blowpipe, when it turns black and is attractable by the magnet, showing its composition as iron. The scent of the fumes of arsenic is somewhat like that of onions.

The principal ores of silver do not resemble silver, but contain in varying quantities lead with other associations, but in smaller quantity than that of the lead. Almost all galena (lead sulphide) contains silver sometimes in very small quantities. Some of the lead ores in Southern Indiana, Rosa Clare mines, contain scarcely a trace of silver, and the same may be said of some near Lexington, Ky. Generally speaking, the lead ores which present a grain or rough appearance contain silver, while those which have shining surfaces contain less, but this is not always true. The separation of silver from galena will be spoken of under lead.

Copper ores contain, sometimes, much silver, and the separation of silver from copper is described under copper.

Several minerals rich in silver may be found, which, while they indicate silver, are not usually considered true ores in this country. Of these the following are worthy of mention, as indicating the neighborhood of true ores:—

ANTIMONIAL SILVER, or DYSCRACITE; foreign specimens contain about 75 to 80 per cent. silver, and 20 to 25 antimony. Hardness, 3.5 to 4. Gravity, 9.4 to 9.8. Color and streak silver white, sometimes tarnished. Opaque.

Before the blowpipe fuses on charcoal, coating the edges of the charcoal around the assay with antimonial white oxide and finally giving a globule of silver. The bead is soluble in nitric acid leaving oxide of antimony.

BISMUTH SILVER also occurs in foreign localities with 86 per cent. silver and 14 per cent. bismuth. It is soft, silver white, tarnishes easily, and easily shows silver under the blowpipe.

FREIESLEBENITE is the mineralogical name given to a light steel gray, or inclining to silver-white, mineral. H. 2. to 2.5, gravity 6 to 6.4, yields easily to the knife and rather brittle. Streak same as color. Composition, when pure, sulphur 18.6, Sb 25.9, lead 31.2, silver 24.3.

Before the blowpipe in an open tube it yields both sulphurous and antimonial fumes, the latter condensing upon the sides as a white sublimate. On charcoal fuses easily, giving, outside, white of the antimonious acid, and nearer, the yellow oxide of lead. After a time the silver globule appears.

STEPHANITE is an ore and found and worked in Nevada, Idaho, and elsewhere. Found massive and disseminated. H. 2. to 2.5; gravity, 6.3. Has a metallic lustre, but streak and color iron-black. S 16.2, Sb 15.3, silver 68.5 = 100. It rarely contains traces of Fe and Cu. It is soluble in dilute heated nitric acid with precipitation of sulphur.

Before the blowpipe acts as in the last-mentioned mineral except that after long blowing a red color appears upon the antimonial coloring, on the charcoal, from the oxidized silver.

ARGENTITE is a sulphide of silver. H. 2. to 2.5; grav., 7.2 to 7.3. Lustre metallic, streak and color blackish lead-gray, but streak shining. Opaque, readily cut with a knife.

Composition S 12.9, silver 87.1 = 100, but generally less silver. It occurs in Nevada and some other mines with stephanite and is an ore.

RUBY SILVER, or PYRARGYRITE, is an antimonious sulphur silver, sometimes found in large masses, one in Idaho, Poorman's lode, weighing several hundred weight. H. 2. to 2.5; grav., 5.7 to 5.9, lustre metallic, color from black to carmine red, streak red, translucent to opaque. Composition S 17.7, Sb 22.5, silver 59.8 = 100, specimen in possession of the author about 57 per cent. silver, from Mexico.

It appears then from the preceding that silver when not native is generally found associated with S, Sb, Pb, Bi, and it is the desire of the assayer at first to separate the silver as the most important element.

THE DRY WAY. Cupellation is the process used. This we have described in the introduction to this part of our work. But there is a preliminary assay with the ore, the object of which is to form an alloy of the silver contained in the ore with lead, which is to be added generally as litharge.

The process as described by Makins is the simplest and is as follows: As it is best to have no more lead for the subsequent cupel operation than is absolutely necessary, the fluxing with litharge is an operation requiring much care, since the ore itself is apt to vary very much in its effect upon the litharge, and so render different and opposite modes of treatment necessary. For example, most ores contain sulphur or other bodies which have a strong affinity for oxygen, hence such ores would very readily reduce the litharge. Therefore, in order to prevent this from taking place to too



great an extent, it is found necessary to add also an oxidizing flux, as nitre (potassium nitrate), to counteract in a sufficient degree the reducing power of the ore. Then, on the other hand, the ore may naturally be of an oxidizing character, in which case not only will no oxidizing flux be required, but, on the contrary, a reducing one, such as argol (coarse bitartrate of potass), must be used; while, lastly, the ore may chance to possess just the reducing power requisite to act sufficiently upon the litharge and no more, in which case the litharge alone is employed.

From all this it will be seen that the first step required in the assay of a silver ore is one whereby we may learn its nature in the above-mentioned respects. For this purpose Mitchell advises a preliminary assay upon about twenty grains of ore, which is to be powdered and mixed intimately with five hundred of litharge. This mixture is put into a small crucible, capable of containing about double the bulk, the crucible is heated very gently at first, but after a time the heat is to be quickly raised to a full red so as to complete the operation as speedily as possible. When cool the pot is broken, and the button removed and weighed. It may be that but little lead has been reduced, perhaps not more than half the weight of the ore used. In such a case an actual assay would be made of the following mixture: 200 grains of ore, 200 of sodic carbonate, 1000 of litharge, and 15 grains of argol, for the purpose of assisting the reduction of the lead. Secondly, if the trial button should weigh about double the weight of ore employed then the same mixture should be used, except as regards the argol,

which must be omitted and about fifty grains of nitre be used in its place. Thirdly, if the trial button weighed about the same as the ore then litharge alone would be employed without either reducing or oxidizing flux.

The mixture being intimately made as above is to be put into a proper sized crucible, and it may be here observed that in all cases where nitre is employed, either in assaying or melting operations, a very capacious crucible should be taken, as considerable action is always set up. The mixture is next covered with a layer of salt (sodium chloride) and lastly with 200 grains of powdered borax. The crucible is put into the furnace and the gentle heat at first used raised until the fluxes are thoroughly liquid, at which point the assay will be found completed. The pot is then removed and when cool broken, the button hammered so as to separate all the flux, and reserved for subsequent cupellation.

There is another operation which is applicable in all cases, especially where the assay is one of shop sweepings containing solder and even zinc and tin, and hence applicable to almost any ore of similar composition. It has the name of scorification and precedes the work of cupellation. It consists in heating the specimen under examination with a quantity of granulated lead in a shallow clay vessel or "scorifier," the name given it in the chemical warehouse. The operation, as given by Makins, is as follows: The scorifier is so placed in a muffle as that a current of atmospheric air may pass over the surface of the vessel and oxidize portions of the lead. This oxide of lead then forms a menstruum for the suspension of foreign matters and combines

with silica as a fusible slag, while the portion kept unoxidized will retain the gold and silver sought for in the sample.

The operation is carried on as follows: A quantity of about fifty grains of the sample is weighed and powdered; this will be about the quantity workable in one scorifier, but it is advisable to work this as in all assays double, hence two scorifiers are prepared. A quantity of granulated lead is next taken and the amount required may range from twelve to thirty times the weight of the ore or of the sweepings. The quantity required will be large if much tin or zinc be present, or if (as in the case of an ore) it contain a large proportion of lime salts. Half this amount of lead is first put into each scorifier and upon it the 50 grains of the specimen previously mixed with 50 of borax. The whole is then mixed and covered with the remaining half of lead. The scorifiers are then placed in a heated muffle and the opening closed up for a quarter of an hour so as to fuse the lead. The heat is then allowed to fall, the door of the muffle opened as in carrying on a cupellation, and the roasting of the mass commenced. A slag will form first at edges of the bath and increase over the surface, but as the lead oxidizes it becomes quite fluid; the whole should be now occasionally stirred so as to keep all parts mixed. The heat is then raised, whereby the whole is rendered fully liquid. This last fact may be judged of by the facility with which it runs off an iron stirrer which is crooked at the end so as conveniently to be dipped into the bath. Thus under the influence of the borax the metallic particles are so cleansed as to run well together, the borax assisting also in

the formation of a liquid slag from the first. The assay being in this limpid state at the end of the operation (which will be completed at the end of half an hour to three-quarters) the scorifier is removed and its contents poured quickly into a hemispherical iron ingot-mould. Thus a button is obtained, consisting of a greenish slag at the top, covering a button of metal; these are to be separated by a blow of the hammer and the metal reserved for cupellation and "parting" for gold.

If the operation has been well performed, this button will be tolerably malleable, and the slag quite free from any beads of metal. If these features be not present the assay is not trustworthy. The working may be divided into three stages, namely, of about a quarter of an hour for the first fusion; next twenty minutes for the roasting and oxidization; and lastly, ten minutes for the final fusion of the whole.

The next process is that of cupellation. This depends upon the property which characterizes the noble metals, namely, that when heated to fusion, and exposed to a current of air, not the least oxidation takes place, while such treatment of base metals constituting alloys, under certain conditions, perfectly oxidizes them. So that by this means alone we are able to get rid of the alloy associated with a precious metal, platinum excepted. (*See under Lead.*)

The buttons are now ready for cupellation, which process we have described. In addition to what we have already said, we may say that charcoal, coke, or anthracite may be used, charcoal for a small furnace, coke and anthracite for a

larger one. The objectionable feature in some otherwise very well arranged cupel furnaces is that the furnace is too thin in front and the heat becomes disagreeably great. If the front is built with two bricks and the sides with one brick thickness, the furnace heat is more endurable. Care must be taken to have a draft sufficiently strong and a damper in the pipe, if a stove is used, or a sliding cut-off in the chimney if the furnace connects with the chimney directly. The muffle should have a well fitting piece of brick (fire brick) stopper to correct or stop entirely the draft passing from the front of the muffle over the assay when, as in this case stated above, it is better to stop for a season all draft through the muffle. (*See the drawing already given.*)

*Caution.* It has been found that when the silver is worked with less than three times its weight of lead the result is not trustworthy, and Makins says that the English standard requires six times its weight. Hence we should exceed the three times rather than attempt to equal it.

The fusible lead oxide readily gives up a part of its oxygen to any copper oxide which is also formed, and this cupric oxide is dissolved in the fluid litharge and passes with it into the porous cupel in which the assay is made. Tin or antimony or any volatile metal, or substance, has been probably entirely driven off in the scorification and finally almost entirely disappears. Unfortunately the dry processes are usually attended with some loss of silver, sometimes very minute and, perhaps for some purposes, unimportant, but nevertheless for very accurate results we must resort to the—

WET PROCESS, or humid assay of silver. A process of separating silver from copper is that of Haidlen and Fresenius, namely: Add cyanide of potassium to the solution of the two metals until the precipitate redissolves. A current of sulphuretted hydrogen is then passed into the liquor, the excess of gas expelled by heat and a little more cyanide added. The silver is thus precipitated while the copper remains in solution.

Another method where gold is in association is as follows: Dissolve the argentiferous copper in sulphuric acid and precipitate the silver from the solution by introducing clean slips of copper; the precipitated silver, which is in the form of a gray metallic powder, is washed and fused in a clay crucible with a mixture of nitrate of potassium and borax; it is thus purified from the copper which may have been precipitated with it. The copper may for the arts be recovered by crystallization as cupric sulphate (blue vitriol), and the gold having remained in the solution, undissolved in the sulphuric acid, can be filtered therefrom, before crystallizing the copper sulphate. This method is used where the silver and gold only are required very nearly accurately and the copper "by difference" by subtracting the weights of the gold and silver from the weighed argentiferous copper used at the beginning. But this process is not as accurate as may be required. In that case the specimen may be dissolved in nitric acid and the silver chloride precipitated by hydrochloric acid, as we have elsewhere shown, filtered, washed, and weighed after the chloride has been reduced by

hydrogen (see under Reagents "silver nitrate), and the copper determined by difference.

*Caution.*—Rose has shown that some traces of silver are dissolved in chlorides of potassium, sodium, and ammonium, and therefore it is not well to precipitate silver by these salts, but when it has been so precipitated it is recommended (by Gay Lussac and Liebig) to evaporate the solution, filtered from the chloride of silver, nearly to dryness, and to treat the residue with nitric acid; on exposing the whole to heat, the alkaline chlorides are converted into nitrates, while the small quantity of silver chloride remains unaltered, and does not dissolve when the mixture is diluted. Silver is separated from all the metals of the first four groups (see at the beginning of this part) by sulphuretted hydrogen from acid solutions. From lead it may be separated by hydrochloric acid, the solution having been previously diluted largely to prevent the precipitation of chloride of lead, or by heating the solution containing both metals with cyanide of potassium which precipitates the lead in the state of carbonate, retaining the silver in solution, as argento-cyanide of potassium. The silver is subsequently precipitated in the form of cyanide of silver by the addition of nitric acid.

To separate SILVER from LEAD the precipitation is advantageously preceded by addition of sodium acetate. The fluid must be hot and the hydrochloric acid rather dilute and no more added of the latter than is just necessary. In this manner the separation may be readily effected, since lead chloride dissolves in sodium acetate. The silver chloride is washed with hot water. The lead is thrown down from the

filtrate by hydrogen sulphide. Great care must be taken in washing the silver chloride from all sodium acetate.

SILVER is separated from cadmium and bismuth compounds, thus: Add to the nitric acid solution containing excess of nitric acid hydrochloric acid as long as a precipitate forms, and separate the precipitated silver chloride from the solution which contains the other metals by introducing a strip of zinc, or iron, and add some dilute sulphuric acid. Wash the spongy silver first with dilute sulphuric acid, then with water, and finally dissolve it in nitric acid. It may now be precipitated with hydrochloric acid and be determined (weighed) as chloride, or by reducing with zinc to silver, washed and dried, be weighed as silver, as we have already shown. (*See under "Reagents" for silver chloride reduced to silver by zinc.*)

SILVER from MERCURY requires that the nitric acid solution, or rather the silver nitrate in solution should have an addition of acetate of sodium. But to be sure of complete separation of the silver, mix the nitric acid solution (free from any mercurous salt and acidified with nitric acid) with sufficient water, and with hydrochloric acid so long as any precipitate falls. Filter and heat the precipitate with a little nitric acid, add a little water, then a few drops of hydrochloric acid and filter off the silver chloride. This is done lest any mercuric salt was precipitated with the silver. In the filtrate the mercuric solution remains which must be determined as sulphide by diluting sufficiently, acidulating with hydrochloric acid and precipitating with clear saturated hydrogen sulphide water, or (in the case of large quantities) by passing through



it the gas. Filter quickly after allowing a partial deposit, wash with cold water, dry at the heat of boiling water, and weigh. The proportions are as follows:—

Hg	200	86.21 per cent.
S	32	13.79 “ “
	<hr/>	<hr/>
	232	100.00 “ “

SILVER from SULPHURETS. In assaying the sulphurets, the finely pulverized ore must be acted upon by strong nitric acid as in the case of lead sulphuret. (See under Copper Sulphides for another process.)

---

## COPPER.

The useful copper minerals may be divided into three classes, the native copper ores, the compound copper ores, and ores not strictly copper ores but ores from which in obtaining other metals, copper, as matter of economy, is extracted.

NATIVE COPPER, as a true ore, occurs in the United States most extensively in the Lake Superior copper region near Keweenaw Point. One mass weighing 420 tons was discovered in 1857 in the Minnesota mine in the belt of conglomerate, which forms the foot-wall of the vein. (Dana.) But it has been found in New Jersey, Connecticut, California, and Arizona; compound and native in Montana, New Mexico, Colorado, Utah, Wyoming, Nevada, Idaho, Missouri, and elsewhere.

It is almost always associated with silver, sometimes with bismuth and other metals.

HARDNESS, 2.5 to 3; gravity, 8.8 to 8.9, in the best native ore.

BEFORE THE BLOWPIPE it fuses easily; on cooling becomes covered with a coat of black oxide. Dissolves readily in nitric acid giving off red fumes. Easily distinguished by its color.

ITS GEOLOGICAL POSITION varies. In Eastern United States it is found in the red sandstone, in Lake Superior region in the Silurian trap rocks, in Texas in the granite, in quartz rocks, as reported; its locality is generally among the earlier formations.

The usual compound ores of copper are chiefly COPPER PYRITES, from which the larger part of the copper in Great Britain is obtained. Its composition is  $\text{Cu}_2\text{S}$ ,  $\text{Fe}_2\text{S}_3$ , and contains, when pure, 34.4 per cent. copper, but, due to impurities, it may not hold more than ten or twelve per cent. COLOR, brassy; gravity, 4.2. LOCALITY, in the primitive rock, and especially in clay slate.

Another sulphide is worked, called purple ore, or variegated ore, whose composition varies but is generally  $\text{Cu}_2\text{S}$ ,  $\text{FeS}_2$  with 56 per cent. of copper.

There is another ore also a sulphide, called indigo copper. This contains 66 per cent. copper, but although specimens are found in some places it does not occur extensively as an ore.

Other ores with less copper may be worked and may be valuable.

**BLOWPIPE AND OTHER DETECTION OF COPPER.** Heated in the blowpipe oxidizing flame it will generally produce a greenish tinge to the flame. With borax a green bead is formed which becomes blue when cold. In the reducing flame the bead will be reddish when cold. If heated upon charcoal with soda carbonate in the reducing flame we get a bead of metallic copper, if not too much mixed with impurities.

Copper may be detected in exceedingly weak solutions by placing a drop of the suspected solution upon a strip of clean platinum foil. If now a point of zinc be placed in the solution, but touching the foil, a spot of reduced copper will be seen, if present, at the point of contact.

The blue reaction which copper ores, when roasted, or calcined, in a little crucible, or in fragments, under the blowpipe, with carbonate of soda, give with ammonia, always indicates the presence of copper, and after the discovery that the ore contains copper we proceed to ascertain the quantity.

**BY DRY METHOD.** This method never will yield all the copper accurately, but it is so nearly the kind of copper produced by the smelting works before it is entirely refined, that it is preferred as an assay by some, and is as follows: Take about two or three hundred grains, but if lean, as an ore, take more. The weighed quantity is mixed with about twice its weight of a flux composed of equal weights of lime, borax, powdered glass, and fluorspar. The mixture is put into a crucible and heated to fusion, tapped down so as to cause all particles to conglomerate in the bottom of the cru-

cible. The whole is then poured into any iron mould, and as soon as set the whole is plunged into water, thus cracking off the glassy slag. The brittle "regulus" is then powdered, roasted without allowing it to fuse, but stirring to get rid of all volatile matter as far as possible. When well roasted the residue is put into a crucible and mixed with a flux composed of argol, nitre (saltpetre), and borax; the crucible is now heated till the copper subsides beneath the slag. The button may be a little coarse but it can be refined to some degree by throwing it into a red hot crucible and heating with some flux of lime and powdered common porcelain, or powdered china, in the proportion of two-thirds weight of the former and one third of the latter, in a sufficient quantity to cover the button a half inch deep. Heat to melting for ten to twenty minutes, cool and remove and weigh.

**THE WET METHOD.** If the solution contains only copper or no other metal whose oxide is thrown down by potassa, we have only to add an excess of caustic potassa, or soda, and well boil the precipitate (oxide of copper), wash, dry, and weigh. The precipitate (which is cupric oxide) contains 79.85 per cent. metallic copper.

**CAUTION.** The solution should be dilute and the precipitate well washed with boiling water, or some potassa will adhere. If any organic matter is in the solution it will deteriorate results, or if any organic acids are used or have been in the solution, another process must be adopted, or organic matter, if any was in the ore, must be burned out by roasting or by continued red heat. The cupric oxide thus formed is a brownish black, or black precipitate.

If silver be present with the copper, it is precipitated from a nitro-hydrochloric acid solution by sodium chloride as we have described under SILVER, and the copper in the blue solution of copper precipitated as oxide, as above stated.

THE COPPER SULPHIDES, as in many other metallic sulphides, may be decomposed and sulphur separated thus: The sulphur is determined as sulphuric acid ( $H_2 O S O_4$ ); pulverize the metallic sulphide, weigh and place it in a test tube. Have a flask with sufficient fuming nitric acid in it to dissolve all the pulverized sulphide; slip the test tube into the flask and immediately cover the end with a loose glass stopper during the commotion of the dissolving powder, wait till quiet, and then agitate the assay till all is dissolved and the fuming gas is absorbed; wash off the glass stopper with a few drops of nitric acid into the flask, heat gently; the whole of the sulphur is now in the solution but it is either oxidized, or in sulphur particles. The solution should be perfectly clear, which it will be if no metals were in the assay which form insoluble salts in sulphuric acid, such as lead, barium, etc. If there were such metals a precipitate will occur and another course must be pursued, which we shall describe. Put the solution into a dish and evaporate about one-fifth with some sodium chloride, adding (toward the close of evaporation) some hydrochloric acid, cooling the dish each time before adding more acid. Evaporate three or four times to get rid of nitric acid, adding the hydrochloric acid each time. Determine the sulphuric acid as we have shown by use of barium chloride.

*Caution.*—The chloride of barium is soluble in some acids and the liquor should, if possible, be free from all nitric acid or chlorine and have as little free hydrochloric acid as possible. [The liquor may be tested for nitric acid and chlorine, detecting the one-ten-thousandth part, by adding a drop or two of the solution to 20 or 30 drops of pure sulphuric acid in a test tube and stirring the mixture with a glass rod moistened at the end with a little brucine. (Berthèmot.) If any nitric acid is present the liquor becomes red and afterwards yellow. Or, if either nitric acid or chlorine be present in the solution, a few drops may be removed to a test-tube and a little solution of indigo in sulphuric acid may be added, enough to give it a blue color, and it be heated. If any nitrates or chlorine be present the color will be changed to yellow in consequence of the oxidation of the indigo at the expense of the nitric acid or the chlorine.] The nitric acid may be entirely eliminated by repeated evaporation with pure hydrochloric acid. The solution must be diluted considerably if the precipitate be dense at first, and it must be heated to near boiling before the barium chloride is added and the solution allowed to stand at a gentle heat for several hours. Care in these last movements will give great accuracy.

If any sulphur is floating in the fluid add potassium chlorate, or strong hydrochloric acid and digest some time, placing the dish upon a sand-bath or water-bath. If all does not dissolve, examine, and if the sulphur is all that remains, and that yellow, filter off and wash and weigh as sulphur. Other substances may be lead sulphate, or other sulphates, which must be separated washed and examined, and the

other process to which we have referred in a former paragraph be used when lead, barium, tin, calcium, antimony, or strontium are present. This process is that of oxidizing the sulphur with chlorine. The ore in this case should be pulverized exceedingly fine, to 80 to the inch when largest, and heated several hours with solution of pure potassa. Then conduct chlorine into the solution which speedily oxidizes the sulphur to sulphuric acid, the potassa becomes potassium sulphate, and the oxides remain undissolved. Filter and wash the precipitates and reduce the sulphuric acid in the solution by barium chloride as we have described (noting the cautions suggested), but not until after the alkaline solution is acidified very slightly with hydrochloric acid. Arsenic and antimony remain dissolved as acids, but the lead is converted into insoluble binoxide and is filtered out as above directed. If iron be present there will appear a red tint, and as soon as that is noticed, discontinue the passing of the chlorine and heat the liquid a few minutes with powdered white quartz which decomposes the ferric acid. If the ore has been exceedingly finely pulverized much trouble will be avoided from the rapid disengagement of oxygen which retards the oxidating by the chlorine.

Where the assayer desires chiefly to know the amount of pure copper in the assay, or only this, then he may treat the copper button extracted from the ore in the crucible process (dry way), and this he may determine by the copper oxide precipitation method which we have already described.

## NICKEL.

Nickel is a white metal, hard, and susceptible of high polish, but it is not employed unalloyed. DUCTILE and very TENACIOUS. Malleable when pure, but this property is much diminished when carbon is present. It is capable of welding and is feebly magnetic. Spec. grav. 8.82 when hammered. Slowly soluble in sulphuric or in hydrochloric acid, but freely so in nitric acid or nitro-hydrochloric acid. It is oxidized if heated strongly in the air. The ores are arsenide of nickel, *niccolite*, hardness 5 to 5.5; grav. 6.7 to 7.3, metallic lustre; pale copper-red, with a tarnish and called, from its color, copper-nickel; brittle and contains from about 39 to 48 per cent. nickel, and from about 46 to 54 arsenic, with traces of iron, lead, cobalt, antimony, and sulphur.

Before the blowpipe, in open tube, the traces of sulphurous acid may be detected, but the arsenous acid is very plainly detected [by small and white coating], the assay becoming yellowish green. On charcoal gives arsenical fumes and fuses to a globule. The last residue, if treated in borax bead, gives, if slowly increased in heat, reactions for iron, cobalt and nickel. (Dana.)

Nickel glance is an arseniosulphide of nickel ( $\text{NiAs}_2, \text{NiS}_2$ ). Mineralogical name *Gersdorffite*, normally its composition is arsenic 45.5, sulphur 19.4, nickel 35.1 = 100, but in nature it varies from 33 to 49 per cent. arsenic, 22 to 40 per cent. nickel, and 9 to 21 per cent. sulphur, with some iron and



cobalt. Hardness 5.5 and grav. 5.6 to 6 or 7. Form and cleavage: the latter cubic, the former with variations, like iron pyrites. Color: silver white to steel gray and sometimes tarnished.

The speiss, so-called, is the residue from making cobalt and contains iron, nickel, and copper combined with arsenic and sulphur, which residue remains in the bottom of the crucible. From this residue much of the nickel of commerce in Europe is made. The Cornish ores seldom yield more than 7 per cent. of nickel.

There are two oxides of nickel analogous to those of iron, viz: a protoxide and a sesquioxide, the first is precipitated from a nickel salt, by an alkali, as a pale bulky apple green hydrate, and this is the usual color of nickel salts. This oxide is soluble in acids forming salts of nickel. Ammonia, or ammoniac chloride, dissolves this oxide, forming darker blue solutions ( $\text{NiO}$ ), atomic weight 75. The anhydrate (oxide) is best prepared by igniting the carbonate in a covered crucible; it is of a brownish-green color.

The second, or sesquioxide, may be formed by heating the carbonate as in the last case, but gently and with exposure to air; in this way a black powder is obtained. This is insoluble in acids, but on heating it in nitric or sulphuric acid salts of protoxide are obtained,  $\text{Ni}_2\text{O}_3$ , atomic weight 166.

A chloride may be obtained,  $\text{NiCl}_2$ , by dissolving the protoxide in hydrochloric acid and evaporating the solution to dryness and the residue may be sublimed in yellow crystals.

There are three sulphides, a subsulphide, a protosulphide,

and a disulphide. The protosulphide is not precipitated from nickel solution by hydrogen sulphide (dihydric), but by ammonium sulphide. It then falls as a black powder in a hydrated state. It may be formed as anhydrated sulphide by heating nickel and sulphur together, the action is very violent and the combination takes place at a lower point than that of the fusing point of sulphur.

The alloys of nickel are chiefly those with copper and zinc (German silver), and are 51 copper, 30.5 zinc, 18.5 nickel. A little cobalt increases the ductility of nickel, but arsenic will render it and its alloys brittle and dispose them to atmospheric oxidization. Iron and lead also tend to render nickel and its alloys brittle.

Nickel is always estimated as protoxide, and if it is precipitated by potassa great care must be taken in washing out the potassa before drying and weighing.

The separation of constituents in a nickel ore which contains arsenic, copper, antimony, lead, bismuth, iron, cobalt, barium, or calcium with the nickel is as follows: After roasting the ore, as speiss or diarsenide (kupfer-nickel), powder and dissolve in hydrochloric acid (concentrated). Then add to the solution excess of hydrosodic sulphite (hydrosulphite of soda) and boil till the arsenic acid is reduced to arsenous acid and the excess of sulphurous acid is driven off. Next pass into the warm solution hydrogen sulphide. Thus arsenic, copper, antimony, lead, and bismuth are separated and after standing some time filtered out. Evaporate the filtrate to dryness and the residue must be dissolved in water. Chlorine is passed in. Add baric or calcic carbon-

ate which precipitates iron and cobalt. Sulphuric acid is now added sufficient to remove any dissolved barium or calcium. After filtering, sodic carbonate is added which precipitates nickel carbonate and this is reduced by heating to redness after the usual washing and drying. (Cloez.)

If the object is to get pure nickel Deville's method is to dissolve commercial nickel in hydrochloric acid, boil the solution to dryness, digest the residue in water; thus the ferric oxide is left. Dihydric sulphide (sulphuretted hydrogen) is then passed in to separate the copper present, the solution being diluted for the purpose. It is then evaporated and when sufficiently concentrated oxalic acid is added, thus nickel oxalate is precipitated; this is heated intensely in a lime crucible (made by excavating a cavity in a lump of hard common lime) with a well luted cover, so as to exclude the air, thus the carbonate oxide, formed by the decomposition of the oxalic acid, reduces the metal itself.

In the United States the ores of copper-nickel found at Gap Mine, Lancaster County, Penn., are the chief and the only ones, of any consequence, produced, but silicated ores are found on the Pacific slope in Oregon, Douglas County, and the arsenides exist in Nevada in Churchill County. More recently (1883) it has been found in the Sierra Nevada mountain region near Mono Lake and also in Southern California from the vicinity of Corisa Creek and at White River, Kern County. (Williams.)

The price of nickel has so decreased in the last ten years (from \$2.60 per pound to \$0.75 in 1884) that many of the

discovered localities have not been considered as worth the capital necessary for remunerative working.

In examining for ores of nickel it is almost invariably true that some of the masses, pieces, or specimens will show to the naked eye or under the magnifying lens the characteristic apple-green specks or streaks of some of the salts of nickel.

It is very probable that vessels lined or plated with nickel will be used more extensively for culinary purposes, since the effects of this metal upon the human system appear from experiments by F. Geerkens less injurious than copper or brass, and M. Mermet recommends the chemist to use crucibles of nickel in place of silver as less likely to melt and far less expensive and not more readily acted upon by potash than silver.

The total consumption in the United States in 1885 was about 400,000 pounds according to Williams. The coinage alone in 1884 was 399,141 troy ounces, which was less than in 1883, when it was 703,426 ounces. A large stock had accumulated which was supplied to the market in 1883 and 1884, and hence the total actual consumption cannot be told by adding the production of works to the importations.

For the separation of nickel and cobalt see process given at close of article on cobalt.

## IRON.

Iron does not occur native, except as meteoric.

When pure its spec. grav. is 7.844.

Its malleability, gold being 1, is 6, and its ductility 4. Its tenacity is 1, lead being 11, and gold 6. Its heat conducting power is 6, silver being 1, its electrical conducting power being in the same order.

Iron is universally present in nature, but the true ores of iron are generally oxides and carbonates, the sulphides, though found in some places in large amounts, are not used as ores of iron, but for the manufacture of sulphuric acid and for other purposes.

In Great Britain the chief ores are the carbonates, they are found in beds in the coal-formation and alternating with layers of coal, and hence the ore and fuel are found in the same place. Even the limestone used as a flux in the furnace is also associated with the iron ore, and it is not infrequently the fact that the entire supply of material used in the furnace is had on the same tract with the furnace.

THE CHIEF ORES OF IRON, named in order of their richness in pure iron, are:—

1. THE MAGNETIC ORES. The mineralogical name is MAGNETITE. Pure magnetic ore is black; streak black; brittle; fracture conchoidal; when in crystals they are octahedral, or of derived forms, even to dodecahedral, but they are determined by their magnetic quality. All these ores are magnetic in that they effect the needle but have no magnetism

necessarily in themselves. When they have, that is when they will attract a tack, or other piece of iron, then they are called polaric. Some fine and strong polaric ores are found among the Shepard Mountain ores of Missouri, but the finest occur in Siberia.

The hardness is 5.5 to 6.5 and gravity 4.9 to 5.2. The theoretically pure specimens cannot contain more than 72.4 parts of iron, but this degree of purity is rare and never excelled in the mines. Yet we frequently hear people speak of an ore of 75 to 80 or even 90 per cent. iron. In the Washington mine, not far from Marquette, Lake Superior, the writer has found semi-crystalline masses which assayed nearly 72 per cent. and were richer than any found by him in the Port Henry, Lake Champlain region; the ore from the latter region carries with it more silica in grains.

But these, while they are the richest ores, are by no means the only valuable magnetic ores. Rich magnetic ores are found in some places harder to work than some of the poorer magnetic ores. The associations are sometimes quartz, alumina, and sometimes lime (azoic lime), as in the Champlain region, but more injurious associations are found in the sulphur and copper united with the ores as in the Cornwall mines of Lebanon Co., Penn. It is sometimes also associated with small amounts of arsenic and phosphorus. The sulphur has the tendency to make the iron break when red hot, and the phosphorus when cold. The former ores as well as the iron are called "red-short," and the latter "cold-short." Small quantities of sulphur in an ore may, by furnace treatment, be rendered almost harmless, and ores containing phos-

phorus may be partially neutralized by the use of ores containing sulphur to a certain amount. Hence large quantities of ores are constantly successfully used, which have small traces of either sulphur or phosphorus, but care must be exercised in the introduction of an ore, as to the amount of either phosphorus or sulphur contained, since even 0.5 per cent. of the former affects the tenacity of the iron.

Very frequently loose fragments of magnetic iron ore are found around upon the surface of a country where it cannot be determined that any true vein exists, the ore having been transported by natural agencies.

The geologic position of magnetite is in the lowest rocks, granite, metamorphic, and azoic series. All the remaining ores appear to have been derived from magnetite. Magnetic ore has for its chemical composition iron and oxygen, in that condition called a sesquioxide and protoxide, or  $\text{Fe}_2\text{O}_3 + \text{FeO} = \text{Fe}_3\text{O}_4$ . By exposure to air it changes, and the iron takes all the oxygen for which it has affinity and becomes entirely  $\text{Fe}_2\text{O}_3$  without the protoxide  $\text{FeO}$ . In that mineralogical form it is called—

2. HEMATITE OR RED HEMATITE, its streak being a bright red; when pure its hardness is 5.5 to 6.5, and gravity 4.5—5.3. Sometimes the crystals, or crystalline forms appear black and extremely polished, and hence it is sometimes called *specular* ore, but when very thin it can be seen by transmitted light as red and translucent.

This is the larger source of the iron of the United States, and its variations in appearance, hardness, and consistency, are numerous. In some specimens (Jefferson Co., N. Y.,

commercial) it presents the appearance of broken steel having a close, hard, and tough texture, leaving fine micaceous particles. But the streak is always red. At other places it appears in masses, somewhat unctuous to the touch, and soft as in Missouri, always red or reddish brown, containing as high as 60 per cent. or more of iron. There is another form which the author has traced from Central New York through Pennsylvania, and which occurs at intervals somewhat changed down to Georgia, and which contains small grains of double convex to perfectly round forms like large shot, called fish-egg ore, lenticular ore, etc., but it is a true red hematite, and in some sections it seems to contain traces of phosphorus.

Fragments of this ore frequently indicate large deposits not far off.

The per cent. of iron in a pure specimen of red hematite is never over 70 per cent.

It is asserted in some mineralogical works that this ore is "sometimes attractable by the magnet, and occasionally even magnetipolar," but the writer has examined several specimens asserted to be "attractable," etc., and in every case the specimen contained traces of magnetite where the red hematite had not entirely been changed into sesquioxide. Such specimens we have found on Staten Island in the hematite mine there worked. We believe that the red hematite if entirely homogeneous is never attractable by the magnet.

3. BROWN HEMATITE is the next ore in importance, and differs from the red, only that it contains, in chemical combination, a portion of water varying somewhat, but generally about



14 per cent. of its weight, when the ore is fairly dry. Streak, brown. Mineralogical name, "Limonite." Brown hematite, when in mass and pure, has a spec. grav. of 3.6 to 4, and hardness of 5 to 5.5. Its composition in its purest state is as stated above, sesquioxide of iron 85.6, water 14.4, = 100. It, therefore, in its purest state contains 59.89 per cent. of iron but never more. The usual brown hematites seldom yield more than 30 to 35 per cent. iron, and are considered very rich at 40 to 45 per cent. They are easily worked and some of the best charcoal irons are made from this ore.

Its geologic position, as a rule, is not in the older rocks, but in the secondary, and it seems to have been derived from the red hematite by water agencies. In many parts of the United States the author has found that the largest and best brown hematite beds are upon basins, at the present time, and that in very many instances they may be located by examining the country where such ore does exist and excavating upon the lower levels, or where ancient water-sheds inclined away from magnetic ranges.

The impurities of these ores are generally alumina, silica, lime, magnesia, phosphates, sulphides, and manganese.

There are in some mines (on the Lehigh, opposite Easton) some peculiarities of appearance in the limonite. Some specimens are round and hollow, and when broken present a black concave surface of exceeding hardness and splendid polish, but the streak is always brown and the texture fibrous below the polished surface, and the small amount of silicious loose material found in every polished geode seems

to suggest the cause of that polish, namely, the constant motion of the geode through ages in the moving waters of some shallow lake. Some of these specimens show the presence of manganese in small quantities, and it is supposed that the peculiar features of this ore are due to the presence of that metal.

Limonite (so called from the Greek for a meadow) is found as bog ore in wet lands in nodules, frequently in concentric layers, and called in some parts of Southeastern Ohio "kidney ore." Sometimes it is found in long sedimentary strata as in the mines along the Lehigh, Penn., and not far off in stalactite and rounded masses in the mines near Allentown. Also with incrustations of minute quartz crystals as at five or six miles east of Phillipsburg, N. J. The mine at this place is not worked, the ore being too silicious.

4. Another ore called SPATHIC ORE is found in smaller quantities in the United States. It is an iron carbonate,  $\text{FeCO}_3$ . When pure it contains 48.27 per cent. iron, is of a light brown or gray color, translucent. Hardness, 3.5 to 4.5; grav., 3.7 to 3.9. Streak, white. Mineralogical name, *Siderite*. But it has not yet been found in so large quantities as to constitute an ore. In Connecticut at Roxbury it occurs in veins in quartz in gneiss.

In another form, as argillaceous carbonate, of a dark or bluish-gray color (a clay iron-stone), it is found in large quantities in Pennsylvania, seen best in Johnstown and Northeastern Ohio; considerably altered and associated with coal, it formed some small source of production near Mauch Chunk, Penn. A darker variety was mined in some small

quantities containing carbonaceous material and called black band iron ore, but it was not worked with much success as to quantity. Some of the latter kind of ore occurs in Ohio and may yet be found elsewhere. Black band is used very extensively in Scotland.

These ores are the chief sources of iron in the United States, and it is to them that the practical mineralogist will turn his attention.

It is seldom necessary to bring any of these ores before the blowpipe, except it be the argillaceous, some of which so little resemble iron ore as usually seen that there may be sufficient reason for doubt as to their composition. On charcoal any iron ore with even a small per cent. of iron may with the I. F. be reduced to metallic iron and by means of the magnet be shown to be iron. This is especially important where iron sulphide (pyrite) or arsenical iron (mispickel) is to be tested. The former is frequently taken for gold and the latter for silver; the blowpipe, I. F., detects the mistake by reduction to metallic iron attractable by the magnet.

**DRY ASSAY OF IRON.** In order to approximate the richness of any ore of iron all the ores may be treated by the following method called dry assay:—

Brasque a Hessian crucible (as described on page 77) of medium size and introduce a weighed portion of a powdered ore. Cover it with charcoal to very near the top, introduce the crucible into a fire after the crucible has been gradually heated previously to thoroughly drying it, and then heat to nearly a white heat for about half an hour; withdraw the

crucible, let it cool, and empty the charcoal upon a piece of paper. At the bottom will be found a button of iron with the slag attached to one side, the latter easily separates and then the button can be weighed and the proportion of ore to metal be approximately determined.

*Cautions.*—It is a mistake to pulverize the ore too finely, it causes scattering of the reduced iron; the size of the powder should be about that of small pin-heads; judgment must be formed upon the richness of the ore, lean ores should be coarser. Cover the crucible with a piece of an old crucible or fitted piece of tile resting on the charcoal. Be sure that the heat at the close of the operation is near white heat for at least ten minutes to melt the button together. There is no use in breaking a brasqued crucible, it is safer to use again a crucible which has been used successfully. In using a tiled cap for your crucible or piece of brick it is always better to rub wet charcoal upon its edges or use plumbago to prevent its adherence to the crucible. In testing an ore it is always better to try several assays and note the variation and take the average. But the larger the button the more accurate the assay, because several extraneous additions to the metal make the result doubtful; first there is a certain weight due to carbon which must be subtracted and this amount may vary from about four per cent. to less than one; some buttons may contain slightly over four per cent., but we have frequently, by keeping the heat for less than an hour only to a medium red, reduced the ore to a nearly malleable wrought iron with practically little carbon, and it can be heated so that the iron shall con-

tain no carbon. In a brasqued crucible of the largest size of ordinary nests, a button weighing two or even three ounces may be made, and if broken through the middle the amount of carbon may be guessed; the dark, rough, semi-crystalline, porous surface represents about 4.25 to 4.50 per cent.; white or grayish-white, smoother, very hard, not granular surface, may be about 2.50 to 3 per cent., and it is quite possible to produce a button closely approximating steel of good quality, known by its hardness and steely grain, containing about 1.5, a little more or less, according to treatment. With a little practice the assayer may judge of the heat, also the assay quantity of ore to be used, the time, and quality of ore to make an assay containing very nearly the kind of carbon metal he wishes. These remarks take into consideration nearly pure ores and the use of the same ore or similar ores at each trial.

Ores containing sulphides, arsenides, or selenium should be roasted at a low heat, not quite to red, after being (in smaller assays) broken down to the sizes of shot.

Besides what we have already said we should state that these buttons may contain other impurities as phosphorus, copper, titanium, manganese, chromium, and frequently magnesium, calcium, and silicon, and perhaps some other elements which only the wet assay may wholly eliminate. But notwithstanding all these impurities the metal produced always approximates the furnace product more nearly than even the wet and more accurate assay. And therefore it is very useful.

In choosing samples for experiments from the ore bed the

assayer should use great caution, especially if by this assay he is to judge of a large quantity, or of the entire mine. In choosing a sample he should, if possible, visit the mine or ore heap himself and select from both the smaller pieces and larger, have them broken down together, mixed thoroughly to the amount of five or ten pounds, then the pile quartered and two diagonally opposite quarters taken out mixed and still further broken down and divided in the same way, until the whole is reduced to about three or four ounces, which may be passed through a silk sieve or miller's bolting cloth of 40 to the inch. The whole must be passed through entirely, as silex and some other impurities, being hard, remain until the last sifting, and if they are not passed through, they materially change the result in some assays. In this condition the ore may be kept in a jar for future use. This size is good for dry assay, as above described.

In some cases where much quartz is associated with the ore it may be well to use about half the assay weight of dry lime, or fluorspar; both must be free from any sulphate or sulphide (gypsum or pyrites). These unite with the quartz to form a flux and then a slag. Where the ore has little or no quartz, sand or pounded glass may be used to make a flux with the gangue of the ore, and a little practice will enable the assayer to judge as to the quantity to be used. In this case also a brasqued crucible should be used, or the crucible be rubbed inside thickly with plumbago. If the reduction is performed in an anthracite coal furnace, the outside of the crucible should be rubbed well with plumbago

to prevent the clinging of pieces of slaty coal to the crucibles; or plumbago (black lead) crucibles may be used.

As we have already intimated, the metal formed by dry assay will always weigh more than the pure iron, because of the impurities mentioned; but, as we have said, it is very near the condition of the cast-iron from the same ore in the blast furnace, and these buttons may be subjected to the wet method for determination of other ingredients or elements as found in the button.

THE WET METHOD enables the assayer to determine not only the iron, but every other element in the ore. When, however, the element sought is only iron, the following plan may be pursued:—

Reduce the ore, as before spoken of, to a finer powder, using a bolting cloth of 80 to the inch, passing about a gramme (15.43 grains) entirely through. Weigh, and then heat in a porcelain crucible to a low red over the blast alcoholic lamp, or Bunsen burner. When no reduction of weight is observed, weigh, subtract this weight from the first weight and you have the amount of water in the ore, both mechanically combined and the chemically combined water. Transfer the assay to your beaker glass—the size of the beaker glass should be about 7 by 3 inches, or larger—pour upon the assay about an ounce of muriatic acid (hydrochloric acid, HCl) and digest with low heat till the ore disappears in the solution, stir with a glass rod, or narrow slip of glass, or platinum wire, and add a little nitric acid (25 or 30 drops), and after solution is fully effected, add about four or five ounces water, stir, now add slowly aqua ammonia

till a precipitate begins, stir again and add more ammonia till apparently no additional precipitate appears. If the solution smells of ammonia, stop, stir with the glass rod and let it settle. This precipitate now contains all the iron in the condition of sesquioxide. In a few minutes it will settle towards the bottom of the beaker. But the precipitate contains also all the alumina of the ore, if there was any, but it is quite soluble in caustic potass. Add now a piece of a stick of caustic potass about one inch and a half in length while the solution is quite warm; if any hissing or commotion takes place, as is usual, wait till all is dissolved and heat and stir for about ten minutes till the solution is a little below boiling point, stop and let the temperature remain the same. You have now probably dissolved all the alumina, and the sesquioxide, undissolved, is precipitated in the solution. Let all stand till nearly cool, giving ample time for any floating sesquioxide to settle. Some specks will hold up because of a minute bubble of air, but cooling will collapse them and they may all sink. If not, touch them with the rod. Now if only iron is to be ascertained, prepare your filter paper upon the glass funnel over another beaker, stir the solution and slowly pour it out upon the filter paper until the whole has passed through. Add some more warm water from your washing ("spitz") bottle, till all of the assay is out of the beaker and upon the filter. Now comes the washing of the soft sesquioxide. Use the spitz to stir up the precipitate by blowing the stream on the filter paper around the mass, then into it, let it settle, dose it again, and after you have passed about a pint of hot water upon it, lift the funnel off



the beaker and let six or eight drops of the solution fall into a small test tube, replace the funnel over the beaker and let fall one drop, or less, of silver nitrate into the test tube. If there yet remains a trace of hydrochloric acid, a milky appearance (silver chloride) is seen. Continue the washing for a time, which must be according to the density of the milky precipitate, or until, on again testing, no milkiness appears. Put the funnel with filter aside covered from dust, and let it dry. It will shrink to less than one-quarter its size. When dry it is easily detached from the filter paper, and may then be transferred to the porcelain cup, or platinum crucible for heating till all water is driven off; this requires a low red heat continued till no decrease of weight is perceptible. If great accuracy is required, and every particle and even iron stain cannot be removed from the filter paper, then the filter paper must be burned, as we have already described, but more particularly again. After the mass and all particles have been removed from the assay paper, the paper itself must be rolled up, or torn in pieces carefully so as to lose nothing, and burned to ashes in the crucible either with the oxidizing flame of the blowpipe, or better over the alcoholic blast lamp, till every particle becomes a white ash and no carbon specks remain. Cool it and weigh. Subtract the former noted weight of that paper's ash from the latter weight of the burned filter ash and sesquioxide, and you have the amount of only that sesquioxide which adhered to the filter paper. This weight must be added to the weight of the mass, and you have then almost accurately the whole amount of sesquioxide, every 100 parts of which contain 70

parts of pure iron, if it is in a state of purity. We say "almost accurately," for the sesquioxide very probably, despite the washing, holds very little of the potash. But where extreme accuracy is not necessary the potash may be very nearly washed out by using boiling hot water, long continued, until no residue appears upon a bright strip of platinum, or silver, after evaporating upon it, in a flame, a drop of the filtrate.

The precipitate (sesquioxide) may be separated from the potash much more readily, after a little washing with nearly boiling water, by re-dissolving upon the filter, by hydrochloric acid dropped upon it, and after all has passed through, precipitating by ammonia again, the solution being made *hot*, and washing. Time is saved by this process. Care must be taken to wash all the dissolved sesquioxide through the filter before precipitating with ammonia. The sesquioxide is now ready (see below) for extracting phosphorus.

If, however, you wish corroborative proof and accuracy, with less washing, Wöhler's method is the best, namely: Neutralize the dilute solution of the ore (before precipitation by ammonia) with carbonate of sodium, add to it hyposulphite of sodium, and boil until sulphurous acid ceases to be evolved, that is, until it cannot be detected by the smell. The alumina collects as a pretty dense precipitate, which only needs to be filtered, washed, calcined by red heat and weighed. If properly performed, the alumina must be white, entirely. To the solution, after a little concentration by evaporation, add potassium chlorate (a gramme or more), and hydrochloric acid, filter to separate some particles of free

sulphur, and then precipitate the iron sesquioxide by ammonia, just as before. The weight of the alumina may now be ascertained.

**FOR PHOSPHORUS.** The iron sesquioxide may contain this element, and as its amount is a fact to be studied in iron metallurgy, we must examine the sesquioxide carefully, thus: The sesquioxide remaining upon the filter, as spoken of in the second paragraph above, or any peroxide precipitated by ammonia from a hot solution, contains the phosphorus. The following method is the best for its determination: dissolve the finely pulverized ore in hydrochloric acid, adding 15 or 20 drops of nitric acid to reduce all protoxide to sesquioxide (peroxide), then heat the solution, using as little acid as possible beyond the quantity necessary for dissolving the ore.

*Note:* If all the ore is not dissolved at first, then continue heating and agitating with a glass rod; if not yet soluble, then either separate the insoluble particles by filtration, triturate, heat with caustic soda and dissolve again, or begin with a new supply of ore (a gramme), and after putting the very finely triturated ore into a platinum crucible, add 4 to 5 grammes of caustic soda, or potash, or the sodic-potassium (see page 58), heat slowly to red heat, moderating the heat till all effervescence ceases, then increasing the heat and continuing till all is dissolved and is tranquil, remove the crucible, cool it on a cold plate rapidly, and place it in a porcelain dish containing water sufficient to cover it. Add a few drops of hydrochloric acid and heat the dish, and continue adding hydrochloric acid till all is dissolved.

After this, wash out the platinum crucible, that is, rinse out all its contents in order that nothing be lost and evaporate the liquid to dryness. This last process renders all the soluble silica insoluble even in the hydrochloric acid with its little water which may be added and the whole now thrown upon a filter paper, filtered and washed; the silica remains in the filter and the iron with its phosphorus passes through into the filtrate. Wash the white silica well so that no cloudiness appears in the filtrate when tested with silver nitrate, as we have before described, and this filter paper may be removed to dry, and its silica weighed when ready, and the filter burned as we have shown where great accuracy is required.

Remove the alumina, as before directed, precipitating the peroxide which is now clear of silica and alumina and you are ready to remove the phosphorus. With proper care, as we shall direct, the molybdate of ammonium is the reagent to be used. An aqueous solution of this reagent is to be preferred to that in nitric acid (see under Reagents), commonly employed. Its strength is but from 50 to 60 grammes to the litre (1.7 pint) of water. Phosphorus is not precipitated by this reagent from neutral solutions, and on the other hand *strongly* acid solutions retard, or even resist precipitation.

Parry's method, the accuracy and value of which Mallet has proved, is as follows: Add ammonia to the solution until a complete precipitation occurs of peroxide of iron. Add cautiously as much nitric acid as is just sufficient to redissolve the precipitated peroxide. Bring the solution to boil

and add the molybdate of ammonia in the proportion of about 30 cubic centimetres to the quarter litre of iron solution (*i. e.*, about 14 fluidounces to  $8\frac{1}{2}$  ounces) or a little more if it be rich in phosphorus. The usual yellow precipitate may appear immediately, but if not, boil briskly again for a few minutes, add a very few drops of nitric acid, and shake the closed flask vigorously at intervals, and continue to add a drop or two more of nitric acid until a distinct precipitate is observed to commence. The ebullition must now be stopped or a bulky flocculent precipitate will rapidly form; but the flask should be kept hot and as near to the boiling-point as possible (without actual boiling), and shake briskly now and then. In from an hour or two to four or five hours the whole of the phosphorus will usually have precipitated in a good granular form. If these details be fully observed, it is seldom necessary to repeat the process in order to obtain the whole of the phosphorus present. The yellow precipitate separated by filtration, washed with water and molybdic solution (equal volumes), is redissolved afterwards on the filter with the aid of ammonia. Pour into this ammoniacal solution a solution of sulphate of magnesium, which precipitates the phosphoric acid in the ordinary form of double phosphate of ammonium and magnesium. The precipitate is thrown on a filter, washed with cold water containing a third of its volume of ammonia, then dried, calcined, and weighed, as  $Mg_2P_2O_7$  or  $2MgOP_2O_5$ . In calcining (with red heat) it loses ammonia and water. In this precipitate phosphorus is 27.92 per cent. of the whole and the  $P_2O_5$  (phosphoric acid) 63.96 per cent. (See p. 41.)

Care must be taken not to calcine the phosphate too rapidly, else it will not have time to oxidize the carbon particles which may have fallen into it from the filter paper or from some other source, and the mass may be dark. To avoid this, raise the temperature slowly to redness; in this way the precipitate becomes pulverulent, and the organic matters are completely burned away.

In these processes we have separated from the iron and determined the elements alumina, silica, and phosphorus. The peroxide of iron may be precipitated as before, or it may now be determined from a fresh amount of ore of same weight dissolved in hydrochloric acid, the peroxide of iron and the alumina precipitated by ammonia in excess, heated, and the precipitate washed, dried, and calcined. The weight of the alumina, silica, and phosphoric acid subtracted from the precipitated sesquioxide leaves the weight of the pure sesquioxide. The pure iron may now be deduced thus:  $\text{Fe}_2\text{O}_3$  (sesquioxide anhydrous)  $112 + 48 = 160$ , that is, every 160 parts contain 112 of iron, or 70 per cent. The various weights of assays must in their sum equal the original weight of the assay, or we must look for other elements.

In the filtrate from the iron and alumina may remain lime and magnesia. The lime may be precipitated by oxalate of ammonium added in excess, after warming the solution, and allowing it to stand for ten or twelve hours. If any adhere to the glass, drop a few drops of nitric acid upon it and precipitate it again with the ammonium oxalate and add it to the other. Instead of filtering, as it is difficult, the supernatant liquid may be decanted until near the precipitate and

the latter then thrown upon a filter previously wetted with a little water and alcohol to facilitate filtration without loss, and washed with warm water. Dry and calcine slowly to a red heat and keep it at this heat until changed from oxalate of lime to carbonate and then to caustic lime from which all the carbonic acid ( $\text{CO}_2$ , carbonic dioxide) has been driven off. It can then be weighed as lime ( $\text{CaO}$ ). It is well to try this lime in the porcelain or platinum crucible by dropping a little hydrochloric acid upon it after adding a drop or two of water.

If there is no  $\text{CO}_2$ , there will be no effervescence; if there is, then the reduction of the ammonium oxalate to lime was not well done. You must now add a few drops of sulphuric acid, evaporate with care to dryness, calcine at a low heat, and after cooling weigh and from the sulphate of lime thus formed ( $\text{CaOSO}_4$ ) the lime may be determined, being 41.17 per cent. The magnesia still remains in the solution and this may be determined by adding ammonia in excess, then a solution of phosphate of sodium also in excess, set aside for 12 to 24 hours. After this filter, washing with cold water containing one-quarter to one-third of ammonia, dry, calcine to low red heat, cool, and weigh, 36.03 per cent. of which is  $\text{MgO}$  = magnesia.

*Cautions.*—To the inexperienced it may be necessary to use test papers to determine the alkaline, or acid, condition of assays. The preparation of these we have described in the beginning of this part of the work (p. 63). But a little practice will decide; ammonia in excess may be known by the smell, even when the excess is small. Always stir a solution im-

mediately before testing. So with sulphuretted hydrogen and ammoniacal sulphides when used and eliminated by boiling, their presence or absence may be tested by the smell. In stirring solutions learn to stir without much striking the sides; some testing, as for magnesia, requires care not to scratch or even touch the glass, but where the amount of magnesia is small the precipitation may be promoted by drawing the glass rod over the inside of the glass, in contact but not by scratching.

In precipitating lime, when it bears a small proportion to that of the magnesia present, the assay for lime must be particularly careful, for it goes down in part, and, if very small, wholly with the magnesia. So if this condition is suspected both the lime and magnesia must be converted into sulphates, as we have explained when the assayer has failed to reduce the oxalate to lime, but has injured his assay by not sufficiently calcining. In the assay the lime sulphate is not soluble in alcohol, while the magnesia sulphate is, and so the two may be separated and the magnesia be afterward precipitated.

**FOR SULPHUR.** The ore may yet contain S from some sulphide of iron, of barium of lime or of copper, but generally as sulphide of iron. As sulphur is important in its influence upon the wrought iron produced, it is important to be exact in the analyses for this element, and it had better be determined from a freshly made solution of ore.

The most satisfactory way to ascertain the sulphur in the ore, whether brown or red hematite or magnetite, is finely to pulverize the ore, sift (80 to the inch), dry and mixed with



four or five times its weight of caustic potass, or soda, or a mixture of both (see Reagents), place in the platinum crucible, begin heating slowly and increase the heat to red as the effervescence ceases, until a tranquil fusion is effected. Time will depend upon the nature of the ore and the fineness to which it was reduced. During the fusion carefully add about twice its weight (of the ore) of nitrate of potassium (dry and in small pieces). The better way is to mix carbonate of soda 10 parts and carbonate of potassium 14 parts, and of this mixture take 4 times the weight of the ore to be assayed; add twice the weight of the ore, of nitrate of potassium all dry, and when the ore is being heated in the platinum crucible, add, by degrees, the powder until all has been added and all is in tranquil fusion. Let it cool, and treat with hydrochloric acid till all is completely dissolved, evaporate to dryness for silicic acid (as we have already described) and to decompose the nitrate. The residuum is now to be moistened with hydrochloric acid, and afterward treated with hot water, filtered, and thus the silicic acid separated, the solution should be perfectly clear. We are now ready to precipitate the sulphur as sulphate of barium, but it must be done carefully by adding in small quantities of chloride of barium. If the ore contained iron pyrites, it is always better to add a weaker solution of the barium chloride in order not to make too dense a precipitate.

If the ore contains calcium sulphate or iron sulphate (gypsum or native copperas, so called) it must first be boiled in water, filtered, and what is soluble be treated until all the

sulphur is determined by the chloride of barium, and afterward treat the insoluble residue as described above.

*Caution.*—The barytic sulphate thus produced may retain some of the alkaline salts used, and this has sometimes made an error in excess in the assayer's analysis for sulphur. Stolba (so Mallet) says it is better after the filtrate comes away, apparently free from barytic sulphate, to place all the latter in another beaker and release it by rewashing after treating it in a small beaker with a solution of neutral acetate of copper with some acetic acid added, and then digesting it at a boiling heat. After about five minutes' heating throw it again upon the filter and filter and wash anew. Thus the sulphur may be very closely found after careful drying and calcining the sulphate at low red. The per cent. of sulphur in barium sulphate is 13.73.

The above elements, silica, alumina, lime, magnesia, phosphorus, and sulphur are all which occur as the general accompaniments in the brown hematite ores, very rarely barium, but in some ores manganese forms a very important part, and it is well to become acquainted with the process of determining this element.

**MANGANESE.** After the reactions with the blowpipe, one of which we have sufficiently pointed out in the beginning of this part (p. 31), and a better one under **MANGANESE**, indicate the presence of this element, we proceed to determine its quantity as follows:—

The shortest way is to use carbonate of barium. The solution of the ore is saturated with carbonate of sodium, testing the solution with litmus paper until very little free

acid shows itself. Then add an excess of carbonate of barium, stir well and let it act *cold* for about half an hour, stirring the liquid frequently. Separate the precipitate by filtration. This contains the peroxide of iron, phosphoric acid, and alumina, combined with some of the carbonate of barium. Wash with cold water, and the filtered liquid contains the manganese, lime, magnesia, and a salt of barium. The precipitate may be proceeded with as we have before directed to obtain iron, alumina, and phosphoric acid, the only additional care being to get rid of the barium. This must be done by redissolving the precipitate over a new beaker separately with hydrochloric acid, washing all through, and precipitating the barium with dilute sulphuric acid and separating by filtration. You are now ready to precipitate as before with ammonia, collect the filtrate, and proceed as we have shown. Use Wöhler's process as always preferable to the usually adopted method of using caustic potash to separate the alumina, unless it is not necessary to be extremely accurate. We have described this already. If you have room enough in the same beaker, a new one need not be used, but the precipitate dissolved with hydrochloric acid a little diluted and run off, using the same filter and beaker, washed with warm water slightly acidulated with hydrochloric acid and the filtrate, thus diluted, boiled and then the barium precipitated by sulphuric acid diluted. Let the solution stand until all is settled, separate the barium sulphate by filtration, and then, as we have already shown, precipitate the peroxide, alumina, and the

accompanying phosphoric acid by ammonia, filter, wash, and proceed for alumina and phosphoric acid as we have directed.

The clear, colorless liquid which contains the manganese, lime, and magnesia must be poured into a matrass and heated slightly. The liquid now contains chloride of ammonium from the use of both hydrochloric acid and the ammonia to precipitate the peroxides; this condition is necessary in order to proceed for the manganese. Add hydrosulphide of ammonium to precipitate the manganese. If the iron has been previously carefully and entirely precipitated, the precipitate will be of a very clear rose color; any grayish or black color will show that some lack of care has pre-existed and iron remains. After twelve hours' rest, the matrass being either corked or covered with a watch crystal, the hydrated sulphuret of manganese will be entirely precipitated. After some time the color may change to a greenish tint, due to the fact that the hydrated sulphuret of manganese loses a little water of hydration, but this is immaterial. The precipitate may now be filtered with some care, thus: Filter off the liquid from the precipitate and add the latter to a solution of chloride of ammonium in another vessel, to which some drops of the hydrosulphide have been added, let it settle, and then decant the whole upon the same filter and add this solution to that first made. If there are any signs of remaining sulphuret of Mn in the solution, run it through again. Now wash the precipitate with distilled water containing a little both of the hydrosulphide and of the chloride of ammonium, and as the washing proceeds diminish the quantity of chloride of ammonium

and toward the close omit it entirely. The danger exists in the change of sulphuret of manganese into protosulphate; the latter being soluble may pass over into the filtrate. Hence the use of the hydrosulphide to prevent this change, but care should be taken to keep the filter full and thus protect the precipitate from contact with the air as much as possible.

The first of the filtrate may be somewhat turbid; if so, filter for awhile and throw back this turbid filtrate when the liquor flows clear. The precipitate may now either be washed, dried, and calcined, protected from the atmosphere as much as possible and weighed, or more accurately thus: treat the precipitate and filter with hydrochloric acid somewhat diluted, avoiding excess beyond that necessary fully to dissolve the precipitate. The sulphuret of manganese is now changed into the soluble chloride and hydrosulphuric acid gas is given off. Heat the solution till the passage of hydrosulphuric acid gas ceases and filter to get rid of all particles which may be floating in the liquor. Boil the solution and add very cautiously, a little at a time, carbonate of sodium (lest too much effervescence causes loss), until the solution shows slight alkaline reaction (using reddened litmus paper for this purpose). The precipitate now is proto-carbonate of manganese. Wash several times by decantation, filling the jar or beaker with hot water, letting the precipitate settle, and pouring off. Then throw it upon a filter, passing all through, and continue the washing till a polished platinum strip shows no residue. Dry and calcine strongly, as in reducing carbonate of lime to lime, in contact

with the air and weigh; every hundred parts contain 72.05 parts manganese, that is, of the resulting  $Mn_3O_4$ , 72.05 per cent. is manganese.

The solution may now be heated to boiling and the hydrosulphide of ammonium completely decomposed by adding hydrochloric acid slowly until no sulphuretted hydrogen remains; this can be known by the absence of all smell. Filter to separate the deposited sulphur, neutralize with ammonia, and proceed to separate lime and magnesia as already directed.

SPATHIC ORE, or ore containing carbonic dioxide,  $CO_2$ , as iron carbonate. The determination of  $CO_2$  is the same as in marble or any lime carbonate and is made by using a small glass instrument, formerly called Kipp's apparatus, of the following form (Fig. 5).

Fig. 5.



Into *B* put the carbonate, powdered, dried, and weighed, through the hole at *D*; add a little water. Into *A* hydrochloric acid is poured through *C*, after fixing the glass stopper tube in its place, till *A* is nearly full. Wipe dry and weigh the whole. Draw the tube *D* out through the cork so far that the lower end will not come in contact with the carbonate when the latter effervesces; now draw

the tube *C* up a little so as to drop a few drops of the acid upon the carbonate and let the effervescence subside; then drop some drops again and repeat this process until all effervescence entirely ceases to come off. Draw out the cork at *D* and with a perfectly dry glass tube blow gently into *B* through the open hole until all  $CO_2$  has been driven out,

and if the vessel is warm from the action of the acid upon the carbonate, let it stand till as cool as when the acid was poured in. Now weigh the whole again. It will weigh less than before; subtract the latter from the former weight and the weight of the  $\text{CO}_2$  will be had as that of the carbonic dioxide ( $\text{CO}_2$ ) of the iron carbonate weighed at first, and this will be nearly accurate; the only inaccuracy will result from carelessness and the loss of moisture escaping through the tube at *D*. The latter may be provided against by having a short glass tube with a cork tightly fixed in one end with a hole sufficiently large to admit the end of the small tube at *D*. When all things are ready and just before weighing fill this larger tube with some small pieces, the size of about one-eighth or one-fourth inch diameter, of calcium chloride. The escaping gas will leave its moisture in the salt and the dry gas only will escape; the upper end of the short tube may have a piece of cork cut to fit in loosely so as to allow the gas to escape and yet not allow much contact with the outside air.

In the use of this carbonic dioxide apparatus, some experience, care, and skill are required, and the student should, for his own practice, try this  $\text{CO}_2$  determination at least three or four times, before feeling that he is competent to use the apparatus.

Several other shapes and sizes of carbonic dioxide apparatuses are offered, but, as skill in the operator is the chief matter, there is none superior to the last mentioned, in the hands of the careful manipulator; in fact with two of the smallest beaker glasses, usually found in a "nest," a prac-

tised analyst may make a very good analysis of  $\text{CO}_2$  by placing the weighed carbonate with water in one beaker, the acid in the other and weighing the two glasses, treating them as above suggested, weighing again and subtracting the latter from the former weight. But this last process is not so convenient as with the single instrument.

The Kipps, and any other apparatus of this kind, may be had at any chemist's wareroom.

**TITANIC ACID.** Immense quantities of a dark-colored iron sand are found in Nova Scotia, and, a few years ago, on Honduras Bay, and more recently in various parts of the United States and Territories. This sand contains iron and titanitic acid. It has also occurred in some magnetite ore in New Jersey in very small per cent., and yet so as to show itself in the furnace slags on the Lehigh, and wherever titaniferous iron ores are smelted, but the furnace products do not appear to be  $\text{TiO}_2$ , but  $\text{TiCy}_2\text{Ti}_3\text{N}_2$ . As a mineral it is called *rutile*, which contains sometimes over 98 per cent. of titanitic acid ( $\text{TiO}_2$ ). The iron sand sometimes possesses as much as 40 per cent. Some ores contain less than 3 per cent. and can then be used in the furnace, but any per cent. over that amount causes the ores to be rejected, although in wrought iron made from such ores the effect is to strengthen the iron, and in certain proportions its action is to make a steely iron. The difficulty as to the use of these ores in the furnaces is that the associated lime and coal (flux and fuel), called "charges," must be somewhat modified to keep up the same grade of pig iron.

Under the blowpipe, titanitic acid, even though combined



with iron, may be detected by treating a small particle first in a bead of phosphate of soda in which no color appears except from the iron in the R. F., but after treating the bead with metallic tin upon charcoal a violet color appears more or less apparent according to the amount of titanium.  $\text{TiO}_2$  is not soluble in acids, but may be made soluble by heating to fusion with caustic alkalis, or their carbonates. An excess of acid is then added, and with the addition of tin foil it gives a decided violet color, especially when concentrated.

To extract  $\text{TiO}_2$  from the iron sand, or titanitic iron ore, the substance is finely pulverized and fused with three parts of carbonate of potash [or soda potash]; on washing the mass with hot water a part of the alkali is removed and an acid titanate of potash left mixed with the iron oxide. This is dissolved in hydrochloric acid and the solution evaporated to dryness, when the titanitic acid and any silicic acid which may be present are converted into the insoluble modifications and are left. The residue is again digested with hydrochloric acid, is washed with water (by decantation, for titanitic acid easily passes through the filter), dried and fused at gentle heat with bisulphate of potash. The sulphuric acid forms a soluble compound with the  $\text{TiO}_2$  which may be extracted by cold water, leaving the silicic acid undissolved. The solution containing the titanitic acid is mixed with about twenty times its volume of water, and boiled for some time, when the titanitic acid is separated as a white precipitate, exhibiting a great inclination to cling as a film to the surface of the flask in which the solution is boiled, and giving it the appearance of being corroded.  $\text{TiO}_2$  becomes yellow when

strongly heated, and white again on cooling; it does not dissolve in solution of potash like silica, but forms a titanate, which is decomposed by water; the acid titanate of potash which is left may be dissolved in hydrochloric acid, and if the solution be neutralized with carbonate of ammonia, hydrated titanate acid is precipitated, very much resembling alumina in appearance. (Bloxam.)

#### VOLUMETRIC DETERMINATION.

We shall preface the explanation of this method by saying that while it is a very convenient one under exceeding care, it is nevertheless attended with the difficulty that inexperienced analysts may need considerable practice before accuracy can be claimed in the results arrived at. It would be well for a beginner to assay a piece of pure iron wire by the process already described by ammonia precipitation, etc., and then experiment with the volumetric determination, comparing results.

VOLUMETRIC DETERMINATION by potassium permanganate depends upon this fact, that a definite amount of this salt in solution will change a definite amount of a solution of a ferrous salt ( $\text{FeO}$ ) into a ferric salt  $\text{Fe}_2\text{O}_3$ . If we know how much iron in the ferrous state ( $\text{FeO}$ ) can be changed into the ferric state ( $\text{Fe}_2\text{O}_3$ ) by 100 cubic inches of a certain strength of solution of permanganate of potassium, we can readily know the amount of iron in any solution of an ore, without either weighing or separating any of the associated elements, by simply measuring the proportion of solution of permanganate taken up in the change.

**THE PREPARATION.** Dissolve 5 grammes of pure crystallized potassium permanganate in a litre of water and preserve it in a well-stopped bottle away from the light. It does not readily alter, but should occasionally be tested as to its efficacy.

**PREPARATION OF THE TEST IRON.** Weigh off carefully one gramme of thin ( $\frac{1}{16}$  inch) clean piano wire, transfer it to a  $\frac{1}{4}$  litre (nearly half pint) flask having a mark or measure line of capacity, containing 100 cub. cent. (about 3 oz.) of dilute sulphuric acid, 1 part to 8 of water. Add a little sodium bicarbonate simply to evolve a little  $\text{CO}_2$  to keep air out, and then stop the flask with an india-rubber cork provided with a tube for evolution into another flask containing 20 or 30 c. c. (about one ounce) of water. Previously to proceeding any further, boil about 300 c. c. (8 or 9 oz.) of water to exclude all the air and place it aside to cool. Heat now the first flask containing the iron carefully to boiling till the iron is dissolved, and the evolved hydrogen will escape into the water of the second flask, the tube being bent so as to pass at right angles down into and under the water surface in the second flask.

It should be stated that the tube passing out of the flask containing the iron should be bent at right angles and be similar to another right-angle piece leading into the second flask. The benefit of two tubes is that a piece of india-rubber tubing of a couple of inches in length may be slipped over each tube end and thus allow of a clip, or pinch stop, between the two flasks to cut off the communication between them, when such action is needed. Thus, when the iron is

boiled to entire dissolution in the dilute sulphuric acid, the clips can first be put on, and after removing the lamp the flasks will no longer be in communication. After the solution cools, open the clip and the partial vacuum in the first flask will now draw the water up from the second flask, and, by so adding the water which was boiled and put aside to cool, the first flask may be filled to the mark which as we said at first indicated  $\frac{1}{4}$  litre (7 oz.). This solution contains now one gramme of iron wire, which we will suppose contains .996 pure iron, because by general assays piano wire is supposed to contain .4 carbon. This wire must be assayed if great precision and certainty are required. But we now proceed to draw out of the flask, by means of a pipette, 50 c. c. of the iron solution containing  $\frac{1}{5}$  of the iron (the  $\frac{1}{4}$  litre = 250 c. c.), and transfer to a beaker of 400 c. c. capacity, then dilute, until the beaker is half full and place it upon a sheet of white paper that the changes of color may be seen. Fill a burette, graduated accurately, with the permanganate solution. Now add the permanganate to the ferrous solution, stirring it well all the time. At first the red drops disappear rapidly and then more slowly, the solution gradually changing to a yellowish tint; then proceed slowly until the last drop imparts a faint, though unmistakably reddish tint, which remains even on stirring. Stop and let the permanganate solution be carefully read off and the cubic centimetres noted with great exactitude. The amount of permanganate solution should be about 20 c. c. Repeat the experiment with another 50 c. c. of the iron solution, and compare the two notings: there should be not over .1 of a

c. c. of difference. If there is a greater difference, try again another 50 c. c. Practice will perfect the beginner. From the average calculate from the quantity of permanganate used the amount of iron changed by 100 c. c. First divide the iron weighed off at the beginning by 5 and multiply by .996 (the per cent. of pure iron in the wire used); this gives the amount of iron in 50 c. c. of the solution. Thus, suppose we took 1.050 gramme of iron wire and used a mean of 21.3 c. c. of permanganate, then 1.050 divided by 5 is .210, multiplied by .996 equals .20916, which is the amount of iron in 21.3 c. c. Then  $21.3 : .20916 :: 100 : .98197$ , that is, for every 100 c. c. of that solution of permanganate used .98197 is the proportion of pure iron represented. This is, in the main, the method as described in Fresenius, and it is added that, if there is a deficiency of free acid in the solution of iron, the fluid acquires a brown color, turns turbid, and deposits a brown precipitate (manganese dioxide and ferric hydroxide). The same may happen also if the solution of permanganate is added too quickly, or if the proper stirring of the iron solution is omitted or interrupted. In these cases the result is not satisfactory. That the fluid reddened by the last drop of solution of potassium permanganate added loses its color again after a time need create no surprise or uneasiness; this decolorization is, in fact, quite inevitable, as a dilute solution of free permanganic acid cannot keep long undecomposed. (Fresenius.)

It is plain that when the per cent. of iron is all that is needed, all that is required is to pulverize the iron ore, weigh and dissolve in hydrochloric acid and reduce the iron to the

protoxide condition (ferrous) and then note the proportion of potassium permanganate solution required exactly to change the ferrous to the ferric state in the assay and state the proportion, thus: the weight of the assay ore we will suppose is 2 grammes and of the solution of permanganate used is 50 c. c., which was proved to be equivalent to (half of 100, which was shown to be .9819) .490+ of iron. Then the amount of iron present is .490 of a gramme in 2 grammes of the ore.

To prepare the ore for the assay we must see to it that the condition of all the iron therein is that of ferrous salt. In order to this condition the ore should be dissolved as usual in hydrochloric acid, using a little more than is absolutely necessary to dissolve it. Let it be entirely free from nitric acid. The condition now is that of a ferric solution, and by dropping in small pieces of granulated zinc, which has been found free from iron, hydrogen begins to form immediately and passes out of the flask, which, if it has a long narrow neck, will drive out the atmosphere and the solution will become paler as the ferric chloride changes to the ferrous chloride. If sulphuric acid was used instead of hydrochloric acid, the state of the iron would be that of ferric sulphate and ferrous sulphate. Use a moderate heat and more zinc until the color having been perfectly removed, that is, the ferric having been changed into a ferrous condition, you are now ready to add the potassium permanganate from the graduated burette, as we have already described. If the zinc contains iron, as is frequently the case, and perfectly free zinc cannot be obtained, the zinc must be analyzed for iron, and the proportion of iron in the weight used must be subtracted

from the amount of iron found in the solution, and this zinc be always that which shall be used with its stated amount of iron.

If the presence of the atmosphere is objectionable because that the analysis is desired to be extremely accurate, then the passage of  $\text{CO}_2$  into the flask over the solution from a prepared bottle kept for this purpose, may be provided for, and the surface of the ferrous solution kept from the oxidizing influence of the atmosphere until the volumetric determination has been made.

A ferric solution may be changed into a ferrous by passing hydrogen sulphide through the solution while cold. Continue passing the hydrogen sulphide some minutes after the color due to the ferric condition has been changed entirely. Then cautiously increase the heat to boiling and continue boiling till all the hydrogen sulphide passes off and produces no discoloration upon lead paper held at the mouth of the flask. When the boiling is discontinued fill the flask to within an inch of its mouth and close with a stopper and cool rapidly in a basin or stream of cold water. It is now ready for volumetric determination.

The hydrochloric acid should be removed from the solution before the change of ferric to ferrous state is produced, and this may be done by adding sulphuric acid in excess and evaporating the solution as long as hydrochloric acid vapors pass off at a temperature of about  $212^\circ \text{F.}$  ( $100^\circ \text{C.}$ ). Add water on cooling and digest till any ferric sulphate crystals which may have formed are dissolved. Care must be taken to add sulphuric acid liberally. If there should prove to be

much barium, calcium, or any salt which when combined with sulphuric acid might form an insoluble salt, the process by using zinc would be preferable, as these insoluble salts may hold some iron. If, therefore, after evaporating with sulphuric acid, and subsequent treatment with water, any insoluble residue remains, it must be examined for iron.

The above method is generally preferred to others which may be found in some works on analysis, and where care has been taken to keep the potassium permanganate solution always regulated, and skill used in reading off the amount used, a few experiments will make the performer quite ready and the process become very easy and accurate. This method of determination of iron becomes very important in the hands of a skilful manipulator, as enabling the analyst to determine "by difference" the amount of other ingredients in an ore; thus, if he has the weight of a precipitate containing peroxide of iron and alumina, having by volumetric determination the weight of the iron, he may know that of the alumina by simply subtracting the weight of the iron from the whole. Or, if he has the alumina by actual analysis in a peroxide which he suspects contains phosphoric acid, he may proceed in the same way—adding the alumina to the determined iron and subtracting the weight of the two from the whole; if anything be over, it will be that of the phosphoric acid, if the assay contains nothing else. Such a method of determination by subtraction is termed analysis "by difference," and in some cases is of great importance.



## EXHAUSTION OF IRON ORE DEPOSITS.

Before we close this section relating to iron we add the following remarks recently (1887) furnished for publication by Major John W. Powell, Director of the Geological Survey:—

“The great increase in the production of pig iron, from 4,529,869 short tons in 1885 to 5,600,000 short tons during the year 1886, has led to much inquiry as to the source of the ores which made this increase possible; for it is a well-known fact that even the ordinary production is a drain upon the ore deposits sufficient to exhaust the present sources of actual supply in a short period—perhaps in thirty years—more probably in much less time. The Government has given sufficient attention to the general geology of the country, however, to afford a good grasp on the distribution of the iron ores, and the geologists have also defined the character of the ores so well as to direct the explorers accurately to the profitable fields. The statement was made last year by me that within thirty years the necessary exploration for new iron ore mines would exceed that of Great Britain, where every available deposit is being traced to the furthest extent. The years 1885 and 1886 have shown the justice of this prediction in the development of new fields to support the increased production.

“The new Gogebic district in the vicinity of Gogebic lake, Ontonagon Co., Michigan, which produced 1022 tons in 1884, increased to 111,661 tons in 1885, and increased this fourfold in 1886, has been the scene of unparalleled devel-

opments, and the same is true of the Vermillion district of Minnesota. The confidence with which capital has been invested in these new claims is due to the advice of the geologists to extend the mines in this direction. That the new mines are the result and not the cause of the increased production of iron and steel, is shown by the increased imports of Spanish ores during the last year, as the result of higher prices. This shows that the remedy for prospective exhaustion is still further exploration for the mines to which the geologist points in various parts of the country. Many of the large deposits have been neglected, as not suitable for making steel by the ordinary acid process, and in others the percentage of iron is not attractive. But much attention will undoubtedly be given to these ores within the next few years. This tendency is seen at one locality in Tennessee by the increase from 70,757 long tons in 1884 to 94,319 long tons in 1885, and even the siliceous ores at Cornwall, Pa., show increased use."

---

## TIN.

Pure tin has a spec. grav. of 7.292, and belongs to the white metals, as silver, platinum, aluminium, etc., but the spec. grav. will readily distinguish the metal as tin. In a bar it is easily detected by the crackling sound emitted when bent back and forward. Excepting lead and zinc, it is the least tenacious, and hence lead is the only common metal which is more difficult to draw into wire at ordinary tempe-

ature. Tin may be drawn at 212° F. (Bloxam.) Melts at 442° F. and not easily vaporized. Only gold, silver, and copper are more malleable. Its chemical symbol is Sn, and its combining number or "atomic weight" is 118, or, exactly, 117.6980.

**OCCURRENT FORM.** It rarely occurs native, and then it is combined with lead and even gold in Siberia. (Dana.) Also as an oxide of tin (binoxide) (tin 78.67, oxygen 21.33 if pure), massive and in crystals of a lustrous black, or brown, and grav. from 6.4 to 7.1, and hardness 6 to 7, sometimes nearly transparent to entirely opaque. Called then *tin-stone*, either as crystal, or massive. The streak is white or grayish and brownish. It is brittle. The crystals take a four-sided shape (tetragonal, right prismatic) with tetragonal termination and variations from this form, the edges being sometimes replaced by planes, so that some appear almost eight-sided. Mineralogical name is *Cassiterite*. It also occurs as a sulphuret, containing copper, iron, and zinc, of a theoretic ratio corresponding to sulphur 29.5, tin 27.2, copper 29.3, iron 6.5, zinc 7.5 = 100; this is in foreign specimens. H. 4. Grav. 4.3 = 4.5, with metallic lustre, and, when pure, of a steel gray, but varying to a bronze-like appearance and then called bell-metal ore. Mineralogical name, *Stannite*.

The nodular or rounded grains of tin found in beds of streams and in alluvial soil, and called *stream-tin*, are very pure tin-stone (binoxide); as found in the alluvial soil of the island of Banca it is considered the best in the world. Only a small portion of this island has been explored for tin and

that in the north part, but the yield is about 4000 tons annually. In Cornwall the tin mines have been worked from remote antiquity, but the tin is mixed with various sulphurets and minerals, as copper, blende (zinc), arsenic, fluor, apatite and tungstate of iron and manganese (wolfram). The latter requires special treatment.

LOCALITIES AND GEOLOGY. It occurs in various other countries besides the ones stated above, as Austria, Siberia, Saxony, in Australia, and in form of cassiterite in some places in the United States: Maine, Massachusetts, New Hampshire, New York, Virginia, North Carolina, Georgia, California, Idaho, and, as asserted, in Missouri, but not in quantities sufficient to invite much outlay for working. From a mistaken notion as to the appearance of tin ore, several announcements have been made of discoveries in various places where no tin was, and in others where the amount of tin was so small and the associations so difficult to separate and in such preponderance, that the discoveries were without commercial value. And yet there are indications of its workable existence in Missouri and California.

At present the appearance of large quantities of tin-ore in Dakota with various associations, and in some parts almost pure, seems to indicate that it has a wide and valuable distribution. The district in Dakota, where the chief deposit has been found (June, 1883), is at the central portion of the Black Hills, in Pennington County, about twenty miles southwest of Rapid City, two miles from Harney City. It is at the claim known as the Etta, on an isolated conical granitic

hill rising about 250 feet above the surrounding valley, 4500 feet above the sea.

The geological surroundings of the Black Hills are those of the outcropping edges of the sedimentary formations from the base of the Silurian upward to the Tertiary, so far as they exist in the far West. These formations dip gently away on all sides from the central nucleus of the more ancient rocks which rise up in a multitude of irregular peaks and broken ridges with a general northerly and southerly trend. These rocks consist chiefly of fine-grained mica schist and micaceous sandstones, traversed by veins of quartz, which are often auriferous. In some portions the slates may be said to be garnet-slates, as they contain 20 per cent. of garnet, rather than mica slates. The mineral called *staurolite*, from the cross-like appearance of some of the crystals, is also very frequent in the rocks; staurolite is a silicate of iron and alumina with some magnesia. The transition from these schists to the granite is sudden.

The tin ore seems to be in granulated or disseminated condition in a rock composed of small scales of mica and albite feldspar, called "*greisen*," hand samples of which contain from 6 to 10 per cent. of concentrated ore. It is thought probable that it will be profitable to work, even if some of it does not carry more than 10 pounds of tin ore to the ton. The general average of the ores raised from the mines at Cornwall, England, appears to be less than 3 per cent., being under 60 pounds of "block tin" (concentrated tin ore) to the short ton of ore. Some of the greisen from Dakota, sent to the New York metallurgical works, assayed 4.6 per cent. of

block tin, equivalent to 2.95 of pure tin. Some of the massive "kidney" ore from the Etta mine yielded 44.1 per cent., according to the reports of the company.

Tinstone has also been discovered in the northwest parts of the Black Hills, in Wyoming, and stream tin in beautiful brown grains on Jordan creek, Idaho, with gold in the placer deposits of that stream. Also in 1876 a bar of tin was shown at the Centennial Exposition, made from *wood-tin*, in small rounded light brown colored grains about the size of peas, or kernels of corn, from Montana, not far from Helena. The composition of one of these ores shows the associations of the tin oxide as follows: The analysis is by Dr. F. A. Genth, of an ore from California, the Temescal tin mines at Cajalca:—

Silicic acid	. . . . .	9.82
Tungstic acid	. . . . .	.22
Oxide of tin	. . . . .	76.15
Oxide of copper	. . . . .	.27
Oxides of iron and manganese, lime and alumina		13.54
		<hr/> 100.00

**MINERALOGICAL APPEARANCE.** As the chief ore is that of the dioxide, sometimes called binoxide ( $\text{SnO}_2$ ) or *cassiterite*, attention should be paid to its appearance in the mass, or in grains. As the spec. grav. of the usual ore is not quite that of the pure tinstone, it is difficult to detect it by the weight, although as we have stated the pure is nearly if not quite 7, or very little lighter than cast iron. It is, therefore, much heavier than quartz, which is 2.5 to 2.8 and in hardness in some cases quite equal to quartz. In color, however, its

variations may perplex, as it is found black, brown, brownish-red and in the wood-tin mixed shades, generally with concentric shades and botryoidal shapes. Sometimes it has a reddish hue, gray yellow, or even white. The streak is not always white, but grayish and even brownish.

It has been confounded with tourmaline by those not well informed, also with brown garnet. From the former it may readily be distinguished by the lightness of tourmaline 3, tinstone 7, and the streak of tourmaline is always uncolored, though its hardness is 7. From garnet it may be distinguished by the spec. grav., garnet being very little more than 3, seldom ever over 4, and its streak is white. But the blowpipe will determine the difference immediately, and this must be brought in to help.

BEFORE THE BLOWPIPE. As *cassiterite*, on charcoal and alone, it remains unchanged. With soda it is reduced to a malleable metallic tin globule, and leaves a white coating (around the metal) of tin oxide. With borax on the platinum loop, it gives the colors of iron and manganese if they be present. The former is almost always present, but sometimes in quantities as low as 1 per cent. But pure tin in the borax gives no color; the borax bead, if discolored at all, shows the presence of other metals, as iron, copper, manganese, especially in stannite. It will therefore be very difficult to distinguish the color and shades, since they become mixed; the skilful method is to begin with a mere speck of the assay and turn on the O. F. and then add a little more, watching the bead with great care, as frequently certain tints will, in the progress of oxidation, reveal themselves to skilful

manipulation as they will not when a larger quantity is used at first. However, for detection of the associated iron, copper, or manganese, resort must be had to chemical test. The best flux is one of equal parts of borax, or sodium carbonate, and cyanide of potassium, upon the charcoal before the I. F. of the blowpipe.

As *stannite*, in small pieces in a glass tube closed at the lower end, it decrepitates under heat and gives off a little sublimate (tin oxide); in an open tube it gives off the smell of sulphur (sulphurous acid, sulphurous dioxide) and a white cloud of oxide of tin near the assay upon the glass. On charcoal it fuses, gives off sulphur, and the white tin oxide appears on the charcoal. It may be decomposed by nitric acid, and the solution (blue) shows the copper, but the sulphur and oxide of tin are apparent as precipitates.

The geology of this ore is evidently that of the earliest rocks, granite, gneiss, chlorite, porphyry, and where it occurs in Banca in the alluvial soil it seems to have descended from the granite ranges. It occurs in veins, and in Cornwall they run almost always east and west. (Makins.) In Dakota it is found in mica schist mixed with feldspar in the granitic regions, as we have already described. In other places in quartz through granite and the earlier rocks.

**EXTRACTION** for detection. From the *cassiterite* (binoxide) or tinstone, it may be extracted in a small way by melting 100 grains with 20 grains of dry carbonate of soda and 20 to 25 grains of borax in a brasqued crucible. (See p. 77.)

In the larger way and as impure, or *stannite*, as when combined with sulphur, copper, arsenical pyrites, etc., it is



broken into small pieces and separated from quartz and lighter gangue by washing, that is concentrating, on an incline, as the tin ore is much heavier than the usual gangue material. It is then roasted under a low red heat to expel sulphur, arsenic, etc., the iron is left as an oxide (sesquioxide), and the copper as a sulphate with some unaltered sulphide of copper. To further desulphurize the unaltered sulphide it is moistened with water and exposed to the air for some days, after which the whole of the copper may be removed by washing, as the copper sulphate is readily dissolved. The iron may now be also separated by washing, as it is a lighter sesquioxide and is in suspension. The ore now contains about 65 per cent. tin, and it is mixed very intimately with about  $\frac{1}{8}$  of powdered coal and a little lime, or fluorspar to form a fusible slag with the earthy impurities, gradually roasted to prevent the melting of the tin oxide with the silica to form a silicate, from which the metal would be reduced with difficulty. (Bloxam.) If the process is conducted in a crucible, the latter must be covered so as to exclude the air and favor the combination of the carbon and tin oxide, its oxygen going over to the carbon to form carbonic oxide (carbon monoxide). This process requires a low red heat for 6 to 8 hours, and then the tin is found beneath the slag.

The tin thus extracted contains some impurities, as iron, copper, arsenic, sometimes tungsten and wolfram (tungstate of iron and manganese), and in the large way it is purified from the latter substance before melting, by fusion with

carbonate of soda in the reverberatory furnace, thus converting the tungstic acid into a soluble tungstate of soda, which is dissolved out by water and crystallized for sale to the calico printers.

In estimating the QUANTITY of tin in any compound, it is done by reducing the tin to metastannic acid ( $\text{Sn}_5\text{O}_{10}$ ), for in this form it may be separated from almost all the other metals. This acid appears as a white crystalline hydrate, when tin is oxidized by nitric acid, and the process is as follows: A nitric acid solution is made and then evaporated to a very small bulk; by this the dioxide of tin is thoroughly separated. Proceed by washing this precipitate well with dilute nitric acid, and afterward by water. After which it is dried and heated to a low red to drive off the water, for when dried by exposure it has the composition  $\text{Sn}_5\text{O}_{10} + 10\text{H}_2\text{O}$ , but when heated to  $212^\circ \text{F}$ . it becomes  $\text{Sn}_5\text{O}_{10} + 5\text{H}_2\text{O}$ . If more strongly heated, it assumes a yellowish color and a hardness resembling powdered tinstone ( $\text{SnO}_2$ ). Now, to estimate the quantity of tin, this residue is weighed and the proportion is 78.66 of tin to every one hundred parts. According to Fresenius, 78.67 of Sn, 21.33  $\text{O}_2 = 100.00$ .

When lead is present and it is necessary to decide the amount of that metal, it is necessary, after dissolving the compound in somewhat diluted nitric acid under heat, to dilute and filter and wash out the metastannic acid as above, and then to the residue add sulphuric acid in excess and evaporate all down to expel the nitric acid. This causes the precipitation of the lead sulphate which is filtered out,

washed and removed to a porcelain crucible, the filter paper (which contains some remains of the sulphate) is burned on the crucible cap, or in another porcelain crucible, till it ceases to decrease in weight; this weight may be added to the contents of the other crucible, and then all heated till no decrease of weight is found—then weighed and the amount of lead determined from the sulphate of lead; of the latter 68.31 parts, by weight, are lead in every 100 parts of sulphate.

---

## ZINC.

**OCCURRENT FORM.** It is not proved that it has ever occurred native, although so stated.

**HARDNESS,** of metallic zinc, 2.

**GRAVITY,** of metallic zinc, 7.69 (Bloxam), or 7.146 (Makins), 7.2 (Richter).

**COLOR.** Grayish or slightly bluish white, for the METAL; for the ores see further on.

**DUCTILITY,** brittle, both at ordinary temperature and at high temperature, 400° F., but in 1812 it was discovered that a temperature between 200° and 250° F., but more recent experiments give 212° and 302° F., rendered it malleable and capable of being rolled into thin sheets. For this purpose it is necessary that the zinc should not contain iron or lead, the former of which it acquires when melted in iron pots, while the lead is carried over in the distillation of the zinc in consequence of the presence of galena (sulphide of lead) in the ore.

MELTING POINT, 770° F. (773°, Bloxam and Miller).

IMPURITIES. Metallic zinc, as occurring in commerce, frequently contains, as above stated, iron and sometimes lead, but also cadmium, tin, antimony, arsenic, and copper. (Bloxam.) Carbon is also mentioned among its impurities, but Elliot and Storer did not find it in any of the thirteen specimens they examined, although traces of sulphur were always present.

LOCALITIES. The ores of zinc are found in Silesia as calamine (zinc carbonate); Carinthia, electric calamine (zinc silicate); in Belgium (zinc carbonate); in the Mendip Hills, Somersetshire, Cumberland and Derbyshire (zinc carbonate); blende (zinc sulphide) is worked in England.

*United States.* In New Jersey as red oxide of zinc; Saucun Valley, Penn., as silicate and carbonate of zinc; "Smithsonite" or carbonate of zinc, Ueberoth mine near Bethlehem, Penn.; abundant as an ore; at the same place a pale yellow zinc bearing clay is found. Also in Illinois (Collinsville, Peru, and La Salle); Missouri, Kansas, and Arkansas, and in recent borings (1887) at 200 feet depth.

It frequently happens that ZINC SULPHIDE is found in amber-colored streaks and isolated small pieces in places where no zinc mines will probably ever be found. It has been obtained in such small quantities by the author, in the Niagara rocks at Niagara Falls; also in Ohio in the Helderberg limestone, on the Cincinnati and Marietta Railroad near Greenfield, and in various other places. The silicates and carbonates are the most useful ores.

The SILICATE (*Willemite*) appears generally yellow and gray, but sometimes green and even pink. Hardness, 5.5; grav., 3.8 to 4.1. Streak, uncolored. If pure it should contain 72.9 per cent. zinc oxide.

CARBONATE OF ZINC (*Smithsonite*) has a hardness of 5; grav., 4 to 4.5, containing about 64 per cent. of zinc oxide, when pure 64.8. It has a color varying from white to gray, also greenish and brownish-white, translucent and brittle. It is found in Missouri and Arkansas along with the lead ores in the lower Silurian limestone.

ZINC SULPHIDE, or BLENDE, is translucent, having a honey color by transmitted light, though frequently a vitreous and almost metallic appearance by reflected light. Another name, mineralogical, is *Sphalerite*. Hardness, 3.5 to 4; grav., about 4. It rarely appears black, reddish, or green. Streak, white to reddish-brown; always brittle and translucent, sometimes transparent. Of zinc sulphide the proportions are: Zn, 65.06; S, 32 = 97.06; per cent., Zn, 67.03; S, 32.97 = 100.00; Zn, 64.9 (Richter), 65.06 (Fresenius).

UNDER THE BLOWPIPE, BLENDE on charcoal in the R. F. gives a coating of white oxide of zinc, yellow while hot, white when cold. The mineralogist should remember that the fact that zinc oxide is yellow while hot, white when cold, is not always an exclusive proof of zinc, as monazite acts so also, whose composition in part is phosphoric acid, cerium, lanthanum, but no zinc, but very rare, though found in the United States; it also presents an enamel white glass, much like zinc on flaming in borax, although zinc silicate does this without borax and alone. It is called *monazite* from a

Greek word, "*solitary*," because of its rare occurrence. Perhaps the similarity of change under the blowpipe may be due to cerium, which with borax in the O. F. also gives a yellow turning nearly colorless when cold, as in the mineral cerite; but these are so rare that they only need mention. With a cobalt solution the coating in O. F. gives a green color. In open tube it gives off sulphurous fumes and generally changes its color.

CARBONATE OF ZINC, *Smithsonite*, in the closed tube gives off carbonic dioxide,  $\text{CO}_2$ , and if pure is yellow while hot and colorless while cooling. On charcoal with soda acts as blende. If cadmium is present, it gives a deep yellow or brown coating before the zinc coating appears. (Dana.) It is soluble in hydrochloric acid and effervesces. If copper, iron, and manganese are present, they severally give their own reactions, and great care must be exercised if even two of these are present. Iron may be detected by first putting half a drop of nitric acid on the assay and afterward an equally small amount of solution of ferridcyanide of potassium, producing a blood-red color. Copper must be tested in the wet way, as we have indicated under that metal, as also must manganese.

SILICATE OF ZINC (*Willemite*). This must be held by forceps (in a small piece) in the O. F. and then it fuses with considerable difficulty, making a white enamel. On charcoal, either with or without soda, in the I. F. it gives the white coating exactly as in blende and acts with cobalt solution in the same way.

**DISTILLING ZINC.** For chemical purposes it is essential that the zinc be distilled, which may be done in the following way, on a small scale, as recommended by Bloxam: Take a small

black lead crucible, *A*, about five inches high and three in diameter. A hole is drilled through the bottom with a round file, and into this is fitted a piece of wrought iron gas-pipe, *B*, running up in the crucible above the zinc; the piece may be nine inches long and one inch in diameter. Any crevices between the

pipe and the sides of the hole are carefully stopped up with fire-clay moistened with solution of borax. A few ounces of zinc are introduced into the crucible, the cover of which is then carefully cemented on with the same kind of fire-clay with borax solution until all is tight. Keep the crucible several hours in a warm place till all is perfectly dry. It is then placed in a cylindrical furnace with a hole in the bottom, through which the iron pipe may pass as in Fig. 6. A lateral opening, *C*, may be made for a tube connected with a bellows. Some lighted charcoal is thrown into the furnace and when well kindled add coke broken into small pieces. The fire is then blown till the zinc distils freely into the vessel of water *D*. Four ounces of zinc may be easily distilled in half an hour. But for still purer zinc see further on.

Fig. 6.

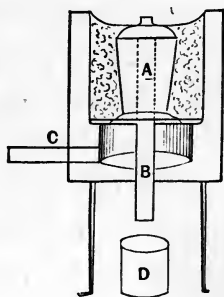

From CALAMINE or BLENDE in the large way by the English method, the ore is treated to a preliminary process

which brings them both to the condition of oxide of zinc. For this purpose the ores are calcined in a reverberatory furnace in order to expel the carbonic dioxide, but the blende is *roasted* for ten or twelve hours, with constant stirring, so as to expose fresh surfaces to the air, when the sulphur passes off in the form of sulphurous acid and its place is taken by the oxygen, the  $ZnS$  becoming  $ZnO$ . The extraction of the metal from this oxide of zinc depends upon the circumstance that zinc is capable of being distilled at a bright red heat, its boiling-point being  $1904^{\circ}$  F. (Bloxam.) This oxide is mixed with about half its weight of coke or anthracite coal and introduced into large crucibles with a hole in the bottom as in Fig. 6. When the mixture in the crucibles is heated to redness it begins to evolve carbonic monoxide, produced by the combination of the carbon with the oxygen from the oxide of zinc. This gas burns with a blue flame at the mouth of the iron pipe, but at a bright red heat the metallic zinc which has been thus liberated is converted into vapor, and the greenish-white flame of burning zinc is perceived at the orifice. When this is the case about eight feet of iron pipe are joined on to the short piece in order to condense the vapor of zinc, which falls into the vessel prepared for its reception. The distillation from crucibles of about four feet high by two and a half feet wide occupies about sixty hours, and the average yield is about 35 parts of zinc from 100 of ore, a considerable quantity of zinc being left behind in the form of silicate of zinc (electric calamine) which is not reduced by distillation with carbon. This zinc, however, is impure and it is therefore melted



again in a large iron pan and allowed to rest, in order that the dross may rise to the surface; this is skimmed off, to be worked over again in a fresh operation and the metal is cast into ingots.

In the Belgian process the zinc oxide is placed in fire-clay cylinders lying horizontally, the vapor being conveyed by a short conical iron pipe, the smaller end projecting out from the cylinder and communicating with another conical iron receiver at its smaller end, and this is emptied every two hours into a large ladle. This method economizes fuel.

In the Silesian process the vapors are received into a short clay pipe instead of iron and it is remelted in clay pots and hence has less iron in the reduced zinc, as melted zinc always dissolves iron and a very small quantity of iron is found to injure zinc when required for rolling into sheets. A small quantity of lead always distills over together with the zinc and therefore it is sometimes remelted near the base of a flue in a kind of pocket or small pit, for, since the gravity of lead, 11.4, is greater than that of zinc, 6.9, the latter rises to the surface and is drawn off, thus relieving the mixture of some lead.

OXIDE OF ZINC when pure is always white, but in the impure results from roasting, etc., it is of varied colors according to the nature of the impurity. The true color of pure sulphide of zinc is also white, and the various shades of the ore are due to the metallic impurities which almost always exist and sometimes to such a degree that the blende has a black appearance and sometimes red, but even then the streak is almost always white, or brownish-white.

Proportion of metallic zinc in the oxide of zinc is—

Zn	65.06	80.26 per cent.
O	16.00	19.74 “ “
	81.06	100.00 “ “

**PURE METALLIC ZINC.** Although by redistilling, and by the use of nitre in the crucible, zinc is supposed to be nearly pure, yet no process gives zinc free from impurities absolutely except the wet process as follows: Dissolve the zinc in pure sulphuric acid, thus soluble zincic sulphate is formed, and an insoluble lead sulphate, if lead be present. Dilute and filter and then sulphuretted hydrogen ( $H_2S$ ) is to be passed through the clear solution; this will throw down the cadmium and arsenic. Separate these and then treat the liquid with carbonate of ammonia in excess, thus the iron is precipitated; if any zinc falls, redissolve by more carbonate of ammonia. Then sodic carbonate is added to the liquid filtered from the iron precipitate; this throws down the zinc as carbonate; this must now be separated, washed, and dried. Next by igniting this in a crucible (porcelain if large enough) pure zincic oxide is obtained, which, if treated, as we have said above, with pure carbon and distilled in a porcelain retort, will yield absolutely pure zinc. The carbon should be made from loaf sugar (heated in a crucible out of air). If any carbon should be present, a second distillation will free it from carbon. The hydrogen made from this zinc is free from all arsenic and may be considered pure. It is the only proper zinc for volumetric analysis.

Zinc salts are not precipitated by  $H_2S$  (sulphuretted hy-

drogen), but a white gelatinous sulphide is precipitated as a hydrate, from neutral or alkaline solutions of zinc, by means of ammoniac hydric sulphide (ammonium sulphide). This is soluble in acids, and is readily oxidized by contact with the air. (Makins.) In regard to this method the following should be remembered and acted upon. Colorless ammonium sulphide precipitates dilute solutions of zinc, but only slowly; yellow ammonium sulphide (see Reagents) does not precipitate dilute solutions of zinc at all. (Fresenius.) Ammonium chloride favors the precipitation considerably. Free ammonia acts to retard the precipitation. With care and the above suggestions acted upon, zinc may be precipitated from a solution containing only the one-millionth part. The filtrate from zinc sulphide is likely to be turbid. The washing is best conducted with water having a small quantity of ammonium sulphide, and continually diminished quantities of ammonium chloride, but entirely omitted at last. The hydrated zinc sulphide is insoluble in water, caustic alkalies, alkaline carbonates, and the monosulphides of the alkali metals. It dissolves readily and completely in hydrochloric and nitric acids, and sparingly in acetic acid. When air-dried its composition is  $3\text{ZnS} + 2\text{H}_2\text{O}$ ; dried at  $100^\circ\text{C}$ . ( $212^\circ\text{F}$ .)  $2\text{ZnS} + \text{H}_2\text{O}$ ; at  $150^\circ\text{C}$ . ( $302^\circ\text{F}$ .)  $4\text{ZnS} + \text{H}_2\text{O}$ . On ignition it loses all its water, but the ignition must not be continued longer than five minutes, nor over a gas blowpipe (Fresenius), or loss will result.

If, in the analysis of zinc ore, the cadmium and arsenic are to be separated, they, as well as all other metallic oxides of Groups V. and VI., may be separated thus: Precipitate

the acid solution of the two (cadmium, oxide of, Group V. from arsenic oxide of Group VI.) with hydrogen sulphide, taking care in the cadmium and arsenic separation to have as little acid in excess as possible. The precipitates consist of the sulphides of all the metals of Groups V. and VI. Wash and treat at once with yellow ammonium sulphide in excess. It is usually best to spread the filter paper with the precipitates in a porcelain dish, add the ammonium sulphide, cover with a glass, and place all upon a sand-bath, or water-bath heated, not exposing to the air. Add some water, filter off the clear liquid, treat the residue again with some ammonium sulphide, digest a short time, repeat the same operation perhaps a third or fourth time, filter and wash the remaining sulphides of Group V. (lead, copper, cadmium) with water containing ammonium sulphide. If tin sulphide be present, the ammonium sulphide must be very yellow or some flowers of sulphur must be added to the ammonium sulphide. If copper be present, it is best to use sodium sulphide rather than ammonium sulphide, as copper sulphide is somewhat soluble in ammonium sulphide. But if mercury is present sodium sulphide cannot be used, as mercury sulphide is soluble in sodium sulphide, but this latter presence (of mercury) is not to be suspected, as no such occurrence has yet been met with in ores.

Add now to the alkaline filtrate, gradually, hydrochloric acid in small portions until the acid predominates; let it subside and filter off the sulphides of Group VI. If it is known that a large quantity of arsenic is present with a small amount of copper, bismuth, etc., the latter may be precipitated by

a brief treatment with hydrogen sulphide which may also precipitate a little of the arsenious sulphide. Filter, extract by dissolving the precipitate with a little ammonium (or potassium) sulphide, acidify the solution and mix it with the former solution containing the larger amount of arsenic, and proceed to treat further with hydrogen sulphide, heating the liquid to about 150° F. as long as any precipitate comes down; in the mixture will always be some sulphur with the arsenious sulphide (if that is all that is present), since the arsenic acid is first reduced to arsenious acid (with separation of sulphur) and then the latter is decomposed. (Rose.) To convert this mixture into pure arsenious sulphide ready for weighing, treat it as follows: Extract, by dissolving with ammonia, the washed and still moist precipitate in the filter, wash the residual sulphur, precipitate the solution with hydrochloric acid, cold, filter, dry, extract any admixed sulphur by dissolving it out and through the filter by adding purified carbon disulphide, dry at 212° F. (100° C.) and weigh. The results are accurate. (Fresenius.) Arsenious sulphide forms a precipitate of a rich yellow color, it is insoluble in water, except as one part to about one million of water, and also in hydrogen sulphide water; it may be dried at 212° F. (100° C.) without decomposition. Red fuming nitric acid converts it into arsenic acid and sulphuric acid. Composition,  $As_2S_3$ ;

$As_2$	150	60.98 per cent.
$S_3$	96	39.02 " "
	<hr/>	<hr/>
	246	100.00

## LEAD.

LEAD is, in some very rare cases, said to have been found native in globules, or small scales, but of no practical value. In **HARDNESS** it is 1.5; **GRAVITY**, when pure, 11.445 (Dana), 11.35 (Makins); its order in **ELECTRICAL CONDUCTING POWER** is 8, silver being 1, copper 2, gold 3. **HEAT-CONDUCTING POWER** 9, among the metals (1) silver, (2) gold, (3) copper, (4) aluminum, (5) zinc, (6) iron, (7) tin, and (8) platinum. And in **MALLEABILITY** it ranges 10; **DUCTILITY** 12; **TENACITY** 11, when in addition to the above-mentioned metals we add palladium, cadmium, and nickel. **FUSIBILITY** 617° F. (325° C.).

The only abundant lead ore is **GALENA**, mineralogical name *galenite*, a lead gray brittle ore, described hereafter, but it occurs in various associations as carbonate, phosphate, arsenate, and sulphate, rarely worked as ores. As a mineral it is found as antimonate, chloride, oxide, tungstate, molybdate, vanadate, chromate, seleniate, and in some very rare and unimportant forms. The only practical advantage in examining these rarer forms is that it may lead to the discovery of the useful ores, and hence under the blowpipe we have described the action of these lead compounds as a class.

The **GEOLOGICAL HORIZONS** and **OCCURRENCE** of lead are, specially galena, in limestones of the Lower Silurian era, especially the Trenton, also in millstone grit. It is associated frequently with zinc (blende), iron and copper pyrites, also with calcite, as in New York State. Its form and cleav-

age (as galena) are generally cubical, rarely octahedral in the United States, but frequently in England.

It is found in extensive deposits in Illinois, Iowa, Missouri, Kansas, Wisconsin, and in New York and New England, also in Pennsylvania, Virginia, Tennessee, Michigan, but chiefly in Colorado (Leadville), where 141,450 tons of ore were produced in 1883, Utah, Nevada, Idaho; besides these there are many individual producers turning out more than 2000 tons of ore a year, not mentioned in the above account. New Mexico turned out 6000 short tons of lead in 1884, and Arizona 2700 in the same year. Large quantities of lead are produced in the working of silver leads, for it is thought that no galenas are found without silver, although one author says:—

“We keep two hand-specimens as special curiosities. Both are from Northern Lake Superior and look exactly alike. One of them contains silver, \$4500 to the ton; the other contains none. There is very little earthy matrix in either case; but in the former it is carbonate of lime, in the latter it is silex or quartz.”

Then, again, a galena in calcareous spar from this same region showed the faintest trace of silver. In one instance a sulphide of zinc and lead from the north side of Thunder Bay, Lake Superior, yielded \$4600 per ton. In another, not far off, a silicious rock with carbonate of lime and sulphide of silver gave \$360 per ton. In addition to silver all the galena leads contain more or less gold. Percy says that he has never found a lead ore which did not contain gold. It contains, however, in some cases not more than half an

ounce of gold to the ton even where the amount of silver was 1138 ounces to the ton.

Galena is a crystalline ore, its primary form being the cube, and sometimes with very bright metallic lustre. But it often occurs in small quantities in various associations, where it is useless to expend any money in attempting to work it.

**WORKING ON THE LARGE SCALE.** Before smelting, the ore is assayed to find out the amount of lead present. And the simplest method is by simply fusing the ore in contact with iron, the sulphur of the ore uniting with the iron to form a sulphide. The simplest way is to use a wrought-iron crucible, or when that may not be had to use a clay crucible and introduce wrought-iron pieces (nails, strips, etc.) into the melted sulphide. The fluxes used are some alkaline ones for the dissolving and separation of earthy matters and a little borax. Supposing an earthen crucible is employed, the ore is first powdered and dried. The weight for assay is then taken and 250 grains is a fair quantity to operate upon, but if the ore is not rich as much as 500 grains must be taken. With 250 grains, 350 grains of black flux, or some analogous flux, for example, a part of powdered argol with 7 of sodic carbonate, and of this mixture about 150 grains might be used. A clay crucible having been heated to dull redness the mixture is introduced; about 50 grains more flux is now put in, then a few pieces of good iron (horse-shoe nails are considered excellent). Lastly, about 60 or 70 grains of fused borax are put upon the top of all. Of course if 500 grains are used the proportions would be accordingly



increased. The crucible is then placed in a wind furnace and heated gradually to full redness for about ten minutes, after which the remaining iron is removed, the whole allowed to cool, when the pot is broken and the mass struck a sharp blow on the side with a hammer; this compresses the button and breaks the slag, detaching it. Or, if all can be poured, it may be poured into a mould with care that no metal remains adhering to the crucible. An iron crucible or deep dish of iron is thought to be better; in such a case no strips of iron or nails are used. A dry assay may be made without iron in the following way: The dried and weighed assay is mixed with three or four times its weight of dry potassic carbonate. This is put into a small clay crucible and covered with a layer of dry common salt. It is next introduced into a muffle and heated to a high temperature for half an hour. A button of lead will subside, which on removal of the slag may be weighed. But this requires more attention and time than the iron method.

IN THE WET METHOD the lead may be converted into the sulphate thus: Powder the ore, dry and weigh off twenty-five grains. This is treated with strong nitric acid. When decomposition ceases a few drops of strong sulphuric acid are added, and it is to be evaporated until all the nitric acid is driven off. This may be done in an evaporating porcelain dish on the sand-bath. The metal will thus be converted into sulphate. The mass is next digested in water to dissolve out soluble sulphates, and the insoluble residue filtered out and washed with water containing a little sulphuric acid. The insoluble matter is next dried, ignited in a small porce-

lain crucible and weighed. It is next removed and digested in a solution of tartrate of ammonia or of acetate of ammonia, added in successive portions; this will dissolve out the plumbic (lead) sulphate, leaving any baric sulphate with other insoluble bodies, as the oxides of tin and antimony, quartz, etc. The part undissolved of the whole is again filtered out and well washed with boiling water, and again dried, ignited, and weighed. The difference between the two weighings is the amount of plumbic sulphate which was present in the first weighed matter and from this the weight of lead may be calculated. The composition of lead sulphate is—

PbO	223	73.60 per cent.
SO <sub>3</sub>	80	26.40 “ “
	<hr/>	<hr/>
	303	100.00 “ “

Of the PbO 92.83 per cent. is lead or 68.32 per cent. of lead sulphate.

The quantity of lead having been determined, the lead ores are picked over, sorted to obtain the richest and separate the barren parts; it is then crushed, washed in order to concentrate, and then placed upon the hearth of the reverberatory furnace and carefully and evenly heated, not to melt, but with free access of air, to change the lead sulphide into lead oxide and sulphate by the oxidation of both the lead and sulphur of the galena. The portions so changed react upon some unchanged ore, and the sulphur and oxygen being just in the proportions to produce sulphurous anhy-

dride ( $\text{SO}_2$ ) this gas is formed and evolved and the metallic lead set free.

Where the ore contains much silica this process would be attended with much loss of lead from the union of the lead with the siliceous matter. In this case the process with iron would have to be resorted to.

The fumes or gaseous constituents passing off from lead ores consist largely of arsenious acid as well as sulphurous anhydride, and the solid particles frequently passing off are ashes, carbonaceous matter, ferric oxide, but more important are the lead sulphide, sulphate, oxide and carbonate, and generally more or less of silver or what might be called volatilized lead compounds. Besides the poisonous effect on the atmosphere, great loss occurs, as high in some cases as one-seventh of the product. (Makins.) To prevent this loss, after many experiments, nothing seems yet so efficient as the long flues sometimes, as in zinc works, running great distances.

Experiments have been made with blowers, or what in this case may more properly be called "exhausters," which have proved worthy of mention because the experiments have been so far successful. The principle is to draw the air in such volume through "ways" or horizontal, or winding shafts, or chambers by means of these exhausters, as in reality to take the place of the vapor stack and create a strong draft.

In some experiments performed by means of the Sturtevant blower, we were not entirely successful because the exhausting power, or even the blowing power, was not sufficient to overcome the necessary resistance, and while for

some very small furnaces it worked well, would not act continuously for larger, as we found during experiments continued several months. But the power of the Roots' blower is quite sufficient to allow a resistance of several pounds to the inch and yet reserve sufficient power to force the vapors to pass through the resisting medium to the stack. In one Western reducing works the blower has been used both as an exhauster and blower—taking the vapors from the furnaces and driving them through water into an exhaust chamber.

Recent improvements in the Roots' blower render it very likely that it may be used even in such works as the nickel furnaces at Lancaster, Pa., if for no other purpose than to lessen the poisonous qualities of the exhalations.

As the silver in lead ores remains pretty much the same in quantity in the metallic lead as in the ore from which it was made, several processes have been adopted to extract it. Formerly the lead of commerce contained much more silver than at the present day.

Mr. Pattinson discovered that if we fuse lead containing any considerable amount of silver, and then cool slowly, carefully stirring at the same time, crystals will form in the bath and subside to the bottom; and, moreover, these will be much less rich in silver than the original metal was. In order to make practical use of this discovery in the lead works, a series of ten or twelve large iron hemispherical pots are placed each over its own furnace and the silver leads are melted near the middle pot first, stirred and slowly cooled, the crystals of lead removed to the pot on one side and the richer lead to that on the other, and thus the silver is con-

tinually increased until in the extreme pot on one end the lead may have only a half ounce or little over of silver to the ton, while that at the opposite end may contain as high as 640 ounces to the ton. This is called Pattinson's process.

But another process is used in the United States for which Mr. Parkes obtained patents over thirty years ago. In his process lead and zinc are fused together; the object being to avail one's self of the fact that zinc rises to the surface carrying with it the silver and the gold, and the alloy may be skimmed off in that condition as loaded with a very large part of the noble metals. The skimmed-off alloy contains zinc, some lead and nearly all the silver and gold, and it is then subjected to another heating and the less fusible parts separated from the more fusible by a process called *liquation*, and the zinc distilled off as we have described under zinc, and the lead cupelled as also described under gold and silver, and thus the silver which carries all the gold extracted pure, its gold excepted.

In both these processes much lead oxide results, and this is put by itself and reduced with charcoal in a reverberating furnace having a bed, or hearth, on an incline towards a tap hole situated on one side at the back, and raked over to assist the reduction, and the fluid lead allowed to run from the lower part into a pot set outside and then ladled out and cast into pigs.

In the Parkes process zinc is added in the proportion of about one pound up to  $1\frac{3}{4}$  pounds to the ounce of silver in the lead. It is plain that the zinc should be thoroughly stirred in the lead so as to combine with the silver; this

causes so much labor that the process of driving steam into the lead has been adopted with great success. One of the improvements of Parkes's process is the use of superheated steam, which acts, in addition to the advantage just mentioned, as an oxidizing agent to the metals retained by the lead; the watery vapor being decomposed, the oxygen unites also with a small part of the lead and the hydrogen passes off. Percy says that in examining the results of the working of Parkes's process which he witnessed, the lead left retained 10 dwts. of silver per ton; that which had been liquated retained 55 ozs. per ton; while the zinc skimmed contained 225 ozs. 8 dwts. per ton.

Mr. H. O. Hoffman, in the recent report (1885) upon the mineral resources of the United States, p. 462, says that the Parkes process is employed in all the desilverizing works of the United States but one, and with some improvements in particular treatments. The use of steam for stirring, and the use of superheated steam for oxidizing some of the impurities, were patented before 1873 by Condurié.

· LEAD CHARACTERISTICS. Pure lead is soft enough to be cut into by the finger nail. The impurities of commercial lead render it harder and of lower specific gravity, and if repeatedly heated and pressed it gradually becomes harder. It shrinks on cooling, is readily acted upon by acetic acid, but not by cold hydrochloric or sulphuric acid, the action being very slight when boiled with them. Nitric acid dissolves it, nitric oxide being evolved, and the nitrate formed, the acid acts very readily when diluted.

· Pure water containing air (that is, unboiled water) acts

upon lead to produce the carbonate of lead (basic carbonate), and the scale falling off, renewed action will take place until the lead is dissolved, but the presence of bicarbonate of lime prevents this dissolution entirely, and the phosphates, sulphates, and carbonates diminish the corrosion, according to Miller and Daniell. Hence spring waters containing lime carbonates are inactive upon lead, but chlorides, nitrates, and nitrites are particularly injurious, 3 to 4 grains to the gallon inducing solution. If, however, water is boiled so as to expel all air, it is inactive upon lead, although the water may be pure.

One part in nineteen hundred and twenty of lead in gold will destroy to some extent the coining qualities of gold. Platinum with its own weight of lead becomes brittle and granular. Hence a platinum crucible is perforated by fusing lead in it.

Lead cannot be cupelled from platinum, for as the lead decreases the melting point increases till the platinum congeals with lead still remaining.

WET ASSAYS and methods of detection. Sulphide of hydrogen and sulphide of ammonium throw down lead as black sulphide, insoluble in any amount of these sulphide precipitants.

Potash or ammonia throws down hydrated oxide soluble in excess of potash, but not of ammonia.

Alkaline carbonates precipitate a white lead carbonate which is quickly blackened by sulphide of hydrogen.

Sulphuric acid precipitates a white sulphate; this is a

characteristic test. It is thrown down, also, by any soluble sulphate.

Potassic chromate is the most delicate test, precipitating a fine yellow lead chromate in even exceedingly dilute solutions.

Hydrochloric acid, or a chloride gives a white precipitate soluble in excess of potash.

When lead is to be determined quantitatively it is usually precipitated as sulphate, washed, dried, and ignited in a porcelain crucible before weighing, the crucible being covered, as "the sulphate is slightly volatile." (Makins.) In this method the solution of the lead salt should be tolerably concentrated, but the sulphuric acid diluted. This method, however, is not so accurate as adding twice the bulk of alcohol and giving time for the precipitate, then washing the latter with alcohol; it should then be dried, ignited, and weighed. Of this 68.32 per cent. is lead.

The analysis of silver lead requires a solution in nitric acid. Then largely dilute and add a large excess of hydrochloric acid to throw down the silver. The lead chloride is prevented from going down by this dilution and excess of acid.

The Galena assay (wet) we have already given.

We present Mascazzinie's method of assaying lead ore, viz: The ore or other substance is oxidized, and its metals converted into sulphates before reduction, the best agent for this purpose being sulphate of ammonia. The ore is mixed with an equal or double weight of sulphate of ammonia, ac-



ording as it is supposed to be poorer or richer, and the mixture is ignited in a small crucible of porcelain, covered to prevent loss from spurting. The mass, when cold, is treated with boiling water, acidulated with sulphuric acid and muriatic acid. By this means the sulphates and oxides of iron, copper, etc., are dissolved, while lead and silver remain insoluble. This portion is washed by decantation, the washings being passed through a filter. This filter is next dried, and its ashes are added to the dried insoluble portion. It is then mixed with muriatic acid and powdered zinc, in order to reduce the sulphate of lead and chloride of silver. The metallic deposit is washed with water which has been boiled, or acidulated with sulphuric acid, and is then pressed into a compact mass. This is dried and heated with from  $1\frac{1}{2}$  to 2 parts its own weight of a flux composed of 13 grammes carbonate of potassa, 10 grammes carbonate of soda, 5 grammes of melted borax, and 5 grammes of farina. The whole is covered over with dried chloride of sodium, and heat is raised by degrees to redness. When the whole is in a state of quiet fusion, it is submitted for a moment to a higher temperature. This process serves for determining lead and silver in white lead, red lead, ores rich in gold and silver, also antimony, tin, and copper. If, in the assay of ores of gold and silver, the amount of lead is insufficient, pure oxide of lead (litharge) is added.

## MANGANESE.

Manganese (symbol Mn) resembles iron in several particulars, physical and chemical, and it occurs with iron compounds. The metal itself has not yet been applied to any useful purpose. Metallic manganese may be obtained by reducing carbonate of manganese with charcoal at a very high temperature, and the fused mass which is combined with a little carbon (as in cast iron) is freed from its carbon by a second fusion in contact with carbonate of manganese. Metallic Mn is darker in color than (wrought) iron and much harder, brittle, and feebly attracted by the magnet. Spec. grav. 8.013; its geological occurrence is said to be, in one mine, upon the Silurian limestone. It is somewhat more easily oxidized than iron.

WITH THE BLOWPIPE a compound containing Mn, in however small a quantity, is fused on a piece of platinum foil with carbonate of soda, a mass of manganate of soda ( $\text{Na}_2\text{MnO}_4$ ) is formed, which is green while hot, and becomes blue on cooling. The oxygen required to convert the lower oxides of manganese into manganic acid has been absorbed from the air. (Bloxam.) In executing this test turn up the edges of the platinum foil and apply the flame of the blowpipe to the under side of the foil.

ASSOCIATIONS. It is sometimes associated with some silver, though the oxide of Mn remains very high in proportion, as in Montana. At the Nile mine (Butte ores), the Mn de-

creases as the silver increases in the ore. It sometimes contains cobalt, nickel, and rarely zinc. But the chief association is with iron, and its importance is very largely due to the influence which it exerts upon metallic iron and steel.

ITS USES in the arts and manufactures are found in the oxidizing power of its richest ores, which are manganese dioxides, mineralogical name *pyrolusite*,  $MnO_3$ ; *braunite* or the brown oxide,  $Mn_2O_3$ ; *manganite*,  $Mn_2O_3H_2O$ ; *hausmannite*,  $Mn_3O_4$ ; and *psilomelane*, of which the true nature is doubtful, although it is a common ore of manganese in foreign countries and contains as much as 85 per cent. of manganic oxides. There is also a bog manganese called *wad* which has been found in New York, Maine, Missouri, and South Carolina and other States. The most important mines are the Crimora mine at Crimora Station, on the Shenandoah Valley Railroad, Augusta County, Virginia; one in Barton County, Georgia; Woodstock Station, Calhoun County, Alabama; and more recently in Arkansas and in California and Nevada.

Manganese oxides are used for the purpose of furnishing oxygen, and for the production of chlorine for bleaching purposes and for forming bleaching powders. Large amounts are used for these purposes. It is said that one-fifth of the manganese ore mined in the United States is used at Pomeroy and at other places on the Ohio River, in the West Virginia and Ohio salt district, for making bromine. It is also used in glass.

Large amounts of manganese were formerly imported to furnish manganese to the Bessemer steel works.

But other very important ores are those in which manganese forms only a small proportion, but yet an essential part. These are the iron ores containing generally about two to three per cent. of manganese, for the irons made from these ores contain that amount of manganese which seems to exert a purifying power over the steel made therefrom which could not otherwise be obtained.

If pure manganese could readily be obtained, that would be used. But this cannot be had, and therefore a mixture of the oxides of manganese and of iron is made called "spiegel" iron when the manganese is less than 15 or 20 per cent., and "ferromanganese" when it exceeds this percentage.

The ores for this purpose should be highly charged with iron so as to obtain as high an amount of the manganese as possible, as this condition is favorable for the making of the alloy of the manganese and iron; otherwise the manganese inclines to leave the iron for the slag. The best ores, therefore, are those which contain a very large proportion of iron.

As a matter of some importance, but aside from that just mentioned, it is important for the purposes of building that the mineralogist should determine the presence of the oxide of manganese in building stones, especially the sandstones of cream-colored shade, brown, or gray. Wherever particles of manganese oxide exist they are determinable by the blowpipe and the borax bead, as we have already shown, and their presence will always be followed by disagreeable

streaks of dark peroxide running down the side of the stone and disfiguring the building and its ornaments wherever that stone is used. Such blocks should be either refused altogether or placed where dark streaks will not be seen, for although very small specks in the quarry, when placed in the outer walls they invariably increase in size and length after every rain and never fade away.

The analyses for manganese by the WET PROCESS may be found treated upon in connection with iron in the article on Iron. Detection of minute traces of manganese may be made by the following process: Dissolve the compound in a little nitric acid; then add dioxide of lead and boil the mixture, when the least trace of manganese will produce a red tint of permanganic acid.

---

## PLATINUM.

Found NATIVE, but combined with gold, iron, iridium, rhodium, palladium, copper, osmium, and chromite (Dana), and ruthenium and occasionally lead and manganese. (Makins.) Ir, Ru, Rh, Os, Pd, are the platinum metals.

HARDNESS, 4 to 4.5; GRAV., 16 to 19; LUSTRE, metallic; COLOR and streak, whitish steel-gray.

It has been supposed to be slightly magnetic, but this seems due entirely to the iron contained in the magnetic specimens. It is found in fine grains and masses as heavy as 11.57 pounds troy, and one, the largest yet reported, weighing 21 pounds troy, in the Demidoff cabinet.

**GEOLOGY AND OCCURRENCE.** It is found in alluvial districts, but wherever this is the case it seems to owe its presence there to transportation from the earliest rocks. In Russia it is found with chrome-iron ore in serpentine. About 80 per cent. of the world's platinum comes from this source and about 15 per cent. from the gold washings of the Pinto, province of Antioquia, at the headwaters of the Atral River, in the United States of Colombia. In Brazil it is associated with syenite. It has been noticed lately in a quartz vein impregnated with gold-bearing iron pyrites in the Thames gold district, New Zealand. Here it seems to have been in place.

In the United States it has been found in small quantities associated with placer gold, and in some places of the Pacific slope only has it been found in merchantable quantities. It occurs in California at Hay Fork, a branch of the Trinity River, on the North Fork, in Butte County; in the hydraulic mines around Cherokee and Oroville, occasionally for nine parts of gold found here one part is platinum. Also found in Mendocino County, in Anderson Valley, Novarro River, and other places. Also on the beach between Capes Blanco and Mendocino, on the Merced and Tuolumne rivers in that State. Going farther north the amount of platinum increases. On the Oregon coast the proportion of gold to platinum in the placers is sometimes five to one, and in rare instances the amount of platinum equals the gold. Platinum has been reported as occurring in Idaho and in the Black Cañon and on the Agua Fria, in Arizona, though the occurrence in the latter Territory is not well authenticated. Also a consider-

able quantity was brought by a private individual in grains and small pieces to Philadelphia for examination, which was said to have been gathered by him on the Yellowstone River.

California ore sometimes yields the refiner only fifty per cent. of its weight in pure platinum. The following analysis of California ore will give some idea of its associations:—

	Per cent.
Platinum . . . . .	85.50
Gold . . . . .	.80
Iron . . . . .	6.75
Iridium . . . . .	1.05
Rhodium . . . . .	1.00
Palladium . . . . .	.60
Copper . . . . .	1.40
Osmiridium . . . . .	1.10
Sand . . . . .	2.95
	101.15

The osmiridium (iridosmine) is an alloy of osmium and iridium, which is separated by its insolubility in nitro-hydrochloric acid. The sand mentioned contains quartz, chrome-iron ore, hyacinth, spinel, and titanite iron. (Williams.)

The production of platinum in the United States during 1883 is estimated at 200 troy ounces and in 1884 at 150 troy ounces. The use of platinum in electric lights (incandescent) has largely increased the demand.

When the proportion of iridium reaches twenty per cent. the alloy is scarcely attacked by nitro-hydrochloric acid.

THE WET PROCESS of analysis. As the platinum metals are soluble only in nitro-hydrochloric acid, the ore may be purified in part by employing the components of this acid suc-



cessively. It is, therefore, first heated with nitric acid; thus any copper, lead, iron, and silver are dissolved. Then, after washing, a second such operation with hydrochloric acid will remove any magnetic iron ore left in it. The ore is now in a fit state to be treated with nitro-hydrochloric acid, made from pure nitric and hydrochloric acids. But, in order to prevent the solution of one of the metals, iridium, it is diluted for use with an equal bulk of water. The proportions Wollaston advises are, to 100 parts of ore as much hydrochloric acid as contains 150 parts of actual (dry) acid, mixed with nitric equal to 40 parts (by weight) of dry, *i. e.*, free from water. Solution will be complete after three or four days' digestion, but towards the end it is always necessary to assist this by gentle heat. The vessel is then set aside, in order that suspended matter, which is almost entirely iridium, may be deposited. The clear solution is then syphoned off, and to it ammoniac chloride, amounting to 41 parts (volume), is added. This throws down a yellow crystalline precipitate, which is ammonio-platinic chloride; this on heating will be decomposed and yield platinum. By this first precipitation about 65 parts of platinum are at once separated from the ore, the weight of the compound salt being, in this case, about 165 parts. About 11 parts of platinum are left in the mother liquor of the crystals, associated with nearly the whole of the other metals. A clean plate of zinc is then put into it which will precipitate them all. This deposit is first washed clean, and then redissolved in aqua regia; and to the solution one-thirty-second of its bulk of strong hydrochloric acid is added, after which more



ammoniac chloride, so as to throw down the remainder of the platinum. This addition of hydrochloric acid last made is for the prevention of the precipitation of any palladium, or lead, with it. But the palladium may be separated at the first, by first neutralizing the solution with sodic carbonate, and then adding mercuric cyanide; this throws down the palladium, after removing which the addition of ammoniac chloride will precipitate the platinum.

As the solution of the ore in aqua regia takes place very slowly, it has been advised, in place of mixing and adding the acids at once, to put the hydrochloric on the ore, and then add the nitric by degrees, as solution progresses; and no doubt acid may be thus economized.

The precipitates of ammonio-platinic chloride are always contaminated with iridium, a portion of which has formed a soluble double salt with ammoniac chloride; therefore they are carefully washed with cold water, which will partially remove this, and afterwards pressed slightly between layers of filter material and then dried.

It now only remains to ignite, in order to separate the ammonia salt; this requires much care so as not to use heat enough to agglutinate the reduced metal, the success of the after working of which mainly depends upon its fine division.

For this reduction it is put into a black lead crucible and heated until only the platinum, in fine powder, is left. This is removed, any lumps broken up, and then rubbed to powder with a wooden mortar and pestle, the rubbing being light so as not to burnish or condense the powder in the

least. This powder is the platinum, and the next movement is to consolidate this mass without melting because of the exceeding heat required. But in the analysis this is not necessary, since it may be filtered out, dried, and weighed.

This process, however, does not entirely eliminate the iridium from the platinum, but while in the arts this is no objection, but renders the platinum less liable to be affected by chemicals, and harder and less easy to melt, yet in analysis the platinum may be needed separate as in completion of the constituents, hence the separation is called for and effected thus: The solution of the two metals is treated with potassic chloride; the precipitate is fused after washing with twice its weight of potassic carbonate. Thus the iridium is oxidized, while the platinum is reduced to the metallic condition. By boiling the whole in water all potash salts are removed, and then, on treating the residue with nitro-hydrochloric acid, the platinum is dissolved, leaving the insoluble iridium oxide untouched by it. If any iridium is yet found in the product, this operation may be repeated. Potassic cyanide solution may also be used for the separation, for, on digesting the precipitate in it, the iridium salt will dissolve while the platinum ore is insoluble.

---

## IRIDIUM.

This metal does not occur unalloyed. It is associated with osmium in different proportions, and in this sense it may be said to occur NATIVE. Mineralogical name *Iridosmine*. HARDNESS 6 to 7; GRAV. 19.3 to 21.12. (Dana.)

LUSTRE metallic, and COLOR tin-white and light steel-gray. Opaque. Malleable with difficulty.

Its name is derived from the various colors of its compounds, which are green, blue, and yellow. The protoxide,  $\text{IrO}$ , in solution in potash becomes blue when exposed to air, from the formation of the binoxide,  $\text{IrO}_2$ . The teroxide is green. Iridium resembles palladium in its disposition to unite with carbon when heated in the flame of a spirit-lamp.

The following table exhibits a general view of the analytical process by which the remarkable metals associated in the ores of platinum may be separated from each other, omitting the minor details which are requisite to insure the purity of each metal. (Bloxam.)

*Analysis of the ore of Platinum. Boil with aqua regia.*

Dissolved: PLATINUM, PALLADIUM, RHODIUM. Add chloride of ammonium.		Undissolved: IRIDIUM, OSMIUM, RUTHENIUM. Chrome iron, Titanic iron, etc. Heat in current of dry air.				
Precipitated: PLATINUM as $2\text{NH}_4\text{Cl}, \text{PtCl}_4$ .	Solution: Neutralize with carbonate of soda; add cyanide of mercury.		Volatilized OSMIUM. as $\text{OsO}_4$ .	Carried forward by the current: RUTHENIUM as $\text{RuO}_2$ .	Residue: Mix with chloride of sodium, and heat in current of chlorine. Treat with boiling water.	
	Precipitated: PALLADIUM as $\text{PdCy}_2$ .	Solution: Evaporate with hydrochloric acid. Treat with alcohol. Insoluble RHODIUM as $3\text{NaCl}, \text{RoCl}_3$ .			Dissolved: IRIDIUM as $2\text{NaCl}, \text{IrCl}_4$ .	Residue: Titanic iron, Chrome iron, etc.

Neither rhodium nor iridium is attacked by nitro-hydrochloric acid, unless alloyed with platinum.

The geographical distribution of this metal is quite wide; it is found in foreign countries, in Russia, East India, Borneo, South America, Canada, Australia, France, Germany, and Spain. The principal source is in the Ural Mountains, in Russia, associated with platinum and gold, and the association in chief is with platinum and osmium, as platiniridium and osmiridium, in the former of which the iridium amounts to 76.80 per cent. and the platinum to 19.64, in the osmiridium the iridium is 55.24 per cent., the platinum 10.08, while the osmium is 27.32 for the Ural specimens.

In the United States, this metal is found in California and Oregon, and in Williams's report it is stated as found quite abundantly in the river sands of the northern counties of the former State. Considerable quantities accumulate in the mints and assay offices, obtained from the crucibles in melting placer gold.

Iridium ore is a source of great annoyance when mixed with gold dust on account of its specific gravity, which is about 19.3, being nearly the same as that of gold. Consequently, it is impossible to separate the gold from the iridium by the process of washing, but as neither iridium nor its ores combine with mercury, the gold may be amalgamated and the iridium remain behind. Or the gold may be separated by solution in aqua regia, which has no effect upon iridium.

In the mints these metals are frequently separated in the crucible by allowing the melted gold to stand for some time when the iridium settles and the gold may be poured off.

The gold in the dregs is dissolved and the iridium remains. In the San Francisco mint 150 to 300 ounces of iridosmine are accumulated annually.

It is supposed that the iridium which was claimed to have been melted by the older chemists was alloyed, since the iridium of the present day is not of the same nature "ductile" and 18.68 for gravity as then reported, but extremely hard and 22.38 in gravity.

The important discovery of Mr. John Holland, of Cincinnati, Ohio, that a combination of phosphorus and iridium could be made by heating the latter to a white heat and adding the former, has made it possible to melt iridium in a crucible and pour the iridium into ingots. This iridium, which contains about  $7\frac{1}{2}$  per cent. of phosphorus, has the physical properties of the iridium without the phosphorus, so far as hardness is concerned, and can be remelted at a white heat. But in its fusibility it cannot be used for some purposes before the phosphorus is removed. This is done by heating the phosphorus-iridium in a lime crucible within an electric current. By this means the phosphorus is entirely removed.

The natural grains of iridosmine are used for pointing gold pens. These are soldered on the points and cut down to shape by diamond, or corundum, dust, upon the edge of a copper wheel rotating about 3000 revolutions per minute.

Many other uses are now being made of this metal, all dependent upon the facts of its exceeding hardness and its infusibility; its melting-point as pure iridium has been

estimated (Violle), at 1950° C. and platinum at 1750° C., or 3542 F. and 3182 F. respectively.

Iridosmine as it comes from the mines, having been thoroughly washed and free from "black sand," is worth from \$2 to \$5 per ounce, pure iridium being worth about \$20 per ounce. Selected grains of iridosmine suitable for pen points have a market value of from \$50 to \$75 per ounce. (Wm. L. Dudley.)

---

## MERCURY.

**OCCURRENT FORMS:** NATIVE, in small globules scattered through its gangue; also in quartz geodes containing several pounds of mercury, at the Prince's Mine in the Napa Valley, California. (Dana.) Also associated with some of its ores, cinnabar especially. (Miller.)

**HARDNESS:** liquid in a temperature higher than—39° Fah.; becomes solid at temperature under—40°F. = 39.44°. (Bristow.)

**GRAVITY:** 13.568. (Bristow.) When solid 15.6, with octahedral crystallization.

**COLOR:** tin white.

**DUCTILITY:** in liquid form elastic; as a solid, malleable and ductile, but not in a high degree.

**COMPOSITION:** mercury, with sometimes a little silver, and sometimes gold. (Crookes and Röhrig.)

**IT BOILS** at 660° F = 349.5° C., but evaporates at ordinary temperature.

LOCALITIES: chiefly at Almaden, a town of La Mancha, in Spain; and Idria, in Carniola; in Wolfstein, in Rhenish Bavaria; in Hungary, France, Peru, and California; small quantities of native metal are found in various other places.

GEOLOGY AND ASSOCIATIONS: the rocks affording the metal and its ores are mostly clay shales, or schists of different geological ages. (Dana.) At Cividale, in Venetian Lombardy, it is found in a marl regarded as a part of the Eocene nummulitic beds—occasionally found in the drift; springs sometimes bear along globules of mercury, as from the Carpathian sandstone of Transylvania and Gallicia. At Mount Idria it occurs interspersed through a clay slate. (Dana.) At Almaden the mercury is said not to form veins, but to have impregnated the vertical strata of quartzose sandstone associated with carbonaceous slates; and in the Asturias the mines are worked in coal strata. (David Page.) The strata in which the Almaden mines occur belong to the upper Silurian; the immediate wall-rock is usually a black carbonaceous slate and quartzite, with which hard, fine-grained, sandstones and slates alternate, but contain no ores. The deposits decline, at the surface  $60^{\circ}$  to  $70^{\circ}$ , then dip almost vertically. They had been opened in 1851 to a depth of 1050 feet, and they strike E. to W. Sometimes in this mine the ore is associated with iron-pyrites and ophite (a tolerably compact diorite). (Cotta by Prime.) Ores of mercury are found in the eastern portion of the Saarbrück coal-basin, in lodes, and as impregnations; in the rocks of the carboniferous formation, in porphyry and amygdaloid. According to Von Dechen, the lodes of the Potz Mountain are in the strata of the carboni-

ferous formation, and such igneous rocks as traverse them. "The general character of these quicksilver lodes and the fact that the ores are almost only found at a moderate depth, distributed in the numerous fissures of the rock, would seem to prove, that most of the ores, especially those of mercury, have penetrated into the fissures by a process of sublimation, and that a tolerably extended district was subjected for a considerable period to these sublimations, in such a manner that the same penetrated wherever a possibility existed for their doing so, and were deposited at a certain level (by a certain temperature), having some choice as to the rocks which they selected." (Cotta by Prime.)

**CHEMICAL CHARACTERISTICS.** Mercury is readily dissolved by nitric acid, and the nitrate is formed with evolution of nitric oxide; if the nitric acid is dilute, the action is slow and crystals are formed of mercurous nitrate.

Sulphuric acid dissolves it with heat, forming a sulphate, and at the same time sulphurous acid is evolved. Hydrochloric acid has no action upon it. It combines directly at ordinary temperatures with chlorine, iodine, and bromine, and it combines readily with gold, silver, tin, lead, bismuth, cadmium and zinc, with some more difficulty with copper and iron. When potassium or sodium is associated with it, it readily adheres even to steel.

Two oxides of mercury are known, the suboxide  $\text{Hg}_2\text{O}$ , and the oxide  $\text{HgO}$ . The suboxide is called the black oxide, or mercurous oxide; the oxide is called the red oxide, or red precipitate, becomes nearly black when heated and is resolved into mercury and oxygen at a red heat. A bright yellow



modification of the oxide is precipitated when a solution of corrosive sublimate ( $\text{HgCl}_2$ ) is decomposed by potash. The yellow variety is chemically more active than the red.

ORES. The New Almaden Mine, in California, is the most important in the United States, and supposed to be second, in product, in the world, Almaden, in Spain, being first. The ore is *cinnabar*, which is a native sulphide, varying in color from dark brown to red, SPEC. GRAVITY 8.2; streak red. Neither hydrochloric nor nitric acid will effect a solution, but a mixture of the two dissolves it, forming mercuric chloride with separation of sulphur. Pyrite, occasionally, accompanies the ore, bitumen is quite common and is intimately associated with the cinnabar. Some native mercury is also present.

The ore is first broken and passed through bar-screens placed about one inch, or inch and a quarter apart, and the sizes of ore passed through in this condition are called *tierras* (or fine ore). The large pieces which do not pass through are picked over and that which contains cinnabar is reduced to less than 9 inches, and these in the quantity are known as *granza*, or coarse ore. But these sizes and sorts are again picked over at the reducing furnaces, changed in size and richness. At the mine the *granza* is often associated with serpentine, and as a whole contains only from 6 to 8 per cent. of metallic quicksilver. The waste is also picked and any sign of cinnabar causes it to be kept, washed, and set out in the weather, and it is called *terrero*, its quicksilver contents being only about 1 or 2 per cent.

The *granza* and the *tierras* are weighed; the *terrero* and

other dump material are estimated by volume, the latter weighing about 85 pounds to a cubic foot and 23.5 cubic feet to the ton.

The method of treatment is adapted to the nature of the above classifications.

In former times the retort process was used, necessitating crushing all the ores in order to mix them with lime, but this was abandoned some years ago, because of the salivation of the workmen caused by vapors and dust arising from and because of the process. Hence attempts were made to roast the ores and condense the quicksilver arising from the combustion. This roasting is performed only in case of the larger poorer masses in cylinder furnaces of the Rumford pattern, vertically kindled with fires at the bottom outside and the ores arranged so that they do not intercept the upper draft or ascent of heat to too great an extent. This is done by placing heavy larger or spent pieces at the bottom of an hexagonal cylinder of sheet iron whose upper half is cylindrical, the lower half only being hexagonal. The lower half is prepared with the fireplaces below, out of the line of the cylinder, vertically, and the draw-holes below for removing the ore when all the quicksilver has been roasted out. The uppermost part is covered with a flat dome at the top with an arrangement for dumping in the ores and covering quickly to avoid the loss of the quicksilver in vapor. The sides near the top are provided with exit pipes for conveying the quicksilver vapors into condensers. This furnace is only for the coarse ores which cannot be treated in the Hüttner & Scott shelf furnace; this we shall

describe. After many experiments and improvements the resultant form remained as follows: The ore body of the furnace consists of a long narrow room running upward to a proportionably high elevation and with openings in the end walls, "pigeon-holes;" from either side wall of this ore chamber project tile shelves to catch the small ore which is thrown in from the top of the furnace or ore chamber. These shelves incline inward to the wall, thus catching the falling ore and throwing it back against the wall. The shelves on opposite sides are not opposite each other, but alternate, so that the ore is more likely in falling to be caught as it falls upon and strikes one shelf by the other shelf opposite, and the distance from one shelf vertically downward to the other varies as the fineness of the ore from three to eight inches. The edges of these shelves lap under each other, so that when they are over full the fine ore slides off and is caught by the lower shelf and pitched back to the wall until too full, when it begins to deliver to the next below, and so on, till the furnace is fully charged, of which fact the workman must judge by peep-holes aided by his experience in charging. When fine ore is fed into the ore chamber through the hopper at the top it runs from one shelf to the next until the column finds support upon the discharge apparatus at the bottom, whereupon the whole column comes to rest throughout the structure. Thus the shelves of the ore chambers are kept covered by an irregular, zigzag column of ore. The end walls of the chamber are pierced with pigeon-holes so that the flames may pass from the fireplace under each shelf and over the ore lying upon the shelf be-

neath to a vapor chamber on the opposite end of the ore chamber. Thence they pass to the condensers. In the first experimental form the flames made only one passage across the ore chambers. The furnace as thus constructed roasted the ores well enough, but the escaping vapors were still quite hot and the consumption of the fuel was considerable. This loss of heat was provided for by arches placed across the vapor chambers and over the fire-box, so that the air and fumes were compelled to make four passages across the furnace on their way to the condensers.

•It will be seen that this method is superior to that of working the fine ore into bricks with clay and roasting, for the making of these bricks, called "*adobes*," caused an outlay of work and expense of about ninety-five cents to the ton of ore which is now entirely unnecessary in the shelf furnace.

In the old intermittent furnaces, only one of which is now used at New Almaden, the chamber is 12 feet long, 9 feet wide, and 17 feet 6 inches high, inside measures, and the charge of ore is 80 to 100 tons, arranged with graded ascent openings in the ore to the top, with channels from the fireplace to the vapor chamber at opposite ends of the furnace. The graded condition is called for by the natural tendency of hot air to roast the upper rather than the lower layers of ore; the channels are made smaller and further apart in the upper layers of ore, and a certain amount of *tierras* and soot from the condensers is added to the coarse ore for the same reason. But the intermittent furnaces are no longer used to treat *tierras*, and the model of the old

Rumford limekiln improved upon at Idria, Austria, by Bergrath Exeli, and in some respects still further improved upon for coarse ore shaft roasting furnaces with exterior firing, is fully explained by Samuel B. Christy in a paper read before the American Institute of Mining Engineers and found also in Williams's "Mineral Resources" in U. S. Geological Survey, 1883 and 1884.

*Characteristics of mercurial compounds.*—If a substance supposed to contain mercury be insoluble, a portion of it may be placed in a hard glass tube and then covered with a thick layer of dry sodic carbonate and subsequently heated. If mercury be present, it will separate and condense in globules in a cool part of the tube. All mercuric compounds are dissipated by heating only. If the suspected body be soluble, a solution of it may be made and into it a strip of clean copper placed. Mercury will be reduced upon it which may be polished to a silvery appearance, and if the strip be afterwards heated in a glass tube the mercury may be sublimed off the copper.

Stannous chloride added may at once throw down a gray precipitate of metallic mercury; but if it do so, the compound contained mercury in the state of sub-oxide. If, on the other hand, the precipitate appears white during the addition of this reagent, and before sufficient of it has been added, the mercury was contained as protoxide. The first white precipitation depended upon the formation of calomel, which latter becomes reduced to the metallic state upon the complete addition of the tin salt.

Potash, soda, or ammonia gives a black precipitate in

salts of the suboxide, insoluble in any excess, but if potash gives a reddish precipitate, and ammonia a white one, the mercury was in form of a protoxide.

Hydrochloric acid gives no precipitate in salts of protoxide, but throws down white subchloride in salts of suboxide.

If to the unknown solution, sulphide of hydrogen, or ammonium sulphide be added very cautiously, and a black precipitate appears at once, it is due to a suboxide; but if the precipitate is at first white, then brown, and at last black, it is from the presence of protoxide. This last, if removed and heated, will sublime as a dark-red cinnabar or vermilion. The sulphides of either oxide are quite insoluble in excess of the above precipitants, or in potassic cyanide.

An accurate method (Makins) for determining mercury in compounds is the following one. The compound is heated with dry lime, being placed in a combustion tube 18 inches long, having at one end a receiver—generally blown in the tube. Into this tube a small plug of asbestos is put close to the receiver end. Then dry fragments of quicklime are added until they reach nearly to the centre of the tube, next the mercurial compound; a carefully weighed quantity of about 20 grains being employed, or ranging from one to two grammes. After this the tube is fitted to its front end with more lime. It is next arranged in a combustion furnace. To the outer end of the tube is connected a small tube from an apparatus for the evolution of dry hydrogen gas; a current of the latter being passed in, the combustion tube is heated to redness by hot charcoal, commencing at the end next the receiver, and carrying it back to the outer end. After the

full decomposition of the specimen, the evolution of the gas is steadily kept up till all watery vapor is driven out; after which the receiver is cut off and weighed with its contents, and again weighed after thoroughly cleansing out the mercury, when the loss will correspond to the weight of the latter. If nitric acid be present in the compound to be analyzed, quicklime cannot be employed, but copper turnings must be used instead. (Makins.)

With soluble compounds of mercury the latter may be estimated as a sulphide. For this the solution is to be acidulated with hydrochloric acid and excess of hydrogen sulphide passed in; allow the precipitated sulphide to subside, and then filter, wash quickly with cold water, and dry at a moderately low temperature and weigh. The drying, however, is more safely and accurately performed under a drying glass with sulphuric acid under the same glass for absorption of moisture, trying the assay on the scales until the weight is uniform.

---

## ANTIMONY.

ANTIMONY. As a metal it is tin-white and volatile, very brittle, and easily reduced to powder. It has been reported as native at Warren, New Jersey, and at Prince William, New Brunswick, Canada, but rare.

Hardness about 3; gravity 6.6 to 6.7. When native, said to be associated with silver, iron, or arsenic. Melting-point 1150° F. (621° C.).

But the chief ores are the sulphide known as STIBNITE, containing 71.8 antimony, 28.2 sulphur, and VALENTINITE, or white antimony, which seems to be derived from the other by the oxidation of the ore. There is also a red antimony or KERMESITE. The first is the usual ore.

STIBNITE occurs both in masses and in crystals, the latter with the sides deeply striated; lustre metallic; often columnar, and color and streak a steel gray, or lead gray, sometimes iridescent. It is sectile, the hardness being only 2 and gravity 4.5 to 4.6.

Before the blowpipe on charcoal it fuses, gives off both sulphurous and antimonial fumes, and coats the coal white with oxide of antimony; the latter, treated by the R. F., tinges the flame a greenish blue. It is perfectly soluble in hydrochloric acid.

It occurs in the United States in very large deposits at San Emigdio, Kern Co., California, where it had been worked for silver many years ago. The vein consists of quartz and gray antimony, and traverses granite rock, northwest and southeast, with a dip southwest of  $64^{\circ}$ . The width of the vein varies from a few inches to many feet.

At the Alta claim in San Benito County, there is a distinctively formed vein traversing a trachytic or plutonic rock. The thickness varies from one inch to twenty-four inches, and the deposits in this region seem to be very great.

Antimony is associated with cinnabar in several places in California.

It has been found in Nevada about twelve miles south of Battle Mountain station, on the Central Pacific Road, in



Humboldt Co. Here the veins are nearly vertical and one hundred feet apart.

Remarkable deposits of *stibnite* have also been found in Utah. Here the antimony occurs just above the junction of the sandstone with the limestone and the conglomerate; and in some places the ore has been found in the conglomerate, penetrating irregularly between the boulders, and without the evidence of any vein formation. One mass of pure stibnite weighed about 3000 pounds, and was sent to Salt Lake and thence to New York. This mass, like most of the ore found in the sandstone, has a very strongly defined radial structure, the crystallization being in close aggregations of long, needle-like fibres, or prisms, which are diverted from central points or nuclei, giving a stellate appearance to the masses, and particularly to the smaller aggregations, some of which are only a few inches in breadth. In the large masses the radial fibres are sometimes 18 inches long, and form dense aggregations of pure ore 8 to 15 inches thick at the large end, tapering to a point at the other end. (W. P. Blake, in the Min. Res. of U. S., 1885.)

It is found in various foreign lands, and recently some very fine crystals have been sent from Japan from the mines in Shikoku to the Yale College collections. It has also been worked in Nova Scotia, Sonora, Mexico; France, Spain, Portugal, Prussia, Austria, Bohemia, Hungary, Italy, and Algeria. In Victoria a lode traverses Silurian strata, and contains about 2 ounces of gold to the ton.

*Extraction.* The extraction of antimony from its ores is attended with some difficulty, owing to its volatility and affinity for oxygen. If the sulphide is much mixed with veinstone, such as quartz, it is subjected to the preliminary process of liquation, by which the fused sulphide flows away, leaving the rock behind. The sulphur is extracted by heating with iron, alkalies, and charcoal, leaving a regulus of metal, or by oxidation, leaving the antimony in the condition of teroxide, which is afterwards reduced with charcoal and alkalies in crucibles. The metal sinks to the bottom, and the overlying residue is known as *crocus of antimony*. (Blake.)

*Uses of antimony.* Antimony is used extensively in forming type metal, the amount of antimony being from 17 to 20 per cent. Britannia metal contains about from 10 to 16 parts, and Babbitt metal, for journals and various bearings of machinery, contains 8.3 per cent. Pewter contains about 7 per cent., and various metallic compounds of softer metals owe their hardness to certain proportions of antimony. Besides, it is used in medicinal preparations, in pigments, and in vulcanization of rubber.

*Estimation of antimony.* A method of quickly making commercial determination of antimony present in ores, alloys or slags, is described by Mr. G. T. Dougherty. "The substance is first reduced to a button by fusion. If in an oxidized state, it is melted with charcoal and argol; if combined with sulphur, it is decomposed by fusion with equal parts of potassium cyanide and sodium carbonate. Ten grains is the most convenient quantity to use. The

weighed button is then cut into small pieces, placed in a porcelain dish, and digested at a boiling heat in a mixture of equal parts of nitric acid and water, until the solution has nearly evaporated and the lead is dissolved, leaving the antimony as a white, insoluble precipitate of antimony tetroxide ( $\text{Sb}_2\text{O}_4$ ), which is separated by filtration from the diluted solution, and is dried and weighed." In a button containing lead and antimony only the quantity of lead is ascertained by deducting the weight of the antimony, or it may be determined from the filtrate as sulphate of lead, as we have shown in another part of this work.

Composition of  $\text{Sb}_2\text{O}_4$ :—

$\text{Sb}_2$	244	79.22 per cent.
$\text{O}_4$	64	20.78 " "
	308	100.00 " "

*To distinguish antimony from bismuth.* Treat a hydrochloric solution of antimony with a quantity of water, an immediate precipitate of an oxychloride falls. This may be dissolved in tartaric acid; the addition of water employed would have prevented the precipitation—it now dissolves it. This solubility in tartaric acid distinguishes it from the analogous bismuth precipitation.

Makins's method of estimating antimony is very satisfactory, as follows: To the hydrochloric solution add a little tartaric acid and then pass in dihydric sulphide (hydrogen sulphide). Thus the sulphide of antimony is thrown down. And now all excess of the precipitant must be got rid of by driving it off at a temperature of about  $100^\circ$  F. Wash,

dry, and weigh the sulphide; having noted the weight, next dissolve it in aqua regia, then mix this with a solution of tartaric acid and precipitate the sulphuric acid (formed by the oxidation of the sulphur of the sulphide) by means of chloride of barium. From the weight of this when washed, dried, and ignited, that of the sulphur is got at and the loss represents the antimony.

*Caution.*—In passing hydrogen sulphide through the hydrochloric solution some basic antimony chloride may remain unless fully saturated, and with gentle heat this secures all as antimonious sulphide.

---

## BISMUTH

Occurs native, with occasional traces of arsenic, sulphur, and tellurium. The chief ore is the native metal.

Hardness, 2 to 2.5; gravity, 9.7. Lustre, metallic. Streak and color, silver-white with a reddish hue. Brittle when cold, somewhat malleable when heated. It crystallizes in rhombohedra, nearly approaching the cube. These may be formed artificially in beautiful masses by melting a quantity of the metal in a ladle or a pot and after removing it into some glowing coals or heated sand, allowing the bulk to cool slowly; and in order to prevent the cooling action commencing at the upper surface, the heat is kept up by covering the vessel with a shallow iron basin into which a quantity of hot fuel is placed. As soon as a crust of metal is presumed to have formed round the sides and top it is

pierced at one side by a red-hot iron and the remaining fluid metal is poured out. If, then, when cold, the upper covering be sawn off, the whole interior surface will be found to have crystallized in most regular forms of hollow cubes and tetrahedra.

Bismuth fuses at  $507^{\circ}$  F. =  $264^{\circ}$  C., and when added to other metals it lowers their melting-points in an extraordinary manner. At a high temperature it burns somewhat like zinc, with a bluish flame, giving off fumes of yellow oxide.

Nitric acid dissolves the metal readily, sulphuric acid only upon boiling, and hydrochloric acid has but little action upon it.

It expands on cooling after fusion to about one-thirty-second of increase in bulk.

*Detection of bismuth.* Its salts are for the most part devoid of color; some are soluble, others insoluble; the soluble salts redden litmus paper.

Dihydric sulphide or ammonio-hydric sulphide throws down a black sulphide, insoluble in excess of either precipitant.

The alkalies, potash, soda, or ammonia, throw down white hydrated oxide. Upon boiling this precipitate it becomes yellow.

Potassic chromate throws down a yellow chromate of *bismuth*, which may be distinguished from the corresponding *lead* precipitate in being soluble in dilute nitric acid and insoluble in caustic potash.

To distinguish it from lead, sulphuric acid or soluble sul-

phates produce no precipitate, and if we evaporate with sulphuric acid in excess to dryness the residual mass will be *perfectly soluble in water* acidified with a little sulphuric acid.

*Under the blowpipe* a salt of bismuth heated upon charcoal with sodic carbonate in the inner or reducing flame yields a bead of the metal, surrounded by a crust of yellow oxide. This may be distinguished from lead by the brittleness of the bead under the hammer. The yellow crust is the sesquioxide and is of a deep orange color while hot, but yellow on cooling.

It occurs in the United States twelve miles west of Beaver City, Utah, in a magnesium limestone, but the entire matter assays only from one to six per cent. of the metal. Also in Granite district, Beaver County. It occurs in several places in Colorado, in Lake City district, and near Golden some rich specimens have been found. Also near Tucson, Arizona, and in Inyo County, California; and some remarkably pure specimens have been reported as found on the flank of Mount Vostovia, Alaska. There is no commercial production of bismuth in the United States as yet, though the prospects are fair, and a producing mine would be valuable.

Metallic bismuth is used in making fusible alloys, as soft solder, plugs for safety-valves, and in stereotype moulds. Also as an amalgam in silvering glass globes. The subnitrate is used under the name of pearl-white as in enamels, in porcelain, in optical glass, and in medicine. The nitrate is used as a mordant.

## CHROMIUM.

The only useful ore of chromium is that known as chrome-iron or iron-stone, which is a mixture of sesquioxide of chromium with oxide of iron and whose composition may be expressed by the formula  $\text{FeCr}_2\text{O}_4$ , but the chromium may in part be replaced by iron and the latter may be partly replaced by magnesium. Aluminum is sometimes present, and silica may be found in the sand ore, or ore containing chromite in the form of small grains. The purest ore is sometimes found in lumps weighing several pounds.

The mineralogical name is *chromite*, which in its typical form contains 32 parts oxide of iron, 68 parts oxide of chromium, but in analysis may contain as high as 36 parts oxide of iron, 39.51 sesquioxide of chromium, 13 sesquioxide of aluminum, and 10.60 silica, which proportions are found in a Baltimore specimen.

Hardness 5.5; grav. 4.32 to 4.56. Lustre submetallic, streak brown, color between iron black and brownish-black. Brittle, sometimes magnetic.

*Before the blowpipe.* In the O. F. infusible; in the I. F. becomes slightly rounded on the edges, and then is found to be magnetic. With borax and salt of phosphorus it gives beads, which, while hot, show only a reaction for iron, but on cooling become chrome-green; the green color is heightened by fusion, on charcoal, with metallic tin. (Dana.)

Not soluble in acids; soluble with heat in bisulphate of potash, or soda.

*Its occurrence* was first noticed, in the commercial way, many years ago at Bare Hill, Maryland, but these deposits became exhausted, and very large deposits were found in Harford and Cecil Counties, Maryland, and in Lancaster County, Pennsylvania. The ore is extremely infusible, but after many improvements the final results, as at present understood, lead to the following treatment: The decomposition of the ore is effected by powdering the mineral by means of good millstones, heating it for some hours in a reverberatory furnace with potassium carbonate and lime in certain proportions, and dissolving out the chromium from the fused mass by water, in the form of potassium chromate, which is converted into bichromate by sulphuric acid. Although this is put down in the text-books as an easy process, it requires great experience and skill to effect results which will make the reductions perfect, and at such rates as will compete in the world's markets. This the skilled firm in Baltimore, Maryland, by its long experience and by devices known to itself is able to do.

Recently deposits of chrome ore have been found in Jackson County, North Carolina, also in Fairfax County, Virginia. But the largest deposits are now found in California, in Del Norte County, in Sonoma, San Louis Obispo, and in Placer counties, and in many other counties of California.

These deposits are not found in veins, but in pockets, and may at any time, in certain locations now rich, become ex-



hausted; hence it is important to keep up the supply by additional discoveries.

IN THE QUANTITATIVE analysis of chrome iron ore the assay should be reduced to the finest powder possible, and time is saved by paying careful attention to this work. Bisulphate of potassium is added in about three times the weight and slowly fused with it in a platinum crucible at red heat; here again patience and long-continued heating must be had until with the smooth glass rod or platinum wire no particles can be felt. Alkaline carbonate will not do, but caustic potassa with one-third caustic soda will in a longer time make a good solution. The fused mass is extracted with water, which dissolves the chromate of potassium together with the excess of potassa; the oxide of iron remains behind, together, perhaps, with a small quantity of the undecomposed ore if the fusion at first was not complete; and this must be separated from the sesquioxide of iron by hydrochloric acid; from the hydrochloric solution the iron is precipitated by ammonia, and the chromic acid in the aqueous solution is reduced to the sesquioxide of chromium by hydrochloric acid and addition of a little alcohol. If the mineral contained alumina, it will be found in the aqueous solution with the alkaline chromate, and it will be precipitated together with the oxide of chromium, from which it is separated in the following way: After taking the weight of the chromium oxide and alumina compound, fuse the mixture as in the case of the chrome iron assay at first; convey the precipitate (obtained by adding ammonia to the solution) containing the two oxides (chromium and aluminum) into a hot concentrated

solution of caustic potassa, and boil the whole down till near solidification; when quite cold, water is added, and the whole of the alumina dissolves without carrying with it a trace of oxide of chromium. (Schaffhaeutl.)

---

## COBALT.

This metal is not used in the metallic state, but when reduced to that state it is usually associated with nickel, since the nickel ores contain cobalt. As nickel is slightly magnetic the cobalt ores are in some cases also very slightly magnetic, but only from the presence of nickel.

The ores are sulphoarsenide (COBALT GLANCE) and tin-white arsenide of cobalt (SMALTINE). ZAFFRE is an impure oxide formed by roasting the ore with twice its weight of quartz sand. The metal itself may be prepared by first roasting the ore at a moderate temperature, in order to get rid of as much arsenic as possible. It is next dissolved in nitrohydrochloric acid, evaporated to dryness, and the residue dissolved in water. The solution is then precipitated by dihydric sulphide; thus, all metals except the cobalt and iron go down. After filtering, the clear liquid is boiled with a little strong nitric acid in order to peroxidize the iron, after which potassic carbonate is added to throw the whole down. Then after washing this precipitate it is digested in oxalic acid, which converts the cobaltous carbonate into an insoluble oxalate, while it dissolves out the iron. After washing the cobalt salt, intensely heating it in a porcelain cruci-

ble will at once reduce the metal. The crucible must be encased in a clay one, as the heat must not only be as strong as can be well commanded, but must also be maintained from three-quarters of an hour to an hour. (Makins.) The heat should be nearly that for reducing iron ore.

Cobalt is a reddish-gray metal, crystalline, with specific gravity 8.95; fusible at a temperature somewhat below that of iron.

Various cobalt minerals have been found where neither the amount of the mineral nor the per cent. of cobalt would pay for the working, but they occur in Carroll Co., Maryland; in Colorado, at Granite, in New Mexico, in Nevada, and at Mine la Motte, Missouri. The important source has been at the nickel mine at Lancaster Gap, Penn. As mined the per cent. of cobalt is only 0.1, and only the nickel associated with it gives any profit in the working.

The only use at present for cobalt is as a pigment—to give color to glass, to correct the yellow color in pottery, and in decoration work.

Attempts have been made to plate with cobalt as with nickel, but they have shown its inferiority, because cobalt plating oxidized more rapidly than nickel and was more costly.

The metallic value of cobalt, nominally, is \$14 per pound. Cobalt oxide has varied from \$2.50 to \$3 for twenty years, except at one period, lately.

Compounds of this metal may be detected under the blow-pipe by the intense blue they give in the oxidizing flame, in borax.

The separation of cobalt from nickel is a very nice operation, requiring care. The solution of the protoxides of these metals must be free from other oxides, those of potassium and sodium excepted; hydrocyanic acid in excess, and then caustic potassa are added; it is then warmed until all is dissolved, when it becomes a reddish-yellow in color. It is then heated to boiling, to expel excess of hydrocyanic acid. A double cyanide of cobalt and potassium is first formed, which is next converted into cobalticyanide of potassium, hydrogen being evolved. The double cyanide of nickel and potassium is unchanged. Some mercuric oxide (red oxide) is now powdered, washed, and added, and the mixture boiled. The nickel is precipitated partly as nickelous oxide, and partly as cyanide, mercuric cyanide being produced and at the same time passing into solution. The nickel precipitate is now washed and ignited, and the residue being a pure nickelous oxide, a dirty grayish-green-powder, is weighed and estimated. Composition,  $\text{NiO} = 59 + 16 = 75$ . Ni 78.67 per cent., 021.33. (Liebig.)

The cobalt in the filtrate may now be determined by first nearly neutralizing by nitric acid, then adding a solution of mercurous nitrate as neutral as possible; a precipitate now falls which is mercurous cobalticyanide; this washed, ignited, and weighed, is pure cobaltous oxide [the per cent. of cobalt being 78.67]. (Wöhler.)

## CORUNDUM AND EMERY.

CORUNDUM when pure is simply alumina, or sesquioxide of aluminum, and emery in its general acceptance is the same with various degrees of associated iron oxide (ferric or ferrous oxide). Corundum in its purest crystalline state is the sapphire when blue, and ruby when red. But the hardness (pure) varies from next to the diamond 9, to (impure) as low as 5, the latter being emery much mixed with magnetite and silica. Its gravity if pure is about 4. Lustre vitreous, sometimes pearly on the basal planes, and frequently, as in North Carolina specimens, showing an opalescent star of six rays in the direction of the axis, especially if dipped in water.

Under the blowpipe it remains unaltered, but slowly dissolves in borax and salt of phosphorus to a clear glass colorless if free from iron. The finely pulverized mineral, after long heating with a cobalt solution, gives a beautiful blue color. It is converted into a soluble compound if heated with bisulphate of potash as in case of chrome iron ore last described.

This mineral is associated with crystalline rock, as granular limestone, or dolomite, gneiss, granite, mica, slate, chlorite slate.

The largest occurrence of emery at present known is at Chester, Mass., but this emery is not rated as equal to the foreign, nor at all equal in abrasive power to corundum,

especially to that now worked in North Carolina at Corundum Hill, Macon County, and in Georgia, Lowndes County, and in other States. In searching for corundum, chlorite is considered a good sign. "As the rocks of the southern corundum field are often decomposed to a depth of from 30 to 40 feet, prospecting is sometimes difficult; but a careful preliminary examination of the surface will often save much useless digging." Hence it is advised to look for corundum neither in the gneiss nor in the chrysolite (?), but along the contacts of the two rocks, and particularly when the two rocks are most altered: if a contact is found, it should be carefully followed and the adjacent rocks closely examined. (T. M. Chartard.) This chrysolite is a term probably for some eruptive rock or hypersthene of grayish-green color, but not the true chrysolite, mineralogically.

Almost all the corundum and a large proportion of the emery of commerce are used for the manufacture of the well-known corundum and emery wheels. The preparation of corundum and emery has for its object the granulation of the material into a series of "numbers" or grades of fineness, ranging from the finest "flour" up to particles of comparatively large size.

The method recommended to test the abrasive power of a corundum sample, upon which its value depends, is by taking a piece of plate glass previously weighed, placing on it a weighed portion of the sample to be tested, rubbing the material on the glass and continuing the operation until the glass ceases to lose in weight, the total loss in weight of the glass giving the abrasive power of the sample. (Chartard.)

The proper way of conducting this test is by using two pieces of glass one to rub with and the other to be weighed, or both may be weighed and the time taken in constant work is also an element in making up a test.

Corundum beds may be considered valuable and the value will increase. The exports of manufactured emery in 1883 were reported in value as \$1857, and in 1887 there were exported emery wheels valued at \$35,290; emery cloth, emery paper, and corundum wheels \$4537; total \$39,827. The imports for the same year were: Emery ore, \$66,601; emery in grains, ground, pulverized, or refined, \$29,833; emery wheels or files, \$1191; total, \$97,625.

---

## PUMICE STONE.

The only deposit of this material utilized in the United States is near Lake Merced, a few miles from San Francisco, California, but the amount mined is very small, not exceeding seventy tons yearly, but of a quality equal to the imported article.

Pumice stone, as imported from the Lipari Islands, is composed of from 70 to 77 per cent. silica, and 16 to 17.5 of alumina with a little (.5 to 1.75) ferric oxide and some lime and potassa. In gravity it is lighter than water and generally of a grayish color, occasionally brownish-gray. Lipari, a volcanic island, twenty-six miles north of Sicily, is at present the great magazine of pumice stone. The value of the importation of this substance in 1883 was \$50,634, decreasing in 1887 to \$26,291.

*Rotten stone*, sometimes known as "tripoli," is a decomposed silicious limestone, not yet discovered in any sufficient quantities for mining in the United States, but is imported from Great Britain, \$2235 worth being entered for consumption in 1886, and \$5556 in 1887. The knowledge of these two bodies must be gained by comparison of samples known with the mineral samples obtained.

---

## INFUSORIAL EARTH.

The composition of this material is chiefly of what may be called the minute silicious skeletons of fossil animalcules (infusoria). The analysis of infusorial earth near Richmond, Virginia, yielded Mr. J. M. Cabell 75.86 of silica, 9.88 alumina, some ferric oxide and smaller quantities of lime, magnesia, potash, soda, and nitrogenous matter. The detection of this earth must be made by use of the microscope, which readily reveals the silicious fossils.

Beds of this earth have been found in many places in California and Nevada, some of which have been proved to be of great extent.

This earth has been used in the manufacture of polishing powders, in so-called "sand soaps" and other deterative soaps, and as an absorbent of nitro-glycerine for explosives, although for the latter purposes it has been imported from Germany. A deposit known as "tripoli" is found on the Patuxent River, near Dunkirk, Calvert County, Maryland. Samples show about 84 per cent. silica, one specimen running over



90 per cent. with about 8 per cent. lime. Work has begun quite extensively upon this deposit.

---

## GRINDSTONES.

This is a fine-grained sandstone differing greatly in texture and hardness in different localities. The principal source of grindstones in the United States is the geological formation known as the Berea Grit, which underlies large areas in the northeastern part of Ohio. Near Grindstone City, Michigan, there is found a fine-grained argillaceous stone, of a uniform blue color, which is in general use for finishing work, especially where a very fine edge is required. Near Marquette, on the shore of Lake Superior, the writer discovered a large quantity of an exceedingly fine-grained silicious sandstone of close texture and had some of it worked up in Ohio, where it was made into small stones of excellent cutting power, and it is probable that as soon as arrangements can be made the material will be more extensively tried. In 1884 the total imports finished and rough were 7056 tons, valued at \$86,286. But the home production was valued as \$570,000 in the same year. In 1887 the imports were \$37,548.

---

## BUHR-STONES.

The leading localities for this stone in the United States are Ulster Co., New York, where the stone known as Esopus

stone is a quartzite of variable texture and hardness; Lancaster Co., Pennsylvania, here called the Cocalico, a conglomerate stone found as boulders scattered over the surface; Peninsula, Summit Co., Ohio, where a white variety of the Berea Grit is worked, mainly for the purpose of grinding oatmeal and barley. Many other places have reported discoveries of buhr-stones of various qualities, but the American stones are not used at all for grinding wheat, but only for the coarser cereals, and for grinding paints, cement, chemicals, fertilizers, charcoal, etc. The imported stones, being finer in grain and much harder, are used for grinding wheat and for all the better class of work. The use of rollers, as a substitute for buhr-stone, is gaining ground with great rapidity, and this may account for the fact that, while in 1882 the value of buhr-stones imported was \$104,034, in 1883 it fell to \$73,685, and in 1887 to \$26,217. The true buhr-stone is a cellular flinty rock having the nature, in part, of coarse chalcedony. (Dana.)

---

## THE DIAMOND.

Diamonds have been found in the following places in the United States: Probably the largest was found at Manchester, Virginia, in some earth dug up by a laboring man, the first public record of which occurs in the *New York Evening Post* of April 28, 1855. The original weight was  $23\frac{3}{4}$  carats, and after cutting it weighed  $11\frac{1}{6}$  carats (*carat*

of four grains). As it is an "off color" and not perfect, its present value is considered only \$300 to \$400.

The first diamond found in North Carolina was at the ford of Brindletown Creek, in Burke County, value \$100. Another was found in the same neighborhood and a third at Twitty's mine, Rutherford County, of yellowish color. A fourth was found near Cottage Home, Lincoln County, in 1852, and of greenish color. Another was found at Todd's branch, Mecklenburg County, of a good white color. Dr. Andrews reports the finding of a black diamond, of the "size of a chincapin," by three persons, who crushed it, believing a diamond could not be broken. He found that the fragments scratch corundum very readily.

The following places may be mentioned in addition:—

Two diamonds found at Portis mine, Franklin County, N. C.

One at head-waters of Muddy Creek, McDowell County, N. C.

Several from one-half carat to over 2 carats, J. C. Mill's mine in Burke County, but some of these were quartz, and one Mr. Kunz found to be zircon.

"The diamonds found in North Carolina are usually found associated with gold, monazite, xenotime, zircon, octahedrite, and other minerals." (Kunz.) Dr. Genth says this *débris* is the result of the old gneissoid rocks, such as mica schists and gneiss, in which graphite is always found. *Monazite* has a hardness of 5 to 5.5 and gravity of about 5, with a resinous lustre, with a brownish or yellowish-brown color, and subtranslucent to nearly transparent appearance.

The composition is phosphoric acid, thorium, sometimes tin, cerium and lanthanum; the mineral is very rare: Under the blowpipe it is infusible, but soon turns gray, and with a little sulphuric acid it tinges the flame bluish-green: With borax it gives a bead yellow while hot and colorless on cooling, and a saturated bead becomes enamel white on flaming, soluble in muriatic acid with difficulty. *Xenotime* has the same general appearance, except that it is opaque, hardness 4 to 5, gravity 4.5; its composition is phosphoric acid and yttria, and acts under the blowpipe as *monazite*, but is insoluble in acids: the crystals are frequently flattened, while those of *monazite* are rather elongated. *Octahedrite* has a hardness of *monazite* and a gravity 4, a metallic-adamantine lustre, color various shades of brown, passing into indigo blue and black; greenish-yellow by transmitted light, uncolored streak, and is in composition pure titanitic acid. Before the blowpipe infusible, but with salt of phosphorus gives a colorless bead which in the I. F. assumes a violet color on cooling. Where any iron is present the color appears only upon charcoal when treated with metallic tin. If made soluble, by fusion with an alkali or alkaline carbonate, in excess of muriatic or nitric acid, with the addition of tin-foil, it gives a beautiful violet color when concentrated, just as in the case of the mineral *rutile*, which has the same composition. See Titanium.

Mr. C. Leventhorpe mentions the finding at his placer mine, in Rutherford County, North Carolina, of a diamond of bad color, which was placed in the Amherst College collection.

One was found in a South Carolina placer by Mr. Twitty, and one, owned by the latter gentleman, from White County, Georgia. Also in Georgia at the Horshow placer gold mine, Racooche Valley, White County, Georgia, several have been found here.

Also in California from Forrest Hill, El Dorado County, found at a great depth in the auriferous gravel. Another at French Carrol, Nevada County. Four have been found at Fiddletown, Amador County, in the gray cemented gravel underlying a stratum of so-called lava, or compact ashes. Prof. Whitney states that diamonds had been found in fifteen to twenty localities in California, the largest of  $7\frac{1}{4}$  carats, found at French corral. Some 13 or 14 have been reported from Placerville, California. At Cherokee flat, some fifty or sixty diamonds have been found, some rose-colored and yellow, and some white, all associated with lava, ashes, or other volcanic matter, zircon, platinum, iridium, magnetite, etc.

A few have been found in the placer diggings in Idaho. One was said to have been found at Eagle, Waukesha County, Wisconsin, having been thrown out from a depth of 60 feet while excavating a well. Two others have been reported as found here. One was found at Nelson Hill, near Blackfoot, Deer Lodge County, Montana, and another near Philadelphus, Arizona.

Diamonds have a gravity of about 3.5. When found they are generally of an octahedral shape, and without any very apparent lustre, hence they must be cut before the characteristic brilliancy exhibits itself. They will bear even a red heat without losing any hardness, or even suffering

injury in any way. While resisting pressure to a remarkable extent, they may, however, be fractured, and frequently diamonds have been splintered, or broken, under the stamp of the gold quartz stamp at the mills. Perhaps one of the best tests of a diamond is its ability to scratch, or wear, the surface of a piece of corundum. The appearance of the diamond in the rough state is so peculiar that nothing but large experience will enable the discoverer of such a diamond to determine its nature. But as corundum is next in hardness to the diamond, the latter in a rough state will show its nature very frequently by its feeling of resistance as well as by its effect upon the corundum surface. But this feeling of resistance is to a great extent only acquired by experience, and hence only the abrasive, or scratching power of the true diamond upon a smooth piece of corundum is a sure test. The octahedral form of the diamond, as sometimes found, is not always to be expected by the explorer, since it frequently occurs in other forms, and sometimes massive in small quantities, and has been found in various shades of color and even black. But we may be almost certain that any perfectly crystalline transparent forms are not those of the true stone, especially if projecting from, or attached to, any rock. Diamonds are found always of a dingy white surface and sometimes like ground or worn glass pebbles, unless they have suffered fracture. Their ability to scratch glass is no proof of their distinctive value as diamonds, and other transparent stones found with the diamonds may do the same, especially the zircon and quartz pebbles.

In the diamond fields of Africa it is said that the richest stones are found in a bed of clay about 200 feet below the surface, and as the claims are about 300 yards square the work is very expensive, for miners attempt to excavate and examine the entire claim, since fine diamonds may be found in any part. This is at Kimberley, Griqua land.





PART II.

MINING WORK AND ARCHITECTURE,

INCLUDING

VARIOUS SUGGESTIONS, WITH DESCRIPTIONS OF ASSOCIATED  
APPARATUS AND MACHINERY.

WITH AN APPENDIX

ON

BORING ARTESIAN, PETROLEUM, GAS, AND OTHER DEEP WELLS.



# MINING CONSTRUCTION AND MACHINERY.

---

## INTRODUCTION.

IN this part we have followed, to a large extent, the plans and suggestions of some of the best English, French, and German authorities and works, but especially the work of Niederist, which, in translating, we have accommodated to methods adopted successfully in our own mines. In some parts of New York and in mines on Lake Superior as well as in the South and in the Colorado and Montana gold mines, a system of mining was formerly pursued, with a view to immediate results, which has been the occasion of great loss of products as well as of time, and has necessitated great labor, in some instances, to put the workings into shape for future operations. The author had photographs and drawings taken as illustrations of these errors; it was thought, however, best not to use them, but to present only the best methods, as the reasons for adopting them would cover all instances of errors and of inferior plans and apparatus and so afford more space for that which might prove more valuable.

The cuts will fully explain all the suggestions and methods presented where the text has not already given descriptions.

## SOME EXPLANATION OF TERMS.

Various names are given to the same parts of mines as well as of pieces of construction, in different parts of the country. These variations are readily learned at the place, and do not cause much confusion to the well-informed. Certain terms, however, are almost universal, and a few of these should be understood before we proceed.

Niederest and other German authors give the German names we have stated, which in some cases are better than the usual English names.

Fig. 7. A gallery, or gangway, is a horizontal, or slightly ascending subterranean entrance into a hill or mountain.

Its beginning, *S*, is called the opening or mouth and is usually understood as the opening to daylight (mündlock or mündung). The upper part is called the roof, sometimes the range (firste or forste); the lower part the floor, or bottom (sohle); both right and left sides are called the side-walls (ulme), and the end of the gallery in the mountain, *t*, is the termination or end of the mine (ort, or vorort).

Every gallery nook which does not open out directly into day, *A, A*, is called by the German miner a *strecke*, and when transportation is the object of such a gallery it is called a run; or course, or way (lauf). It is the Austrian *sohlenstrecke*, or in the Cumberland region of England the *headway*. Sometimes it is called the *heading gangway*, as in the Eastern Pennsylvania coal regions.

If this latter gangway, *H* or *F*, driven in a formation composed of layers, runs at right angles with the strike of the

PLATE I.

FIG. 7.

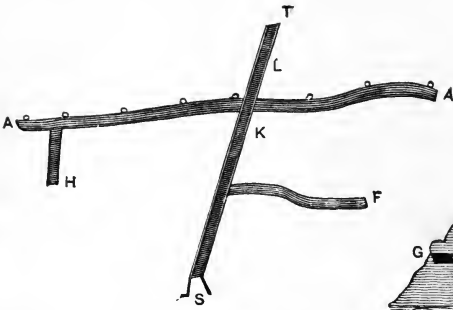

FIG. 8.

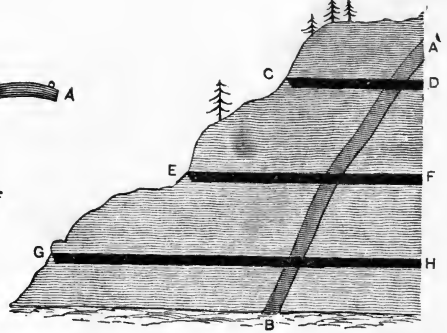

FIG. 9.

A

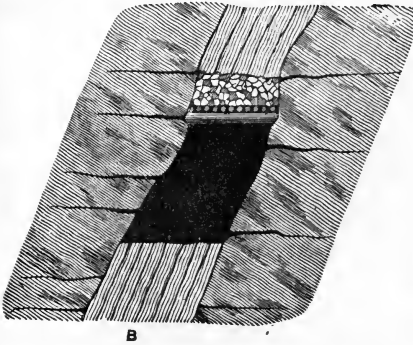

FIG. 10.

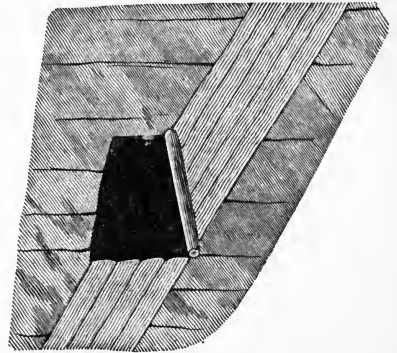
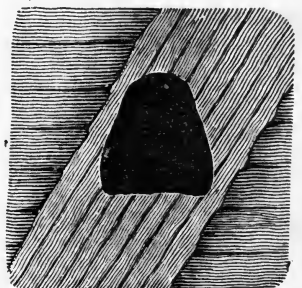

FIG. 11.



FIG. 12.





vein, that is, runs parallel with the dip, or inclination, it is called an inclined drift, or heading (*schwebende strecke*); sometimes in England an “*upbrow*,” or “*drift on the dip*,” and an “inclined drift,” or heading. If it follows the strike of the strata, that is, runs parallel with the strike, it is called a “*strike gallery*,” or “*way run on the gallery*,” and it is called a *diagonal strike* when made upon a line between the two directions above described.

If from a gallery, or gangway, *S T*, a branch, *A A*, sets off sidewise, it is called a *level* (*flügelort*), or when it passes along the strike of the deposit the Germans call it an “*auslängen*” or *side level* or *side way*. If the gallery, or “*strecke*,” runs crosswise into the mountain or bed, it is called a “cross-cut,” and may be either an “overhanging” cut, *H*, or “underlying” cut, *L*, according to the position of the rock as a hanging or lying rock, *i. e.*, hanging or foot rock. When a gallery crosses another as at *K*, or crosses the side level (or *auslängen*), only the term “crossing” is used to express this fact. (See Fig. 7.)

Other terms which are used in this work are generally explained in the text or the figures.

## PRELIMINARY WORK AND CONSIDERATIONS.

Trial shafts or excavations are in some cases necessary before the main work of mining proper begins. In the brown hematite ores these trial shafts are generally made where the country is higher on one side, and the general appearance of the immediate site of the shaft is that of a

shelf or of a basin. In many places these hematites seem to have originated from the washing down of red hematites, and of magnetic ores from higher levels, and the long-continued settling of the hydrated ore upon some knee, or on some basin. In such cases, borings by proper machinery may take the places of regular excavations, as in a shaft.

When, however, the mineral sought for is known to exist in sufficient quantities and determination is settled to begin excavation, the first important examination is to be made of the immediate neighborhood to learn the general level and the nearest distance to some run or rivulet, and such other descents as shall determine the question of drainage if it should so happen that the mine should ever be troubled with water.

A study of the nature of the soil should be instituted with a view to the choice of the material and the quantity to be used in protecting the excavations, and a wise provision made beforehand for the timber, or masonry, which may be called for in course of work.

One of the most important elements of successful mining is accessibility to market. This includes accessibility to those places, furnaces or mills, to which in the nature of the product the ore or rock should be transported before ready for the market. Such methods by river, or rail, or road, should be diligently studied before any true mining work is begun. There is no one point in which economy may be studied with better advantage than in the cost of transportation, both within the range of the works and beyond. Unnecessary grades, bad clayey or rough roads, cost, in the long run,



heavily by delay, breakage, and wear and exhausted power and small amount of carriage, all necessitated by the condition of the way over which products are carried.

When the work of excavating or mining proper is to be begun, a very important consideration to be taken into account is that relating to drainage. In some cases mining may be prosecuted in a region where little water is found. In other cases no exit by gravitation may be had, so that by any grade, water may flow out of the mine; and then the only resort is a pit, in the proper place, to receive the drainage, from which pit the water must be lifted to the surface by some power to be hereafter stated. But in all cases the system of inclination called the grade must be definite and thoroughly provided for at the beginning, and all works constructed and excavations made with a view to this descent, which will be more or less modified according to circumstances.

This grade or descent of the floor is modified somewhat, by the nature of the rock or earth forming the floor, or by its smoothness and the amount of water to be drained. As we shall see hereafter, the drain or sluice through which the mine-water runs may be constructed along the middle of the floor, or on either side, and should always be sufficiently wide and deep to prevent overflowing the floor. The amount of grade or descent will be from one-eighth of an inch to one-half of an inch per yard of length—the former, when the water is not great in quantity, and the channel smooth. Generally, a quarter of an inch to the yard is descent enough. The main gallery is usually constructed along the strike of the

mineral to be mined. The location of the gallery, or limiting of the side walls, will depend much upon the strength, the soundness and the size of the mineral vein, lode or seam to be worked. So also will the number and position of the galleries be determined by the size and location of the vein or seam. It may be necessary to increase the number of galleries, and they will then be distinguished by numbering them as first, second, etc., gallery or "lift"—upper, middle, or lower gallery; according to number and position.

Opening a gallery from the side of a hill, all other things being equal, is preferable, as may readily be seen by Fig. 8.

Here it becomes plain, that there would be an advantage gained for drainage and transportation by "driving" a gallery into the hill-side toward the vein which is represented as slightly inclining or pitching downward from right to left, *AB*.

In opening upon a lode or vein which pitches as above stated, it is always best to begin the galleries, in this case called drifts, near the top of the hill and work toward the lode or vein. The second gallery or drift, below, will be under the first at a distance determined by the softness of the soil, and the amount of vein (on the slope) which can be economically worked. For there must be considerable expense incurred in running these drifts, as they are to be made wide and high, and thoroughly prepared for conveying the material from the mines and for drainage. If the mineral vein can be worked upward from any one drift floor, the distance from the floor of one drift gallery to that one over it may be determined in part by the economic amount of

labor capable of being done upward. As this is strictly a matter of economy it must be studied upon the basis of what may be said hereafter.

All galleries running at right angles to the above drifts must incline toward the drift according to the suggestions on p. 259. They will then be galleries running parallel with the strike of the mineral dip and be worked along the face of the dip or inclined plane.

It is evident that a *slope* might be sunk from the top of the hill, Fig. 8, within the lode  $AB$ , or vein, if the lode was wide enough, and no drifts,  $CD$ ,  $EF$ ,  $GH$ , be made, but only galleries (strike galleries) upon the vein, and along it parallel with the face of the hill, and having the vein as both floor and roof, or they might be only partly in the vein, or the gallery might be outside of the vein entirely. Figs. 9, 10, and 11 will explain.

Fig. 9 represents the gallery entirely in the lode to be worked out. The lode  $AB$  is wide enough for the gallery, the roof is weak, hence it is timbered, as represented. The side walls, hanging, and foot walls are alone strong.

Fig. 10 represents a case where this gallery is partly in the rock and partly in the lode. If the lode is weak, then timber on the side—the hanging rock is strong and you can trust it for roofing; or when the rock pitches timber your soft lode rock, as in Fig. 11, putting the gallery outside of the lode entirely.

Fig. 12 represents the gallery entirely within the lode when the lode rock is the only safe rock, or, as in Figs. 13 and 14, when the rock is not in horizontal strata; being, Fig.

13, partly in gangue rock and partly in the mine rock, but having the hanging rock in a part resting upon the upper timbering. In Fig. 14 advantage is taken of the lode rock for the entire top of the gallery, and the gallery floor is laid upon the outside or gangue rock. In all these cases the miner will be guided in the timbering by the nature of the rock. In some cases the lode will be timbered, in others the outside rock, as in the figures.

In some cases it will be found advantageous to build a gallery parallel with the "pay rock," and yet some eighty or ninety feet off, more or less, according to circumstances, and connect the pay rock with the gallery by offset drivings, *EEEE*, Fig. 15, wherein *AB* represents the pay rock or lode, *CD* the gallery, and *EEEE* the drivings. In this and in similar cases the miner must timber where necessary, and, indeed, either timbering or stone work would be required in such a case as this, for here the pay rock is supposed to be strong and the neighboring rock untrustworthy, and it is desirable, perhaps, to extract all the pay rock.

In general it is advisable to follow all curves in the pay rock or seam by most gradual turns in the gallery, which is the plan above suggested, and may be easily accomplished, as the distance between *AB* and *CD* will allow of curves of greater or lesser intensity even when the pay rock *AB* suddenly changes its course. Thus all severe bends or changes of direction in tramways and other methods of transit, either to or fro along the gallery, unnecessary obstructions to the easy flow of air in ventilation, and other objectionable features of mine operation, may be avoided.

PLATE II.

FIG. 13.

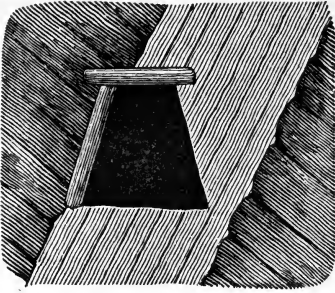

FIG. 14.



FIG. 15.

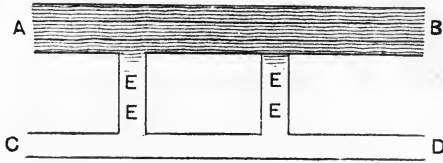

FIG. 16.

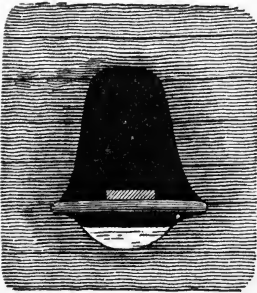

FIG. 17.



FIG. 18.



FIG. 19.

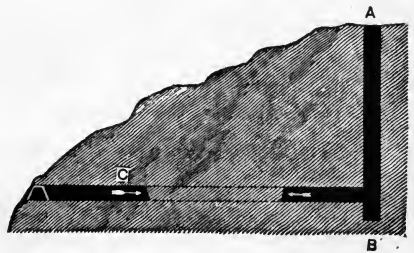



REESE LIBRARY  
OF THE  
UNIVERSITY  
OF  
CALIFORNIA.

In all mining operations more or less water (mine water) may be met with. Sometimes it increases gradually, at other times with more or less suddenness, and the water channels of the earth may be likened to the great system of blood-passages or channels in the human body. In general, where the water enters the excavations in large quantities, a channel may be let into the floor of the gallery and covered, as in Fig. 16. Or, if the water supply is not large, it may be led off on either side, as in Figs. 17 and 18, though in general the water gutter or channel should be made on the side which cuts into the down or lower slope of the rock, as most water is found at that side. Wherever the channel is likely to leak, and it is not thought proper to allow the mine water to escape into the rock, the channel may be either clayed, timbered, or regularly tiled or covered with mason work, as may be found suitable. (Fig. 18.) For here it should be carefully noticed that, as in Fig. 17, where a fissure occurs in the rock, it is always unwise to allow water to run along the drain over such a fissure, for the percolation of water through fissures may lead to extra work in some unexpected direction, and the work of removing or even lifting the same water may be found necessary on some lower level where gravitation may add to the cost of removing that water which now might readily and with little extra pains be carried entirely beyond the mine.

Where expedition is required the miner may run a drift into the side of a hill on the proper grade, and, while a set of men are at work toward the shaft, another set may be

working downward or from the shaft *AB* toward the first set at *C*, as illustrated in Fig. 19.

Between the several galleries built over each other there may be a vertical distance of from 60 to 120 feet thickness, but the lowest gallery may run beneath the level of the water outside, in which case, the water not being able to run off, will accumulate and must be extracted by pumps. Generally the place at the bottom of the main shaft—a square hole several feet deep—is called the sumpt (correctly sumpf), and into the hole all the drained water runs by gravity. The main or principal passage may be called the gallery, and the parallel galleries, above and below, may be called the first, middle, and lowest lift, course, or gangway, as in Fig. 20. Where more than three occur other names are used.

In some mines it is necessary to make many short or long drifts or oreways into the side of the shaft between the usual lifts, and it has been recommended to draw not only the ore and other minerals from these secondary drifts or levels, but also the water, by methods described hereafter, as a means of saving cost upon the process of drawing all waters from the foot of the shaft whither they have been led by all the drains from all passages whatever. Before any steam pumps are placed it would be undoubtedly best to pump all waters and raise all dead (useless) rock and all useful material from the least depth as a matter of true economy. But in the advanced state of pumping machinery, where large pumps can be obtained at all, very little additional cost will purchase pumps capable of forcing water from great depths,



FIG. 20.

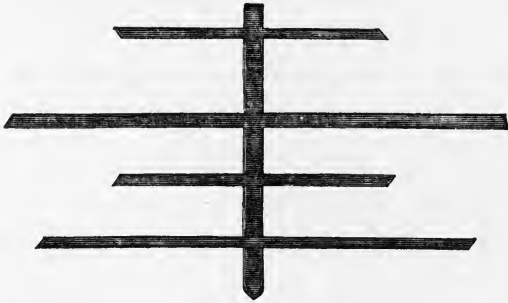

FIG. 21.

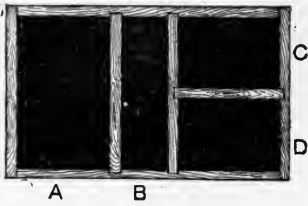

FIG. 22.

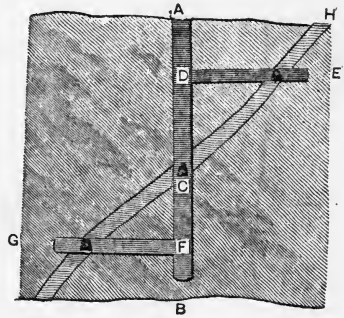

FIG. 23.

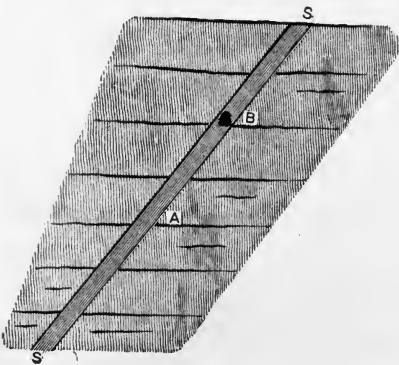
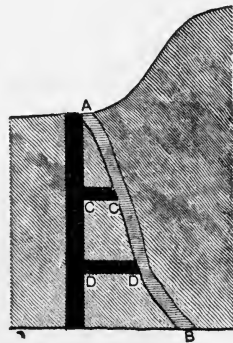

FIG. 24.





where any attempt to save expense by lifting or forcing from two or more levels by distinct pumps would be an expense without any corresponding profit.

Where, from the level nature of the country, no entrance upon the mineral lodes can be made by drifts, or any horizontal passages, it is necessary to adopt, from the beginning, the SHAFT method of reaching the objects of search and of mining. These shafts may be intended for various purposes and may be worked from several points and places both above and under ground in a mine region. They may be for many purposes, but they may be divided into the main, or head shaft, or hoist, and into secondary shafts for the purposes of connecting the ends on floor and roof of two galleries or gangways. In some mines they are worked from below upwards or from above downward, the former being a very dangerous and inconvenient method when the soil is loose, in which latter case it becomes dangerous even to dig downwards, except where the lower gallery roof is sustained by a propped ceiling, when the miner may dig down, making the danger less imminent as he descends, rather than increasing it, as in the former case. When rock is to be penetrated it is possible to drill from below upward and from above downward, although even then it is doubtful in some cases whether it is economical to work upward, and in all cases it is attended with danger from pieces of rock half detached falling upon the workman.

Where the shaft is intended for the entrance of light, and opens to-day, it is called the day-shaft, but such a shaft is rarely opened. Generally, the main shaft towards which all

the underground drains run, is the one at the foot of which is a deep cistern or reservoir into which are received the mine waters and which is called the sumpt, and in many cases it occupies the spot immediately over the "carriage" or box used to let the men down and bring up the ore or coal. It is more out of the way here, and as no one *should* ever stand under the carriage, and no one *can* when it is down, there is less danger of getting into it in this position than if put in any other. Nevertheless, it is plain that when slopes occur, this might not be the only proper or convenient place.

The advantage of the slope over the perpendicular shaft is generally apparent when by the slope we can pass down upon the dip of the vein or along a line lying in the direction of the strike—thus taking out the useful mineral from the opening of the mining work. For it is evident that compared with a shaft there is no economy of time or distance in using a slope to reach the same spot in the mine, as a longer way is to be traversed, which, in a long run, seems to amount to much useless consumption of time and power, and in addition involves loss of material in wear and tear of engine, strain, etc. But there are cases where the slope, despite these disadvantages, is profitable, especially where there is no dead work (work yielding no mineral) in driving the slope, while there may be much in sinking a shaft.

A cross section of one method of shaft-framing may be seen in Fig. 21.

Here, if we assume the general proportions, from 15 to 18

feet long and 6 feet broad, we have a rectangular opening in the rock, or loose earth, divided into four compartments: *A* for the mine water pump, *B* for the ascent of the miners, and *CD* for the raising of material.

This is probably the greatest number of divisions, and an unnecessary amount, for in some of our most important ore and coal mines it is customary to make but two grand divisions, for example, making the *A* division both a pumping shaft and upcast, and of the division *B* both hoist way for material and miners and downcast for ventilation where the ventilation is by furnace. In the latter case, six by ten or eleven feet is usually sufficiently large. But all this may be yet modified by particular emergencies.

In beginning and in the prosecution of a shaft, it is important that after the proper location has been decided upon, the exact vertical direction, or in case of a slope, the inclination should be exactly and continuously preserved. A straight and vertical shaft may be used as both an experimental and permanent shaft, though originally built only to determine the direction of the vein or the slope or dip of the mineral seam; thus in Fig. 22 we have an illustration.

When, however, as partly suggested in Fig. 22, the ore, lode, or seam appears of undetermined angle, it is more economical to sink another shaft, more as a trial shaft, between the surface points *A H*, which will more certainly determine the direction of the slope as the depth will always be much less than at *A*. If successful, the shaft may for some purposes be used to better advantage than the shaft at *A*.

But having sunk the shaft on the vertical line *A B* and

finding the vein when  $C$  is reached, it may be approximately determined from what direction the seam slopes towards  $C$ , and therefore workmen may immediately begin to drive a gallery at  $C$  while others work out a drift at  $D$  toward  $E$ , or at  $F$  toward  $G$ . In a slope the seam or dip would become itself the line of direction for the work, and would determine the angle of inclination of the vein, as seen in Fig. 23.

Here  $SS$  is the slope sunk to  $A$ , having one lift or gallery at  $B$ , and the mine is in course of construction. While the above methods may be suitable in some rocks, in others the lode or gangue may be so unstable or weak as to require for safety and economy that the shaft be sunk as in Fig. 24 and approaches be made to the material to be worked out upon (in this case) the gradually lengthening gangways  $CC$   $DD$ . Especially is this so when the lode  $AB$  is on a very steep incline, as in Fig. 24.

In the coal beds the slope would be put down along the dip of the coal, which would be represented by  $AB$ , Fig. 24.

In opening the shaft in rock or soil it is recommended to begin at a narrow end or the shortest side of the rectangle and blast, or open out toward the other end, always sinking deeper at the beginning that the water may find a little sumpt and be readily pumped out. By reference to Fig. 25, it will be seen that either slope, or shaft, may begin with the same rectangular space upon the surface of the ground at  $AC$ , but the long side will generally be toward the engine or machinery for pumping or raising. The reason will read-

PLATE IV.

FIG. 25.

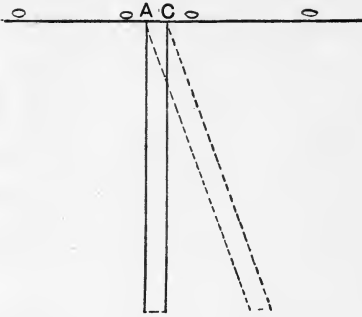

FIG. 26.

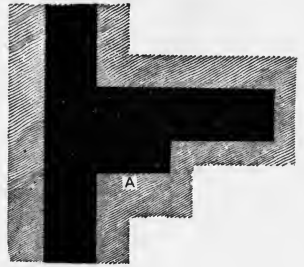

FIG. 27.

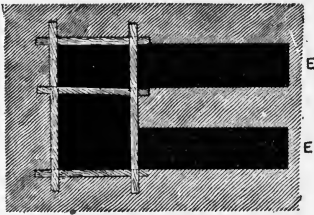

FIG. 28.

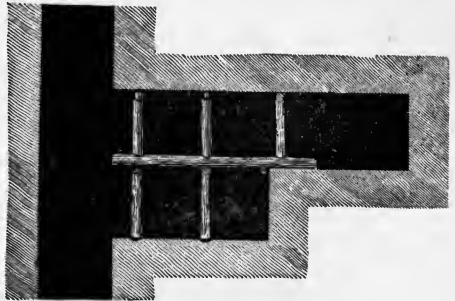

FIG. 29.

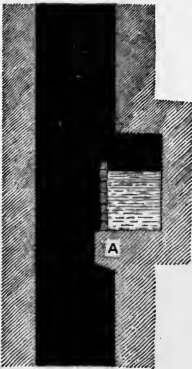
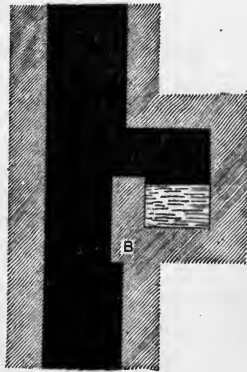

FIG. 30.







ily be seen by noticing the divisions in Fig. 21, for no chains or pump-trunks or pipes should run along the length unless there be some reason compensating for the expense of unnecessarily increased ropes, chains, pipes, etc. After sufficiently descending, the main lift or galleries can be commenced, always giving a fair foothold or start into the gallery before the shaft is continued downward below the foot, or floor, of the newly begun side work. Where there is no special expedition called for, it is better to proceed farther upon the new level, using the shaft bottom, now at level with the cross-cut or gallery, for the place whence either the gangue rock or mineral may be lifted at least until the vein is fairly opened upon, and the cross-cut finished, or dead rock removed.

In some ore-gangways opening into the shaft, it is recommended to lower the level or floor of the gangway at the mouth or opening into the shaft as represented in Fig. 26, *A*, thus allowing a space below the floor level for delivering the ore out of the way of the gallery level where it may be handled before delivering into the shaft.

Where the roof is weak it is advised to sink two side pits *EE*. Put solid timber up in these pits to support the roof, and then remove the intervening embankment for the lowered level. (See ground view, Fig. 27.)

It may be timbered as in the elevation, Fig. 28. The usual timbering may then be made to complete the safety and usefulness of this dumping flat or depression.

The depth of this dumping floor or pit might be five or six feet, and as wide as the shaft. By this pit, ore, etc.

might be kept below the level until all hands can attend to the lifting. This is a German method, but not an economical one in all cases, especially where the ore-cart, running on tramways, may be filled by the miners, run along the gangway to the shaft, and even upon the floor of a shaft-hoist, or cage prepared for that purpose, thus dispensing with all this handling, necessary where the ore is thrown into such a depression at the shaft.

In some shafts where the water is troublesome it is led off from the side walls by inclined gutters or grooves in the rock and conducted into niches or recesses in the side of the shaft as represented, Figs. 29, 30, where it may be retained and from which it may be pumped before going further down.

The abutments *A B* are either of stone or of timber, and the spaces between them and the sides opposite the shafts are made wide enough to allow of the free passage of the buckets, miners, etc. Although cases may occur where this method may be adopted with advantage, it is seldom called for except when an outflow at some particular place might cause trouble in allowing water to fall down the shaft and become a great inconvenience.

As the construction of the shaft and horizontal ways is of great importance, reference is made to other parts of this treatise where this very important art in mining is stated more at large.

#### ON THE OPENING OF MINES.

In order to reap the greatest possible advantage from a deposit of mineral which, after preliminary prospecting, is

deemed sufficiently rich to reward the labor and expense of mining, it is necessary, first, to open and explore the deposit (bed, vein, lode, or mine), that is, to find out its extent, the thickness and richness of the ore or mineral.

As long as a vein, or lode, runs in a well-defined shape and size, in unbroken connection and uniform direction, there is no difficulty in opening and exploring the mine. All that is necessary is simply to follow it. But it is frequently the case that changes and interruptions and diverse departures from regularity occur, and these demand not only a general knowledge of mineral deposits, but some knowledge of the particular country where a mine is to be opened and much careful observation.

The opening, or exploring of a mine, begins really with the work of prospecting and is only a continuation of that work. One of the most important general rules to be observed in opening, or exploring a deposit, is *to follow it to the end in its two main directions, namely, its horizontal direction, or bearing, and its inclined direction, or dip, and this ought to be done, although both the richness and the thickness of the vein decrease.* Another rule is to pay constant and close attention to the general direction of the vein, the nature of the mass composing the vein, and also the nature of the sides. If the vein be thin, or there is danger of losing it, the better plan is to begin in the centre of the exploring tunnel, or shaft, and from that part note carefully every change. The most important changes are: (1) the splitting, forking, or scattering of a vein; (2) the compression, or, as

miners call it, the pinching of the vein; and (3) shifts, or faults.

If a vein divides into several branches, it is best to follow the one which continues in the main direction, more especially if it be the largest, and the surrounding rock, or gangue, correspond to the undivided vein. The remaining branches, or forks, and also any veins, or threads, that may be discovered in either wall, are reserved for a future investigation, and to indicate their location they are cut into to the depth of a few inches.

If a vein becomes thin or pinched, it is best to follow whatever traces there may be in the main direction. Sometimes a vein appears pinched out because the "filling up" (or "pay gangue") leaves the main seam or stratum, and the ore shifts from one side to the other. In such cases it is best to attack the seam in its average direction, and occasionally to work above it as well as below.

When a vein or lode is intersected by another and the continuation of the one that is in process of opening cannot be found in the same direction, and when there is consequently reason to suspect a shift (slide, fault), then the first thing to be done is to examine carefully the intersection, to discover, if possible, from the manner in which the vein enters or combines with the dike or cross vein, on which side the offcast is likely to be found. Should this remain doubtful, then the intersecting dyke or cross vein is to be followed for some distance in both directions, being careful to observe the traces of the gangue rock, closely examining every diverging seam, and following the most promising until

fully convinced that all has been examined. It is sometimes the case that the intersecting (transverse) vein wholly takes up the mineral sought for, so that no offcast or only a very weak one is found; in which case the intersecting vein may itself be worth mining.

In opening a deposit of mineral it must be remembered that a distinction is to be made between the gangue and the ore, for the latter is only a part of the former, still it preserves its own form and direction, which demand special attention. Thus, for example, the lenticular mass of ore  $AB$ , Fig. 31, is at different levels of different thickness or power, as the tunnels  $CDE$  indicate, and because of the rise (inclination) of the deposit, the tunnel and shafts are not continuously in ore, but enter sooner or later into the barren overlying or underlying rock. Of all this the first tunnel, with its upper and lower levels, ought to furnish sufficient data to determine where the limits of the pay ore are and how far it is proper to proceed with the work of opening, so as not to incur useless expense and labor. In general it is a good rule to infer the unknown from what is well known.

The rise (inclination) of the ore requires special consideration in opening a lower or foot drift or adit. If, for example, it were proposed to attack the ore-mass  $AB$ , Fig. 31, by means of an adit (drift) from the point  $F$ , it is plain that the ore would not be reached; but the adit would pass below it into the mountain. Before a foot adit is opened there must be sufficient evidence to show that the ore reaches down as low as the level on which it is intended to drive the adit and that it has not already been pitched away.

To determine where the work of opening a deposit is to begin and how it is to be carried on it is necessary to consider the nature of the ground and the situation of the deposit. If the mountain be steep and the strike of the vein parallel to the slope of the mountain, the shortest way to attack it is by means of a tunnel from the slope to the vein, unless there should be in some ravine close by an outcrop or edge which would make the deposit more accessible. On reaching the deposit by means of a cross-tunnel, galleries are made in it to the right and left and shafts are sunk in the direction of its dip.

If, however, the strike of the vein be across the strike of the mountain ridge, then the work of opening is begun on the line of the strike, and, if possible, at a point where it opens out. There a tunnel is driven along the course of the vein and shafts are sunk. The tunnel is commenced as low down as the known depth of the deposit will permit.

If the deposit to be opened be greatly inclined or if it strike under a plain, it is opened by sinking two inclined shafts at suitable distances from each other in the direction of its fall and uniting them by a gallery. Perpendicular shafts may also be substituted for the inclined, which are sunk in the overlying or hanging rock, provided it be solid, but if not of sufficient solidity and firmness the shafts are sunk in the underlying rock, and in both cases the two shafts are brought in connection with the deposit by means of tunnels, *A B*, Fig. 32. The shafts should be sunk in such a manner as to pierce the deposit at a medium depth.

A deposit or bed, nearly horizontal, which lies under a

FIG. 31.

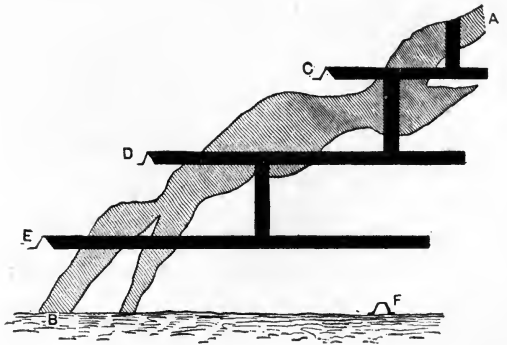

FIG. 32.

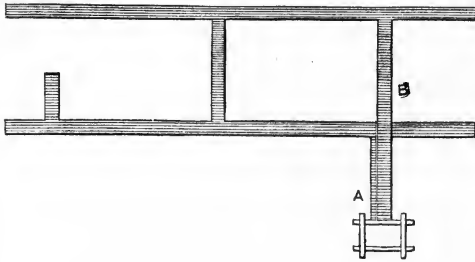

FIG. 33.

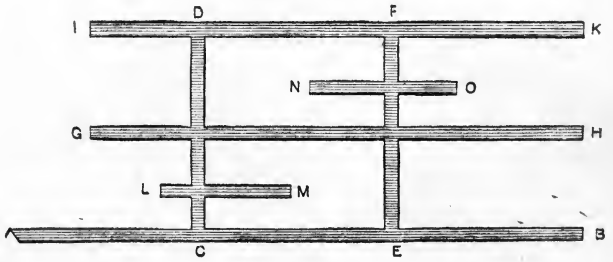
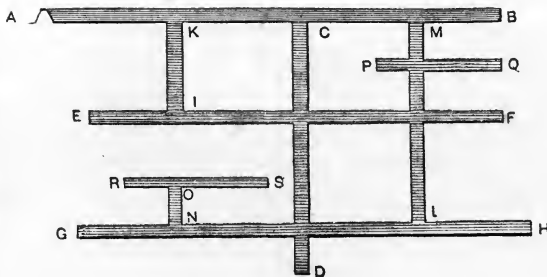

FIG. 34.







plain, is opened by means of two perpendicular shafts, which shall arrive at points in the same line of the dip not in the line of the strike and which are united by a tunnel cut in the deposit.

The opening of large irregular deposits is nearly the same as that of veins and beds; only this is to be remarked that it is not advisable to make shafts pass through standing masses; it is better to put the shaft some little distance away in the barren rock and open the deposit by means of tunnels driven from the shafts.

The nests or kidneys of ore lying separate from each other offer the greatest difficulty in opening and preparing them for mining. The facts by which the miner has to be guided are very few and rather vague. As a general rule these deposits occur in a narrow strip of the mountains and observe a certain direction; in this strip the rock is of a different nature from that outside of it, and the nests, pockets, or detached masses are sometimes connected by slender seams and traces which may serve as guides. Such deposits are attacked by means of a tunnel driven to their lower extremity, or by a shaft sunk in the immediate neighborhood, and they are mined from below upward.

Well-conducted, scientific, systematic mining requires that the opening and exploring of a deposit should always be in advance of the work of extracting the ore. Moreover, it is important not to continue on the first opened level until that be exhausted, but to go down to the lower parts of the deposit as soon as practicable, for in many cases the ore is extracted and the mine exhausted more economically from

below upwards: 1st, because the empty spaces in the higher levels afford free course to the water and thus increase the quantity of that troublesome element which becomes more and more annoying the deeper the mine is worked; 2d, because it is much more difficult to support spaces formed by working from above downwards than the opposite; 3d, because many deposits from their nature are more easily exhausted from below upwards.

In going down to the depth of the deposit necessary provision must be made in time for removing the water from the mine.

Systematic mining also requires that both during the preparatory work of opening a deposit and also during the actual working of it, the foot wall and the roof of the vein should be pierced occasionally to discover, if possible, mineral deposits that may lie on either side of the one that is worked and thus to secure for the mine a long and prosperous future.

One good result of this will be the furnishing of clear knowledge concerning the extent and limits of the metalliferous mass, the extent of the richer ore, and the various changes which they exhibit. In these respects transverse galleries do good service: cross clefts and fissures are also important guides, not only because they save labor, but also because frequently they are either themselves metalliferous or increase the richness of deposits with which they unite.

## FINAL PREPARATIONS AND WORKING OF MINES.

The opening and exploring of a mine are succeeded by another preparatory work, namely, the division of the mineral deposit or matter into smaller portions, and both these labors find their termination in the actual working or "stopping" out the ore. This final work, with the preparation immediately preceding it, is affected very much by the bearing and inclination and by the thickness and regularity of the vein to be mined. Veins, beds, detached masses, etc. require different methods of working. Still there are some general principles common to all the different methods. The deposits to be mined, viewed as general masses, are generally divided into smaller portions by means of levels, drifts, intermediate drifts, etc., and by shafts and wings, and thus the masses are prepared for the more complete extraction of their most valuable material. When a mine is thus prepared the ore is then said to be "*exposed.*" The different levels and drifts and also the wings ought to be at uniform distances from each other in order not only that the mine may present the appearance of regularity, but also because this method aids greatly in taking out the ore with regularity and order, and it renders superintendence and oversight much easier.

Systematic mining requires a thoughtful consideration of a variety of matters. And, first of all, there ought to be established a correct relation between the preparatory work and the extracting of the ore, that is, for every three or four miners engaged in extracting ore that has been exposed to view by previous preparatory work, there ought to be one

miner engaged in this preparatory or prospective work, so that the final work may not follow right on the heels of the preparatory, or, which would be still worse, go on without any such preparatory work.

Again, mining to be conducted judiciously requires that all the exposed ore be not hewn out as soon as exposed, but a part of it, especially that in the higher levels, be held as reserve in order to provide against a time of need, and also that an average may be brought about between higher and lower, richer and poorer ores, which is the more necessary, since the lower we go the greater the difficulty and cost of mining and the poorer or less abundant are the ores. Judicious mining, therefore, does not allow the avaricious taking out of ores which are rich and easily accessible while the poorer ores, or those most difficult to mine, are left neglected, but it seeks to gain the rich with the poor, and, as far as possible, to save all that is valuable.

A mine which is worked without care for the future and without regard for a judicious management of reserves degenerates into what the Germans call a "robbing of the mine." The consequences of such a course are easily predicted: the inferior ores that remain do not justify the expense of properly opening and fitting up the mine, and sometimes not even the expense of extracting them, and the owners must either give up some of their former profits or give up the mine and leave a large mass of useful mineral unextracted.

On the other hand, it is equally important to gain the ore in a mine as easily and cheaply as possible. To secure this

it is necessary to adopt some system with reference to the work and also with reference to the hands employed. As a general rule a stronger force is put to work in the lower levels than in the higher, so that the lowest part of the mine may be soonest exhausted and the cost of keeping out the water and bringing the products to the surface lessened.

It is also a good rule not to scatter the working force over too wide a space, but keep them in a limited field, and when that is finished let it be left forever. In this way a good deal is saved in oversight which is generally very expensive, and more is saved in not having to keep open and in repair long galleries, gangways, or deep shafts, which would require expensive carpentry or masonry.

As to the number of miners to be employed, it is always better to have too few than too many, lest they should be in each other's way.

Finally, suitable provision must be made for a thorough draining or ventilation of the mine, for short and cheap transportation, and for the security of the mine and the lives of the miners, guarding them against being buried alive by the caving in of any portion of the mine, or being burned to death by carelessness or insufficiency of protection in other respects.

#### VEINS AND LODES. HOW PREPARED AND MINED.

After the work of opening and exploring has sufficiently advanced, some further arrangements have to be made to mine the ore to the best advantage.

If the vein be not over twelve feet thick, and preparations

are to be made for mining overhead, then the method will be as follows: From the main gangway or tunnel, *AB*, Fig. 33, we pierce shafts 120, 130, or 240 feet apart, as *CD*, *EF*, Fig. 33; these shafts follow the inclination of the vein, and are made 60 or 70 feet upward. From these shafts we pierce drifts, *GH*, *IK*, and also shorter intermediate drifts, *LM*, *NO*. In this manner we proceed until the next adit or level is reached. In this way the shafts are connected, the vein is explored, the ore is exposed, and ventilation and transportation provided.

Whilst these preparations are made overhead, similar work is done below the floor of the main gangway. Thus, from the gangway *AB*, Fig. 34, a shaft *CD* is sunk either inclined and following the dip of the vein, or perpendicular in the hanging rock; in the latter case cross-tunnels are driven from the shaft until they meet the vein. From those points, or at suitable distances in the incline shaft, drifts are cut along the bearing of the vein, as *EF*, *GH*; then from the lower drift to the upper one, shafts are pierced, as *IK*, *LM*, *NO*, with or without short intermediate drifts, *PQ*, *RS*, and thus the ore is reached. If, during the work of opening the vein as described in the sections on the opening of mines, the extent of the pay-ore has become known, then the shafts are arranged in such a manner that the whole mass to be mined may be divided into equal portions, or the first shaft, opened as *CD*, Fig. 33, is placed in the centre of the field and the other shafts at regular distances on each side.

As soon as this preparatory work has sufficiently advanced the final work of exhausting the mine is commenced. There

are two ways of doing this, either by attacking the ore overhead, or by attacking the ore under foot. The former method is especially adapted for steep veins; the latter method is suitable for either steep or flat deposits.

Mining overhead, or by reverse or ascending steps, as it is sometimes called, may be conducted in two ways. The first consists of leaving a strip *M*, Fig. 35, of vein matter which serves as a floor for the miners to stand on and for holding the rubbish. A more minute description would be as follows: Let *AB*, Fig. 35, represent the main gangway; *GF* is a shaft from which the work is to commence; at the point *C* are placed two miners upon a platform, who commence excavating drifts six feet in height, the one towards *D*, the other towards *E*. They do not commence immediately over the roof of the main gangway, but leave a strip *M*, of from 3 to 6 feet in thickness, which serves as a floor for the drift they are excavating. As soon as these drifts have advanced 2 or 3 fathoms the drifts marked 2 are commenced, then 3, and so on until the next gangway is reached, where again a strip similar to *M* is left and the work proceeds as before.

From the material that is there hewn out the ore is selected and the barren rocks are used for filling up the empty space, or for supporting the overhanging material. The miner stands upon this rubbish, and in order that the smaller pieces of rich ore may not be lost among the rubbish a floor has to be prepared by from time to time filling in smaller pieces.

In order that the ore obtained may be more easily taken to the surface by means of the main gangway there are pierced

through the strip *M*, in distances 20 or 30 fathoms apart, pitfalls *R*, *S*, Fig. 36, kept open by timber casings as far as the rubbish accumulates. In the same manner the shaft *F* *G*, Fig. 36, is treated unless indeed it be deemed expedient to wall it up with rock and use it as a transporting shaft.

The method just described, *i. e.*, the leaving of a strip instead of making a strong frame by timbering, is not always to be recommended. For in view of little thickness the timbering does not cost a great deal, therefore there is no great saving; and in view of great thickness these strips are dangerous unless they are taken very thick, which would involve the loss of a large quantity of ore, for it is generally deemed essential to take the strip three or four times the thickness of the vein. It is only where these veins are to be worked, and where at the same time the gangue is both easily mined and firm, and where wood is scarce that this method would be advantageous.

The other method of working overhead is as follows: The roof of the gangway or tunnel, in Fig. 37, is used as the floor of the first drift, and for this purpose it is prepared with heavy timber or stone arch, *K*, of sufficient strength to support the rubbish *V*. Thus, as the drift marked 1, in Fig. 37, advances from *C*, the timbering or walled arch follows it. If the rubbish rises too high or becomes too heavy, additional supports, as *K'*, have to be provided in order that the entire weight may not be held up by one set of timbers, as at *K*, but be distributed over several as at *K*, *K'*, etc. The side of the shaft taken away is replaced by timber casings, as at *C* *Z*, or a wall is made of the larger pieces of barren rock.



FIG. 35.

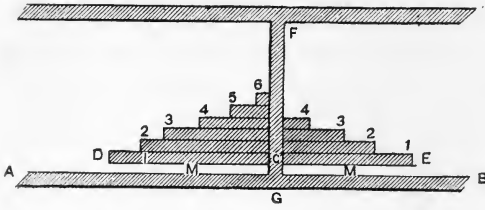

FIG. 36.

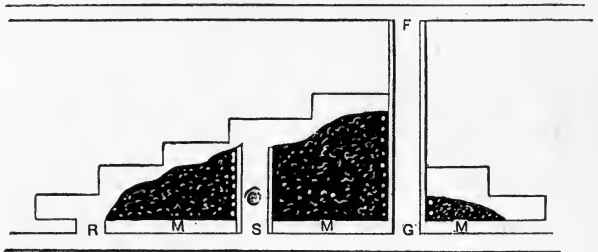

FIG. 37.

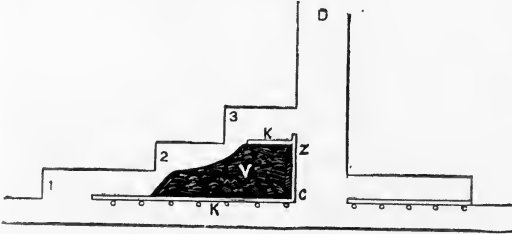
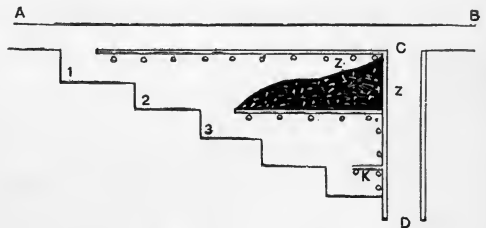

FIG. 38.





Every 10, 20, or 30 fathoms' distance apart holes are left in the roof  $K$ , for the purpose of throwing down the ore as it is hewn out. Large pieces of very rich ore are handed down in sacks or baskets to prevent loss from the rougher mode of handling.

The method of working downwards is simply the reverse of that just described. In Fig. 38, let  $AB$  represent a main level or gangway;  $CD$  is a shaft sunk along the slope of the vein. At the point  $C$  a miner begins to excavate the drift 1. When he has proceeded a few fathoms another miner commences drift 2 and so on. In this way the working presents the appearance of descending stairs. As in the case of the overhead working, so here the work may be carried on on two sides simultaneously. In this method the miners stand not on the rubbish, but on the ore. The ore hewn out in this manner is hoisted up by means of a windlass or in some other way through openings left in the floor of the tunnel, and the rubbish is thrown on timber casings,  $K$ , which are formed between each two drifts and laid securely with heavy timbers.

Since the floor of the tunnel  $AB$  and the side of the shaft  $CD$ , Fig. 38, are hewn away by the first drift, their places have to be supplied by timbers  $Z$ .

In coal-mines this method of working by descending steps has been abandoned, because where the miners stand upon the coal they crush the coal; moreover, ventilation is more difficult and a great deal of timber is required.

In both these methods of mining, *i. e.*, descending steps and reversed steps, the ore presents two exposed sides, one

in front and the other either above or below ; sometimes the miner forms a third. For, if the vein has a selvage or partition rock, easily worked and of little or no value, the miner hews a trench into this and thus frees it from the side rock and then drills holes for blasting or wedging in the ore mass. But if the vein be firmly attached on both sides to the rock the advantage of having the ore exposed on three sides cannot be had unless a trench be made in the ore itself, which, however, ought not to be done if the ore be pure or rich, nor ought holes for blasting to be drilled into such ore. It is better to free the ore-mass by cutting a groove or incision, and then with pick or hammer and chisel, or a very weak blast, the ore is obtained. Each method of working, *i. e.*, by descending steps or reversed steps, has its advantages and disadvantages.

In working by reversed steps the miner has to work overhead, which is inconvenient, but then the weight of the rock assists him, because it is more easily detached from above downward than in the reverse direction. Moreover, less timber is required and the labor of transporting the ore out of the mine is lessened. Still there is considerable loss, because some of the ore will roll among the rubbish on which the miner has to stand.

In the other method, *i. e.*, by descending steps, the work is easier, for the miner works in a more convenient posture and can use water in drilling ; there is also less loss of ore, because there is a solid floor to stand upon. But then more timber is required ; the cost of transporting the ore out of the mine is greater, because it has to be hoisted by means of

a windlass up to the main gallery; and then in mines where water abounds it is difficult to drain the workings properly so as not to inconvenience the miners.

All things considered, the method of working overhead or by reversed steps is the preferable one and is the one generally adopted.

When a vein or lode is not uniformly rich, when the ore is deposited in small detached masses or in pockets or nests, then the method of working is as follows: By means of short tunnels the ore is sought, and when discovered it is extracted by piercing shafts or wings which follow the ore and determine the extent of the pockets and then all that is worth mining is taken out. (See Fig. 39.) Of course entire regularity in such workings is out of the question, still there ought to be some regularity in the direction of the drifts and the distance between them; care must also be taken to secure ventilation and provide for the safety of the miners.

Lodes of more than two or three fathoms' thickness are worked by what is called a cross-work. The lode is prepared for working by making gangways or drivings at *AB*, either in the hanging or lying wall, as in the plan, Fig. 40, which gangways are used for transporting the ore and are heavily timbered. When these preparations are finished cross-cuts or breasts, 1, 2, 3, etc., are marked off. These cross-cuts are made from one to two fathoms in width and one fathom in height, and cut at right angles to the gangway *AB* until they reach the opposite wall, *C*. These breasts are worked in such a way that beside each one that

is worked, 1, 2, 3, or more will remain. For example, first the breasts 1, 3, and 5 are opened and then 2 and 4; or first 1 and 5, then 2 and 4, and finally 3, which has remained as a support for the roof. The breast 5 is then taken as the first of the next division and so on.

While these breasts are worked they are furnished with timber casings if necessary, the rubbish is put at the side of the breast, and the ore taken out into the gangway *A*, Fig. 41.

When a breast reaches the wall the timbers, with the exception of those on the floor, are taken out and the whole breast is completely filled up with rubbish. Where no timbers have been used during the progress of cutting the breast the floor must be covered before it is filled up and abandoned, lest at some future time, when coming up from a lower level, these barren rocks endanger the workings.

Before all the breasts which open on the level *A*, Fig. 41, and which together constitute one story, are attacked, steps are taken to open a second story, *H*, immediately over the first, *T*. For this purpose a gangway, *A'*, is made over *A*, so that the roof of *A* shall be the floor of *A'*. This is also furnished with timber casings, but openings are left in the floor ten fathoms apart through which the ore is cast into the gangway *A*. From the gangway *A'* cross-cuts or breasts are driven through the entire thickness of the vein. After the work has advanced to a certain extent on this story a third story is opened and then a fourth, and so on. But it must be observed that two breasts, the one of which is directly over the other, ought never to be worked at the same

PLATE VII.

FIG. 39.

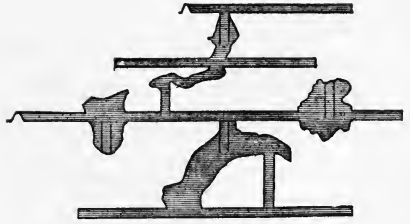

FIG. 40.

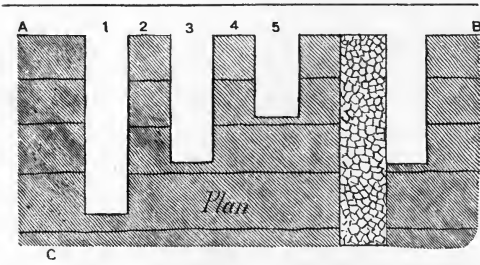

FIG. 41.

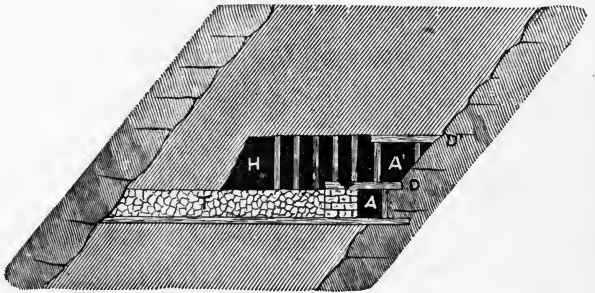
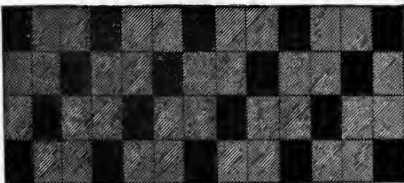

FIG. 42.







time, but the breasts worked in the upper stories must always be over breasts not yet cut out or over breasts filled up with barren rock. The working of the cross-breasts is therefore arranged in such a way that by the side of each one that is actually worked there shall be as many left as there are stories or tiers. (See Fig. 42.) The work is then prosecuted after the manner of working by reversed steps described in pages 281 and 282. Commonly not more than ten tiers or stories are taken to constitute a working field; the eleventh story has its tunnel fitted up so as to be used as a main or transporting gallery.

When a large mass of barren rock is met in working a deposit at *T*, Fig. 43, it is left standing and the ore behind it or above or below is obtained by mining around the obstacle. It is sometimes the case, however, that what appears to be a barren mass may contain within it a valuable ore; it is not well, therefore, to leave such a mass hastily, but rather pierce through it at some point.

#### PREPARATION AND WORKING OF STRATIFIED DEPOSITS AND BEDS.

The working of layers or beds of great inclination corresponds, in the main, with that of lodes or veins. But beds whose inclination is less than 40 degrees are worked in one of two ways, by the long wall system, or post and stall workings.

The former method is adapted to thin and nearly horizontal beds, which furnish a sufficient amount of rubbish. This method is really very similar to that described on

pages 281, 282, and is conducted very much in the same way, only that the workings which in that case had a perpendicular direction are carried on here in a horizontal one.

The following is a more detailed description of this method of working. The bed or deposit to be worked is prepared by opening on a certain level a tunnel *A B*, Figs. 44 to 47. This tunnel is made of sufficient height to be used as a transporting gallery. If this tunnel is also the lowest of the mine, it is called the ground level or dip-head level. The portion of the bed or layer above this ground level is further prepared by opening parallel levels *C C*, and diagonal drifts *D*, Fig. 44, or by drifts perpendicular to the ground level, as *E E* in Fig. 45. If the inclination of the strata or "vein" be insufficient to admit of rolling down the material hewn out, and at the same time too steep to admit of transportation with carts or barrows, then the mine is prepared by diagonal drifts *F F*, as in Fig. 46. Thus in one or the other of these ways the bed is divided into portions 1, 2, 3, etc., each of which is from 25 to 50 fathoms long in the direction of the strike or bearing, and from 10 to 30 fathoms in the direction of the dip. The field thus prepared is generally bounded on the upper side by a level *G H*, Figs. 44, 45, 46, which is used as the ground level in working the next field, or which has already been so used. To secure ventilation the levels or drifts are united by crosscuts, as at *I* in Figs. 44 and 45.

Each breast or working face in its entire width is occupied by miners who work one above the other in such a

FIG. 43.

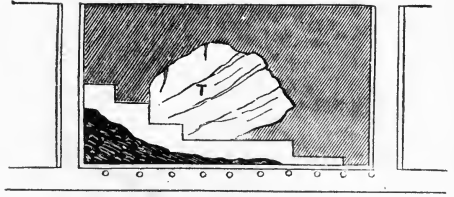

FIG. 44.

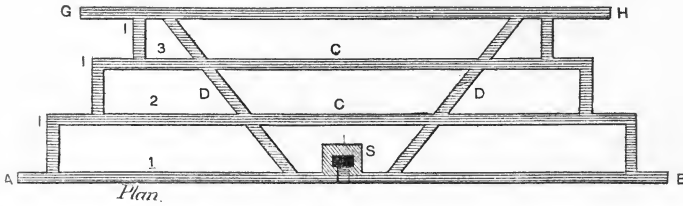

FIG. 45.

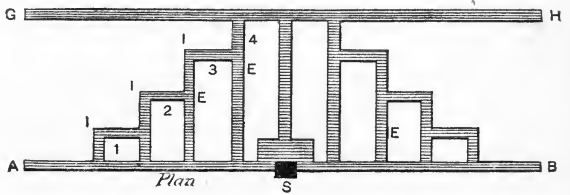

FIG. 46.

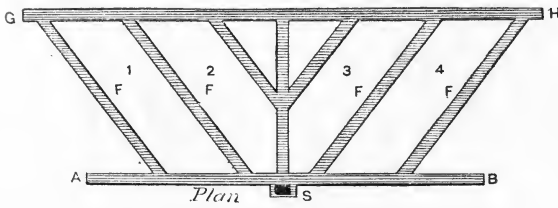
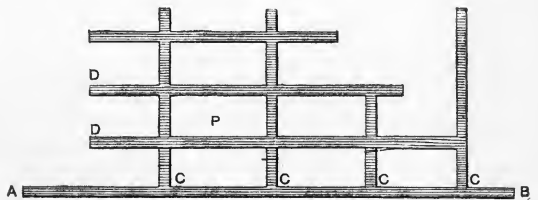

FIG. 47.



To face page 288.



way that the steps or tiers, Nos. 2, 3, etc., recede like stair-steps with reference to the breast No. 1, see Figs. 44 and 45.

Whilst the work is thus going forward the roof in the excavated space is temporarily supported by timbers until it can be more permanently filled up. Care must be taken to leave open and unobstructed the levels and diagonal drift along which the mineral is transported to the ground level *A B* or the shaft *S*. (See Figs. 44, 45, and 46.)

With the exception of thin and slightly inclined coal-beds, this method is used only in the cupriferous slate strata of Mansfeld.

The post and stall method is used in deposits and beds of considerable thickness which do not furnish a sufficient amount of rubbish, and where pillars must be left to support the roof, or where the roof is allowed to crush down.

The preparatory work for this method of mining is as follows:—

At the lowest level of the bed, a tunnel or ground-level *A B*, Figs. 47 and 48, is made which may be two fathoms in width. Perpendicular (*i. e.*, right-angled) or diagonal to this a drift *C* is made, and crossing this at regular intervals of two or three fathoms levels *D D* parallel into the ground-level *A B*. In this manner the bed or deposit is divided into long strips. These are again cut through at intervals of from three to six fathoms by drifts perpendicular or right-angled to the ground level, and thus the necessary arrangements for transportation and ventilation are made and the rectangular (horizontally long) or square (vertically short) pillars. See (*P*) Figs. 47 and 48. The size of these pillars

depends upon the nature of the roof and the solidity of the floor.

The taking out of the pillars begins when the levels, or drifts, have reached the end of the bed, or the extent of the field to be worked, or exhausted portions of the mine, or in general arrived at the predetermined limits. The beginning is made at the point farthest removed from the main or working shaft or gangway and the work proceeds towards this shaft or gangway so that the roof may be allowed to crush in without interfering with transportation and ventilation and the workings still be carried on in other portions of the mine.

The separate pillars are taken one after another, beginning with the upper one and proceeding down in the direction of the dip. Before this is commenced and while it is going on, the roof has to be supported either by timbers or dry walls. As soon as one pillar has been taken away and the materials composing it removed, the timbers supporting the roof are carefully taken away, provided it can be done without danger, otherwise they are abandoned and the roof is allowed to fall.

If the roof is very brittle, it is sometimes best to leave some of the pillars standing, or to build hollow pillars of rock which are filled with coal waste, which, in order to guard them against spontaneous combustion, are kept from the draft of air.

In coal-beds, levels and drifts are cut most advantageously in the following manner: The miner cuts with his pick in the most suitable place, generally as near the floor as possible, a shallow horizontal groove *S*, Fig. 49, as deep into the

FIG. 48.

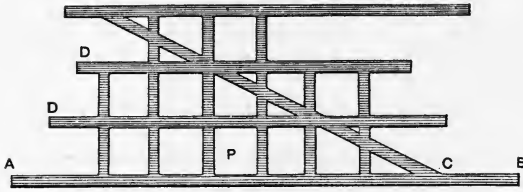

FIG. 49.

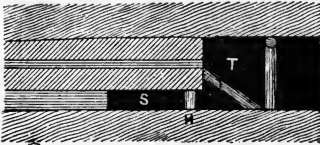

FIG. 50.

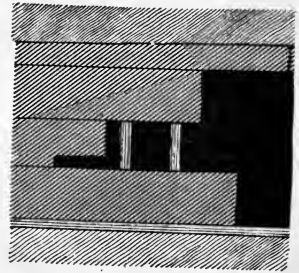
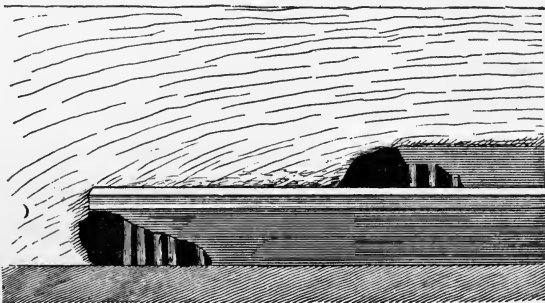

FIG. 51.





REESE LIBRARY  
OF THE  
UNIVERSITY  
CALIFORNIA.



coal as possible. The coal thus liberated is supported by blocks, *H*, and props *T*. Then perpendicular grooves are cut through the entire thickness of the bed and as deep as the groove *S*. In this way blocks are formed which are free on four sides and which may easily be detached.

In coal-beds composed of several different layers or "benches" of different degrees of hardness, the first or horizontal groove is made in the softest layer, but in beds of greater thickness generally in the middle (Fig. 50), in which case the upper portion is removed first. In beds of very great thickness the galleries are not cut through the entire thickness at once, but in successive layers or tiers. (See Fig. 51.)

If the roof or walls need support, this is supplied as the excavation of the level or drift proceeds. This support consists generally of posts which are let into the floor and wedged firmly and perpendicularly against the roof.

In coal mines spontaneous combustion not unfrequently occurs, especially where a part of the roof is allowed to crush in. It is generally supposed that the cause is to be found in the decomposition of pyrites (iron sulphide) contained in the remaining coal and the contiguous clay-slate. Frequently such combustions result in extensive conflagrations. The most effective mode of prevention of such calamities would be to fill up the excavated spaces completely before they are abandoned and before the roof is allowed to crush in. But, inasmuch as this would involve too great an expense, the next best means ought to be resorted to, which would be to separate and shut off any extended portion of the mine, that has been abandoned, from that which is still worked, by walls

of stone and dams of clay, etc. Only in case of absolute necessity is it allowable to inundate the workings.

The precautionary rules are, not to expose the coal to a stronger current of air than is absolutely necessary for purposes of ventilation; and not to prepare too extensive a field at one time; to leave pillars of sufficient strength to prevent a premature caving in; and to begin the work of taking out the pillars and abandoning the field as soon as the previous work is completed.

#### PREPARATION AND WORKING OF MINERAL DEPOSITS THAT OCCUR IN LARGE MASSES.

In mining deposits of irregular form, and containing large masses, the form and extent of them, and the nature of the surrounding rock will determine the method to be pursued. Large deposits which possess some degree of regularity may generally be mined by what has already been described as the cross system of mining. Deposits with little or no regularity of form require a peculiar method. As a general rule the aim should be to find the extent of the deposit in a downward direction and then work from below upwards, as this will be found easier and more profitable.

The manner of preparing such a deposit is about as follows:—

When the deposit has been discovered by means of an adit or tunnel and this tunnel has entered the ore, then shafts are pierced both above and below either perpendicular or inclined, and from these shafts, at moderate intervals, drifts are run in the ore-mass, as *A B C*, Fig. 52. If the

FIG. 52.

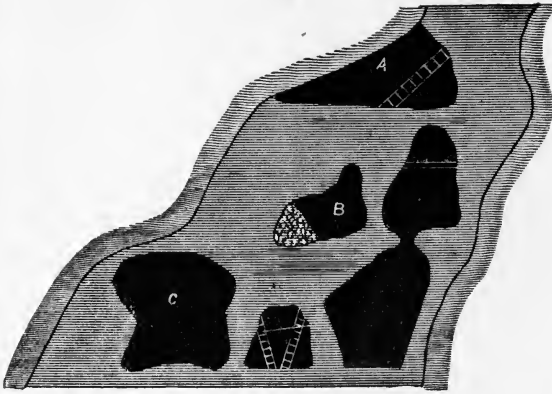

FIG. 53.

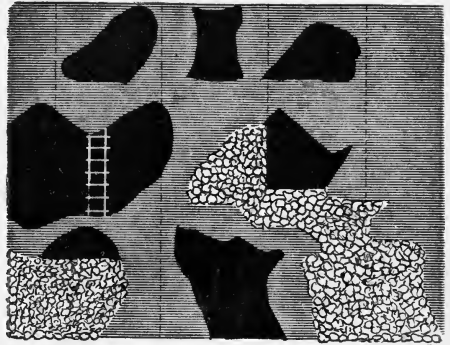
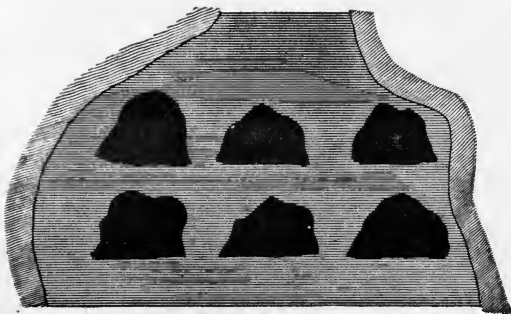

FIG. 54.





REESE LIBRARY  
OF THE  
UNIVERSITY  
OF CALIFORNIA.

deposit has been discovered by a shaft, a cross gallery is run and from this the work proceeds as above. Along these drifts vault-like chambers are formed by hewing away from the sides, roof, and floor, which are enlarged as far as the solidity of the ore-mass will permit. Between each two vaults lying above each other, ore of sufficient thickness is left to serve as a floor for the upper one, also pillars, and both floors and pillars as much as possible of worthless ore. The pillars ought to be so arranged that they will be over each other, and a sufficient amount of ore should be left around the shaft to prevent their caving in. The floors are pierced wherever it is necessary in order to transport ore either up or down.

The miners while at work stand upon the accumulated rubbish or upon ladders or scaffolds.

If one of the vaults should become too large and be in danger of crushing in, or if the ore-mass is composed of hanging and lying ore-veins, then it is best to run drifts in different directions which start from the same point or cross each other. When these drifts reach the limits of the ore, new vaults are made. In this manner there are exposed irregular masses of inferior ore which may be worth mining, but are difficult to extract because surrounded by large spaces. In order to gain all these masses those between two contiguous drifts are divided in the direction of the drifts into 2, 3, 4, etc., perpendicular portions (see Fig. 53), after which the floors, pillars, etc. are taken out in regular order, beginning with the division at the lowest level and leaving what is worthless whether in the shape of pillar or floor.

The rubbish is so placed that it may support the roofs which rest upon pillars that are to be taken down. If sufficient rubbish for this purpose is wanting, pillars are made of timber filled in with rubbish.

If in spite of all precautions a part of the mine should crush in, the valuable ore contained in the wreck may be gained in the following manner. The wreck is approached by means of drifts or galleries which are secured with timbers as they advance. When these galleries reach valuable ore it is taken away from the breast of the gallery, and as it is taken new materials are allowed to roll down from above as long as they continue to be valuable. When they cease to be so, the broken mass is approached from another side. This kind of work is generally reserved for miners who wish to work extra time and are willing to take what they can make.

This method described in the preceding paragraphs finds its application also in rock-salt works. In deposits which contain salt in large and almost pure masses galleries are cut, as shown in Fig. 54. These are brought into communication with each other and with the main shaft. These tunnels are then enlarged by hewing away from the sides and roofs as shown in Fig. 55. The dissolving power of water is made use of in such works with great advantage. The water is conducted into pipes which have a row of fine holes along their entire length through which the water flows in fine thread-like streams against the salt. These threads soon cut deep grooves in the salt and large masses may then be detached at once.

FIG. 55.

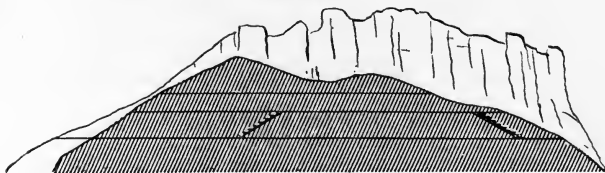

FIG. 56.

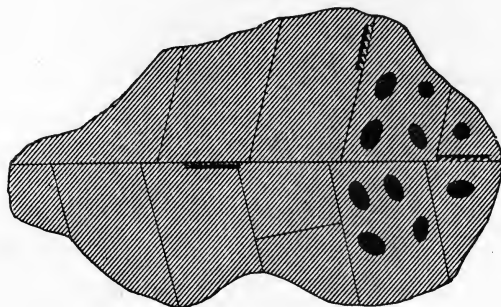

FIG. 57.

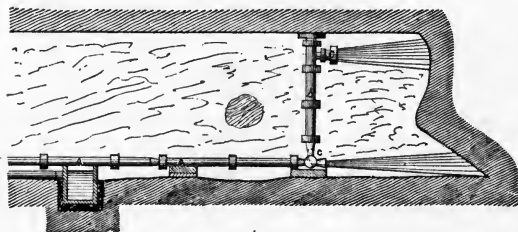

FIG. 58.

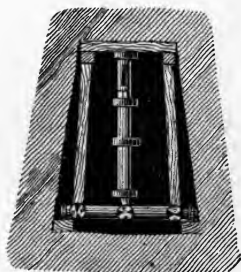
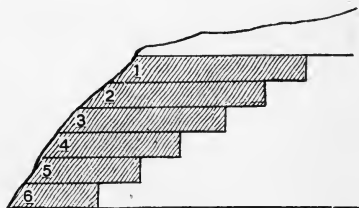

FIG. 59.





REESE LIBRARY  
OF THE  
UNIVERSITY  
CALIFORNIA.



The method of gaining the salt in a mine by dissolving it is almost entirely out of use. The particular method of running the gangways and communications between them vertically and the rectangular branches conveying the water toward the opening may be understood sufficiently by examining Figs. 55 and 56, one being a vertical section, the other a ground-plan.

In solid rock, as for instance in limestone, quartz rock and the like, it is usual to have recourse to the work of rock blasting, with drill and powder of various kinds. In the salt-bearing slates, and material of similar strength, generally the pick-axe serves sufficiently well, but more recently and with greater advantage and perhaps in California with the greatest possible advantage, the water stream is used, which is described more fully on p. 298, "Buddling." In some of the salt mines, as stated by Niederist, the following method is used in progressing against a breast in a gangway: The figures explain the process sufficiently where (Fig. 57) *A A* is the pipe conveying water from a high level, and of consequent high pressure. *B* is the stand-pipe and *C C* are the nozzles from which the water escapes and dashes with great force against the soil or mineral; Fig. 58 shows the bracing of the standpipe.

#### *Preparation and Working of Nests, Cores, or Pockets.*

In working small irregular deposits, such as nests, cores, or pockets and shoots from larger veins, we have to be governed by their size and form. The smaller and the more irregular they are, the more necessary it is to follow

closely the direction of the ore and not attempt to do much in the way of prospecting. If they assume the form of veins or beds, or larger masses, they are worked in accordance with the conditions.

In working cores or threads the sides of the tunnel should be as clean and smooth as possible, because these cores frequently send out branches which may lead to the discovery of other deposits, if scrutinized carefully when free from rock and other misleading substances.

#### SURFACE OR DAY-WORKING.

Surface or day-working is that where the deposits to be worked occur at a moderate depth below the surface and which admit of the covering mass being removed. To this class belong deposits of peat or turf, bog iron ore, rock-salt, flat coal-beds and even deposits of ore. The work includes stripping, quarrying, and bundling.

The work of stripping consists in removing the surface soil and thus exposing the deposit. The mass to be taken away must be removed to one side, or at any rate to a place where it will not impede the subsequent work, and where at the same time it will be convenient to fill up excavated spaces if it should be needed for that purpose. When this is done, a cut is made to the bottom of the deposit, or at any rate to a considerable depth where a ditch is made to convey away the water, or a cistern to collect the same. Then the working is carried on by descending steps. At the same time care has to be taken that the breast, or the wall, does not cave in and endanger the workmen.

In open quarrying there may be gained not only building stones, mill-stones, and the like, but also valuable minerals, as rock-salt, iron ore, etc.

The mass to be mined may be loose or solid. In the former case it is best to arrange and prosecute the working by steps or cuts, 1, 2, 3, etc., Fig. 59, and to roll down the material gained from the upper to the lower steps, and to facilitate this an inclined plane is made in the middle of the quarry by cutting away the corners of the steps; this incline ought to be about  $45^{\circ}$ .

If solid rock is to be quarried, then the method will depend upon the size and form which the pieces ought to have. Large regular building stones and mill-stones are gained by cutting grooves and driving in wedges along the line of the groove, and also by blasting. Smaller, irregular pieces are obtained by blasting, and most easily by adopting the method of descending steps. In various mines or quarries, as in Middletown, Connecticut, large blocks are easily opened in almost any direction by driving in perfectly dry pins into the holes prepared during the day along the line of the desired opening, and just before the workmen are dismissed water is poured in the groove. The swelling of the wood, by morning, opens a seam, and the removal of the block is easily effected. In case the holes were not deep enough and the pins or wedges are not long enough, alternate holes are made and the trial repeated the next night. The miner must learn this process and judge of its special efficiency by the nature of the rock; generally in sand-rock holes six and eight inches deep, one-and-a-quarter inch diameter, are

quite sufficient, at an interval for each hole of eight or nine inches. In some brittle and soft rocks these measurements are greater than necessary.

When a quarry is first opened it is necessary to remove the covering mass to a place where it will not be in the way. It is also necessary to provide a suitable road, so that the teams can drive up to the workings and prevent unnecessary hauling, or moving of the quarried mass.

To avoid the removal of a very thick covering, and to be able to work during winter, or in case the quarry is difficult of access, it is sometimes well to work it under ground with tunnels. Where the covering, however, extends a great distance, as at the iron mines near Hokendauqua, Pennsylvania, and other places in this region, the tunnels must be driven from shafts. In this plan the enormous deposits of water in the workings would be avoided, but where wood is dear and hard to be had the necessary timbering must be considered as an objection. The cost of hoisting engines, fuel, etc., would be about the same in either case.

Buddling is the method of gaining useful minerals by means of water and the specific gravity of the minerals. There is a great variety of methods more or less complicated. One of the simplest methods is that employed in steep mountain valleys, where a ditch is dug, beginning at the lowest point and casting the mass to be washed in at the top and causing water to wash it down. In this way the coarse and worthless particles will be found on top, lower down the finer sand, and the finest with the valuable mineral at the bottom. The worthless is cast away, the next grade is

crushed if necessary, and with the finest is washed again in suitable apparatus.

Instead of ditches various mechanical contrivances are used, such as the washboard, which is especially adapted for minerals found in coarse grains, as gold. It is three or four feet in length and has shallow grooves running crosswise, and is at the sides supplied with a rim. This washboard is placed in a ditch having a slight inclination; the earth to be washed is put into the ditch above, and, with constant stirring, is washed first on the board and then over the same. When a certain amount has been washed, the board is lifted out; and the sand collected in the grooves is emptied into a vessel and the metal is separated. Several such boards are generally placed at distances of one or two fathoms apart, and at the end of the ditch a dam is erected to intercept the sand so that it can be washed again.

If the mineral particles are very fine, the muddy water is conveyed over a series of sieves, and thus the coarser particles are separated from the fine.

Where a sufficient head of water can be obtained and the soil to be washed is loose, it is advantageous to convey the water directly to the mass by means of hose and discharge it through a  $1\frac{1}{2}$  inch nozzle upon the earth so as to undermine a portion of it and cause it to crumble in. This is then still further separated and dissolved by the stream and washed into and through ditches 200 or 300 feet long, having considerable inclination thereto; these are furnished with grooves in which the metallic particles are collected. Instead of ditches, troughs made of boards are sometimes used,

and these are furnished with cross pieces on the bottom instead of grooves.

### ASSORTING THE ORE IN THE MINE.

The useful ore must be separated from the worthless rock in which it is generally contained. The beginning of this work is made in the mine itself, partly to obtain rubbish with which to fill up and partly to save transporting useless material. This assorting in the mine cannot be very close or minute, but aims only to separate the larger pieces which are entirely worthless from those which contain ore.

The miner looks carefully at the mass obtained by a blast, breaks the larger pieces, and throws the worthless to one side. The rest is taken away and more narrowly examined, and assorted first as to the size of the pieces, then the larger pieces are separated into richer and poorer.

If very rich ores of valuable minerals are discovered in the mine, they are carefully separated and put in sacks or baskets and carried out of the mine immediately. In precious minerals even apparently useless ores are saved, because even a very low per cent. of gold, or silver, will pay the cost of mining and smelting.

### TRANSPORTATION.

This whole subject may be conveniently and appropriately classified under one head:—

1st. Transportation in galleries and drifts either level or with an inclination not exceeding  $10^{\circ}$ .

2d. Transportation through galleries and drifts having an inclination of more than  $10^\circ$  and less than  $30^\circ$ .

3d. Transportation through shafts either perpendicular or inclined.

*General Rules.*—1st. Choose the shortest way and simplest method.

2d. Avoid as much as possible repeated loading and unloading, or broken transportation.

3d. Wherever convenient use machinery.

4th. Be not afraid of expense in securing the best means and method of transportation.

5th. Do not hastily or frequently change the transportation from one drift or level to another in the hope of saving distance.

*Transportation through galleries and drifts having an inclination of more than  $10^\circ$  and less than  $30^\circ$ .*

When ore, or coal, is to be transported from a higher to a lower point over an inclined plane one method usually adopted is that represented in Fig. 60 (called a jigger break). It consists of a *winch* or *whim*, placed at the point from which the ore is to be transported to a lower gallery or level *A*. Along this incline double wooden rails are laid. *R* is an axle-tree around which a rope or chain is wound several times; at the upper end of this the loaded wagon *V* is fastened, and at the lower the empty one *L*. When the loaded wagon descends it draws up the empty one. Now to prevent a too rapid descent a wooden wheel, *S*, is attached

to the axle-tree, and this again is provided with a brake, *B*, as shown in Fig. 60.

When ore is to be transported from an intermediate drift, *A*, Fig. 61, the wagon may be attached to the chain, as there shown, provided the inclination is not too great. On steeper inclines the wagon is placed on a platform, *G*, as shown in Fig. 62. The object is to prevent the ore from falling out of the loaded wagon during the descent.

### *Transportation through Shafts.*

The method of shaft transportation depends upon the nature of the shaft, whether it be perpendicular or inclined. The machines used are adapted to the power employed. The windlass is worked by muscular power, the water-wheel and turbine by water-power, the steam-engine by steam-power.

An essential requisite for shaft transportation is found in ropes. Two kinds are used, hemp and wire. The former are made of hemp or manilla fibre, the latter of wire, and both either round or flat. Chains, on account of their great weight, are not much used. Round ropes are wound about cylindrical or conical drums; the flat ropes or bands are wound between disks (see Fig. 63), composed of two flanges, *RR*, with intermediate space, *SS*, for the band or flat rope.

The shortest and most natural method of transporting minerals, etc., from a higher to a lower plane is through shafts; these, however, must have such an inclination that the transportable material may not be arrested or



FIG. 60.

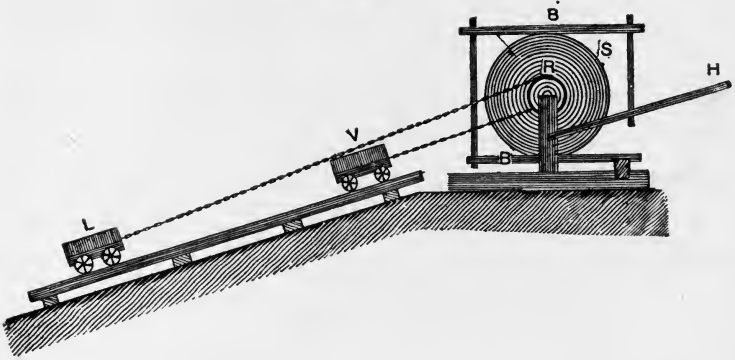

FIG. 61.

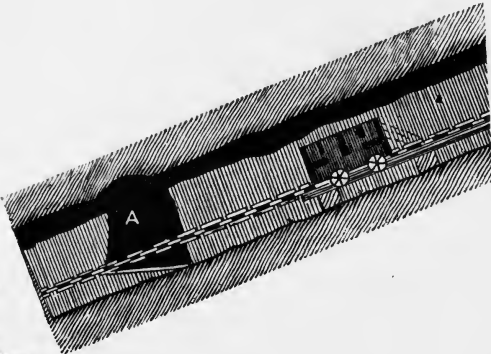

FIG. 63.

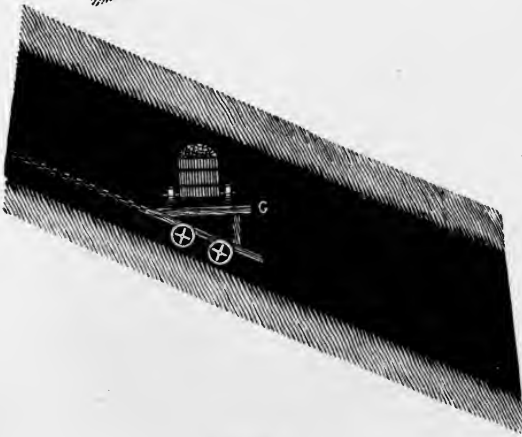
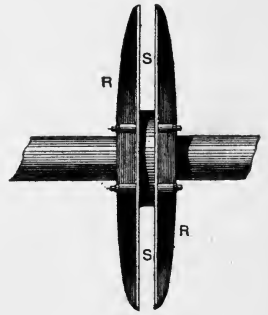
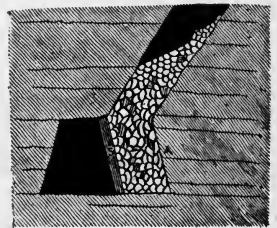

FIG. 62.

FIG. 64.





“hang” in its course ; therefore, they should not be curved, irregularly, vertically, or laterally.

If the shutes are lined with timber, then the boards should be arranged longitudinally, that is, parallel with the course and securely nailed.

In the lower plane the shute terminates with or without a sliding gate. If no sliding gate be provided, a recess about six feet in depth should be made (see *A*, Fig. 64), which should be furnished with a door or closed by strong posts, *S*, in order that material shall not fall into the gangway and interrupt transportation. If the shute is provided with a sliding gate, Fig. 65, *A B*, the surrounding frame should be closed up with strong timbers, and only the opening left for the sliding gate through which the transportable material falls into a car placed below or is raked in. In order that the timbering may not be injured by the material rolling against it, the shute should never be entirely empty, but filled up to the height of about twelve feet.

The windlass is efficient in transporting material from a lower to a higher level for a distance of twenty fathoms (120 feet), Fig. 66. The windlass consists of a framework and drum or cylinder. To the frame belong the floor frame *B B G G* and the posts or uprights *T T* supported by the braces *S S*. Into the uprights the cylinder is let by axles, and around the cylinder is wound a rope with the transported weight or bucket at the end. The revolution of the cylinder is caused by the cranks which form the continuation of the axles which turn in iron-lined journals let or “scored” into the upright (see Fig. 67), or nailed on to the upright (see

Fig. 68). The windlass for moderate depths is generally worked by two men, and for greater depths three and sometimes four men. According as the windlass is worked backward or forward, one or the other vessel descends.

Where a windlass is to be erected, a wider space is to be excavated. (Fig. 69.) In perpendicular shafts the uprights of the windlass are perpendicular to the frame, and to make them more secure they are extended and let into the roof. (Fig. 69.) In inclined shafts the uprights are set at right angles or nearly so to the inclination of the shaft, mortising them into the frame, and letting them into the roof. (Fig. 70.) The journals are fixed at two-thirds of a man's height, or about three and a half feet above the floor, taking care that they be upon the same level. The cylinder should be at least nine inches in diameter, and may be made of pine because of its lightness as well as of its strength, care being taken to obtain heart timber and sound.

If a greater weight is to be raised, and from a greater depth than usual, a larger and stronger cylinder is used, geared in with cog-wheels, the larger wheel being upon the main cylinder and the small cog-wheel upon a separate shaft, or rod, with the crank attached. The cranks should not be at right angles, but directly opposite each other, so that when one is down the other shall be up; and in order that they shall not chafe the hands of the workmen, they should be furnished with cases, or shells on which the permanent handle turns.

The hemp ropes are generally tarred to make them more durable. In mines where the water is not acid, chains with

FIG. 65.

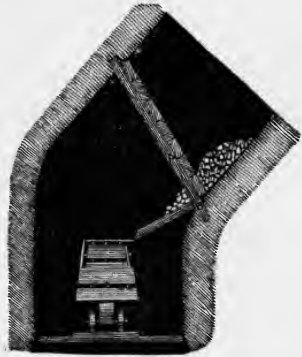
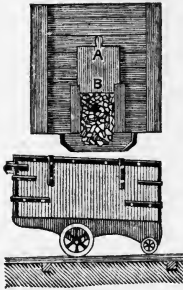

FIG. 66.

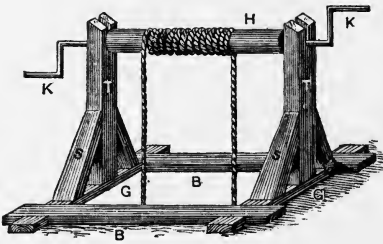

FIG. 67.

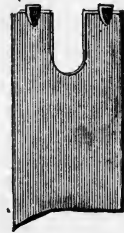

FIG. 68.

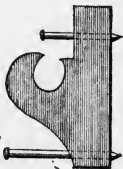
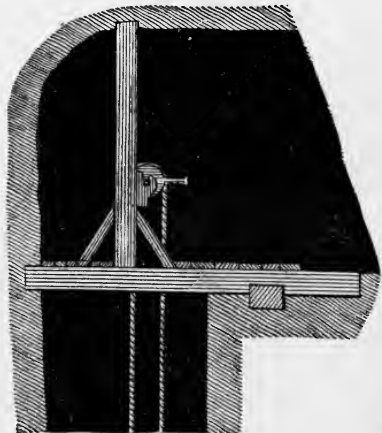

FIG. 69.





PUBLIC LIBRARY  
OF THE  
UNIVERSITY  
OF CALIFORNIA.

FIG. 70.

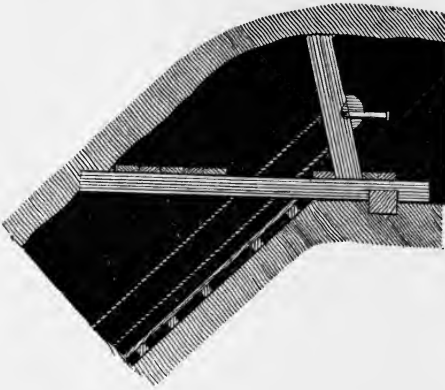

FIG. 71.

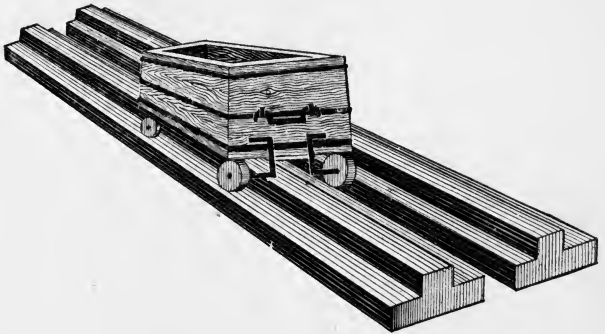
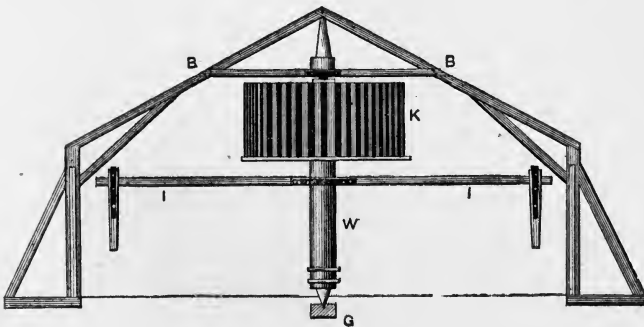

FIG. 72.







twisted links, may be used to greater advantage than wire ropes. The ropes must, however, be three or four fathoms longer than the depth of the shaft, to furnish friction enough by sufficient coiling upon the cylinder.

In perpendicular shafts round buckets are preferred, in inclined shafts square vessels with or without wheels. In the former they are freely suspended, in the latter they slide or roll upon rails or guides. In curved shafts the rope, or chain, must be guided by rollers, or pulleys placed at the parts of altered direction.

To prevent the falling of material into the shaft, the framework at the foundation is covered with flooring into which a trap-door, to allow transportation, is opened.

When the depth of the shaft amounts to more than twenty fathoms (one hundred and twenty feet), the windlass must give place to more effective machines. The more common are horse-whims, water-wheels, and turbine and steam-engines. The horse-whim, Fig. 72, consists of an upright cylinder post *W*, with drum *K*, and draft-beams *II*. The cylinder is made of hard wood and revolves upon two iron axles, turning on cast-iron centres of which the upper one is fastened into a wooden collar beam *BB*, and the lower one turns in a stone block *G*. Around the drum two ropes are wound in opposite directions, which, during the revolution of the cylinders, run over pulley-wheels, Fig. 73, into the shaft. The manner of putting together a drum for such a horse-whim may be readily understood by examining the following, Fig. 74, the spurs being preferable to a smooth periphery as allowing greater hold or friction. At the ends of the ropes

buckets are hung. When the full bucket ascends the empty one descends. As the rope of the descending bucket gradually becomes longer and heavier, that of the ascending bucket becomes shorter and lighter; in this manner the descending bucket gradually gains in weight and velocity. To equalize this the drum receives, instead of a cylindrical, a double conical form, and is composed of two frustums of cones joined at either the larger or smaller ends—Figs. 75 and 76. The latter is especially used in the horse-whims. The former method finds its application chiefly in the water-whims, and both are known under the name of spiral buckets, and they are generally furnished with breaks. When such a whim is in operation the rope of the ascending full bucket winds itself in the direction of the greater diameter of the shaft, that is the leverage of the load increases, whilst on the other hand the rope of the descending empty bucket winds itself about the basket in the direction of the small diameter, and thus the leverage decreases so that the power and weight tend to equalize each other.

To the draft-beams horses or other animals are hitched, and they move in a circle, either to the right or to the left, according to the desired movements of the buckets.

It is well to remember that, in using buckets, it sometimes is a great convenience to have properly placed in the bottom of the bucket a square opening fastened by a strong hinge on the one side and by a small movable bar of metal on the other, both on the outside, so that the contents of the bucket may readily be discharged upon the ground without turning

FIG. 73.

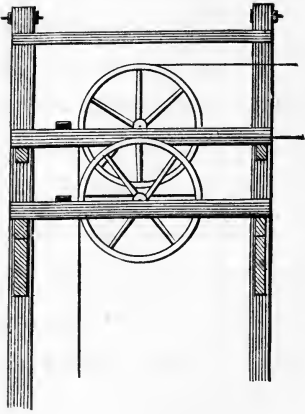

FIG. 74.

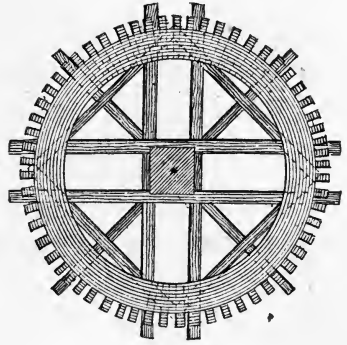

FIG. 75.

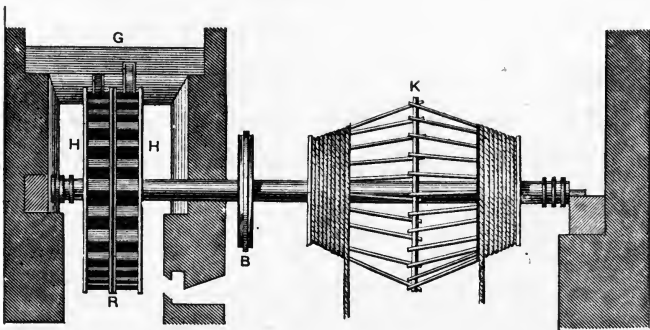
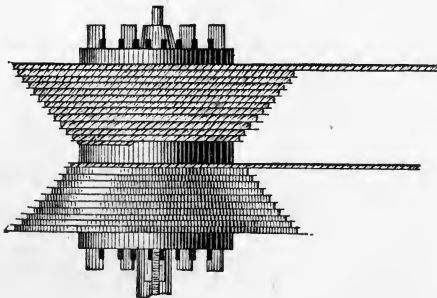

FIG. 76.





or tilting the bucket over, a work sometimes attended with great effort.

To prevent a loaded car from "jumping the track," or parting from its proper course, not only double rails may be used, but one single elevation in the midway of the track may be found both cheaper and more efficient, as represented in Fig. 71, wherein the car is supposed to be lifted up at the nearest end to show both axles.

The principal parts of a water-whim are a double water-wheel *R*, Fig. 75, constructed with a brake attachment, and the horizontal rope basket *K*. The water-wheel may have a diameter of from three to thirty-six feet, and differs in its construction from an ordinary overshot water-wheel only in this that the periphery of the wheel is divided into two sections *HH*, having the water-buckets in reversed directions with an intervening division or partition, so placed that a double wheel is formed which may be turned in opposite directions according as the water is let into one side or the other of the wheel. The advantage of the conical basket is the same as in the horse-whims.

The brake attachment consists either of a separate wheel *B*, Fig. 75, or the middle of the water-wheel is raised an inch and a half over the two sides and the brake attached to *G*. A very simple brake consists of a brake-frame, *TT*, Fig. 77, the rods *BB*, the draft-rods *ZZ*, and the brake-lever *H*. When the lever is depressed the rods *BB* are pressed against the wheel, and by means of the shoes *SS* the desired friction is produced. This may also be accom-

plished by turning the water into the opposite side of the water-wheel.

Since the weight decreases as the bucket ascends the head of water is decreased, and when the bucket has nearly reached the surface the water is cut off altogether, in order to stop the wheel. This, however, can only be fully accomplished by means of the brakes, for the weight of the water in the wheel-buckets and the momentum of the wheel tend to continue the motion.

Another method is as follows: The descending bucket is filled with water which by its weight draws up the bucket filled with ore and other material. In this case the shaft is furnished with either a horizontal drum for round ropes or two disks,  $S S'$ , Fig. 78, for band or flat ropes and a brake,  $B$ . The flat ropes run over pulleys or rollers,  $R R'$ , into the shaft. Where conical baskets are used these pulleys or rollers are movable along their axes, in order to follow the lateral movement of the rope from side to side. The brake-wheel is situated upon the same cylinder  $S S'$ , and has on its sides pins,  $Z Z$ , for the purpose of raising or lowering the bucket to be emptied.

The water is let into the bucket from an elevated reservoir through a pipe which has a delivery arm and hose and stop-cock,  $T$ , and is retained in the bucket by a valve in the bottom.

Since the mine material is heavier than the water both buckets must not be equally filled, but one must have proportionably less weight. For this purpose the buckets have false bottoms, so made that they do not permit the water to

FIG. 77.

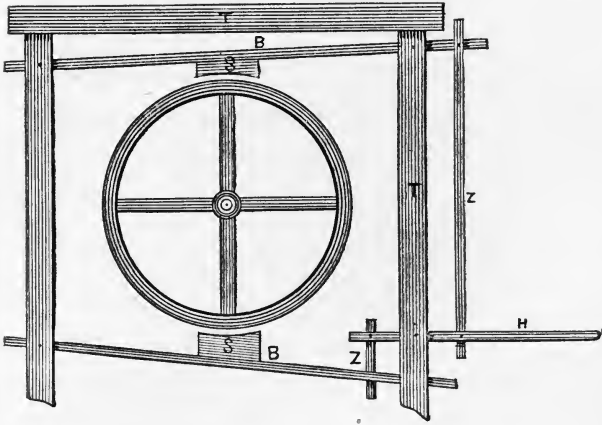
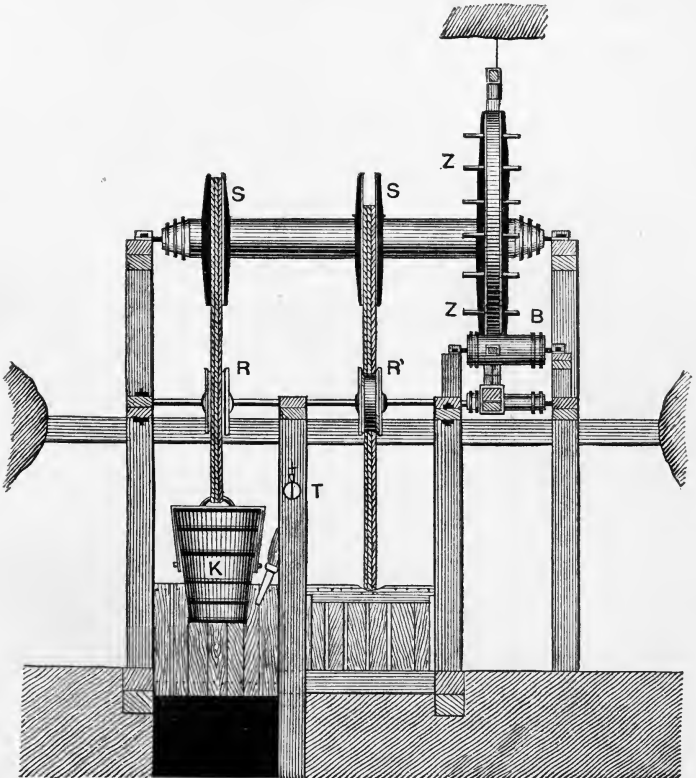

FIG. 78.





REESE LIBRARY  
OF THE  
UNIVERSITY  
OF  
CALIFORNIA.



come in contact with the solid contents, but to enter the space below, which, when it is desired, may be filled with water. In order to empty the bucket when it reaches the bottom of the shaft, a valve is set in the bucket for the release of the water. This method of lifting is of value only when the water can be led out of the shaft by tunnel or otherwise. Instead of filling the descending bucket with water it may also be filled with rocks, provided they are called for filling or other uses in the mine, as suggested under "Timbering and Masonry," p. 317.

It is of importance to put the whim as high over the lowest adit level  $AB$ , Fig. 79, as the distance  $CD$  is below the same, so that both buckets may be at the place of loading and unloading at the same time.

Where there is a small amount of water with sufficient head, turbine wheels may be used. They present the appearance of horizontal wheels (with perpendicular axes), upon which the water acts by thrust and weight combined, being caught by the curvature on one side of a series of blades, which are concave to the approaching water, but convex on the opposite side to the same body of water.

The general form and curvature of the blades may be seen in Fig. 80, which represents a horizontal section. The double form of the wheel will be noticed, the outside ring-wheel being made stationary and the inside fastened to the shaft, as we shall further explain, in Fig. 81.

In Fig. 81 may be seen a method of placing the wheel and shaft. Here  $W$  is the shaft, the wheel, Fig. 80, being at the lower part of the shaft and its plane at right angles

to the length of the shaft  $W$ . At the top of the shaft is the small cog-wheel  $X$  gearing into  $R$ , which runs the machinery. On the left hand is the main delivery pipe,  $A$ , the box receiving the water, which turns the submerged wheel placed between the beams  $S S$ . At this point it is necessary to understand that this form of the turbine requires that firmly placed between  $S S$  is the outer ring of the wheel, Fig. 80. The water descending would naturally push this outer ring in the direction of the arrow, but being immovable the effect is to move toward the opposite direction, the inner wheel attached to the shaft  $W$ . Sufficient room, or headway, is given for the water to escape from under  $S S$ . It is plain that the greater the pressure of the water in  $A$  the greater will be the force exerted upon the curved blades of the turbine. These principles will be further treated of in the examination of special cases.

If water power cannot be obtained at all, or only at too great cost, and if fuel be available and cheap, it is better to use steam power for transportation and other work. The effectiveness depends upon the expansiveness of steam, and the general principles upon which all steam-engines move may be learned by examination of Fig. 82, with the explanations we proceed to give.

$C C$  is the *cylinder*, which is the chief and head place of active power in the engine. In the cylinder is the *piston head*  $K$  attached to the *piston rod*  $L L$ , which is connected with the *connecting rod*  $M M$  and moving with the motion of the *crank*  $E$  upon a joint at  $P$  in what is ordinarily called

FIG. 79.

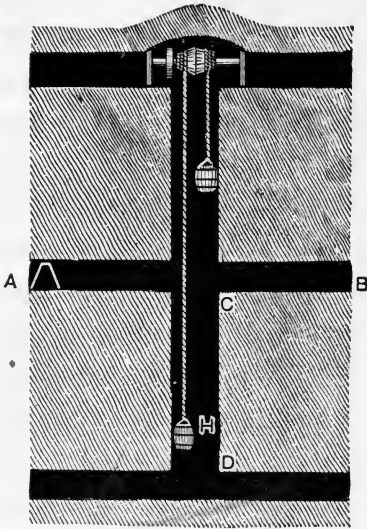

FIG. 80.

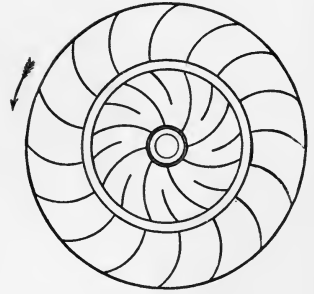

FIG. 81.

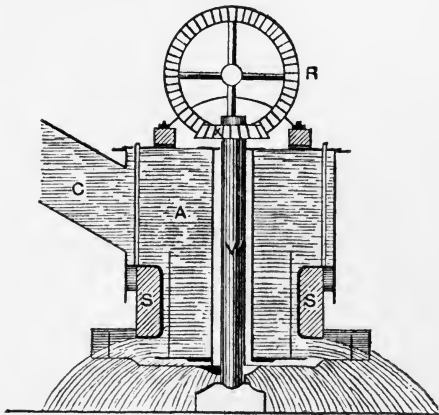
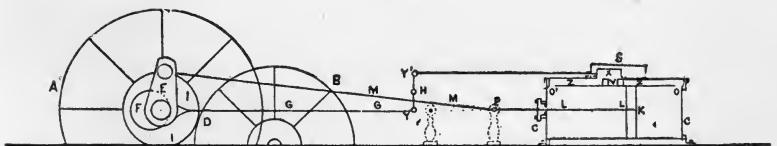

FIG. 82.





the *cross head* guided on either end by the *guide*, or *guide rods*. *A* is the fly-wheel, whose momentum carries the connecting rod around the dead centres; the crank *E* is now between the dead centres and in the upper semicircle. *II* is a wheel "cogging in" to the larger wheel *DB*, which thus carries the machinery. Now it is plain that steam entering with sufficient pressure behind *K* into *CC* will press *K* toward the crank, and, contrariwise, if the steam was let in on the opposite side it would return the piston-head *K*, and thus the engine-shaft would turn. This oscillation, however, is the result of a constant pressure of steam entering at *S*, and at that point always in one direction, and the alternation is brought about by means of a sliding valve *X* in the *steam-chest ZZ*, so placed, as may be seen in Fig. 82, that only one hole, called "*port*," opens the steam into the cylinder at one time. In the figure the right hand hole is now open and the steam is running into the port *O*, at the same time the left hand lip or projection of the slide-valve has covered the left hand port, and no steam entering there the pressure is altogether delivered on one side of *K*. But there must be some relief from the resistance of the steam already in the front part of the cylinder at *LL*. This is obtained through the cavity in the bottom of the sliding valve *X*, which allows the steam now useless, and called the "*exhaust-steam*," to pass out of the same port through which the "live" steam just before passed in, until the valve slid over the "port," so far as to allow the cavity in its bottom to pass the exhaust-steam to *V*, when it escapes into the open air with the noise which all non-condensing engines make.

After this front movement, it is plain that a back movement of the slide-valve would be attended by an uncovering of the front (upper) port, the passage of the steam into the (lower) front port *O'* and the consequent reverse movement of the piston-head *K*, the steam escaping from behind the piston-head as before it escaped from before the front. It now remains to show how this alternative becomes automatic. As it would not answer to make the movement of the slide-valve greater than an inch or two, it would not do to connect the rod *G G* with the crank of the engine, hence a contrivance called the "*eccentric*" or eccentric wheel *F*, is brought into use. This is a wheel, or circular disk, or plate, placed on the shaft, but not so that the two centres of the shaft and eccentric coincide, but the latter is out of centre and hence the name. Around the periphery of this eccentric is a groove to hold the circle end of the slide-valve rod. It is plain that just in proportion to the amount of displacement, or eccentricity, of the eccentric will be the amount of draw or thrust of the eccentric rod, and if the centre of the shaft and the centre of the eccentric wheel, or plate, differ by one inch, then the amount of movement of the rod will be twice the amount of departure of centres or two inches. In this way the eccentric rod may be made to move from the smallest movement to as great as the size of the eccentric will permit, remembering that, when fitted properly, the eccentric should never have its centre cut out so near its circumference as too much to weaken the edge nearest to which the hole is cut out. The eccentric can move around the shaft and be accommodated to any desired position of the sliding valve;

after that is determined, the wheel is fixed by means of a "key" cut half way in the shaft and half in the eccentric wheel. In all engines much efficiency depends upon placing the slide-valve in nice adjustment, that is, not too far over one port and too little over the other. Eccentrics should move but little, hence it is generally preferable to cut the ports not round, nor square, but in rectangular form, so that the slide-valve may open a long opening, thus letting in a larger quantity of steam by the same draw or move of the eccentric rod. It is very plain that an eccentric may be so large as seriously to detract from the power of the engine—hence in some engines, locomotives especially, the ports are very narrow. The pressure of steam upon the valve of an engine is in some cases very great, and although the power lost or expended upon mere movement of the valve may be slight, the difficulty in managing the starting-rod or lever, in some engines, is inconvenient from this source and the consequent wear upon the valves great. Conical valves have been invented, as in the Corliss engine, and rollers under the slide-valve have been introduced and have been used in some locomotives, but not generally so.

Nearly all engines, in large operations, whether horizontal or vertical and direct in acting, or with "walking-beams" (see Fig. 83, *A A*), as in some blowing engines on the Lehigh River, at Catasauqua and Hockendauqua, Pa., and Scranton, Pa., where the finest and largest of this kind are to be found, owe their efficiency to the mechanical parts just described, variously modified to meet a variety of purposes. Some engines are arranged for reversing the action of the wheel, a con-

venience which becomes in some mines an absolute necessity. The principle is easily illustrated: Thus, suppose, Fig. 82, that the part of the eccentric rod  $GG$ , resting on the "rocking shaft," or "rock bar"  $YY'$ , itself turning or "rocking," that is oscillating, at  $H$ , should be so arranged that the end at  $Y$  could be raised to  $Y'$ , it is plain that a draw of the eccentric which now throws  $Y$  to the left would instantly throw  $Y'$  to the left and consequently reverse the motion of  $Y$ , and this would reverse the movement of the engine and keep it running on this reverse till the end of  $GG$  was restored to its former position and connection. Various ingenious motions have been invented, especially for locomotives, and adopted in various engines for hoists at mines, with the object of quickly reversing the engine.

Thus far we have the general principles of the steam-engine, and special improvements and adaptations will be treated of in another place.

#### TRANSPORTATION ON STEEP INCLINES.

In cars on very steep inclines, or where the angle of inclination changes, the wheels are in some cases (Fig. 84) run between rails  $SS$ , and the boxes or cars are covered so that the material may not fall out, even if there should be a change of slope from one side to the other of a vertical line. One side  $S$ , is partly discontinued in the drawing, showing the course of the ore from the car  $T$ , and its door.

The work of transportation consists of the running of the machinery, filling of the vessels, displacing and replacing



FIG. 83.

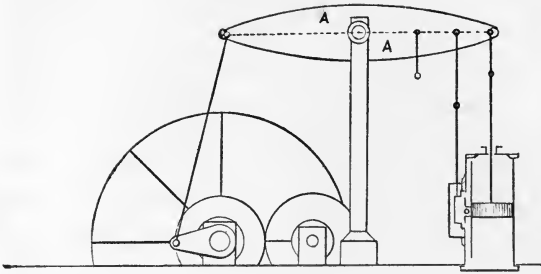

FIG. 84.

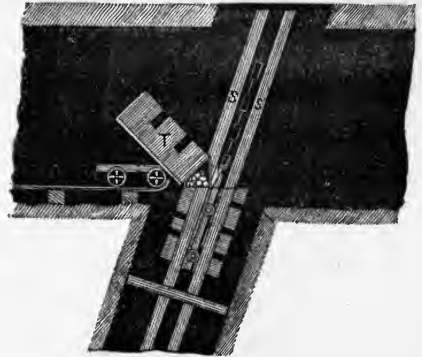
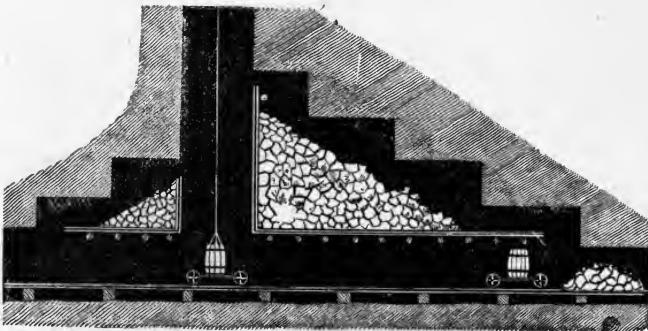

FIG. 85.





REESE LIBRARY  
OF THE  
UNIVERSITY  
OF CALIFORNIA.

the car or box and the emptying. Each of these employments demands a certain expertness and care. In order to give expedition, as well as security in transportation, various means and appliances are used; for example, instead of dumping material upon the ground from overhead workings, it is always advisable to dump into a box, barrel, or car, and then transport the car to the place of delivery, and raise the box, barrel, or car directly up to the surface. (Fig. 85.) A still more expeditious method is to use cages, generally constructed with iron rods, with a board floor and iron rails for the box on car-wheels. These cages are attached to the rope of the shaft; the full car, *W*, Fig. 86, is run from the working floor immediately upon the cage floor and securely fastened for hoisting upwards, whilst, at the same time, another cage with an empty wagon, or car descends. To prevent lateral motion, they are made to run between two vertical rails by means of a horse-shoe clamp, or guide, *A A*, and in order to prevent accident from falling of the cage, should the rope break, safety ratchets fall into places cut to receive them when the rope breaks.

Another kind of labor-saving expedient relates to the emptying and preservation of vessels. These arrangements consist chiefly in movable floor or sides furnished with slidebolts or springs and latches, by means of which the car is opened and closed.

Sometimes the emptying is effected by a dump-cart (see Fig. 84, at *T'*). In some cases the loaded vessel is raised higher than the mouth of the shaft, and advantage is taken of this higher grade to allow the loaded vessel or car to pass,

by gravity, upon a tramway to a distant place of deposit or delivery.

Another plan is to raise the car, then rolling it off aside to an inclined shute, attaching a hook to the back which prevents the car from passing down the shute, and after emptying returning it to the cage or platform upon which it was raised from below.

FOR INGRESS OR EGRESS OF WORKMEN ladders have been used, placed at an angle of  $60^{\circ}$  to  $70^{\circ}$  upon landings, or platforms, twelve feet apart (vertically); the openings in the landings are not placed immediately under each other, but alternately on one side of one landing, and on the other side of the next. Nothing can therefore fall directly down. Fig. 87. Where the depth is not great, climbing trees are used (see Fig. 88), placed at a considerable angle, not, however, too horizontally, and the cuts deep and not slanting, but at right angles to the treading edge and side of the tree.

Another plan, suitable for narrow ways, is by a series of rounds like parallel ladders, down which the workman passes, placing his feet alternately upon one and another round.

All these consume time and annoy the workmen when any depth is to be traversed; hence other and more effective methods are adopted.

One method is that shown in Fig. 89, wherein are represented two series of platforms fastened to rods, and placed at equal distances, and so worked by machinery above that they move alternately upward and downward. There are hand-rails represented in the figure, and the workmen pass

FIG. 86.



FIG. 87.



FIG. 88.



FIG. 89.

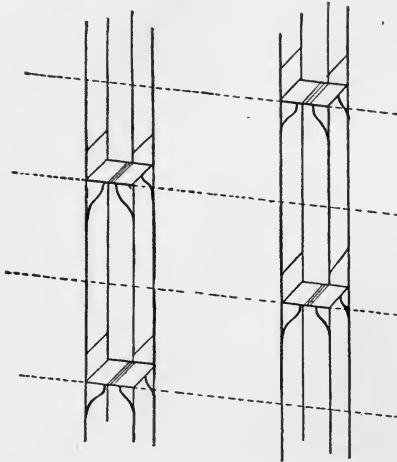

FIG. 90.

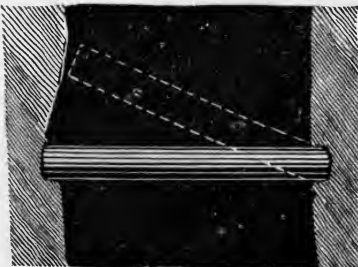
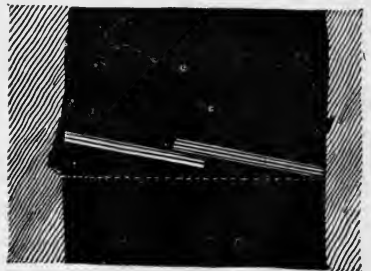

FIG. 91.





REESE LIBRARY  
OF THE  
UNIVERSITY  
OF  
CALIFORNIA.

alternately from one to another platform in ascending and descending.

### TIMBERING AND MASONRY.

When the rock of a mine is not perfectly firm, it has to be supported and pains taken to guard against a crush while the mine is made accessible in all its parts. This calls for the work of mining-timbering and masonry.

If the spaces are to be self-supporting, this rock must not only be firm, but whole, and the form of the spaces must approach the circle or some other curve. The greater or less firmness will also depend upon the direction in which the excavations pierce the structure of the rock. A tunnel, for example, which runs in the direction of the strike of the rock, or a shaft whose sides are parallel with the same, will not be so secure as when they cross that direction.

Well-known means of supporting open spaces in mines are by pillars of native rock, or that left standing from original rock, and supports erected from waste or rejected material. For the former purpose, that rock of least value is used; if, however, valuable ores have to be left as supports, care should be exercised that, at some later period, this material may be recovered. For artificial pillars, the rubbish is used, or if the ore does not furnish sufficient rubbish, a quarry is made in some other part of the mine or rocks are brought from the surface. An underground quarry may be made by digging out a space, supporting it for a time, and then permitting it to crush in, thus affording material, but

keeping open all approaches to the quarry. The bringing of rock from the surface is too expensive and only admissible in extreme cases, and then such rock should be used as counter-weight in drawing up useful material or sent down in shutes, if possible.

If the above-mentioned simple means are not sufficient, timbering or masonry has to be resorted to. The question is which of the two may be most suitable and advantageous. When wood is scarce and not always attainable and expensive, and when because of the great frangibility of the rock, and the great pressure, strong and heavy timbering is necessary, or when on account of imperfect ventilation, the timbering must be frequently changed, and further, when the mine is to be kept open a long time, and, finally, when in or near the mine good and cheap stone is to be had, there and then masonry certainly deserves the preference, even if it should cost more at the outset, for by its longer duration it will abundantly make up the greater first cost. Frequently, also, a dry wall may be constructed with great advantage and at small cost. Before either method of timbering or masonry is adopted it must be determined from which side the greater pressure comes, and how great it is.

#### MINING CARPENTRY.

In timbering, much depends upon the nature and selection as well as the preparation and placing of the timbers. In mining timbers as a general fact the cone-bearing trees—firs, pines, and the like—showing acicular leaves, are pre-



ferred to the broad or flat leaf bearing trees. However, among the latter, the oak is the best. Even when it is high priced the best and most durable wood should be used, because the expense of frequent renewal is avoided. In selecting wood, choose straight pieces, and use more and stronger pieces according to the pressure, remembering that it is better to have too much than too little. So far as the preparation is concerned, avoid weakening the wood by too much cutting away either in tenons, or in dressing. As a general thing timber is used unhewed, in order that none of its strength shall be lost.

In regard to the position of timber it is a well-known fact that every piece of timber can support a greater weight longitudinally than laterally, and hence vertically than horizontally, and supports the greater amount of pressure at right angles to the grain. So also in pieces of the same thickness, a short piece will support a greater weight than a long piece.

In order to secure greater durability in timbering the main parts of it are let into the rock. Fig. 90 represents a niche cut sloping from the top into which the beam falls and is held permanently, while, at the opposite side, the hole is only large enough to receive the end of the beam. For measuring accurately two rods may be used, which, held together and slid outwardly, may be marked and the measure obtained as in Fig. 91. The beam is then cut accurately, so as to be firmly wedged in place. Should the rock on either side be brittle or soft, it would not be wise to put the ends

of the beams immediately against it, but they must be made to rest against pieces and upon plates or sills, as in Fig. 92.

The timber is intended to be either permanent or temporary. The permanent is constructed with a view to long duration, the temporary for only a short time, until it can be replaced by more permanent timbering or masonry.

If in a gallery or drift only one wall overhanging or underlying is to be supported, it is done by putting one end of a cross-beam, Fig. 93, into a groove of solid rock and wedging the other end firmly or tightly against the wall to be supported. Should the wall itself be brittle, a wall-beam *R* must be placed against the wall and the pillar or stay-beam be securely wedged against it, Fig. 94. Should both walls be insecure, two such beams must be used, Fig. 95. In galleries and drifts a side wall is secured by posts let into a groove at the bottom and wedged against the weak side, Fig. 96. Should the side be firm, but the roof brittle, the beams are put into the grooves, Fig. 97, and covered with slabs. Fig. 98 represents the method of timbering in approaching movable and loose masses of soil or rubbish, also for draining and ventilation, being the strongest timbering in narrow ways.

When the side and the roof need support the method is as represented in Fig. 99. If both sides and the roof are to be secured, three-quarter frames are used, as shown in Fig. 100, or whole frames, as shown in Fig. 101. The frames consist of the posts *SS*, Fig. 102, and the cross-piece *K*. They are framed into each other; the projecting parts *C*, *D* are called the foreheads and *E* and *F* the faces. The thickness

FIG. 92.

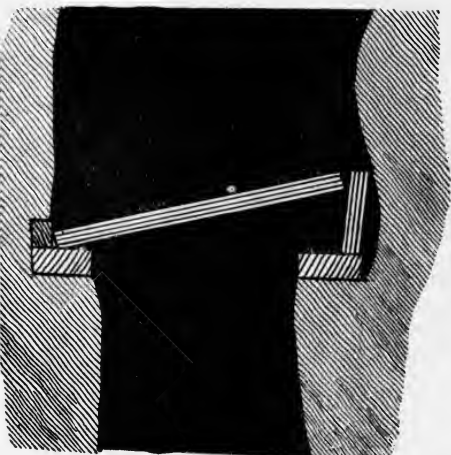

FIG. 93.

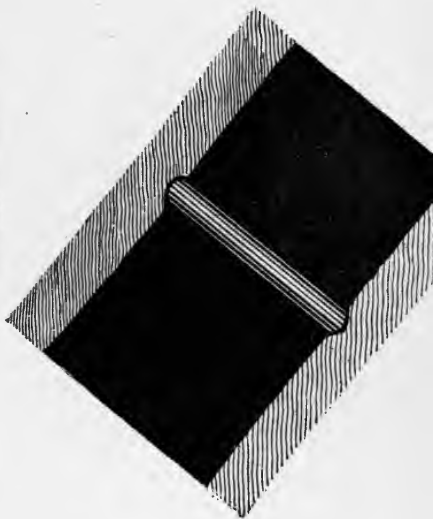

FIG. 94.

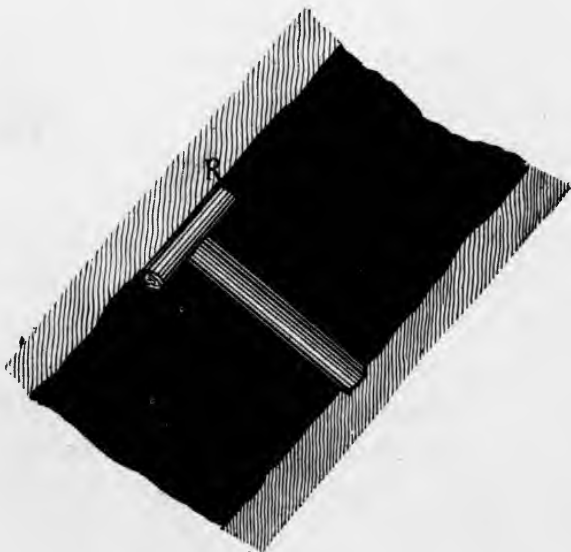



FIG. 95.

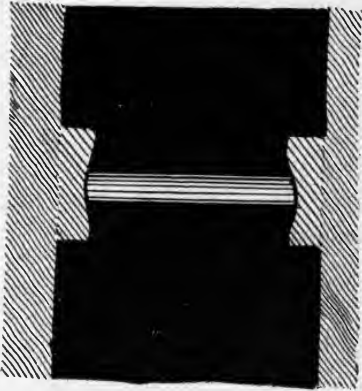

FIG. 96.

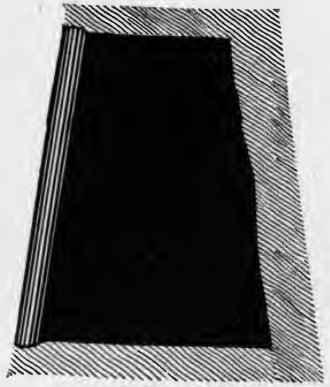
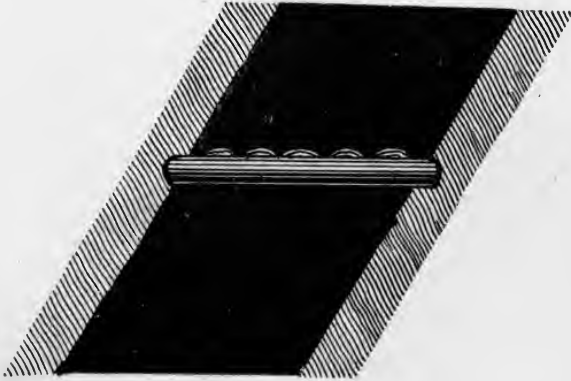

FIG. 97.





REESE LIBRARY  
OF THE  
UNIVERSITY  
CALIFORNIA.

FIG. 98.

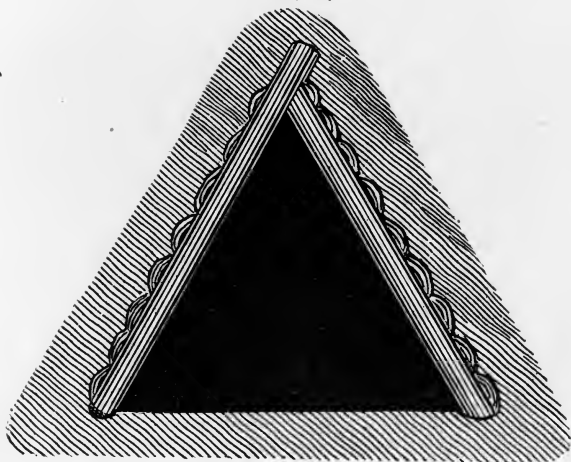

FIG. 99.



FIG. 100.

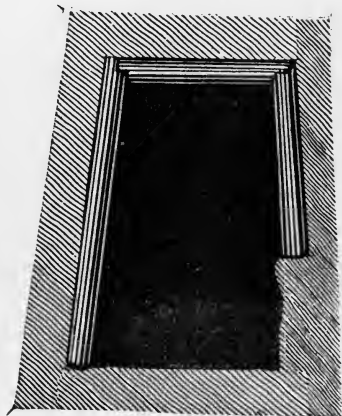





PLATE XXIII.

FIG. 101.

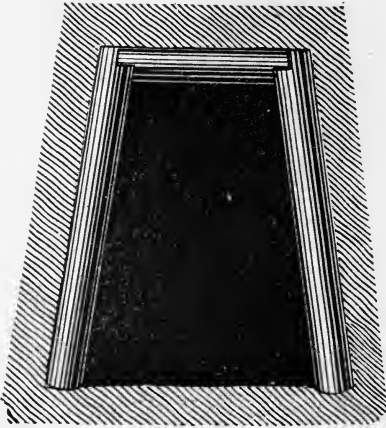

FIG. 102.

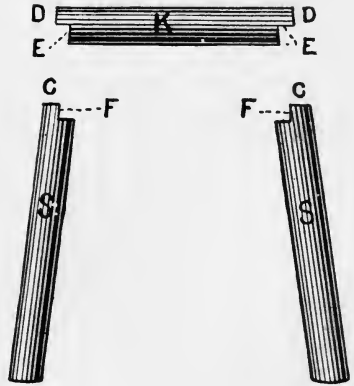

FIG. 103.

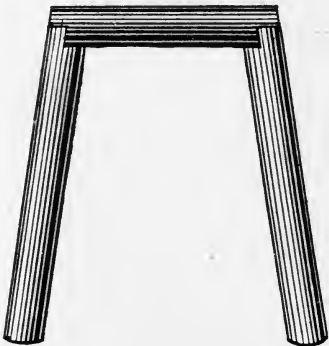

FIG. 104.

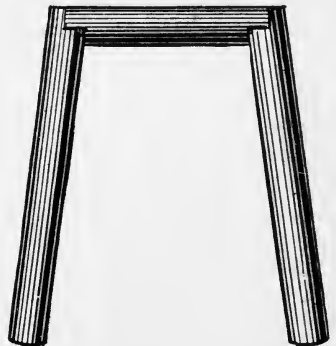

FIG. 105.

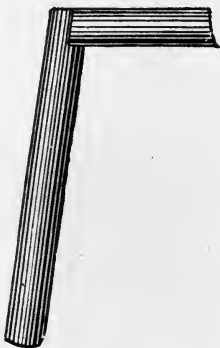
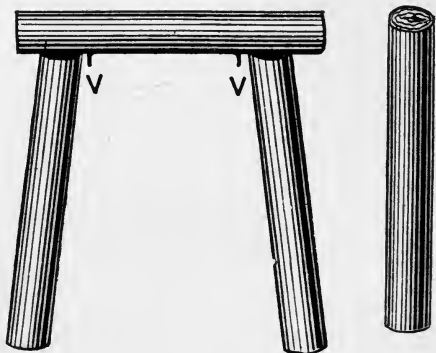

FIG. 106.





REESE LIBRARY  
OF THE  
UNIVERSITY  
OF CALIFORNIA.

of the posts used for frames is generally from seven to nine inches. Since shorter beams can sustain (overhead) a greater pressure, and also require less wood, the two posts are generally made to incline toward each other. The posts must be placed at right angles to the course of the gallery or of direction and be of equal height or length in order that the cross-beams may rest upon them horizontally and that the pressure may be equally distributed.

The method of framing depends upon the direction from which the pressure comes and upon its force or amount of pressure. Should the pressure be equal upon all sides and not very great, then the cross-beam is placed as in Fig. 103; but, if the side pressure predominates, then as in Fig. 104; and if the pressure be very great, then as in Fig. 105. Great pressure from above is met with frames whose posts and caps are not scored in, as in Fig. 106, where the posts at the head or end are only hollowed out to receive the cap. In order that the posts may not be displaced, projecting spikes or pins, *VV*, are driven into the cap pieces close to the posts. To give the frame a still greater strength additional cross-wedges or braces are placed between the posts under the caps, as in Fig. 107, and kept in place by spikes.

In salt mines, posts and caps are formed together in a very simple manner, in order to resist a very great and uniform pressure. The posts at the head are sawed and beveled in such a manner that the cap lies with a flat face upon the head, and then the edge of the inner corner of the post is hewn off, as in Fig. 108, *B*. In the *A* form the cap log is

hewn off to an acute angle, that the lateral pressure may tend to a more nearly vertical direction.

When the floor is loose and soft, and the posts are liable to sink, ground sills have to be placed under them, as in Fig. 109. When the frames are near to each other long sills are preferred, but when the frames are some distance apart short sills. The long sills *G*, Fig. 109, are unhewn logs which are placed in the corners of the floor, and upon which several frames are erected. When the pressure upon the sides is so great that both sills and posts might be crowded into the gallery, wedge braces have to be placed every six feet, which are hollowed out at the ends, as on *S S*, to fit the long sills *G*. The short ground sills *G*, Fig. 110, are placed across the floor of the gallery, generally let into the sides of the gallery rock-wall, and each sill carries its own frames.

The frames are placed farther apart, or nearer, according to the greatness of the pressure, and in the former case, if the rock be liable to crumble, the lining of slabs, or split logs, or saplings, Fig. 111, are used. On the outside of the frames, the split logs are placed longitudinally with the flat sides towards or against the uprights, and the empty space between them and the walls is carefully filled in with rock.

In ground altogether crumbling, or where old works are to be reopened by driving piles horizontally, then use timber half a foot wide, and made of split or sawn timber about six feet in length. When a loose face, or breast, of a gallery is to be opened and timbered, the first thing is to set an entire frame in place securely and then drive the above-

FIG. 107.

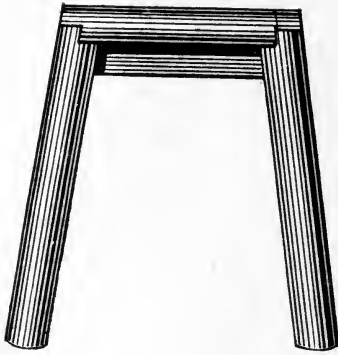

FIG. 108.

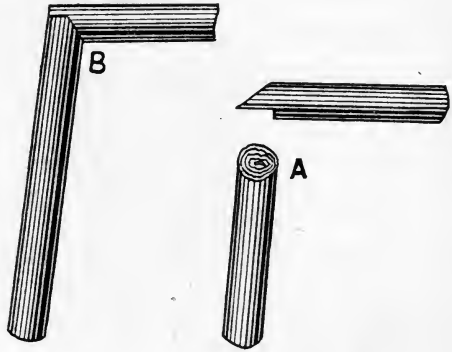

FIG. 109.

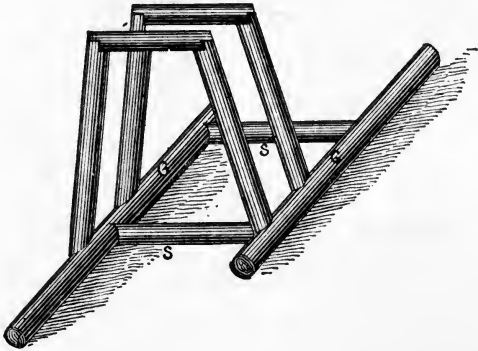
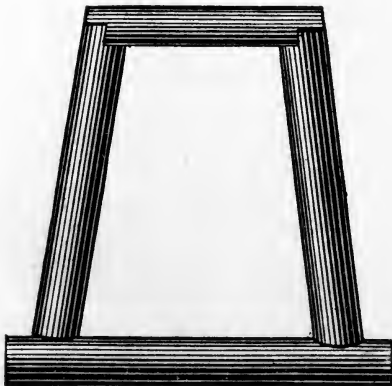

FIG. 110.



G

FIG. 111.





REESE LIBRARY  
OF THE  
UNIVERSITY  
OF CALIFORNIA.

FIG. 112.

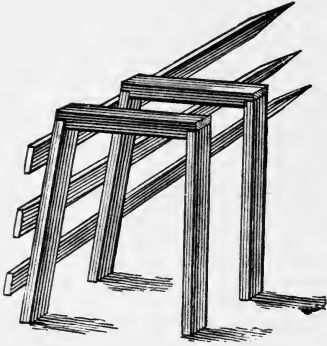

FIG. 117.

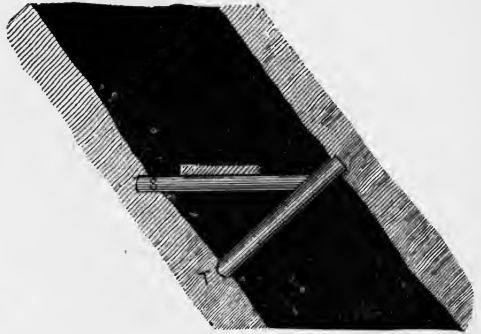

FIG. 113.



FIG. 114.

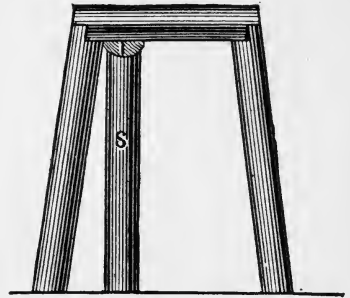
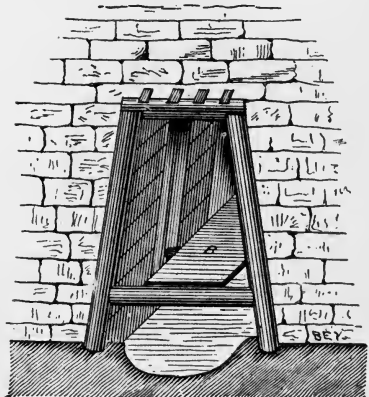

FIG. 115.



FIG. 116.





REESE LIBRARY  
OF THE  
UNIVERSITY  
CALIFORNIA.



mentioned wedges or piles on the outside of the frame two or three feet into the soil. The encompassed mass is then removed and the piles are driven in deeper. Should the ground be exceedingly loose, a second frame has to be erected before the piles are driven a second time, and in this manner we proceed until the piles are driven up to the full extent. (See Figs. 112, 113.)

In the case when the sides are firm and only the roof is brittle or soft, a cross-beam *A*, Fig. 113, is wedged in overhead; over this piles are driven close to each other upon a slight rise or angle of ascent until they have penetrated three or four feet. When the dirt is taken out, a second beam is placed, and then a third; then a new beginning is made at *A'*, and then proceeding as before.

When a side, or drift gallery, is to be opened from another and timbered gallery, the caps of the old gallery are supported on the side upon which the new drift is to be opened by post *S*, Fig. 114, and a cap beam or collar *I*; then the posts of the old frame are removed. (Fig. 114.)

If the floor of a gallery or drift is to be prepared for transportation and drainage, a timbered floor has to be constructed, and according to the amount of water to be drained off, this floor is raised from one to three feet above the ground. (Fig. 115.) In galleries untimbered, this is accomplished by placing in distances of six to twelve feet cross-beams from four to eight inches square let into the wall-sides upon which the flooring is placed. In timbered galleries the cross-beams are placed between the posts of the frames, as in Fig. 116. In placing the boards they should be closely joined and

fastened down with wooden pins. When the vein pitches considerably, so that the floor-beam cannot be let into both sides, as in Fig. 117, the post or sill-beam *T* is first let into the rock, and the floor-beam *S* is secured upon this.

The floor must have not only a direction parallel with the course of the gallery, but also be horizontal from side to side; therefore the boards before they are nailed are tried with the level, or by pouring a little water in a trough placed upon them.

When the water is drained off upon one of the sides in a ditch or gutter (Figs. 17, 18) then the board floor rests immediately upon the rock floor of the gallery on proper joists or scantling.

Floor for transportation is either a common open floor or tight floor; an open floor has only a single board *B*, Fig. 116. A tight floor is an entire covering, used, not only for transportation, but for ventilation. (Fig. 115.)

#### TIMBERING OF SHAFTS.

It is seldom the case that shafts are sunk for their entire distance in solid rock which requires no support. As a general thing all shafts require more or less timbering. This cannot be made permanent at once, but a preparatory, or temporary, timbering has to be used at first.

Timbering of shafts is thus commenced: upon the leveled ground the frame is laid; this frame consists of oak beams, ten by twelve inches, and the length according to the size of the shaft, allowing from two to three feet for the projections

FIG. 118.

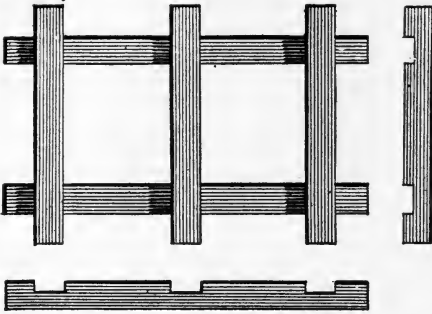

FIG. 119.

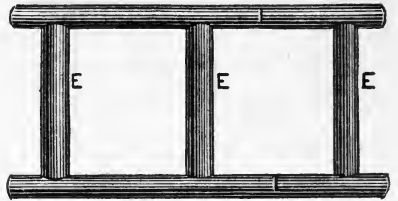

FIG. 120.

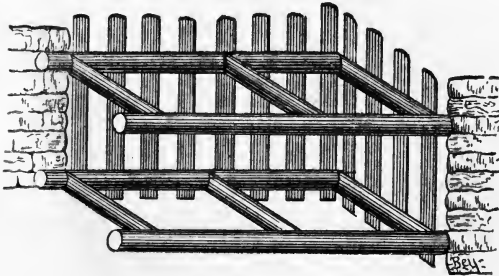
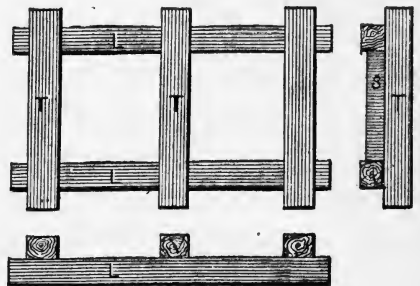

FIG. 121.





over the frame which are intended to be let into the sides of the shafts. (Fig. 118.) When the shaft is sunk from the surface, the first, or "day frame," has to be raised and set higher than the shaft mouth to obtain height of level for discharging material. This frame should be set to the exact position intended for the shaft, and the subsequent excavation is measured by a plumb line from its corner. To extract material a windlass is erected and also a pump, if necessary to remove the water.

As long as the excavation proceeds through insecure rock, temporary timbering of unhewn, but of barked wood is used. For this purpose holes are made into the corners of the shorter sides into which the beams *I, I*, Fig. 119, are placed; these are kept apart by cross-beams, *E E E*, according to the number of divisions the shaft shall contain. These parts are concave at the ends to fit the other timber, and all these timbers when placed, as in Fig. 119, constitute a lock frame. When the rock is very friable, the locks are placed two and three feet apart; when the rock is firmer, they may be farther apart. On the outside of these frames casings or linings are placed, as in Fig. 120.

When the shaft has proceeded with temporary timbering for some distance, and this is no longer sufficient for the pressure, steps must be taken for the erection of permanent timber. This must be begun by preparing a firm foundation. For this purpose holes are made into the long sides of the shaft corresponding with the partitions of the shafts, and into these cross-beams *T T T* (Fig. 121) are placed; these beams are square, and intended to carry the rest of the timbering.

Should the rock be insecure, long beams, *L*, are let into very deep holes in the shorter shaft sides, and upon these cross-beams, *T*, are placed, and to obtain still greater security braces, *S*, are placed between the long beams under the cross-beams or ties. Such foundation frames are placed at distances of from one to four fathoms, according to the firmness of the soil. If the ground is not sufficiently firm for the holes of the beams, they have to be furnished with ground plates and sills, as shown in Fig. 95.

The lining of shaft timbering may be constructed in three ways, as in Fig. 122, which is a vertical cross section, wherein the uprights *R R* are placed vertically between the two cross-beams *T T*, and to secure them still further the diagonal braces *G G G* serve to hold the lining logs, or slabs, against the sides of the shaft. This is especially suitable for the shafts wherein the only long sides *A B*, *A B* are insecure. In the second method the lining boards are vertically placed (Fig. 123), and the frames are placed upon stub-pillars at the corners, the partition cross-pieces are let into the longer beams, and to prevent the striking of the buckets, may be lined inside with timbers vertically placed. The frames are distant apart not more than three feet, the sub pillars being proportionate. This method is adapted to a firmer rock where the pressure is uniform upon all four sides. The space behind the lining must be filled up. This method of lining does not require hewn timbers, but it is sufficient if the frame which rests immediately upon the foundation frame, and every alternate one, be of hewn timber.

The third method, shown in Fig. 124, which consists of

PLATE XXVII.

FIG. 122.

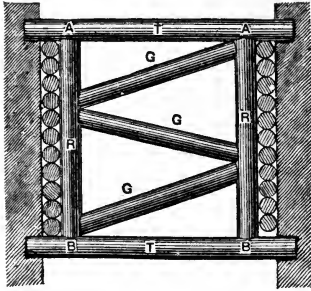

FIG. 125.

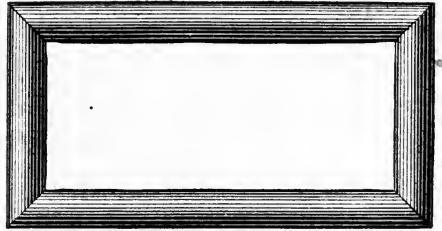

FIG. 123.

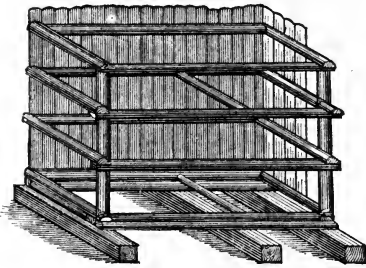

FIG. 124.

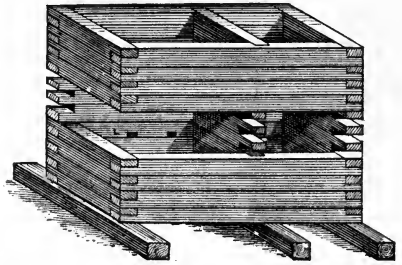

FIG. 126.

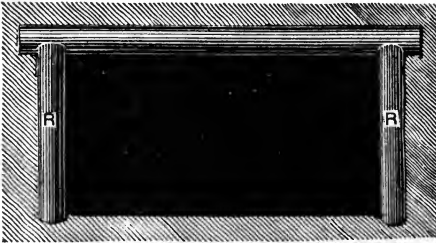

FIG. 127.







frames placed one on top of the other, is used when very great pressure has to be resisted and the ground is very loose. In order that no linings may be required, hewn timbers are used for the frames. Instead of joining them together by half tenoning, as in Fig. 124, they may also be joined by a mitre cut, as in Fig. 125.

When all the sides of a shaft do not need timbering, the firm side is left open. Supposing one of the long sides needs timbering, then the beam is let into the side, as in Fig. 126, and held against that side by the cross beams *RR*, which are concave against the sustaining beam, and let into the wall at the other ends. (Figs. 126, 127.)

In Fig. 127, we have the method of timbering when the short sides need timbering, and the long are firm.

When only portions of the shaft need timbering, either one or other of the already described methods may be used as needed.

As in the case of galleries, so in shafts, it may be necessary to proceed to pile-driving, as in Fig. 128. When the piles have been driven down from three to four feet below the upper frame *S*, and the loose material has been taken out, then follows a second local frame *S'*, and between the two, posts may be put at the corners, should it be necessary. Therefore the piles are driven deeper into the ground, and the method of procedure is as before.

When perpendicular shafts have several divisions, these must be timbered to answer the purpose for which they are to be used. When one is to be used by the miners alone, it is separated from the transporting shaft by a partition,

Fig. 87, *V*, which is nailed to the partition beams. Within the partition, platforms are made twelve feet apart upon which the ladders are placed, as in Fig. 87.

In the transporting division, care has to be taken that the buckets, or other vessels, do not strike or catch on the sides. In the other division (pumping or ventilating) platforms, similar to those in Fig. 87, are erected for the purpose of examining the machinery, and keeping it in order. The mouth of a gallery opening into a shaft ought to be provided with doors or way-boards to prevent accident. When a transporting gallery opens into a shaft, a place for filling the vessels has to be prepared. In order to its complete timbering, long ground sills are placed along its two sides, *G G G*, Fig. 129. Upon these posts, *S S*, are placed nicely fitted, and therefore, perhaps, concave at the lower ends; and upon the latter, long joists *II*, driven firmly against the ceiling, or upper wall, and when from friability of this wall, or great pressure, additional lining is needed, then an additional joist *M* is used with its corresponding support. This arrangement is adopted when a larger chamber is demanded whose width is greater than that of the gallery. Where such a chamber is situated in solid rock, all that is required is to provide timbering for it where it opens into the shaft. Here a sort of door-frame is erected. For this purpose holes are cut in the short sides, and a heavy sill is placed along the edge of the long sides *G*, Fig. 130; a joist *I* corresponding with the ceiling of the chamber furnished with tenon holes into which the posts *S S* are fitted. These spaces thus formed are either closed permanently as at *A*, or doors, *T T*,

FIG. 128.

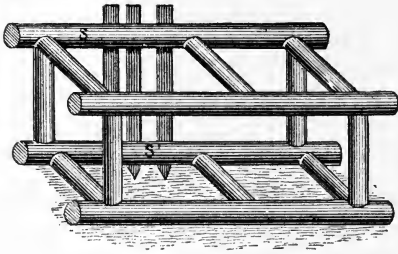

FIG. 131.

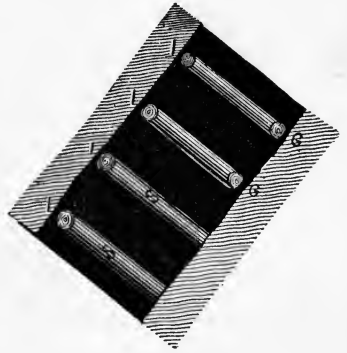

FIG. 129.

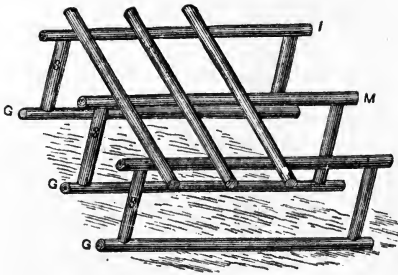

FIG. 132.

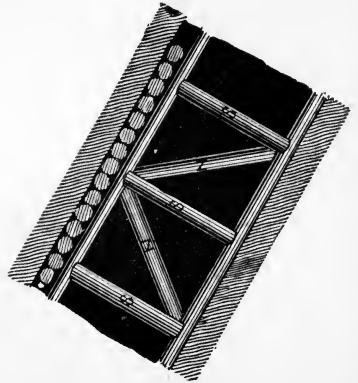

FIG. 130.





are provided which open into the chamber, and during the working hours are closed, and may be during other hours. Above, just below the joists, are placed two rollers *W W*, projecting slightly into the shaft to prevent friction on the joists when the vessel is drawn up. As a safety for the miners, supports *K K* are firmly fastened upon the two uprights *S S*. The space of the chamber is generally divided off by posts into several partitions for the reception of different kinds of material, and platforms are erected inclining toward the gallery away from the shaft.

#### TIMBERING OF INCLINED SHAFTS (SLOPES).

In slopes, the roof generally needs the most support. When, therefore, it is not perfectly safe, joists *I*, Fig. 131, are laid across the shaft, and propped up by posts *S*, truly fitted. These are perpendicular to the direction, and placed in holes, or, when necessary, upon floor joists, as seen in Fig. 131 at *G G*. These are placed nearer or farther apart, as determined by the nature of the rock or ground. When the overhanging rock is very brittle and unsafe, the joists are placed very near together. (See Fig. 132.) Under them are placed long plate beams supported on posts *S S S*, and with diagonal braces *Z Z*, if necessary, as seen in the figure; and also when necessary a ground sill is used. When the roof is firm, separate posts, *S*, are needed only for partitions of the inclined shaft, which are let into holes, or placed upon sills and to which slabs or boards are nailed. The partition through which the miners pass is furnished with platforms *B*, or steps *T*, Fig. 133. The former are placed upon the

ground floor from the overhanging to the underlying wall and the cleets or steps on the underlying wall. These cleets must have sufficient depth so as to hold the post. There is also a hand-rail, as seen in Fig. 133. For transporting vessels having wheels the floor of the inclined shaft is fitted with a tramway, or rail-track of ordinary iron or wooden rails, or such as represented in Fig. 70, or as in Fig. 84.

Shutes or transporting shafts, used also for miners' way, must be provided with a strong partition (see Fig. 134), and the shute itself, if it be irregular in inclination, should be furnished with a board floor in order that the material may the more readily slide down.

On the mouth of any shaft a shed should be built at first for the windlass and pump, and at a later period, when the shaft has been driven deeper, and machinery is necessary, a larger head-house should be built.

#### TIMBERING NECESSARY FOR WORKING IN MINES.

The open spaces arising from abstraction or withdrawal of mineral deposit demand special timbering. In working overhead when the roof has been hewn away to a certain extent, and the gallery beneath is to remain open, a timber ceiling is prepared by placing joists *E*, Fig. 135, across the gallery at the usual height, which joists are let into the walls and covered with suitable lining or flooring, and upon this rubbish is cast. In very steep veins the joist is placed as shown in Fig. 135 by dotted lines *E'*, in order that the underlying rock may bear more of the weight. When the overhead working has proceeded for some distance, and the

FIG. 133.

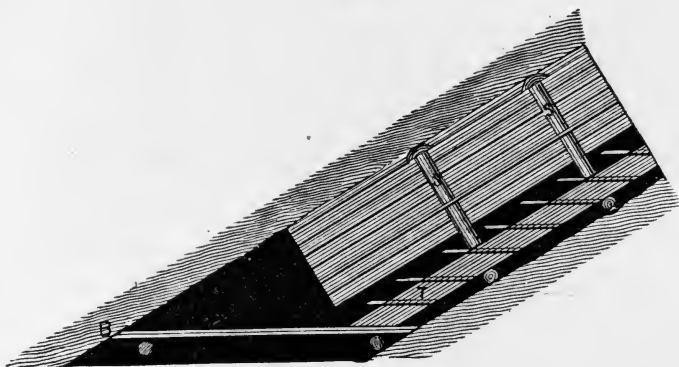

FIG. 134.

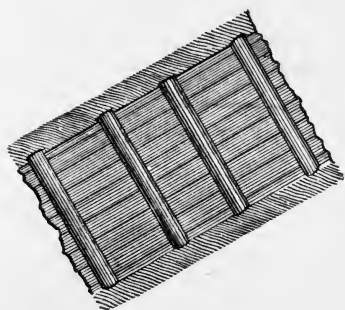

FIG. 135.

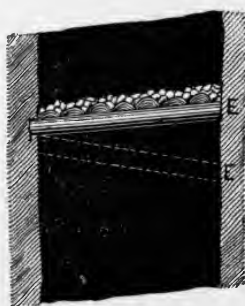

FIG. 136.

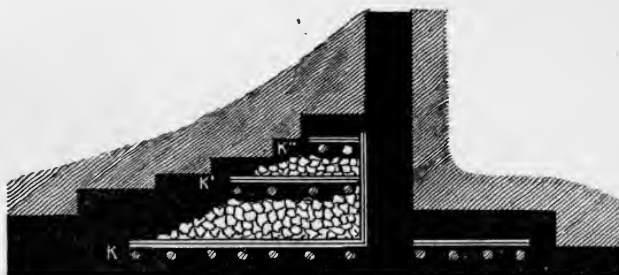





FIG. 137.

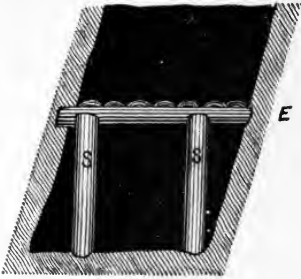

FIG. 138.

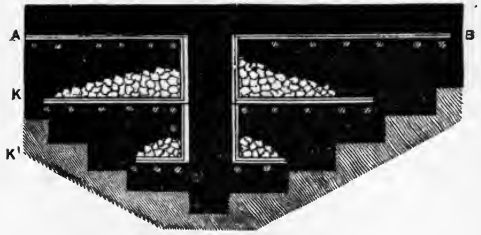

FIG. 139.

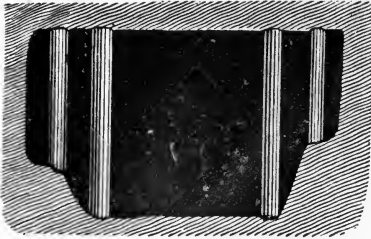

FIG. 140.

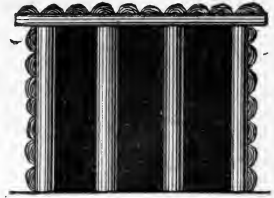

FIG. 141.

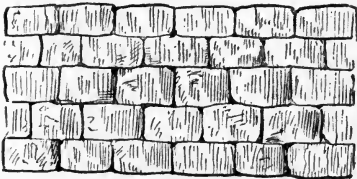

FIG. 142.

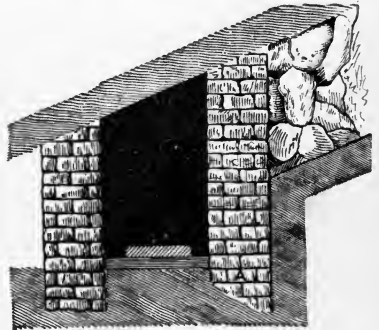
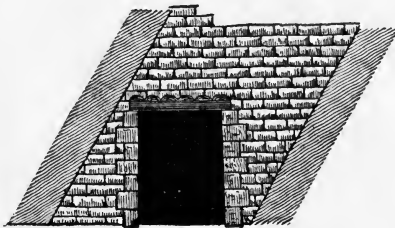

FIG. 143.





REESE LIBRARY  
OF THE  
UNIVERSITY  
CALIFORNIA.

mass of rubbish becomes too heavy for the first set of timbers, as in Fig. 136,  $K$ , then at suitable distances other timber has to be provided, as  $K'$ , in order to distribute the weight of the rubbish. When a vein, or lode, has considerable thickness, and the joist  $E$ , Fig. 137, as a consequence, has to be long, it is supported by posts  $S S$ . In working downward on benches, as in Fig. 138, where  $A B$  represents the floor of the gallery which has been cut away and replaced by timbers, the method of procedure is as follows: Joists, as under  $A B$ , are placed in holes in the sides of the wall and a suitable floor upon them. Now, as the steps descend, still lower additional floors,  $K K'$ , are constructed to receive the rubbish.

In taking out the ore from large deposits, the method of timbering is essentially the same as that already described, only on a greater scale. Sometimes it is sufficient to use simply posts or props (see Fig. 139), or box pillars may be used, or door-frames with several posts, as in Fig. 140, or the method is adopted as suggested in Fig. 129. It must be borne in mind that in timbering larger spaces stronger timbers are needed, and a method of joining, or combining them, which will give the greatest resistance or durability.

#### RENEWING TIMBERING.

When a timber decays, or when a break occurs in the same, the insecure has to be replaced by that which is new and strong. For this purpose the timbering should be constructed in the beginning so as to facilitate these repairs, that is, in such a manner that any piece may be taken out

and replaced by another without tearing to pieces the whole frame. These repairs should be made in good time, so that danger or loss may be avoided.

When single frames are to be replaced, the new cap is put against the ceiling, the posts are put into the holes, and driven or wedged against the cap in order that the posts may not yield. Pegs, as in Fig. 106, are driven in, or cross-braces are used, as in Fig. 107. In replacing shaft timbers, the work proceeds from below upwards. The support of the upper portion must precede the work. The first thing is to erect a firm platform at the place where the repairs are to be made. The beams upon which the platform rests may be placed upon the lock-frames represented in Fig. 122, *T T*, or upon any of the frames, Fig. 123; but where the shaft is timbered according to the method in Fig. 124, holes for the reception of beams six feet apart vertically ought to be left. (See *L*, Fig. 124.) Before a frame is removed, the one immediately over it is propped up securely by braces until the defective frame is removed and the new put in its place. Where single frames are to be removed from shafts, as shown in Fig. 124, posts or timbers which have the ends fitted to the proper curvature are wedged in upon the sides separately, that is, one by one.

### MASONRY.

Walls of the gallery are either wet-laid, or are dry walls, that is, laid in mortar, or without mortar; straight or curved, level or arched. In ordinary walls the stones are laid flat and the wall rises perpendicularly. In arched masonry, the

stones receive a wedge-shape form and the walls ascend in a curve.

A durable masonry requires good and suitable materials, a firm foundation and exact joining of the stones. The most suitable building stones are thick table pieces with broad, long, flat faces. In arched masonry the stones are generally specially prepared.

In order to prepare good common mortar, from six to ten parts of sand are taken to one of lime slaked; the mass is stirred while the water is being added, and it is best to make only as much as can be used up in one day. When walls are to be built in a damp place, or where there is a great deal of water, it is better to use hydraulic mortar which hardens in the water. This is prepared by adding hydraulic cement or plaster of Paris. Such an addition is of advantage to common mortar because mines always are more or less damp. The foundation of the walls should, if possible, be made in the solid rock, but when this cannot be done, large stones should be used or arches constructed.

For a proper joining of stones it is necessary that they should lie flat upon each other, and that some should be used as runners, that is, presenting a long face on the wall front, and others as binders, that is, running inwards and across the wall from front backward.

It is of course understood that each stone shall cross the joints of two others underlying (see Fig. 141), or, as it is called, "break joint;" the outward faces ought not to project, but must fall in line in one plane, and the interstices should be filled with spalls and mortar, and, in dry walls, with moss

and spalls. Behind the wall this space should be completely filled up either by rubbish or dry wall.

Before beginning a wall a sufficient space has to be cleared ; in order to do this the gallery is made larger, when first driven, by the thickness of the wall to be put up, or enlarged afterwards ; then the direction and the amount of pressure have to be determined ; the greater the pressure the thicker the wall, and its main strength is applied toward the main pressure. The strength of a wall depends upon its thickness, the proper joining of the stones, and upon the size of the stones. Small stones are more difficult to be united, and require more mortar, and afford on that very account less strength.

To oppose or resist a slight pressure upon the sides it is frequently sufficient to erect a dry wall, and a mortar wall is certainly strong enough. To give to such a wall a firmer position, the ground is excavated to some depth, and, on the side of the pressure, the foot of the wall is made to slope or slant downward toward the pressure, as *A* in Fig. 142. A level wall is used also when galleries are to be constructed in large excavated spaces. The wall is built up of large pieces of rock and filled up behind to the overhanging and underlying wall to the limits of the chamber. On top of the wall caps or joists are placed which are covered with suitable covering and walled over or covered with rock. (Fig. 143.)

Where great strength and durability are required arched masonry is used. The arch and the semicircle are the curves generally employed, also small segments of a circle, and the ellipse, which has either an egg shape, an oval, or elliptical,

as the pressure, the height and width, etc., may demand. In arched masonry or in vaults we distinguish the span, the height, and the strength. By the span is meant the length of the arch, or the distance  $AB$ , Fig. 144, measured between the two feet of the arch inside. By the height is understood the perpendicular distance from  $AB$  to the highest point of the arch  $D$ . The thickness or strength of an arch is represented in the figure by the thickness of the wall. The supports for the feet of the arch are called the holding.

The arches themselves are either whole, that is, closed on all sides, or half, that is, such as have only a half of the curved line; or partial, that is when the curve is smaller than a semicircle.

The length, or span, and the height of the arch stand in a certain relation to each other, that is, for any six feet of length two feet of height are usually reckoned. When the span is greater, the height is usually shorter than the above ratio in proportion, in order that the vault may not occupy too much room and require too much labor in its erection. But since its supporting power is thereby weakened, it receives greater thickness. The height of the arch must be proportioned to the pressure, and in such a way that all the vaulting may have a uniform direction to the centre. The beds are hewn into the solid rock or prepared by masonry. The surfaces must lie in the same line with the radii  $CA$ ,  $CB$ , which determine the arch. Fig. 145.

In order to give to an arch the proper curve, forms or patterns are made of boards. These are joined together and cut according to the curve desired, and then so placed that

the arch may be built upon it. The radius of the form, or curve, must, however, be from one to one and a half inch shorter than that of the desired curve, because upon these forms a shield is nailed upon which the arch is built. Moreover, these patterns must be so placed as not to obstruct the free passage.

Fig. 146 represents the form for a semicircular arch. At *N* a nail is driven to which the string is tied for describing the curve. Instead of disposing the boards as in Fig. 146, they may be placed as in Fig. 147, where the nail is driven into a stake at *P*, and the boards so placed as to receive the curve symmetrically. Only when the curve has been described are the boards secured together and sawed off at the ends and along the curve. To prepare an elliptical form or curve the boards are placed together as in Fig. 148, and upon these a cross forming right angles is placed, and upon the strips forming the cross lines are drawn intersecting each other, as in Fig. 148 at *C*. From the point of intersection, half the height of the tunnel is marked off at *A* and *B*, also half the width on the other arms at *D* and *E*, remembering that allowance must be made for the thickness of the shield. *AB* now represents the greater and *DE* the smaller axis of the ellipse. Half the smaller axis is measured off from *C* on the larger axis at *F* and *G*, then these points constitute the foci of the ellipse. Into these points nails are driven. Now if the pencil, or scribing point, be held at *D*, and a cord or string passed tightly around the pencil and the two nails, and tied, then by moving the pencil around either to the right or left, we shall have the ellipse of the



FIG. 144.

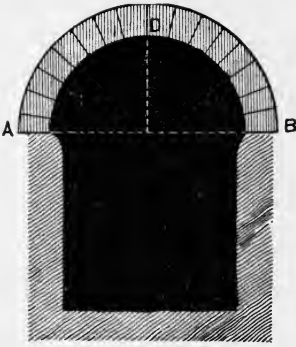

FIG. 145.

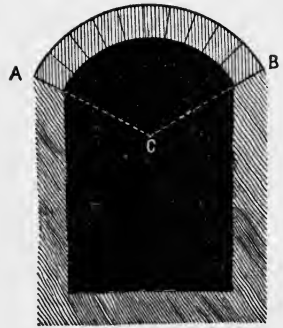

FIG. 146.

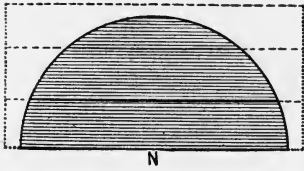

FIG. 147.

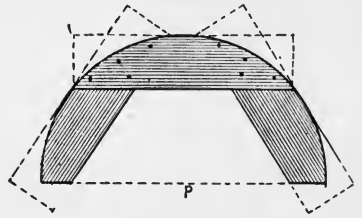

FIG. 148.

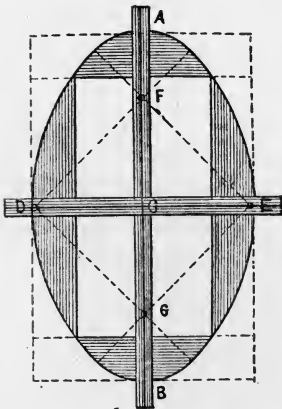
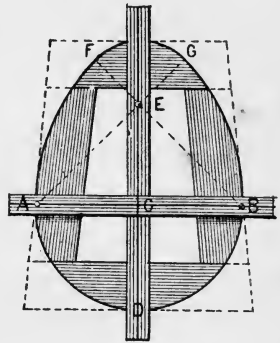

FIG. 149.





REESE LIBRARY  
OF THE  
UNIVERSITY  
CALIFORNIA.

Fig. 148. The length of the axis in elliptical vaults or tunnels should depend, not simply upon the space of the tunnel, but also upon the pressure the walls must sustain. Should the main pressure be from above, the minor axis is shortened; if the pressure comes from the sides, it is lengthened. But it should never be shorter than the major axis.

Fig. 149 represents the manner of constructing the egg-shape pattern. Upon the frame represented by dotted lines a cross forming right angles is placed, furnished with lines as already mentioned; from the point of intersection of these lines,  $C$ , half of the width of the tunnel is measured off toward  $A$  and  $B$  and also toward  $D$ , and with this radius the lower semicircle  $A D B$  is described. Through  $E$  and  $B$  indefinite lines are drawn. Make  $E C$  equal to  $A C$  and through  $E$  draw lines of indefinite length,  $A E$  and  $B E$ , then, using  $A B$  as centres with a radius equal to the entire width of the tunnel, describe curves  $A F$  and  $B G$ , and finally with  $E F$  or  $E G$  as radius describe the curve  $G F$ . The pieces of the elliptical or oval forms are securely nailed together and fastened with laths or strips across the corners.

For the construction of an arched tunnel, a number of patterns must be had in readiness, but if the tunnel is long the first used may be taken away and applied for the continuation as soon as the wall is sufficiently dry. The forms are placed at intervals of from two to six feet, upon wooden tressels (as in Fig. 150) or upon the rock bed. The long timbers  $A A$  are placed upon the supports  $S S$  of a frame in such a manner that their upper faces will be in a line passing horizontally along the gallery and against the wall

to bear up the lower edge of the form, and may be supported by tressels as in Fig. 150, or by posts as in Fig. 151.

After placing the forms as above described, a shield or lining is nailed upon them. (See Fig. 152.)

The building of the arched wall is begun by preparing the bedding. To give to this a proper direction, a line is stretched along the side of the gallery and also one crosswise in direction of the radii of the arch, and in accordance with these lines the bed is hewn out. When the rests, or beddings, are prepared of masonry, the ground must be level, and the stones laid level, as shown in Fig. 153. From both these beds the arch is begun at the same time. Upon the form, or wooden pattern, stone upon stone fitted together by slight taps of the hammer are laid, and when they come near enough to each other the wedge-shaped keystone is driven in by interposing a piece of wood between it and the hammer, lest the stone be broken by the hammer. At the beginning the arched wall is made a little thicker than at the top, the interstices are finally filled with little rocks, and the space above the masonry filled in. When the work on the arch has to be interrupted before it is completed, segments are wedged apart, as shown in Fig. 154, by posts, or, if the segments are near each other, by a piece of wood, as in Fig. 155. If water is found behind the wall, then holes are let into the wall at proper intervals to draw it off.

In mines, dry walls of greater thickness are preferred to mortar walls because the oozing water dissolves the mortar and loosens the walls, whilst in a dry wall the water can easily run off, and a sediment may collect on the wall which may help to strengthen it.

PLATE XXXII.

FIG. 150.

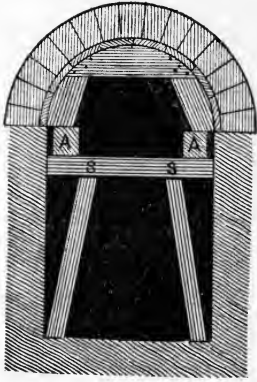

FIG. 151.

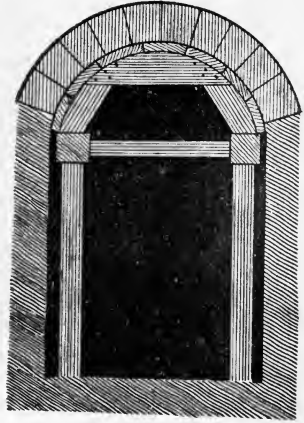

FIG. 152.

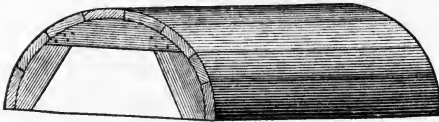

FIG. 153.

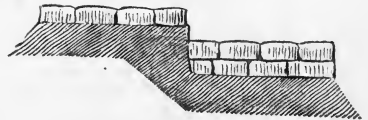

FIG. 154.

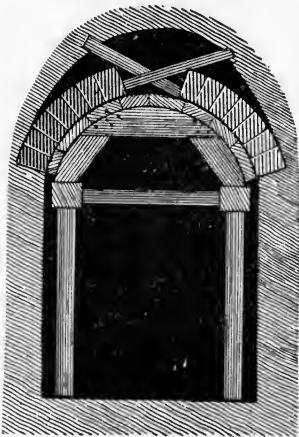

FIG. 155.

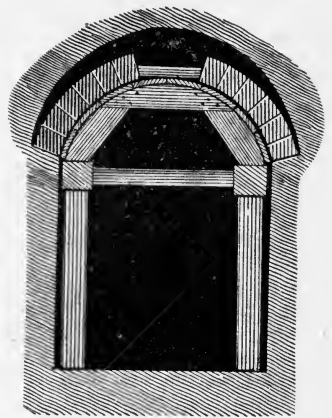



FIG. 156.

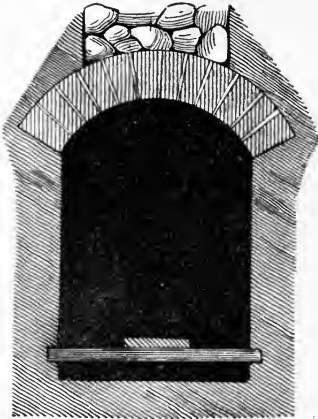

FIG. 157.

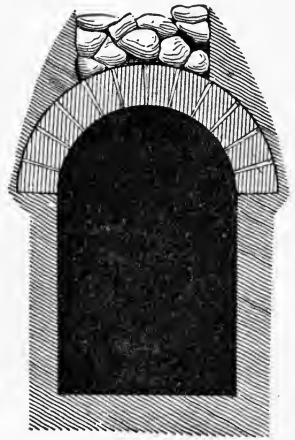

FIG. 158.

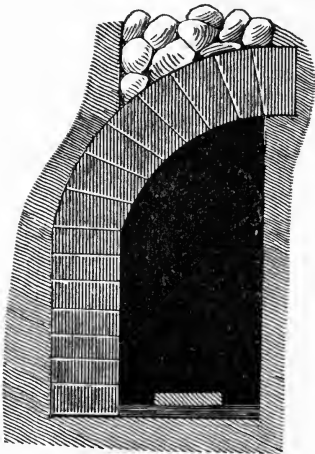

FIG. 159.

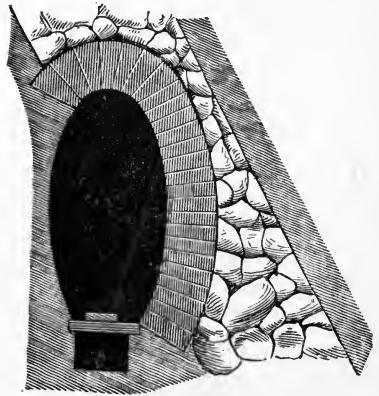

FIG. 160.

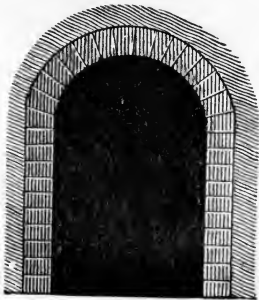
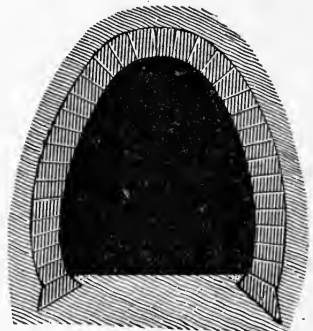

FIG. 161.







Arched walls are protected against water by putting a coating of clay over them. (Figs. 156, 157.)

When a gallery or drift is to be arched in, the nature of the arch will depend upon whether a partial or entire arch is demanded. Should only the roof need support, a short, low arch (Fig. 156), or a semicircle (Fig. 157), is adopted, the beds of which are hewn in the solid rock. When the roof and one side only require protection, and the lateral pressure is slight, then a level wall is built upon the side, and upon it a partial arch. (Fig. 158.)

When the pressure is great upon one side, a half vault is erected. (Fig. 159.) Should both sides and the roof need protection, then, if the pressure upon the two sides is not too great, Fig. 160 represents the method. If the pressure upon the sides is very great, Fig. 161 is a representation of the proper method. All these methods presuppose that the floor is firm. Should the floor also need masonry, it receives an oval form, as in Figs. 162, 163. That represented by Fig. 163 is preferred where much water is to be drained off.

In main galleries, or adits, it is customary to build a drainage canal or sluice. Should the floor be firm, the canal assumes the form in Fig. 164. Should it be unsuitable for draining, an inverted arch is used, as shown in Fig. 165, or a close arch forming a pipe, as in Fig. 166. In the latter case holes are left at suitable distances over the upper side, so that the pipe may be cleared in case of stoppage. The bricks of all such arches must be securely filled in, or coated with clay, and upon them the tramway is laid. When water comes from the ceiling or the sides, it is led by means of pipes through openings in the arch into the canal.

The joists for the tramway, when these cannot be let into the native rock in the sides, are either walled in, as in Fig. 167, or openings are left at proper distances for their reception, leaving larger openings upon one side of the gallery to provide for the putting in of new joists in case of decay. The floor joists may also be placed upon benches, as shown in Fig. 168, or, finally, they may be walled into the rubbish, as in Fig. 166.

### MASONRY FOR SHAFTS.

The walling up of shafts depends, in its main features, upon the same rules as the timbering. The shafts, according to the firmness of rock, are either walled in entirely, or only partially.

In perpendicular shafts a temporary timbering precedes the masonry. The walls are built from below upwards, and rest, like a foundation framing, upon main arches corresponding to the long pieces of a frame as represented in Figs. 169 and 170, at *L*, and upon shorter arches corresponding to the short beams of the foundation frame, as at *T T*, Fig. 170.

These arches are put at intervals from two to four fathoms according to the nature of the rock, and rest, in all cases, upon deep and sufficiently firm bedding. The main arches need a thickness of from three to four feet; upon them the level wall *M* is erected. (Fig. 169.)

The partition walls *S S* are also furnished with inserted arches *R R*, Fig. 169, which walls are built up along with the main walls to the thickness of from one-and-a-half to

FIG. 162.

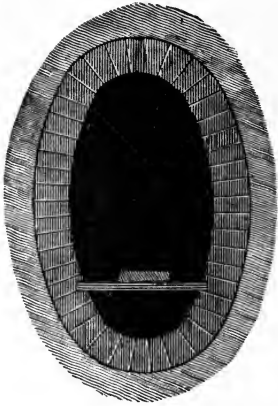

FIG. 163.

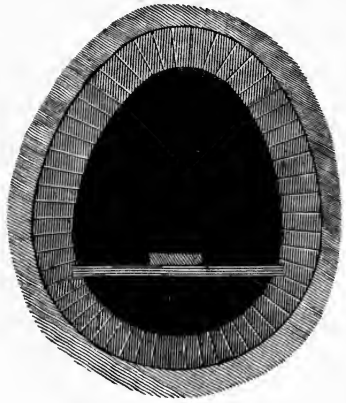

FIG. 164.

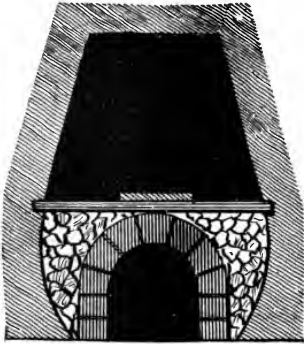

FIG. 165.

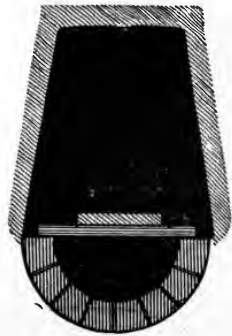

FIG. 166.

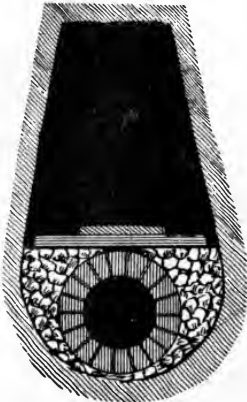

FIG. 167.

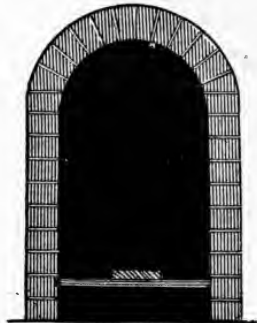



FIG. 168.

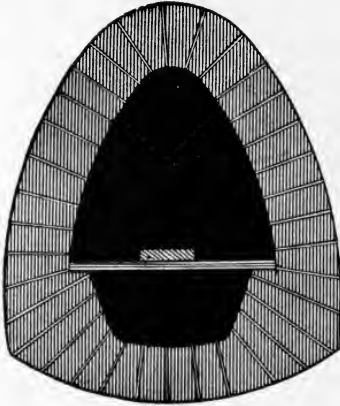

FIG. 169.

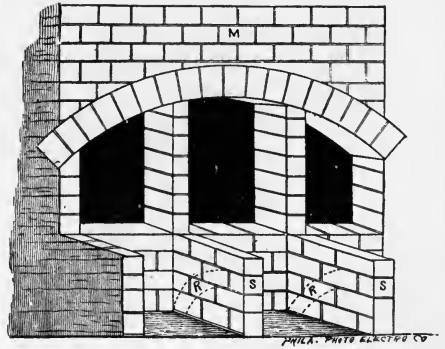

FIG. 170.

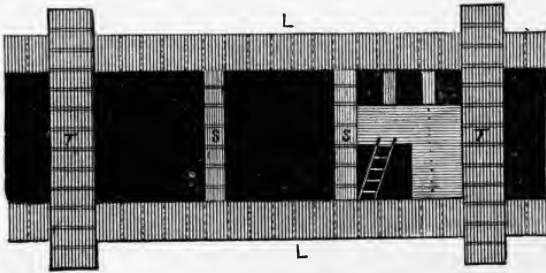
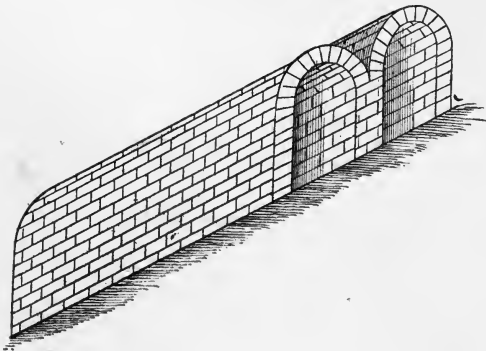

FIG. 171.





two feet. These partition walls are also furnished with openings into each other, provided with frames as shown in Fig. 130, and arched over.

In swamp lands, if shafts are to be masoned, the following method is used: A continuous or close wall is placed upon a strong oak frame, until it sinks by its own weight into the soft soil. The inclosed mass is taken out and the wall built up higher.

The masonry of inclined shafts or slopes is very similar to that of galleries, if the inclination be slight, but approaches more to the masonry of perpendicular shafts if the inclination be steep. The partition walls serve as arch beds (see Fig. 171), and the openings into the galleries are arched over as in perpendicular shafts. If the underlying rock is firm, the foundation trenches are hewn in it for the main and partition walls. In these trenches the level walls are founded, and upon these the arches are placed according to the number of the divisions. Should the underlying rock be unstable, then it is covered with masonry, and the other walls are placed upon it.

Filling rooms and other extended spaces, if they are to be walled, should be secured by arches; and the strength of such arches should correspond to the pressure, and they must rest upon deep and perfectly firm beds.

When water is found at the side of the shafts it is collected behind the walls and led through openings into pipes.





# APPENDIX.

---

## SINKING ARTESIAN WELLS.

---

### APPARATUS FOR SINKING ARTESIAN WELLS.

THE derricks used for sinking wells will vary in height with the general habits and ideas of the workmen. Some of the deepest wells have been dug with derricks only 30 or 40 feet in height. In the gas wells of Ohio, Indiana, and elsewhere, it is customary to erect derricks 60 to 70 feet in height, which in many cases are used only ten or twelve days, and then taken down. Hence there is an unnecessary loss of time and timber.

Mr. W. Blasdell, of Philadelphia, who has been engaged in this work for many years, writes us that "the tools used at the present time I believe to be about one-third heavier than those enumerated in the catalogues of Morris, Tasker & Co., of 1874," but in cases where only trial-borings are made, or temporary ones, or those of no great depths, about the same tools and sizes as those of former use may be employed.

In the larger size derricks, 60 to 70 feet, it is not necessary to use any heavy timber for the upper parts. In many wells, in various places, which have been worked successfully under our own observation, derricks 70 feet high and 20 feet spread at the base have been composed of timber no larger than two inches by ten inches placed together on their long edges, making one side twelve inches wide and nailed properly. These are laid up as the maker ascends, keeping the sloping pitch at proper angle and bracing with planks on the outside as he goes up. All the safety and strength depend upon the bracing, generally every

ten feet. The shaking and trembling of the derrick on letting the drill down rapidly into the well never do any injury to the derrick. The only precaution necessary is that the workman always should be sure that the "up and down" scantlings rest at their ends securely upon one another, and that the foundation is solid and perfectly immovable before any work is begun. These derricks are "four square," having four-corner inclining posts all approaching each other evenly to the top, which is about three feet square, and provided with sufficiently heavy timber to sustain the weight of the rope, drills, and other apparatus, frequently weighing several tons.

Below we give the methods adopted by Mr. Blasdell:—

The derrick used by myself in sinking artesian wells through soil, clays, and the like, by boring, is about 33 feet high by some  $3\frac{1}{2}$  or 4 feet wide. It is often made of spruce or pine spars 8 inches at the butt by some  $4\frac{1}{2}$  inches at the top [hewed], or of some light sawed timber nearly of that proportion. They are cross-braced for strength and slats nailed or screwed on for going up or down. The foot-piece [opening the two timbers or scantling of this kind of derrick at the base] will be 10 feet long, and head-piece 4 feet long, both mortised, and the derrick keyed into them. The derrick of two timbers is held up by two poles, or legs, reaching nearly to the top of the derrick and against two "chocks" or pieces bolted on either side of the derrick, and then held by an iron strap or rope lashing. When the derrick is up the distance between the legs and the foot-piece of the derrick is about 10 feet, making about a square, thus giving room to turn the yoke or wrench handle in turning the auger or bit on the stage, which is about 8 feet above the ground. To make the stage connect by bolts or rope lashings place two scantlings on either side about 8 feet up and use planks for floorings. Double gearing is used for hoisting with a 6-inch pinion-wheel and 24-inch cog-wheel, with a 9-inch wooden drum on the shaft of the cog-wheel for the hoisting rope. A single  $4\frac{1}{2}$ -inch rope is used for the hoisting fall attached to the wooden drum then up and passing through the iron "gin-wheel" or pulley at the head of the derrick, then down to the rods or augers. Attached to the

fall is an iron "swivel-hook" made flat so as to hook in the eye of the rods or augers, for hoisting them; the socket, as seen in some catalogues (No. 49, of Morris, Tasker & Co., 10th edition), is not used by some workers. The fall and hook are used for hoisting the levers to shove the pipe [or tubing]—not using the small derrick as sometimes depicted. The bearings and shaft of the pinion-wheel should be on the same side of the derrick that the drum or cog-wheel shaft is, and the crank on the upper or pinion-wheel shaft. There is an error in the drawing in this respect in one of the catalogues most extensively circulated.

The pipes, or tubing, generally used in sinking artesian wells are sometimes of cast-iron, and may be as large as 8, 12, and even 20 inches calibre, in sections of 8 and 10 feet, connected together with wrought-iron bands heated and shrunk on. The metal of the pipe is thickened at the joint, making the calibre a little smaller, then the outside of the pipe is turned down in a lathe so as to make the band flush with the outside of the pipe after it is shrunk on. The end turned down on the pipe is from 3 to 4 inches in length and depth to correspond with the thickness of the band, which is usually from  $\frac{1}{2}$  inch to  $\frac{5}{8}$  inch thick. The ends of the pipe butt together, one resting on the other; the bands should be a little narrower than the turned ends of the pipe, so that the pipes will closely rest together.

To connect the pipes together in boring an artesian well, first shove the pipe down as far as the levers will carry it, which will leave it above ground some 2 or 3 feet, then sling the pipe that you wish to connect and raise with the fall and let it hang immediately over the lower pipe. The band must now be heated red hot in a sheet-iron furnace, with a wood fire (or in any similar way), and with a pair of tongs place the band on the first pipe, then lower the other pipe into the band, and when the band cools it will contract and make a tight joint. The band when cold should be a little smaller than the turned ends of the pipe; the heating expands the band, which should be put on the pipe quickly in order to success. The first, or bottom pipe, has a sharp iron or steel cutting band on the lower end to cut its way down as the boring is done through the inside of the

pipe. In some cases the reamer, or combination auger, is used to enlarge the hole as in very stiff clays.

The "twist" or "spiral auger" is found to work better than any other. Four to 6 twists are commonly used in the full length, 5 feet, made of  $1\frac{1}{4}$  inch iron steel pointed, or of all steel one inch square.

Rods used are in 15 feet sections,  $1\frac{1}{4}$  inches square. Iron with male and female socket joints, held with a key and a clasp, to cover and hold the key in its place.

The sand pump is made of sheet iron from 2 to 3 feet in length of a size loosely to fit inside the pipe; it is furnished with a single leather valve at the lower end, hinged and resting on an iron ring  $\frac{1}{2}$  to  $\frac{3}{4}$  of an inch thick as a base. This ring is from 1 to 2 inches deep, beveled thin at the lower edge and riveted in the lower end of the sand pump. The leather valve is strengthened by thin iron plates riveted on either side of it. The pump is used for pumping sand and gravel, and sometimes stone can be pumped up of a size as large as the pump will admit. To use the pump, attach a single line to the bail and lower it into the well pipe to the bottom; then slowly draw it up some 12 or 16 inches, and let it drop quickly. Keep repeating until it is well charged, then draw up and empty.

The pump being nearly as large as the calibre of the artesian pipe, the drawing it up in the water forms a vacuum and the sand and *débris* follow the pump up and by dropping the pump quickly the valve opens inside, and the pump being heavier than the floating material drops quicker and shuts over it, and by raising the pump the valve closes and retains a portion each time.

There must be water in the well to cover the sand-pump, in order that it shall work. If the well will not afford the water, it can be turned in. A single "gin wheel" or pulley-block is used at the head of the derrick for the sand pump rope.

In boring or sinking tubing or pipe, the work is generally done by man-power. To turn the auger a lever, or yoke of iron, some 4 feet long, is attached to the rods by a "set-screw" and turned by two or three men working on the elevated stage. When the auger is full, draw up, and disconnect the rack rod at the joint.

In order to hold the rods while disconnecting them, let the shoulders near the end of the rod (male end) rest on the crotch-bar (or fork, No. 33, M., T. & Co.'s cat., 10th ed.), which is placed on and held up by the stage, or in case the pipe should be higher than the stage then let the fork rest on the top of the pipe.

Levers used to force the pipe down are usually about 20 feet in length, 1 foot in diameter, of round, or square timber. In the center of them 15 inches from the end there is a slot  $1\frac{1}{2}$  inches wide, 9 inches in length at the top, and 4 inches at the bottom, cut through them for the lever irons to work in.

The lever iron is 17 inches in length, 4 inches wide, and 1 inch thick. At the top end there is a round hole  $1\frac{1}{2}$  inches for a shackle pin, so as to connect and shackle it to the side chains to draw or force the pipe down. At the lower end there is a square and deep hole for a key to hold it, that it may not pull through the slot in the levers. By cutting the slot on the top of the lever it will admit raising the lever to an angle sufficient to shove the pipe. One foot from the end of the lever it is necessary to have a pin projecting up some 6 inches to prevent the lever slipping under the fulcrum stick when the former is raised up to shove the pipe. The two fulcrum chains should each be about 17 feet in length, and made of iron  $\frac{3}{4}$  inch in diameter. The two side chains should be 12 feet long, each made of  $1\frac{1}{4}$  inch iron and the link 5 or 6 inches in length to admit of a heavy shackle to attach them to the lever irons. The bottom, or lower fulcrum stick, should be 10 or 12 feet in length, by some 12 or 14 inches on the face, and 8 or 10 inches thick; a wide faced one is better for holding. The top fulcrum should be round, of some 10 inches in diameter and 6 feet in length. In the "combination auger," there are two steel cutters screwed on the bottom plate. So by turning the auger ahead they will open and cut larger than the pipe, and by turning back they close up so that it can be withdrawn.

Valve sockets, or "catchalls," are to catch the rods, when by accident they become disconnected. Steel dogs, of different sizes, are hinged to them which will catch by drawing up and hold the rod.

The "catchall" for hauling pipe has a dog, a little longer than

the calibre of the pipe, hinged to the main stem. So, that when drawing up, the heel slips a little and the point being steel and sharp catches and thus holds the pipe to draw it out. Sometimes the connecting bands adhere fast enough to draw the pipe with chains made fast to the top pipe.

The "wrench bar" is used temporarily to turn the rods in boring instead of using the wrench handle.

The "boulder-cracker" is raised with a rope and dropped to break stone, but it is not very effective. A pointed chisel made to connect the rods and all raised and dropped together is preferable.

The "spring catch" for hauling pipe, also "hooks," are seldom used, nor is the "lifter."

A line should be attached to the "catchall," to regulate and prevent catching where not wanted.

#### TO COMMENCE AN ARTESIAN WELL.

Put the derrick up, then commence in front 4 feet from the base of the derrick parallel with the plane of the derrick legs, and dig a trench 18 inches wide, 10 feet long and 5 feet deep for the bottom fulcrum stick. Then lower the centre, or bight, of the two fulcrum chains in the trench some 4 feet apart, allowing the two ends of each chain to extend a few feet above the surface of the ground, then place the fulcrum stick in the trench on top of the chains and secure it by placing cross pieces of plank or small timber, allowing each end to penetrate the earth on the sides of the trench for holding. Then fill the trench up on top of the stick with the earth which was excavated, and tamp all solidly, thus securing the stick for leverage power in shoving the pipe down. We next place two blocks of timber (immediately over the filled up trench), some five feet apart, and lay the top fulcrum stick on the blocks, and secure by passing the ends of the fulcrum chains over it, and shackling together. Thus a complete fulcrum power may be obtained for the levers in shoving, or forcing, the pipe into the earth. The pipe is then placed immediately in front of the centre of the fulcrum sticks, and the boring commenced through the inside calibre of the pipe, and continued from one to two feet below the bottom of the pipe; then the

shoving band is placed on the pipe. The shoving chains, or side chains, hung on the side hooks which are attached to the shoving band on either side, and the ends of the levers are placed under the top fulcrum stick, one on either side of the pipe. The opposite ends are now raised up, by the derrick, some seven or eight feet in height, and the side chains shackled to the lever irons, when one link, or five or six inches are gained at each time of raising the levers, and thus the pipe is drawn, or forced, down into the earth. If there is too much friction resistance against the pipe for the weight of the levers to force it down, weights must be applied to the ends of the levers, which will give a power of some fifteen tons pressure. In boring through clay, loam, or marl, only use the spiral auger, which adheres to it and when full it may be drawn up and cleaned. In drawing the auger up the rods have to be disconnected at the joints one at a time.

When sand, gravel, or small stone is reached the sand pump is used to take it out, keeping the leverage power on at the same time to force the pipe down. When stone, or large boulders are encountered, it is found very difficult and sometimes impossible to shove the pipe. In such cases it is customary to use a heavy drill, or boulder-cracker, as it is called, and try to break or displace them. Soft stone, such as slate, or sandstone, can be broken, but if there is a hard stone which is almost or actually impossible to break, then the well digging has to stop, and the pipe drawn and changed to some other point.

Sometimes a boulder-catcher, or "lazy tongs," can be used to advantage in picking up stone, or boulders.

A larger supply, and better water, are usually obtained after passing through good pure clay. In all cases in order to obtain a supply of water it is necessary to reach a water bearing stratum of coarse sand, gravel, pebbles, or a bed of small stone, or boulders, which are generally intermixed more or less with sand or gravel. It is necessary to carry the pipe a few feet into the water-bearing stratum, in order that the water shall not be interfered with from washings of the above clay stratum. It is very seldom that a supply of water can be obtained in fine sand, for the simple

reason that pumping the head of water down will cause the sand to rise in the pipe with the water, and very quickly choke off the supply.

Most of the wells in the vicinity of Philadelphia are through soil and the water obtained in a gravel stratum ; patent flush pipes, or those which have no ridge on the outside, are used of 8, 12, and 20 inches calibre. In some cases where water is not obtained and the rock reached, a drill is used cutting a hole from 4 to 12 inches calibre, and the water is obtained from the fissures and crevices.

Sometimes the common mining tools, spring-pole and man-power, may be employed in drilling the rock, and sometimes the oil well tools, with walking-beam and steam power, must be resorted to.

In using the spring-pole for mining purposes, or shallow wells, for water, sometimes the solid iron rods with screw joint are sufficient, and sometimes extra heavy  $1\frac{1}{2}$ -inch gas pipe rods, and sometimes wooden rods with strap screw joints. In most of the salt wells which were drilled in former times, and some which went down several hundred, or a thousand feet, the spring-pole with wooden rods and strap points was successfully employed.

## OIL AND GAS WELLS.

To sink an oil or gas well it is necessary to have a steam-engine from 8 to 12 horse power, a derrick 45 feet high, with a base of 15 feet, with a "sampson post" 8 or 10 feet high for the walking-beam, which must be 20 to 30 feet in length, and other tools and fixtures as enumerated in the usual catalogues of such machinery.

To start a well where the soil overlies the rock, either the plan already described must be used, or a heavy cast-iron driving pipe of 5 or 6 inches calibre is driven to the rock by raising a heavy timber (some 14 inches square by 12 or 14 feet in length) to the head of the derrick and letting it drop upon an iron cap placed on the top of the pipe. The drill is also used to cut up the soil, or any obstructions which may be encountered, and the



sand pump to take the *débris* out. Where the rock crops to the surface no pipe is required.

To commence drilling first connect the "auger stem" to the "centre-bit," then the "jars" to the auger stem, then the "sinker bar" to the jars, then the rope socket to the sinker bar, then attach the drilling rope to the rope socket, then clasp the temper screw to the rope at the point where required, then attach the temper screw to the walking-beam. The screw is about 3 feet or more in length, and in starting should be closely screwed up and held with a set screw, and as the drill cuts its way down to be gradually unscrewed to the end.

After about 3 feet are drilled the centre-bit is withdrawn, the sand pump put in, and the *débris* pumped out, then "the reamer" which is about 1 inch larger than the centre-bit is put in and the hole reamed down as far as the centre-bit has cut.

The reamer makes the hole round and smooth. Where the centre-bit is used (without reaming) for any great distance the hole becomes triangular in shape. Generally the rock operated in for oil is slate, shale, and limestone or sandstone. After a well is drilled it is then cased with wrought-iron tube, or casing, with a seed-bag attached to it to shut off water-veins.

To "seed-bag" the casing of a well, a leather case like a boot-leg, some 3 feet in length, is slipped over the iron casing and tied at the lower end with a string. Then the space between the leather case and iron casing is filled with flax-seed and the top end of the leather case is securely tied with a hemp cord.

The leather case, or seed-bag, is somewhat larger than the iron casing, so that when filled with the seed it will nearly fill the drill-hole, a gauge being passed over it, the size of the drill-hole, to make it smooth and parallel. When the seeds swell in the water it will make the space between the well and casing water-tight, thus excluding the water-veins from the oil-veins while pumping or flowing.

The seed-bag is put on the casing so that when put down into the well it will be immediately above the oil-vein.

In drawing the casing the top string on the bag breaks and the bag turns inside out, discharging the seed.

Formerly the wells drilled were from 4 to 5 inches diameter, but many are from 6 to 8 inches.

It is probable that the most of the oil obtained at the present day is after passing the third or fourth sand rock, formerly obtained under the second sand.

While the drill is in operation a man turns the rope to which the tools are attached forwards several times then backwards in order to drill a round hole.\*

\* For drawings of a complete oil-well derrick or carpenter's rig see Crew *A Practical Treatise on Petroleum*, Philadelphia, Henry Carey Baird & Co., 1887.

# I N D E X.

- A** CETATE of ammonium, symbol and atomic weight, 59  
test of, 59  
of sodium, symbol and atomic weight, 58  
test of, 58  
Acetic acid, symbol and atomic weight of, 52  
test for, 52  
Africa, diamond fields of, 251  
Alcohol, its uses in chemical work, 44  
Alkaline earths, 42  
Alumina, employment in fluxes, 54  
symbol and atomic weight, 54  
Ammonia, preparation and test of, 54  
symbol and atomic weight, 54  
Ammonium, chloride, hydrosulphide, molybdate, and acetate of, 59  
oxalate, and neutral succinate of, 60  
Analysis of the ore of platinum, table of, 215  
Analytical scales, requirements of, 67  
Antimonial silver, description of, 114, 115  
Antimony, 227, 232  
assay, caution, 232  
characteristics of, 227  
estimation of, 230, 231  
gravity, 227  
hardness, 227  
localities of, 227  
Makins's method of estimating, 231, 232  
melting point, 227  
native, associations of, 227  
to distinguish, from bismuth, 231  
uses of, 230  
Apparatus, chemical, list of, 71-79  
for rapid filtering, illustrated and described, 75-77  
for sinking artesian wells, 343-348  
Aqua regia, composition of, 50
- 23
- Arched masonry, forms generally used, illustrated and described, 334, 335  
where needed, 334  
tunnel, construction of, 337, 338  
wall, construction of, 338  
walls, to protect, against water, illustrated and described, 339  
Arch, to give it the proper form, 335-337  
Argentite, characteristics of, 115, 116  
Arsenical iron, 113  
Artesian well, to commence an, 348, 349  
wells in the vicinity of Philadelphia, 350  
removal of obstructions met with in boring, 349, 350  
sinking, 343-350  
Assay furnace, illustrated and described, 64-67  
Assays, testing the alkaline or acid condition of, 155, 156  
Assorting the ore in the mine, 300  
Atomic weights, practical use of table of, 39-42
- B**ARIUM, chloride, nitrate, and carbonate of, 60  
Barytes, appearances of, 22  
to distinguish, from lime carbonate, 22  
Beds, ore, with inclination less than 40 degrees, working, 287-291  
Bismuth, 232-234  
brittleness, 232  
crystallization, 232  
detection of, 233  
effects of acids upon, 233  
flamability, 233  
fusing point, 233

- Bismuth**—  
 gravity, 232  
 hardness, 232  
 lustre, 232  
 malleability, 232  
 metallic, uses of, for alloys, amalgams, etc., 234  
 occurrence, 232  
   in the United States, 234  
 silver, description of, 115  
 streak and color, 232  
 to distinguish it from lead, 233, 234  
 under the blowpipe, 234
- Black flux**, components of, 55, 56
- Blende**, 185-187  
 under the blowpipe, 185, 186
- Blowpipe**, hints for students, 29, 30  
 inner and outer flames of, 27  
 philosophy of its action, 27  
 practice, materials for, 28, 29  
   review of, 35-37  
   with lead oxide and carbonate of soda, 30  
   with metallic zinc, 30-36  
 preparatory practice with the, 29-35  
 the, 27-35
- Blowpipes**, requisite characteristics of, 27  
 requisites in a practitioner with, 27
- Borax bead** in powdered charcoal, 31  
 in oxide of manganese, 31, 32  
 composition of, 58
- Boring a well**, the power generally used, 346
- Boulder cracker**, use of, 348
- Brake attachment**, illustrated and described, 307, 308
- Brasque**, explanation of, 77, 78
- Breast**, when it reaches the wall, treatment of, 286
- Bromine** and **iodine**, symbols and atomic weights of, 46  
 uses of, 46  
 chemical action of, 47  
 preparation of, 47, 48  
 three forms of, 46, 47
- Brown hematite**, characteristics of, 140, 141  
 general impurities of, 141  
 geological position of, 141  
 peculiarities of appearance in some mines, 141, 142
- Buckets**, to balance, illustrated and described, 308, 309
- Buddling**, description of, 298  
 employed in steep mountain valleys, 298, 299  
 with a hose, 299
- Buhr stones**, 245, 246  
 commercial statistics of, 246  
 principal localities of, in the United States, 245, 246  
 substitution of rollers for, 246  
 uses of, 246
- Bulk of a body**, a mode of determining, 22, 23
- CADMIUM** and bismuth compounds, to separate silver from, 124
- Calamine**, English manner of distilling, 187, 188
- Calcium**, chloride of, 61
- Carat**, the weight of, 246, 247
- Carbonate**, lime, description of, 18  
 of barium, preparation of, 60, 61  
   symbol and atomic weight, 60  
 of potassium, symbol and atomic weight, 55  
   test of, 55  
 of sodium, symbol and atomic weight, 58  
   test of, 58  
 of zinc, characteristics of, and where found, 185  
   under the blowpipe, 186
- Carbonic acid gas**, symbol and atomic weight of, 53  
 dioxide (carbonic acid gas), preparation of, 53  
 symbol and atomic weight of, 53
- Car**, loaded, to prevent a, from "jumping the track," 307
- Carpentry**, mining, 318-324
- Cassiterite**, 176
- "Catchall," equipment of, 347, 348
- Caution** in decomposing copper sulphides, 130, 131  
 in regard to copper solution, 128, 129  
 in working silver with lead, 121  
 to the inexperienced operator in using reagents, 69
- Cautions and suggestions** in analysis and assaying, 63-68  
 in making the dry assay of iron, 144, 145
- Charcoal**, preparation of, for use under the blowpipe, 27, 28

- Chemical analysis, certain principles of, 36, 37  
 importance of, in mineralogy, 17, 18  
 apparatus, list of, 71-79  
 symbols, table of, 37, 38
- Chemicals for private laboratory, 72, 73
- Chemistry, value of, in mineralogy, 17
- Chlorate of potassium, symbol and atomic weight, 56
- Chloride of ammonium, symbol and atomic weight, 59  
 test of, 59  
 of barium, test of, 60  
 symbol and atomic weight, 60  
 of calcium, preparation of, 61  
 symbol and atomic weight, 61  
 of nickel, way of obtaining, 133  
 of sodium, symbol and atomic weight, 57  
 test of, 57  
 use of, 57
- Chlorine, process of obtaining, illustrated and described, 45, 46  
 symbol and atomic weight, 45  
 use of, 46
- Chlorite, a good sign in searching for corundum, 242
- Chrome iron, components of, 235  
 ore, quantitative analysis of, 237
- Chromite, constituents of, 235
- Chromium, 235-238  
 before the blowpipe, 235  
 brittleness of, 235  
 color, 235  
 decomposition of the ore, 236  
 first notice of its occurrence in the commercial way, 236  
 gravity, 235  
 hardness, 235  
 its occurrence in the United States, 236  
 lustre, 235  
 solubility of, 236  
 streak, 235
- Cinnabar, characteristics of, 221
- Cleavage of minerals, 20
- Coal-beds, cutting levels and drifts in, illustrated and described, 290, 291  
 of different benches, working, illustrated and described, 291  
 the slope in, illustrated and described, 268
- Coal—  
 mines, precautionary rules to prevent spontaneous combustion, 292
- Cobalt, 238-240  
 color of, 239  
 compounds, detection of, under the blowpipe, 239  
 fusibility, 239  
 glance, 238  
 gravity, 239  
 inability to plate with, 239  
 metallic, nominal value, 239  
 minerals, localities of, 239  
 only present use of, 239  
 ores of, 238  
 preparation of, from the ore, 238, 239  
 separation of, from nickel, 240
- Cocalico, 246
- Color, importance of, in determining the nature of a substance, 20, 21
- Combining weights of elementary bodies, table of, 38, 39
- Compounds, groups of, 42, 43
- Connecting the pipes in boring an artesian well, 345
- Copper, 125-131  
 assay by the dry method, 127, 128  
 by the wet method, 128  
 associations with, 126  
 blowpipe and other modes of detection of, 127  
 compound ores of, 126  
 hardness and gravity, 126  
 its geological position, 126  
 minerals, three classes of, 125  
 native, geographical localities of, in the United States, 125  
 ores, silver contained in, 114  
 oxide of, symbol and atomic weight of, 55  
 pyrites, characteristics of, 126  
 separation of silver from, 122  
 solution, caution in regard to, 128, 129  
 sulphides, caution in decomposing, 130, 131  
 sulphides, decomposition of, 129
- Corundum and emery, 241-243  
 associations of, 241  
 gravity, 241  
 hardness, 241  
 in its purest crystalline state, colors of, 241  
 lustre, 241

- Corundum—  
 sample, to test its abrasive power, 242, 243  
 under the blowpipe, 241  
 uses of, 242
- Crucibles, platinum, requirements of, 77
- Crystal forms, use of, for the mineralogist, 36
- Crystallization, immense importance of, to the mineralogist, 18, 19
- Crystals, three-sided and six-sided, 19
- Cupel, description of, 34
- Cupellation, knowledge of the process necessary to the mineralogist, 33, 34
- Cupellation of ores, 120, 121
- D**AY shaft, intention of a, 265
- Day working, 296-300
- Deposit, barren rock met in a, treatment of, illustrated and described, 287
- discovered by a tunnel which has entered the ore, working of a, illustrated and described, 292, 293
- greatly inclined, opening of a, 274
- nearly horizontal, opening of a, 274, 275
- opening a, when the mountain is steep and the strike of vein is parallel to it, 274
- opening a, when the strike of the vein is across the strike of the mountain ridge, 274
- striking under a plain, opening of a, illustrated and described, 274
- Deposits and beds, stratified, preparation and working of, 287-292
- large irregular, opening of, 275
- large, possessing some degree of regularity, working of, 292
- with little or no regularity of form, general rule in regard to mining of, 292
- with little or no regularity of form, preparation of, for mining, illustrated and described, 292-294
- Derrick used by Mr. Blasdell, 344, 345
- Derricks used in sinking wells, 343-345
- Diamond, appearance of, in the rough state, 250
- best test for, 250
- débris in North Carolina, Dr. Genth's opinion of, 247
- fields of Africa, 251.
- Diamond—  
 gravity, 248  
 localities where found in the United States, 246, 249  
 the, 246-251
- Diamonds, their ability to scratch glass no proof of their distinctive value, 250
- Distilled water, use of, in accurate determination of specific gravity, 24, 25
- Distilling zinc, apparatus for, illustrated and described, 187-189
- Ditches in budding, substitute for, 299
- Drainage of a mine, 258, 259
- Drift gallery, opening from another and timbered gallery, illustrated and described, 323
- Drifts, explanation of the term, 260
- Dry assay of iron, 143, 144
- Dump carts, illustrated and described, 315, 316
- Dumping floor, depth and width of, 269, 270
- Dyscracite, description of, 114, 115
- E**CONOMIC treatment and history of the useful minerals, 81-251
- Egg-shaped arch, illustrated and described, 337
- Elementary bodies, table of combining weights of, 38
- Elements of material substances, 36, 37
- Elliptical arch, illustrated and described, 336, 337
- Emery, commercial statistics of, 243  
 occurrence of, in the United States, 241, 242
- Esopus stone, 245, 246
- Excavations, protecting the, 258
- Excavation through insecure rock, timbering for, illustrated and described, 325
- Exhaustion of iron ore deposits of the United States, 173, 174
- F**ERROMANGANESE, 208
- Filtering, rapid, apparatus for, illustrated and described, 75-77
- Filter papers, folding of, 75-75  
 treatment of, 67
- Folding filter papers, 73-75
- Fracture of minerals, 20
- Framing, method of, illustrated and described, 321

Freieslebenite, characteristics of, 115  
Fuming nitric acid, use and preparation of, 78, 79

**G**ALENA, description of, 196  
only abundant lead ore, 194  
Galleries, names of the, in mines, 264  
vertical distances between, 264  
Gallery, arching of a, illustrated and described, 339  
construction of drainage, canal or sluice, illustrated, 339  
entirely within the lode, illustrated and described, 261, 262  
floors, descent of, 259  
floor, to prepare for transportation and drainage, illustrated and described, 323, 324  
opening a, from the side of a hill, illustrated and described, 260-262  
parallel to the "pay rock," illustrated and described, 262  
partly in the rock and partly in the lode, illustrated and described, 261  
second story, opening of a, illustrated and described, 286, 287  
walls, masonry of, 332, 333  
when the rock is not in horizontal strata, illustrated and described, 261, 262  
Gas and oil wells, 350-352  
Geology of gold and its associations, 88-96  
Gersdorffite, composition and characteristics of, 132, 133  
Glass of borax, use of, 58  
Glassware and reagents, how to use, 68-71  
heating, 69, 70  
Gold, 83-110  
absurd deduction of French chemist in regard to, 93  
alloying metal, 93  
alloys, methods of treating, 96-100  
treatment of in the United States Mint, 96  
and its associations, geology of, 88-96  
and platinum, to separate from the slag, 98, 99  
average fineness of, in several States, 94  
best admixture for smelting, 97

Gold, best—  
amount to melt in one operation, 97  
California, native, average fineness of, 92  
color of, 83  
composition of, 83, 84  
containing osm-iridium, treatment of, at the Mint in St. Petersburg, 100  
treatment of, at the United States Mint, 99  
cradle or rocker, illustrated and described, 104-106  
ductility and malleability of, 83  
exploitation, necessity of an "eye for color" for, 103  
extracted, Pettenkofer's statement regarding, 96, 97  
found in England, 89  
hardness and specific gravity, 83  
in Australia, 89  
marked difference in, 94  
in fine dissemination, simplest instrument for discovery of, 103, 104  
in North Carolina, Dr. Genth's description of, 90-92  
in rocks of various ages, 90, 91  
in Siberia, 89  
in the sands of rivers, 90  
Miller's chlorine refining and parting process for, 94  
mines of South America and Mexico, 86, 87  
native, occurrence of, 99  
necessary precautions in the treatment of, 109, 110  
occurrent condition and form in nature, 83  
of Colorado, color of, 94  
of the world, where mostly gathered, 89, 90  
ores, discovery and proving, 103-106  
poorer, Hungarian process of treatment, 108  
treatment of, 107-109  
or silver, separating, from lead, 35  
poorer ores containing, 107-110  
production of, in the United States, 87, 88  
separating silver from, 122, 123  
specific gravity and hardness, 83

## Gold—

- study of its alloys and accompani-  
ments, 94-96
- sulphides, 88, 89
- United States, localities of, 84-88
- use of cast iron in "parting," 101-  
103
- of platinum vessels in parting,  
101-103

## Granza, 221

Greisen, per cent. assay of, 177, 178

## Grindstones, 245

- home product and import of, 245
- principal source of, in the United  
States, 245

Groups of compounds, 42, 43

**H**ARDNESS, a characteristic in de-  
termination of many mine-  
rals, 19, 20

- of a mineral, standard of  
comparison, 81, 82

Heating glassware, 69, 70

Hematite, characteristics of, 139

ores, 139, 142

Hydraulic mortar, preparation of, 333

Hydrochloric acid, characteristics of,  
and tests for, 49, 50

symbol and atomic weight, 49

Hydrogen, preparation of, 44, 45

symbol and atomic weight, 44

use of, in reducing finely powdered  
iron ore to iron, 44Hydrosulphide of ammonium, process  
of obtaining, 59symbol and atomic weight,  
59Hydrosulphuric acid gas, formation of,  
51symbol and atomic weight,  
51**I**NCLINED shafts, masonry for, 341

Infusorial earth, 244

composition of, 244

localities of, in the United  
States, 244

uses of, 244

Ingress and egress for workmen, illus-  
trated and described, 316, 317Iodine and bromine, symbols and atomic  
weights of, 46

uses of, 46

Iridium, 214-218

## Iridium—

and phosphorus, discovery of John  
Holland in regard to, 217

as melted by the older chemists, 217

color, 215

commercial value of, 218

derivation of its name, 215

geographical distribution of, 216

gravity, 214

hardness of, 214

in the United States, 216

lustre, 215

malleability, 215

melting point of, 217, 218

occurrence and association, 214

separation of, from gold, 216, 217

## Iridosmine, 214

as points for gold pens, 217

commercial value of, 218

## Iron, 137-174

cast, use of, in parting gold, 101-  
103

chief ores of, 137-143

dry assay of, 143, 144

ductility of, 137

effect of phosphorus on, 138

effect of sulphur on, 138

electrical conducting power of, 137

heat conducting power of, 137

malleability of, 137

magnetic ores of, 137-143

ore at the Washington mine, near  
Marquette, Michigan, 138

deposits of the United States,

exhaustion of, 173, 174

preparation of, for the assay,  
170-172to ascertain the sulphur in,  
156-158to determine the amount of  
manganese in, 158-162

ores, associations found with, 138

before the blowpipe, 143

of Great Britain, 137

pig, increase of production of, in  
the United States, 173, 174

polaric ores, where found, 138

pure, specific gravity of, 137

symbol and atomic weight, 48

tenacity of, 137

universally present in nature, 137

use of, for volumetric assays, 48

volumetric determination of, 166-  
172

wet method of assay, 147-151

Isinglass, cleavage of, 20



- J**UDICIOUS mining, treatment of the ore veins in, 278
- K**ERMESITE, 228
- L**ABORATORY, selecting a location, 63, 64
- Lead, 194-205  
 action of water on, 202, 203  
 characteristics of, 202, 203  
 destroying the coining qualities of gold, 203  
 ductility, 194  
 electrical conducting power, 194  
 fusibility, 194  
 geological horizons and occurrence, 194-196  
 gravity, 194  
 hardness, 194  
 heat conducting power, 194  
 in the United States, 194, 195  
 malleability, 194  
 ore, by the wet process, 197-199  
   Mascazzino's method of assaying, 204, 205  
   working on the large scale, 196, 199  
 ores, silver contained in, 114  
 Parkes's process for, 201, 202  
 Pattinson's process for, 200  
 quantitatively determined, 204  
 to separate silver from, 123, 124  
 separating gold and silver from, 35  
 sulphate, composition of, 198  
 tenacity of, 194  
 wet assays of, and methods of detection, 203, 204
- Lenses, use of, for blowpipe practice, 33
- Levers used to force the pipe down an artesian well, 347
- Lime carbonate, cleavage of, 20  
 description of, 18  
 to distinguish from barytes, 22  
 precipitation of, from the iron filtrate, 154, 155
- Lime-water, symbol and atomic weight, 54
- Limonite, where found, 142
- Litharge, symbol and atomic weight, 54  
 test of, 54, 55
- Litmus paper, preparation of, 63
- Lodes and veins, how prepared and mined, 279-287
- Lodes—  
 of more than two or three fathoms thickness, method of working, illustrated and described, 285, 286  
 Long wall system of mining, illustrated and described, 287-289
- M**AGNESIA, precipitation of, from the iron filtrate, 155
- Magnesium, sulphate of, 61
- Magnetism, use of, in determining some minerals, 33
- Magnetite, characteristics of, 137-139  
 geologic position of, 139
- Manganese, 206-209  
 analyses of, by the wet process, 209  
 associations of, 206, 207  
 characteristic color of, 32  
 characteristics of, 206  
 its uses in the arts and manufactures, 207-209  
 oxide of, injurious effects of, in building stone, 208, 209  
   on a borax bead under the blowpipe, 31, 32  
 to determine the quantity of, in an iron ore, 158-162  
 with the blowpipe, 206.
- Mascazzino's method of assaying lead ore, 204, 205
- Masonry, 332-341  
 and timbering of mines, 317, 318  
 durable, requirements of, 333  
 for shafts, 340, 341
- Masses between two contiguous drifts, to gain the, illustrated and described, 293, 294
- Mercurial compounds, characteristics of, 225-227
- Mercury, 218-227  
 boiling point, 218  
 chemical characteristics, 220, 221  
 color, 218  
 composition, 218  
 ductility, 218  
 geology and associations, 219, 220  
 gravity, 218  
 hardness, 218  
 in compounds, Makins's accurate method for determining, 226, 227  
 localities, 219  
 ocurrent forms, 218  
 ores in the United States and in Spain, 221

- Mercury ores—  
 treatment of, 222-225  
 to separate silver from, 124, 125
- Metallic oxides completely precipitated from their acid solutions by sulphuretted hydrogen, but not from their alkaline solutions, their sulphurets being soluble in alkaline sulphurets, 43
- completely precipitated from their solutions, whether acid, alkaline, or neutral, by sulphuretted hydrogen, their sulphurets being insoluble in alkaline hydrosulphurets, 42, 43
- not precipitated by sulphuretted hydrogen, but precipitated as oxides by hydrosulphuret of ammonia, 42
- not precipitated from their acid solutions by sulphuretted hydrogen, but completely precipitated by hydrosulphuret of ammonia as sulphurets, 42
- not precipitated from their solutions by sulphuretted hydrogen, but precipitated by hydrosulphuret of ammonia only under certain circumstances, as salts, and also precipitated by alkaline carbonates, 42
- not precipitated from their solutions by sulphuretted hydrogen, hydrosulphuret of ammonia, or alkaline carbonates, 42
- zinc, manipulation of, under the blowpipe, 30, 31
- Metal or mineral, finding specific gravity of a, at different temperatures, 25, 26
- Methylic alcohol, use of, for burning and for blowpipe purposes, 44
- Mica, cleavage of, 20
- Microcosmic salt, 28, 29  
 preparation of, 63  
 symbol and atomic weight, 63
- Mineral deposits in the mines, division of, 277
- making a distinction between the gangue and the ore, illustrated and described, 273
- Mineral deposits—  
 occurring in large masses, preparation and working of, 292-296  
 or metal, finding specific gravity of a, at different temperatures, 25, 26
- Minerals, cleavage of, 20  
 fracture of, 20  
 hardness of, characteristic of in determination of, 19, 20  
 importance of color in determining their nature, 20, 21  
 requiring other than blowpipe treatment, 36  
 scale of descent of, in hardness, 81, 82  
 specific gravity an important characteristic of, 21, 22  
 streak an important characteristic of, 21  
 useful, economic treatment and history of, 81-251  
 weighing blocks of, without scales, 26
- Mine crushed in, gaining the ore in, 294  
 floors altogether crumbling, framing for, illustrated and described, 322, 323  
 loose and soft, framing for, illustrated and described, 322  
 opening or exploring of a, most important rules to be observed, 271  
 when "exposed," 277  
 water, construction of channels for leading off, illustrated and described, 263  
 exhausting the, two ways of, 281  
 pumping, 264, 265
- Mines, advantage of dry walls in, 338  
 final preparations and working of, 277, 278  
 opening of, 270-276  
 robbing of, 278  
 timbering necessary for working, illustrated and described, 330, 331  
 when the sides are firm and only the roof is brittle, timbering for, illustrated and described, 323
- Mining by descending steps, 284  
 by reversed steps, 284  
 carpentry, 318-324  
 construction and machinery, 253-341

## Mining—

- downwards, illustrated and described, 283, 284
- explanation of some terms, 256
- judicious, treatment of the ore vein in, 278, 279
- mineralogy, necessary information for successful study of, 17
- preliminary principles and preparations, 17-29
- overhead, illustrated and described, 281-283
- preliminary work and considerations, 257-270
- shaft method of, 265-270
- systematic, requirements of, 277, 278
- well-conducted, scientific, systematic, requirements of, 275, 276
- when expedition is required, illustrated and described, 263, 264
- work and architecture, 253-341
- Mispickel, deceptive appearance of, 113, 114
- ore, to distinguish from silver ore, 114
- Molybdate of ammonium, symbol and atomic weight, 59
- Molybdic acid, symbol and atomic weight, 53
- Monazite, 185, 186
  - color, 247
  - composition of, 248
  - hardness of, 247
  - lustre, 247
  - gravity of, 247
  - under the blowpipe, 248
- Mortar, preparation of, 333
- Muffle, charcoal, for small assays, 35
  - to make one with a common sheet-iron stove, 34, 35
- N**ESTS, cores, or pockets, preparation and working of, 295, 296
- Nests of ore lying separate from each other, rule for opening, 275
- Nicolite, characteristics of, 132
- Nickel, 132-136
  - alloys of, 134
  - before the blow-pipe, 132
  - characteristics of, 132
  - consumption of, in the United States, 136
  - ductility and tenacity of, 132

## Nickel—

- glance, symbol, 132
- lined vessels, advantages of, 136
- malleability of, 132
- ores, 132
  - in the United States, 135
- ore, separation of its constituents, 134, 135
- prices of, 135, 136
- pure, Devill's method of obtaining, 135
- separation from cobalt, 136
- solubility of, 132
- specific gravity of, 132
- Nitrate of barium, symbol and atomic weight, 60
  - test of, 60
  - of potassium, symbol and atomic weight, 55
  - of silver, preparation of, in crystals, 62
    - proper dilution of, 61
    - symbol and atomic weight, 61
- Nitric acid, fuming, use and preparation of, 78, 79
  - symbol and atomic weight, 50
  - two conditions in which it is employed, 50
- Nitro-prusside of sodium, symbol and atomic weight, 59
- O**CTAHEDRITE, characteristics of, 248
  - under the blowpipe, 248
- Oil and gas wells, 350-352
- Opening of deposits according to the positions of the ore veins, 272-274
  - of mines, 270-276
- Ore gangways, leveling the floor of, illustrated and described, 269
  - inclination of, consideration in opening a lower or foot drift, illustrated and described, 273
  - in the mine, assorting, 300
- Ore-mass composed of hanging and lying ore veins, working the drifts, 293
- Ore samples for experiments, caution to be observed in selecting, 145, 146
  - veins, important changes of, 271, 272
  - vein, treatment in judicious mining, 278, 279

- Ores, cupellation of, 120, 121  
 iron, containing sulphides, arsenides, or selenium, treatment of, 145
- Oreways, recommendations pertaining to, 264
- Osm-iridium, 211
- Oxalate of ammonium, preparation of, 52  
 test of, 60  
 symbol and atomic weight, 60
- Oxalic acid, symbol and atomic weight, 52  
 test for, 52  
 uses of, 52
- Oxide of copper, symbol and atomic weight, 55  
 uses of, 55  
 of manganese, injurious effects of the, in building stone, 208, 209  
 of zinc, proportion of metallic zinc in, 190  
 pure, characteristics of, 189
- Oxygen, processes for obtaining, 48  
 symbol and atomic weight, 48
- P**ALLADIUM, extracted from argentiferous gold, 100
- Parkes process for lead, 201, 202
- Pattinson process for lead, 200
- Permanganate of potassium, coloring power of, 57  
 process for forming, 56, 57  
 symbol and atomic weight, 56  
 use of, in the volumetric analysis of iron, 57
- Peroxide of iron, precipitation of, 154
- Perpendicular shafts, construction of walls in, illustrated and described, 340, 341
- Phosphate of sodium, symbol and atomic weight, 58  
 test of, 58
- Phosphorus, extracting, from the sesquioxide of iron, 151  
 extraction of, from iron, 151  
 Parry's method of precipitating, 152, 153
- Piano wire, purity of iron in, 48, 49
- Pig-iron, increase of production of, in United States, 173, 174
- Pillars, taking out the, 290
- Pipes used in sinking artesian wells, 345
- Platinum, 209-214  
 color and streak, 209
- Platinum—  
 crucibles, requirements of, 77  
 foil, use of, in the filtering funnel, 73, 74  
 geology and occurrence, 210  
 gravity, 209  
 hardness, 209  
 localities of, in the United States, 210, 211  
 lustre, 209  
 melting point of, 218  
 native, combinations with, 209  
 ore, California, analysis of, 211  
 table of the analysis of, 215  
 production of, in the United States, 211  
 wet process of analysis, 211-214  
 wire, objection to, in reducing a metal under the blowpipe, 33
- Poorer ores containing gold, 107-110
- Post and stall system, preparatory work for, illustrated and described, 289, 290  
 where used, 289
- Potassa, characteristics and tests of, 53, 54  
 symbol and atomic weight of, 53
- Potassium, chlorate and permanganate of, 56  
 nitrate, sulphate, and carbonate of, 55  
 sulphocyanide of, 57
- Practical use of table of atomic weights, 39-42
- Precipitations, to calculate the weight of, 68
- Preparation and working of mineral deposits that occur in large masses, 292-296  
 of nests, cores, or pockets, 295, 296  
 of stratified deposits and beds, 287-292
- Preparatory practice with the blowpipe, 29-35
- Protosulphide of nickel, precipitation of, 134
- Protoxide of nickel, care required in precipitating by potassa, 134  
 precipitation of, 133
- Pumice stone, 243, 244  
 color of, 243  
 gravity, 243  
 imported, composition of, 243  
 only utilized deposit of, in the United States, 243, 244

Pumice stone—  
value of importations, 243

Pumping, mine, 264, 265  
or ventilating division of shaft,  
necessary platforms in, 328

Pyrargyrite, characteristics of, 116

**QUARRIES**, difficult of access, tunnelling for, 298  
with very thick covering, tunnelling for, 298

Quarrying for large stones, etc., 297  
materials gained in open, 297  
solid rock, 297  
when the mass is loose, 297

Quartz, analysis of, 18

**RAIN** water, pure, weight of, 23  
Reagents and glassware, how to use, 68-71  
the, 43-63

Reamer, use of, in boring a well, 346

Red antimony, 228

Red hematite, characteristics of, 139  
not attractable by the magnet, 140  
ore, condemnation of, from deceptive appearances, 19  
limit of per cent. of iron in, 140  
variations in its characteristics, 139, 140

litmus paper, preparation of, 63

Renewing timber, 331, 332

Robbing of mines, 278

Rock, barren, met in a deposit, treatment of, illustrated and described, 287

Rock-salt works, mining in, illustrated and described, 294, 295

Rods used in boring artesian wells, 346

Roof, supporting the, 290  
weak, sinking side pits and timbering for, illustrated and described, 269

Roofs or walls, supporting, 291

Roots' blower, 200

Rotten stone, 244

Ruby silver, characteristics of, 116

Rutile, 164

**SALT**, microcosmic, 28, 29  
mines, forming posts and caps in, illustrated and described, 321, 322

Salt—  
of lead paper, uses of, 63

Sand bath, 64

pump, description and use of, in boring artesian wells, 346

Scale of descent of minerals compared with the diamond, 81, 82

Scales for specific gravity, 36

Scorification of mixed ores, 118-120

Semicircular arch, illustrated and described, 336

Sesquioxide of nickel, formation of, 133

Shaft, direction or inclination of a, to be exactly and continuously preserved, 267

framing, section of, illustrated and described, 266, 267

in rock or soil, opening of a, illustrated and described, 268, 269

method of mining, 265-270

permanent timbering of, illustrated and described, 325, 326

straight and vertical, used as experimental or permanent, illustrated and described, 267

sunk on a vertical line, illustrated and described, 267, 268

timbering, lining of, illustrated and described, 326, 327

when all the sides do not need timbering, illustrated and described, 327

Shafts, buckets in, 305

in swamp lands, masonry for, 341  
leading the water from, illustrated and described, 270

masonry for, 340, 341

more than 20 fathoms deep, machines for, illustrated and described, 305, 306

perpendicular, having several divisions, timbering for, illustrated and described, 327, 328

pile driving in, illustrated and described, 327

(slopes), inclined, timbering for, 329, 330

timbering of, 324-329

when rock is to be drilled, 265

working downwards, 265

from below upwards, 265

Shutes or transporting shafts, 330

inclination of, 302, 303

in the lower plane, illustrated and described, 303

- Siderite, 142
- Silver, 111-125  
 antimonial, description of, 114, 115  
 assay by the dry way, 116  
 bismuth, description of, 115  
 caution against precipitating, with  
 chlorides of potassium, sodium,  
 and ammonium, 123  
 color of, 111  
 composition of, 111, 112  
 ductility of, 111  
 found in other ores, 114  
 from sulphurets, to separate, 125  
 gravity of, 111  
 hardness of, 111  
 localities, geology, and associations,  
 112-123  
 Makins's process of assaying by  
 cupellation, 116, 117  
 mines in the United States, 113, 114  
 foreign, 112, 113  
 native, table of specific gravities of,  
 at different temperatures of the  
 water, 25, 26  
 nitrate of, 61  
 occurrent form or appearance in  
 nature, 111  
 ore, first step required in the assay  
 of, 117, 118  
 ores, general resemblances of, 114  
 or gold, separating from lead, 35  
 ruby, characteristics of, 116  
 separating, from copper, 122  
 from gold, 122, 123  
 shop sweepings, assay of, 118, 120  
 to separate, from cadmium and bis-  
 muth compounds, 124  
 from lead, 123, 124  
 from mercury, 124  
 wet process or humid assay of,  
 122-124
- Sinking artesian wells, 343-350
- Slope, advantage of, over the perpen-  
 dicular shaft, 266  
 in coal beds, illustrated and de-  
 scribed, 268  
 sinking a, illustrated and described,  
 261
- Slopes, timbering the partitions, illus-  
 trated and described, 329,  
 330  
 to support the overhanging  
 rock, illustrated and  
 described, 329  
 the roof, illustrated and  
 described, 329
- Sluice, construction of, 259  
 in a gallery, construction of, illus-  
 trated and described, 339
- Smaltine, 238
- Smithsonite, 185, 186
- Soda, symbol and atomic weight, 54
- Sodium, chloride and sulphuret of, 57  
 disulphate, use and preparation of,  
 78, 79  
 nitro-prusside of, 59  
 sulphite, carbonate, phosphate,  
 acetate, succinate, 58
- Solid rock, quarrying, 297, 298
- Spathic ore, characteristics of, 142  
 Kipp's apparatus to determine  
 the amount of iron carbonate  
 in, illustrated and described,  
 162, 163  
 where found, 142, 143
- Specific gravity, an important charac-  
 teristic in mineralogy, 21, 22  
 scales for, 36  
 simplest way of determining,  
 21, 26  
 use of distilled water in making  
 accurate determination of,  
 24, 25
- Specular ore, appearance of, 139
- Speiss, composition of, 153
- Sphalerite, 183
- Spiegel iron, 208
- Spiral auger, operating the, 346, 347  
 use of, in boring a well, 346
- Splitting rock with wooden pins, 297
- Spontaneous combustion in coal mines;  
 generally supposed  
 cause of, 291  
 most effective means  
 of prevention, 291,  
 292
- Spring catch, use of, 348
- Stannite, 176  
 geology of, 180
- Staurolite, 177
- Steam-engine, illustrated and described,  
 310-314
- Stephanite, characteristics of, 115
- Stibnite, 228  
 before the blowpipe, 228  
 color and streak, 228  
 deposits of, in the United States,  
 228, 229  
 extraction of, 230  
 foreign localities of, 229  
 hardness, 228  
 lustre, 227

Stibnite—  
 occurrence of, 228  
 Stones, proper joining of, 333  
 Stratified deposits and beds, preparation and working of, 287-292  
 Strongest important characteristic of a mineral, 21  
 Stream tin, 175  
 Stripping or removing surface for veins, 296  
 Succinate, neutral, of ammonium, preparation of, 60  
 symbol and atomic weight, 60  
 of sodium, symbol and atomic weight, 58  
 test of, 59  
 Succinic acid, symbol and atomic weight, 52  
 use and test of, 52  
 Sulphate of magnesium, preparation of, 61  
 symbol and atomic weight, 61  
 of potassium, symbol and atomic weight, 55  
 test of, 55  
 Sulphite of sodium, symbol and atomic weight, 58  
 test of, 58  
 Sulphocyanide of potassium, symbol and atomic weight, 57  
 Sulphuret of sodium, process of making a solution, 57  
 symbol and atomic weight, 57  
 use of, 57  
 Sulphurets, to separate silver from, 125  
 Sulphuric acid, characteristics of and tests for, 50, 51  
 precaution in using, 50  
 symbol and atomic weight, 50  
 Sulphurous acid or anhydride, symbol and atomic weight of, 53  
 preparation of, 53  
 Sulphur, to ascertain the, in an iron ore, 156-158  
 Sump, proper location for, 266  
 (sumpf), location of, 264  
 Surface or day working, 296-300  
 where applicable, 296  
 working, divisions of work, 291  
 Systematic mining, requirements of, 277, 278

**T**ABLE of atomic weights, practical use of, 39-42  
 of chemical symbols, 37, 38  
 of combining weights of elementary bodies, 38, 39  
 of specific gravity of native silver at different temperatures of the water, 25, 26  
 of the analysis of the ore of platinum, 215  
 Tartaric acid solution, treatment of, 52, 53  
 symbol and atomic weight, 52  
 Terrero, 221  
 Test iron, preparation of, for volumetric determination, 167-170  
 Tierras, 221  
 Timbering and masonry of mines, 317, 318  
 necessary for working in mines, 330, 331  
 of inclined shafts, 329, 330  
 of shafts, 324-329  
 commencement of, illustrated and described, 324, 325  
 renewing, 331, 332  
 to secure greater durability, illustrated and described, 319-321  
 Tin, 174-183  
 before the blowpipe, 179, 180  
 California, assay of, 178  
 estimating the amount of, in any compound, 182  
 extraction of, 180-182  
 in the United States, 176  
 localities and geology, 176  
 mineralogical appearance of, 178, 179  
 occurrent form, 175, 176  
 practice with, under the blowpipe, 31  
 specific gravity of, 174  
 stone, 178  
 stream, 175  
 symbol and atomic weight, 49, 175  
 uses of, 49  
 Titanic acid, detection of, 164, 165  
 where found, 164  
 iron ore, to extract the titanic acid from, 165, 166  
 Tramway, joists for, illustrated and described, 340  
 Transportation, 300-317  
 general rules for, 301  
 on steep inclines, illustrated and described, 314-317

- Transportation—  
 through galleries and drifts having an inclination of more than  $10^{\circ}$  and less than  $30^{\circ}$ , illustrated and described, 301, 302  
 through shafts, illustrated and described, 302  
 through shutes, 302, 303  
 Transporting division of shaft, caution in regard to buckets, 328  
 gallery, complete timbering of, illustrated and described, 328, 329  
 shafts, wooden partition and floor in, illustrated and described, 330  
 Trial shafts or excavations, 257  
 Tripoli, 244  
 Tunnel, arched, construction of, 337, 338  
 Tunnelling for quarries with very thick covering or difficult of access, 298  
 Turbine blades, form and curvature of, illustrated and described, 309  
 wheels, use of, 309

### VALENTINITE, 228

- Valve sockets, use of, 347  
 Vaults, danger of crushing in working the drifts, 293  
 Vein dividing into several branches, 272  
 having a selvage or partition rock, treatment of a, 284  
 not over twelve feet thick and to be mined overhead, working of a, illustrated and described, 279, 280  
 or lode, not uniformly rich, method of working, 285  
 thin or pinched, 272  
 working of a, in case of a fault, 272, 273  
 Veins and lodes, how prepared and mined, 279-287  
 ore, important changes of, 271, 272  
 Volumetric determination of iron, 166-172  
 preparation for, 167  
 by potassium permanganate, 166

- WALL, to give a firm position to a, illustrated and described, 334  
 Walls, dry, advantage of, in mines, 338  
 for filled-in spaces, arches for, 341

- Walls—  
 or roofs, supporting, 291  
 preparations for beginning, 334  
 Washboard for buddling, 299  
 Water at the side of a shaft, manner of draining, 341  
 collecting of pure, 70, 71  
 for finest analyses, 43, 44  
 formula of, 43  
 of crystallization, intumescence caused by escape of, 31  
 pure, use of, in determining a specific gravity, 24, 25  
 Weighing blocks of minerals without scales, 26  
 Wells, machinery for digging, 350  
 oil and gas, 350-352  
 Wet assay of iron, Wöhler's method of, 150, 151  
 method of assay for iron, 147  
 Wheel and shaft, position of, illustrated and described, 309, 310  
 Whim, water, illustrated and described, 307-309  
 Willemite, 186  
 Windlass, the, illustrated and described, 303-306  
 Wöhler's method of wet assay for iron, 150, 151  
 Wood tin, 178  
 Workmen, ingress or egress of, illustrated and described, 316, 317  
 "Wrench bar," use of, in well digging, 348

### XENOTIME, characteristics of, 248

### ZAFFRE, 238

- Zinc, 183-193  
 carbonate of, 185  
 of, under the blowpipe, 186  
 color of, 183  
 distillation of, 49  
 distilling, 187-189  
 ductility of, 183  
 granulation of, 44  
 gravity of, 183  
 impurities, 184  
 in the United States, 184  
 localities, foreign, 184  
 metallic, hardness of, 183  
 melting point, 184  
 occurrent form of, 183



Zinc—

oxide, Belgian distilling process,  
189  
pure, characteristics of, 189  
Silesian distilling process, 189  
proportion of metallic, in the oxide  
of, 190  
pure metallic, obtaining by the wet  
process, 190-193

Zinc—

purifying of, 44, 45  
silicate of, appearance of, 185  
sulphide, characteristics of, 185  
where found, 184  
symbol and atomic weight, 49  
under the blowpipe, 185, 186  
uses of, 49



①







**UNIVERSITY OF CALIFORNIA LIBRARY  
BERKELEY**

**Return to desk from which borrowed.  
This book is DUE on the last date stamped below.**

MAR 19 1948

20 Nov '55 Ws

NOV 6 1955

6 OCT 5 1955

REC'D LD

OCT 9 1961

APR 16 1983

REC. CIR. MAY 5 '83

43212

1  
143  
05

**THE UNIVERSITY OF CALIFORNIA LIBRARY**

