



LIBRARY OF CONGRESS.

Class. *2* Serials No. *100*

Shelf M84

UNITED STATES OF AMERICA.

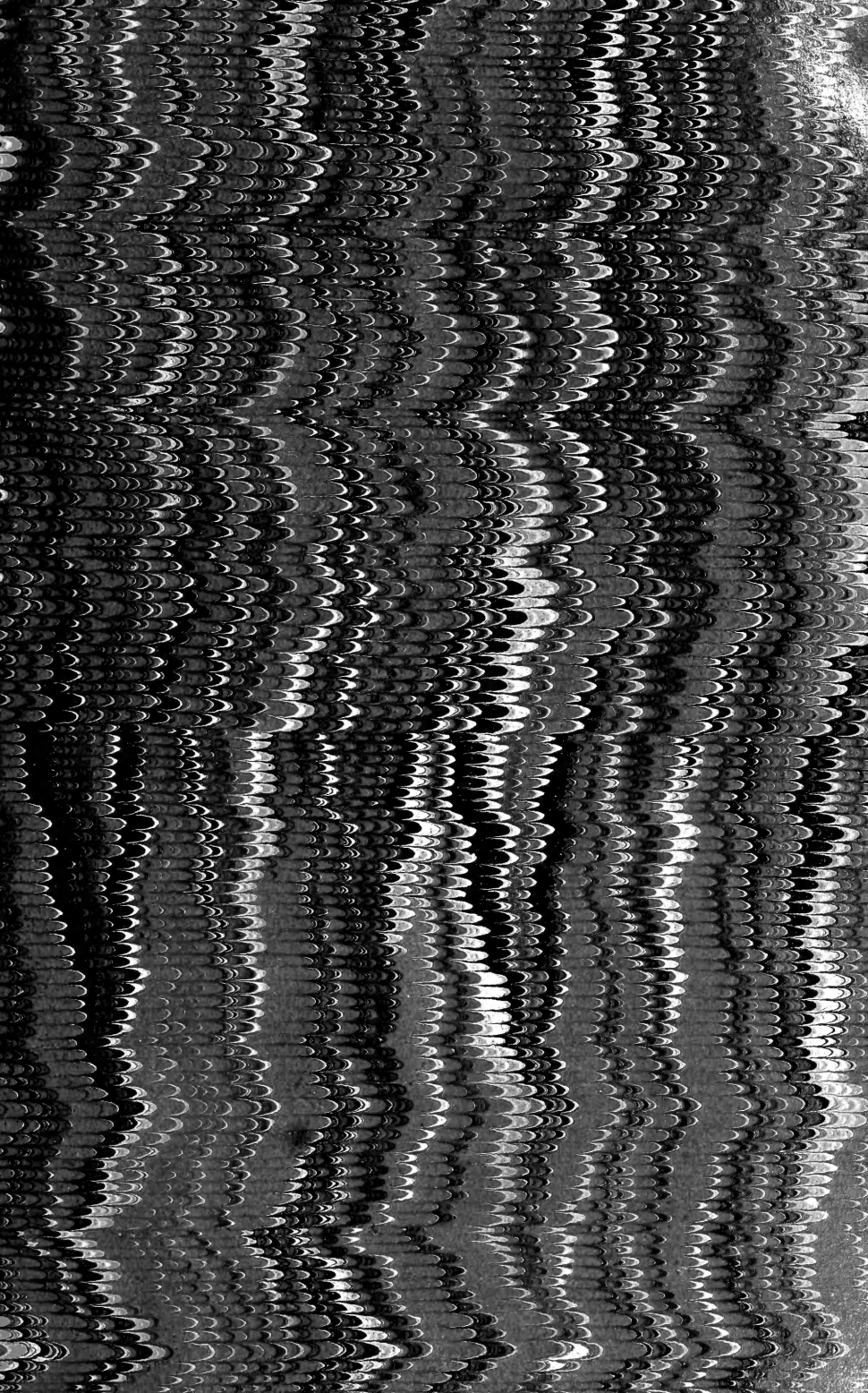







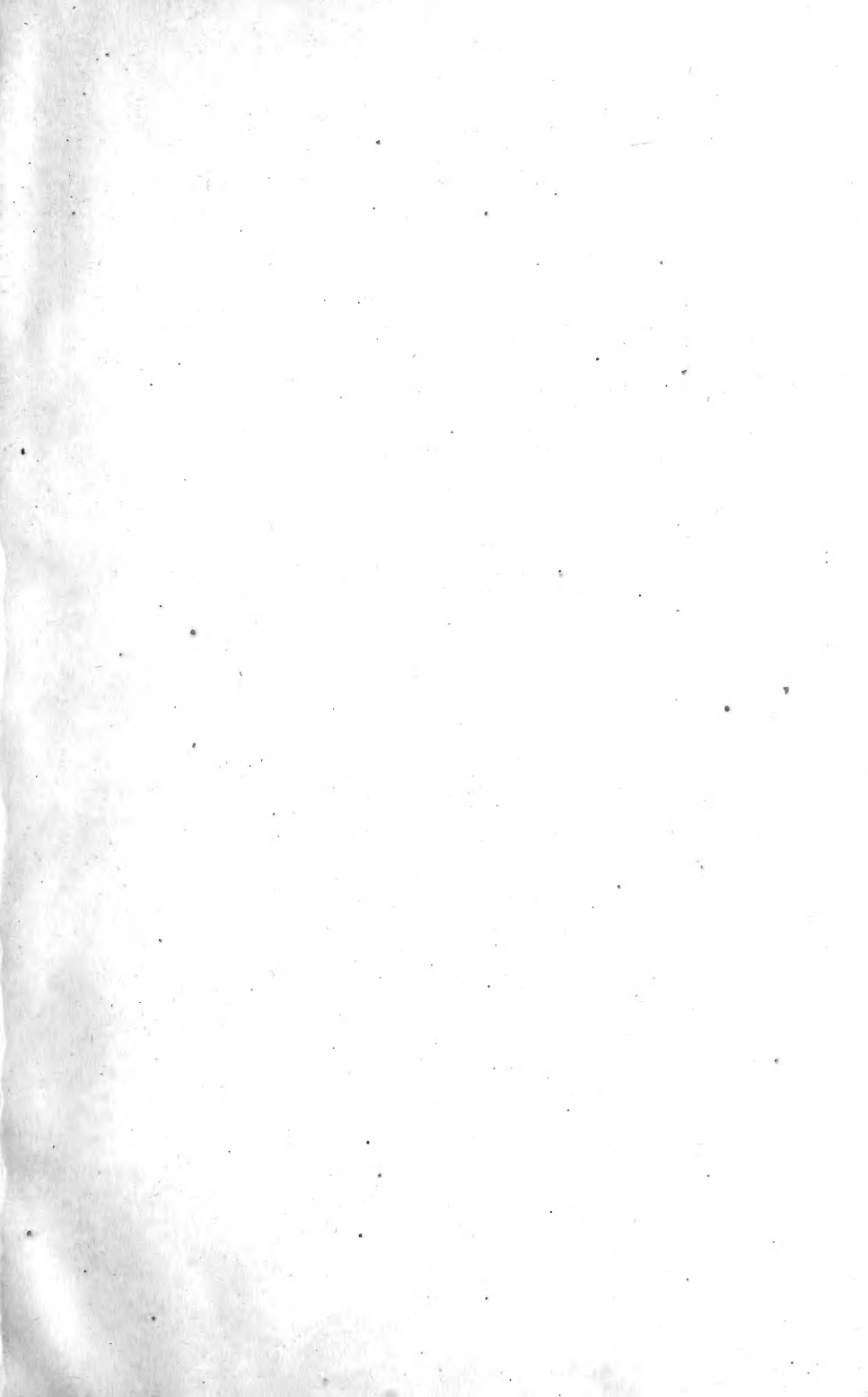



A PRACTICAL TREATISE
ON PURE FERTILIZERS.

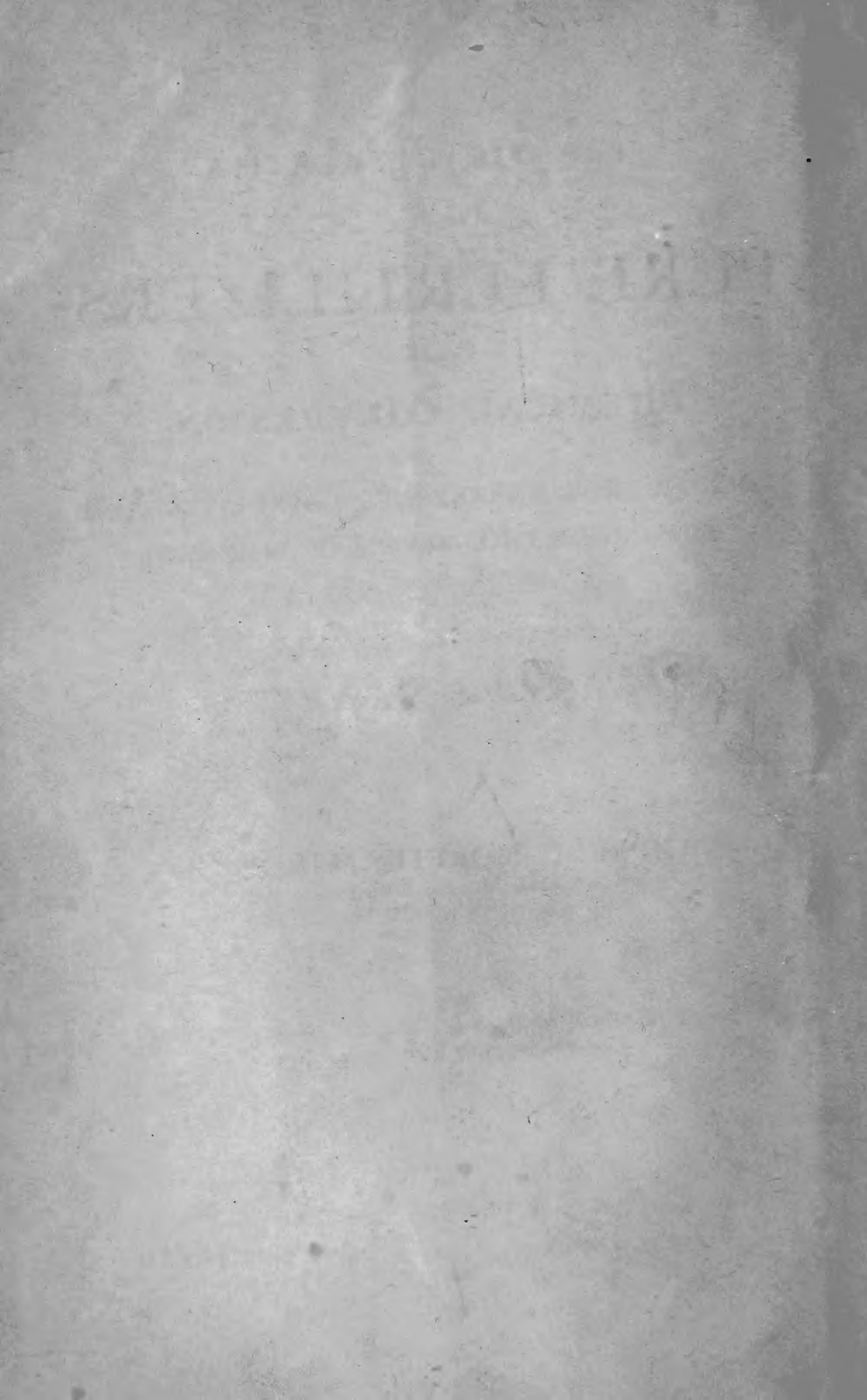

17627, C-

A
PRACTICAL TREATISE
ON
PURE FERTILIZERS;
AND THE
CHEMICAL CONVERSION
OF
ROCK GUANOS, MARLSTONES, COPROLITES, AND
THE CRUDE PHOSPHATES OF LIME AND
ALUMINA GENERALLY,
INTO VARIOUS
VALUABLE PRODUCTS.

BY
✓
CAMPBELL MORFIT, M.D., F.C.S., TORONTO



FORMERLY PROFESSOR OF APPLIED CHEMISTRY IN THE
UNIVERSITY OF MARYLAND.

*With Twenty-Eight Illustrative Plates, or Construction Plans,
drawn to Scale Measurements.*

NEW YORK:
D. VAN NOSTRAND, PUBLISHER,
23, MURRAY STREET, AND 27, WARREN STREET.
1872.

ENTERED ACCORDING TO THE ACT OF CONGRESS IN THE YEAR 1872, BY
CAMPBELL MORFIT,
IN THE CLERK'S OFFICE OF THE DISTRICT COURT OF THE UNITED STATES FOR THE
STATE OF MARYLAND.

3625
1184

PREFACE.



THIS treatise is founded upon the special studies and large professional experience of the author in the technology of the mineral phosphates of lime and alumina. All of its teachings are submitted, therefore, as practical knowledge, setting forth the subject systematically, in its most improved relations to science and economics.

The illustrations, which, with few exceptions, are new, have been drawn large to a scale and as actual construction-plans, so that they may be fully expressive without long descriptions. Their creditable style

is due to the draughting skill of Mr. H. Herbert Lewis, a talented mechanical engineer, who worked out the author's original designs.

LONDON,

November 11th, 1872.



TABLE OF CONTENTS.



CHAPTER I.

	PAGE
THE GENERAL RELATIONS OF THE SUBJECT - -	1-6

CHAPTER II.

THE RAW MATERIALS.—COMPARATIVE SOLUBILITY OF THE CRUDE PHOSPHATES.	
---	--

Bone-black ; Bone-ash ; Apatite ; Phosphorite ; Spanish Phosphorite ; Welsh Phosphorite ; German Phosphorite ; Russian Phosphorite ; Austrian Phosphorite ; Coprolites ; Wicken Coprolites ; Calais Coprolites ; Rossa or Guaymas Guano ; Sombrero Guano ; St. Martin's Phosphate ; Marlstones ; South Carolina Phosphate ; French Phosphate ; Cooperite or Navasa Guano ; Orchila Guano. —Analytical table of the comparative composition of the crude or natural phosphates of Lime.—Sulphuric acid ; Brown oil of vitriol ; Chamber acids ; Table of strengths.—Hydrochloric acid ; Table of strength.—Crude ammonia liquor from coal-gas and bone-black works.—Table of the supply and value of nitrogenous wastes.—Woollen refuse ; Leather clippings ; Dried blood ; Dried flesh ; Carne cozida ; Greaves or cracklings ; Human excrements ; Sewage ; Suggestions for the conversion of the latter into ammonia salts ; Morris and Penny's process ; J. Berger Spence's and Dunn's process.—Sulphate

of ammonia ; Chloride of ammonium.—Sulphate of potassa ; Chloride of potassium.—Carbonate of potassa ; Salt of tartar ; Pearl ash.—Lime ; Carbonate of lime ; Chalk ; Whiting ; Hydrated sulphate of lime.—Nitrate of soda	-	-	-	-	-	7-66
--	---	---	---	---	---	------

CHAPTER III.

CHEMICAL DATA IN CONNECTION WITH THE RAW MATERIALS OF ARTIFICIAL FERTILIZERS.

Tri- or bone-phosphate of lime ; Di- or neutral-phosphate of lime ; Bi- or superphosphate of lime ; Precipitated phosphate of lime ; Colombian phosphate of lime ; Sulphite of calcium phosphate.—Phosphate of magnesia.—Carbonate of lime ; Organate of lime ; Sulphate of lime.—Fluoride of calcium ; Chloride of calcium.—Oxide of iron ; Phosphate of iron.—Oxide of aluminium ; Phosphate of alumina.—Organic matters.—Silica and sand.—Water	-	-	-	-	-	67-91
--	---	---	---	---	---	-------

CHAPTER IV.

THE GRINDING AND SIFTING APPARATUS.

Burr-stone mills ; Roller-mill ; Chasers ; Revolving sifter ; Blake's crusher ; Howel-Hannay's centrifugal mill	-	92-107
---	---	--------

CHAPTER V.

THE PLANT.

Steam-boiler and engine ; Roasting furnace ; Platform and its accessories ; Elevator ; Lift ; Acid reservoir ; Mixer ; Stone digestion vats ; Solution vats ; Syphon ; Montejus ; Precipitation vat ; Drying kiln ; Wash vat ; Evapo-

rating pan ; Mixing machines ; Carr's disintegrator ; Poole and Hunt's mixer	-	-	-	-	108-146
---	---	---	---	---	---------

CHAPTER VI.

THE ARRANGEMENT OF THE FACTORY PLANT	-	-	-	-	147-152
--------------------------------------	---	---	---	---	---------

CHAPTER VII.

THE RATIONALE OF THE PROCESSES FOR REFINING THE CRUDE PHOSPHATES OF LIME.					
--	--	--	--	--	--

Diagram of the progressive operations and their effects					153-161
---	--	--	--	--	---------

CHAPTER VIII.

THE MANUFACTURE OF PRECIPITATED PHOSPHATE OF LIME.

First fractional treatment or purge for the removal of car- bonate of lime ; Second fractional digestion for the solu- tion of the tri-phosphate of lime constituent ; the vacuo- precipitation vats ; the ammonia-generator ; Air-pump ; Filtration in vacuo ; Reclamation of the ammonia-precipi- tant for repeated use indefinitely ; Utilization of the purge liquor	-	-	-	-	162-202
--	---	---	---	---	---------

CHAPTER IX.

THE MANUFACTURE OF COLOMBIAN PHOSPHATE OF LIME.

First process : The use of whiting as precipitant ; Horizontal sieve ; Composition of the product ; the utilization of the mother-liquor or wash. Second process : The use of iron and aluminium impurities of the mineral, as precipi- tant	-	-	-	-	203-225
--	---	---	---	---	---------

CHAPTER X.

THE MANUFACTURE OF DI-PHOSPHATE OF LIME.

Morfit's process (A) : Porcelain-lined vat ; Morfit's process (B) ; J. Thomas Way's process ; Ernest Deligny's process ; Way's chloro-phosphate of lime and the method of making it	-	-	-	-	-	-	226-276
---	---	---	---	---	---	---	---------

CHAPTER XI.

THE METHOD OF RECLAIMING THE CHLORIDE OF CALCIUM MOTHER-LIQUOR IN PROFITABLE FORMS.

As pure chloride of calcium ; as chloride of ammonium and hydrated sulphate of lime by means of sulphate of ammonia or gas-liquor ; by means of sulphate of potassa as chloride of potassium ; by means of phosphate of soda	-	-	-	-	-	-	277-287
--	---	---	---	---	---	---	---------

CHAPTER XII.

THE PRINCIPLES OF THE SUPER-PHOSPHATING PROCESSES.

The maximum yield by pure tri-phosphate of lime ; the fallacies of the usual methods ; the maximum yield by bone-ash ; by coprolites and marlstones ; Analyses	-	-	-	-	-	-	288-297
--	---	---	---	---	---	---	---------

CHAPTER XIII.

THE MANUFACTURE OF PURE "SUPER-PHOSPHATE".

Composition of the products from pure tri- and di-phosphates of lime	-	-	-	-	-	-	298-302
--	---	---	---	---	---	---	---------

CHAPTER XIV.

THE MANUFACTURE OF PURE AND WHOLLY SOLUBLE BI-PHOSPHATE OF LIME.

The turbine ; the vacuo-leaching vat - - - - - 303-314

CHAPTER XV.

THE MANUFACTURE OF "COMMERCIAL SUPER-PHOSPHATE".

Composition of the product from various crude bases.—The

wells - - - - - 315-326

CHAPTER XVI.

THE MANUFACTURE OF HORSFORD-LIEBIG'S AND OTHER PHOSPHATIC BAKING-POWDERS.

The process of manufacture ; the directions for use ; Brown or bran bread ; Bread for gouty patients ; Confectioner's cakes ; White bread.—The steam evaporating-pan - 327-338

CHAPTER XVII.

GERLAND'S SULPHITE OF CALCIUM-PHOSPHATE.

Its composition, properties, and manufacture ; Its uses as a fertilizer ; as a disinfectant.—The chemical analysis of the product - - - - - 339-359

CHAPTER XVIII.

THE CHEMICAL TREATMENT OF "REDONDA GUANO" AND "ALTA VELA GUANO" AND MINERAL PHOSPHATES OF ALUMINA AND IRON GENERALLY, FOR CONVERSION INTO FERTILIZERS.

Redonda guano ; Alta Vela crust ; A. B. R. phosphate rock ; Analytical table of their comparative composition and value ; Method for converting them into potential fertilizers ; Digestion vats of stone - - - - - 360-377

CHAPTER XIX.

THE MINERAL PHOSPHATES OF ALUMINA AND IRON AS RAW MATERIAL FOR THE MANUFACTURE OF ALUM AND OTHER USEFUL PRODUCTS.

Peter Spence's process for making alum, sulphate of alumina, crude phosphoric acid and phosphates ; J. Berger Spence's and Peter Dunn's processes for removing ammonia from illuminating gas ; for the manufacture of phosphates of ammonia and lime.—Townsend's process - - - - - - - - 378-392

CHAPTER XX.

THE MINERAL PHOSPHATES OF ALUMINA AND IRON AS RAW MATERIAL FOR DEFECATING SEWAGE.

Their application in purifying and utilizing town sewage ; Forbes's processes ; Price's processes ; Morfit's "mother-water" as substitute for Alta Vela and Redonda guanos ; comparative composition of the sewage precipitates obtained by the use of the "mother-liquor" and sulphuric solution of Alta Vela guano - - - - - - - - 393-401

CHAPTER XXI.

THE PROFITABLE UTILIZATION OF THE PHOSPHAT-ALUMINA PRECIPITATE FROM SEWAGE AS RAW MATERIAL FOR VARIOUS PRODUCTS.

For the reclamation of its nitrogenous matter as material for the manufacture of ammonia salts ; as raw material for the manufacture of alum and pure phosphates of alumina and lime ; as aluminate of soda or ready saponifier and common salt.—Phosphate of alumina in the manufacture of sugar ; in dyeing ; as a glaze for pottery - - - - - - - - 402-418

CHAPTER XXII.

SPECIAL FERTILIZERS AND THEIR PREPARATIONS.

The physical and chemical structure of soils.—Normal fertilizer ; Universal Dunger ; Fertilizer for cereal crops ; for leguminous plants ; for gramineous crops ; for sugar ; for root crops	-	-	-	-	-	419-431
--	---	---	---	---	---	---------

CHAPTER XXIII.

FORMULÆ FOR THE CHEMICAL ANALYSIS OF PHOSPHATIC MATERIALS AND PRODUCTS.

The chemical and ethical principles involved.—Instructions for the full analysis of bone-ash and mineral phosphates of lime ; of mineral phosphates of alumina and iron ; of "commercial superphosphate" ; of compound fertilizers	-	-	-	-	-	432-484
--	---	---	---	---	---	---------

CHAPTER XXIV.

THE COMMERCIAL VALUATION OF CRUDE AND REFINED FERTILIZING MATERIALS	-	-	-	-	-	485-510
---	---	---	---	---	---	---------

CHAPTER XXV.

THE MODE OF USING HYDROMETERS AND THERMOMETERS	-	-	-	-	-	511-519
--	---	---	---	---	---	---------

CHAPTER XXVI.

ACID AND WATER-PROOF CEMENTS AND PAINTS	-	-	-	-	-	520-530
INDEX	-	-	-	-	-	531-546

ERRATA.

- Page 35.—In the heading of the table, read " SO_3 ," for "SO."
,, 74.—In the sixth line from the top, read " O_5 ," for "O."
,, 95.—In the sixth line from the bottom, read "f," for "b."
,, 101.—At the bottom line, read "fig. 3," for "fig. 1."
,, 111.—At the eighth line from the top, read "D," for "O."
,, 116.—At the fifteenth line from the top, read "G," for "D."
,, 120.—At the seventeenth line from the top, read "a a," for "AA."
,, 120.—At the twenty-second line from the top, read "a," for "h."
,, 191.—At the seventeenth line from the top, read "k," for "l."
,, 192.—At the eighteenth line from the top, read " r_3 ," for "x."
,, 254.—At the last line, read "bone-ash," for "bone."

A LIST OF THE ENGRAVED PLATES OR CONSTRUCTION PLANS.



PLATE	PAGE
1. ROLLER MILL	5
2. REVOLVING SIEVE	20
3. BLAKE'S CRUSHER	35
4. HOWEL'S CENTRIFUGAL MILL	50
5. PLATFORM, LIFT, AND ELEVATOR	65
6. DETAILS OF LIFT AND ELEVATOR	80
7. MIXER	98
8. DIGESTER OR SOLUTION VAT	110
9. TROLLEY FOR BRINGING UP CARBOYS	123
10. MONTE-JUS	140
11. PRECIPITATION VAT	155
12. DRYING KILN	175
13. EVAPORATING PAN	195
14. } CARR'S MIXING MACHINE	{ 215
15. }	{ 225
16. GROUND PLAN OF A FACTORY ARRANGEMENT	245
17. } BATTERY OF PRECIPITATION VATS, WITH AMMONIA-	{ 265
18. } GENERATOR	{ 285
19. VACUUM FILTER, WITH AIR-PUMP AND MONTE-JUS	305

PLATE	PAGE
20. HORIZONTAL SIFTING AND STRAINING MACHINE	... 330
21. PUG-MIXER 350
22. SOLUTION VAT COMBINED WITH VACUUM FILTER	... 370
23. DRAINERS 395
24. SUPER-PHOSPHATE WELLS OR PITS	... 420
25. FILTERING STANDS 440
26. } APPARATUS FOR THE TREATMENT OF MINERAL PHOS-	{ 460
27. } PHATES OF ALUMINA	{ 480
28. DOUBLE-PAN FOR MAKING ACID-PROOF CEMENT AND PAINT 500

PURE FERTILIZERS.

CHAPTER I.



THE GENERAL RELATIONS OF THE SUBJECT.

THE fructification of soils has its natural pabulum, undoubtedly, in the sewage of cities, towns, and habitations; and it is desirable, both as respects agricultural interests and the public hygiene, that thoroughly efficient means should be devised for utilizing this resource judiciously. Until this is done, the food required by growing crops must be supplied through the media of artificial fertilizers. The manufacture of these products has become, consequently, an enterprise of great magnitude, which is daily extending its area; so that abundant supplies of the basis-material are indispensable. Fortunately, the beneficence of Nature

vouchsafes to us vast deposits of this basis-material, which she has distributed throughout the surface of the globe in the form of mineral phosphates, and as a temporary substitute for sewage, while our enterprise and skill may remain at fault in managing the latter with a perfect facility.* These mineral phosphates consist of the various kinds of "Rock Guano," Coprolites, the fossils of Marlbeds, and the minerals Apatite and Phosphorite.

The chief and valuable constituent of them is bone-phosphate of lime. In some few instances, phosphate of alumina is the prevailing constituent.

All of these varieties of the mineral phosphates differ from the typical phosphate of lime, which is bone-ash, in having a very dense, compact physical structure, owing to the peculiar state of aggregation of their chemical elements. These elements vary with the kind of mineral phosphate, but besides tri-phosphate of lime, are commonly water,

* Their geological distribution is explained fully in an interesting paper by W. J. T. Dyer and A. H. Church, at pp. 159-185, vol. ii of *Practice with Science*.

organic matter, silica, sulphate lime, carbonate lime, together with aluminium and iron oxides and phosphates. Some of them have only a secondary value as agricultural powers, while the others are objectionable, because they dilute the mass unprofitably. In another, and far more serious sense, however, their presence impairs the usefulness of the raw mineral; for the latter, even when powdered finely, is by their cementing action rendered rather passive to decomposing influences, and consequently a slow fertilizer.

I say slow, because I do not share the opinion of many sagacious chemists, that phosphates of alumina and iron are without fertilizing effect; nor yet that it is indispensable to change the chemical structure of the mineral phosphate of lime in order to give it action as a manure. They have inertia in those respects undoubtedly; but it is my belief that the need of phosphoric acid by the growing crops is so great as to give them the energy to draw it from the most difficult source if none easier should be accessible. At the same time the strain which is thus put upon the assimilating powers of the

plant must weaken its constitution and impair the quantity as well as the quality of the harvest.

Upon the ground of expediency, therefore, and to economize time, labour, and money, this fault of the mineral phosphates should be corrected by a proper chemical treatment, preliminary to their application to soils. That is, they must not only be finely powdered, but converted into forms which are promptly sensitive to the solvent action of aqueous solutions of carbonic and organic acids, very dilute acetic acid, ammoniacal and potassic salts, and of the corresponding influences of the soil and plants as exerted during the progress of vegetation.

The usual method of destroying the inertia, or passive condition of mineral phosphates, is to act upon them with sulphuric acid which should convert their tri-phosphate of lime into soluble bi-phosphate. This plan is perfectly sound in principle; but, on account of the slovenly mode of carrying it out generally practised, variable quantities of the raw phosphate remain undecomposed, and, as a consequence, proportional amounts of free sulphuric acid are introduced.

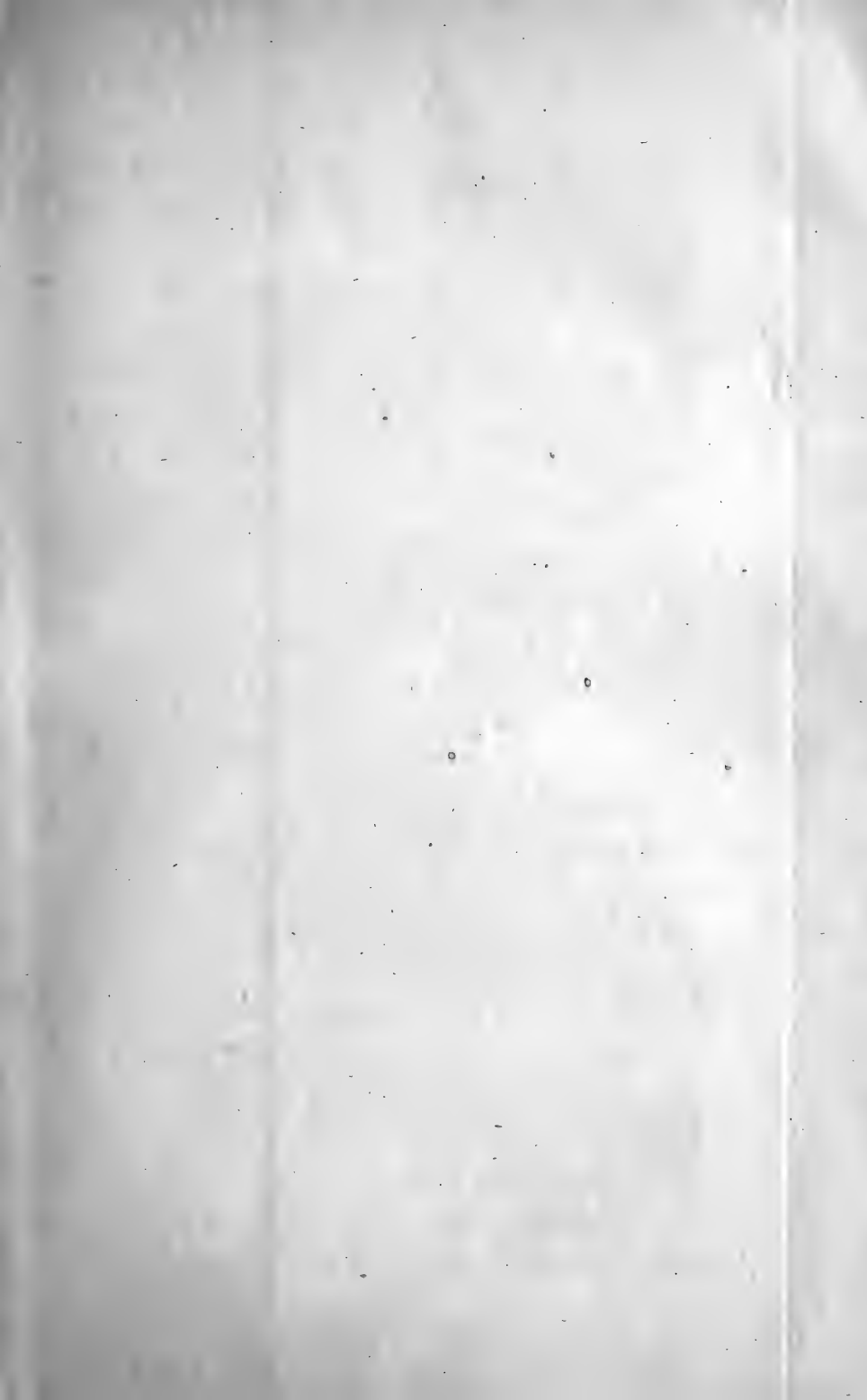

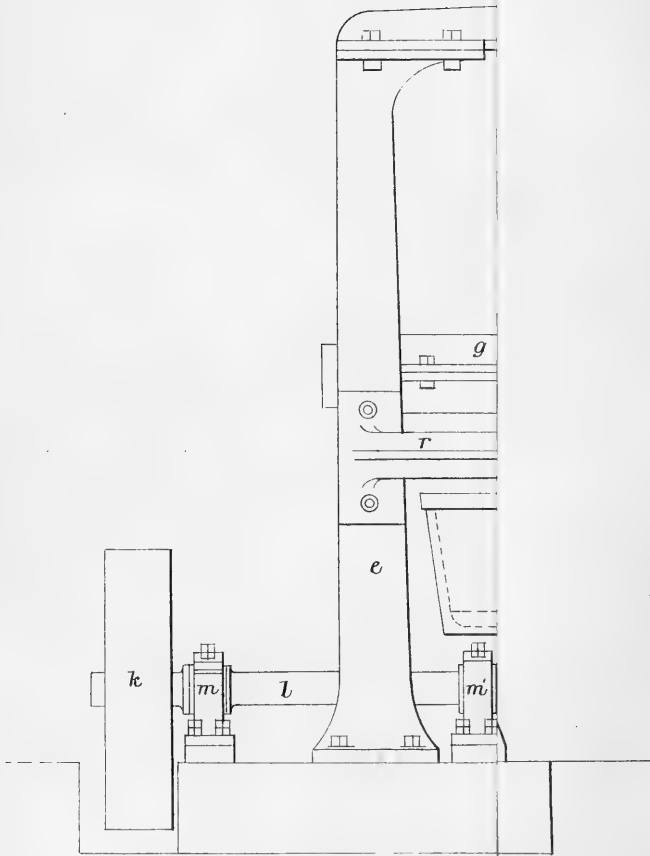

Here, then, consequently, are a profligate waste of two materials, a want of uniformity in the product, and a wide extent of dilution, by reason of the sulphate of lime which is formed, to say nothing of the disadvantage of the free sulphuric acid.

What is wanted, then, are methods, simple and economical, for changing not merely the physical constitution of the mineral phosphates, but also their chemical temperament, and in such a manner as to convert them into fertilizers at once concentrated and potential. These latter qualities are important, more especially on the score of package and freight or transportation charges in extensive countries, like the United States of America, where distribution of the products is mostly in small lots, to the interior of scattered and often remote districts. In such cases, the necessary or desirable dilution may be done by the farmer himself, and with suitable as well as inexpensive materials which abound at his door, and thus save him needless outlay.

The chemical mind has been very active in suggesting ways of accomplishing the needed

ROLLER MILL.

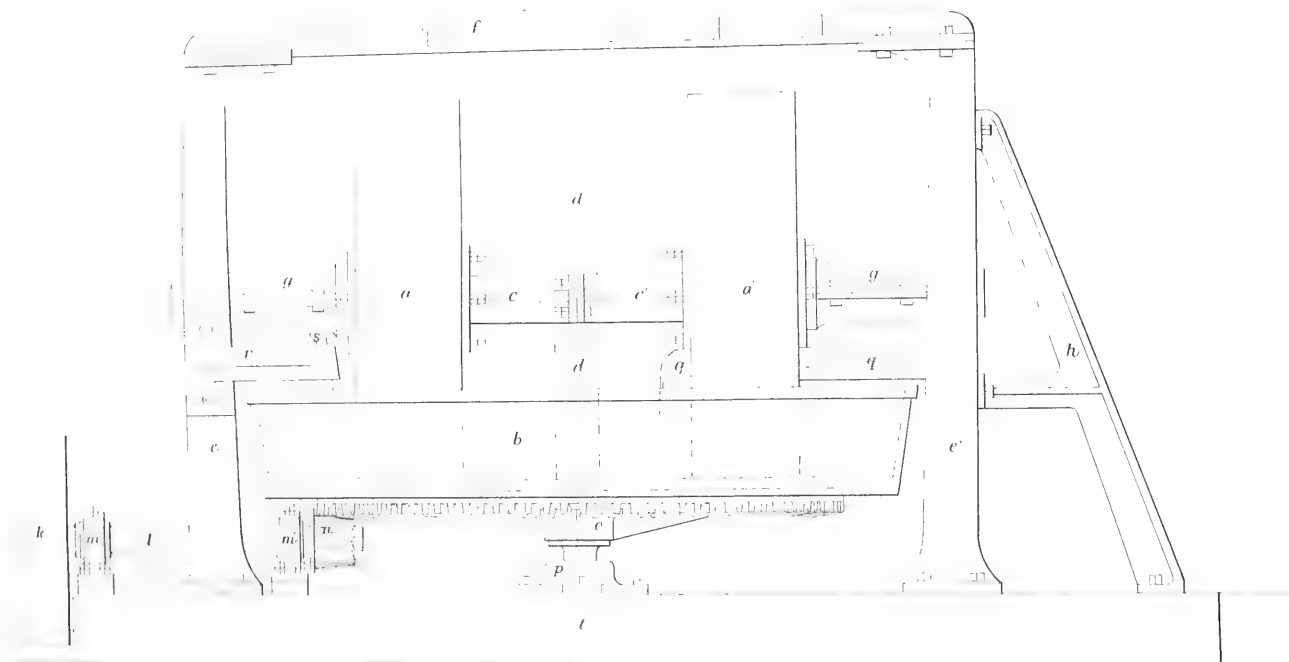

FRONT ELEVATION.

SCALE OF FEET



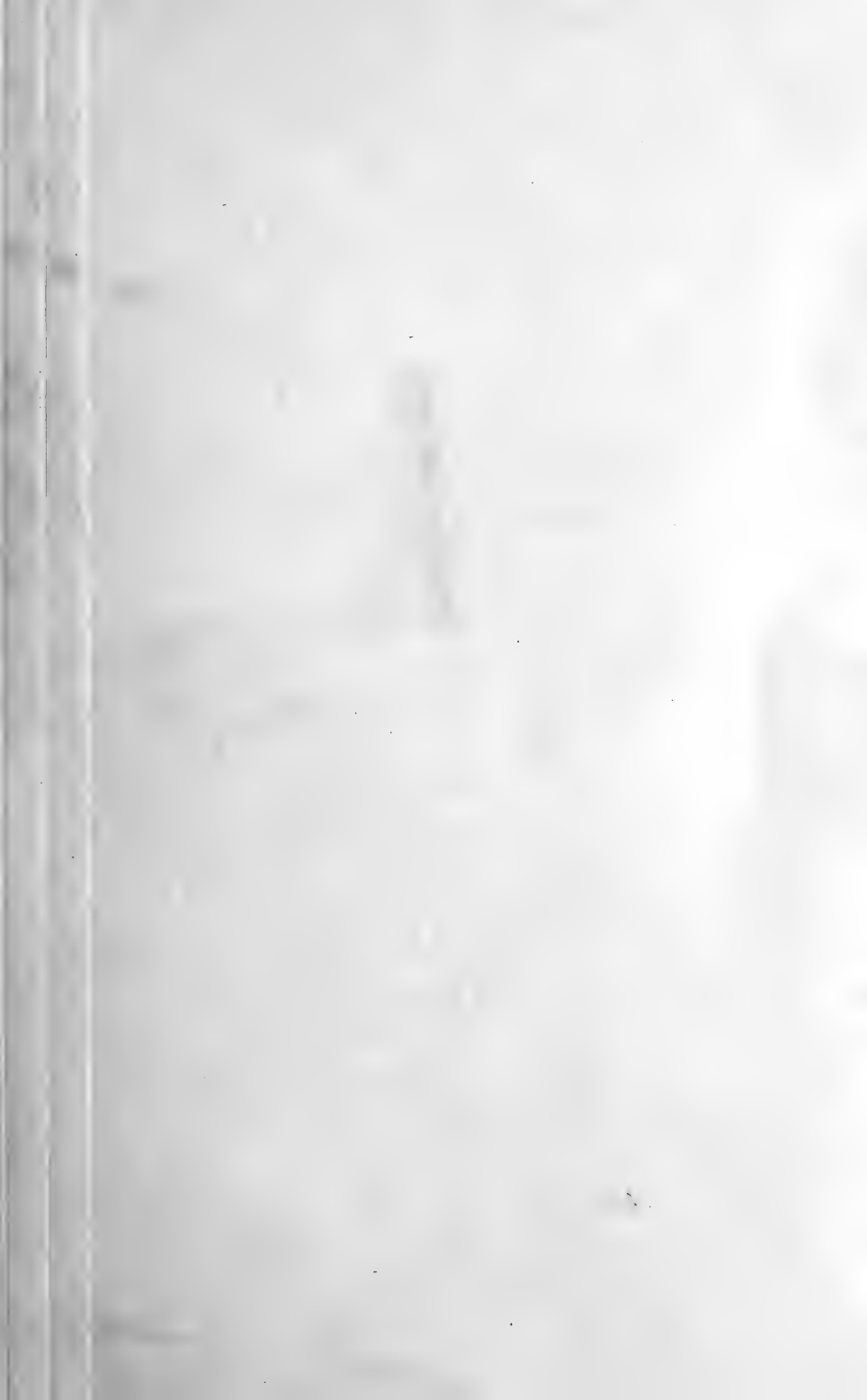

improvement. Treatment in furnaces with fluxes, and boiling in pans with salts of different kinds, in order to render the phosphoric acid constituent soluble, are the methods most commonly met with in books. The use of acids of several kinds, and in varied manner, also constitutes the substance of many recorded processes.

But, in most cases, the chemical agent employed is either itself an undesirable element to import into the fertilizer, or the mode of use is expensive, by reason of the agent not producing incidentally some tangible result to repay fully its cost. Then, too, there is the bulkiness of the raw phosphate, which renders the usual methods both troublesome and defective in economy.

No plan of instruction is equal to the chemical agricultural and commercial requirements of the case which does not remedy these deficiencies. This consideration, therefore, is held paramount in the processes of the following chapters. Self-compensating throughout, they will deliver the products in the most valuable forms with the least possible manufacturing expense and waste.

CHAPTER II.



THE RAW MATERIALS.

THE raw materials involved in the manufacture of artificial fertilizers are the animal and mineral phosphates of lime, sulphuric acid, hydrochloric acid, crude ammonia liquor, sulphate of ammonia, chloride of ammonium, sulphate of potassa, chloride of potassium, carbonate of potassa, lime, and nitrate of soda.

The sources of the chief class, that is the phosphates, are all natural, the several individuals being bone-black, bone-ash, apatite, phosphorite, coprolites, marl-stones, and the "rock guanos".

Bone-Black.

This material, known also by the title of "Animal Charcoal", is made by calcining

bones in a manner to drive off all the volatile matters except carbon, which is left with the phosphate of lime. This residue thus formed, when ground to powder, is sold to sugar refiners for decolorizing their solutions. After having been used and "*revived*" several times, its bleaching power has become exhausted, and then it is sold either as a manure or for conversion into "*superphosphate*". It contains a large amount of organic matter, more particularly when blood has been associated with it in the decolorizing or refining operation.

Bone-Ash.

This is a greyish-white powder obtained by calcining raw-bones, in open vessels, so as to get rid of the moisture, organic matter, and carbon; as these associates would interfere with the economy and convenience of transportation from distant countries where cattle abound and are killed for their hides, tallow, and bones. The supplies come mostly from the La Plata Districts of South America, and the Baltic, Mediterranean, and Black Sea ports, where the process of manufacture is conducted so wastefully that the valuable

ammonia distillate does not receive any consideration.

The tri- or bone-phosphate of lime in this ash, as well as in the bone-black, is peculiarly sensitive to the assimilating action of growing crops. For example, one part of its phosphate is soluble in 6800 parts of carbonic water, according to Warrington's experiments; and this solubility is even greater when alkaline salts are present.

Both the bone-black and bone-ash are such superior fertilizers for direct application to the soil, that it would be profligate to use them as raw material for conversion into "superphosphate". So great and growing is the demand for these two materials, that their market price has advanced twenty per cent. within the last few years.

Apatite.

This is a hard mineral, sometimes crystallized and at others foliated or conchoidal, which is found generally in thin seams in crystalline or volcanic rocks. It varies in colour from light green to iron-stone red. The principal localities are Norway, Sweden,

Switzerland, Bohemia, Saxony, Bavaria, Canada, New York, and New Jersey. In order to obtain a fair average sample, it is necessary to grind an entire ton, owing to the difficulty of excluding foreign minerals in mining it.

According to Voelcker, the Norway apatite is always free from fluoride of calcium, which is present, usually, in the other varieties.

The Canadian apatite is crystallized, crystalline, granular, and massive, and of a sea-green, olive green, greyish, or reddish colour. It abounds, according to T. S. Hunt, in the Laurentian limestones of North Elmsley and North Burgess, where it forms numerous beds eight to twenty-four inches thick and about ten feet broad.

The closely cemented structure of this mineral, even when finely powdered, makes it unsuited, in an economical sense, for direct application to soils. It must be previously converted into precipitated phosphate or superphosphate, for which purposes it is most eligible on account of its high content of lime phosphate and low proportion of waste constituents.

The commercial supply of apatite is limited, owing to the difficult accessibility of its sources.

Phosphorite.

The best qualities of this material are found at Estramadura in Spain, and Amberg in Bavaria. In both of these localities it abounds, but does not reach foreign markets in any quantity, because of the great expense of mining labour, and of the difficulties of inland transportation at the sources. It derives its name from its property of becoming phosphorescent when heated.

It is found in thick beds flanked with apatite and quartz. It is fibrous in structure, of a light yellow colour, and very hard, as well as difficult to powder. It is a very superior raw material for conversion into refined phosphates; and to this preparatory treatment it should be subjected in order to render it a prompt and economical fertilizer.

Welsh Phosphorite.

The phosphatic beds at Cwmgwnnen in the Lower Silurian series of North Wales has an

area, according to W. J. T. Dyer and A. H. Church, of four miles long by a width of eighty yards and a thickness of fifteen inches. It is worked by adit levels driven in from the hill side, which it intersects almost vertically.

German Phosphorite.

Recent geological surveys have revealed very extensive deposits of this mineral in the districts of Staffel, Limburg, Hinterland, Wetzlar, Oberlahn, Unterlahn, the borders of the river Lahn and Dill, and other portions of the right basin of the Rhine.

“It lies, generally, in diabase and shale overlapped or underlaid by lower and middle Devonian and by diluvial beds. The whole region is full of seams, beds and veins of black, red, and brown hematites.”

On account of its immense mass, the mineral of the Staffel and Limburg beds can only be mined by blasting. It is an amorphous solid, of a brownish-yellow or fawn-grey colour, with a splintery fracture; but there are two varieties, one of which is friable and the other is soft.

Though it contains some calcium fluoride

and carbonate, alumina, and oxide of iron, it is, nevertheless, a good raw material for refining purposes, and should be subjected to this preparatory treatment instead of being applied, in its natural powdered state, to the soil.

The analysis, by Fresenius, in the table at page 30, represents a selected sample, doubtless; for that which forms a deposit of about four thousand German acres, near the Lahn river in Nassau, is several per cent. less rich. Its composition, according to Voelcker, is as follows:—

Moisture	-	-	-	0.36
Water of combination	-	-	-	1.85
Phosphoric acid (= 3CaO, PO ⁵ 65.19)	-	-	-	29.86
Lime	-	-	-	42.31
Magnesia	-	-	-	0.30
Sulphuric acid	-	-	-	0.65
Carbonic acid	-	-	-	2.86
Oxide of iron	-	-	-	4.43
Alumina and loss in analysis	-	-	-	6.33
Insoluble siliceous matter	-	-	-	11.05
				100.00

Russian and Austrian Phosphorite.

The great phosphorite zone in Russia occupies an area of 20,000 square versts:

extending from the Volga, near Simbirsk, into the Desna district of Smolensk; and thence, after a real or apparent break, into the government of Grodno. Grewingk's analysis gives the following composition for the mineral:—

Organic matter and constitutional water	-	4.702
Moisture or accidental water	-	0.910
Silica	-	42.965
Fluorid of calcium	-	3.535
Proto-carbonate of iron	-	3.847
Carbonate of magnesia	-	1.602
Oxide of iron	-	0.922
Alumina	-	5.027
Phosphate of alumina	-	1.874
Tri-phosphate of lime	-	32.950
Potassa	-	0.751
Soda	-	0.593
Sulphuric acid	-	0.076
		99.754

Further southward, on the Zanks, on the Dniester, in Russian Podolia, and in the Bukowina, there are also deposits of phosphorite, which Schwachofer describes as very rich on the average. The composition of the nodular portions resembles that of apatite.

Coprolites.

True coprolites are not fossil excrements, as has been supposed, but worn and rounded fragments of fossil bones of a peculiar organization. They are found in the green sand and crag of the lower chalk formation and adjoining strata.

The false coprolites, as those of Suffolk, are a mixture of fossilized excrements, fish-bones, rolled stones, etc., forming beds in the more recent tertiary strata between the coralline crag and the London clay.

The coast of Suffolk and Cambridgeshire, England, are extensive localities for these phosphatic materials. They are also found abundantly in France and Germany, and to a small extent in Canada.

Owing to the fluoride of calcium which they contain, hydrofluoric acid is evolved during the process of superphosphating them, and waste as well as discomfort ensue consequently. The presence of a large amount of carbonate of lime involves, also; a waste of acid; to say nothing of the considerable proportion of alumina and oxide of iron, which not only are profligate constituents as regards

the consumption of the acid, but the means of rendering the "superphosphate" permanently damp. These circumstances, and the fact that their valueless constituents will dilute the product to an extreme degree, reduce the coprolites to an inferior rank as a raw material, for the manufacture of refined phosphate products. Nevertheless, they are employed extensively for the purpose in Great Britain,—perhaps on account of their regular abundance and low price. They do not make "superphosphate" of good quality by the usual processes; nor are they so profitable for the methods of this treatise as even the "South Carolina Phosphate"; and those inferior kinds of coprolites known as the "Wicken Coprolites" from Cambridgeshire and Bedfordshire; and "Calais Coprolites" from the Pas de Calais in France. Either of the two latter is to be obtained abundantly at a low price, and the following analyses will show their composition. The samples were obtained from a trustworthy source, and represent fairly the average character of the respective deposits. They may be considered as typical members of the class of low grades of mineral phosphates of lime.

WICKEN COPROLITES. (<i>Morfit.</i>)	COPROLITES FROM PAS DE CALAIS. (<i>Morfit and B. W. Gerland.</i>)
Moisture - - - 1·66	Moisture - - - 0·610
Loss by ignition - 2·97	Sand, pyrites, etc., in-
Silica, sand, & pyrites 24·46	soluble in HCl. - 33·340
Fluoride of calcium - 2·02	Silicic acid - - - 1·490
Sulphate of lime - 1·53	Fluoride calcium - 2·100
Carbonate of lime - 10·16	Sulphate of lime - 2·487
Lime (as silicate and	Carbonate of lime - 11·360
organate) - - - 6·40	Lime as silicate, etc. 7·360
Tri-phosphate of lime 35·66	Tri-phosphate lime 29·150
Oxide of iron - 7·56	Tri-phosphate mag-
Alumina - - - 4·07	nesia - - - - 2·552
Phosphoric acid 2·67	Oxides of iron, 2·111
	Alumina, 2·730
	Phospho. acid, 5·700
99·16	100·990

Rossa or Guaymas Guano.

This is a very superior rock guano from Rossa Island, 28·3 north latitude, and 110·46 west longitude, near Guaymas, in the Gulf of California. It contains a portion of its phosphate of lime in a di- or neutral state, and is almost wholly free from constituents which would waste acid. It is in hard lumps, but

can be reduced to fine powder without difficulty ; and in this latter form is well suited for mixing with highly ammoniacal manures.

For the purposes of this treatise, it may be considered almost a pure material, as the foreign matters are all excluded, by the action of the hydrochloric acid, in the very first stage of the refining processes.

The analysis in the table represents a sample which I examined several years ago ; but, though the deposit is large, none has yet been brought into this market.

Sombrero Guano.

This is a rock guano constituting the entire structure of one of the Windward Islands in the Carribean Sea, called Sombrero. It is most probably a bone breccia ; as pieces of bone are found occasionally in the mass. It is not very hard, and forms a light yellow brown powder.

I was the first to recognise the agricultural value of this mineral phosphate, and give it professional support when it was the object of great prejudice. The following analyses by Voelcker, of cargoes imported in 1871, show

that notwithstanding a greater dampness, owing to being mined now below the level of the sea, it reaches the market in quality as good as that of the earlier importations which are represented by my figures in the analytical table at pages 30, 31.

	1	2	3	4	5	6	7	8
Water and Organic matters	2'99	5'08	9'42	9'19	5'49	9'52	6'89	21'20
Phosphoric acid	32'32	30'84	30'98	30'84	32'86	30'48	31'16	27'82
Lime - - -	45'96	47'65	44'98	44'33	45'83	44'77	45'18	35'72
Magnesia, Ox. iron, Carbonic acid, etc.	11'21	15'48	13'53	14'59	14'57	14'14	15'45	14'56
Sand & Silica	7'52	'95	1'19	1'05	1'25	1'09	1.32	'70
	100'00	100'00	100'00	100'00	100'00	100'00	100'00	100'00

There is one portion of the island which gives a mineral of the following composition, according to analysis by Evans and Jones ; but none of it has yet been mined for market.

Moisture and water of combination	-	6'01
Silica	-	10'10
Carbonate of lime	-	4'43
Phosphate of lime	-	43'35
Phosphate of alumina	-	30'20
Alkaline salts	-	5'91

100'00

St. Martin's Phosphate.

This mineral is from the island of St. Martin's, but has not been sent forward in any large quantity. The following analysis by Voelcker shows the composition of what may be considered an inferior sample.

Water and loss on heating	-	8.66
Carbonic acid	-	11.57
Phosphoric acid	-	24.76
Lime	-	45.41
Alumina, ox. iron, and magnesia	-	6.37
Insoluble silicates	-	3.23
		100.00

South Carolina Phosphate.

This material comes from the neighbourhood of the Ashley river, South Carolina, United States of America. It is in the form of hard nodules called Marlstones. The fish beds from which it is obtained are forty to fifty miles in extent. It may be ground without difficulty, and forms a powder sometimes of an olive-grey shade, at others of a brownish-buff colour, and soluble in acids.

Of all the mineral phosphates of lime which

REVOLVING SIEVE — SIDE AND END ELEVATION.

FIG 1.

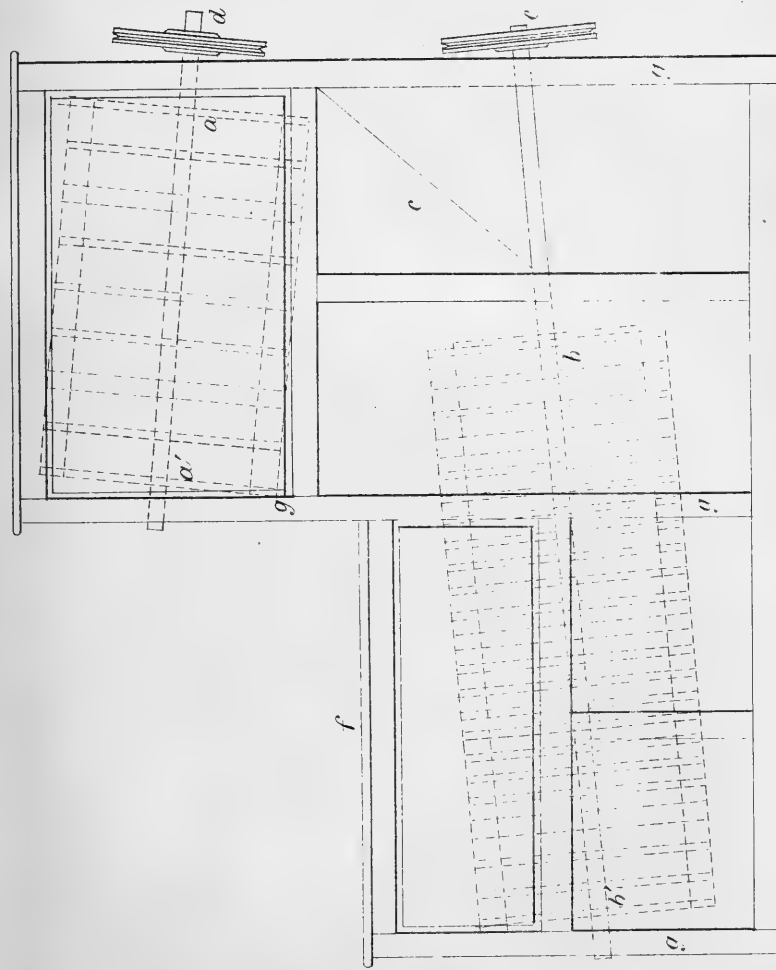
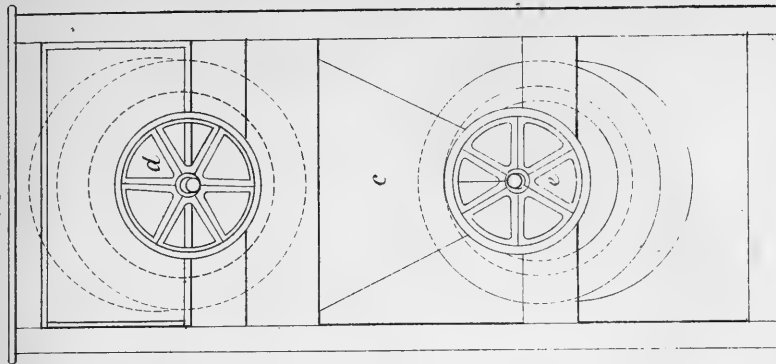

Plate 2.

FIG. 2.



SCALE — 1/2 TO A FOOT.



are available, *in abundant and regular supply*, these marlstones are among those best suited for the purpose of this treatise. Their ratio of carbonate and organate of lime is not unprofitably large where hydrochloric acid is cheap; and the solution of the iron and alumina constituents may be kept down in considerable degree by skilful manipulation. The remaining associates of the phosphate of lime constituent are merely valueless and not diluents or promoters of waste of acid. Their proportion of phosphate of lime, though only a moderate average, is thus really present in profitable degree. Another advantage is that the material may be bought at a comparatively lower price than minerals of the same class.

The composition of that kind of "South Carolina Phosphate" which gives a fawn-coloured powder, and as imported in 1870-1, is shown by the analytical table at pages 30, 31.

Another variety, whose powder is olive-greyish in colour, and now coming forward (1872) in greater or lesser quantity, has the following chemical constitution, according to

the full analysis of a sample from a recent cargo :—

“SOUTH CAROLINA PHOSPHATE.”

(Morfit and B. W. Gerland.)

Moisture -	-	-	-	1'11
Organic matter -	-	-	-	1'34
Insoluble, silica, sand, etc.	-	-	-	11'56
Pyrites -	-	-	-	1'24
Silica, dissolved by HCl.	-	-	-	·86
Fluoride calcium -	-	-	-	2'62
Sulphate lime -	-	-	-	4'11
Carbonate lime -	-	-	-	14'02
Lime, as organate, silicate, aluminat	-	-	-	9'11
Tri-phosphate lime	-	-	-	42'13
Tri-phosphate magnesia	-	-	-	4'43
Oxide iron	-	-	1'83	} 8'39
Alumina -	-	-	2'07	
Phosphoric acid	-	-	4'49	
				100'92

A third variety of this phosphate is now being brought forward also, from Williman's Island, Prince William's parish, Beaufort County, S.C., formed by inlets on the eastern coast, about fifteen miles from the Atlantic Ocean. It comprises nearly 1600 acres, with a bed of phosphate running throughout,

which latter has been calculated to yield 10,000,000 tons.

Dr. A. Vöelcker, who examined this phosphate, has reported that a careful and detailed analysis of the finely ground sample (unwashed) taken from the bulk at the Stores yielded the following results :—

Moisture	-	-	-	-	1'91
*Organic matter and water of combination					4'05
Phosphoric acid	-	-	-	-	26'23
Magnesia	-	-	-	-	'24
Lime	-	-	-	-	39'78
Potash	-	-	-	-	'20
Soda	-	-	-	-	'63
Chloride of sodium	-	-	-	-	'05
Sulphuric acid	-	-	-	-	2'50
Oxide of iron	-	-	-	-	1'85
Alumina and a little fluorine	-	-	-	-	4'64
Insoluble silicious matter & soluble silica					15'31
Carbonic acid	-	-	-	-	2'60
					100'00
*Containing nitrogen	-	-	-	-	'09
Equal to ammonia	-	-	-	-	'11

“The presence of traces of nitrogenous organic matter in this material appears to indicate its organic origin.”

“Williman’s Island Guano resembles nearest in character the Cambridgeshire Coprolites.”

French Phosphate.

This is most probably a species of bone breccia, for, though of rocky character, fossil bones are found with it in some of the openings.

It extends over a wide area of the departments of the Lot and Garonne, the Lot and the Aveyron in France, where it is found in detached veins and small pockets underlying the grey limestone on the highest plateaux of the mountains between the rivers Lot and Aveyron.

The solid veins run generally from eastward to westward; and the loose boulders are found embedded in a ferruginous looking clay and sand. It gives a light fawn coloured powder.

The following analyses by Voelcker of several of the cargoes of 1871 show that it is a very high quality of mineral phosphate.

Components.	"Topaz."	"Denia."	"Maria."	"Rifle."	"ArmandMarianne."	"Philomene."	"Hanton."
Water and loss } by heating }	3'45	3'15	4'10	4'29	6'03	4'94	2'23
Phosphoric acid	36'07	36'64	33'05	34'89	33'80	34'90	37'60
Lime -	48'43	48'65	48'46	47'09	48'25	49'62	46'52
Alumina and oxide of iron, magnesia, carbonic acid, etc. }	9'56	9'04	12'40	11'02	9'24	8'89	13'04
Insoluble sili- cious matter }	2'49	2'52	1'99	2'71	2'68	1'65	'61
	100'00	100'00	100'00	100'00	100'00	100'00	100'00

Navasa Guano or Cooperite.

The island which furnishes this mineral is on the coast of Hayti, in latitude 78 deg. 25 min. N., and longitude 75 deg. 2 min. W. As sent into the market by the proprietors, it is in brown lumps which give a powder like that of hematite. The very large proportion of iron and aluminium compounds, which it contains, distinguishes it from all other mineral phosphates of lime; and owing to this and other characteristic features I gave it, some years ago, the name of Cooperite, after the enterprising Captain of the Commercial Marine who first brought it into notice.

My analysis in the table at pages 30, 31 represents its composition at that time; and it is uncertain whether the quality has since improved.

Those cargoes which arrive now are very variable in their degree of moisture; and there is also a want of uniformity in the quantitative relation of the phosphoric acid constituent.

The annexed analyses represent the composition of a superior and an inferior sample; so that the mean of the two may be accepted as the present average quality of the mineral.

In my recent refining experiments on a large scale, I obtained from it about fifty-five per cent. of precipitated phosphate of lime independent of the iron and alumina with which it was associated. The difficulty of preventing the solution of a large portion of the oxide iron and alumina along with the phosphate lime is the only objection to this raw material for superphosphating purposes, as it is cheap and in abundant supply. At the same time, the *precipitated* product which I obtained from it by my processes was of good quality and gave a "superphosphate"

much superior in every respect to that which any *raw* phosphate material, except bone-ash, could be made to yield.

 NAVASA GUANO OR COOPERITE.

(Morfit and B. W. Gerland.)

	1	2
Moisture - - -	3'94	3'13
Organic matter and loss by ignition	5'07	5'32
Sand, silica, etc. - -	4'43	4'37
Fluoride calcium - -	1'27	1'40
Sulphate lime - -	1'09	1'21
Lime, as organate, silicate, aluminate	4'80	11'12
Carbonate lime - -	4'63	6'52
Tri-phosphate lime - -	} 55'62	{ 45'52
Tri-phosphate magnesia - -		{ 1'83
Oxide iron - - -	} 19'86	- 22'24
Alumina - - -		
Phosphoric acid - - -		
	-----	-----
	100'71	99'86

Orchila Guano.

This material is best known in the United States market. It is brought from Orchila, an island in the Carribean Sea, lat. 11 deg. 50 min. N., and long. 66 deg. 14 min. W., and belonging to Venezuela. Its natural form is that of a rather damp, fawn-coloured

powder. Its loose texture is advantageous for its direct application to the soil; but the pro-

NOTE.—Charles P. Williams (*Chemical News*, xxiv, 306; and *Journal of the Chemical Society*, x, 269, 1872) has reported some very interesting results of a course of experiments upon the comparative solubility of several crude phosphates of lime. Care was observed to separate the dissolved phosphate of lime from any foreign associates in the liquor, so that its amount might be determined exactly. Molybdate of ammonia was the re-agent employed. According to that Chemist:—

- One part of finely ground bone, containing 56.78 per cent. of tri-phosphate of lime, dissolved in 5.698 parts of water saturated with carbonic acid gas.
- One part of finely ground South Carolina Phosphate, containing 57.89 per cent. of tri-phosphate of lime, dissolved in 6.983 parts of water saturated with carbonic acid gas.
- One part of finely ground Orchila Guano, containing 49.67 per cent. of tri-phosphate of lime, dissolved in 8.009 parts of water saturated with carbonic acid gas.
- One part of finely ground Bone-Ash, containing — per cent. of tri-phosphate of lime, dissolved in 8.029 parts of water saturated with carbonic acid gas.
- One part of levigated Apatite from Canada, containing 89.27 per cent. of tri-phosphate of lime, dissolved in 140.840 parts of water saturated with carbonic acid gas.
- One part of ground Apatite from Canada, containing 89.27 per cent. of tri-phosphate of lime, dissolved in 222.222 parts of water saturated with carbonic acid gas.

portion of phosphate of lime which it contains renders its money value comparatively small. As this latter is associated with a very large amount of carbonate lime and other profligate components, the guano is not well suited for refining purposes. The analytical figures in the annexed table represent a sample which I obtained direct from the proprietor's agent.

The foregoing examples may be considered the commercial representatives of their class of materials; for, with few exceptions, they are all now in the market. It is only the comparative expense of mining and transportation that makes any exceptional instances, and even those will disappear as soon as the contingencies of supply and demand may justify the bringing forward of present reserves.

It is to be hoped, however, that in the meantime new and even cheaper sources, in rich abundance, may be found and developed; for, as phosphate of lime is the basis of crops, and bountiful harvests cheapen bread, which forms the staff of life, such incidents would grow as well a humanitarian influence in the grandest and most practical sense.

Analytical Table of the Comparative Crude Phosphates

Components.	Rossa Gu- ano from the Gulf of California. (Morfit.)	Apatite from Canada. (T.S.Hunt.)	Apatite from Norway. (Voelcker.)	Phospho- rite from Spain. (Ogston.)	Phospho- rite from Germany. (Frese- nius.)
Bone or tri-phosphate } lime and magnesia }	53·08	91·20	90·74	80·68	74·64
Neutral or diphosphate } lime - - - }	18·03	—	—	—	—
Carbonate lime - -	—	—	—	4·26	3·43
Lime, with organic } acids, silica, and } alumina - - - }	—	—	4·59	1·83	1·34
Fluoride calcium -	—	7·60	—	·11	5·26
Chloride calcium -	—	·78	1·61	—	—
Phosphate alumina -	—	—	} 1·66	—	—
Phosphate iron - -	—	—		—	—
Oxide aluminium -	0·25	—	traces	} ·50	1·08
Oxide iron - - -	0·15	—	—		6·42
Sulphate lime - -	8·10	—	—	—	—
Potassa salts - -	} ·30	—	—	—	0·58
Soda salts - - -		—	—	—	0·52
Organic matters -	9·80	—	—	—	—
Water, constitutional -	} 3·62	—	—	—	—
Water, accidental -		—	—	0·43	·20
Carbon - - - -	—	—	—	—	—
Sand and silica - -	6·20	0·90	1·64	12·34	4·83
	99·53	100·48	100·67	99·92	100·55

Composition of the Natural,
of Lime.

Bone-Ash from South America. (Morfit.)	Bone-Black from Sugar Refineries. (Morfit.)	Sombrero Guano. (Morfit.)	True Coprolites, Cambridge. (Way.)	False Coprolites, Suffolk. (Herepath.)	Marlstones or South Carolina Phosphate. (Morfit.)	Cooperite or Navasa Guano. (Morfit.)	Orchila Guano. (Morfit.)
70'31	58'10	67'06	57'09	55'49	52'21	46'80	45'84
—	—	—	—	—	—	—	—
10'82	8'80	5'34	13'27	13'40	} 14'32	1'92	19'61
'79	—	6'97	3'41	—		10'37	2'74
—	—	—	4'33	1'43	—	—	—
—	—	—	—	1'66	—	—	—
—	—	3'62	5'57	5'12	} 8'89	6'78	} 11'36
—	—	1'95	1'78	1'61		3'20	
} '60	—	3'13	2'14	'80		11'62	
	—	1'10	traces	traces		3'70	
—	—	'86	'80	'70	—	1'02	—
} '20	} '80	} '49	'61	'65	—	—	—
			—	—	—	traces	—
} 8'42	} 8'60	5'36	} 4'05	} 6'26	8'00	6'02	6'93
		3'52			—	—	3'05
		19'50	—	—	—	—	—
9'20	4'00	'68	6'93	12'45	13'96	4'50	1'24
100'34	99'80	100'08	99'98	99'57	100'43	100'67	100'26

Sulphuric Acid. $\text{SO}_3 \cdot \text{HO} = 49$.

The composition of this acid in its pure state is as follows :—

Dry sulphuric acid (SO_3)	-	40'00, or per cent.	81'63
Water of constitution (HO)		9'00	18'37
		49'00	100'00
Chemical equivalent	-	49'00	100'00

The range and strength of affinities which pertain to this acid render it the most important and useful chemical agent in the arts. There are very few salts of other acids which it will not decompose. Moreover, it is cheap and abundant.

Sulphuric acid is met with in commerce of two strengths, the first being known as *Oil of Vitriol* having a specific gravity of 1'846, and the second, called *Brown Oil of Vitriol*, with a specific gravity of 1'700. This latter is the acid as it comes from the leaden chambers in which it is made. By subsequent concentration in platinum or glass vessels it becomes Oil of Vitriol or Monohydrated Sulphuric Acid ($\text{SO}_3 \cdot \text{HO}$).

The brown or chamber acid has the formula $\text{SO}_3 \cdot \text{HO} + \text{HO}$ approximately. There are yet

weaker acids known in the factories but not met with in commerce and having respectively the specific gravity 1.450, 1.350, 1.250.

Oil of vitriol is a transparent, colourless liquid of oily consistence which freezes at 29 deg. below 0 deg. F., and boils at 620 deg. F. It distils then without being decomposed, the fumes given off being those of dry sulphuric acid (SO_3).

Sulphuric acid has a great affinity for water, and when one is added to the other so much heat is evolved that great care must be observed in mixing them.

The dry acid (SO_3) is not known in commerce, and both the oil of vitriol and brown acid are solutions of dry acid in water, of different strengths. The latter is much more economical than the former for manufacturing purposes, as all the expense of concentration is saved, strong acid not being required. There are thirteen carboys to the ton.

In the manufacture of fertilizers, the consumption of sulphuric acid is so great that the cost of the carboys which contain it and the expense of transporting them are important elements of consideration. It is advis-

able, therefore, to manufacture the acid on the spot or else to locate the manure works in the immediate neighbourhood of a sulphuric acid factory.

As differences of strength are due to degree of concentration, the weaker the acid the less expensive will be its use.

One pound of oil of vitriol of specific gravity 1·846 is *practically* equivalent to :—

1·26	lbs. of brown sulphuric acid of sp. gravity,	1·700
1·76	„ chamber „ „	1·450
2·20	„ „ „ „	1·350
2·91	„ „ „ „	1·250

Every per cent. or pound of tri- or bone-phosphate of lime requires practically for its decomposition into soluble bi-phosphate of lime :—

0·64	lbs. of concentrated oil of vitriol of sp. gr.,	1·846
0·82	„ brown „ „	1·700
1·14	„ chamber sulphuric acid „	1·450
1·42	„ „ „ „	1·350
1·87	„ „ „ „	1·250

For the decomposition of each per cent. or pound of carbonate and organate of lime, there would be wasted . . .

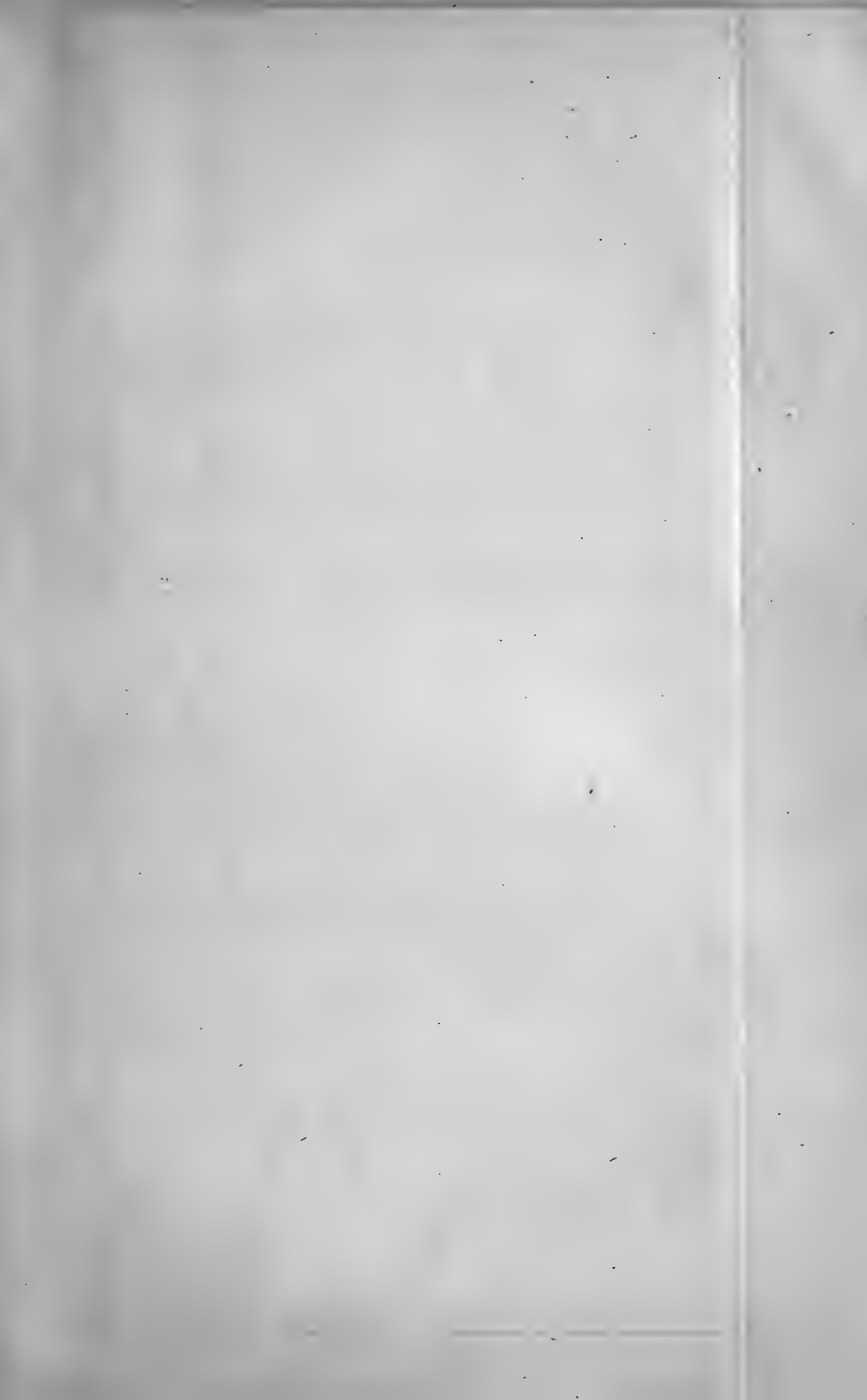

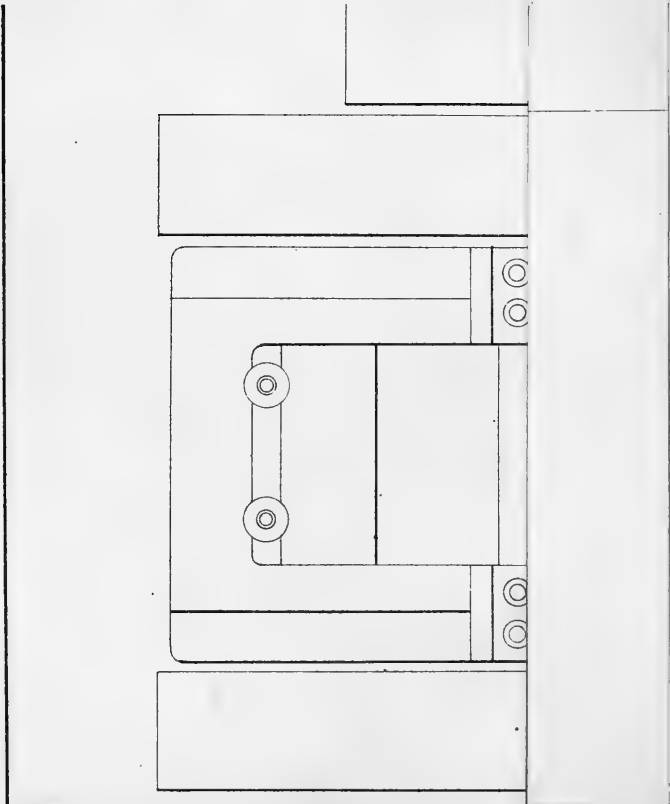

Specially designed for D. Morfits Work on Fertilizers.

Gen. Lath

0'98 lbs. of concentrated oil of vitriol of sp. gr., 1'846
 1'26 " brown " " 1'700
 1'76 " chamber sulphuric acid " 1'450
 2'20 " " " " 1'350
 2'91 " " " " 1'250

Ure's Table of the Quantity of Concentrated (SO HO) and Dry Sulphuric Acid (SO) in 100 parts of Dilute Acid at different densities.

Specific Gravity.	Liquid Acid in 100.	Dry Acid in 100.	Specific Gravity.	Liquid Acid in 100.	Dry Acid in 100.	Specific Gravity.	Liquid Acid in 100.	Dry Acid in 100.
1'8460	100	81'54	1'5503	66	53'82	1'2334	32	26'09
1'8438	99	80'72	1'5390	65	53'00	1'2260	31	25'28
1'8415	98	79'90	1'5280	64	52'18	1'2184	30	24'46
1'8391	97	79'09	1'5170	63	51'37	1'2108	29	23'65
1'8366	96	78'28	1'5066	62	50'55	1'2032	28	22'83
1'8340	95	77'46	1'4960	61	49'74	1'1956	27	22'01
1'8288	94	76'45	1'4860	60	48'92	1'1876	26	21'20
1'8235	93	75'83	1'4760	59	48'11	1'1792	25	20'38
1'8181	92	75'02	1'4660	58	47'29	1'1706	24	19'57
1'8026	91	74'20	1'4560	57	46'48	1'1626	23	18'75
1'8070	90	73'39	1'4460	56	45'66	1'1549	22	17'94
1'7986	89	72'57	1'4360	55	44'85	1'1480	21	17'12
1'7901	88	71'75	1'4265	54	44'03	1'1410	20	16'31
1'7815	87	70'94	1'4170	53	43'22	1'1330	19	15'49
1'7728	86	70'12	1'4073	52	42'40	1'1246	18	14'68
1'7640	85	69'31	1'3977	51	41'58	1'1165	17	13'86
1'7540	84	68'49	1'3884	50	40'77	1'1090	16	13'05
1'7525	83	67'68	1'3788	49	39'96	1'1019	15	12'23
1'7315	82	66'86	1'3697	48	39'14	1'0951	14	11'41
1'7200	81	66'05	1'3612	47	38'32	1'0887	13	10'60
1'7080	80	65'23	1'3530	46	37'51	1'0809	12	9'78
1'6972	79	64'42	1'3440	45	36'69	1'0743	11	8'97
1'6860	78	63'60	1'3345	44	35'88	1'0682	10	8'15
1'6744	77	62'78	1'3255	43	35'06	1'0614	9	7'34
1'6624	76	61'97	1'3165	42	34'25	1'0544	8	6'52
1'6500	75	61'15	1'3080	41	33'43	1'0477	7	5'71
1'6415	74	60'34	1'2999	40	32'61	1'0405	6	4'89
1'6321	73	59'52	1'2913	39	31'80	1'0336	5	4'08
1'6204	72	58'71	1'2826	38	30'98	1'0268	4	3'26
1'6090	71	57'89	1'2740	37	30'17	1'0206	3	2'44
1'5975	70	57'08	1'2654	36	29'35	1'0140	2	1'63
1'5868	69	56'26	1'2572	35	28'54	1'0074	1	0'81
1'5760	68	55'45	1'2490	34	27'72			
1'5648	67	54'63	1'2409	33	26'91			

BLAKE'S CRUSHER - FRONT ELEVATION & PLAN.

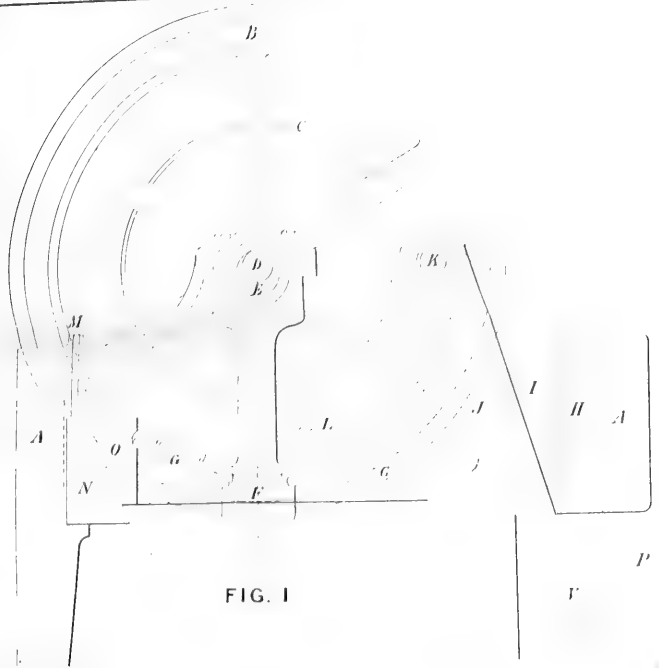

FIG. 1

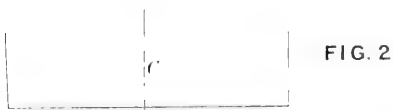
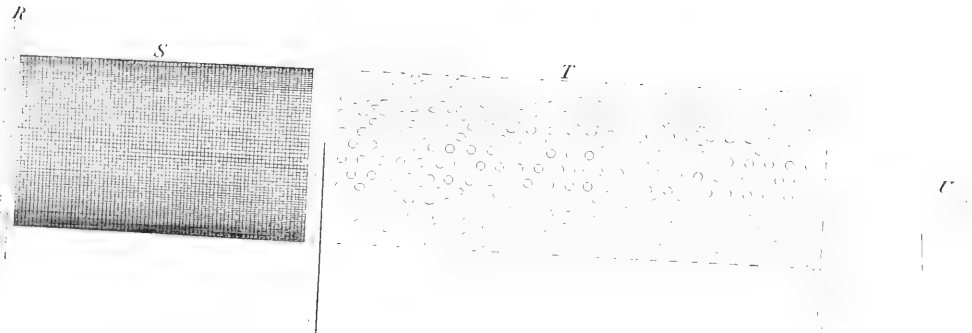
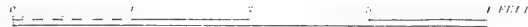

FIG. 2

FIG. 3



SCALE



Hydrochloric Acid. $\text{HCl} = 36.5$.

In a pure gaseous state, it has the following composition :—

Chlorine (Cl)	-	-	35.5, or per cent.	-	97.26
Hydrogen (H)	-	-	1.0	„	2.74
			36.5		100.00
Chemical equivalent	-	36.5	„	-	100.00

Hydrochloric acid is rarely found free except in certain mineral waters and volcanic exhalations. It is diffused, however, in nature to a wide extent, as chloride of sodium and other chlorides or hydrochlorates.

Commercial hydrochloric acid is a solution of dry acid in water, and as made, direct, from chloride of sodium, it has the specific gravity 1.170 to 1.247. That which is found in commerce, however, rarely has a greater strength than specific gravity 1.170. This latter is, in Great Britain and France, a by-product of the soda manufacture obtained by condensing the vapours, from the decomposing furnaces, in Gossage's coke towers; and may be bought there to any extent at 12 to 15 shillings per ton.

A factory for fertilizers should form a part of every soda-works, in order that the large incidental product of hydrochloric acid may be utilized advantageously on the spot.

Chemically considered, one equivalent of dry or gaseous hydrochloric acid ($\text{HCl} = 36.5$) is equivalent to one equivalent of dry sulphuric acid ($\text{SO}_3 = 40$). Therefore, as the commercial hydrochloric acid of specific gravity 1.170 contains 34.25 per cent. of gaseous acid (HCl), one pound of it is equivalent to 0.46 pounds of concentrated oil of vitriol of specific gravity 1.846 or 0.58 pounds of brown oil of vitriol of specific gravity 1.700.

For the same reason, every 1.0 carbonate of lime would require for its decomposition 2.13 of hydrochloric acid (1.170) and form 1.11 of dry chloride calcium (CaCl).

So also, every 1.0 of tri-phosphate lime needs for its solution 1.37 of this hydrochloric acid; and there is produced 0.71 of dry chloride calcium (CaCl).

As hydrochloric acid, whether weak or strong, always gives off fumes, at even ordinary temperatures, it is necessary to be careful in manipulating with it. The reser-

voir which is to hold it and the pipes which are to convey it must be closed, consequently, and lined with stearic pitch, gutta-percha, or caoutchouc.

Ure's Table showing the per cent. of Gaseous or Dry Acids in Hydrochloric Acid of different densities at 62° F.

Specific Gravity.	Gaseous Acid (HCl).	Specific Gravity.	Gaseous Acid (HCl).	Specific Gravity.	Gaseous Acid (HCl).	Specific Gravity.	Gaseous Acid (HCl)
1·2000	40·777	1·1575	30·582	1·1000	20·388	1·0497	10·194
1·1982	40·369	1·1494	30·174	1·0980	19·980	1·0477	9·786
1·1964	39·961	1·1473	29·767	1·0960	19·572	1·0457	9·379
1·1946	39·554	1·1452	29·359	1·0939	19·165	1·0437	8·971
1·1928	39·146	1·1431	28·951	1·0919	18·757	1·0417	8·563
1·1910	38·738	1·1410	28·544	1·0899	18·349	1·0397	8·155
1·1893	38·330	1·1389	28·136	1·0879	17·941	1·0377	7·747
1·1875	37·923	1·1369	27·728	1·0859	17·534	1·0357	7·340
1·1857	37·516	1·1349	27·321	1·0838	17·126	1·0337	6·932
1·1846	37·108	1·1328	26·913	1·0813	16·718	1·0318	6·524
1·1822	36·700	1·1308	26·505	1·0798	16·310	1·0298	6·116
1·1802	36·292	1·1287	26·098	1·0778	15·902	1·0279	5·709
1·1782	35·884	1·1267	25·690	1·0758	15·494	1·0259	5·301
1·1762	35·476	1·1247	25·282	1·0738	15·087	1·0239	4·895
1·1741	35·068	1·1226	24·874	1·0718	14·679	1·0220	4·486
1·1721	34·660	1·1206	24·466	1·0697	14·271	1·0210	4·078
1·1701	34·252	1·1185	24·058	1·0677	13·863	1·0180	3·670
1·1681	33·845	1·1164	23·650	1·0657	13·456	1·0160	3·262
1·1661	33·437	1·1143	23·242	1·0637	13·049	1·0140	2·854
1·1641	33·029	1·1123	22·834	1·0617	12·641	1·0120	2·447
1·1620	32·621	1·1102	22·426	1·0597	12·233	1·0100	2·039
1·1599	32·213	1·1082	22·019	1·0577	11·825	1·0080	1·631
1·1578	31·805	1·1061	21·611	1·0557	11·418	1·0060	1·224
1·1557	31·398	1·1041	21·203	1·0537	11·010	1·0040	0·816
1·1537	30·990	1·1020	20·796	1·0517	10·602	1·0020	0·408

Crude Ammonia Liquor.

The most common form of this material is "*gas liquor*", one of the products incident to the destructive distillation of bituminous coal in the manufacture of illuminating gas. It is formed also, and largely, as a secondary product, in the manufacture of animal charcoal from bones, and in the destructive distillation of bituminous schists, refuse oil-cake, woollen waste, leather clippings, and nitrogenous, organic matters generally.

Theoretically, every 14 per cent. of nitrogen in the raw material should give 17 per cent. of ammonia; but, owing to various difficulties and complexities in the mechanical, as well as chemical, circumstances of the practical conversion, the actual results do not approach this estimate.

When the raw material contains sulphur, as in the case of coal, then the liquor distilled from it will hold the ammonia, principally as carbonate, but associated with sulphide, sulphate, chloride, and ferrocyanide. As obtained from other sources, it is almost wholly a solution of carbonate of ammonia.

The coal-gas liquor, which is in fact a solution of crude ammonium salts, comes over with tar, and is condensed in the hydraulic main; but the tar forms a separate stratum, and the two may be separated readily by decantation or drawing off from the containing cistern or well. The volume of tar is greater, generally, by 20 per cent. than that of the ammonia liquor.

In the manufacture of gas from coal, as much as 60 per cent. of the ammonia, it is said, remains with the gas; but, according to Wright, one ton of good Newcastle coal will yield, nevertheless, ten gallons of liquor weighing 100 pounds. Pockston names 11 to 13 imperial gallons as the usual product from a ton of good coal.

Clegg states that the amount of ammoniacal product varies with the temperature at which the destructive distillation of the coal is effected. Very high heat diminishes the product by converting a portion of the ammonia into cyanogen. Nevertheless, the usual amount of liquor obtained from one ton of Newcastle coal is ten imperial gallons, equivalent to $3\text{-}3\frac{1}{4}$ ounces of dry caustic am-

monia, or a total of 30 to $32\frac{1}{2}$ ounces. In addition, the gas retains so much more as to raise the actual yield of dry ammonia gas from one ton of Newcastle coal to six pounds avoirdupois. The liquor from boghead and cannel coals yields less ammonia, generally, than that from the bituminous coals.

Berger Spence and Peter Dunn (chapter xix) propose to abstract all the ammonia retained in the gas by passing it through the crude phosphoric acid liquor obtained in the chemical treatment of mineral phosphates of alumina (chapter xix). The gas would be thus purified by the formation, simultaneously, of phosphate ammonia—a very valuable product.

To make caustic ammonia from gas-liquor, it is only necessary to add lime (with some chloride of iron) to the latter in the proportion of five per cent. of its weight, and then to distil. The gaseous distillate passing over is to be received in water, which at 50° F. condenses 670 to 780 times its volume of ammoniacal gas.

The strength of crude ammoniacal liquor varies with its source. It is sold usually by

the ton at one shilling for every degree it may show by Twaddel's hydrometer, and each degree of this instrument represents 0.47 dry ammonia gas.

Owing to the liquor being a mixture of several different ammonium salts, this mode of estimating the strength is very rough. A better, but yet only approximately correct method, would be to take a weighed measure of the liquor, neutralize it with pure hydrochloric acid, evaporate it to dryness, and weigh the residue. In this manner I obtained two and three quarter ounces of solid chloride of ammonium from 16 fluid ounces of the liquor of a private gas-works. Assays of liquor from other works showed, in like manner, an average of nine per cent. of chloride, or, say three per cent. of dry caustic ammonia.

According to Knapp, one imperial gallon, or, say ten pounds, of gas-liquor yield, by distillation to hydrochloric acid, 31 to 39 ounces of solid chloride of ammonium, equivalent to an average of 17.50 per cent.

Barreswill, an eminent French chemist, states that 2000 litres of gas-liquor give 100

kilogrammes of sulphate of ammonia, or in the proportion of 5 per cent. of the weight, which is equal to $1\frac{1}{4}$ per cent. of dry caustic ammonia.

English manufacturers of fertilizers report to me that 1000 gallons of gas-liquor, weighing, say, 10'000 pounds, produce an average of ten hundredweight of sulphate of ammonia; that is, about 10 per cent., equivalent to 2.50 per cent. of dry caustic ammonia.

The average strength of English gas-liquor, therefore, to be deduced from these data, is, in round numbers, 3 per cent. of dry caustic ammonia, or sixty pounds and upwards per ton.

Some idea of the extent to which this liquor is produced may be obtained by considering the fact that the amount of coal consumed for gas in London alone, is nearly one and a half millions of tons yearly. And, as every city, town, hamlet, railway station, factory, and large farm establishment, will, sooner or later, have its gas-works, this source of ammonia-supply will become even richer than at present.

In addition, however, to gas-liquor, there

are other abundant sources of ammonia, and notably the manufacture of bone-black from bones, in which it also distils over as a crude liquor.

According to Kamrodt, the nitrogen is as follows, in the various waste products of commerce:—

Horn	-	-	-	15 to 17 per cent.
Feathers	-	-	-	17 „
Bristles	-	-	-	9 to 10 „
Hide cuttings	-	-	-	4.5 to 5 „
Old shoes	-	-	-	6 to 7 „
Good woollen rags	-	-	-	13 to 16 „
Inferior woollen rags	-	-	-	10 to 12 „
Ox, cow, and calves' hair	-	-	-	15 to 17 „
Dried ox blood	-	-	-	15 to 17 „
Sheep's wool	-	-	-	16 to 17 „
Shoddy	-	-	-	7 to 9 „

Wool.

The destructive distillation of wool is another source of ammonia. Wool, when fresh, contains, according to Scherer, 13 to 16 per cent. of water. On exposure to air, 6 to 7 per cent. of this water passes away by evaporation; and the wool, thus dried, yields by calcination, 3.23 of ash. The ultimate composition of wool is—

Carbon	-	-	-	50·65
Hydrogen	-	-	-	7·03
Nitrogen	-	-	-	17·71
Oxygen, sulphur, etc.	-	-	-	24·61
				100·00

The following table of the present supply and market values of the several kinds of woollen waste in England, is made from data furnished to me by Mr. W. G. Etchells, Huddersfield :—

Kind of Woollen Waste.	Present Market Price in England per ton.	Probable amount of Supply annually in Great Britain.
	£ s. d.	
1. Willy dust - - -	0 10 0	10,000 tons
2. " - - -	0 10 0	—
3. " - - -	0 10 0	—
4. Cutters' flocks - - -	7 0 0	1,000 tons
5. Shoddy - - 18s. to	1 0 0	10,000 "
6. New woollen rags or cuttings - - - }	10 and } upwards }	Any quantity
7. Old woollen rags or cuttings - - - }	4 and } upwards }	

Leather Clippings.

The almost unlimited supply of this waste material, which abounds everywhere, and

may be collected at a nominal cost, renders it a very suitable basis for an ammonia process by destructive distillation. The quantity of nitrogen which it contains is always large, but varies more or less with the kind of leather waste.

Dried Blood.

In the extensive slaughter-houses of the United States of America, as well as in the *abattoirs* of France, the blood of the animals which are killed for food is either dried or solidified by coagulation, and thus economised for market. Its condensed form and richness in nitrogen render it a most valuable nitrogenous material for fertilizing purposes or the production of ammoniacal salts.

Dried Flesh.

In countries where cattle, sheep, and hogs abound and are killed for their hides and tallow and the flesh is boiled for extract of meat, there is a fibrinous residue which, when dried, becomes a most advantageous nitrogenous material for all the purposes of this treatise. The supply of it is very large.

Human Excrements.

This source alone, if properly utilized, would supply the larger part of all the ammonia salts that are required by mankind. The dejecta of each person amount per day to $4\frac{1}{4}$ lbs.; and these dejecta, comprising 3 lbs. of urine and 20 oz. of solid fæces, contain the average of 150 grains of nitrogen, which is equivalent, in that element, to 6000 grains or nearly a pound of wheat flour. Two hundred pounds of wheat flour are considered a liberal annual apportionment to each person.

All this wealth of fertilizing matter might be economised by such a municipal regulation as would compel the inhabitants of towns or cities to construct their privies with box-receptacles and a automatic, hopper arrangement, by which the dejecta would become mixed with dry earth as they fell. The deodorizing and absorbent properties of the dry earth would render the mixture easy to be handled and removed for further drying in heated air-currents. Thus prepared and powdered, it would then be ready for combustion with

soda lime, according to the methods suggested at p. 53.

In this manner, all the contained nitrogen would be eliminated as ammonia distillate, to be condensed into ammoniacal salt by means of sulphuric, hydrochloric, or crude phosphoric acid.

The solid residuum or calx would consist of sand, soda, and carbonate of lime, together with phosphate of lime or phosphate of soda. If the latter is present, it will have been formed from the phosphate of lime element of the fæces, by interaction with the soda under the fluxing influence of the high heat employed for the combustion. Indeed, the chemical and mechanical conditions of the combustion might be arranged so as to insure the total conversion of the phosphate of lime into phosphate of soda. The solid residue would then yield this latter as an aqueous solution by simple leeching with water. The phosphate of soda thus isolated, is a most valuable liquor for economising the WASH or MOTHER LIQUOR in chapter xi. By merely mixing the two, an exchange of bases would take place, and pure phosphate of lime would

precipitate, leaving chloride of sodium or common salt in solution.

On the other hand, if the combustion should be managed so as to preserve intact the phosphate of lime element, then the soda may be washed out by means of water and evaporated to dryness for repeated use an indefinite number of times.

The remainder of the solid residuum is in itself a valuable mineral manure, or it may be dried, powdered, and substituted advantageously, for earth, as the drying and deodorizing material to be used in the privies.

Sewage.

Several of the processes now in use for the defecation of town sewage render the latter a valuable source of ammonia. The precipitate thus produced carries down the suspended organic matter of the sewage; and this latter may be then isolated by merely dissolving the earthy portion of the precipitate in hydrochloric or sulphuric acid. The organic matter, on being dried carefully, is a most potential form of nitrogen, for direct use as a fertilizing agent, as it contains the equivalent of about 7 per

cent. of ammonia, associated with valuable humus matters. It forms, also, a most concentrated material for combustion with soda-lime, to produce ammonia salts by Morris and Penny's process, described at p. 53; provided always that it is wholly or nearly free from sand and silica.

At the same time, the decanted liquor being a hydrochloric or sulphuric solution of the defecating elements of the original material, is ready for purifying a fresh portion of sewage, as in the first instance; and thus it may be made to serve for an indefinite number of repetitions of the process. The establishment, in this manner, of an independence of any possible failure in the supply of the *Alta Vela*, *Redonda*, or other of the mineral phosphate materials employed in the purification of sewage, is an important consideration, and invests the process with a capacity for eminent utility and economy.

The ammoniacal salts are such necessary aids to profitable agriculture, that every means should be promoted to increase the supply of them. As a stimulus to enterprise in this direction, I have exposed the fore-

FIG. 2

Plate 4.

C

I

F

a

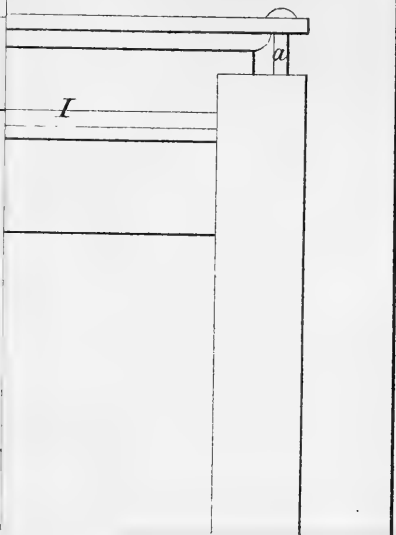

FIG. 1

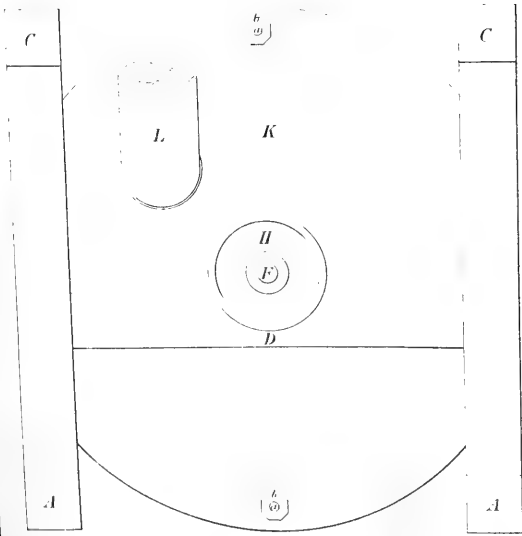

FIG. 2

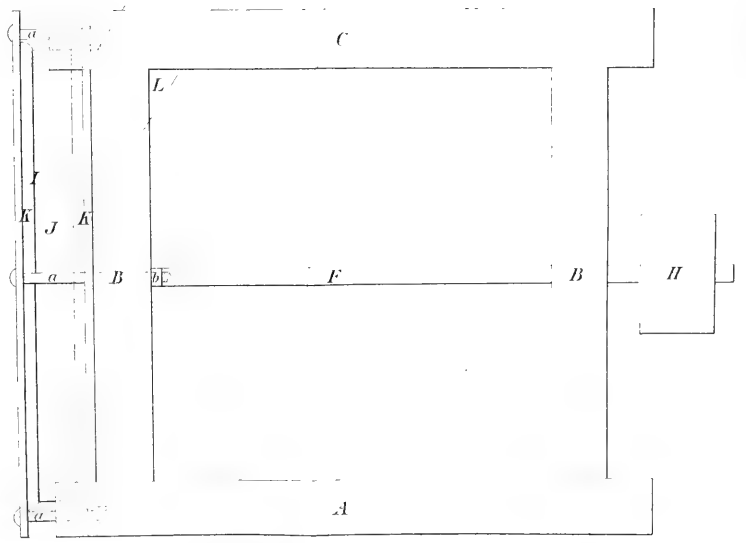

FIG. 3

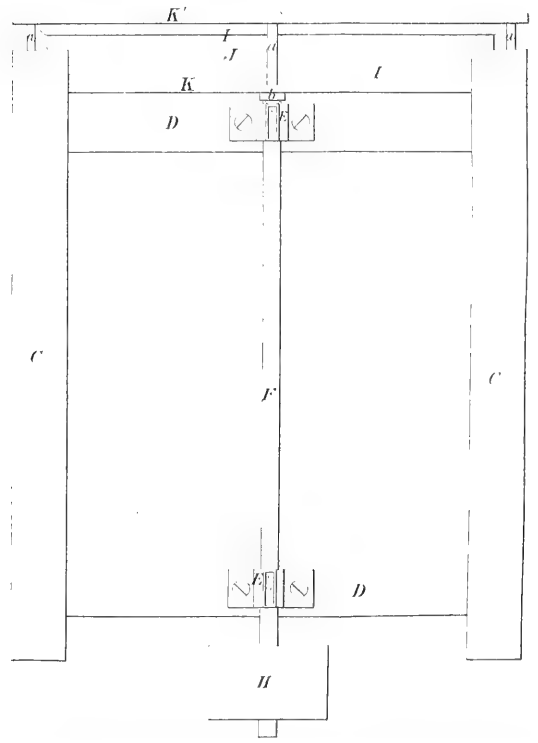

FIG. 4

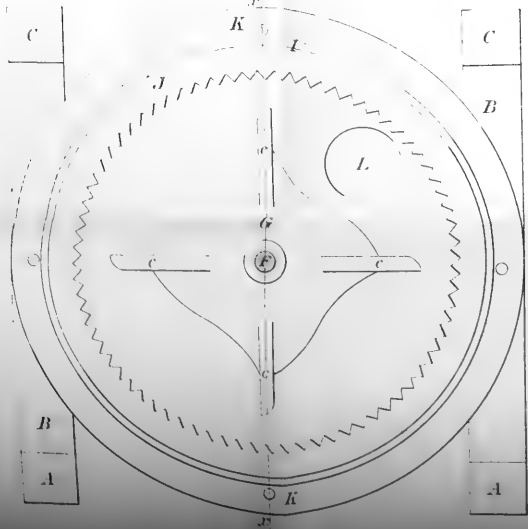

FIG. 7

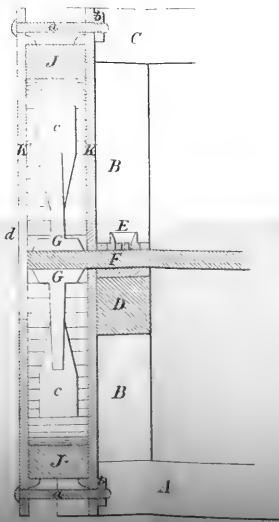

FIG. 5



FIG. 6



SCALE OF FEET



CENTRIFUGAL MILL - GENERAL VIEW & DETAILS

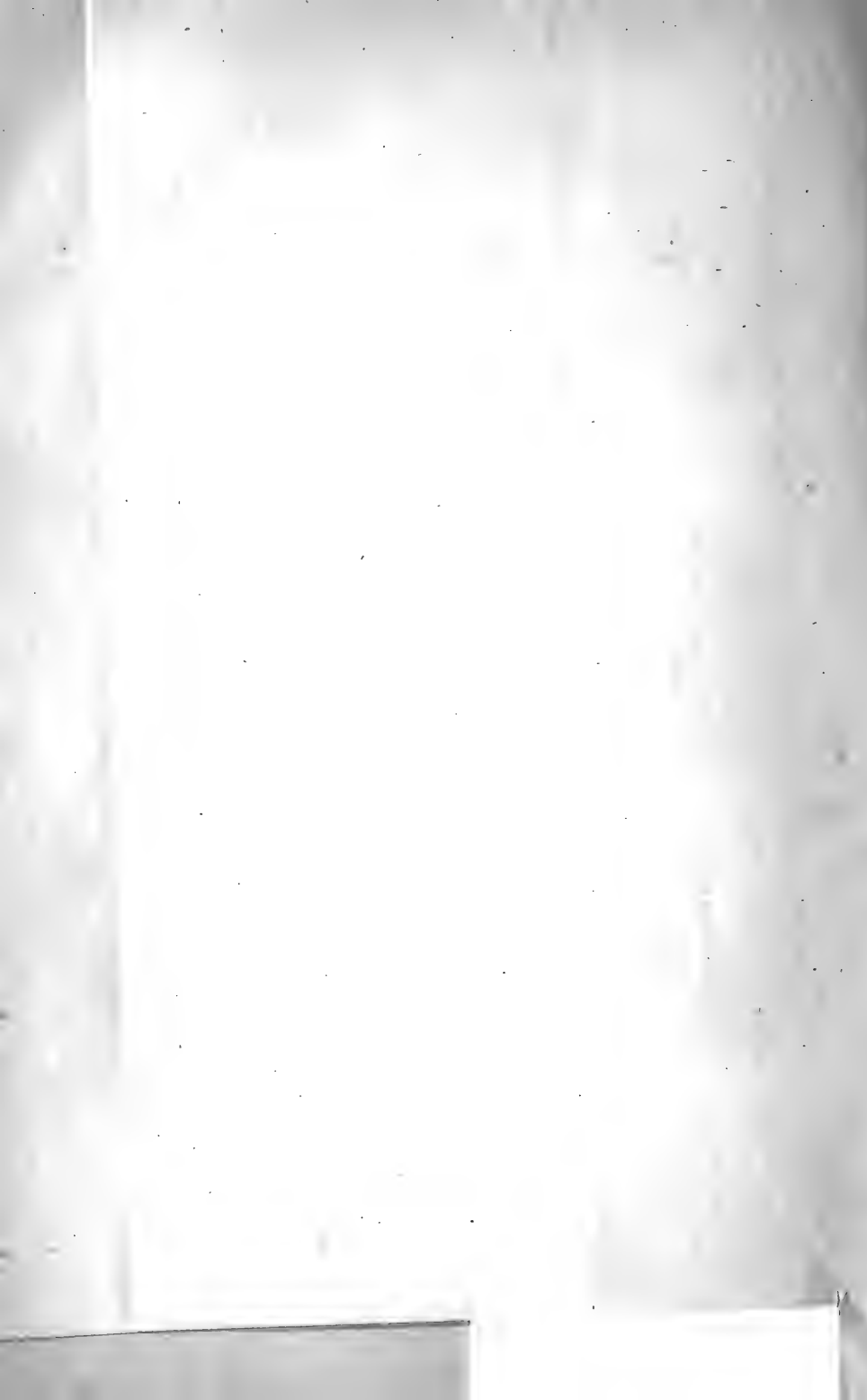

going details, and set forth in Chapter XI a simple and practicable process for reclaiming the ammonia of gas-liquor wherever the latter may be found.

The comparative abundance and cheapness of the several kinds of woollen and leather waste deserve the most serious consideration in this connection. I have long given the subject such study as my leisure would permit, and the plan for converting these materials into ammonia, which would be most likely to succeed, is one assimilating in character to the analytical method of estimating the amount of nitrogen in organic bodies by combustion with soda-lime.

The principle upon which such a process would be founded is safe and well-established, and consists in the property which nitrogenous organic bodies have of giving off the whole of their nitrogen in the form of ammonia, when strongly heated with hydrated alkalis.

The soda-lime employed may be reclaimed an indefinite number of times; so that the expense on this item would be at the lowest possible point. But there are mechanical difficulties which beset the necessary arrange-

ment for effecting a progressive combustion on a large scale. My present idea is to use iron retorts, like those for making coal-gas, but longer, and with suitable valve-cocks for safety, and tube-attachments to convey away the gas and intercept the fluid portion of the distillate.

The mixture of waste and soda-lime having been put into a series of retorts, the whole are to be closed and made air-tight at the joints by means of fire-lute. As it would cause a too sudden and free flow of distillate to put fire under the retort throughout its entire length at once, the heating would have to be restricted at the commencement to the first twelve inches of the front or mouth portion of the retort, and pushed forward gradually as the current of gas from the preceding part begins to slacken.

It is necessary that a good fire should envelope the top of the retort as well as the bottom. Indeed, it is the arrangement of the heating appliances, so as to produce a progressive and perfect combustion of a large quantity of waste in each retort, that presents the chief obstacle to the installation of an

economical and ready-working process upon the basis which I have suggested. As the obstacle is not by any means insurmountable, I hope that it may soon have solution by some competent mind and hand.

Richard Morris and Mulgrave Daniel Penny, manufacturing chemists of Yorkshire, England, obtained a patent recently for a process in this direction, which they describe as follows:—

“The process is for treating shoddy and other animal waste to obtain ammonia and salts of ammonia therefrom.

“We decompose the shoddy, or it may be leather cuttings, horn piths, or such-like animal waste, in clay or iron retorts, heated to a cherry red; and we admit jets of steam into the retorts. Retorts like those used for the manufacture of coal-gas, and similarly set in a furnace may be employed.

“The gases and vapours from these retorts are passed into a main, as in the manufacture of coal-gas, where tar and ammoniacal water are deposited. From the main, the gases and vapours pass into the retorts containing the alkaline matter.

“Lime is the material we commonly employ. The lime retorts are similar, but of

greater length, say twenty feet or thereabout. They are heated to a white-heat. The gases and vapours are passed in succession through the lime retorts (six retorts are a convenient number to employ), and then they are caused to enter an absorbing tower where the ammonia formed is absorbed by acid, by preference sulphuric acid. The water and the tar which condense in the main, and the acid in the absorbing vessel, contain all the ammonia.

“The acid is drawn off from the absorbing vessel from time to time, and saturated by distilling ammonia into it from the water of the main. Finally, the saturated solution is evaporated to the point of crystallization.

“The gas, of which the quantity is large, is collected in gasometers, and it may be employed for the purposes of heating and lighting. An exhauster may advantageously be employed to draw the gas and vapour from the retorts, as is usual in the manufacture of gas. The shoddy, or animal-matter retorts, are re-charged in succession, as soon as it is found that the material in them is spent, and the residue is useful as animal charcoal or as manure. The lime retorts are also re-charged from time to time, whenever the lime is found to have become clogged with deposit and spent; the gas and vapour are caused to pass

first into the lime retort which has been longest charged, and last into that which has been most recently replenished. Sometimes we charge the last retort of the series with soda-lime or with caustic soda, in place of with lime, and so get a most perfect conversion of the nitrogen of the animal matter into ammonia. We purify the sulphate and other salt of ammonia by crystallization in the usual way, and from this ammonia salt caustic ammonia may be obtained by heating with lime, as is well understood."

Sulphate of Ammonia. $\text{NH}_3, \text{SO}_3, \text{HO} = 66.$

This salt, when pure, is composed of—

Ammonia (NH_3)	17.0, or per cent.,	25.75
Sulphuric acid (SO_3) -	40.0	60.62
Water of constitution (HO) -	9.0	13.63
	<hr/>	<hr/>
Chemical equivalent -	66.0	100.00

This is the neutral sulphate obtained on a large scale from the water of condensation, produced in the distillation of coal for generating illuminating gas, and in the calcination of bones for making bone-black or bone-ash. It is manufactured, also, from stale urine and other animal matters. It is in

crystals, which are colourless when pure, but dirty grey or brownish when crude. The crystals are six-sided prisms, with corresponding pyramidal tops, and have a specific gravity of 1.75. They are very soluble in cold water, but insoluble in alcohol, and have a bitter, piquant taste.

Sulphate of ammonia melts at 284° F., but resists decomposition up to 356° F. Beyond the latter degree it loses ammonia, becomes firstly bi-sulphate, and changes finally into nitrogen, water, and bi-sulphate of ammonia, which sublimes.

This salt is the means by which I change the chloride of calcium of hydrochloric solutions of mineral phosphates of lime, into chloride of ammonia and sulphate of lime; so as to reclaim the hydrochloric acid profitably, and, at the same time, to free the precipitated phosphate of lime from any hygroscopic or humid tendency.

Each (1.0) per cent. or pound of this neutral sulphate of ammonia is equivalent to 1.32 neutral sulphate of potassa.

For each pound (1.0) of carbonate or organate of lime that may have been dissolved

out of the mineral phosphate by hydrochloric acid (2·13), there will be required 1·32 pounds of sulphate of ammonia, and the products would be—

1·72 lbs. of hydrated sulph. of lime ($\text{CaO}, \text{SO}_3, 2\text{HO}$);
1·07 lbs. of dry chloride of ammonium (NH_3, HCl).

Chloride of Ammonium, or Hydrochlorate
of Ammonia. $\cdot \text{NH}_3, \text{HCl} = 53\cdot5$.

When pure, its composition is—

Ammonia (NH_3)	-	17·0, or per cent.,	31·78
Hydrochloric acid (HCl)	36·5	„	68·22
Chemical equivalent	-	53·5	„ 100·00

This salt crystallizes in needles, which are soluble in water and alcohol. It is always anhydrous, and sublimes unaltered at a temperature just below redness. It is commonly called *Sal Ammoniac*. Specific gravity, 1·45 to 1·50.

Its per cent. of ammonia is much higher than that of the sulphate (25·75), and on this account, as well as for other good reasons, it is to be preferred for fertilizing purposes.

Sulphate of Potassa. $\text{KO}, \text{SO}_3 = 87\cdot0$.

Its composition, when pure, is as follows :

Potassa (KO) - - -	- 47'00, or per cent.,	54'00
Sulphuric acid (SO ₃)	- 40'00	„ 46'00
	<u> </u>	<u> </u>
Chemical equivalent	- 87'00	„ 100'00

This is a neutral salt in the form of colourless hard crystals, which are very soluble in cold or hot water, and resist decomposition at even high temperatures. Its specific gravity in the anhydrous state is 2·625; but it varies from 2·623 to 2·656 in the ordinary commercial article.

It is used alone or in conjunction with sulphate of ammonia for economising the chloride of calcium *wash* liquor in the processes of this treatise, by precipitating the lime as sulphate and forming chloride of potassium. But it is in no sense as advantageous for that purpose as the sulphate of ammonia.

Each per cent. (1·0) or pound of carbonate and organate of lime which has been decomposed and dissolved by hydrochloric acid (2·13) from the raw mineral, requires 1·74

pounds of this neutral sulphate of potassa, and forms—

1·72 lbs. of hydrated sulph. of lime ($\text{CaO}, \text{SO}_3, 2\text{HO}$);
1·49 lbs. of dry chloride of potassium (KCl).

This salt is a secondary or reclaimed product in the clarification of oils and in many other manufacturing processes. Dark coloured crystals cost less than the bright, and are sufficiently pure for this process. It is also sent to market largely from the natural deposits at Stassfurt, in Prussia, and in this form is known commercially as *kainit*; which contains, as an average, 23 to 25 per cent. of sulphate of potassa, associated with 14 to 28 per cent. of magnesia salts and 30 to 48 per cent. of chloride of sodium.

Chloride of Potassium. $\text{KCl}=74\cdot5$.

Its composition is—

Potassium (K)	- 39·0, or per cent.,	52·35=KO,	63·1
Chlorine (Cl)	- 35·5	„	47·65
		<u> </u>	<u> </u>
Chemical equiv.	- 74·5	„	100·00

This is an anhydrous salt which crystallizes in cubes or rectangular prisms, and dissolves

in about two and a half times its weight of cold water. It volatilizes at a red heat without decomposing. Specific gravity 1.950.

Carbonate of Potassa. $\text{KO}, \text{CO}_2=69.0$.

When pure and ignited its composition is :

Potassa (KO)	-	-	47.00, or per cent.,	68.11
Carbonic acid	-	-	22.00	31.89
Chemical equivalent	-	-	69.00	100.00

As found in commerce, however, it is a more or less impure salt under the names of *salt of tartar* and *pearl ash*, and contains about 16 per cent. of water of crystallization.

The first is in the form of a coarse granulated powder, insoluble in alcohol, but very soluble in water and even deliquescent. It fuses at a red heat without decomposing.

Salt of tartar is refined pearl-ash, obtained by dissolving the latter in water, and leaving it to repose. The clear liquor contains all the caustic and carbonate of potassa, with some portion of the other soluble salts of the pearl-ash, and rests upon a sediment of insoluble impurities. The liquor being then drawn off and concentrated by evaporation, drops a fur-

ther portion of its foreign salts, from which it must be decanted. Thus largely freed from impurities it is finally evaporated to syrup and stirred into dry granular *salt of tartar*.

It is employed in the processes which will be described for the mineral phosphates of alumina; and would answer the required purposes in its crude form of pearlash.

Lime. $\text{CaO}=28$.

The composition of caustic lime when pure is—

Calcium (Ca)	-	-	20.0, or per cent.,	71.42
Oxygen (O)	-	-	8.0	28.58
Chemical equivalent	-	28.0	„	100.00

It is largely diffused in nature as carbonate and sulphate, and forms the basis of limestones, chalk, the various kinds of marbles, calcareous spars, gypsum and many other minerals.

Caustic lime is obtained by calcining limestone or other carbonate of lime in suitable kilns. In this way the carbonic acid is driven off and lime remains in a “quick” or caustic state mixed with more or less of magnesia,

alumina, oxide of iron, silica, and the other impurities of the original raw material.

These vary in quantity from 5 to 30 per cent. according to the kind of raw material; and when the lime is to be employed in chemical equivalent proportion, the amount of foreign matters must be predetermined by analysis and excepted in the calculation. Any excess above five per cent. of impurities takes it out of the class of good lime for the processes of this treatise.

Lime is in lumps, sometimes white and at others grey, very alkaline, and has such an affinity for water and carbonic acid that it must be kept in closed barrels protected from exposure to air. It is very soluble in acids, and forms salts with them. Hot water dissolves it less readily and in less quantity than cold water, which latter takes it up in the proportion of one part of lime to every 730 parts of water. Specific gravity 2·3 to 3·0.

When quick-lime is sprinkled to saturation with water it soon begins to give off hissing sounds, develops great heat and thick vapours of volatilized water, and finally enlarges its volume into a fine powder or

mass of *slaked lime*, which is a hydrate of lime= CaO , HO.

In slaking the lime with half its weight of water, the temperature rises to 500° .

The longer it takes to fall to powder after the drenching with water for slaking it, the more impure it is. A good rich lime is never longer than three to five minutes in answering favourably to this test.

If the quantity of water is then further increased so as to give a liquid character to the mixture, the product is *milk of lime*. This milk must be strained through a fine sieve of galvanized wire cloth.

One equivalent of anhydrous lime($\text{CaO}=28$) corresponds with one equivalent of dry hydrochloric acid ($\text{HCl}=36.5$) or one equivalent of dry sulphuric acid ($\text{SO}_3=40$).

Carbonate of Lime.

This substance is noted in another place as to its more scientific relations; so that it only remains to mention it here in its practical bearings upon the processes about to be described.

The form employed is that commonly

known as *whiting*. It is prepared from *chalk*, a white earthy mineral which may be considered, practically, as pure carbonate of lime. That is, its impurities are in small proportion, and mostly mechanical, and easily removed. It is the elimination of these latter which changes the chalk into whiting. According to Schweitzer's analysis, the chalk of Brighton (Sussex) cliff is composed of—

Carbonate of lime	-	-	98·57
Carbonate of magnesia	-	-	·38
Phosphate of lime	-	-	·11
Oxide of iron	-	-	·08
Oxide of manganese	-	-	·06
Alumina	-	-	·16
Silica	-	-	·64
			100·00

The process consists in grinding the chalk, diffusing the powder in a large volume of water, and leaving to repose only so long as may be necessary for the subsidence of the heavy particles. The liquor, holding in suspension all of the finer portion, is to be drawn off into a vat and allowed to settle. When this has been accomplished, the supernatant water is to be drawn to waste through taps,



MORFIT or

Trübner & Co. 60, Patet.

and the residual white pulpy deposit dried in the air or in a moderately heated chamber.

The dried mass is "*whiting*", and so much more suitable than chalk as a chemical agent, that in many instances it will produce the desired effect where chalk would fail.

Sulphate of Lime. $\text{CaO}, \text{SO}_3, 2 \text{HO} = 86.$

Its composition is—

Lime (CaO)	-	-	-	28.0, or per cent.,	32.56
Sulphuric acid (SO ₃)	-	-	40.0	,,	46.51
Water of constitution (HO)	-	18.0	,,		20.93
Chemical equivalent	-	86.0	,,		100.00

Ordinary sulphate of lime is known as "*ground plaster.*" When this is calcined it becomes anhydrous, and is then called "*plaster of Paris.*"

The form relating to fertilizers is that of artificial hydrate, because it is much more active as a fertilizer than the natural ground gypsum. It is the solid product obtained in the decomposition of the *wash liquor* (chapter xi) by sulphate of ammonia or potassa, and then dried at 120° F. From this source it will retain, generally, some little of ammonia or potassa salt.

DETAILS OF ELEVATOR LIFT & PLATFORM.

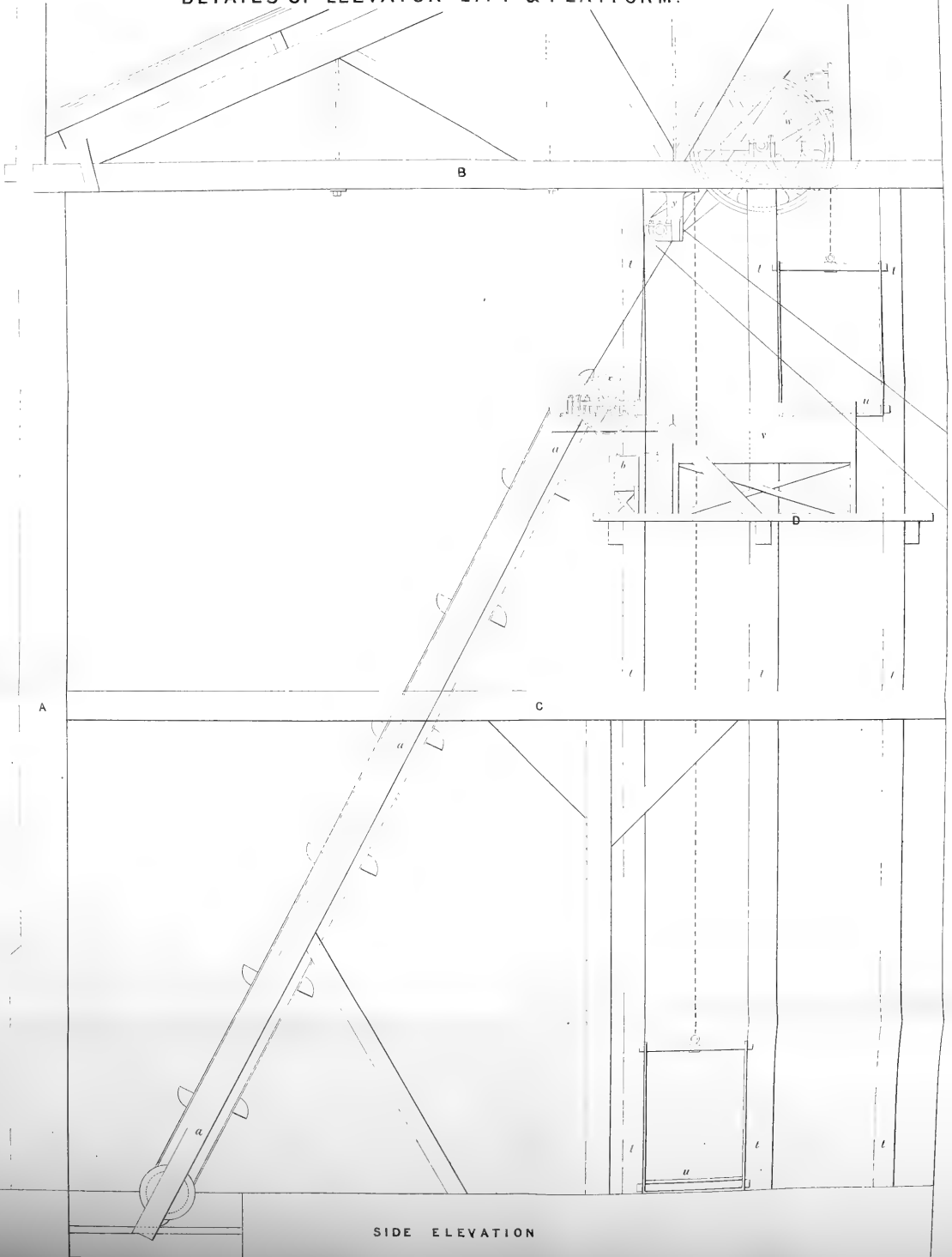

SIDE ELEVATION

SCALE OF FEET.



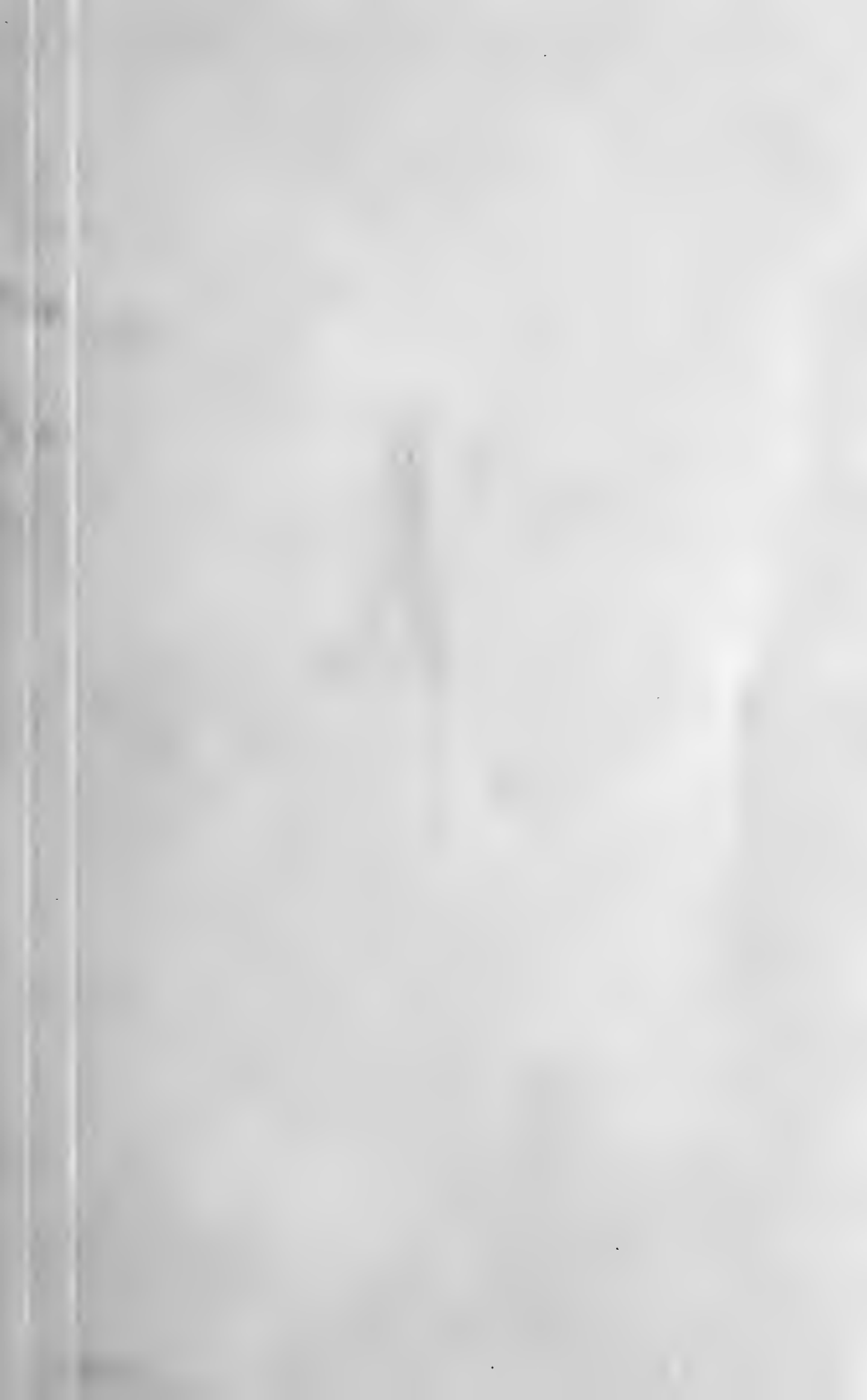

Nitrate of Soda. $\text{NaO}, \text{NO}_5=85\cdot0$.

Its composition is—

Soda (NaO) -	-	31·0, or per cent.,	36·81
Nitric acid (NO ₅) -	-	54·0	63·19
		85·0	100·00

This salt forms thick natural beds of great extent in the deserts of Atacama and other parts of Peru and Chili, whence it is brought in very large quantities. It is found also in the Bahia province of Brazil. As found in nature, it is in the form of greyish white, grey and yellowish, friable lumps, containing two to eight per cent. of impurities consisting chiefly of water, chloride of calcium, chloride of sodium, sulphate of potassa, nitrate of potassa, and nitrate of magnesia.

It crystallizes in rhombohedra, the angles of which are not very far removed from those of a cube, and hence its synonyme of *cubic nitre*. It is also known as *Chilian saltpetre*.

It is very soluble in water, but rather insoluble in alcohol, and has a tendency to dampness, and a sharp, bitter, cooling taste.

CHAPTER III.



CHEMICAL DATA IN CONNECTION WITH THE RAW MATERIALS OF ARTIFICIAL FERTILIZERS.

A PROPER understanding of the subject of this treatise will depend upon a knowledge of the internal, as well as physical, properties of the substances employed.

This chapter, therefore, will be devoted to the study of the individual components of the raw materials which enter into the manufacture of artificial fertilizers.

The most important is the phosphate of lime, and there are three chemical phases of it. The principal one is the tri-basic or bone-phosphate forming the structure of bones. This consists of three equivalents of lime in combination with one equivalent of phosphoric acid. The second is the di- or neutral-phosphate, differing from the preceding

in containing two equivalents of lime to one of acid, the third equivalent of lime being replaced by water. The third is the bi-phosphate, and consists of only one equivalent of lime to one of acid, with two equivalents of water. "Super-phosphate" is the commercial mixture of bi-phosphate, bone-phosphate, and sulphate of lime made by the action of sulphuric acid on animal or mineral phosphate of lime.

These distinctions of formulæ will be better understood when expressed in tabular form with their relative numerical equivalents or values affixed.

Distinction.	Symbol.	Combining Numbers.			Composition per cent.		
		Lime.	Water.	Phosphoric Acid.	Lime.	Water.	Phosphoric Acid.
Tri- or Bone-phosphate of lime } }	3CaO. PO_5	84·0	—	72·0 (= 156)	53·85	—	46·15 (= 100)
Di- or Neutral - phosphate of lime } }	$2\text{CaO. PO}_5 + \text{HO}$	56·	9	72· (= 137)	40·87	6·57	52·56 (= 100)
Bi - phosphate of lime } }	$\text{CaO. PO}_5 + 2\text{HO}$	28·	18	72· (= 118)	23·73	15·26	61·01 (= 100)

Tri- or Bone-Phosphate of Lime. $3 \text{CaO, PO}_5 = 156.$

This is the most common form, being widely diffused in nature as the carthy

structure of bones and the basis of mineral phosphates, such as apatite, phosphorite, coprolites, rock guanos, marlstones, and the like.

It is also a component of ammoniacal guanos; and the chief constituent of bone-black and bone-ashes. When associated with gelatine and other organic matters in its natural condition of ground bone, it breaks up in the soil under atmospheric influences into forms which are not only soluble but very assimilable by the growing crops. In the state of bone-black it is scarcely less soluble in the soil; and in the form of bone-ash falls only a few degrees in rank of solubility below the bone-black. Weak acids dissolve it readily; and those of greater strength not only dissolve it but convert it into super-phosphate by abstracting two equivalents of its lime.

In like manner, the presence of acetic acid, carbonic acid, chloride of ammonium, certain potassic salts, and chloride of sodium, causes it to split into more soluble phosphatic salts or states; and it is in this manner drawn up by growing crops into the vegetal circulation.

It may be prepared artificially from an aqueous solution of chloride of calcium by the addition of an aqueous solution of basic phosphate of soda ; or on a large scale by precipitating a hydrochloric acid solution of bone-phosphate of lime, or even of bone-ash, with pure ammonia.

Strictly considered, however, this precipitate from the latter solutions is rather a mixture of several phosphates of lime, all quite prompt to assume solubility under the conditions existing in soils.

When freshly precipitated from an acid solution, phosphate of lime is white and insoluble in water, but peculiarly sensitive to the solvent action of water containing only a small quantity of ammonia or carbonic acid.

This action, though gradual, is constant, and extends even to the precipitated phosphate in a dry state.

As existing in rock guanos or minerals, tri-phosphate of lime is not only cemented closely by associate ingredients, but has naturally a physical temperament which renders it obstinate to the action of solvents

under the ordinary conditions pertaining to the soil. These natural forms are consequently so very slow as fertilizers *per se* that chemical treatment must be practised to render them soluble previous to their application.

This is particularly necessary when they are accompanied with fluoride of calcium, silicate of lime, alumina, phosphate of alumina, oxide and phosphate of iron.

Di- or Neutral-Phosphate of Lime. 2CaO ,
 HO , $\text{PO}_5 = 137$.

This phosphate exists in many mineral waters, but is rarely found in nature to any extent. The only two instances in my knowledge are, that of the Colombian guano from Maracaibo, of which the stock has been exhausted long since; and another rock-phosphate from Rossa Island near Guaymas in the Gulf of California. It has been formed in nature, as it may be in the laboratory, by the gradual action of water, and particularly of water containing ammonia or alkali, upon bone-phosphate lime in a fresh state as existing in bird dung or ammoniacal guanos. It

may be precipitated, too, from acid solutions ; and at the same time some bi-phosphate of lime is produced.

As prepared artificially by adding an aqueous solution of ordinary phosphate of soda to an aqueous solution of chloride of calcium, it is a white precipitate only slightly soluble in water, but very easily soluble in acids, and readily taken up by water containing carbonic acid, ammonia, ammoniacal or even potassic salts.

Some little of it is formed in my process for manufacturing *Colombian Phosphate*, as described in Chapter IX ; and the methods, described in Chapter X, produce it nearly pure.

Guanos or artificial manures, which may contain their phosphatic element in the state of neutral phosphate of lime, will prove to be very active and potential fertilizers.

Chemically considered, it is the best possible material for conversion into "superphosphate". The economy of sulphuric acid and the very high degree of soluble phosphate thus obtained will be great advantages to both producer and planter.

Bi-phosphate of Lime. $\text{CaO}, 2\text{HO}, \text{PO}_5 = 118.$

This phosphate exists, naturally, only in small quantities, as a component of certain mineral waters and organic products.

It is prepared artificially by acting on the tri-basic or bone phosphate of lime with dilute sulphuric acid, which takes away two equivalents of lime, and, with two double equivalents of water, forms hydrated sulphate of lime; leaving the phosphoric acid with one equivalent of lime and two equivalents of water, as bi-phosphate.

To make the decomposition perfectly intelligible, it is only necessary to formulate it as follows:—

One equivalent of $(\text{CaO}.2\text{HO}.\text{PO}_5)$ Bi-phosphate of Lime.

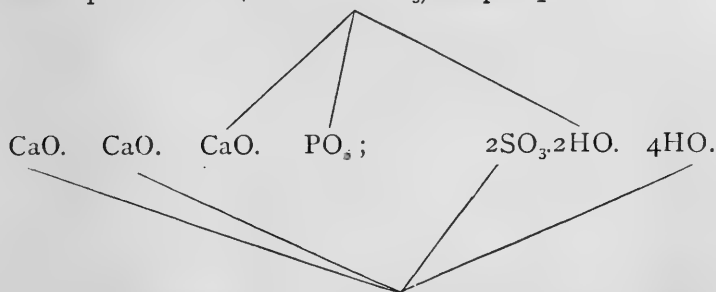

Two equivalents of $((2)\text{CaO}.\text{SO}_3.2\text{HO.})$ Sulphate of lime.

The ascending lines represent the soluble product, and the descending lines indicate the insoluble one.

As bone-phosphate of lime consists of three equivalents of lime (CaO , $28 \times 3=84$) and one equivalent of phosphoric acid (P , $32 + \text{O}$, $40=72$), it follows that every equivalent = 156 when acted on by oil of vitriol or mono-hydrated sulphuric acid diluted with four equivalents of water (2) $\text{SO}_3 \text{HO} (=98) + 4\text{HO} (=36)=134$, will yield—

- | | | |
|---|---|------|
| 1. Bi-phosphate of lime (CaO (28) 2HO (18) PO_5 (72) | } | =290 |
| = 118 parts by weight | | |
| 2. Sulphate of lime (2) CaO (56) 4HO (36) 2 SO_3 (80) | | |
| = 172 parts by weight | | |

As much heat is generated during the chemical reaction, an excess of water must be added to provide for loss by evaporation. Taking this circumstance into consideration, then, by adding together the original items of the formula, the proof of the latter is made evident, thus :—

One equivalent of bone-phosphate of lime	=	156	by weight.
Two equiv. of mono-hydrated sulphuric acid	=	98	„
Two double equivalents of water of dilution	=	36	„
Total	-	-	290

 Converted into—

One equivalent of bi-phosphate of lime	=	118	by weight.
Two equivalents of sulphate of lime	=	172	„
		290	
Total	-	-	290

This salt is very soluble in water, and its aqueous solution when evaporated to syrupy consistence crystallizes in pearly scales, which are deliquescent. These scales, if heated too long, even moderately, assume in part an allotropic condition, which is somewhat insoluble. By igneous fusion it wholly loses its property of solubility.

Of all the phosphates of lime this is the favourite one for agricultural purposes, on account of its great solubility and consequent fertilizing energy. I believe, however, that the phosphate prepared by precipitation from acid solutions of animal or mineral bone-phosphates, and named by me Gelatinous or Colombian phosphate of lime, is sufficiently potential for producing an active and rich vegetation at much less cost than the super-phosphate. Indeed, it is more than probable that this latter is changed into the former by the carbonic acid and other chemical in-

fluences of the soil before it has had time to exert much action by reason of its direct solubility when first applied. If this does not take place, then much of the bi-phosphate would be lost by reason of its solubility; for the rain would wash down into the subsoil all that might not be absorbed by the plants immediately after its application. This portion would be nearly the whole, as it is not rational to suppose that the vegetal absorption could be instantaneous as to the total of any fertilizing element.

If there should be any carbonate of lime, alumina, oxide of iron, or powdered mineral phosphate mixed with the pure bi-phosphate, as in the ordinary commercial "superphosphate", the soluble phosphate of the latter is apt to become insoluble even in the bags, on account of the formation of di- and tri-phosphate. When this occurs, the "superphosphate" is said, in trade parlance, to "*go back*".

Precipitated Phosphate of Lime.

This salt is said to be of the same chemical composition as the bone-phosphate, but with

the addition of quasi-constitutional water in proportion varying from four to six equivalents. It may have the formula 3CaO , $\text{PO}_5 + 4\text{HO}$, or 3CaO , $\text{PO}_5 + 6\text{HO}$, according to the manner in which it may be dried; but most of this water can be expelled by kiln-drying. Practically considered, the circumstances of its preparation influence also its composition. It is prepared always by precipitation with alkalies or alkaline earths, from solutions of the tri- or neutral-phosphate of lime in acids.

My opinion is, that the precipitate comprises all of the several phosphates, varying in proportion with the state of dilution and temperature of the solution and the kind and quantity of precipitant employed; for I have certainly observed, that in its fresh pulpy state, it is not only very soluble in acetic and weak acids, but even splits into soluble forms under the action of water containing carbonic acid, ammonia, chloride of sodium, and many other saline matters. Very probably the carbonic acid of the soil may convert it gradually into bi-phosphate, di-phosphate, and carbonate of lime.

In its dry state it is scarcely less sensitive, and these properties give assurance that under the chemical influences of the soil it will prove as potential in fertilizing as the bi-phosphate, and at much less expense. Indeed, the bi-phosphate is first reduced, doubtless to the state of precipitated phosphate, soon after it has been applied to the soil and the growing crops assimilate it in that form through the subsequent influence of carbonic acid and saline associates.

It is on account of the composite nature and the tender properties above noted, that I have not given it a place in the preceding chemical table, and prefer to distinguish it by the title of *Colombian phosphate of lime*, when it is thrown down by whiting, and *Precipitated phosphate* when ammonia is the precipitant.

Sulphite of Calcium-Phosphate.

This is a product of the action of sulphurous acid upon tri-phosphate of lime, and its chemical and practical relations are given in chapter xvii.

Phosphate of Magnesia.

The chemical equivalent of magnesium is 12.0, and it forms tri-, di-, and bi-phosphates, corresponding in composition with the similar salts of lime, thus:—

Tri-phosphate or $3\text{MgO}, \text{PO}_5$;
 Di-phosphate or $2\text{MgO}, \text{PO}_5, \text{HO}$;
 Bi-phosphate or $\text{MgO}, \text{PO}_5, 2\text{HO}$.

For all practical purposes, this salt may be considered as phosphate of lime, since it assimilates to the latter sufficiently, in chemical and agricultural relations, to justify the union of them under one head. Moreover, it is rarely present to any large extent in mineral phosphates of lime.

Carbonate of Lime. $\text{CaO}, \text{CO}_2, = 50.00$.

Oxide of calcium (CaO) -	28.00,	or per cent.	56.00
Carbonic acid (CO ₂) -	22.00	„	44.00
Chemical equivalent -	50.00	„	100.00

In nature, the more common forms of this chemical salt are the different kinds of chalk, calcareous spars, marbles, and limestones. It is very widely diffused, being an element

of most of the river, spring, and other waters. It also enters into the composition of manifold other substances to a greater or lesser degree. When pure, it is perfectly white. On being calcined at a red heat in an open furnace it gives off its carbonic acid and becomes caustic or quicklime (CaO).

Carbonate of lime is insoluble in water, unless the latter should contain free carbonic acid. With this latter it forms bi-carbonate of lime, which is soluble. Carbonate of lime is also soluble in acids. It is almost an invariable constituent of rock guanos or other phosphatic materials, but it does not impart any value to the latter. On the contrary, until the discovery of my new methods for the treatment of these rock guanos, it was a real pest, in that it consumed acid to extend the weight and dilute the strength of the fertilizer from those materials without forming any compensating product.

According to Warrington, when carbonate of lime is present with phosphate of lime, as in mineral phosphates especially, it way-lays the atmospheric influences of the soil and monopolizes their action by its greater

xi for Dr. Morff's Work on Fertilizer.

B

DETAILS OF ELEVATOR LIFT & PLATFORM

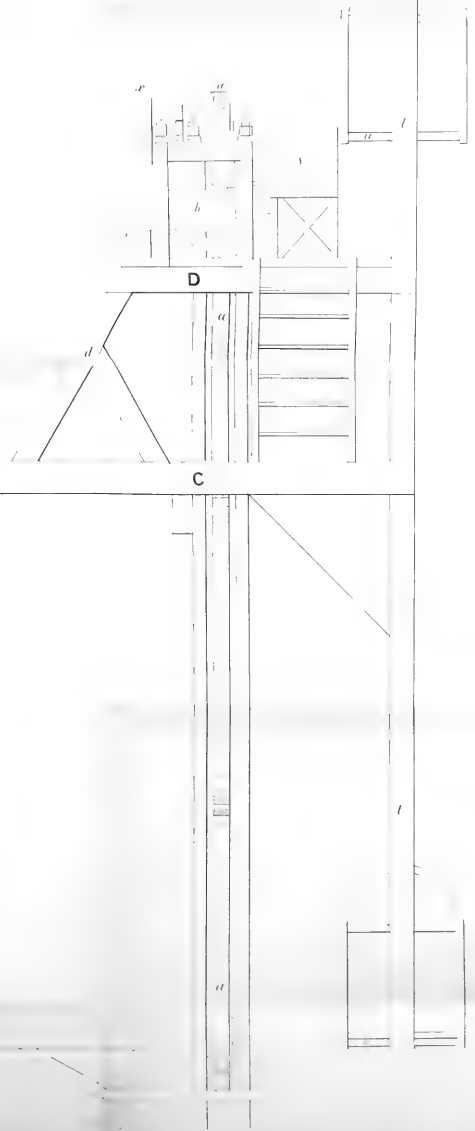

FRONT ELEVATION .

SCALE OF FEET



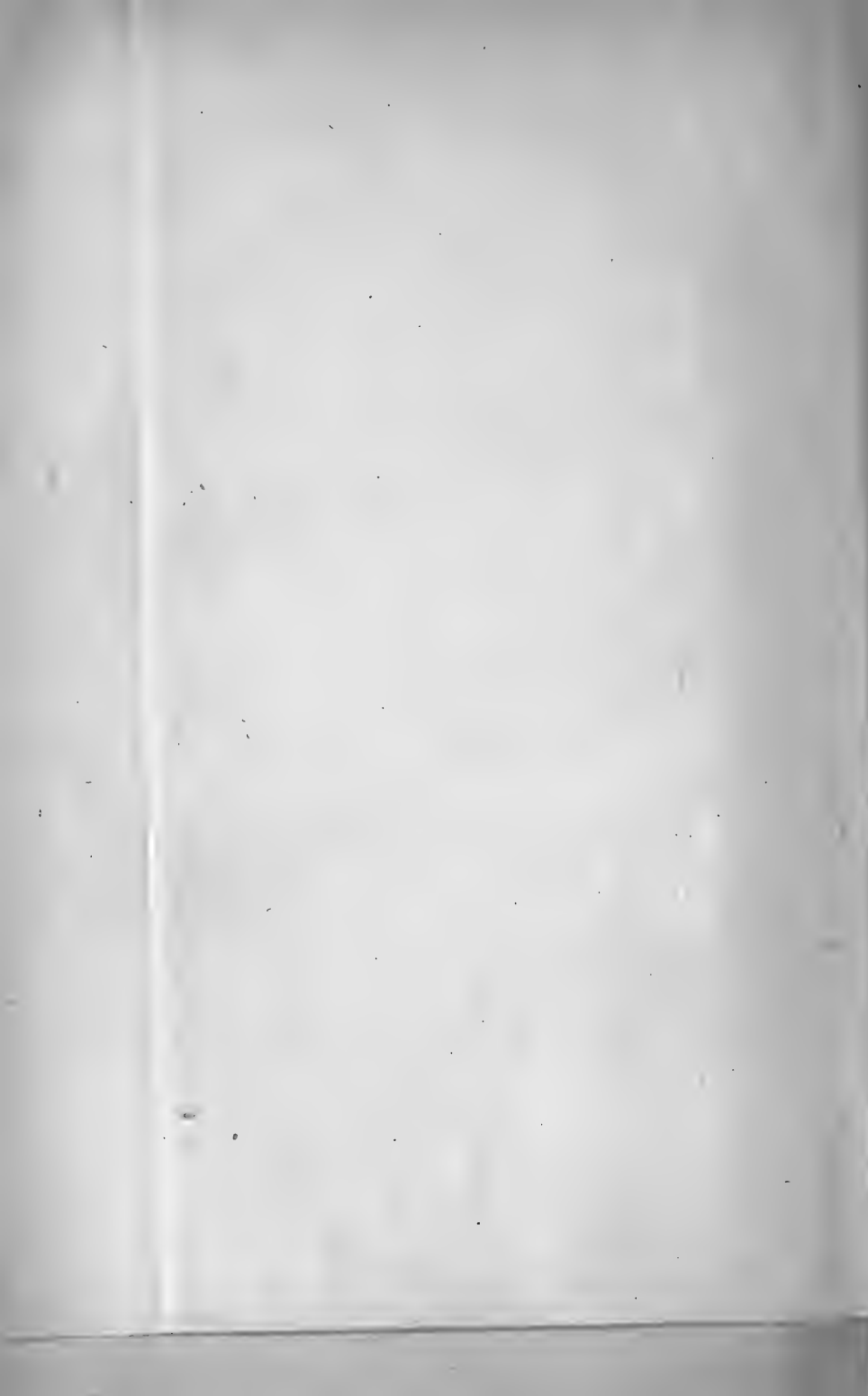

chemical sensibility under the circumstances. Therefore the fertilizing action of the phosphate associate remains dormant until the carbonate has been decomposed by the carbonic acid of the soil.

When the raw mineral phosphate is to be converted into precipitated phosphate or superphosphate, this carbonate of lime constituent is the first to seize and appropriate the earlier additions of hydrochloric or sulphuric acid.

In this way 2.13 of hydrochloric acid (1.17) or 1.00 oil of vitriol (1.846) would be consumed by each per cent. of carbonate of lime.

The profitless product thus imported into the resulting fertilizer would be 1.29 hydrochlorate of lime in the first case, and 1.72 of hydrated sulphate of lime in the second instance, according as one or other of these acids may have been used as the solvent. Hydrochlorate of lime (chloride of calcium) is not only an unprofitable element itself, in this connection, but also a deteriorating presence, which renders the fertilizer product

hygroscopic, and depresses the content of soluble bi-phosphate.

So, also, the hydrated sulphate of lime thus forced into the fertilizer product crowds out soluble bi-phosphate, and renders impracticable any high strength of the latter.

Organate of Lime.

In making a chemical analysis of a mineral phosphate or "rock guano", and after apportioning the lime according to its well-known chemical affinities, there is frequently a residue which, in our present state of knowledge, cannot be allotted confidently to any associate element.

I assume, therefore, until I can inform myself better, that it exists naturally in combination with the organic acids, and probably the silicic acid and alumina which may be present.

Be that as it may, for all the practical purposes of this treatise, organate of lime is to be considered as carbonate of lime, and treated with acids accordingly, in the manufacture of fertilizers.

Sulphate of Lime. $\text{CaO}, \text{SO}_3, 2\text{HO} = 86.0.$

Oxide of calcium (CaO)	- 28.0, or per cent.,	32.56
Sulphuric acid (SO ₃)	- 40.0	46.51
Water of constitution (2HO)	18.0	20.93
Chemical equivalent	- 86.0	100.00

This substance is known in nature as *Gypsum* when amorphous or crystalline, and as *Selinite* or *Alabaster* if crystallized. It is white in the first, and colourless in the second form. It is soluble to the extent of three parts in 1000 of water, but insoluble even in dilute alcohol. Boiling hydrochloric acid dissolves it more freely, and so also does a solution of common salt. By calcination at 212° to 300° F., it loses its water and becomes *Plaster of Paris*.

Its presence in rock guanos neither adds to, nor detracts from, the value of the latter. Though it does not waste acid, it dilutes the mother-material without improving its value. The economy of the raw mineral would be better for its absence.

Fluoride of Calcium. $\text{CaFl} = 39$.

Calcium (Ca)	-	-	20.0, or per cent.	-	51.29
Fluorine (Fl)	-	-	19.0	„	48.71
					<hr/>
Chemical equivalent	-	39.0	„		100.00

Is known as *Fluor Spar*, and found generally associated in nature with other minerals. It is also present in bones, to a small extent. *Coprolites* contain it, as also do some of the *Phosphorites* and *Apatites*.

In its natural state it is yellowish, greenish, or violet, and crystallized or crystalline. When heated, it becomes phosphorescent, and fuses at high degrees of temperature. Superheated steam decomposes it into lime and hydrofluoric acid. So, also, when fused with alkaline hydrates or carbonates, it is readily decomposed. It is itself used as a flux in the smelting of ores.

It is nearly insoluble in water, but dissolves in very strong hydrochloric acid. When acted on by sulphuric acid it gives off noxious vapours of hydrofluoric acid, and it is on this account that mineral phosphates which contain much of fluoride of calcium are not a

favourite material for superphosphating purposes. It also wastes acid in the usual mode of operating, but in the new processes herein described that defect may be lessened by careful manipulation in the digesting operation. Every per cent. of fluoride of calcium would waste 2.73 of hydrochloric acid of specific gravity 1.17, or 1.28 of oil of vitriol of 1.846.

Chloride of Calcium. $\text{Ca Cl} = 55.5$.

Calcium (Ca)	-	-	20.0, or per cent.	-	36.03
Chlorine (Cl)	-	-	35.5	„	63.97
					100.00
Chemical equivalent	-	55.5	„		100.00

Chloride of calcium is a constituent of numerous river, spring, and well waters, as also of many mineral substances. When pure, it is white, and so very soluble in water that it is one of the most deliquescent substances known. By igneous fusion it is perfectly dried; but, on exposure afterwards, soon absorbs moisture. It is also soluble in alcohol. Its presence gives a tendency to humidity to those substances which contain it.

Solutions of chloride of calcium are de-

ture of superphosphate would be less favourable to the economy of the product and also fatal to its perfect dryness.

Oxide of Iron. $\text{Fe}_2 \text{O}_3 = 80.0.$

As existing in mineral phosphate, it is most probably sesqui-oxide.

Two equivalents of iron (Fe_2)	- 56.0, or per cent.,	70.00
Three " oxygen (O_3),	24.0	30.00
Chemical equivalent	- 80.0	100.00

In its mineral state it has only a feeble affinity for acids. Being thus passive, most of it is left undissolved, when mineral phosphates which may contain it are treated in the cold with acids.

Oxide of iron as well as alumina are profitless constituents of mineral phosphates, both as to freight, expense, and fertilizing action. They not only waste acid but form objectionable compounds when the mineral is being converted into "superphosphate."

Phosphate of Iron. $\text{Fe}_2, \text{O}_3, \text{PO}_5 = 152.0.$

As associated with the other elements of mineral phosphates, it is possibly in the state

of phosphate of sesqui-oxide; and anhydrous. But, when freshly precipitated from acid solutions, it takes up four equivalents of water (4HO) and becomes hydrated. In this latter form, it differs from the anhydrous phosphate in important particulars; for it is then soluble in water containing carbonic acid, and also in weak acids, with certain exceptions. The hydrated, when heated to redness, becomes anhydrous, and then it is only partly taken up even by strong acids in the cold.

The freshly precipitated phosphate of iron, as above, has considerable fertilizing energy, more particularly when associated with ammoniacal and potassa salts, as these promote its solubility, and the assimilation of its phosphoric acid by the growing crops.

Oxide of Aluminium. $Al_2, O_3=51.4.$

In its mineral state it is generally anhydrous, and not very sensitive to the action of acids in the cold. When freshly precipitated it becomes quite soluble, and even water, containing carbonic acid, takes up a portion. In this condition it is also completely soluble in solutions of caustic potassa or soda.

When mineral phosphates which may contain alumina are treated with sulphuric acid, the product is more or less damp, unless this property should be corrected by the means prescribed in Chapters VIII and IX.

It is also a diluting constituent of the raw mineral without countervailing advantages.

Phosphate of Alumina. Al_2, O_3, PO_5 .

The composition of the phosphate of alumina as it exists in the mineral phosphates, is even more doubtful than that of the phosphate of iron constituent. In its natural hard state it is dissolved only slowly by the strong acids and the aqueous solutions of caustic potassa and soda. When precipitated from its solutions in acids, it is white, gelatinous, very soluble in acids, and more or less so in water containing carbonic acid and saline matters. When the precipitate is dried in the air, or by only moderate heat, these latter properties remain unimpaired. In this latter condition it is serviceable for fertilization, upon the reasoning which has been noted for phosphate of iron, but in a greater degree.

Its formula, then, is probably $\text{Al}_2, \text{O}_3, \text{PO}_5, 9\text{HO} = 204.40$, but it becomes anhydrous by ignition. The practical mode of converting phosphates of iron and alumina into fertilizers is described for redonda guano in Chapter XVIII.

Organic Matter.

This constituent of mineral phosphates is partly soluble and partly insoluble in acids. Most generally it contains little or no nitrogen. In all cases it remains with the products when the raw phosphates are converted into fertilizers by the processes described in this treatise. The action of the acids may modify its nature slightly, but the soluble portion goes with the precipitated phosphate, and the other forms part of the insoluble residue of the mineral. When the raw phosphates are treated directly with sulphuric acid for their conversion into "superphosphate," the presence of organic matters impedes the action of the acid in some degree, and also promotes its waste. In other respects it is merely an unprofitable diluting associate of the valuable components of the mineral.

Silica and Sand.

These form the part of mineral phosphates which is insoluble in either water or acids. They do not waste acids ; but are, nevertheless, wholly valueless in themselves, being inert diluents of the raw material.

Water.

Is nearly always present in mineral phosphates as an accidental or constitutional element. It is not in the way, chemically considered, but swells, unprofitably, the bulk of the mineral and its cost of transportation.

CHAPTER IV.

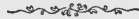

THE GRINDING APPARATUS.

IN all extensive works the factory plant should comprise a grinding apparatus. But as such an arrangement involves the necessity of much space and a large amount of steam power, it is more economical, for moderate operations, to have the raw mineral powdered outside by a regular grinder. The business of the latter being a distinct branch of trade, I will devote a special chapter to the best means of practising it in connection with hard mineral substances.

The usual machines for reducing the mineral phosphates to fine powder, are either French burr stone mills of the ordinary pattern, or cast-iron rollers like a mortar mill. The first are employed by certain manufacturers for grinding coprolites. If the raw mineral should be in large lumps, it would

have to be passed previously through a pair of iron cracker-rollers, in order to break it into smaller pieces, as a preparation for the mill.

The Roller Mill.

Much less expensive and more generally used are the cast-iron rollers. A mill of this construction, with rollers of eight feet diameter, will grind 200 tons of mineral phosphate per week of days and nights. The steam-power required to drive it is equivalent to that of eight horses, and three or four labourers suffice to attend it.

It is all-important that the rollers should be heavy; and the pan may either revolve or be fixed. Some manufacturers prefer the fixed pan; but the other arrangement is adopted most generally. Plate 1 shows a front elevation of a mill of this latter construction, set firmly upon a foundation *t* of mason work. The pan is *b*, and the crushing rollers are *a a'*, carried by the cross shafts *c c'*, bolted together in the middle. These cross shafts have the clips *g g'* on them to keep the rollers *a a'* in place. The pan *b* is

carried by a vertical spindle $d d'$ resting in the footstep p . The frame-work consists of the cast-iron uprights $e e'$, the top entablature f , and the endstay h . The arrangement for motion comprises the shaft l and its plummet blocks $m m'$, the driving pulley k , the bevel pinion n , and the circular rack o , fixed to the pan. The rollers turn round on a fixed axis by the revolution of the pan, and the mineral is kept under them by means of the scrapers.

Some engineers construct these mills so that the grinding and sifting may go on simultaneously in the same machine.

Then the plan b , as shown in the drawing, must be made with a false bottom, upon which the rollers are to run. This false bottom is placed at a distance from the real bottom so as to form a chamber beneath for the collection of the sifted material, which passes through the fine holes with which the bottom is cullendered for the purpose.

Or the pan may have only one bottom, and that cullendered, so that the material as fast as ground will sift through, and can be collected underneath by means of a shoot or otherwise.

When there is no such appendage to the mill, the sifting must be done by a separate instrument, as it is necessary to have the powder of uniform fineness in order that the subsequent chemical treatment may be facilitated.

The Sifter.

This implement, shown in side and end elevation by Plate 2, consists of a strong timber support *g* carrying in the interior the two inclined and revolving cylinders of wooden frame-work, shown by the dotted lines at *a a'* and *b b'*.

Stretching over the circumference of the cylinders is fine galvanized iron-wire cloth. The two sieves are connected by means of the shoot *c*, and derive motion from the pulleys *d* and *e*. The two cylinders being set in motion by steam-power, the mineral to be sifted is then thrown into the end *a'* of the upper one, by a man standing on the platform, *b*, formed by the framing of the machine. The finer portion finds its way through the meshes and falls into the shoot *c*, which conducts it into the end of the lower cylinder *b*. The coarser portions which will not pass through

the meshes are ejected at the end a of the top cylinder, the meshes of which should be coarser than those of the lower one. In like manner, when the finer portion of the upper cylinder falls into the lower one, that part which is fine enough passes through the gauze, while the portion that is too coarse finds its way out at the end b' .

It would seem, from the practical experience of manufacturers, that the most work to be got out of rollers even as large as eight feet diameter, is $1\frac{1}{2}$ tons of powdered mineral per hour.

With all these open mills there is an unavoidable loss of powder, which escapes as fine dust, to the extent of several or more per cent., in many cases, according to its density. I feel confident, therefore, that better progress and economy would be realised by the substitution of a different arrangement; or, in other words, by combining the powdering and mixing portions of the plant into one consisting of a Blake's crusher and a Howel-Hannay mill. A sifting machine will be unnecessary, then, and all the loss by escaping dust would be prevented.

A crusher is necessary to reduce the mineral only when it is in very hard lumps of size larger than an inch or two square. At all times, however, it will expedite the work of the Howel-Hannay mill, and economize the wear and tear of the machine to feed it with mineral of the size of inch cubes.

Both of the above-named machines are American inventions, but can be obtained in England. The Blake crusher is made at the Soho Foundry, Leeds, and is used extensively in this country.

The Howel-Hannay mill will not only reduce the mineral to fine powder, but serve also, and even better, for powdering the finished fertilizer as it comes from the drying kiln.

Blake's Crusher.

This machine is shown by Plate 3, in which fig. 1 represents a front elevation; and fig. 2 a plan of the entire machine.

The circle D is a section of the fly-wheel shaft, and the dotted circle E is a section of the eccentric. A *pitman* on rod F connects the eccentric with the *toggles* GG, which have their bearings forming an elbow or toggle-

joint. There is a *fixed jaw* H, against which the stones are crushed ; and this is bedded in zinc against the end of the frame and held back to its place by *cheeks* I that fit in recesses of the interior of the frame on each side. There is also a movable jaw J, which is supported by the round bar of iron K passing freely through it and forming the pivot upon which it vibrates. An india-rubber spring L is compressed by the forward movement of the jaw, and aids its return.

The frame A (see plan, fig. 2), which receives and supports all the other parts, is cast in one piece, with feet to stand upon the floor or upon timbers. These feet are provided with holes for bolts by which it may be fastened down if desired ; but this is unnecessary, as its own weight gives it all the requisite stability. The *fly-wheels* BB are on a shaft which has its bearings on the frame, and which is formed into an eccentric between these bearings. The pulley C on the same shaft receives a belt from a steam engine or other power.

Every revolution of the eccentric causes the lower end of the movable jaw to advance

ON.

FIG. II.

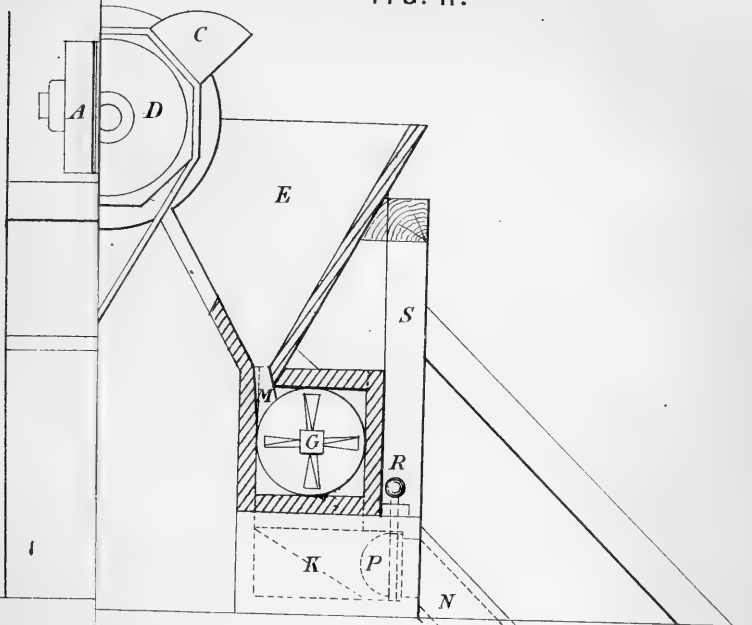

SCALE OF FEET.



DETAILS OF MIXER, IN SECTION.

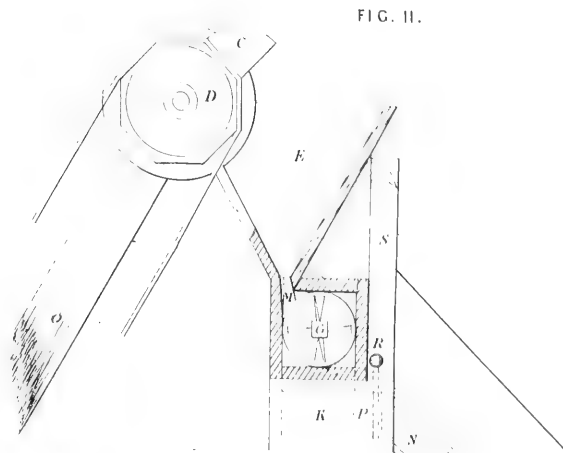
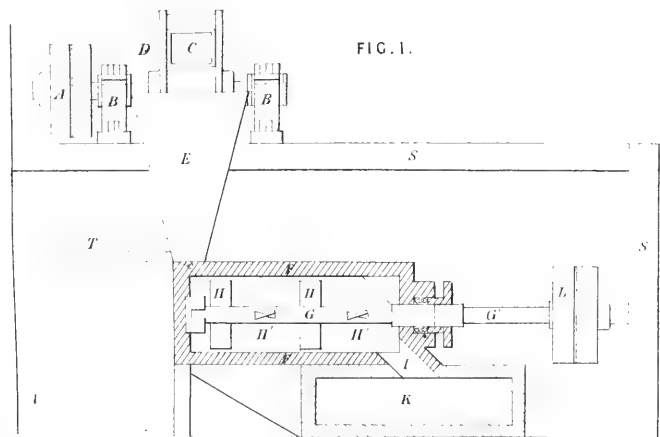
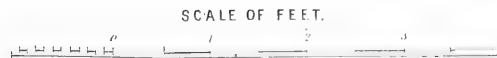
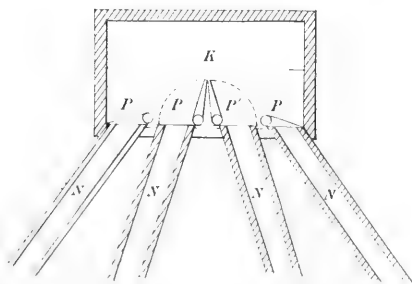

FIG. III.



towards the fixed jaw about a quarter of an inch and return. Hence, if a stone be dropped in between the convergent faces of the jaws, it will be broken by the next succeeding bite; the fragments will then fall down lower and be broken again, and so on until they are small enough to pass out at the bottom. The readiness with which the hardest stones yield at once to the influence of this gentle and quiet movement, and melt down into small fragments, surprises and astonishes every one who witnesses the operation of the machine.

It will be seen that the distance between the jaws at the bottom limits the size of the fragments. The distance, and consequently the size of the fragments, may be regulated at pleasure. A variation to the extent of five-eighths of an inch may be made by turning the *screw-nut* M, which raises and lowers the *wedge* N, and moves the *toggle-block* O forward or back. Further variation may be made by substituting for the toggles GG, or either of them, others that are longer or shorter; extra toggles of different lengths being furnished for this purpose.

This machine is made of several sizes. Each size will break any stone, one end of which can be entered into the opening between the jaws at the top. The size of the machine is designated by the size of the opening; thus, if the width of the jaws be 10 in., and the distance between them at the top 7 in., the size is called 10 by 7.

The following table shows the several sizes of machines which are offered for sale; the product per hour of each size, of fine road metal from the hardest materials, when run with a speed of 250—the power required to perform its duty,—the whole weight of each size, and the weight of the heaviest piece when separated for transportation.

Size.	Product per Hour.	Power required.	Total Weight.	Weight of Frame.	Price Nett.	On Wheels.
	cubic yds.	Horse.	cwts. qrs. lbs.	cwts. qrs. lbs.	£ s. d.	£ s. d.
6 by 4	1½	2½	36 0 0	18 0 0	75 0 0	80 0 0
10 „ 7	3	4	78 0 0	37 2 0	140 0 0	147 10 0
15 „ 7	4½	6	108 0 0	54 0 0	180 0 0	190 0 0
20 „ 9	6	8	156 0 0	74 0 0	240 0 0	255 0 0
24 „ 12	8	12	376 0 0	80 0 0	350 0 0	—

The whole length of the machines (accord-

ing to size) is from 4 to 10 feet ; the height being 5 to 8 feet ; and the width 3 to 5 feet.

The machines may be driven by any power less than that given in the table, and yield a product per hour proportionally.

These machines may be set in one minute, to give the product any size from 2 inches, for road metal to fine gravel.

The product of these machines per hour, in cubic yards of fragments, will vary considerably with the character of the stone broken. Stone that is "*granular*" in its fracture, like granite and most kinds of sandstone, will pass through more rapidly than that which is more compact in its structure. The kind of stone being the same, the product per hour will be in proportion to the width of the jaws, the distance between them at the bottom, and the speed. The proper speed is 200 to 250 revolutions per minute, and to make good road metal from hard compact stone the jaws should be set from $1\frac{1}{4}$ to $1\frac{1}{2}$ inches apart at the bottom. For softer and granular stone they may be set wider.

These machines can be fitted with a screen, as shown by fig. 1, when it is required

to assort the crushed stone into different sizes.

The Howell-Hannay Mill.

The mineral, having been reduced to the size of gravel by the crushers, is next to be subjected to the action of one of these centrifugal mills, constructed upon the principle of reducing quartz, stones, fossils, and other refractory substances of a similar kind to fine powder by percussion—that is to say, by the sudden check of the momentum of a body moving at great velocity. To this end a closed circular chamber is provided, and set in either a vertical or horizontal plane. On a shaft in the centre of this chamber is mounted a plate or disc with arms projecting therefrom towards the inner periphery of the chamber, and this periphery, against which the material to be operated upon is intended to be dashed with great violence, is furnished with ribbed or angular surfaces. The material to be crushed is fed in at one side of the chamber (at the centre thereof) by a hopper, and when crushed it is discharged through an opening on the other side, the rapid rotation of the

arms on the central shaft while dashing the material against the ribbed or angular surfaces of the chamber, causing also a current of air to carry off the powdered material at the discharge opening. A general view and details of this implement are shown by Plate 4, in which figs. 1 and 2 represent the side and end elevations of the improved machine. Fig. 3 is a plan of the same; fig. 4 a side elevation of the machine, with one end of the crushing cylinder removed to show the construction of its parts; fig. 5 is a plan of the interior surface of the cylinder; fig. 6 is a modification of the same; and fig. 7 represents a section through the arms in the line $x x$ of fig. 4. $A A$ are two supporting beams, on which are erected four upright standards B , two on either side, connected together at top by beams C , these being in turn connected and braced together by cross rails D , on which are secured bearings E , in which is supported a revolving shaft F . On one end of this shaft is mounted an armed disc G , and on the other a driving pulley H . The disc G is enclosed by a casing I , consisting of a cylinder J , and end-caps or covers K and K' . In the arrange-

ment represented in the drawing the cylinder J is armed on its interior with ribs, which may be either of a triangular form, as shown in figs. 4 and 5, or formed of pyramidal teeth, as shown in fig. 6, or they may be made in any other suitable form. Instead of teeth the inner surface of the cylinder may be left smooth, but the inventor prefers to use the teeth. The casing 1 thus constructed is firmly and permanently secured to the frame of the machine by means of screw bolts *a* and nuts *b*. On the end κ next the frame of the machine, and at its centre, is cut an opening, through which the shaft F passes, whilst in the outer end κ^1 of the cylinder, and at its centre is cut another circular opening *d*, but of larger size, for the purpose of feeding the machine with the quartz or other material to be pulverized, for which purpose a hopper of suitable shape and dimensions is attached to the machine. At or near the inner periphery of the cylinder there is cut through the inner end or disc κ of the casing 1 another opening, to which is secured a carrying tube L, through which is forced by the current of air engendered by the rotation of the arms, the pul-

verized quartz or other substance as fast as produced, and by it conducted wherever desired; or the spout may be let into the cylinder direct if deemed expedient. In this instance the arms, for the purpose of strength and to lighten as much as possible their weight, are represented as being cast on a disc G, which tapers from the shaft F outwards, but if desired they may be cast on a hub, or in any other suitable manner consistent with strength, and they may either be made straight or curved. The disc on which they are cast (when a disc is used) may also be made in any suitable form consistent with the purpose for which it is intended to be used. On the inner surface of the cylinder ribs or teeth are formed, having the plane of their face set at right angles to the direction of the quartz or other substance as it is projected from the beaters or arms, under which circumstances they may either be made to run straight across the cylinder, as in fig. 5, or be cut somewhat of the form represented in fig. 6, so that the whole momentum of the quartz or other substance may be checked at once. As to the arms themselves, they may

be set at such angle to the shaft, and made in such form, curved or straight, as may be found best adapted for the most perfect execution of their work. In order to make the casing of the arms perfectly tight and strong, the ends or caps κ κ' are made to fit tightly over its ends, and the whole is then bolted firmly to the frame, and if deemed expedient for this purpose, a strip of lead, india-rubber, or other suitable material may be inserted between them.

The operation of the machine is substantially as follows. The quartz or other material, broken to a suitable size, is fed in by hand, or by means of a hopper, through the opening in the outer cap κ , when it is driven with great force and velocity by the arms or beater c of the disc G against the cylinder J , toothed or otherwise, and there reduced to powder, such parts as may not have been completely pulverized rebounding back, and being again projected by the arms against the cylinder until perfectly reduced. The pulverized material is carried and discharged by the current of air engendered by the rotation of the arms (or by other means suitably arranged

for that purpose) through the tube L, and by it conducted wherever desired. If required, the cylinder J may be made to rotate to increase the speed in the opposite direction to the arms, in which event the machine would require to be suitably constructed for that purpose. It may be driven by a number 19 pulley. The frame of the machine is represented as being made of wood, but it may be of iron. The rest of the machine is made of iron, the face of the arms and teeth being chilled.

To render this machine effective, it must be rotated with great velocity, say from one to two thousand revolutions per minute, according to the diameter of the machine; and for this purpose a power of twelve to fifteen horses is required.

The cost of a machine complete is from £80 to £100.

CHAPTER V.



THE PLANT.

A PLANT for the manufacture of fertilizers comprises numerous pieces, each of which should be constructed and arranged with a view to durability and facile management.

Manual labour being a capricious, and time an important element of cost in evolving the products, this consideration is indispensable to the economy of their manufacture.

In other words, the apparatus must be made throughout of the best materials and workmanship, so as to save oft-recurring outlay for repairs, and also be as nearly automatic as possible in order that it may move by steam-power, and do work quickly with the least possible personal attention.

The pieces about to be described are those of general utility, and which constitute the actual requirements of a proper equipment.

The supplementary apparatus pertaining to special processes will be set forth in their proper places.

The Steam Boiler and Engine.

The power of these implements must be according to the amount of work which they are to do. In all cases, however, it is much more economical and convenient to have them rather above than below the exact capacity which may be required. The expense of a large boiler is very much less, proportionally, than that of a small one.

Boiler power of 40 to 60 horses is a none too liberal allowance for a large factory which may require much steam for other purposes besides driving the engine. Even for a manufactory of moderate extent the boiler should be of 25 horse-power, and the engine of 12 to 15 horse-power.

In all cases, a smoke-consuming arrangement should be attached, so as to facilitate the burning of the fine and cheap coal dust.

The Roasting Furnace.

This is a reverberatory furnace with a

broad bed for roasting those mineral phosphates which may contain sulphur, pyrites, and much organic matter. Its position is shown at P on the ground-plan, plate 16. The preparation of the raw phosphate in this manner economises acid and saves time as well as labour in the subsequent operations.

A furnace, 16 feet long and $13\frac{1}{2}$ feet broad, with an arch of the mean height of 2 feet from the bed, will have the capacity for roasting three tons of raw mineral at each charge; and four to six charges may be completed in twenty-four hours.

The Platform and its Accessories.

This arrangement is shown by Plates 5, 6, and 7, and comprises a platform, an elevator, a lift, an acid reservoir, and a mixer.

In the drawings, which are actual construction plans to a scale, the side walls of the buildings are shown at A A, and the roof at B, C being a floor for the convenience of the workmen.

The platform is seen at D, and is a strong timber work supporting the acid reservoir v and the mixer b, in connection with the ele-

DIGESTER OR SOLUTION VAT

Plate 8.

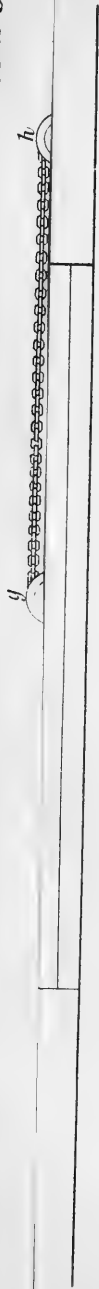

ELEVATION.

Inches



P L A N



DIGESTER OR SOLUTION VAT

Plate 8.

FIG 1.

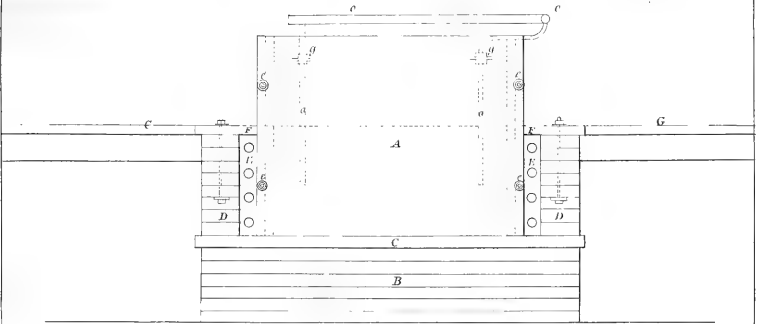
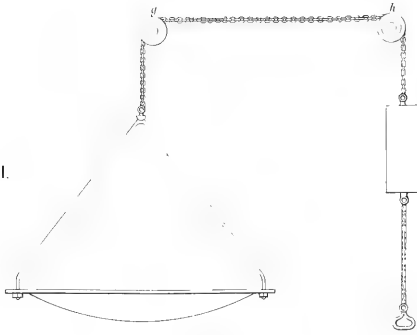

ELEVATION.

FIG 2.

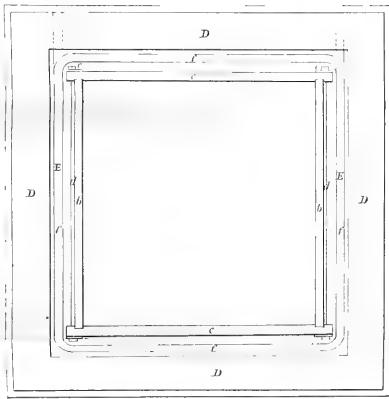

PLAN

FIG 3



SCALE OF FEET



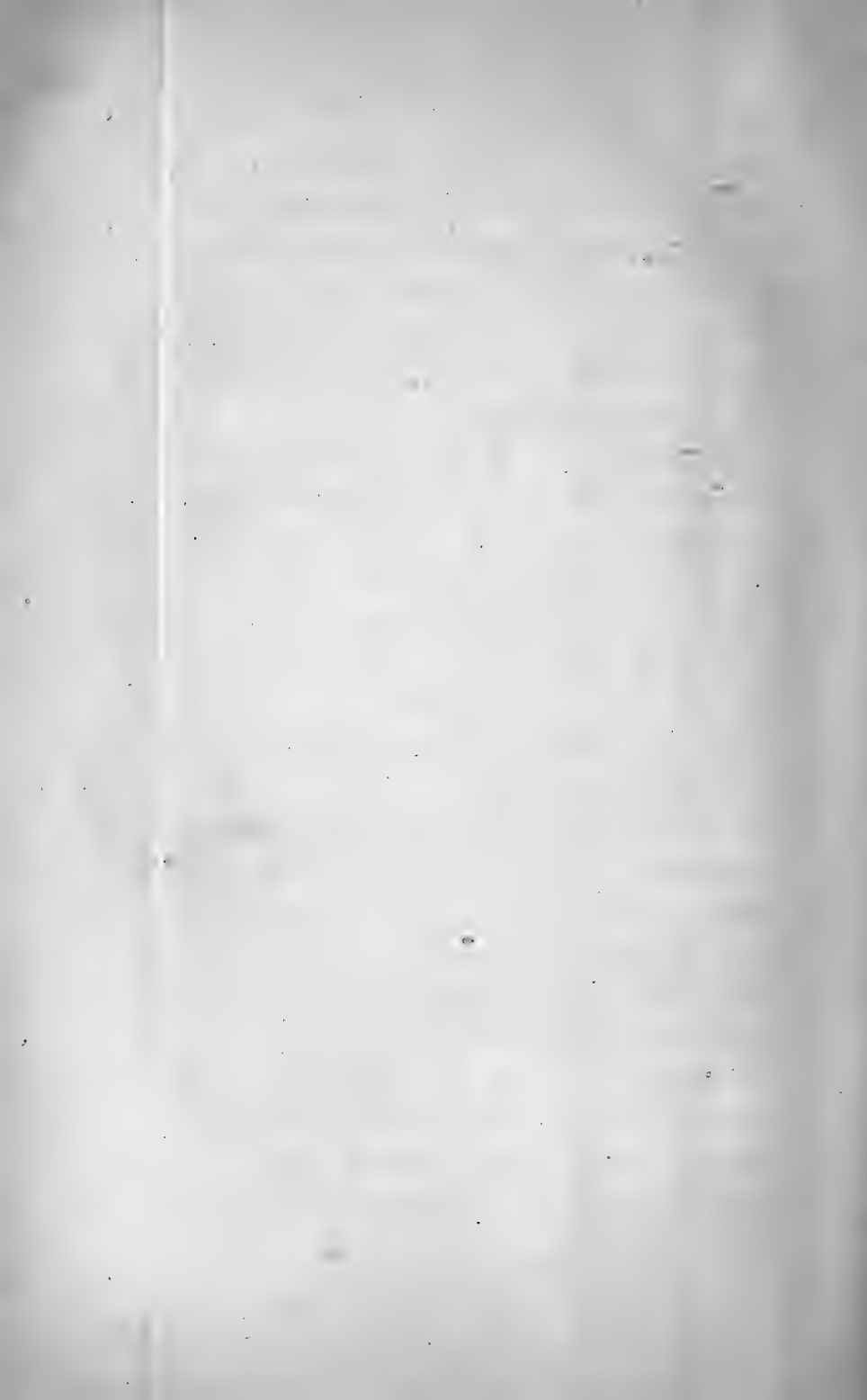

vator *a a a* and the cage *u*, which brings up the carboys of acid to the reservoir. The vertical guides for this lift are shown by *t t t*, and the gearing to hoist it by *w w*. The gearing *x* works the elevator, and the main shafting *y* hung to the roof of the building drives all the machinery.

The platform *o* should be enclosed by a strong railing to prevent accidents; and communication between the ground floor, it, and the floor *c*, must be established by means of a stairway with broad steps.

The Elevator.

This is to carry the powdered mineral from the floor to the mixer *b*. It is an endless flexible belt *a a* passing over a pulley at each extremity. A screw arrangement is for increasing the tension of the band in case this latter should become slack. Motion is communicated by the counter shaft *x* driven from pulley on main shaft *y*.

The belt being put in motion, dips up the powder from the floor beneath by means of the galvanized iron scoops or cups *n n n*, which, as they return downwards, drop it into

the hopper of the mixer *b*, where it meets the diluted acid, issuing in a graduated stream at the same time from the reservoir *v*. At this moment the powder and liquid are thoroughly intermingled by the revolving spindle of the mixer and its blades preliminary to passing down by gravitation through the shoot *c* into the stone vats beneath.

The Lift.

The lift is for hoisting the carboys of acid to the tank or reservoir *v*. It is fixed to the rear of the platform, and consists of two cages *u u*, sliding between strong vertical guides *t t t*, and worked by the gearing *w w*, driven direct from pulley or main shaft *y*.

While one is taking up the full carboys, the other is carrying down the empties.

The reducing gear *w w* serves to diminish the speed and increase the power derived from the main shaft; and there are three pulleys, one narrow and fast, and the other two broad and loose, driven from the main shaft by one open and one cross belt. By shifting the position of these belts, so that

one or the other is upon the narrow pulley, the motion is reversed.

The whole of this driving arrangement is fixed conveniently to beams carried by the roof of the factory building.

When dilute acid is to be used, it must be first emptied into a reservoir in the ground beneath, and thence pumped up by means of a pump constructed of lead and gutta-percha. This more convenient mode of hoisting is less applicable to *strong* sulphuric acid, which should be raised in carboys.

So also hydrochloric acid, on account of its corrosive qualities, must be raised in carboys or by means of the monte jus.

The Acid Reservoir.

This is a tank for holding the charge of acid which may be required for an operation. It consists of a wooden case *v*, lined with lead for sulphuric acid, and coated, inside and outside, with stearic pitch for hydrochloric acid. Such linings are necessary as protection against the corrosive action of the acids.

There should be two adjoining. The tops of the reservoir are level with the cage *u* at its

highest point, so that when the lift brings up the carboys they may be moved readily on top of *v*. Then they are turned over, with their necks in the charging hole, so as to avoid any escape of fumes. As soon as a carboy is emptied, it must give place to a full one, until the reservoir is charged. The acid is drawn from the reservoir by means of a stone-ware tap. A suitable one, with bracket for fixing it in any convenient position, is made by Barnett, of Hoxton, London, and shown by figs. 1 and 2. The tall stem *A* is a pipe of lead or hard vulcanite connected with the acid reservoir, for the passage of the acid; but a glass or vulcanite ball *D*, upon which a regulated pressure

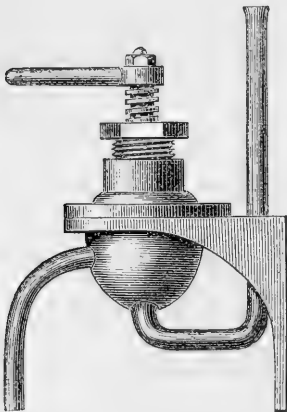

Fig. 1.

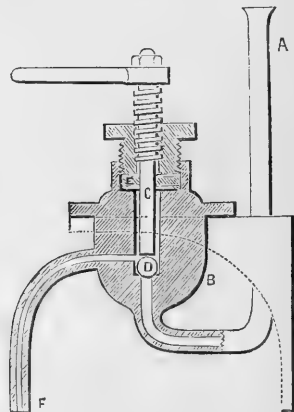

Fig. 2.

is applied by means of the screw and handle c, lessens or stops the flow, as required.

By turning the handle so as to loosen the screw, the pressure of the acid forces up the ball D, and the liquid passes through the outlet F. In like manner by screwing down the ball, the outlet is closed. The packing E is made of felt.

The body B of the tap may be made of lead, vulcanite, or stoneware, according as the tap is intended for the use of sulphuric or hydrochloric acid.

This form of tap is not only cleanly and convenient, but very much less liable to become loose than any other kind.

It were better to avoid the use of metallic nails in the construction of this reservoir, on which account the joints should be dovetailed and fastened with marine glue. The planks should be an inch and a half thick, and to give strength to the whole it must be bound with wrought-iron hoops or bands held tight by a coupling-screw arrangement at the ends.

The Mixer.

This is a wooden box, painted inside and

outside with the protecting pitch already mentioned. It is shown in place by *b*, Plates 5 and 6. A sectional view of its details is presented by Plate 7, and the description which follows will be in connection with this latter drawing.

The sides of the box are *FF*, and fitting into the top of this box is the hopper *E*, which receives the powdered mineral as it falls from the scoop cups *c* of the elevator. The acid enters the mixer at the base of the hopper *E*, through the wooden pipe *T*, coated internally with the protecting pitch just prescribed, and connected with the reservoir. The fast and loose pulleys *L*, drive the spindle *D*, which carries the blades.

The spindle *G*, of the mixer, is made of very hard and tough wood, and has four blades *HH*, passing through it. They are set at right angles to each other and at an angle with the axis of the spindle, as shown at *H'H'*. By this means they move like a screw, and force the mixed mass through the passage *I*, into the collecting-box, whence it passes through the shoots *NN*, into the vats or receptacles beneath. This collecting-box

may be omitted, and then the wet mass will fall directly from the mixer into the vats. The number of diverging shoots should correspond with the number of vats to be fed, and each one must lead into its special vat or receptacle.

The passage from the hopper to the mixer is seen at M; and a semi-circular wooden valve P, working on a spindle R, closes the openings of the shoots at will. These are better shown in fig. 3 (Plate 7), which is a plan of the collecting-box, with its top removed to expose the valves P P P' P', of which two (P P) are represented as closed, and two (P' P) as open. All the parts should be covered with a protecting coating of the stearic pitch.

The Digester or Solution Vat.

The next implement to be installed is the stone vat in which the raw mineral is to be acted upon by the hydrochloric acid. It is shown by Plate 8 as constructed of flagstones; but any other material will answer which is proof against the action of acids.

It is placed on the ground in advance of the elevator, and should constitute one of a row or series of ten.

The drawing shows the whole arrangement in front, elevation and details.

The form is that of a square box A, mounted upon a support of mason-work B, which rises from the ground about 18 inches. Each of the ends and sides, as well as the bottom, must be of an entire piece of stone without crack or fault. The bottom piece is large enough to cover the whole surface of the support B, which extends 16 inches beyond the circumference of the vat, in order to form a broad base c.

The bottom piece c, is to be thicker than the sides and ends *b c*, and these latter are set into the former by means of a nicely-fitting groove cut around at about 12 inches from the circumference. In like manner, the ends are adjusted to the side-pieces by means of similar grooves in proper places.

The front and back sides *c c'*, are 4 inches larger than the ends, in order to be grooved for receiving these latter. All the joints are first sealed with Portland cement or plaster of Paris, and then covered with a layer of stearic pitch. The whole is held firmly together by the strong iron bands *d d*, with screw-nut ends *e e*.

The bottom stone is 7 feet 8 inches square. The side and the end pieces have each a height of 4 feet; but the length of the former is 5 feet 4 inches, while that of the latter is only 5 feet. This gives a clear capacity of about 100 cubic feet to the vat, which is sufficient for the treatment of one ton of raw mineral and upwards at each operation.

Surrounding the vat proper, and built up 2 feet from the base *c*, is a brick wall *D*, forming an enclosure of 4 inches diameter throughout, to act as a hot-air chamber *E*. This brick enclosure is to be capped with a thick flag-stone *F*, laid level, and kept firmly in place by means of cement and iron screw-bolts set into the brick-work.

In the air-chamber, and surrounding the stone vat, is a circuit of iron tubes *ff*, for the circulation of a current of steam, in order that heat may be applied during the process of digestion. These tubes should be coated on the outside with a thick priming of oxide of iron paint, and then with a layer of stearic pitch to prevent rusting.

Each vat is fitted with a cover made of cast

iron plate and protected with paint and pitch, as just mentioned. To facilitate its movement it is hung upon pulleys, as shown by *g*, *h*, *i*, with the handle of the chain in reach of the workman, and high enough to allow convenient stirring of the contents of the vat as may be necessary.

At the rear of the wall and coinciding with the top *F* of the air-chamber, there is a strong wooden platform *G*, to facilitate the stirring of the contents of the vat and removing refuse matter.

The surrounding hot-air chamber of the vat may be dispensed with, and the whole structure reduced to a simple stone box by incurring some extra expense in the first instance for platinum heating tubes *AA*, figs. 1 and 3 of the Plate. They should dip directly into the contents of the vat, and are therefore adjusted by a screw-coupling attachment *g g*, to the steam-fed pipe *o*, above the vat. To economize the expense, the lower parts *h*, of the platinum tubes need only be 30 inches long, as the parts *r*, above the coupling, are iron elbows. These tubes are made by Benham and Froude, Chandos Street (W.), London.

A tube of $1\frac{1}{2}$ inches diameter, and sufficiently stout for this purpose, will weigh 14 pennyweights to the running inch, and cost 17s. 6d. for that length, or £10 10s. per linear foot.

Plain iron tubes, covered inside and outside with hard vulcanite, as prepared by Cow, Hill, and Co., Cheapside, London, may be made to serve in place of those from platinum, but they require more care in the handling. These hard India-rubber coverings will resist the strongest hydrochloric acid, either hot or cold, and even hot oil of vitriol. Steam heat softens them so slightly as not to affect their usefulness in any great degree.

The weight of the vulcanite coverings would be four pounds or less per running yard, and their cost about 3s. 9d. to 4s. per pound, including workmanship.

Porcelain-lined iron tubes, when the enamel is free from lead, arsenic, antimony, or other ingredient which may render it destructible by acids, or easily worn away, are very excellent substitutes for either of the preceding. They are both cheap and cleanly. T. and C. Clark and Co., Wolverhampton, manufacture this kind of ware in very superior quality.

The direction of currents of steam immediately into the vat affords facility of regulating the temperature of the digestion and rousing the contents by a "blow up", as may become expedient or necessary.

As platinum resists the action of acid, there is no wear and tear of these tubes, and the expense of using them is only the annual interest on their first cost.

These screw-coupling attachments allow them to be moved at will, and thus two or four tubes may be made to serve for heating and stirring a series of twelve vats.

The charging of the vat with the materials for a digestion is done in two ways according to circumstances. When the powdered mineral and acid are to enter in a mixed, moist state, the vat must be charged by means of the lift elevator and mixer (Plates 5, 6, and 7). On the other hand, if the materials are to go in separately, the charging is more conveniently effected from the platform G, Plate 8.

To charge the vat from this platform with acid, the latter must be brought in carboys to the side upon a trolley (Plate 9) of wood.

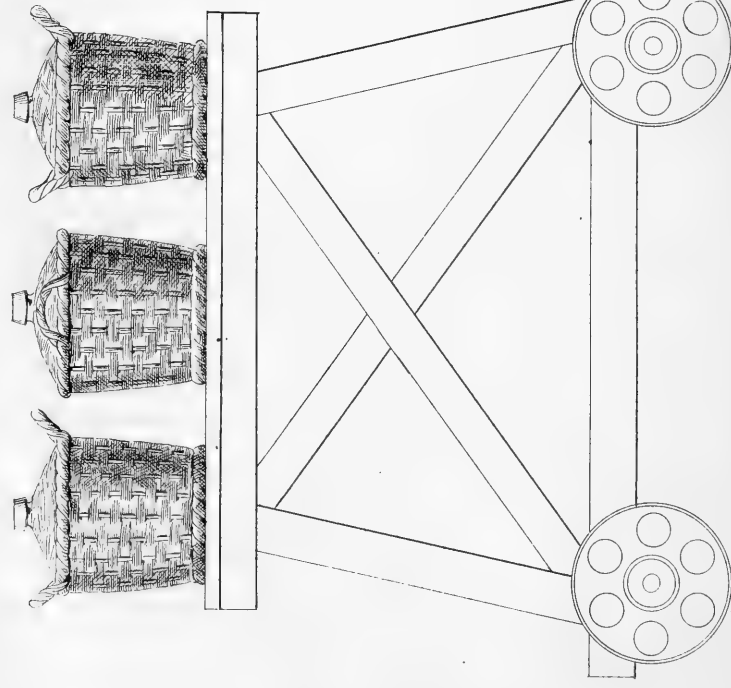
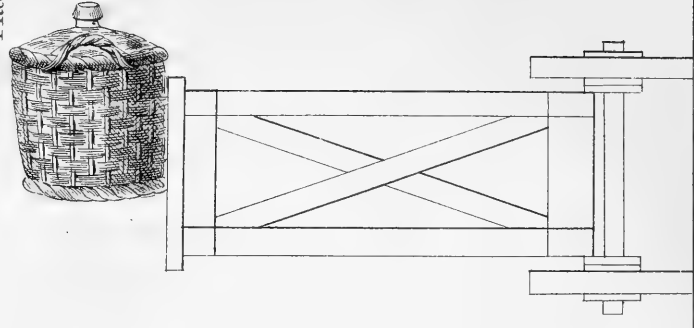

Plate 9



THE TROLLEY.

SCALE.



The platform of this trolley corresponds in height with that of the vat.

The Syphon.

The liquor of the vat, when clear, is drawn off from the settlings or insoluble residue, by means of a syphon; because it is inconvenient to fit taps to the sides of a stone vat. The most convenient form of this apparatus for large operation with acid liquors, more particularly when hot, is that designed by Mr. Harrison Blair, and shown by fig. 3.

It consists of an iron tube, bent in the usual form, and with one leg longer than the other, but at the highest point of the arch there is a projecting tube which connects with a circular tight box *a*. To the lower part of this box is fitted an India-rubber tube, at the other end of which is a bucket *b*. The syphon being set with its short leg in the clear liquor of the vat, so as not to disturb the settled solid matter, and having its longer leg dipping into the liquid contained in the trough which is to lead the filtrate liquor away into a separate vat, the bucket is then to be filled with water and raised above

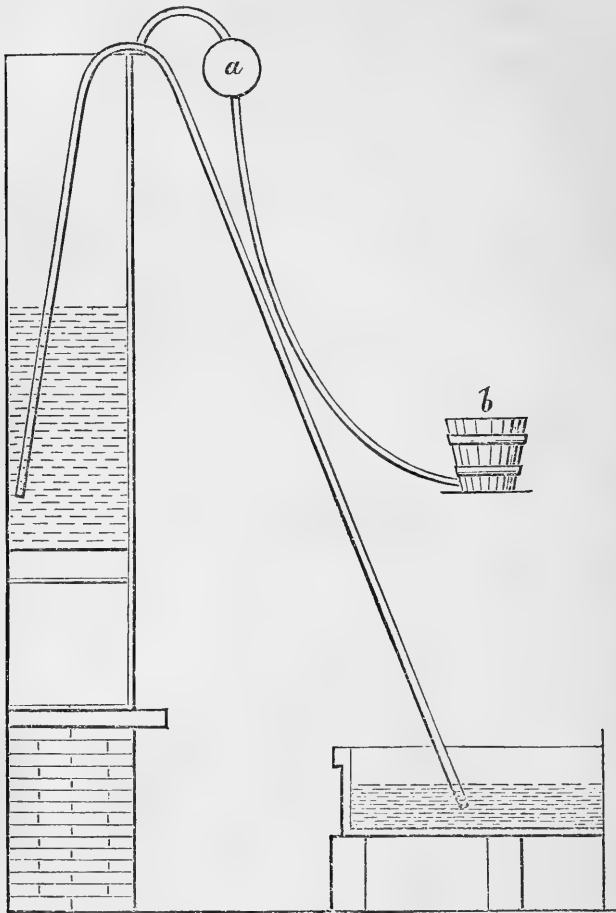

Fig. 3.

the level of the box *a*. The water naturally passes then from the former to the latter; but now, on lowering the bucket *b*, it returns, forming a partial vacuum in *a*, and the air is drawn out of the syphon. This arrange-

ment is at once clean, convenient, and suitable for acid solutions, whether hot or cold. Moreover, it is without risk to the workman.

The Monte-jus.

When the solution liquor has been drawn off by the syphon from the digestion vat into the reservoir in the ground, it requires to be mounted into another vessel for the next operation. The reservoir is constructed, therefore, as a monte-jus.

This piece of apparatus is substituted for pumps whenever the liquor to be raised from the lower to an upper vessel is too bulky or too corrosive to be pumped up. Its arrangement is shown by Plate 10.

For this purpose, it may be made of cast iron as to the reservoir part s, and the top r. This reservoir is a mere round cylinder, with its top and bottom fitted to it by means of screw-bolts and india-rubber washers, so as to form air-tight joints. Before it is set into the ground its whole exterior and interior must be primed and coated first with oxide of iron paint and then with stearic pitch.

At the top there is an iron tube c, protected

as above, or, better, lined with gutta-percha, for conveying the liquor of the digestion-vat from the tube-gutter into which the syphon drops it.

The exit pipe A, similarly constructed, delivers the contents of the monte-jus wherever it may be directed.

In order that the confined air may escape when the monte-jus is being filled, there is a vent tube F.

As just explained, the reservoir is charged through the tube c, and when nearly full the taps c' and F' are closed so as to form a hermetic chamber. The air-pump attached to the pipe D is then set in operation, so as to compress the air above the fluid in the closed chamber s. The tap on the end of the tube A being then opened, the fluid mounts and passes on to its destination, under the pressure thus applied to its surface. High pressure steam may be used instead of the compressed air of the air-pump.

These implements as well as pumps are made by the engineers who do the work for soda manufactories.

Gutta percha and other kinds of pumps

for mounting acids are made by A. Lerverd et Cie., 218, Faubourg St. Martin, Paris; W. Neill and Sons, Bold, St. Helen's Junction, Lancashire; and John Cliff, Runcorn, England.

The Precipitation Vat.

This is the vessel into which the monte-jus delivers the acid solution, in order that it may be treated with a precipitant for the recovery of the phosphates which it has dissolved from the raw mineral. It is placed upon a strong base, at an elevation of twenty feet,* so that its contents may be drawn off when required through taps and gutters, by natural descent, into the receiving vessels beneath. There should be a pair of them at least. Plate 11 shows this vessel A as resting upon its brickwork support B. It is a large rectangular box made of thick wooden planks, and bound round with wrought-iron clamps *d*. These clamps or hoops are joined at the ends by a screw arrangement, fig. 3 of the Plate, so that they may be adjusted tightly by a nut connec-

* By a mistake, the drawing (Pl. 11) shows this base to be only two feet.

tion. Behind and near the bottom is a small manhole of about six inches diameter, as an outlet for the solid precipitate. Above it, but in the front of the vat and at a distance of ten inches apart, are other openings, *b b b b*, fitted with tampons, *c c c c*, for drawing off the supernatant liquor as may be required.

The plug portion of the tampon is made of india-rubber, and has a hole through its centre in order that it may pass over the end of its handles. This latter is a wrought-iron rod with a screw cut and nut at the lower end for fixing the indiarubber plug tightly in place. Fig. 4, Plate 11, shows the tampon separately.

Though it is not absolutely necessary for this vat to have a protecting coating, it would be better to paint it over with the stearic cement aforementioned, as acid liquors injure wood sooner or later.

The heating and stirring of the contents are accomplished, when required, by means of steam-currents. For this purpose there are tubes *s s s*, dipping into the vat. They are attached by coupling-screws to the feeder, which is a large tube *a*, leading from the steam-boiler of the factory, and firmly fixed

to the wall at the rear of the vat, and just above its top. The smaller dip-tubes *s s s*, are made movable because they require to be cleaned frequently of the rust which may form on them; but the better way would be to have them porcelain-glazed on both inner and outer surfaces.

An enlarged view of the coupling-arrangement is shown by fig. 5, Plate 11.

This precipitation vat will serve very well for all ordinary operation, but in cases where it is desired to wash the precipitate wholly free from its mother liquor, and rapidly, then it would be expedient to employ one of the two forms of apparatus (Plate 17 or 22) described for special purposes in Chapters VIII and XIV. By means of their vacuo-filter arrangement a large volume of precipitate may be cleaned in a short time.

The Drying Kiln.

These kilns, shown by Plate 12, are in pairs generally, and should adjoin the evaporating pan, in order that the contents of the latter may be drawn into them conveniently, when required. They are to give the

final drying to the precipitate when it is to be sent into the market, either as precipitated phosphate, Colombian phosphate, or Colombian fertilizer. The pulp from the precipitation vat is led directly into the kiln by means of a movable connecting gutter. Fig. 1 on the plate shows a sectional elevation of this kiln. Its form and construction are much after those for drying white lead. The basin portion is about 12 inches deep, and should be well lined with the best hydraulic cement and a coating of plaster of Paris. The bed of the basin, as well as the furnace portions, are to be built of smooth fire-tiles and bricks.

In order that the heat may be distributed uniformly, so as to insure a moderate temperature, the flues are arranged as shown by fig. 2 on the plate, which is a sectional plan along the lines A and B.

The Wash Vat.

This vessel is that in which the liquor from the precipitated phosphate is drawn, and therefore it must be placed with its top below the level of the bottom of the precipitation vat. This position allows the liquor

of the upper vat to be drawn into the lower through taps or by means of a syphon, with the least possible delay and labour. It is the exact counterpart in all other respects to the precipitation vat, described at page 127; that is, it is constructed of the like material and has corresponding dimensions. There should be a pair of them, side by side, or rather end to end.

The Evaporating Pan.

This may be made either of steel-plate, cast-iron, or sheet-lead, and is usually set with a duplicate. They receive the clear liquors which are drawn off from the precipitation and solution vats, in order to concentrate them to the crystallizing point or evaporate them to dryness. Plate 13, fig. 1, shows a range of these pans: A being the pan portion, B the fire-door, C the ash pit. The whole is supported by masonry, that part where the front of the pans rests being a dome of fire-brick.

The steel pan is almost 18 inches deep. The manner in which the flues are to be built is explained by fig. 2, Plate 13: B being the

fire-grate of the furnace, and A' A' A' the brick walls, which form the channels for the distribution of the current of heat throughout the bottom of the pan which rests upon them.

If the pan is of sheet-lead there must be an intervening iron plate between it and the top of the walls A' A' A', both as a support and protection for its bottom.

An iron stairway affords the facility to the workman of mounting to the top of the pan, as may be necessary for observing the operation and attending to it.

Mixing Machines.

When the fertilizer prepared by either of the processes hereinafter described, has reached the dry state, it is more or less lumpy; and for the purpose of reducing it to powder of uniform fineness, and frequently also of associating it with other substances, it must be passed through a mixing machine. The comparatively loose texture of the mass renders this operation both simple and rapid with a suitable implement.

The machine in most general use, and which does its work very satisfactorily, is

that known as Thomas Carr's Patent Disintegrator, made by the inventor at Bristol, England. My opinion, however, is that the Howel-Hannay centrifugal mill, already described and recommended in Chapter IV for powdering the raw mineral, will serve at the same time, and most advantageously, all the purpose of a mixer. Such a utilization of one machine for several different operations will therefore promote economy of both plant and space. The Howel-Hannay machine prevents all loss by escaping dust, and makes a powder of great fineness, whilst that of Carr produces a granular powder.

Carr's Disintegrator.

This apparatus is the invention of a gentleman who has become distinguished for his practical genius in mechanical engineering. It is shown in two views by Plate 14; fig. 1 being a section elevation of side, and fig. 2 a front elevation, with front plates and front standard (A) removed.

The iron disc *b*, cast in one piece with a tube *b'*, which works on a wrought-iron shaft *c*, carries the wrought-iron or steel rods

a^2 , which connect it with the annular disc a^1 . About a dozen of these rods are made longer than the others, and fasten the cast-iron disc a , which carries a second series of bars revolving in the same direction as the first. Connected with this is also a series of breakers a^6 and d fixed at their extremities by the ring d' . These latter are of a strong flat section, and serve to break the larger lumps which would not pass, otherwise, through the bars of the cage.

The cast-iron disc c' firmly keyed to the main shaft c , and driven by the pulley b^9 , revolves in a direction contrary to the one just described, and carries two series of bars a^4 , secured at their extremities by rings.

The hollow shaft b' , working on the solid spindle c , is retained in proper position by means of the bearings at each extremity. As to this part, b^5 represents two blocks of gun-metal bored to fit the shaft, and secured by means of the cup b and nut and bolt b^7 .

The solid shaft runs at each end in gun-metal bearings of ordinary form, carried by the standard Λ , cast in one piece, with the bed-plate Λ . A casing of wrought iron Λ' , en-

closes the whole for the purpose of confining the pulverising material. As it is thrown off radially from the machine, the wooden sides *yy* of the casing are made almost to fit the larger disc.

A perspective view of the machine in place is shown by Plate 15, which exhibits the method of feeding it, and also the arrangement of the driving-belts; that one of these latter on the fixed spindle being open and the other crossed, so as to give an opposite direction to each series of rings.

The machine represented by the plates is that known as the "*new improved 4 feet 6 inches size*", which costs, complete and including patent licence, £120: 10.

The inventor explains the construction of his disintegrator, and the mode of managing it, as follows:—

"It simply consists of a series of four strong cylindrical iron cages, of various sizes, formed of bars with open spaces of from 3 to 4 inches between them, arranged concentrically one within another, around or parallel with the shafts or axles, and rotated therewith with extreme rapidity (from 350 to 450 revo-

lutions per minute), in contrary direction to one another, by means of an open and a crossed strap; the first and third cages rotating to the right, and the second and fourth to the left, so that, while there are only two motions in reality, yet from the way in which the cages intersect one another, there are relatively four.

“ The material is thrown in at the central orifice either by shovels or elevators, and after the lumps, if very large, are broken by a stationary knife (fixed so that its blade may extend into the interior of the innermost cage, but never used with very hard materials), they are thrown out by centrifugal force from the first cage at a tangent to its circle, precisely as stones are hurled from a sling, and at a speed equivalent to that at which the beaters of the said cage are rotating (which is usually 50 feet per second); when meeting the beaters of the next cage, moving in an opposite direction, usually at 60 feet per second, a collision ensues similar to that which takes place between a cricket ball and bat, the shock thus produced being compounded from the aggregate speed of the beaters, and the speed and weight of the material meeting them. The projectile impetus of the flying material is thereby arrested, and

a fresh impulse given to it in an opposite direction, to meet the beaters of the third cage, travelling the reverse way; and so on in like manner with the fourth one, when, if the material is of a friable and non-fibrous nature, it is shattered by these successive blows into a fine granular powder usually like that of gunpowder, and in less than a second delivered in a radiating shower at a tangent to, and from every portion of, the periphery (like coruscations of the fire-work known as the 'Catherine wheel'), and then arrested in its flight by an external casing of wood or iron enclosing it, and usually formed like the paddle-box of a steamer.

"The power required for the 4 feet 6 inches size varies from 8 to 10, 12, and even 14 and 16 horse, according to the following circumstances: First, the gross weight of material to be operated on per hour; secondly, its hardness, tenacity and specific gravity; thirdly, the degree of fineness to which it has to be reduced; and, fourthly, the speed which must consequently be maintained to accomplish the results required; for, as these four constitute, individually and collectively, a certain amount of work done in a given time, the power to execute the same must necessarily be proportionate thereto, as an adequate

effect can result only from an adequate cause.

“The average speed that the 4 feet 6 inches machines are driven at varies with the above circumstance, from 300 to 400, 500, and even 600 revolutions per minute. Where, however, the engine is deficient in power for the work it is required to do, and it is desirable to increase it by working to the best advantage, great care must be taken not to multiply the speed of the disintegrator too much against the engine, in proportioning the respective sizes of the pulleys, or the engine will be overloaded by the adverse leverage it has thus to contend with, and will therefore not be able to attain its proper speed; whereby its power (deficient as it was to start with) will be still further diminished instead of increased. For the faster the engine runs the more cylinders full of steam (or what amounts to the same thing, the more cubic feet of it) it uses per minute, and therefore the more power it gives out in the time;—provided, of course, the boiler is large enough and has sufficient grate and heating surface to consume sufficient coal and generate sufficient steam to keep the engine running at an increased speed without diminishing the pressure of the steam.

“In driving the disintegrator it will be necessary to have an intermediate shaft, between the engine and it, for the purpose of sufficiently augmenting the speed. This intermediate shaft should be about $3\frac{1}{2}$ inches in diameter, and if driven by straps from the engine or its lay shaft, it should not be immediately above or below it, nor yet directly above or below the shaft of the disintegrator; for, as the weight and sway of a long strap when it partly rests on both pulleys are of great importance in preventing slipping, it follows that the more the shafts are on a level with one another the better; otherwise the lower pulleys will lose the benefit of this weight, which is specially awkward if it happens to be the smaller one. It would do, however, well enough, if a string, stretched from shaft to shaft, made an angle of about 45 degrees with the horizon, and, if convenient to make it more level than that, so much the better.

“The intermediate shaft should also be a good distance apart from the shaft by which it is driven, and also from the disintegrator it drives, in order to give ample length for the straps; for short straps are very objectionable, especially when there is a great disproportion in the sizes of the pulleys: the

large pulley keeping a short strap at too wide an angle for it to embrace sufficiently the circumference of the small one, and give it proper hold on it, whereby it is liable to slip, thereby heating the machine, wearing itself out, and frequently flying off unless kept very tight, which is troublesome, and entails additional friction on the bearings. The following example will give a sufficient idea of what is suitable.—If the pulley on the engine shaft is about 4 feet diameter, driving one on the intermediate shaft 2 feet diameter, it would be sufficient if these shafts were about 9 or 10 feet apart; and if the two other pulleys on the intermediate shaft were also each about 4 feet diameter, driving the small pulleys on the disintegrator; then, as the difference in the sizes is here greater, from 11 to 12 feet between the intermediate shaft and the disintegrator is advisable, and if a foot or two more in both cases so much the better.

“The pulleys will, of course, have to be proportioned to the speed of the engine, so as to multiply it as many times as is required to give the disintegrator its proper speed; only it is advisable that the smaller pulley on the intermediate shaft, that is driven from that on the engine, should be at least half as large again as those on

MONTEJUS.

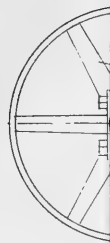

SECTION

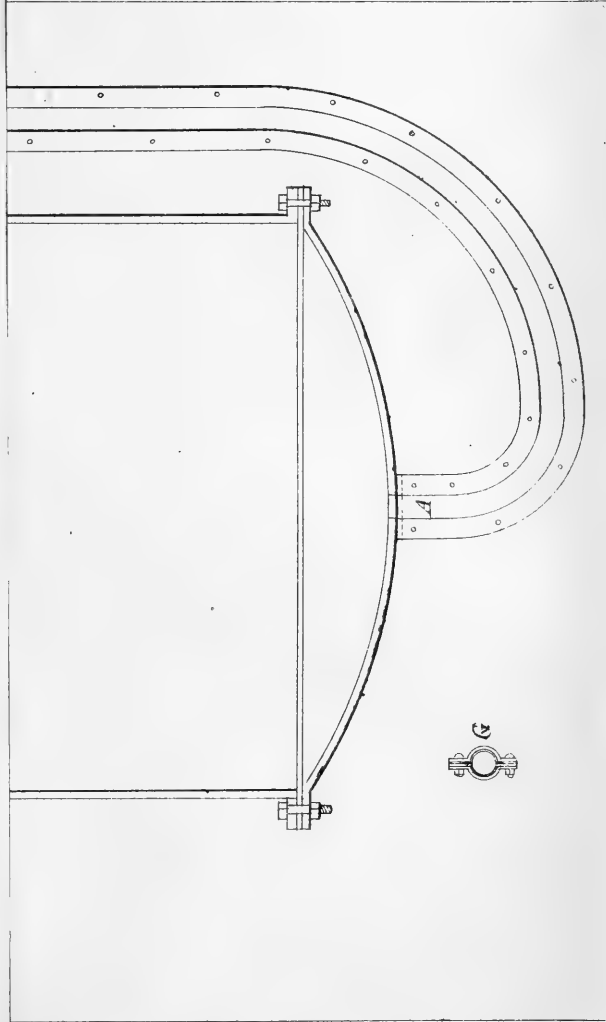

SCALE OF FEET.



MONTEJUS.

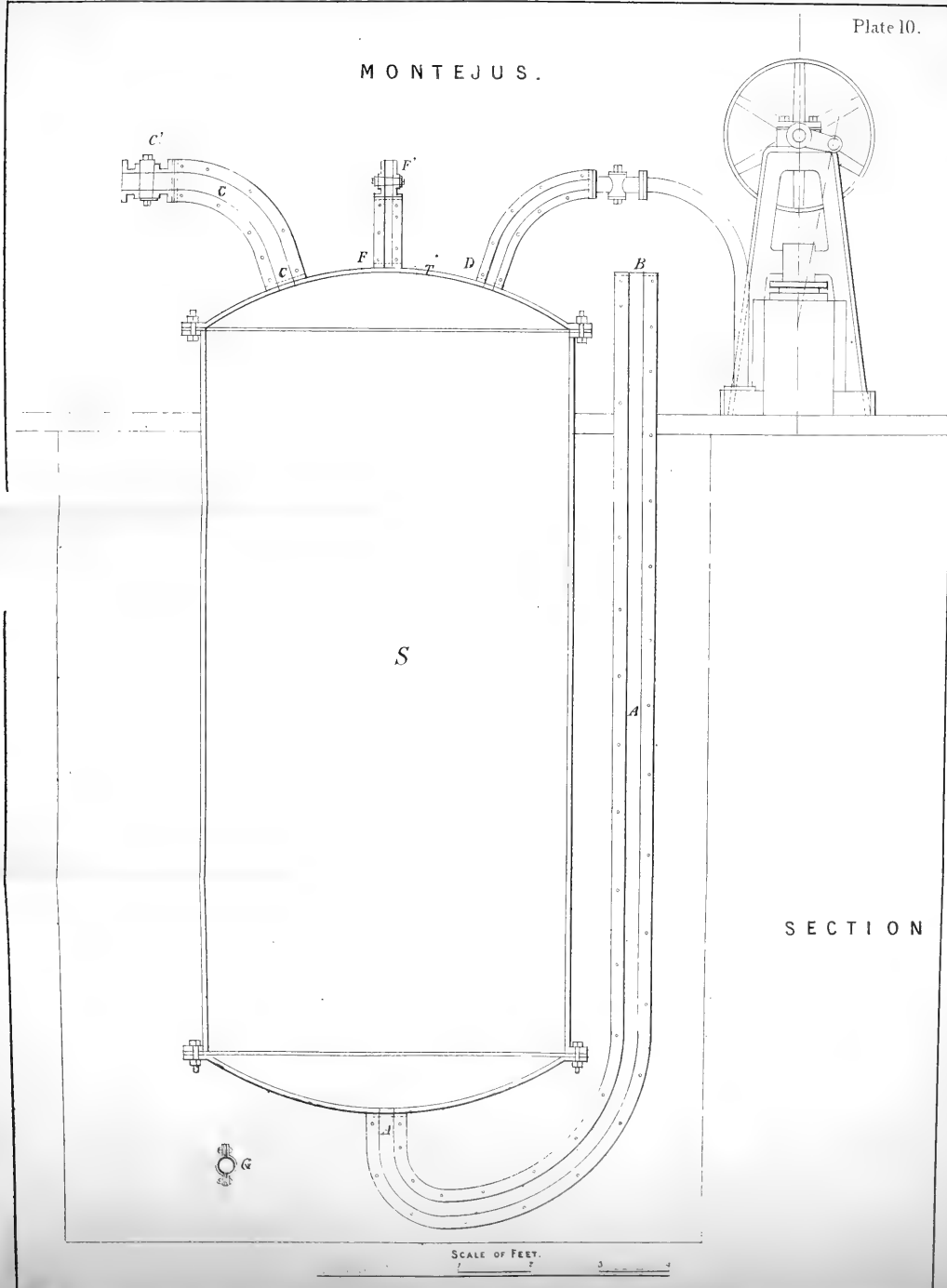

the disintegrator itself, as it has a much harder pull on it; and if the engine is simultaneously employed on other work, it is also very desirable that this pulley should have a loose one of the same size alongside of it, to admit the machine being thrown out of gear without stopping the engine. Of course, in this case, the pulley on the engine-shaft must be made double the breadth otherwise required for the purpose.

“ Thus, having the means of throwing it in and out of gear is especially desirable with the large 6 feet 3 inches machine, the great weight of which makes it awkward to start at full speed, which is readily avoided by slowly shifting the strap from the loose pulley to the fast one, a partial slip of the strap ensuing during the gradual transit, which diminishes the abruptness of the starting.

“ Besides, without the loose pulley, the engine itself, would be found difficult to start with the largest size machine in gear with it; for the power of a single engine on its first half stroke, is nearly wholly expended in giving motion to its own fly-wheel; and if it had simultaneously to start a heavy machine also, and that at a speed very much greater than its own, it would be exceedingly liable to

be brought up when the crank lost its leverage, and came upon its dead centre, its fly-wheel not having attained sufficient momentum to carry it over. Nor is this all, for while the engine is awkward to start when unfreed from the disintegrator, it is under the same circumstances equally difficult to stop it quickly, for the great speed and weight of the large sized one gives it sufficient momentum to powerfully re-act upon the engine when the steam is cut off, and drive it round many more times than its fly-wheel only would have done.

“ The straps should be very stout ones, and if double sewn so much the better. The one to drive the intermediate shaft should be 8 or 9 inches broad, and the two that come from it to the disintegrator should be 7 inches broad. All new straps will be found at first very troublesome, until by use they have ceased to stretch.

“ Stout belts of the same breadths will do as well as leather straps. The cross strap or belt should not be allowed to scrub against itself at the crossing, but should be kept separate by a small iron friction roller between it, $2\frac{1}{2}$ inches diameter and 15 inches long, rotating on a vertical axle $\frac{5}{8}$ in. diameter, supported top and bottom. This would greatly

save the strap from friction and wear, and it is especially desirable when belts are used.

“It is indispensable that the cage should be enclosed in some way by an external casing or chamber, in order to arrest and prevent the too wide dispersion of the material, as it flies out with great force from every portion of the periphery. The shape of it, however, is of no importance so long as it effects this, and also shelters the straps, bearings, and men from the material falling on them, and at the same time admits of the machine being conveniently fed, and the finished material removed. But care should be taken that it is not so restricted that the material may be liable to cake and jam between it and the sides of the machine, thereby acting like a friction-break on it, and involving great waste of power. For it must be borne in mind that resistance caused by any such unnecessary friction here, is multiplied against the engine as many times as the speed of the disintegrator exceeds that of the engine, and therefore becomes very serious. A simple hopper sloping into the machine would be found convenient to guide the material in. The casing should be made to separate, so as to enable the workman to conveniently scrape from it, occasionally, any

material that may have caked against it inside, opposite the bars, between which and the casing there should be a clearance of 15 inches at least, and if double or treble that, so much the better, when the material is pasty.

“With the high speed this machine is driven at, and considering the large amount of work it does, it would be false economy to stint it of oil, especially while new and the bearings not worn smooth and free, and therefore more liable to heat. When working continuously at full speed, from two to three pints of oil a day, if found necessary to keep it cool, should not be grudged, especially while new; and it should be inspected occasionally to see that the brasses do not get injuriously hot.

“When the raw material has not far to be brought to it nor the finished material to be far removed, five men will be sufficient to do fifty tons a day with it: two bringing up the material to it, one shoveling in, and two removing; but with more men, two shovelers, and adequate power, the machine is capable of doing double that quantity. When the materials are hard and of considerable specific gravity, the user must be especially cautious not to throw into a disintegrator of moderate strength solid pieces of an inordi-

nate weight, or he may do more damage to it thereby in five minutes than five years' legitimate work would effect. The knife, with such hard materials, should be dispensed with."

"When a soft and very adhesive material is used, a portion of it will adhere to each bar, but never on the side of the bar which strikes the material, but on the back side of the bar as regards the direction it is moving in. If, therefore, the engine is furnished with reversing gear, and can be conveniently driven occasionally in an opposite direction, the

NOTE.—There is a more modern mixer than Carr's, which, though not known in Great Britain, is spoken of very favourably by the many manufacturers throughout the United States, who use it there. The annexed drawing will give an idea of this machine as constructed by its inventors, Poole and Hunt, mechanical engineers, at Baltimore, Maryland.

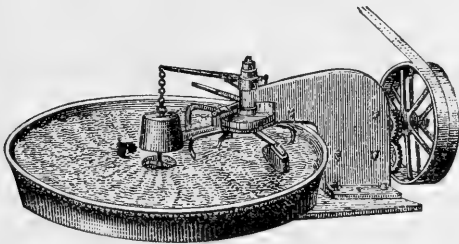

The containing vessel is an iron pan revolving horizontally around a support ; and in this pan a rubbing or

machine will soon clean itself. Or the same might be effected, but with more trouble, by unlacing the straps, and making the cross and open straps exchange pulleys. Or the cleaning may be effected without either of the above plans: viz., by throwing in, while at full speed, a hundredweight or two of any brittle material, such as bone-ash or coprolite.”

mixing apparatus turns about *its* support. In combination with these two parts there is a guiding device for causing the rotation of the pan and mixer to move the mixed material to the central opening in the pan, through which it drops into a conduit or other suitable arrangement for being carried away.

CHAPTER VI.



THE ARRANGEMENT OF THE FACTORY PLANT.

THE ground selected for a factory building should be in an open situation, and convenient to the sources of the raw materials, as well as favourably located for cheap transportation of the finished products. The vicinity of navigable water or a railway station, in a manufacturing centre, is, therefore, the most eligible position.

The factory building must be spacious and freely ventilated, so as to prevent discomforting and unwholesome effects on the workmen from the noxious vapours which are incident unavoidably to the operations conducted therein. As best fulfilling these requirements, the lower part of the building, to the height of 12 feet, may be of mason-work, pierced by numerous windows, the sashes of

which are hung upon pivots; and the upper part wholly of wooden slat-work. The doors should slide on wheels and be very numerous in the front, so that a free draught may be obtained by opening them when the digestions are in progress.

For the convenience and economy of superposing the various implements, so that the contents of the upper may descend step by step and as required, through the series of vessels which are placed beneath, with as little delay and manual assistance as possible, the height of the main apartment should be 35 to 40 feet, and that of the wings and shed 15 feet.

A syphon and several taps may be made thus to save the expense of many workmen, and also to render the apparatus as automatic as possible: an important point, considering the capricious character of manual labour.

Plate 16 exhibits the general construction of a convenient factory, and the relative positions of the several pieces of apparatus.

It consists of two wings, c and G, a central apartment R, and a shed T at the rear.

The left wing has four divisions, of which

the front one *c*, is the office, and the second *B*, an engine room. Back of the latter in *A* are the boilers, while to the rear of all that part of the shed *a* is to be used as the coal and ash room.

The office is subdivided by a sash-work partition, into two parts, in order to furnish a laboratory *c'*, for the analytical and experimental work of the factory. This laboratory must be wholly shut off from the engine-room, so as to protect the latter from the corrosive vapours of the former ; but this need not interfere with the introduction of the necessary steam-pipes.

The ventilation may be made complete by means of the windows and register-openings in the flue, which serves for the sand bath.

Gas is the fuel to be employed for the analytical operations, and steam-pipes are the media for warming the room.

The shed *T* runs the entire width of the building at the rear, and is only 12 or 15 feet high. It is divided into several portions and fitted with suitable sliding-doors and windows. In the part *b*, the grinding and roasting operations are carried on, so as to

keep the main building free from dust. The position of the implements for this purpose is shown by *N O P*. It serves also for the storage of the crude minerals. The portion *c* is for general storage purpose; while the part *d* serves for the fuel and work connected with the evaporating-pans and drying-kilns.

The central apartment *R* is the general operating space. At the north-west corner the platform and its accessories *M* are placed, so as to be convenient to the grinding machines, from which the powdered mineral is shovelled through an opening *e*, at the base of the partition to the foot of the elevator.

In front of the platform and elevator, about 20 feet distant is the series of stone digesters or solution vats *S*; and in the ground beneath, but close to the left hand wall, so as to be out of the way of accident, are two monte-jus *I I*.

The ordinary precipitation vats are placed at *L L*, which show two pairs, one of which *L' L'*, may serve as wash vats.

The vats for special precipitation and fitted with air-chambers, are to be set at *K*. In

order to accommodate the large volume of wash-liquor, during its accumulation, for evaporation, there is a tall reservoir *o*, for the reception and storage.

At *y* is the pug mill for converting the pulpy precipitate of phosphate of lime into superphosphate, and *v v v v* are the wells for the reception of the mixture of acid and pulp as it issues from the pug mill. In these wells it remains until chemical action is complete, and the mass has become hard.

The drainers and a vacuo-vat for making pure bi-phosphate of lime, or, in other words, for leeching superphosphate, have place at *x* and *z*.

The right wing has several apartments. The first, in two parts, contains the evaporating-pan *e*, and the drying kilns *d*, both of these rooms being served with fuel and other attention from the shed-space *d*, in the rear. The division *f* in front accommodates the disintegrator, and the mixing operation; and the room *g* is that in which the finished products are weighed and packed for market.

The upper part of this wing should be full

of windows, moving on a pivot, to produce currents of air for facilitating the evaporating and drying operations, as may be found necessary.

There are two chimney-stacks, one at H for the steam-boiler furnace, and the other H', connecting with the flues of the evaporating-pans and drying kilns. The main pipe, or feeder, for supplying the steam to the apparatus should run along the wall so high up that the heating branches may drop from it. This arrangement will prevent them being in the way of a convenient manipulation.

As a proper economy of the operation can only be secured by an uninterrupted progress, the work must continue day and night; and, therefore, two sets of hands will be necessary, to replace each other at the proper intervals. A plant constructed and collocated, as has been described, will promote a comfortable and economical course of the factory-work.

CHAPTER VII.



THE RATIONALE OF THE PROCESSES FOR REFINING THE CRUDE PHOSPHATES OF LIME INTO PRECIPITATED AND DI- PHOSPHATES OF LIME.

THE methods about to be described for the purification of "rock guanos" and other mineral phosphates, are founded upon certain principles, which may be stated as follows:—

1. The evolution of pure and concentrated products without any valuable "*waste*" of the raw materials, and in a manner which secures alike to manufacturers and farmers the maximum of honest profit and attainable benefits.

2. The use of chemical agents, which are not only very abundant and cheap, but easily managed, and capable of being reclaimed in forms that will pay their original cost, apart from the profit on the pure phosphate products.

Artificial fertilizers are manufactured al-

most always in great commercial centres, and the customers for them live often in districts remote from convenient channels of distribution. Hence the package and transportation expenses become most important items for consideration in connection with a manure. Previously to being sent forth into the market, it should be freed, therefore, from all inert matters; for, to leave it burthened unnecessarily with any profligate constituents, is an imposition upon the confiding planter.

Moreover, that manure is most economical and effectual which does its work through the first season of application; for, though durability is not incompatible with potency, the quality of permanence is superior only in the sense that none of the fertilizing virtue shall be lost by dissipation after the manure has been put into the soil.

In other words, a soil should be manured rather for immediate fruitfulness than durable fertility: and thus half a ton of a pure and active fertilizer is worth double that quantity of a dilute or a sluggish one. The future had much better be left to the chances of a possible excess of the first than that the pre-

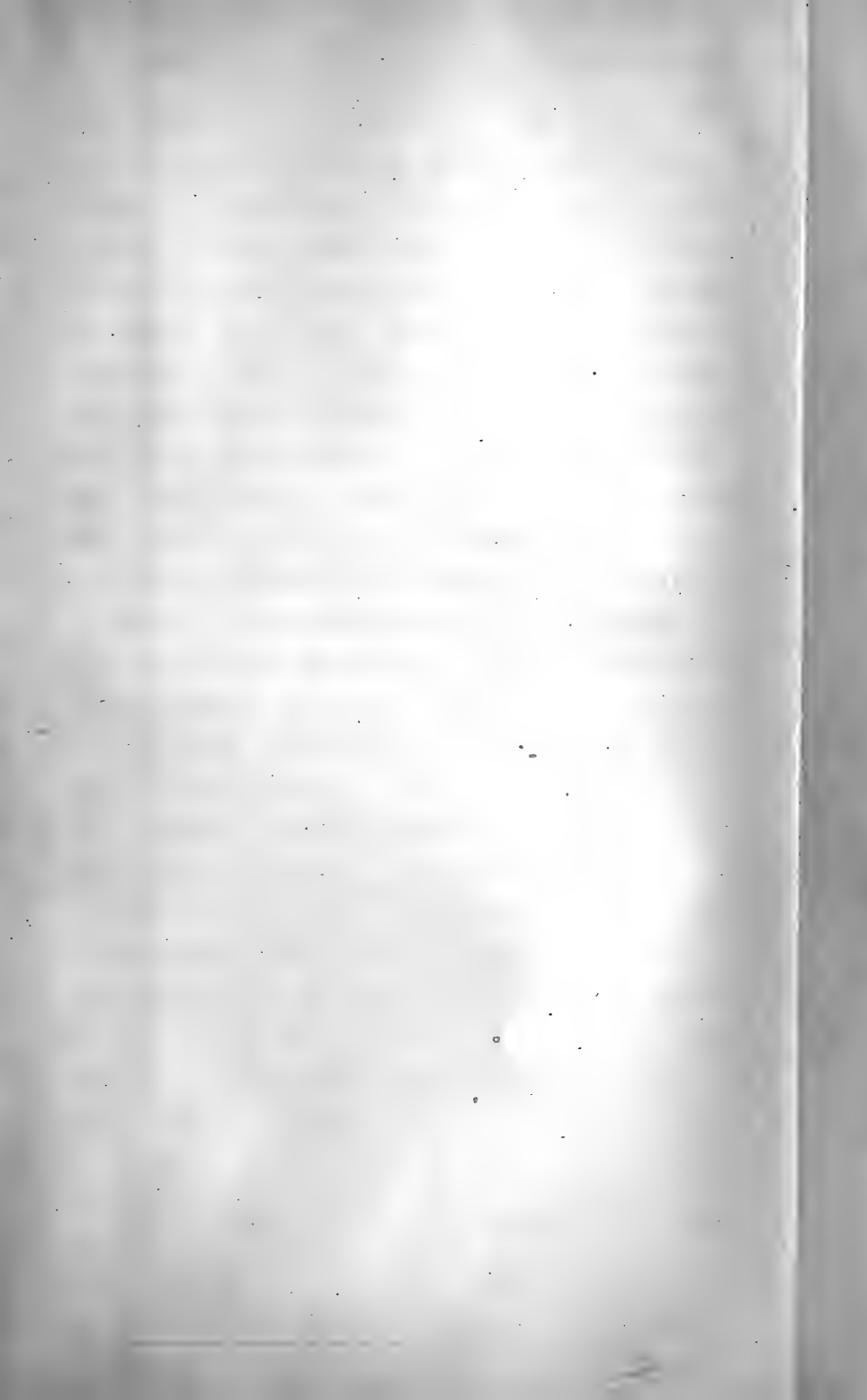



sent should be jeopardised by the imperfect qualities of the latter. In fine, a manure whose forces are being long drawn out through a succession of years, is an injudicious investment, which involves a large capital of money and patience.

I realize these precepts, practically, in some instances, by attacking firstly the crude phosphate of lime with that chemical equivalent proportion of hydrochloric acid which is just sufficient to decompose and dissolve out the whole of the carbonate and organate of lime constituents.

The solution thus formed consists of chloride of calcium, and is to be drawn off into a separate vessel; for this liquor may be evaporated to dryness and utilized profitably in the manufacture of artificial stone by Ransome's process, or for solidifying the ammonia of the liquor of the coal-gas works and bone-black works, as taught in Chapter XI.

These two lime constituents act most profi-
gately in the usual process of treating crude phosphates; for they are the first to seize the sulphuric acid, and only to waste it by swelling the volume and weight of the product with superfluous sulphate of lime.

PRECIPITATION VAT.—DETAILS.

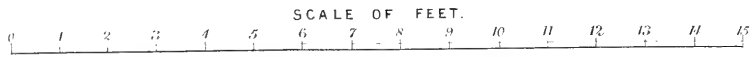

FIG. I.

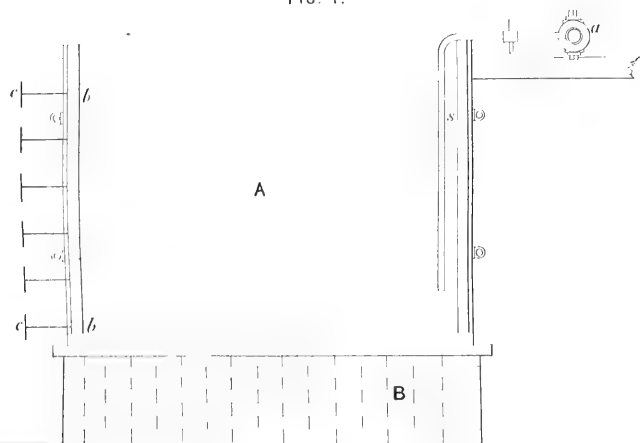

FIG. II.

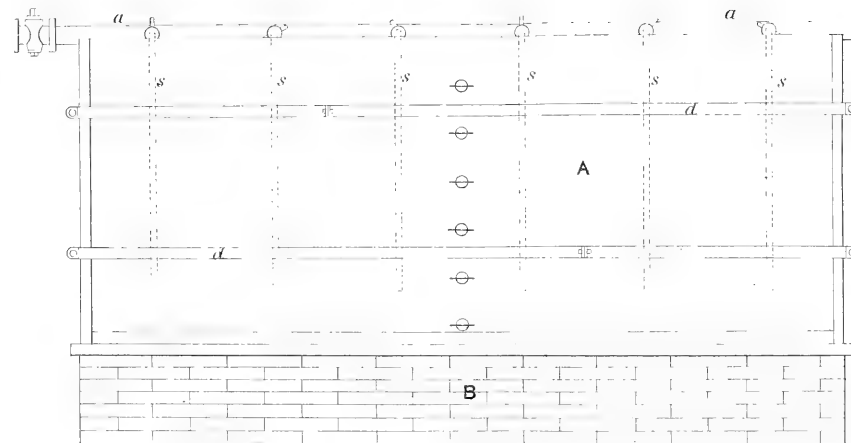

FIG. III.



FIG. IV.

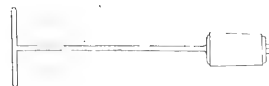
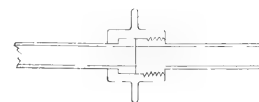

FIG. V.



In my processes, on the contrary, the much cheaper hydrochloric acid is made to do not only that which sulphuric acid would fail to accomplish, but in such a manner that it may be reclaimed in forms which countervail its original cost.

The second step in the refining operation, then, is to add hydrochloric acid again, and in rather greater proportion than will suffice to dissolve out the phosphate of lime and other soluble constituents of the mineral. There is thus left only the insoluble and inert matters, which are to be thrown aside as valueless.

The liquor being drawn off into a separate vessel is a hydrochloric solution of phosphate of lime and magnesia, with certain impurities, and represents the whole essence and value of the crude mineral.

Passing to the third step, which is to get back the phosphates in a solid form, I neutralize the hydrochloric acid of the liquor with a reagent, in such a manner, as to keep in solution the associate-impurities, while precipitating the phosphate of lime; and, at the same time, to reclaim the precipitant in a

suitable form for indefinite repetitions of the operation or other useful purposes.

The precipitate which is thus thrown down being a pure phosphate of lime in the state of pulp, has all the qualities for a rapid and entire conversion into pure "superphosphate" by mere passage through the pug mixer, with its bare chemical equivalent of sulphuric acid.

There is, consequently, no waste whatever of acid, time, or labour, nor any crowding out of the soluble bi-phosphate element to make room for the intrusion of an excess of sulphate of lime or the presence of worthless matters.

The product consists wholly of soluble bi-phosphate of lime in association with only that amount of hydrated sulphate of lime which is incident, unavoidably, to the chemical conversion of tri-phosphate into bi-phosphate of lime.

This high degree of purity of the "superphosphate" affords the facility of producing a soluble bi-phosphate of strength as great as 100 per cent. For, by simply leeching the pure "superphosphate" with water, all the soluble bi-phosphate is removed from its sulphate of lime associate, and may be obtained

as a crystalline mass by evaporating the liquor to dryness.

The following diagram presents a summary of the progressive operations and their effects.

Components of the mineral.	Action & products of the processes.
1. { Carbonate of lime - - { Organate of lime - -	{ Removed by the first dose or fractional of hydrochloric acid; and reclaimed subsequently as chloride of ammonium or chloride of potassium and hydrated sulphate of lime.
2. { Tri-phosphate of lime, with all or most of the iron and aluminum oxides and phosphates - - - -	{ Dissolved out by the second dose or fractional of hydrochloric acid and separated from the liquor in pure solid forms, individually; by agents which are reclaimed subsequently.
3. { Sand and silica - - - { Organic matter - - - { Fluoride of calcium, with more less of { Oxide of iron - - - { Oxide of aluminium - { Phosphate of iron and { Phosphate of alumina -	{ Left as insoluble residue by the hydrochloric acid, and to be thrown away as valueless matters.

There are many cases, however, in which the mineral phosphate will not yield its carbonate and organate of lime constituents to hydrochloric acid, without parting, at the same time, with more or less of the phosphate of lime element; and, therefore, the first fractional treatment may be considered a matter of expediency determinable for each case, according to the judgment of the operator.

If the first fractional treatment or digestion with hydrochloric acid is omitted, or rather merged into the second, so that the two become one and continuous, then the resulting solution differs from that of the previous instance only in containing more chloride of calcium; the additional quantity of the latter being formed from the carbonate and organate of lime constituents of the raw mineral.

This chloride of calcium increases the volume and density of the liquor, so that more time and fuel are required in the subsequent manipulations; but it is not, otherwise, an obstructive presence or modifier of the reactions hereinbefore explained.

To get back the phosphate of lime of the

entire liquor thus made, either ammonia, carbonate of ammonia, or carbonate of lime will answer as the precipitant, and the mother-liquor will have the composition of that already described. But, when di-phosphate of lime is required instead of tri- or Colombian phosphate, either alumina, phosphate of alumina, oxide of iron, phosphate of iron, or milk of lime, must be substituted, as the precipitant, for economical reasons. In each case, the precipitant being the stronger base, seizes the hydrochloric acid which holds the phosphate of lime in solution and causes the latter to precipitate as a white powder. The mother-liquor is then a hydrochloric solution of the precipitant which may have been employed, together with more or less of chloride of calcium and the iron and aluminum constituents of the mineral.

As the use of a full equivalent proportion of the precipitant would produce tri-phosphate, the quantity is reduced to one half of the chemical equivalent of the tri-phosphate of lime contained in the liquor when it may be desired to make the precipitation as di-phosphate of lime.

The quantitative adjustment of the precipitant, so as to restrict the ratio to the requirements for producing either a tri- or di-phosphate, leaves all the iron and aluminium compounds in the mother-liquor and delivers the lime phosphate in a pure state. Thus, then, the latter not only acquires an enhanced value, but promotes for the mother-liquor a wider and more profitable range of usefulness. The latter being now a hydrochloric solution of aluminium and iron oxides and phosphates, is, in fact, a counterpart of the acid solution of "Alta Vela Guano" or other mineral phosphate of alumina as specially made for the defecation of sewage. It has all the advantages of this liquor, with the additional one of much greater cheapness.

So great is the precision with which these re-agents may be made to separate the phosphate of lime from its usual persistent associates, that I intend to found, also, an analytical process in connection with them, and thus solve a problem which, until now, has been full of chemical difficulties.

CHAPTER VIII.

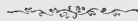

THE MANUFACTURE OF PRECIPITATED PHOSPHATE OF LIME.

THIS product is in the form of a loose white powder, and has a fertilizing capacity only less potential than that of the Colombian phosphate, described in the next chapter.

Chemical authorities generally consider it to be wholly a tri-phosphate of lime; but it usually contains also some di-phosphate. Practically, it is a mixture of all three of the phosphates of lime; for, being very sensitive, it splits into these latter promptly, under the chemical influences of the soil. Its degree of chemical tenderness in this respect varies with the density and temperature of the acid solution from which it is precipitated, and accordingly as the precipitant may be used in the gaseous or liquid state.

It may be made pure, provided the raw

mineral is free from alumina and oxide of iron, and in any case it need not contain more than two or three per cent. of these matters, if proper care is observed in its preparation.

Being free from foreign matters, that is, commercially pure, its superiority as a raw material for conversion into "superphosphate" of very high degree, or even into a pure bi-phosphate, is very evident. The employment of it for this purpose will not only reduce the required amount of labour and acid to the lowest possible ratio, but prevent all waste and unprofitable dilution of the products. Moreover, the latter will be both dry and bright-coloured, in characteristic degree.

Hitherto, all attempts to use ammonia as the precipitant have failed in practice on a large scale, because of the difficulty of adapting a suitable apparatus to the bulky volume of the raw materials and freeing the precipitate from that hygroscopic property which adheres to it through the presence of a slight proportion of chloride of calcium. However much the precipitate may be washed, this property cannot be removed by water alone.

B. de Siebenthal was the first to suggest the reclamation of the ammonia precipitant, but omitted to describe the means. Moreover, he proposed the use of it in a liquid form as precipitant, which is impracticable, for that would require an immense stretch of apparatus and labour for an operation of even moderate extent.

The removal of these fatal obstacles was not an easy task; but they have yielded in my conflict with them, and I am now able, after a patient study of the subject, to present the following method of manufacture, which is at once simple, practical, and, in all respects, economical. Though this process is able to evolve pure products from mineral phosphate of even poor and complex nature, it is yet expedient, for the sake of convenient manipulation and uniform results, that the manufacture should be conducted as much as possible with minerals of uniformly fair composition and character. The "*South Carolina Phosphate*", therefore, will be taken as the raw mineral, with which to exemplify the following instructions.

The Purge or First Fractional Digestion

The first step is to grind the raw mineral to fine powder, after which it should be well heated in a reverberatory furnace to dull redness for an hour. By this process of roasting, the iron constituents are reduced to the lowest degree of solubility in hydrochloric acid, and thus both the purity of the refined product and the economy of its manufacture are materially promoted.

Moreover, part of the carbonic acid being driven off from the carbonate of lime element, there will be less inconvenience from effervescence in the subsequent digesting operation. So, also, in like manner, any pyrites which may be present is converted into oxide of iron and the subsequent evolution of sulphuretted hydrogen during the digesting with acid will be counteracted.

At the same time, it must be mentioned that the presence of organic matter will cause the roasted mass to retain a certain amount of soluble carbon product, which occasionally renders more difficult and slow the subse-

quent digesting operation and clear settlings of the liquors.

Care must be observed in this roasting operation not to fuse the powdered mineral, more particularly when there is much sand or silica present; otherwise, this latter, in connection with some of the other foreign constituents, might re-act upon the phosphate of lime element and diminish its solubility in acids.

The powdered raw mineral phosphate, having been roasted, is to be brought to the foot of the elevator plates 5 and 6, and taken up by the cups *nn*, so as to pass into the mixer *b* gradually, with a sufficient quantity of hydrochloric acid of specific gravity 1.17 to decompose and dissolve out its carbonate and organate of lime constituents.

Assuming that "South Carolina phosphate" is the mineral under treatment, and that it has the composition noted in the table at p. 30, then its content of carbonate and organate of lime being 14.32 per cent. every hundred pounds of the mineral will require 30.93 pounds of hydrochloric acid (sp. gravity 1.17)

and 3·0 additional for contingencies, or say a total of 35 pounds for this preliminary step of the refining operation.

The acid is to flow from the reservoir *v* (Plates 5 and 6) in a gradual stream, so that it will come in contact with the powdered mineral at the moment the latter enters the mixer (Plate 7) from the cups *nn* of the elevator; and it may or may not, according to the judgment of the operator, be previously diluted with one-fourth of its volume of water. My own opinion is in favour of the dilution; for it may happen, otherwise, that the mass will set into a stiff paste with only the volume of liquor represented by the strong acid. This consistence retards digestion in much greater degree than would the addition of water as suggested.

The moist mass, as it falls from the mixer, is to be led through a wooden gutter into the stone digestion-vat described at p. 117, and shown by Plate 8. Here it is heated by the steam currents until effervescence has ceased. At this stage all of the carbonate and organate of lime has been removed by solution in the acid, and together with more or less of

the iron and aluminum elements of the crude mineral. The liquor thus formed is to be drawn off, by means of the syphon, fig. 3, into the monte-jus (Plate 10, page 123). To the residue in the vat, fresh water is to be added, and the whole heated and stirred by the steam current as before, and then allowed to settle. The supernatant wash water is now to be drawn off into the monte-jus and mixed with the previous liquor for treatment, as explained in a subsequent chapter. It is to be known as the *purge liquor*.

This fractional treatment of the mineral, with a restricted portion of acid as the first step of the refining operation, leaves it free from those of its constituents, which would embarrass, otherwise, the subsequent manipulation by producing an excessive volume of liquor. Therefore, the contents of the vat now consist only of the phosphate of lime, constituent with sand, silica, organic matter, a portion of the aluminium and iron compounds, and fluoride of calcium, if any were present.

*The Solution or Second Fractional
Digestion.*

The second step is to relieve the phosphate from its objectionable associates, and this must be accomplished by a new treatment of the washed residue with hydrochloric acid. As the original mineral contains 52·21 per cent. of tri-phosphate of lime, every 100 pounds will require 137, or say 140, pounds of hydrochloric acid, of specific gravity 1·17, for this progressive stage of the refining process. It is to be poured directly upon the contents of the vat, after which the cover is lowered, and the whole heated and stirred by means of the steam currents until all the tri-phosphate of lime has been taken up in solution. It is necessary to keep the vat covered during the digestion, otherwise there will be a great loss of acid by evaporation, and consequently an imperfect result.

The whole is then allowed to settle, after which the fluid portion is to be drawn off into a monte-jus. The residue in the vat is then treated with fresh water, boiled, and allowed to settle as before. The wash water

having been drawn off into the monte-jus, there to mingle with the previous strong liquor, is to be washed a second time. The residue, having been thus cleaned of all its valuable matter, is now to be thrown out as waste, in order to make room for a charge of fresh mineral.

The strong liquor and its two wash-waters in the monte-jus form a hydrochloric solution of phosphate of lime, comprising some little of iron and aluminium compounds, and represent the essence of the "South Carolina Phosphate" disembarassed of profligate and worthless associates. It now remains to get it into a solid form by means which are as convenient and self-compensating as possible. This has been rendered comparatively easy by the cleaning away of the lime carbonate and organate in the first instance, and the contrivance of the following apparatus for the use of ammonia, in a gaseous state and for an indefinite number of repetitions, as the precipitating agent. The volume of this liquor, including wash-waters, is about 350 to 400 gallons from each ton of raw mineral under operation.

*The Precipitation and the Vacuum—
Filter Vats.*

Therefore, to proceed with the next or third step, the hydrochloric solution of tri-phosphate of lime must be raised from the monte-jus into the tall cylindrical vats shown by B B (Plates 17, 18, and 19), and through the openings *g'' g''* (Plate 17).

As the volume of the liquor expands largely in absorbing ammonia, a vat must not be filled to more than two-thirds of its height.

Four vats, B B B B, and one generator, A, constitute a battery. This arrangement is with a view to economy of apparatus and space. In any case, at least a single pair of vats will be necessary for an uninterrupted progress of operations.

The vats, as well as the generator, are in two cylindrical pieces of the best cast iron, bolted together at joints as shown, and made steam-tight by means of a type-metal or caoutchouc ring inserted. The height of each piece is nine feet, which makes a total depth of eighteen feet for the vats and generator severally. The lower piece is to have a thick-

ness of one inch and a quarter for strength, but the upper may be an eighth of an inch thinner. Both the bottoms and tops are fitted on with steam-tight joints.

The four vats are identical in construction, and receive their necessary charge of gaseous ammonia from the generator A. For this purpose there are connecting pipes *o o o o*, made of cast-iron, leading from the directing-valve *e*, and each terminating in two cocks *p p*, at the distances shown from the bottom of the vats. By this arrangement with the interior, the gaseous ammonia is thus made to pass from the generator through nearly the whole volume of liquor in the precipitation vat, by merely opening the lower and closing the upper one of the cocks *p p*. When, after a time the bottom stratum of the liquor may have become thick with precipitate, the uppermost of the cocks is to be opened and the lower one closed, to prevent the further entry of the ammonia to that part which is already saturated.

For the free exit of any gas that may escape absorption or be in excess, there is a cast-iron pipe *s* rising from the top of each

vat and dipping into a small cast-iron extra cistern *t* adjoining. This extra cistern is to be two-thirds filled with the original hydrochloric solution of phosphate, and one of them will suffice for each pair of precipitating vats.

The amount of gas escaping in this way will be so small, comparatively, that one charge of liquor will serve for many operations, so that it will not need to be often replaced by a fresh portion. As the precipitation which takes place in this cistern corresponds with the precipitation going on in the vats, the contents of the former are to follow the course of that of the latter, as soon as they have become thoroughly neutralized by the ammonia gas.

The three cocks *n n n* in each vat for testing the height of the contents within are fitted to a descending tube for carrying off the small try portions of liquor, and thus promote the convenience and comfort of the workman.

There are also a hydrant-pipe *g*, and a steam-pipe *i*, connexion. The steam-pipe, descending into the vat from the latter, is to be perforated here and there throughout its

length, so that the contents of the vat may be stirred and intermixed thoroughly by an occasional "*blow-up*."

In order that the vats may serve equally for the precipitation of the phosphate liquor and the filtration of the precipitate, their bottoms have a special construction; that is, the under portion of each has an air-tight communication with a vacuum chamber *vv*, by means of the short pipe and cock *nnnn*. One of these chambers will suffice for a pair of vats. It is of the best cast iron, seven feet high, with an internal diameter of three feet, and fixed below the level of the precipitation-vats.

Air is exhausted from the vacuum chambers by means of an air-pump *x*, communicating with each through the pipes *nn'* (Plate 19); or steam may be used to form the vacuum. In this latter case, there must be a pipe *l'* connecting with the steam-pipe from boiler, and a pipe *g'* attached to the hydrant which supplies the other vats with water. This arrangement is shown by Plate 17 and will be explained directly.

The details of a precipitation-vat are shown

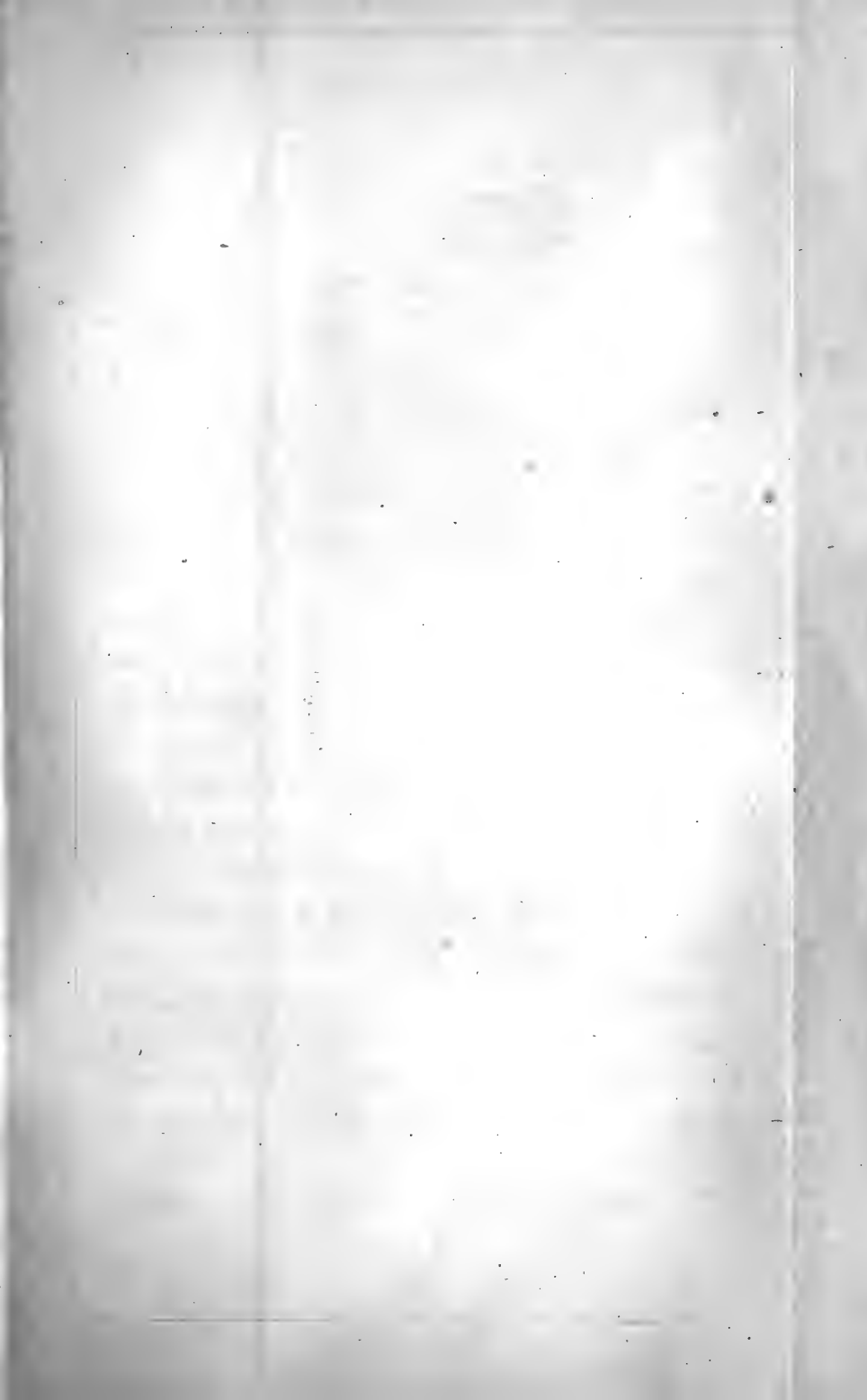

DRYING KILN.

FIG. 1.

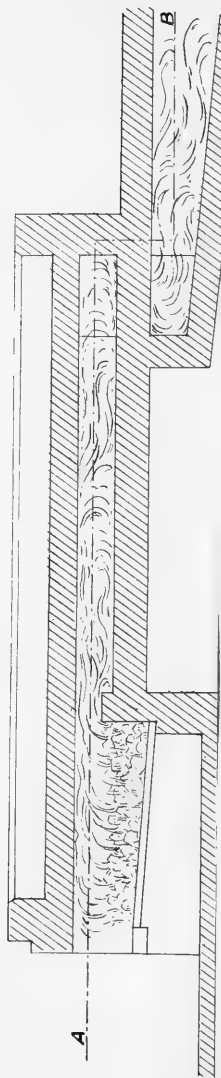

SCALE OF FEET.

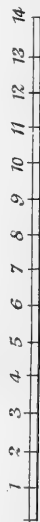

by Plate 18, fig. 1, being a sectional elevation through the centre of the lower portion; and fig. 2, a transverse sectional plan. In both of these figures, the letters of reference correspond for the same parts.

a a are the sides of the vat, and *b b* the iron frame, bolted to the vat, in which slides the wedge-shaped door *c*. Bolted or cast upon a portion of this door-frame is a shoot *d*. The door *c* is raised or lowered by means of the screw *e* and the nut *f*. The gearing to this door consists of a bracket *g* bolted to the side of the vat, and, carrying the end of the screw, a pair of mitre wheels *h*, and a winch handle *i*, for raising, lowering, and screwing the door tightly into the wedge-shaped frame.

The bottom of the vat *k* is strengthened by the ribs *l l l l*, and made to rise a certain distance into the interior of the vat, so as to make the level of the filter-plates *m* correspond with that of the bottom of the door, and also to give an inclination from the edge towards the centre, except at *n*, immediately opposite the door. At this point it is left level, to facilitate the emptying of the vat after each precipitation.

DRYING KILN.

FIG. I.

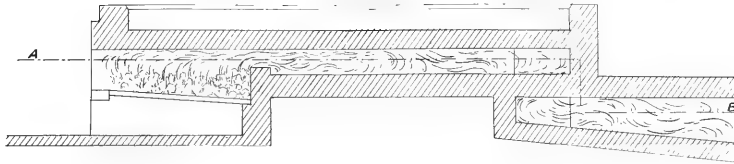

SECTIONAL ELEVATION.

FIG. II.

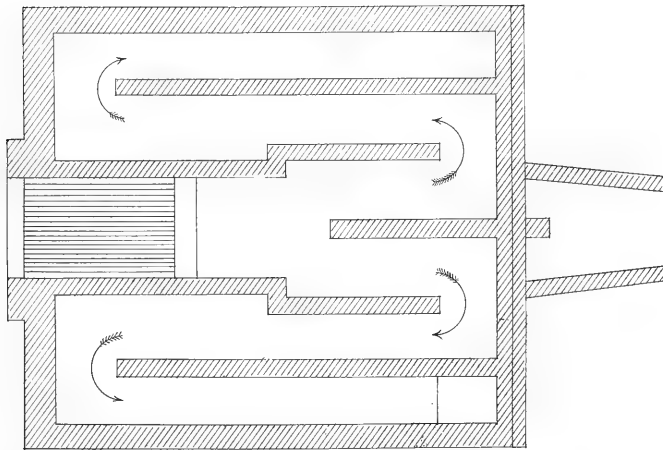

SECTIONAL PLAN.

SCALE OF FEET.

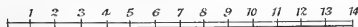



Below the filter-plates the bottom is funnel-shaped, and terminates in a bend and flange, to which is joined the pipe that establishes communication with the vacuum-chamber. These filter-plates, *m*, are twelve in number, each one being a sector, so that it may be introduced conveniently through the door. Six of these are placed in position on the ribs *o o*, and covered with a coarse twilled woollen blanket. Over this are then set the remaining six plates, this arrangement being intended to prevent the clogging and over-weighting of the blanket.

The dimensions of the several parts will be indicated by the scale attached to the drawings.

The hydrochloric solution of phosphate of lime having been mounted into the precipitation-vats, by means of a monte-jus of ordinary construction, is ready to be treated with its required dose of gaseous ammonia.

The Ammonia Generator.

As before noted, the ammonia is evolved in, and sent forth from, the generator Λ (Plate 17); but, before proceeding to explain that

manipulation, I will complete my description of this part of the battery. In material, proportions, and chief points of construction, it is like the precipitation-vats.

In the centre of the top is a manhole and lid of eighteen inches diameter, bolted on and joined in the usual manner, and made steam-tight by means of an inserted ring of type-metal or indiarubber.

At the lower part, and on the side level with the bottom, is a sliding door *m*, like that which has been described for the precipitation-vat on page 175, and by figs. 1 and 2, Plate 18.

On the top of this generator is an arrangement, *a*, for feeding it with the *ammoniacal wash* or *mother liquor*, during the generation of the ammonia. An elevator, *b* (Plate 17), of the usual construction, brings up the ammoniacal matter from a suitable reservoir in the ground beneath, and drops it into the hopper of the generator. On the top of the generator is a relief-valve, *c*, opening inwards to prevent regurgitation of the liquor from the precipitation-vats, in case a partial vacuum should occur in the vat from any cause. A

safety-valve, *d*, is to restrict the pressure within a certain point; and the gas generated within is carried off and conducted into either of the four precipitation-vats by means of a valve, *e*, of special construction.

Water is injected from the main supply, *f*, through the small pipes, *g* (Plate 17), as may be required.

The current of steam, for heating the contents, enters from the main feeder, *h*, through the smaller branch-pipe, *i*. This latter dips to the level of the bottom and there diverges in two branches, *k* and *l*, each of which communicates with a semicircular pipe laid round the interior and on the bottom of the vat. These two internal pipes form a ring, with their terminal ends abutting at opposite sides of the door *m*. They are perforated throughout their length or circumference with small holes for the issue of the steam at high pressure, for heating and stirring the contents of the generator.

At the rear of the generator, or on the opposite side to the one seen in the drawing, are three try-cocks at different heights, and similar to those (*n n n*) of the precipitation-

vats. These are gauges for determining the height of the liquor within or drawing it off.

The generator, like the precipitation-vats, is erected upon a mason-work foundation rising four feet above the level of the ground; but, unlike them, is surrounded to within six inches of the top flange, by a brick wall, with an intervening space between it and the casting. This space is to be filled with ashes, powdered coke, felt, or other non-conducting material, to confine and economize the heat.

A wooden platform, constructed at a level of about two feet below the top flange, so as to surround the battery, and with a suitable stairway, is to afford easy access to the covers, joints, etc., on the tops of the vats.

Plate 18 gives the details of the feeder to this generator; fig. 3 being a transverse section at right angles to its axis; fig. 4, a longitudinal section through the centre parallel to the axis; fig. 5, a complete elevation from the front; and fig. 6, a complete elevation from the side. The letters of reference correspond for the same parts throughout all these figures. *a* is the hopper into which the semi-fluid ammoniacal matter is elevated by

the endless lift, and it is of large size, in order that it may be kept always partially full. Running up the outside of the hopper is a tube *b*, terminating at one end in a long, narrow orifice, and at the other in a pipe which dips into a small condensing cistern, as shown by *c'* and *d'* in Plate 17.

The gas which rises from the generator and fills the apparatus at each revolution escapes by its own elasticity, in part, through this aperture when it is first opened; and the remainder is forced up by the descending mush liquor. As the revolution continues, the aperture at the base of the hopper becomes uncovered, and the contained mush liquor falls through into the generator.

e is a cylindrical chamber with closed ends, and the greater portion of its sides cut away, leaving only the two opposite parts *g g*, and the diaphragm *h*, which divides it. This chamber is turned, truly, to a slightly conical form, so as to insure the maintenance of a continuous good fit as wear and tear take place.

The projecting collar *i*, or exterior flange at the large end, prevents the forcing of it in

too tightly, and a centre screw *k*, regulates the proper degree of pressure, and keeps the inner cylinder in position as wear and tear progress.

l is the outer casing, open at each end, and bored to fit the chamber *e*. It is cast in one piece with the hopper, and terminates at the bottom in an aperture corresponding to the one at the base of the hopper and exactly opposite to it. This is extended in the form of a short pipe *m*, with flanges by which it is bolted to the top of the generator *A*.

n is a worm-wheel fixed on a spindle firmly keyed into a socket *o*, cast upon the centre of the end, and concentric with the cylindrical chamber *e*. Rotary motion is communicated to this wheel by means of the spindle which carries the worm *r*, and is driven by a strap from the main shafting running on the pulley *s s*. A bracket *t*, to carry this gearing is bolted upon lugs cast on the side of the outer casing *l*.

These are drawn to the same scale as the two previous figures. The ammonia material or materials are to be carried to the hopper by the lift, and the feeding must be so

arranged as to keep the hopper nearly full. Motion is then given to the pulleys by means of a strap from the main shafting, and is transmitted by means of the worm and wheel to the inner cylinder. As this revolves from left to right, the portion *g* passing from the base of the hopper allows the contents to fill the space *e*, and as the revolution continues, the contents of the space *e* are poured into the generating vat through the pipe *m*, and at the same time the contained gas takes their place. The further continuation of the revolution then brings the contents of the opposite space into the vat, and the gas that has replaced the contents of the first space *e*, finds an escape through the pipe *b*, and is condensed by dilute sulphuric acid contained in a suitable vessel or receiver, as shown by *d'*, Plate 17. Coincidentally, the material in the hopper again fills the space *e*, and forces all the gases up the pipe *b*. Thus, as long as the revolution is uninterrupted, the material is fed into the generating vat without any of the contained gases being lost; for, as the contents fall into the generator, the corresponding opening through which the mush

liquor enters the feeder is closed by the revolving cylinder.

Fig. 7, Plate 18, is a transverse vertical section; and fig. 9, a transverse horizontal section of the four-way valve-cock by which the generated ammonia gas is distributed to, or shut off from, one or more of the four precipitation vats, as may be desired. A tell-tale window, of thick glass x , Plate 17, will indicate when any lime may be frothing over with the liquor; and, in such case, the heating and agitation of the contents of the generator must be moderated.

$a a a a$ are the four branches, terminating each in a rectangular orifice b , of the same area as that of the circular one c , at the opposite extremity; d is a hollow, conical plug, open at bottom, with one side aperture of same size as b ; e is a handle by which it is turned, and the aperture f made to coincide with that of either of four branches; and g is a flange by which the whole arrangement is bolted to the top of a pipe, which is itself fixed to the top of the generator.

The relief-valve, to prevent regurgitation of the contents of the precipitation vats into

the generator, is shown in transversical section by fig. 8, and in plan by fig. 10, Plate 18.

a is the outer casing; *b*, the valve, supported by the spring *c*, by means of a collar and spindle *d*. This spring is only just powerful enough to bear the weight of the valve.

The apparatus having been constructed and arranged, as described, and the hydrochloric solution of the phosphate of lime mounted into the precipitation vat; the workman then proceeds to charge the generator.

This is done, in the first instance, with a very dense solution of chloride of ammonium as the material for eliminating the gaseous ammonia. For every pound of hydrochloric acid, of specific gravity 1.17, that may have been consumed in making the contents of the *precipitation* vat, there must be taken 0.51 to 0.55 pound of chloride of ammonium.

The ammonia liquor is mounted into the generator from the reservoir in the floor beneath. When all of the requisite charge has entered the vat that is sufficient to generate that amount of gas which is necessary to pre-

cipitate at least the contents of one vat, then it is to be followed by the proper equivalent of lime for its decomposition. This lime must be of the very best quality, and thoroughly slaked into a very thick fluid mush, as directed at p. 63. It is delivered into the generator by the elevator, but the cups of this machine must be always cleansed previous to changing their use from ammonia salt to lime mush, and *vice versa*. Moreover, the addition of the lime mush to the contents of the generator must be very gradual, so that there may be sufficient time for a previous dose to complete its share of decomposing action upon the ammonia salt before being supplemented by a succeeding one. By this management, the contents of the generator will be kept in a fluid state requiring only a moderate heat, and having the capacity of being drawn out easily at the end of the operation. Moreover, it promotes an uninterrupted progress of decomposition, and obviates the inconvenience that would otherwise occur from a too large volume of liquor at any one time.

The hopper-arrangement is expressly for

accomplishing this gradual feeding of the ammonia salt with lime mush.

All of the lime and ammonia salt may be even put together in the generator at once, instead of being fed one to the other by degrees; and, in that case, the feeding appendage *a* on the top of the generator becomes unnecessary, and may be omitted in the construction of the latter.

So, also, the ammonia liquor may be put in first, and have the lime fed to it *gradatim*.

A current of steam must be running into the generator from the instant that the lime begins to enter, or even sooner, so that the liquor may be warm to receive it; and this steam-heating is to continue until all the lime has been consumed, or rather until the ammonia salt has been exhausted, as will be known when there is no longer any smell of ammonia given off by the gaseous distillate, as tested from the try-cock.

Every pound of chloride of ammonium will require 0.53 pound of oxide of calcium for its decomposition, and this is equivalent to 0.60 pound of the best quality of "*quick*" lime.

In the use of chloride of ammonium there is formed gaseous ammonia, which is driven over, with a little moisture, into the precipitation vat, and aqueous solution of chloride of calcium, which remains as liquor in the generator, and is to be drawn out and economised, as explained in Chapter XI. The generator is then ready to receive a fresh charge of material for immediate action on the contents of a succeeding vat.

The current of steam which is let in to heat the mixture of ammonia salt and lime must be regulated so as to keep the temperature down to that point which will suffice to produce the required chemical interaction; otherwise, some of the water might distil over with the evolved ammonia and dilute the liquor in the precipitation vats unnecessarily.

The gas may be passed into one, two, three, or even four, of the precipitation vats at the same time; and, for this purpose, all of the four ways of the exit- or delivery-valve must be opened. But the better plan is to have only two vats in connection simultaneously, for thus one will be sooner finished; and, at the same time, that which adjoins it

will have absorbed all the gas which may escape condensation in the first.

The liquor in a vat is known to be completely precipitated when the clear filtrate from a small portion drawn through the try-cock remains unclouded upon being tested with aqua ammoniæ; and, at this moment, the current of ammonia gas is to be shut off.

All of the precipitation vats should be kept charged with solution, so that, as soon as one is precipitated, the current of ammonia gas may be turned into another immediately.

It may happen when the ebullition within is too strong, that some of the lime will be driven over, and to give warning of such an occurrence there is a tell-tale x , or small piece of thick sheet-glass set into the pipe. In such case, the heating and agitating of the contents of the generator must be moderated until subsidence of this frothing has taken place.

If any slight *excess* of ammonia gas may have been absorbed, it must be economised by adding cautiously to the contents of precipitation vats so much of fresh acid solution or of liquor from the extra cistern t as will

just restore the point of neutralization, and this is to be determined by the use of litmus paper.

The contents, having been brought to this exactly neutral point, are allowed to stand until the precipitate settles, when the supernatant clear liquor is to be drawn off through the cocks into a monte-jus. As all the carbonate of lime was cleared away from the raw mineral in the first or preliminary stage of treatment, this mother-liquor is nearly a pure aqueous solution of chloride of ammonium, and needs evaporation to small volume, in order to be ready for use again as the ammoniacal wash. The amount of chloride of calcium which it contains is only moderate.

Notwithstanding the use of the blanket-cloth and the closing of the intercepting valve-cock *w* (Plate 19), some of the acid solution will pass through into the filter chamber *a* before its phosphate freight has been precipitated. This accumulated liquor must be drawn off, therefore, through the cock *y* (Plate 19) immediately after the settling of the contents of the precipitation vat, and used for

adjusting the neutralization point of liquor or mixed with fresh liquor.

When the supernatant liquor has been drawn off from the deposit of phosphate in the vat, the latter is to be thinned with fresh water, heated and stirred by a "*blow up*", and left to repose, in order that the mixture may clear and allow this wash water to be drawn off as before, and mixed with the previous strong ammoniacal wash in the monte-jus.

One more washing with fresh water is necessary to cleanse the precipitate of any ammonium salt which it may have retained, and this must be done by percolation.

It is to facilitate this operation and save labour that the precipitation vat is constructed as a vacuum-filter with a monte-jus annexed, as shown in detail by Plate 19.

The precipitation vat B, to which this filter-arrangement is attached, has been described above, with reference to Plates 17 and 18, so that it is now only necessary to explain its accessories.

The cast-iron filter-chamber *a* (Plate 19), receives the clear liquor passing through the blanket-filter-cloth from the precipitate, and

delivers it through a connecting-pipe *b*, into a monte-jus *v*, which is constructed as a vacuum vessel. In the conduit *b* there is an intercepting valve-cock *w*, to be used according to requirement.

The float *d* in the monte-jus is to indicate the height of the contents of the latter. This float is fixed to the end of a rod which passes through a stuffing-box *i* on the top, and has a chain end *ff* running over the pulleys *h h*, and terminating in a balance weight *g*. The counterpoise, thus established, will cause the float to rise or fall with the level of the liquor in the vessel.

The pressure above or below that of the atmosphere is shown by a pressure and vacuum guage *t*.

The pipe *l* is the channel through which the contents of the monte-jus are mounted and conveyed into a storage-reservoir in some other part of the factory. During the operation of filtering, this channel is closed by means of the stop-cock *m*.

A pipe *n*, connecting with the steam air-pump *x*, supplies the condensed air for working the monte-jus; and a second pipe *n'*,

serves for exhausting the monte-jus when the latter is to be used for filtrations.

To each of these pipes is fitted a double valve o , which, according to the portion that may be open, puts the air-pump in communication with the monte-jus or the external air. Thus, to exhaust the monte-jus of air, the valve at o on the pipe n must be opened, as shown by the small separate figure x , Plate 19, while the valve immediately behind it on the pipe n' must be screwed down to the contrary position so as to intercept communication through the pipe n' and put the air-pipe in communication with the atmosphere.

The air-pump x is worked by steam power, and consists of an air-cylinder q , and a steam-cylinder x , with a valve-box β , containing one inlet and outlet valve for each end of the cylinder q , that is four valves in all. The plan of the cover of this valve is shown by the small and separate fig. c immediately below the air-pump in Plate 19.

The steam-pipe of the cylinder r is shown at s and the exhaust at t . A short link u communicates rotary motion to a crank-shaft,

from which the steam-valves are driven by the fly-wheel *v*.

If it is desired to do the work by means of steam alone, then the air-pump *x* may be omitted by making the pipe *n'* communicate with the engine-boilers and replacing the air-pipe *n* by a small hydrant pipe. This is to furnish the cold water to condense the steam when a vacuum is to be formed on the monte-jus, as shown in Plate 17, where the pipe *l'* supplies the necessary steam, and the pipe *g'* conveys the water, as previously noted.

The mode of working the apparatus with air is as follows. The contents of the filtration vat *B* being ready for leeching or washing or draining, the valve *w* on the pipe *l'* is to be opened, and the cock *m* on the pipe *l* is to be closed. At the same time, the double valve on the pipe *n* must be screwed down tightly, so as to shut off passage through it, and put one portion of the valve case *p* into communication with the external air. The similar valve on pipe *n'* is then opened to give free passage through the pipe between the other half of the valve case and the

monte-jus vessel *v*. Steam is now admitted to the cylinder *r* of the air-pump, and reciprocating motion transmitted to the piston of the air-cylinder *q*. The air being thus alternately exhausted from the vessel *v*, and forced out through the open valve on the pipe *n'*, there is a partial vacuum formed in the vessel *v*, which allows the whole pressure of the atmosphere to exert its force upon the surface of the contents of vat *B*, and drive the liquid portion through the blanket-filter and sieve bottom along the pipe *l*, into the reservoir or monte-jus vessel *v*.

The height to which it may rise in the latter is indicated by a tell-tale arrangement, consisting of the float *d* and balance weight *g*. The gauge *k* also will show the extent of the vacuum.

When the vessel *v* is full, care being observed to prevent the mounting of the liquor through the pipe into the air engine, the valve *w* is closed. At the same time, the cock *m*, as also the valve on the pipe *n*, are opened, while the valve on the pipe *n'* is closed. Thus the action of the engine becomes reversed, and, compressed air being



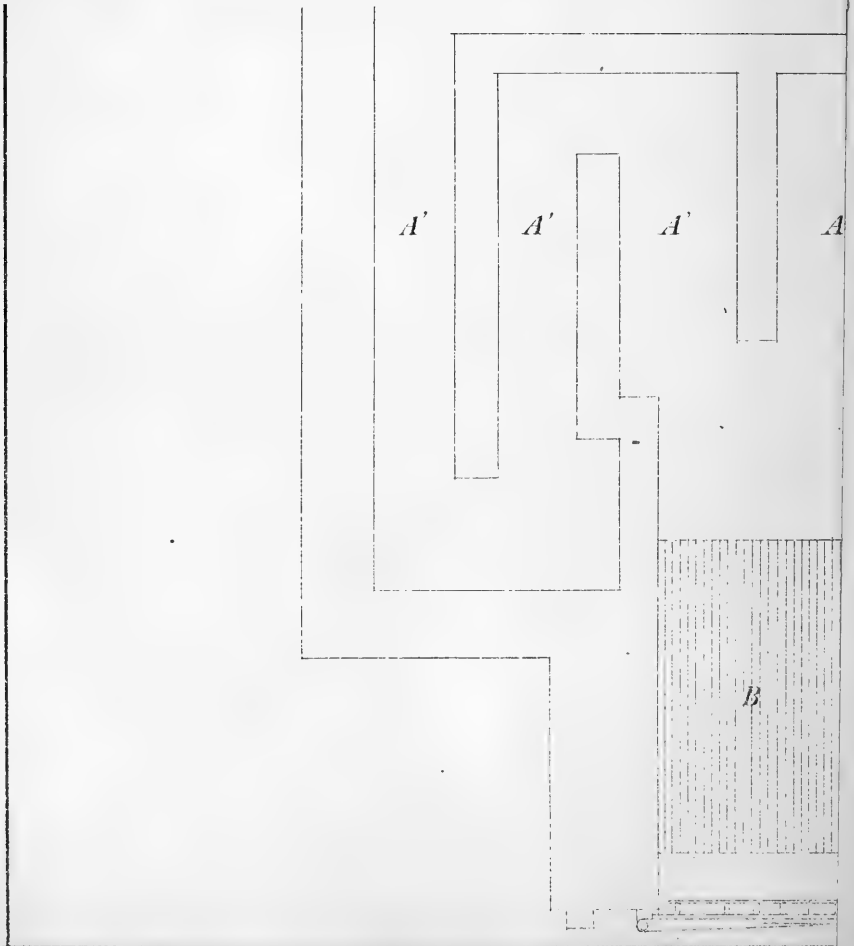

Fig. 1. Diagram of a stepped profile.

forced into the vessel *v*, and acting on the surface of the contained liquor, forces it downwards more or less rapidly, and thence outwards and upwards through the pipe *l* to the required height or to the reservoir which is to receive it.

All of these wash-liquors are to be mixed with the ammoniacal wash aforementioned, as they form part of it.

The precipitate is quite drained in this way, and may receive a further washing, if necessary, in like manner, after covering it with fresh water from the hydrant.

This done, the precipitate is ready to be drawn out through the opening and shoot *c d* (Plate 18), either into the kiln (Plate 12) to be dried for market as precipitated phosphate of lime, or into the pug mixer (Plate 21) for conversion into superphosphate.

If the precipitate is to be sold as such, it must be hot-washed just before going upon the drying-kiln, with about one per cent. of sulphate of ammonia in aqueous solution, to destroy any tendency to dampness which it might retain, otherwise, through the presence of traces of chloride of calcium.

FIG. 1



FIG. 2.

I I I I I I

EVAPORATING PANS.

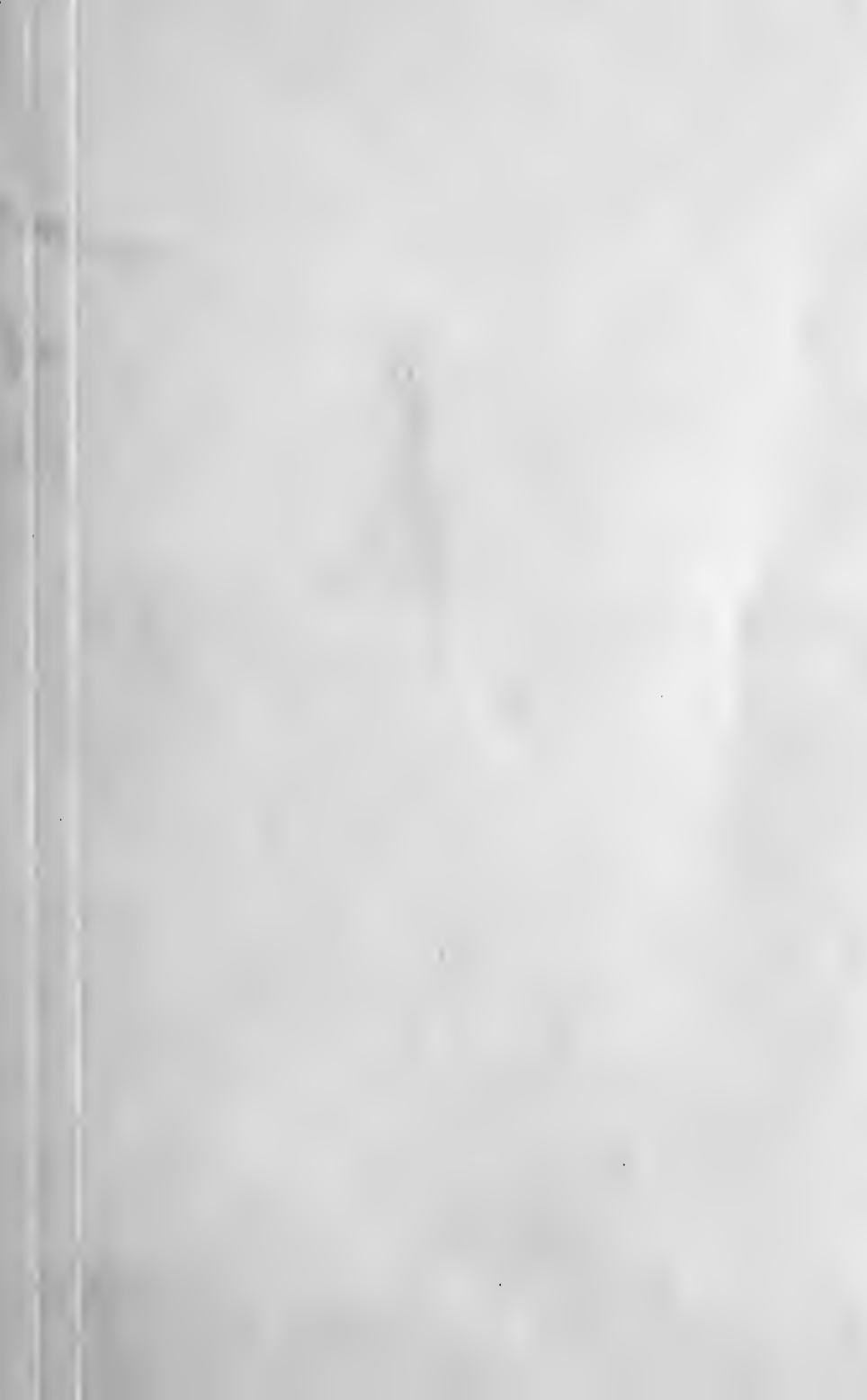

If the vacuo-filtering and washing are to be promoted by steam-condensation instead of the air-pump, then the manipulation must be as follows: As directed in the previous instance, the valve *w* on pipe *b* must be opened, and the cock *m* on pipe *l* is to be closed. Steam is then admitted from the boiler through a pipe, as shown at *l'*, in Plate 17, until it fills completely the vessel *v*, when it is turned off, and immediately followed by the injection of a spray of water through the pipe *g'* (Plate 17). This spray must be sufficient to condense the steam, and thus make a vacuum which acts upon the surface of the contents of the generator in the same manner as when the air-pump is employed. The amount of the vacuum is registered by the gauge *k*, and this manipulation may be repeated several times during the filtering of the vacuo-vat *v*, so as to maintain a good vacuum throughout the operation.

When the vat *v* is full, the stop-valve *w* must be closed, and the cock *m* on the pipe *l* is to be opened. The steam being then turned on, acts by its pressure on the surface of the liquor, and forces it downwards and

upwards through the pipe *l* into the reservoir, as required.

The Ammoniacal Wash or Mother-Liquor.

The mother-liquor, from which the phosphate of lime was precipitated in the vat B by the gaseous ammonia, and the wash-waters, consist of chloride of ammonium, together with a moderate amount of chloride of calcium, in aqueous solution; for it is in the act of combining with the gaseous ammonia that the hydrochloric acid which held the phosphate of lime in solution drops the latter as a solid precipitate.

The preparation which this mother-liquor requires, therefore, to become serviceable again for its original service as ammonia material, is the very simple one of reduction to a small volume in the evaporating-pan (Plate 13). In this way the liquor may be reduced by heat to a dry crystalline mass, or relieved of only a part of its water, as may be desired. The residue in either state is ready for charging the generator, as already explained, and will thus serve over and over

again an indefinite number of times, and with little or no loss if the manipulations are conducted with proper care.

To return to the generator, if the contained charge of lime has not been wholly utilized at the time that the precipitation of the liquor in one of the vats B is completed, then the current of ammonia gas must be turned into another vat kept charged with fresh liquor for such a contingency.

When, however, sufficient chloride of ammonium has been added to convert all the lime into chloride of calcium,—for the lime sends off the ammonia by seizing upon the hydrochloric acid with which the latter is combined,—the generator is to be emptied preparatory to receiving a new charge of lime. This is an easy matter when chloride of ammonium has been the ammonia material, for the residue is a liquid mush which will pass readily out through the sliding door *m* (Plate 17), into a suitable reservoir through a gutter properly inclined, and communicating between these two vessels.

This mush consists of two portions, a liquid or solution of chloride of calcium in

water, and a solid comprising the foreign matters of the lime. After repose the latter settle, and the former may be drawn off into a reservoir specially provided for its storage and subsequent utilization, as taught in Chapter xi.

The Purge Liquor.

At this time, that other portion of the chloride of calcium obtained in the first step of the process from the carbonate of lime portion of the mineral, and known as the *purge liquor*, is to receive attention. It is an aqueous solution of chloride of calcium, containing some little iron and alumina, with more or less of phosphate of lime; for it is only by exceptional care that some little of the latter can be prevented going into solution during the purging operation. However little, it must be reclaimed by adding very *thin milk of lime* with such caution that no excess may be used, to which end the addition must be discontinued as soon as the liquor ceases to redden a blue litmus paper. On repose, all the phosphate of lime will settle, and carry along all or most of the iron

and alumina with which it may have been associated in the purge liquor. Then, after the supernatant liquor of pure chloride of calcium has been drawn off into the storage reservoir, as above mentioned, for treatment according to the instructions of Chapter XI, the precipitate is to be washed with one or two fresh waters, next transferred to the drainers, Plate 23, and finally mixed with the previous chief portion in the drying-kiln or pug-mixer.

If care has been taken in the first instance to wash the raw mineral well and to dry the precipitate thoroughly, the product will be a soft, nearly white powder, containing as much as 96 to 97 per cent. of pure phosphate of lime in the most sensitive condition, chemically and agriculturally speaking; so that, whether it be used as a direct fertilizer, or for conversion into superphosphate, the result will be, in the first case, a rich harvest; and, in the second, a product of maximum strength and excellence. It is also as economical and convenient a material for the manufacture of phosphorus.

The liquor in the extra cistern *t*, as soon

as it has received ammonia enough to precipitate its phosphate of lime, is to be transferred to the filtration vat B, and then drained and washed in the manner explained already at p. 193, as it corresponds exactly in composition with the liquor therein treated.

As soon as a vat is emptied of its saturated contents, it must be charged anew with a fresh portion of the hydrochloric solution of the raw mineral.

All of the iron vessels employed should be coated with stearic pitch, in order to protect their surfaces against the corrosive action of the acid liquors.

By having a battery of four precipitation vats, two of them may be kept in continuous operation, and one ammonia generator will serve for the entire series.

As the form of these vessels is circular, and the thickness of the casting is not less than an inch even in the upper parts, each vat might be filled safely with liquor, as its strength will bear a pressure of 133 pounds to the square inch.

Each vat of 18 feet height and 7 feet diameter, has a containing space of 693 cubic

feet, which is equivalent to 4300 imperial gallons; and may be made to complete an operation every ten or twelve hours. At two-thirds full, therefore, a vat will hold acid liquor representing about 6 or 7 tons of South Carolina Phosphate, and the battery described will give a daily product of, say, 12 to 14 tons of pure precipitated phosphate of lime.

In like manner, the single generator will hold materials enough at each charge to precipitate the second fractional acid liquor of 16 tons of "South Carolina Phosphate".

CHAPTER IX.



ON THE MANUFACTURE OF COLOMBIAN PHOSPHATE OF LIME.

THE precipitate obtained by this process contains a variable quantity of di-phosphate in association with tri-phosphate of lime; and owing to its similitude in respect of composition to the Colombian Rock Guano of earlier renown, I have distinguished it by the special designation of Colombian Phosphate. It is very sensitive to the solvent influences of the soil, and has the additional great advantage of requiring much less of sulphuric acid for its entire conversion into *bi*-phosphate, than any other known product except the di-phosphate of lime.

Moreover, this process is self-compensating throughout to the utmost possible degree; that is, all the chemical agents employed in the refining operation are reclaimed in forms

which have a market value equalling at least their original cost and expenses.

For the sake of convenient manipulation and regularity of products, the manufacture should be conducted as much as possible with mineral of uniform composition and character. This, however, is by no means indispensable, as the process is able to bring out pure products from mineral phosphates of even poor and complex nature.

“South Carolina Phosphate” will be made the example in these instructions.

First Process.

An indispensable preliminary step is to have analysed the raw mineral phosphate of lime about to be subjected to treatment, in order that its components may be exactly and quantitatively defined. Without such information it would be impossible to apportion the acids and other chemical agents, for its treatment, with anything like precision. The sample for analysis will represent more surely a fair average of the material, if it is taken from the whole mass of the latter after it has been powdered. Every separate in-

voice of mineral should undergo this chemical scrutiny, as frequently the same source gives mineral of variable composition. As the operation must continue uninterruptedly during both night and day, a double set of hands will be required to relieve each other alternately.

The first step is to grind the crude mineral, and then roast the fine powder in a reverberatory furnace. This calcining operation reduces the solubility of the iron constituents to the minimum; and not only economises acids subsequently, but enhances the purity of the refined product. The carbonate of lime also loses a portion of its carbonic acid, and thus will produce less effervescence in the subsequent stage of digestion. Sometimes, however, when a large amount of organic matter has been present, there is formed a soluble carbonaceous matter which interferes, more or less, with the digesting and settling operations.

The calcined mineral is now to be brought in wheel-barrows to the foot of the digestion vat (Plate 8), and it is then to be thrown into this vat, shovelful at a time. Previously,

however, the vat must have been charged with the requisite weight of hydrochloric acid of specific gravity 1.170. The proper ratio of this acid is 1.00 to every 1.00 by weight of "South Carolina Phosphate".

To save the time and trouble of weighing the acid at every operation, the vat should be gauged and have chiselled down one of its sides a scale with divisions indicating one hundred pounds for each.

The mineral is shovelled into the acid until the disengagement of carbonic acid produces so much effervescence as to cause an uprising of the mixture to near the top of the vat.

After a brief delay, and as the intumescence subsides, more of the powdered mineral is to be added; and so on, this manipulation is to proceed until the vat is charged to its full capacity. When all has been added, the workman must distribute the solid mass over the bottom of the vat by means of a strong wooden rake. This done, and all the carbonic acid having been eliminated and allowed to pass off into the air, the covers are lowered, so as to close the top of the vat, and steam is let moderately into the tubes which dip

into the vat or heat the surrounding air-chamber, in order that digestion may commence actively.

The covers confine the vapours, prevent the volatilization of acid, and promote the chemical action; but they must be raised occasionally, in order that the workman may rouse the solid matter from the bottom with a strong wooden stirring pole or rake.

The mode of bringing the acid and powdered mineral in contact, as just described, is that which I followed in my experimental operations; and though it has many advantages, it is quite probable, especially on the score of convenience, that the use of the elevator and mixer would prove the best means. The manipulation to be followed with these latter has been described already in Chapters v and VIII.

In about twelve to twenty-four hours all the carbonate and phosphate of lime, with some alumina and oxide of iron, will have been dissolved, and then the heating is to be discontinued and the solution allowed to settle. When, after half an hour of repose, the hydrochloric acid solution rests clear, as the

upper stratum in the vat, it is to be drawn off by means of Blair's syphon (fig. 3) into the monte-jus (Plate 10).

The solid residue consists of the valueless constituents of the raw mineral, but may still retain some traces of phosphates. Therefore, about 0.30 of fresh hydrochloric acid for every pound of South Carolina Phosphate is to be added, and the digestion renewed for several hours. Boiling water is now to be let in from a reservoir until the contents of the vat are doubled in volume, the whole stirred, and then left to repose. After half an hour, when the solid matters have settled, the clear supernatant liquor is to be drawn off into the monte-jus as before, by means of the syphon, to mix there with the previous strong liquor.

The residue is next to be thoroughly washed. This is done by letting in its volume of boiling water, stirring, leaving to repose, and drawing off the clear liquor from the settling as before. This washing is to be repeated with fresh water, and then the residue is clean. The two wash-liquors must be mixed with the preceding strong liquors in the monte-jus.

The insoluble residue comprises the organic matter, sand, silica, and most of the alumina, oxide of iron, and fluoride of calcium, of the original or raw mineral, and must now be removed from the vat to give place to a new charge of fresh mineral.

The total of acid prescribed is rather more than the equivalent proportions for the carbonate and phosphate of lime constituents of the mineral; but the slight excess is to provide for the contingency of some of the aluminium and iron oxides being dissolved.

To be assured that the washed residue is exhausted of phosphate, the following test must be applied:—

Heat a portion, with hydrochloric acid, in a beaker glass for half an hour; add some distilled water, and then filter. Reject the filter, but add aqua ammoniæ to the filtrate until the latter is *barely neutralized*; after which, pour in an excess of oxalic acid, and filter. To the filtrate add an excess of aqua ammoniæ, and filter. The filtrate will now contain phosphate ammoniæ if there was any appreciable quantity of phosphate of lime or magnesia retained in the residue of

the digestion vat. To determine this point it remains only to add to the filtrate some little of a solution of chloride of magnesium, and a precipitate or cloud will be formed at once if the presence of phosphoric acid is in material degree.

The united liquors in the monte-jus are next to be raised therefrom to the precipitation vat, as explained at p. 126.

This liquor is a hydrochloric solution of phosphate of lime, containing chloride of calcium with some aluminium and iron chlorides. The vat may be filled to two-thirds of its capacity with this liquor, which then is to be brought to boiling by means of the steam-pipes provided for the purpose. These pipes should be of enamelled rather than plain iron; for, though the first cost of the former is higher, it is stationary; while that of the latter accumulates constantly by corrosion in the liquor. Moreover, as the iron pipes become rusted, they dirty both the liquor and precipitate; whereas, the normal colour of both of these latter is white.

As soon as the liquor has reached the boiling point, finely powdered *whiting* (levi-

gated chalk) is to be sifted into it *very gradually*, and *during constant steaming*. Carbonic acid is disengaged at once from the whiting, which is a carbonate of lime, and there is much effervescence. At the same time, the hydrochloric acid is neutralized, and the phosphate of lime precipitates as a white mass, together with some alumina and oxide of iron. The liquor which it leaves above is wholly an aqueous solution of chloride of calcium. An excellent sifting arrangement is shown in elevation and plan by Plate 20. It consists of a wrought-iron frame-work *a*, running along the centre of the precipitation vat, and working on the rollers *b*, carried by the iron standards *b'*, fixed to transverse timbers *o*, extending from side to side of the vat. This frame-work carries a series of galvanised cast-iron boxes *c*, held securely by the screw-arrangement *e*.

The distances between the boxes are about one foot. The sieve portion *f*, is a thick zinc plate, finely perforated and rendered movable by the set screws *g*, in order that it may be taken out for cleaning when necessary.

The boxes are receptacles for the whiting. The driving power must be steam. Motion is communicated by means of a disc *h*, an axle *i*, and pulleys *k*. The disc has eccentric depressions *l* and elevations *m*, upon one of the sides. The two bars that form the framework *a* unite in one bar at *n*, and this, when the axle is revolving, follows, necessarily, the sinuosities of the wheel, and, as a consequence, draws the sieve backwards and forwards. This shaking motion promotes the passage of the finer portions of the powder through the perforations after the manner of hand-sifting, but in a much more rapid and regular progression. *p* shows one side of the vat to which this sifter is fixed, *r* the support for the axle *i*, and *s* the handles by which to lift the boxes when they are to be removed for any purpose. In order to prevent any contamination of the precipitate with an excess of whiting, care must be observed to add the latter in gradual portions and to wait always for the effervescence from a previous dose to subside before adding a new or succeeding portion. The approach of the neutral point makes itself evident, therefore, by

the effervescence becoming imperceptible as the last portions of whiting are added: or, in other words, when the addition of a little whiting to the boiling liquor ceases to cause a *hissing* and foaming of the latter, all of the phosphate of lime has been precipitated.

The liquor clears rapidly when the point of neutralisation is reached. The two more important precautions to ensure success in this precipitation is to have the liquor in a sufficient state of dilution and at a high temperature as prescribed.

When the operation, therefore, has been carried through according to the directions already noted, the precipitate will be all down chemically in a few hours; and then the whole is left to repose. Shortly afterwards the precipitate will have settled mechanically, and the clear mother liquor above is to be drawn off into the *wash-vat* or *monte-jus* placed beneath, for treatment according to the instructions in Chapter xi.

As it is possible that the precipitate may contain some little caustic or carbonate of lime, notwithstanding the precaution against adding an excess, there should now be poured

upon it some *dilute* hydrochloric acid. This is best done by letting in fresh water, then heating by steam and adding the acid cautiously so long as there is any effervescence. Afterwards the steaming is to be stopped, and the whole allowed to settle. By this washing with acid the precipitate is freed absolutely from all traces of carbonate of lime; but as some little phosphate of lime may be taken up, also, at the same operation, the supernatant solution must be preserved. It is to be drawn off, therefore, into the precipitation-vat for treatment with the next strong liquor, instead of being sent into the *wash*-vat.

A much surer way, however, to avoid any excess of whiting is to bring the liquor to boiling by means of steam currents, and to add cautiously a thin milk of lime, in sufficient quantity to neutralise any free hydrochloric acid. As soon as the milk of lime ceases to dissolve, and leave the liquor clear—that is when it produces a permanent cloud—then the whiting is to be added in the manner already prescribed, and in quantity barely equivalent, chemically, to the

CARRS' MIXING MACH

FIG. 1.

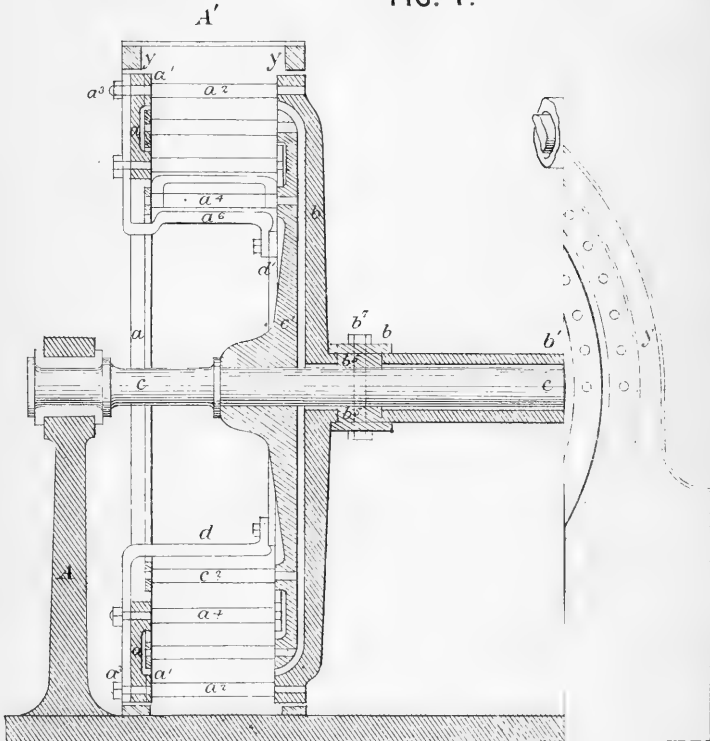

phosphate of lime in the liquor. When all is in, the boiling is to be continued until the liquor becomes a thick mush; and to promote this change the precipitation vat must be provided with close steam tubes on the bottom, as explained in the following Chapter. Water is now added to wash the precipitate in the usual manner, and the decanted mother and wash liquors reserved for further treatment. The washed precipitate is to be dried on the bed of the kiln.

By using a little less of whiting than is equivalent to the amount of tri-phosphate of lime in the acid solution, nearly all of the iron and aluminium, oxides and phosphates, will be left in the mother liquor. But, at the same time, some little of phosphate of lime may be retained with them.

This liquor on being concentrated by evaporation will be a very effectual and profitable material for removing ammonia from gas, for defecating sewage, and for disinfecting purposes generally; as the changes assumed, in such chemical operations, would add to its agricultural advantage and money value.

CARRS' MIXING MACHINE — DETAIL — SIDE AND FRONT ELEVATION SECTIONAL.

FIG. 1.

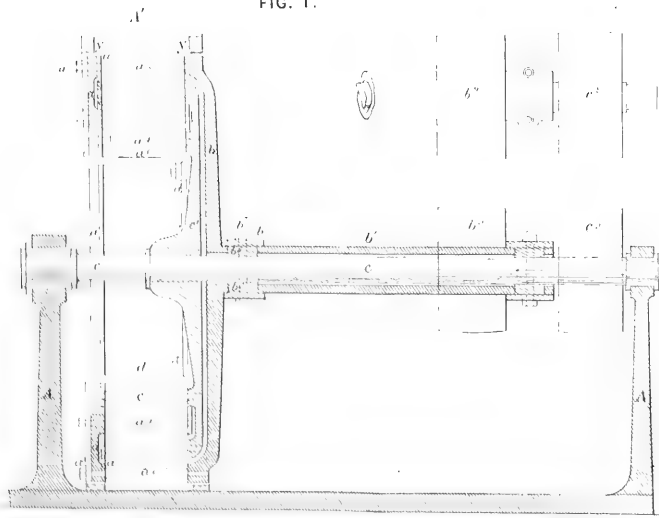
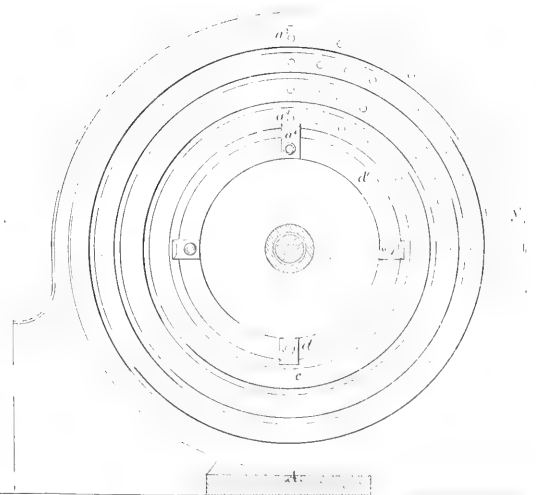

FIG. 2.



SCALE





At the same time, if it is desired to reclaim the small amount of phosphate of lime from the mother liquor, it can be done by adding thin milk of lime to the latter until it blues a red litmus paper. The lime neutralises the hydrochloric acid, and, as a consequence, the phosphate of lime which it retains in solution falls with the iron and aluminum compounds as a precipitate. This, on being washed and dried, may be sold as an inferior manure, or as material for Spence's and Townsend's processes, described in Chapters XIX, XX, and XXI. The liquors left by this precipitate are to be utilised as directed in Chapter XI.

If the precipitate in chief is to be sold as such, that is as Colombian Phosphate of Lime, enough of sulphate of ammonia or sulphate of potassa should be added now to convert the retained traces of chloride of calcium into sulphate of lime, and render the product free from humid tendency and permanently dry. For this purpose the mass is steamed during the addition of the alkaline sulphate, and for some fifteen minutes afterwards. The mixture is then to be run into

the basin of the kiln, and there dried for market as explained at p. 130, and by Plate 12. The product will be a nearly white powder having the following approximate composition per cent.

Tri-phosphate of lime	-	-	80'00 to	85'00
Di-phosphate „	-	-	14'50 to	10'00
Ammonium or potassium chloride	-	-	'60 to	:80
Sulphate of lime	-	-	'90 to	'95
Aluminium and iron oxides and phosphates	-	-	2'00 to	2'25
Water, accidental	-	-	2'00 to	1'00
			<hr/>	<hr/>
			100'00 to	100'00

On the other hand, should the precipitate be intended for conversion into superphosphate, then it must be steamed while wet, with fresh water, for a few minutes, and afterwards left to repose. The clear liquor which thus rises to the top must be drawn off into the wash vat. This washing is to be repeated twice in like manner, and the liquor run off each time into the wash vat.

It is all-important to the convenience and economy of the subsequent operations (Chapters XIII, XIV, and XV) that the precipitated phosphate should be free from chloride

of calcium, and hence the necessity of this thorough washing.

The quantity of whitening required will depend upon its state of dryness, which is variable, and also on the quantity and strength of the acid liquor. These data will have to be determined by gauging the total volume of the liquor, and testing a fluid ounce as follows: In round numbers there must be enough to neutralise all the hydrochloric acid employed in making the solution of the raw mineral, except the equivalent proportion belonging chemically to the carbonate of lime, iron, and alumina constituents. Therefore, to the test portion of one fluid ounce add aqua ammoniæ in slight excess; filter (fig. 18) and wash. Reject the filter, but heat the filtrate in a beaker glass and on a sand bath, until all excess of ammonia has been volatilised.

This filtrate is now to be treated very carefully with a normal nitrate of silver liquor just to that point when a cloud or precipitate ceases to be formed. The normal liquor is to be contained in one of Mohr's graduated burettes (fig. 4) with its india-rubber tube and spring clamp, *a b*, for regulating the flow of its contents.

The number of cubic centimetres of normal liquor consumed for the purpose indicates the quantity of dry hydrochloric acid in the filtrate.

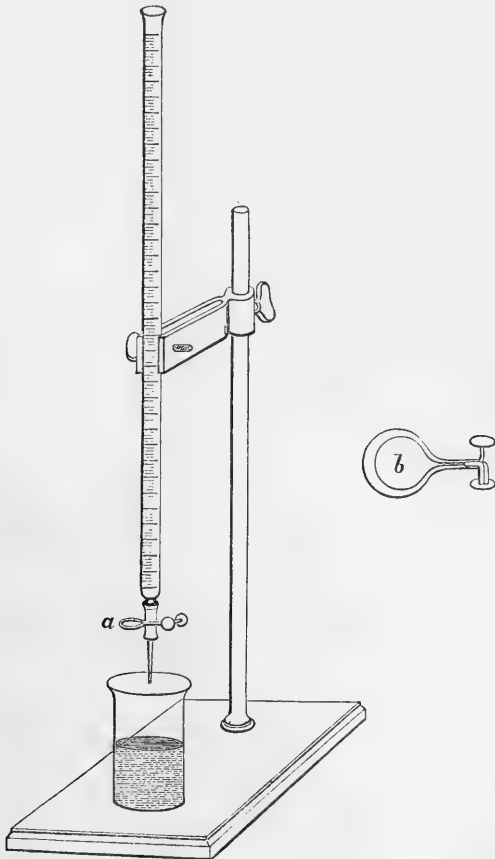

Fig. 4.

One cubic centimetre of the normal liquor

should contain 0.467 grain of solid nitrate of silver to be equivalent to 0.1 grain of dry or gaseous hydrochloric acid (HCl). Therefore, this normal liquor is made by simply dissolving 467.0 grains of solid, pure nitrate of silver in enough of distilled water to make one litre at 60° to 62° F. A suitable flask with a litre mark *a* graduated on its neck, is shown by fig 5. Every 0.3425

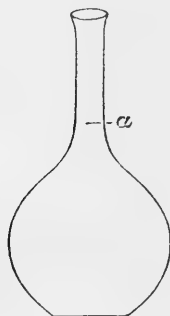

Fig. 5.

of gaseous hydrochloric acid (HCl) is equivalent to 1.0 of liquid acid of specific gravity 1.17; and requires, therefore, for its neutralisation 3.42 cubic centimetres of the normal test liquor.

The Mother-Liquor or Wash.

Attention is now to be turned to the mother-liquor or *wash* from which the phosphate of lime was precipitated. It is wholly an aqueous solution of chloride of calcium from the carbonate and organate of lime of the original raw mineral and the lime base of the whiting.

As the volume will be large, the better way would be to evaporate it to a solid form and sell it as material for Ransome's artificial stone. For this purpose, it is to be run into iron barrels while still in a fused state, and there allowed to set hard. The barrels have each a capacity of one-fifth of a ton.

A form of evaporating furnace, which will answer for this liquor, may be found in the salt manufactories, where there is a great experience in such operation.

There is already a considerable demand for solid chloride of calcium in Great Britain and the United States of America, by those parties who are working the patented process aforesaid, for the manufacture of artificial stone.

The presence of some chloride of aluminium would not be injurious for this purpose. On the contrary, in my opinion, it would be beneficial, and might be added advantageously.

The precipitation of the *wash-liquor* by milk of lime will clear it of both alumina and oxide of iron. If gas-liquor or the sulphates of ammonia and potassa are accessible at moderate cost, then it would be advisable to convert a part of the wash-liquor into alkaline chloride, as explained in Chapter XI.

Second Process.

I have worked out recently another method which has important advantages over the one just described. It not only delivers the phosphate of lime in a pure state, but utilizes, as precipitant, the iron and aluminium compounds with which the former is naturally associated in the crude mineral.

The process is carried out by digesting the finely powdered rock guano or other mineral phosphate of lime in a suitable vat with enough hydrochloric acid to dissolve out all of its soluble matter. The solution is then

drawn off from the insoluble residue and treated in a separate vat with enough of the iron and aluminium compounds of the raw mineral to precipitate all of the phosphate of lime. The heating and stirring during this manipulation are to be accomplished by means of steam-currents entering the liquor.

The iron and aluminium compounds are to be added gradually in the form of a pulp until a precipitate ceases to fall. A sample, tried in a test-tube, from time to time, will indicate this point. A few hours of repose are now to be allowed.

All of the phosphate of lime is thus thrown down as a white powder; while the liquor above contains all, or nearly all, of the iron and aluminium compounds of the original raw mineral in hydrochloric solution. This latter, or "mother-water", is a most advantageous substitute for "Alta Vela Guano" in the defecation of sewage.

The settled deposit of pure Colombian phosphate of lime is to be washed with several relays of fresh water and dried at or below 212° F., for market; or mixed as pulp with the requisite equivalent of sulphuric

acid, in a pug-mill, and converted into a high grade of "superphosphate".

The "mother-liquor" is a mixture of chloride of calcium and hydrochloric solution of iron and aluminium compounds. On the addition to it of a sufficient quantity of milk of lime to make the liquor turn blue a red litmus paper, the whole of these iron and aluminium compounds are precipitated. By repose, they settle well at the bottom, and then the supernatant liquor is to be drawn off.

The precipitate, after having been washed and pressed, is ready for use or sale. A part of it is to serve as precipitant for the succeeding batch of mineral solution; and the remainder will be a most advantageous substitute for the mineral phosphates of alumina in the manufacture of alum, phosphorus, phosphoric acid, and the phosphates; in the refining of sugar; in the defecation of sewage; and for other useful purposes.

This pulpy precipitate is a mixture of iron and aluminum oxides and phosphates, and will effect the precipitation, whichever of its components may predominate. In other



CARR'S MIXING MACHINE.
PERSPECTIVE VIEW.

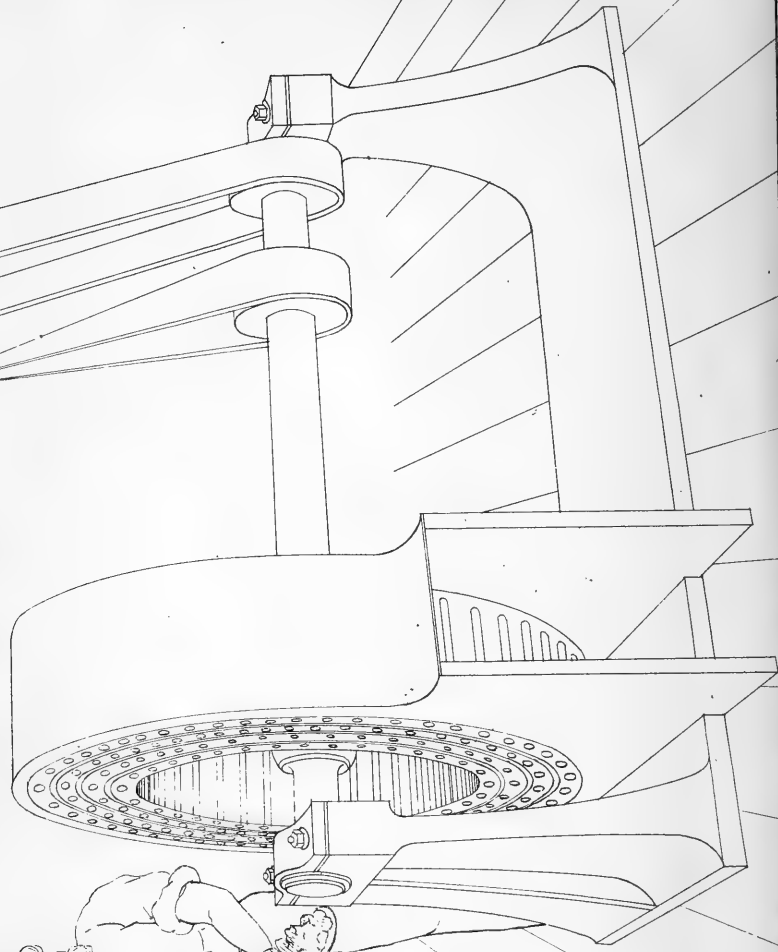
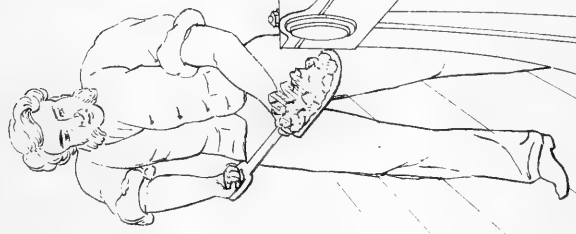

words, by this method, the oxides and phosphates of iron and aluminum, whether natural or prepared artificially, will serve singly or jointly for precipitating the phosphate of lime constituent from acid solutions of mineral or crude phosphates.

The pulp required for an inaugural operation is to be obtained by means of milk of lime from the mother liquors of the preceding process, or from that of the first di-phosphate method in the next chapter.

CHAPTER X.



THE MANUFACTURE OF DI- OR NEUTRAL- PHOSPHATE OF LIME : AND OF CHLORO- PHOSPHATE OF LIME.

THIS salt of lime deserves the best consideration, alike of manufacturers and consumers. It contains a higher ratio of phosphoric acid than the tri-phosphate. Hence, less of sulphuric acid is required for its conversion into bi-phosphate, and it gives a more concentrated product. For this same reason, it is a most advantageous basis-material for the manufacture of phosphorus.

Though not directly soluble in water to any great extent, the di-phosphate is, nevertheless, a most active and economical fertilizer; for the chemical and atmospheric influences of the soil split it promptly into soluble modifications which nourish a growing crop as vigorously as would the bi-phos-

phate. It is only the prejudice born of familiarity in the use of the bi- or superphosphate, and of a want of experience with the di- or neutral-phosphate, that blinds the popular eye to the greater economy and equal potentiality of the latter as a manure. But, as time extends its production and brings it forward more abundantly into market, this di-phosphate will become better known and secure that appreciation which will give it a first place among fertilizers.

The successful manufacture of this article is founded upon the studies of T. J. Way, Deligny, and myself, who are the only chemists from whom the subject has received any serious practical consideration.

As the chemical characters of this di- or neutral-phosphate of lime have been described already at page 71, I will proceed at once to explain the methods of preparing it in a commercially pure state.

Morfit's Process (A).

Having selected a mineral or other crude phosphate of lime of uniform composition and reduced it to powder, the next step is to

add to it sufficient hydrochloric acid of specific gravity 1.17 to dissolve out the carbonate and organate of lime constituents. This is called the purging operation. If the raw mineral should contain any fluoride of calcium, the cover of the digester must be fitted with a flexible-joint pipe leading into the chimney for the purpose of conveying away the fumes.

The acid may be diluted advantageously with water, and the purging manipulations should be performed with the aid of an elevator and mixer, as described at pp. 111-115. The carbonic acid is thus got rid of more quietly and conveniently than if the powder and acid were mixed in mass.

When all of the powder and acid has fallen from the mixer into the digesting vat (Plate 8), more hydrochloric acid must be added, and the whole well heated and stirred, as explained at p. 207.

The proportion of hydrochloric acid necessary to complete a digestion, will be the combined chemical equivalents of the carbonate of lime, organate of lime, tri-phosphate of lime, and iron and aluminium compounds

contained in the raw mineral, and must be calculated according to the analysis of the latter and the data stated already in preceding chapters.

But, after the purging operation, for the removal of the carbonate and organate of lime, the mineral mass should be treated with the remainder of the acid in *divided* portions or moieties. That is, the digestion should be continued with one-half of the residual acid as a second step; and when this latter has become charged with soluble matter, it is to be diluted with water, heated by the "*blow-up*", allowed to settle, and decanted or drawn off.

After this decantation through a tap or by means of a syphon, the last moiety of fresh acid is to be added, and the digestion continued. When the insoluble residue seems to be exhausted, water of dilution is to be poured in again, and the whole heated by a "*blow-up*" and allowed to settle, as previously. The clear liquor is then to be drawn off, and the residue washed with several relays of fresh water, by means of the "*blow-up*", in like manner. The sand and

silicates, etc., forming the insoluble residue, are to be removed from the digester and thrown out as valueless waste; the strong and wash-liquors are to be united in the precipitating vat.

Before passing, however, to the precipitating operation, it is expedient to record a few notes respecting the choice of a digesting or solution vat for the raw mineral.

In many mineral phosphates the presence of large ratios of insoluble residuum and organic matter cause the powder to form a thick mass with the acid, and this impedes the digestion. In such cases, the "*blow-up*" would have to be used frequently, or even constantly, in gentle current, so as to supply the proper state of dilution by means of condensed steam. This may cause such a condensation of steam as to dilute the liquor excessively, and weaken its solvent power. Keeping the digester constantly covered during the operation, as is obligatory, to prevent the volatilization and loss of acid, will not hinder the excessive dilution, but rather promote it. If the raw mineral is easily soluble, this dilution will be imma-

terial; but there are many kinds of rock or fossil phosphate of lime which resist, with much obstinacy, the solvent action of even strong acids. In these latter cases, then, the double vat with surrounding hot-air chamber will be required for the operation of digesting them. The means of heating being a surrounding hot-air chamber, the "*blow-up*" of open steam need not be used except for rousing the mass occasionally.

Time, too, is an important element in the digesting operation; for, while some of the mineral or fossil phosphates of lime give up all their soluble matter in six hours, others require twice, thrice, and even fourfold that time for their solution.

The combined liquors in the precipitation vat, representing the soluble matter of the crude mineral, are an aqueous solution of chloride of calcium, containing a hydrochloric solution of tri-phosphate of lime, together with iron and aluminium compounds.

The vat may be of cast or wrought iron, coated with stearic pitch, and according to the form, dimensions, and general construction shown by Plate 11. But at the bottom

there must be a bed of closed iron tubes for the circulation of steam, in order to form a broad extent of heating surface. The exterior of these tubes must be coated with Clark's enamel.*

The liquor in the precipitation vat is to be brought to boiling by means of the "*blow-up*", and then treated cautiously with very thin and strained milk of lime until all the free hydrochloric acid has been neutralized. This is known as soon as the lime ceases to dissolve and leave the liquor clear or free from cloud.

After having reached this point, the liquor

* I am now having a vat constructed which combines efficiency, durability, and cleanliness in an eminent degree. It consists of only five pieces of cast-iron, each six by four feet, so that a large vat is formed with only a few joints; which are made tight by hard india-rubber slips and nut-screws. The interior surfaces of the plates, as well as the steam-tubes and bottom-coil, are enamelled with porcelain, so as to be proof against corrosion. To give strength, the plates have ribs cast on the outside in a manner to form spaces for the insertion of felt cloth and panel covers, for maintaining the heat of the contents of the vat. Vats thus made are inexpensive, comparatively, and serve equally well for digestions, precipitations, and evaporations, whether hot or cold.

is to be treated further with a certain quantity of thin milk of lime containing only a little more of caustic or quick-lime than is equivalent, chemically, to one-half of the tri-phosphate of lime in the original raw mineral. Thus, if the latter, according to an accurate analysis, contained fifty per cent. of tri-phosphate of lime, and its digestion with hydrochloric acid has been conducted effectually, the liquor from it will hold the entire quantity in solution; and this will make a total of 1120 pounds for every ton of raw mineral. Supposing, therefore, that one ton of the mineral be under operation, then the liquor for it will require 0.18 to 0.20 pound of pure quick-lime for the precipitation, as di-phosphate, of each and every pound of tri-phosphate of lime that it may contain.

The lime must be added in the form of a thin milk and through a fine sieve, so that the passage of coarse particles or dirt may be intercepted.

After all the lime has entered, the steam is to be turned off from the "*blow-up*" into the closed tubular bottom, so that *dry* boiling and evaporation may go on regularly. As

the mixture becomes concentrated it thickens gradually, and when it has reached a state of very sluggish fluidity it will assume, suddenly, the consistence of a thick paste. The heat must be continued from this period until the paste acquires a certain degree of dryness, and then it is to be drenched with its volume of fresh water, heated and stirred for a few minutes by means of the "*blow-up*", and left to repose for eight or ten hours.

The clear mother-liquor is now to be drawn off from the settled precipitate of di-phosphate into a large storage vat for treatment, as hereafter directed.

The precipitate must be washed with several relays of fresh water, with the aid of the "*blow-up*"; and after each settling the wash-water is to be drawn off as before, and mixed with the strong mother-water in the storage vat. The precipitate is then to be dried in the same vat by moderate currents of steam coursing through the tubular steam-heating coil at the bottom.

If the precipitate, as such, is to be sent into the market, there must be added to it, during the drying operation, an aqueous solution of

one or more per cent. of sulphate of ammonia, in order to decompose any traces of chloride of calcium it may have retained, and remove thus the least possible tendency to dampness.

Care must be observed not to over-heat the precipitate, otherwise its bright colour and solubility will be damaged. Therefore, the temperature, or rather the current of steam, must be diminished as soon as any sign of rusty appearance begins to show itself in the mass. With this precaution, the precipitate will be a beautiful white pulverulent mass, readily broken down by the back of the shovel, and is ready then to be packed in bags for market.

Though the mother-liquor will show still an acid reaction when being drawn off from the settled precipitate, that is no indication of its having retained any tri-phosphate of lime. It is true that, by restricting the proportion of quick-lime precipitant, as directed, nearly all the iron and aluminium compounds are kept back in solution, but the precipitation of all the tri-phosphate of lime is assured if the manipulations are conducted properly.

The mother-liquor, then, is a mixture of aqueous and hydrochloric solutions of chloride of calcium and iron and aluminium oxides and phosphates.

To determine whether any traces of phosphate of lime are present, it is only necessary to add a few drops of lime-water to a small portion of the liquor, which, in that case, will give a white precipitate. If there is any bluish-grey or brown tint in the precipitate, it may be inferred that the latter consists wholly of iron and aluminium compounds.

My experience proves that, with the quantity of lime which has been prescribed and a faithful performance of the stated manipulations, there is little or no phosphate of lime left in the mother-water.

The precipitate, consisting chiefly of diphosphate, which is the prime object of the refining process to which this chapter relates, may be rendered nearly anhydrous by pushing the drying process to extremity. But, for the sake of its handsome appearance and more active solubility in the soil, it is expedient to send it into market merely as a powder of ordinary dryness. In this form it

retains water of constitution and some accidental moisture.

To clear the mother-water of its iron and aluminium constituents and render it a pure aqueous solution of chloride of calcium for utilization, as directed in Chapter XI, thin milk of lime is to be added to it in a suitable vat until a red litmus paper, dipped therein, becomes blue. The above-named constituents are thus precipitated, and after a repose of some minutes leave above a clear liquor of chloride of calcium, which is to be drawn off. The deposit is then washed with several relays of fresh water, drained, and pressed in cloths, or dried to powder in the kiln, according to the use for which it may be intended.

If it is the product of a raw mineral which, like Cooperite or Navasa Guano, contains a very large proportion of phosphates of iron and alumina, then it may be reserved advantageously for the uses set forth in Chapters XIX, XX, and XXI.

Dissolved in sulphuric acid, it becomes much superior to the "Alta Vela and Redonda Guanos" as a material for defecating sewage,

and manufacturing purposes. In hydrochloric solution it is an excellent disinfectant. As a dry powder it is a fertilizer of fair but comparatively inferior grade.

Morfit's Process (B).

This important modification of the preceding (A) method possesses novelty and many great advantages. In the first place it eliminates the iron and aluminium compounds usually present in the raw mineral phosphates, and thus delivers the phosphate of lime constituent as a pure product. Secondly, it utilizes as precipitant the iron and aluminium compounds which it eliminates.

This means insures uniform results with the least amount of labour and the greatest simplicity of operation. It removes the expediency, too, of roasting the raw mineral previously to digesting it, as prescribed hereinbefore, for rendering the iron and aluminium constituents insoluble.

Indeed, when these latter are in large proportion and mostly as phosphates, they can be turned to profitable account as by-pro-

ducts. Hence, those highly alumino-ferruginous phosphates of lime, like "Navasa Guano" or "Cooperite", which are such objectionable materials for the ordinary processes, become quite eligible in connection with this mode of treatment.

The crude phosphate of lime having been selected, is to be powdered finely, and digested in a raw state with the requisite amount of hydrochloric acid. The proportion of the latter will depend upon the composition of the former, as determined previously by a careful analysis. There must be so much for the carbonate of lime constituent, an additional portion for the triphosphate of lime element, and a further quantity for their alumino-ferruginous associates. The data for calculation are given in the preceding chapters, and express the chemical equivalent ratios.

The apparatus and manipulations are the same, also, as described for the (A) process just previously recorded.

When the hydrochloric solution of the raw mineral, together with the wash waters from the latter, are in the precipitation vat,

they are to be mixed and heated to boiling by means of the "*blow-up*."

Previously, however, a stock or capital of the alumino-ferruginous compounds must have been accumulated by precipitating the mother waters of the previous process with milk of lime, after the separation of their phosphate of lime freight.

It is only necessary to add thin milk of lime until the mixture in the vats turns blue a red litmus paper. A slight excess of lime is unimportant. The greyish blue or lead-colored precipitate which falls down is the desired material. It may contain, possibly, some little phosphate of lime, but that is immaterial; for it is one of the advantages of this process that its operation and economy are undisturbed, whether an excess or deficiency of the precipitant may have been used. All is brought right by the easiest of manipulations, as will be explained directly in the proper place.

The precipitate, after repose, is to be relieved of the clear liquor of chloride of calcium which rests above it. This is drawn off through taps suitably placed, or by means

of a syphon, and economised as directed in Chapter XI. One washing with fresh water will now suffice for the precipitate, and it is to be accomplished by the aid of the "*blow-up*." The wash water, after repose, is to be drawn off and mixed with the previous mother water.

The precipitate, in its pulpy state, is ready now for use, as the precipitant of the hydrochloric liquor obtained by digesting the raw mineral.

This liquor consists of calcium, iron and aluminium chlorides, together with tri-phosphate of lime, and iron, and aluminium phosphates in solution. It is to be brought to boiling by means of the "*blow-up*," and treated with the pulpy precipitate afore said by shovelfuls of the latter at a time. When the first portion is added it will not cloud the liquor if the latter is very acid; but, as subsequent doses bring about the point of neutralization, a white precipitate begins to form. This is my Colombian phosphate of lime; and when it ceases to be produced, the addition of pulp must be discontinued.

As the pulp is rather lighter than the acid liquor, it floats on or near the top, so that it can be observed readily, by the perfect solution of a preceding dose when it is proper or necessary to supplement it with a succeeding one.

In this way an excess may be avoided, but at the same time can be removed, when it occurs, by the mere addition of some fresh acid liquor.

The alumino-ferruginous pulp, in neutralizing the hydrochloric acid throws down only the phosphate of lime. All of the other constituents of the raw mineral which may have been dissolved out during the digestion, will remain in the mother liquor; and this latter, after repose, is to be drawn off from the subsident precipitate for treatment, as will be explained hereafter.

Upon the precipitate is now to be poured a quantity of fresh acid liquor, equivalent to the original volume of that just thrown down; and this relay must contain the same total of phosphate of lime as the first liquor. Steam is then let in through the "*blow-up*" for five or ten minutes, after which the heat-

ing must be continued by means of the closed tubular coil at the bottom of the vat, until the mass evaporates to the consistence of a stiff, dry mush. Fresh water is then to be added, the whole mixed thoroughly by a current of steam through the "*blow-up*," and allowed to rest.

The precipitate which settles is di-phosphate, containing more or less of tri-phosphate of lime; and the clear liquor above—to be known as the mother liquor—is a mixed solution of calcium, iron, and aluminium chlorides. Oftentimes, however, the alumino-ferruginous portion of the liquor may be chiefly phosphatic.

The mother liquor is to be drawn off from the precipitate into a suitable vat or reservoir; after which the latter is to be washed with several relays of fresh water. The wash waters are in all cases to be mixed with the mother liquor. If the precipitate is to be converted into superphosphate, it should be taken directly after the washing, from the precipitation vat to the pug-mixer (Pl. 21).

On the other hand, when it is to be sent

into market as such, it should be heated after the last washing by means of the "*blow-up*," with an aqueous solution of one or two per cent. of sulphate of ammonia, to destroy any hygroscopic tendency that may be retained through lingering traces of chloride of calcium. Finally, it must be dried on the kiln; and then crushed to powder with the back of the shovel, or by means of Carr's disintegrator; after which it is ready to be packed into bags for market.

The quantity of alumino-ferruginous pulp which may be required will depend, not only upon its state of moisture, but also upon its chemical composition. That is, if the pulp is more oxide than phosphate, less weight will suffice for the precipitation, and *vice versa*. In my experience, the only practical way of determining this point with precision, and quickly, is to test a small portion of the liquor, experimentally.

Thus, a given volume of ten fluid ounces of the acid liquor is treated, while boiling, with the pulp, until precipitation ceases. From the weight, or even the bulk, of the



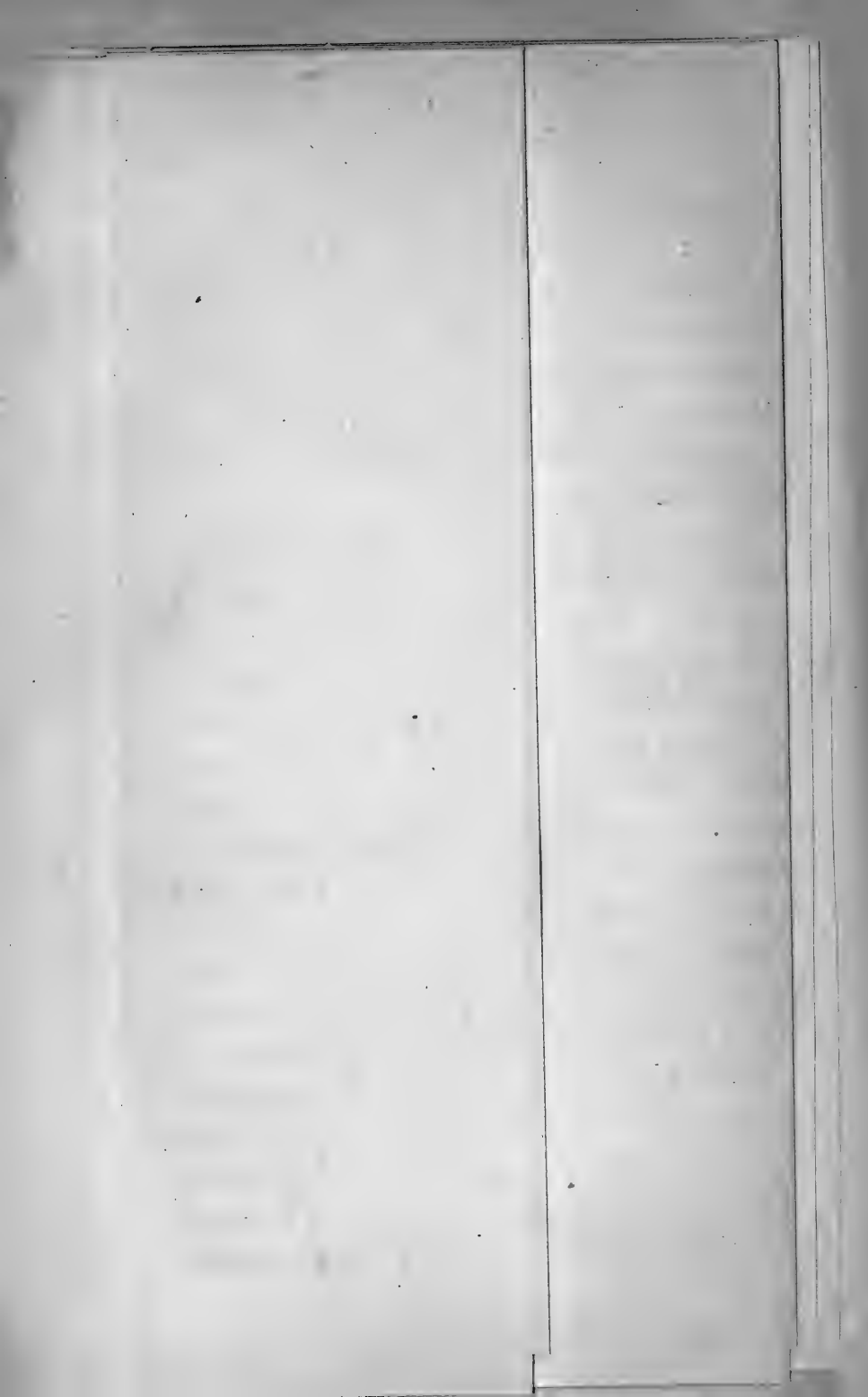

pulp consumed, may be estimated, with sufficient accuracy, the whole quantity which the total of the liquor in the vat will require.

Of course, the entire volume of liquor must have been gauged previously; and for this purpose it will be convenient to fix a permanent measure-rod to the interior side of the containing vat.

The mother liquor and wash waters combined are an aqueous solution of calcium, iron, and aluminium chlorides, associated with hydrochloric liquor of alumino-ferruginous phosphates. Possibly, there may be present, also, some traces of phosphate of lime. This latter may be wholly separated by merely adding, with caution, *only* that quantity of alumino-ferruginous pulp which is necessary to precipitate it.

The mother liquor, then, is an admirable means for defecating town-sewage, according to the methods explained in Chapter xx.

But if its burthen of aluminium and iron compounds is large, then this must be separated and sold for the profitable purposes described in Chapters xix and xxi. Owing to its pulpy condition, it will be very soluble

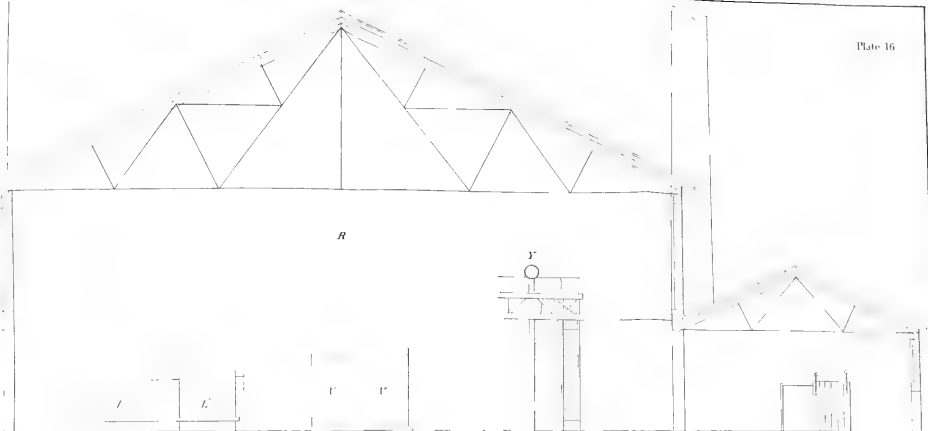

SECTIONAL ELEVATION

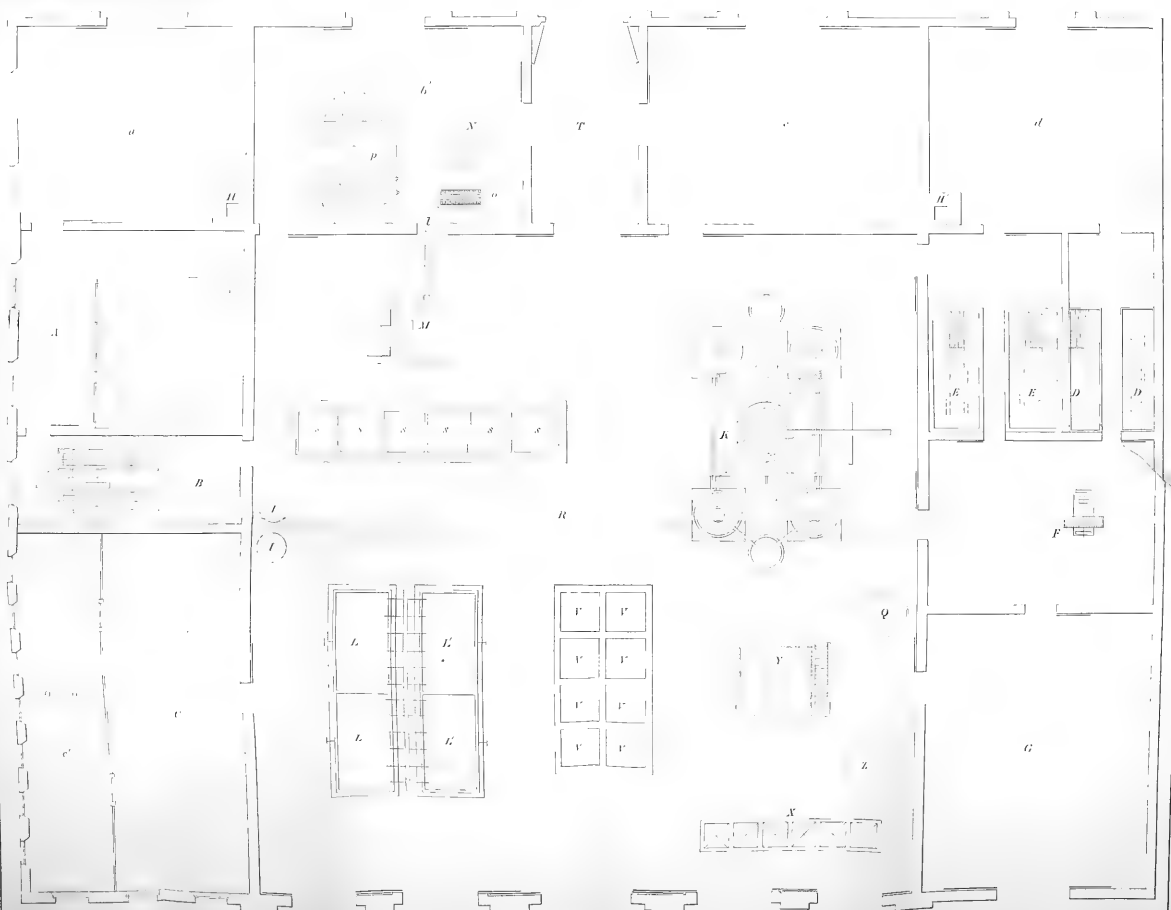

GROUND PLAN.



in acids, and, therefore, a much more desirable raw material than "Redonda Guano", "Alta Vela Guano", and kindred minerals. Moreover, it will have the great advantage of being a domestic by-product, free from the risks and expenses of importation.

The only treatment necessary to separate it from the mother water is the addition of thin milk of lime until the liquor turns blue a red litmus paper. The precipitate which falls leaves above a pure solution of chloride of calcium, which is to be drawn off and utilized, as directed in Chapter XI. The precipitate, after one or two washings, with fresh waters, is to be drained or pressed in cloth, and barrelled for market.

As the mother liquor, from the treatment of the first lot of mineral, will serve to furnish the pulpy precipitant by this treatment an indefinite number of successive times, it will be seen that only the first batch is required for an uninterrupted continuity of precipitating operations. The mother liquor will give back always the whole of the precipitant when prompted by the addition of milk of lime.

There will be constantly, therefore, a daily recurring quantity of this by-product for the profitable applications set forth in Chapters XIX, XX, and XXI.

ƒ. Thomas Way's Process.

My knowledge of this method is little beyond that which the specification of the patentee supplies. It, however, yields a handsome product in the form of a fine white powder, which has, according to Wanklyn's analysis, the following composition, per cent.

Hygrometric moisture	-	-	-	2.18
Constitutional water	-	-	-	14.69
Sand and matters insoluble in acids	-	-	-	9.24
Sulphate of lime	-	-	-	2.17
Oxides and phosphates of iron and aluminium with a little of magnesia	-	-	-	7.83
Lime	-	-	30.62	} Di-phosphate of lime - 66.83
Phosphoric acid	33.21			
				99.94

“This invention relates to the production from ordinary phosphate of lime and the use for manure of a compound of lime and phosphoric acid intermediate in composition and

character between ordinary insoluble phosphate of lime and acid or soluble phosphate of lime. By ordinary phosphate of lime I mean to express the phosphate of lime existing naturally in bones, bone-ash, animal charcoal, and in the usual mineral varieties of this substance, and by acid phosphate or soluble phosphate of lime I mean that form of readily soluble phosphate of lime which is produced by the action of sulphuric acid on ordinary phosphate of lime, and which exists in the substances usually called 'super-phosphates'. The ordinary phosphate of lime first mentioned contains three equivalents or combining proportions of lime to each equivalent or combining proportion of phosphoric acid, and contains lime and phosphoric acid in the proportion of lime 53·9, and phosphoric acid 46·1. I shall, for sake of convenience, call this tri-phosphate of lime, in reference to the three equivalents of lime it contains. The acid phosphate or soluble phosphate of lime contains only one equivalent or combining proportion of lime to each equivalent or combining proportion of phosphoric acid; I call this mono-phosphate of lime, as containing only one equivalent of lime. It contains lime and phosphoric acid in the proportion of 28 parts of lime and 72 parts of phosphoric

acid. Now, the compound of lime and phosphoric acid, which is the subject of this invention, contains two equivalents or combining proportions of lime to one equivalent or combining proportion of phosphoric acid; I therefore call this substance di-phosphate of lime, and it contains lime and phosphoric acid in the proportion of lime 43·8 parts, and phosphoric acid 56·2 parts. This compound is known by chemists to exist, and is described in some works on chemical science; but it has not been made for practical use, nor by any of the methods about to be described, nor has it been used or proposed for use as manure, for which I have ascertained that it is well suited. For, whereas tri-phosphate of lime, whether in its natural state or artificially produced, is not sufficiently soluble in water for purposes of vegetation, and the mono-phosphate or ordinary 'super-phosphate' is so readily soluble in water that it is liable, in some cases, to be washed out of the soil by heavy rain, and so cause a loss of a valuable and expensive product, the di-phosphate of lime is soluble to the extent of from 15 to 25 grains only in a gallon of pure water, and to a larger extent in water containing carbonic acid; it is, therefore, free from both the causes of objection above referred to, and

its use for manure will be attended with great advantage and be found to be economical.

“I have ascertained that di-phosphate of lime can be produced with sufficient economy to enable it to be practically used as a manure by the methods which I proceed to describe.

“1. I take any form of tri-phosphate of lime, such as bone-ash, animal charcoal, coprolites, apatite, or phosphatic guano, and, having ascertained by analysis the proportion of carbonate and phosphate of lime in it, I add to it hydrochloric acid in such quantity as shall be sufficient to dissolve the carbonate of lime and also to unite with one-third part or one equivalent of the three equivalents of lime contained in the phosphate of lime, avoiding the use of any considerable excess of acid beyond that mentioned above. I dilute the acid before employing it with as much water as shall have been found, by previous experiments, necessary to enable it to be mixed intimately with the powdered phosphate, so that every portion may be well moistened; and, in this mixing, I employ some suitable mechanical arrangement, such as an ordinary pug-mill, used for mixing clay. I allow the mixture to rest until I find, by treating a small portion with cold water and testing the filtered solution by ammonia or lime water, that very

little phosphate of lime remains in solution. I find that a gentle temperature given to the mixture greatly promotes the production of di-phosphate; and I sometimes dry the mixed materials on hot plates or by other convenient arrangement, taking care that the heat does not exceed 250° Fahrenheit; I then add cold water, and wash out the chloride of calcium, which is produced from the carbonate of lime and the $\frac{1}{3}$ part of the lime of the tri-phosphate. The washed residue is the di-phosphate of lime in a state more or less pure, which I dry for use at a temperature which should not exceed 240° or 250° Fahrenheit. Before allowing the wash-water to run to waste I render it alkaline by lime, and by subsidence or filtration I separate and preserve the insoluble matter which will contain phosphate of lime. As a source of tri-phosphate in the foregoing process, I prefer to employ bone-ash, or animal charcoal, or tri-phosphate artificially prepared. In carrying this process into effect the proportion of hydrochloric acid to be used will depend upon the proportions of phosphate of lime and carbonate of lime with bone-ash, animal charcoal, or other phosphoric substance or mixture of substances employed and the strength of the hydrochloric acid itself. If liquid hydrochloric acid of specific gravity

1.145, and containing about 30 per cent. of real acid, is used, it will require 240 parts by weight of such acid for each 100 parts of carbonate of lime, and 76 parts for each 100 parts of phosphate of lime present in the substance or mixture of substances to be acted upon; for instance, supposing that the crude phosphate contains 70 per cent. of phosphate of lime and 10 per cent. of carbonate of lime, the quantity of acid of 30 per cent. to be added to each 1000 lbs. of such crude phosphate will be 240 lbs. for the carbonate, and 532 for the phosphate of lime, or together, 772 lbs.; and so on, in relation to the varying proportions of the phosphate and carbonate of lime in different substances treated. As before mentioned, I find that the production of di-phosphate of lime is very much assisted by the application of a gentle heat to the mixture; but I am careful to regulate the temperature, as, otherwise, the result of the action will be to produce the ordinary tri-phosphate of lime instead of the di-phosphate. I have named 250° Fahrenheit as a temperature which is both safe and sufficient for the purpose. This amount of heat may be obtained by hot plates, or ovens, or other ordinary means. When heat is to be employed, an excess of hydrochloric acid may be used

with advantage, but arrangements must be made to collect and condense the fumes of the excess of acid which will be driven off.

“2. I treat any mineral or other phosphate with sufficient hydrochloric acid to dissolve the tri-phosphate, and to the clear solution diluted with water, if necessary, I add bone-ash, animal charcoal, precipitated tri-phosphate, or finely-ground mineral phosphate (preferring the bone-ash, animal charcoal, or precipitated tri-phosphate) in such quantity, that the tri-phosphate added is equal to that in the solution, and then I proceed to mix and wash as in the previous case. This second process is, as will be seen, a simple modification of the process first described, and the instructions given in respect thereto will, for the most part, be applicable to the second process, and are sufficient for the carrying the said process into practical effect.

“3. I treat substances containing tri-phosphate of lime with sulphuric acid in the same manner as in making ordinary super-phosphate of lime, and I dissolve out in a small quantity of water the soluble acid mono-phosphate produced; to this solution I add bone-ash, animal charcoal, precipitated tri-phosphate, or any mineral phosphate, in fine

powder (preferring the bone-ash, animal charcoal, or precipitated tri-phosphate) in such quantity, that the tri-phosphate added is equal to that in the solution. I mix these materials as in the previous case; but, as the mixture does not contain any chloride of calcium, it does not require washing; but after standing in the moist state for a sufficient time to allow of the production of the di-phosphate (and, as is ascertained by testing, as already explained in respect to the first process) it is dried, if necessary, at a temperature of 240° or 250° Fahrenheit for use. In some cases I prefer to treat the phosphate of lime in the first part of this process with sufficient sulphuric acid to combine with the whole of the lime and to liberate phosphoric acid. In this case I add to the solution of this acid as much bone-ash, or other substance as contains twice the phosphoric acid contained in the solution. In making use of the method 3, the solution of acid phosphate or of phosphoric acid produced by the action of sulphuric acid on phosphate of lime may, if necessary, be concentrated by evaporation before mixture with the bone-ash or other material. The quantity of this solution used should be sufficient to act upon the carbonate as well as the phosphate of lime of the bone-

animal charcoal, or other phosphate; the heat employed in this case may be as high as 350° without injury.

“4. I evaporate a solution of tri-phosphate of lime in hydrochloric acid, and heat the residue to such temperature as shall be sufficient to enable the mono-phosphate of lime to react upon one equivalent of the chloride of calcium present and condensing the hydrochloric acid vapours given off. I may digest the residue with chalk or other form of carbonate of lime to decompose any mono-phosphate of lime which may remain, and I wash the di-phosphate produced to free it from chloride of calcium, taking care to precipitate from the wash-water by lime any phosphoric acid it may contain. In carrying out this process, I dissolve the crude phosphate of lime in hydrochloric acid diluted with the smallest possible quantity of water, so as to avoid unnecessary evaporation. I dry down the solution in pans or ordinary evaporating furnaces, taking care to arrange for the collection and condensation of the acid fumes which will be driven off; the heat should not exceed 350° Fahrenheit; otherwise, tri-phosphate of lime may be produced. The materials should be frequently stirred; and, in order to complete the decomposition, the dry products, after re-

moval from the furnaces, may be powdered, mixed, and again heated. I wash the di-phosphate with or without addition of chalk, according to the amount of acid phosphate undecomposed, and dry the di-phosphate as in the previous processes. I precipitate any phosphate in the wash-water with caustic lime.

“5. I find, that when a solution of phosphate of lime in hydrochloric acid is precipitated by milk of lime or lime water, as is well known, a small part of this precipitate may be produced in the state of di-phosphate, and special precautions will be necessary, as hereinafter described, to prevent the greater part being produced in the state of ordinary tri-phosphate of lime. When preparing the di-phosphate of lime in this manner, I add the lime very gradually, and stop short in the addition of lime some time before the liquid becomes alkaline; that is to say, whilst the mixture is still strongly acid with the acid mono-phosphate of lime and remains so. After continued stirring I run off the liquor, and, having washed away the chloride of calcium, I dry the residue, which is the di-phosphate. I am careful to add to the liquor which is run off, and to the water with which I wash away the chloride of calcium from the

di-phosphate, sufficient lime to precipitate any phosphate it may contain before discharging it to waste; or, I add, in the first instance, sufficient lime to render the liquid alkaline. And, to precipitate all the phosphate of lime, I run off the liquid, and digest the precipitate in a fresh and strong solution of phosphate of lime in hydrochloric acid, or in a solution of acid phosphate or mono-phosphate of lime, by which the whole or greater part is converted into di-phosphate of lime, which I wash and dry as before.

“6. In order to precipitate the di-phosphate of lime free from tri-phosphate of lime from a solution of phosphate of lime in hydrochloric acid, I use carbonate of lime in the form of chalk limestone, magnesian limestone, or marble, which I digest with the solution; I find that, in this case, no tri-phosphate of lime is produced. If an excess of chalk or other carbonate of lime has been employed, I get rid of this by digesting the di-phosphate in a further quantity of the phosphate solution.

“In carrying out the method I use any ordinary vessel or tank, and I prefer to employ chalk in very fine powder as a precipitant. I agitate the solution of phosphate in hydrochloric acid with the chalk in vats furnished with revolving arms or beaters, as

is well known, till such time as I find by examination of the liquid that the greater part of the phosphate is precipitated as di-phosphate, which I then wash and dry; or I mix the solution of phosphate with chalk in a pug-mill, and leave the mixture at rest till the decomposition is complete, when I wash out the chloride of calcium by cold water. If the hydrochloric acid has been fully neutralized by phosphate of lime, the quantity of chalk to be used will be about one-third that of the real phosphate of lime in the solution.

“It will be understood that in all cases when di-phosphate is washed to separate chloride of calcium, the wash-water should be precipitated with lime to avoid loss of phosphate. I use the di-phosphate of lime produced by either of the foregoing methods without further treatment, or after the addition of a small quantity of sulphuric or other mineral acid as manure, and I also employ it in the manufacture of phosphorus. I find that the di-phosphate of lime is only soluble to a limited extent in cold water; when the water is heated the di-phosphate is converted into mono-phosphate or acid phosphate, and tri-phosphate or insoluble phosphate, and I sometimes treat the di-phosphate in this

manner for the purposes of manure or for other practical uses."

Deligny's Process.

This process, by Ernest Deligny, of Paris, refers to the production of sesqui-basic phosphate of lime; and I give the description of it in a translation of that chemist's own language:—

"My process relates to the production of what may be termed sesqui-basic phosphate of lime, which product is obtained from bones, mineral phosphates, or other phosphatic sources, and which is soluble in water, or in water containing carbonic acid, and it consists, first, in submitting tri-basic phosphate of lime, either natural or artificially prepared, to the action of acid phosphate of lime, whereby a sesqui-basic phosphate of lime is obtained; second, in submitting to the action of heat either that product, which is obtained in effecting the decomposition of bones, coprolites, or other phosphate of lime, by means of hydrochloric acid, or a mixture of a solution of chloride of calcium and of acid phosphate of lime, whereby the chloride of calcium is in part decomposed, and a sesqui-basic phos-

phate of lime formed. The solid sesqui-basic phosphate of lime thus obtained is to be separated from the salts of lime contained in the supernatant solution, and after having been washed and dried may be employed for such purposes as the acid phosphate of lime is now used, or for other applications.

“The reactions and operations indicated in the Specification of Letters Patent granted to Michael Henry as a communication from Ernest Deligny, and bearing date the Twenty-first of April, One thousand eight hundred and sixty-nine, No. 1224, are obtained in metallic vessels heated by an open fire, and the temperature may be raised considerably above 212° Fahrenheit by reason of the quantity of chloride of calcium contained in the liquids.

“In practically carrying out these operations, however, difficulties are encountered when a liquid is heated in which a precipitate is formed. This latter adheres to the sides of the boilers and exposes them to the risk of being burnt. This evil is so much the more serious that it becomes necessary to employ leaden boilers, iron being too easily attacked. I, therefore, propose to apply the heat by injecting steam into the liquid itself, which also allows of the employment of wooden

vessels. It was, however, discovered that at the boiling temperature thus produced the reactions were modified, and that whatever was the duration of the time of heating, the crystallized precipitate obtained remained in the state of sesqui-phosphate of lime, which may be represented by the formula, $2\text{CaO}, \text{HO}, \text{PO}_5 \times 3\text{CaO}, \text{PO}_5$; or a combination of an equivalent of bi-basic phosphate, with an equivalent of tri-basic phosphate, which retains up to 260° Fahrenheit an equivalent of water of combination.

“ This novel product is obtained in the form of a fine white brilliant crystalline powder of great density, which is rapidly precipitated from the liquid in which it is produced. It is washed with the greatest facility, and is, by that means, completely freed from the chloride of calcium, and it may be easily drained and dried. The resulting product is soluble in water, or in water charged with carbonic acid. The preparation of this product is effected by attacking mineral phosphates of lime or bones with hydrochloric acid, and thus producing a concentrated solution of soluble acid, phosphate of lime, and chloride of calcium, and effecting the reaction by means of heat of the acid phosphate of lime upon chloride of calcium and the precipitation

of the bi-basic phosphate of lime or of the tri-basic phosphate of lime, setting, thereby, free one half or the whole of the hydrochloric acid employed for dissolving the phosphates originally operated upon. The tri-basic phosphate, upon being heated by means of a jet of steam with the acid phosphate, is converted into a sesqui-basic phosphate, and a crystalline deposit is formed. The reaction is more easily produced if the acid phosphate be in excess; or the sesqui-basic phosphate of lime may be produced by adding lime to a solution of the acid phosphate of lime, and thus producing tri-basic phosphate of lime, which by reason of the presence of the acid phosphate upon the application of heat converted into sesqui-basic phosphate of lime. Nearly the whole of the phosphoric acid contained in the liquid may be thus precipitated in the form of crystalline sesqui-basic phosphate. It is advisable, however, not to precipitate the whole of the phosphoric acid, as, should iron be contained in the phosphates, it would be precipitated and would injure the purity of the product. As soon as the reaction is terminated, the supernatant liquid may be poured into a separate vessel and allowed to settle, and the liquid containing the chloride of calcium be separated (which may be applied

to any of its known uses). The precipitated phosphate is drained and washed, and finally dried either in the open air or in a stove, which is heated by utilizing waste heat."

Chloro-Phosphate of Lime.

This is a peculiar product, originated by J. Thomas Way, who claims for it the grade of a potential fertilizer. The subject has been studied with the great ability which characterizes all the professional work of that chemist; and it is due to both him and the reader, that I should give the description of the process in its author's own language, which is as follows:—

"Heretofore, it has been usual to employ in the manufacture of superphosphate of lime, oil of vitriol or sulphuric acid to render soluble the phosphate of lime, which it does by combining with a part of the lime forming gypsum, which is practically insoluble and remains without inconvenience in admixture with the soluble phosphate. It has not been practicable to use hydrochloric acid in place of sulphuric acid in this manner, because the mixture, if so made, would be deliquescent and unfit for the ordinary purposes of manure

from its containing free or uncombined chloride of calcium.

“Now, this process consists of different methods of employing hydrochloric acid in conjunction with sulphuric acid in such manner, that an article of high quality and free from the objection above-named, is obtained more economically than by the use of sulphuric acid alone.

“The methods to be described depend upon the production of a compound of acid or mono-phosphate of lime with chloride of calcium in the proportion of one equivalent of each. This salt, which I call chloro-phosphate of lime, was discovered by myself several years ago; it is, practically, non-deliquescent.

“If a phosphate of lime were met with in nature consisting of one equivalent of phosphoric acid united with two equivalents of lime, it would suffice with such a phosphate to dissolve it in hydrochloric acid and evaporate to dryness to obtain the salt above-mentioned. During the evaporation the phosphoric acid would decompose one half or one equivalent of the chloride of calcium present with the escape of an equivalent of hydrochloric acid and the formation of mono-phosphate of lime, which would unite with the



MOR

rest of the chloride of calcium to form 'chloro-phosphate of lime'. But it so happens that ordinary phosphate of lime contains three equivalents of lime to one equivalent of phosphoric acid, and a solution of this when evaporated gives an equivalent of chloride of calcium in addition to that which can combine with acid phosphate of lime; this additional equivalent renders the product deliquescent and practically unfit for manure.

"Now, the object of the processes to be described is to adjust the balance between the lime and phosphoric acid, so as to reduce the chloride of calcium left in the product to one equivalent for each equivalent of phosphoric acid; and it is manifest that this can be done by decreasing the quantity of lime or by increasing the proportion of phosphoric acid.

"I shall shortly recapitulate the methods by which I accomplish this object.

"I dissolve mineral phosphate of lime, burnt bones, or other substances consisting principally or largely of phosphate of lime, in hydrochloric acid of any convenient strength, preferring, however, a solution of this acid of sixteen degrees Twaddle or sixteen per cent. real acid. The solution of phosphate so made, which I shall call 'the liquor', I deal with in one or other of the following ways:

ELEVATION.



PLAN



GENERATOR AND VATS FOR PRECIPITATION BY AMMONIA

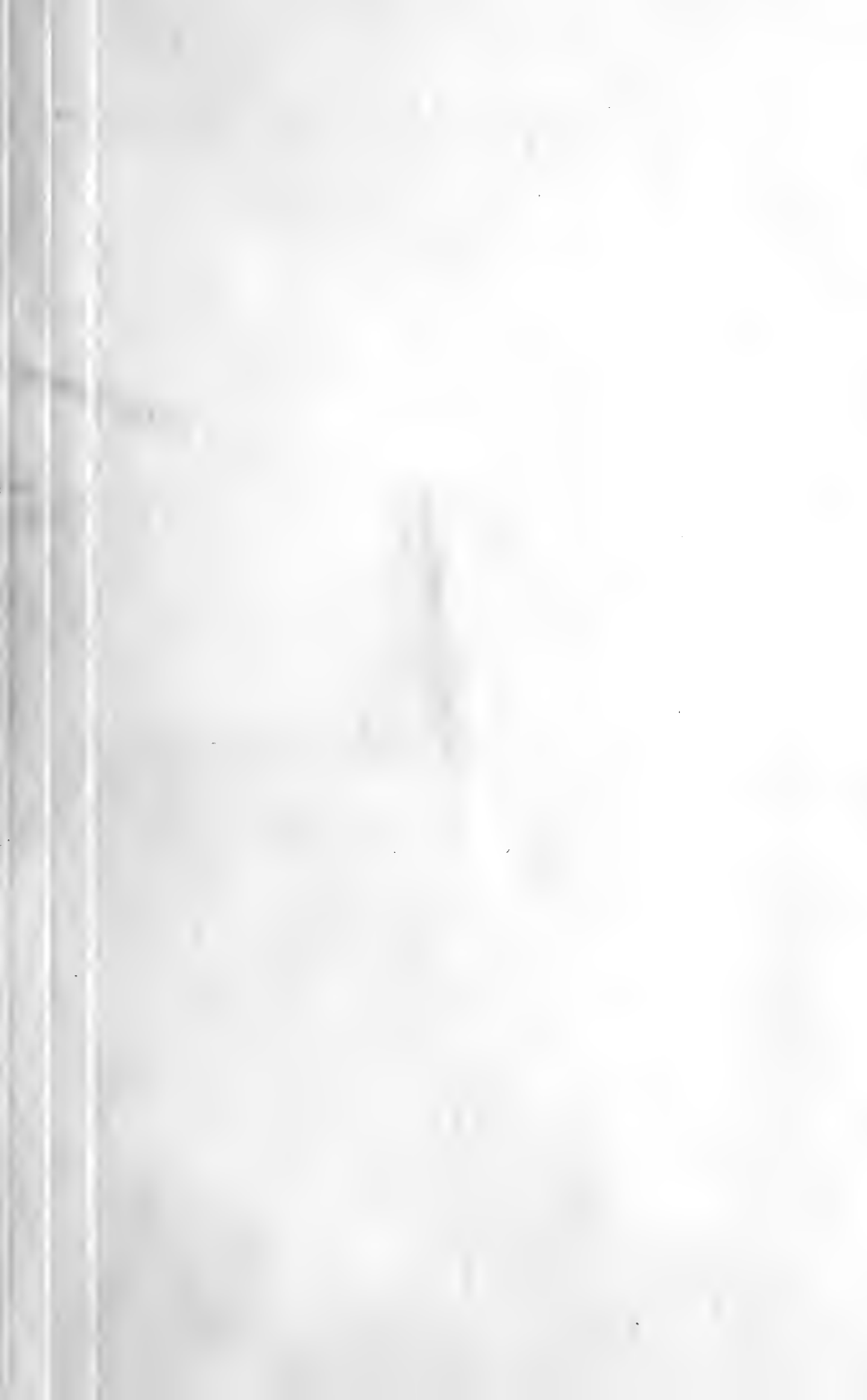

“And, in order to a more easy comprehension of the subject, I will, in the first instance, suppose that the liquor contains phosphoric acid and lime in the proportion of one equivalent or combining proportion of the former to three equivalents or combining proportions of the latter. Where carbonate of lime has existed in the mineral or other phosphate of lime the proportion of lime will be greater than this; but to this I will afterwards refer.

“The following are methods of reducing the proportion of lime so as to produce chlorophosphate of lime as the product :

“A. Adding sulphuric acid to ‘the liquor’, separating by filtration the sulphate of lime produced, and evaporating to dryness.

“B. Adding sulphuric acid as in A, and evaporating the whole to dryness without separation of the sulphate of lime.

“C. Evaporating the liquor to dryness, mixing the product with sulphuric acid, and drying up the mixture by heat.

“The product in A is ‘chloro-phosphate of lime’, with some insoluble phosphate produced in the evaporation.

“In B and C the chloro-phosphate is mixed with sulphate of lime.

“D. Evaporating the liquor till crystals of

chloro-phosphate form, separating the crystals and adding to them sulphuric acid to decompose the adhering chloride of calcium, and drying up the mixture or dissolving the crystals and recrystallizing.

“ In all these processes sulphate of soda may be substituted for sulphuric acid, but at an increase of cost and a diminution in the quality of the product.

“ By all of the above methods a portion of the base is either rendered insoluble or removed.

“ The methods of increasing the quantity of phosphoric acid in lieu of diminishing the quantity of base consist in substituting for the sulphuric acid phosphoric acid or acid phosphate of lime in the processes above set forth ; the whole of the base is thus converted into chloro-phosphate. Without dissolving the phosphate of lime, in the first instance, in hydrochloric acid, I sometimes add to powdered phosphate of lime sulphuric and hydrochloric acid in such proportions as to form sulphate of lime and chloro-phosphate of lime, and I dry up the products for use.

“ Having thus recapitulated the processes which form the subject of the present patent, and each of which may in particular circumstances possess advantages, I proceed to de-

scribe more particularly the way in which they should be carried out.

“Process A.—I take any convenient quantity of the ‘liquor’ prepared in the manner already described, and having ascertained by chemical analysis how much phosphoric acid and lime it contains, I add to it such quantity of oil of vitriol, ‘brown acid’, or other form of sulphuric acid, as shall be sufficient to unite with one-third of the lime present in ‘the liquor’. For instance, I take one hundred gallons of the liquor, and having found that this quantity contains seventy-one pounds of phosphoric acid and eighty-four pounds of lime (which are the chemical equivalents in pounds in tri-phosphate of lime) I add forty-nine pounds (or one equivalent in pounds) of oil of vitriol, or a corresponding quantity of ‘brown acid’, this quantity being capable of uniting with twenty-eight pounds or one third of the lime present. I mix the sulphuric acid and the liquor by agitation, and by means of filtration through cloth or otherwise I separate the sulphate of lime, which has been produced by the addition of the sulphuric acid, which sulphate of lime I wash by successive quantities of water. The solution so obtained and the washings contain the phosphoric acid and two-thirds of

the lime originally present in the liquor. I evaporate these liquids in a reverberatory furnace or other convenient arrangement to a thick paste, collecting and condensing the vapours of hydrochloric acid which are given off during the process, and I further dry it up by steam or other heat, avoiding a temperature much above two hundred and twelve degrees Fahrenheit.

“I would remark that whilst it is necessary that the quantity of sulphuric acid should not be less than that above indicated, a larger quantity is not objectionable (except on the ground of unnecessary expense), provided that it does not exceed twice the above amount.

“When the liquor, as is frequently the case, contains more than 84 parts of lime to 71 parts of phosphoric acid, I use an additional quantity of sulphuric acid, for such excess, in the proportion of 49 lbs. of oil of vitriol (or a corresponding quantity of ‘brown acid’ or other strength of sulphuric acid, for every such additional 28 lbs. present. For instance, supposing that in 100 gallons of liquor containing 71 lbs. of phosphoric acid I find 98 lbs. of lime instead of 84 lbs., then, in addition to 49 lbs. of oil of vitriol, as in the previous instance, I require to use $24\frac{1}{2}$ more to deal with the excess of 14 lbs. of lime present in the liquor.

“ Practically it is generally known without chemical analysis what the nature of the liquor is by that of the raw phosphate from which it was produced, and the sulphuric acid necessary may readily be calculated.

“ In the final evaporation or drying up of the product I prefer to keep the temperature as little above 212° Fahrenheit as may be. Nevertheless the product is not destroyed at a temperature of 280° or 300° Fahrenheit, but at such temperature a larger proportion of the soluble phosphate becomes insoluble.

“ Process B.—This method is carried out essentially as in the case of A, with the exception that the sulphate of lime remains in the product, which is not therefore of such high quality as regards per-centage of soluble phosphate as in the other process.

“ Process C.—In this process I evaporate the liquor without addition of sulphuric acid, and the drying may with advantage be effected at a higher temperature than in A and B, namely, at 300° Fahrenheit, or even higher. With the dry product I mix sulphuric acid by suitable mechanical means, subsequently heating the mixture to 212° or thereabouts to expel hydrochloric acid. The quantity of sulphuric acid to be used in this case can be calculated in the same way as

in processes A and B, the calculation being based on the quantity of liquor evaporated, or the dry residue may be examined for the proportion of phosphoric acid and lime contained in it, and the sulphuric acid calculated as in the other cases.

“D.—This process somewhat differs from that before described, inasmuch as the chloro-phosphate of lime is removed from the excess of chloride of calcium in great part by crystallization instead of the excess of chloride of calcium being separated from the chloro-phosphate entirely by chemical agency. I evaporate ‘the liquor’ till it begins to show signs of crystallization. I allow it to cool, and I separate the crystals from the mother-liquor by drainage and pressure.

“I ascertain the quantity of chloride of calcium present in the crystals over and above the proper quantity to form chloro-phosphate, and I add an equivalent of sulphuric acid, or acid phosphate of lime, or half an equivalent of phosphoric acid for each equivalent of chloride of calcium in excess, and dry up the product at 212° Fahrenheit, or thereabouts, or I add the sulphuric acid in any additional quantity up to such quantity as is sufficient to decompose the whole chloride of calcium present, driving off the hydrochloric acid by

heat, but in this case the product is no longer chloro-phosphate of lime, but a mixture of acid phosphate of lime and sulphate of lime, similar to that made by decomposing di-phosphate of lime by sulphuric acid.

“In dealing with the liquor for crystallization, as now described, I sometimes add before evaporation lime or chalk to neutralize free acid, by which the liberation of hydrochloric acid fumes is avoided. The chalk or lime is added so long as it dissolves in the liquor.

“When dealing with the liquor by increasing the proportion of phosphoric acid in relation to the lime, I obtain the acid phosphate of lime for the purpose from ordinary superphosphate of lime, made by the action of sulphuric acid on phosphate of lime. The phosphoric acid is obtained by using an additional equivalent of sulphuric acid in excess of that employed in the manufacture of superphosphate of lime.

“I will give an example. I take 100 gallons of liquor, in which I will suppose, as before, that the relation of the lime to the phosphoric acid is as three to one in equivalents, and that the 100 gallons contain 71 lbs. of phosphoric acid and 84 lbs. of lime. To this I add so much of acid phosphate of lime as

will contain 71 lbs. or an equivalent in pounds of phosphoric acid, that being the quantity of phosphoric acid in the state of acid phosphate of lime which will combine with the equivalent of chloride of calcium in excess, or I add so much of a solution of phosphoric acid as will contain $35\frac{1}{2}$ lbs., or half an equivalent in pounds of phosphoric acid, that being the quantity of uncombined phosphoric acid which will convert the chloride of calcium into chlorophosphate. I evaporate the solution to dryness, as before. The product being, practically, chloro-phosphate of lime, if the liquor contains an excess of lime beyond the three equivalents, I increase the quantity of acid phosphate or of phosphoric acid accordingly, in the manner described, in using sulphuric acid. Instead of using solutions of phosphoric acid or acid phosphate, I sometimes employ the superphosphate itself, and mix it directly with the liquor, but in that case the product is of lower quality.

“It is also evident that the two processes of reducing the proportion of lime by sulphuric acid, etc., or increasing the proportion of phosphoric acid by its addition or that of acid phosphate of lime, may be practised conjointly, if any advantage is derivable from such a plan.

“When I treat the raw insoluble phosphate without, in the first instance, preparing a liquor by dissolving it in hydrochloric acid, I proceed as follows: I take powdered mineral or other phosphate, and, having ascertained the proportion of tri-phosphate of lime and of carbonate of lime in it, I calculate, first, what quantity of sulphuric acid is necessary to decompose the carbonate of lime, and what quantity will be required to unite with one out of every three parts of the lime present as phosphate. I also calculate how much hydrochloric acid is necessary to unite with an equal quantity of lime. For instance, if the raw phosphate to be used contains 70 per cent. of tri-phosphate of lime and 10 per cent. of carbonate of lime, 221 lbs. will contain 71 lbs. or one equivalent in pounds of phosphoric acid and 22·1 lbs. of carbonate of lime. For this quantity of carbonate of lime I shall require 21·7 lbs. of oil of vitriol, and for a third part or one equivalent of the lime 49 lbs. of oil of vitriol, or in all about 71 lbs., whilst of hydrochloric acid of 30° Twaddle or 30 per cent. I shall require 119 lbs.; that being the quantity of acid of this strength which contains one equivalent in pounds or 36 lbs. of real hydrochloric acid.

“I mix the raw phosphate with the acids

by any convenient mechanical arrangement, and allow the mixture to lie for a time for completion of the chemical action, if necessary. I finally dry the product on hot floors or otherwise, at a heat not much exceeding 212° Fahrenheit. From this product, which is a mixture of chloro-phosphate of lime with sulphate of lime and the impurities of the raw phosphate, I may obtain the chloro-phosphate by treatment with water and evaporation of the solution.

“ In the foregoing description I have provided for the giving off of hydrochloric vapours during evaporation of the liquors; this acid would be condensed in the usual way practised in alkali works. But by a modification of the process such production of hydrochloric acid can be avoided when desirable. When mineral phosphate of lime is dissolved in hydrochloric acid, the liquor is usually a mixture of free phosphoric acid with chloride of calcium, but prolonged contact with the phosphate causes this phosphoric acid to pass into the state of acid phosphate of lime by solution of a further quantity of phosphate of lime, and in this state the liquor will consist of one equivalent of acid phosphate of lime mixed with two equivalents of chloride of calcium. If to this liquor acid phosphate of

lime from ordinary superphosphate of lime (or the superphosphate itself) is added in proper quantity (that is to say, one equivalent for each equivalent of chloride of calcium in excess), and the liquor evaporated, chloro-phosphate of lime will be produced without the formation or escape of hydrochloric acid. The same result will be obtained if to a liquor of the composition described sulphate of soda is added, and the sulphate of lime produced may either be separated before evaporation or may form part of the final product. The chloro-phosphate of lime, manufactured as above described, is valuable for use as manure either alone or mixed with other substances, or it may be used in the arts as a source of phosphoric acid.

“I would have it understood that I claim the manufacture of soluble phosphate of lime in the state of chloro-phosphate (either for use as such, or for further treatment) by acting on the insoluble or natural phosphate with hydrochloric acid, preventing the preponderance of chloride of calcium by converting a portion of the base into sulphate or by the addition of a further quantity of phosphoric acid or acid phosphate of lime.”

CHAPTER XI.



THE MOTHER-LIQUOR OR WASH, AND THE MODE OF RECLAIMING ITS MATERIALS.

IN all of the preceding processes for obtaining the phosphate of lime by precipitation from its solution in hydrochloric acid, the mother-water is either wholly or partly an aqueous liquor of chloride of calcium. The almost invariable presence of carbonate or organate of lime in crude phosphate of lime makes this an absolute case, whether the precipitant may be lime, carbonate of lime, ammonia, iron or aluminium oxide or phosphate.

Pure Chloride of Calcium.

In the preparation of the phosphate of lime by ammonia, as described in Chapter VIII, the preliminary treatment, with a limited portion of hydrochloric acid, is to restrict the

action of the latter to the carbonate and organate of lime constituents of the crude phosphate. The liquor thus formed, however, will contain also some little of phosphate of lime, together with larger or smaller traces of alumina and oxide of iron, if the acid and the heat of digestion are strong. This trace of phosphate having been reclaimed by precipitating with milk of lime, which also frees the liquor of alumina and oxide of iron, the mother-liquor is then a pure aqueous solution of chloride of calcium. It is only necessary, therefore, to evaporate the liquor to dryness, or to such a dense state that it will solidify on cooling, in order to convert it into a saleable commercial article. It is generally packed in sheet-iron barrels or drums, holding each about four hundred weight. Owing to its pure state, it is well adapted for the manufacture of artificial stone by Ransome's process.

Again, in the processes of Chapters IX and X, for making the Colombian and di-phosphates of lime, the final mother-liquor is wholly an aqueous solution of chloride of calcium in a state of purity, and only re-

quires to be solidified by evaporation, in order to become a saleable and profitable article of commerce.

Being thus made largely and as a by-product, it can be sold at a price which will render it independent of all competition.

I have now in progress, with the co-operation of Dr. B. W. Gerland, a course of practical experiments for reclaiming the hydrochloric acid by the concurrent action of a stream of sulphurous acid and blasts of steam and air in the chloride of calcium mother-liquor. This should form sulphate of lime and set free the hydrochloric acid, to be used over and over again an indefinite number of times for digesting the raw mineral, and thus adapt the process to those remote regions, inaccessible to acids, which contain deposits of mineral phosphate, pyrites, and sulphuretted ores. In the roasting of the latter, sulphurous acid would be generated abundantly, so that a manufactory of refined phosphates could be thus established upon a single inaugural batch of hydrochloric acid.

When the mother-liquor is chiefly a solution of iron and aluminium compounds, it is

probable that it might be made to give up its hydrochloric acid, in a free state, by the action alone of superheated steam.

Sulphate of Ammonia as the Economiser.

As a certain amount of ammoniacal salt will be required for the composition of special fertilizers, a portion of the wash-liquor may be used advantageously for converting sulphate of ammonia into chloride of ammonium, the latter being preferable in that connection. Not only is there a small money profit by the transformation, but a gain of bulk, for the equivalent relation of the base ammonia in the chloride is much higher than in the sulphate; and much less of the weight of the former will correspond in nitrogen value with a much larger weight of the latter.

For this purpose, the wash-liquor is to be run into a clean wooden vat, constructed as described at p. 127, and shown by Plate 11. Having been brought to 212° Fahrenheit, a dense aqueous solution of sulphate of ammonia is then to be poured in during constant

agitation and heating by the currents of steam.

A double exchange of bases takes place, white hydrated sulphate of lime precipitates, and chloride of ammonium forms in solution.

Repose being allowed, the solution rises to the top as supernatant liquor, and then is to be drawn off clear, through the cocks, into the evaporating pans (Plate 13): To the deposit is now to be added some fresh water from the hydrant, and the whole boiled and allowed to settle as before. The clear wash-water is to be drawn off into the evaporating pan as was the strong liquor just previously. This washing is to be repeated with a second relay of fresh water in the same manner. The deposit is then wholly or nearly free of all ammonium salt and is to be run off into large shallow troughs placed under an open shed, where it is left to dry spontaneously. When dried, it will be a valuable substitute for ground plaster in agriculture. A portion of it will be needed for drying the bi-phosphate of lime, as explained in a subsequent chapter.

In the meantime, the liquor and its two wash-waters in the evaporating pan must be

undergoing concentration by heat to a dense solution. When it reaches the crystallizing point, the heat is to be stopped.

On cooling, it will form a solid saline cake of chloride of ammonium, which can be broken up and packed in barrels for market.

The expense of a separate vat for making the aqueous solution of alkaline sulphate may be saved by putting the requisite quantity of ammonium sulphate in the precipitating vat, and dissolving it there previously to the entrance of the *wash-liquor*. Then, by stirring as the wash-liquor enters, the decomposition will take place, as has just been explained. The currents of steam from the heating-pipes produce the necessary agitation and intermixture.

Sulphate of potassa may be used in a similar manner to re-place the ammonium sulphate whenever it is desired to produce chloride of potassium.

I distinguish by the name of economisers those agents which are employed to reclaim the wash-liquor, because they convert the latter into valuable products by saving the cost of the hydrochloric acid and improving,

otherwise, the general advantages of the fertilizer.

If sulphate of ammonia is the economiser, the necessary proportion of it is 1.32 pounds for every per cent. or pound of carbonate of lime in the original raw mineral. This will produce 1.07 pounds of chloride of ammonium and 1.72 pounds of hydrated sulphate of lime. In other words, every pound of sulphate of ammonia will react upon the wash-liquor to produce 0.80 pound of chloride of ammonium and 1.30 pounds of hydrated sulphate of lime.

Sulphate of Potassa as the Economiser.

If sulphate of potassa should be used as the economiser, the proportion required is 1.74 pounds for each per cent. or pound of carbonate of lime in the original raw mineral. The products from these ratios will be 1.49 of chloride of potassium and 1.72 of hydrated sulphate of lime. That is, every pound of sulphate of potassa employed in decomposing the wash-liquor of chloride of calcium will yield 0.856 lb. of chloride of potassium and 0.988 lb. of hydrated sulphate of lime.

A Mixture of Sulphates of Ammonia and Potassa as the Economiser.

A mixture of potassa and ammonia sulphates may be apportioned from those data when it is desired to produce the mixture of those bases. To this end, one pound of sulphate of potassa is equivalent to 0.758 pound of sulphate of ammonia. On the other hand, one pound of sulphate of ammonia corresponds with 1.32 pounds of sulphate of potassa.

When the decomposition of the wash is to be made by a mixture of these sulphates, the manipulations are the same as has been explained for them severally.

Crude Ammonia Liquor as the Economiser.

The economiser may be crude ammonia liquor in place of sulphate of ammonia; but then the lime is precipitated as carbonate with some little sulphate. The ammonia product, however, will be chloride, and in slightly greater quantity than from sulphate of ammonia as the economiser. This slight excess arises from the fact that gas-liquor

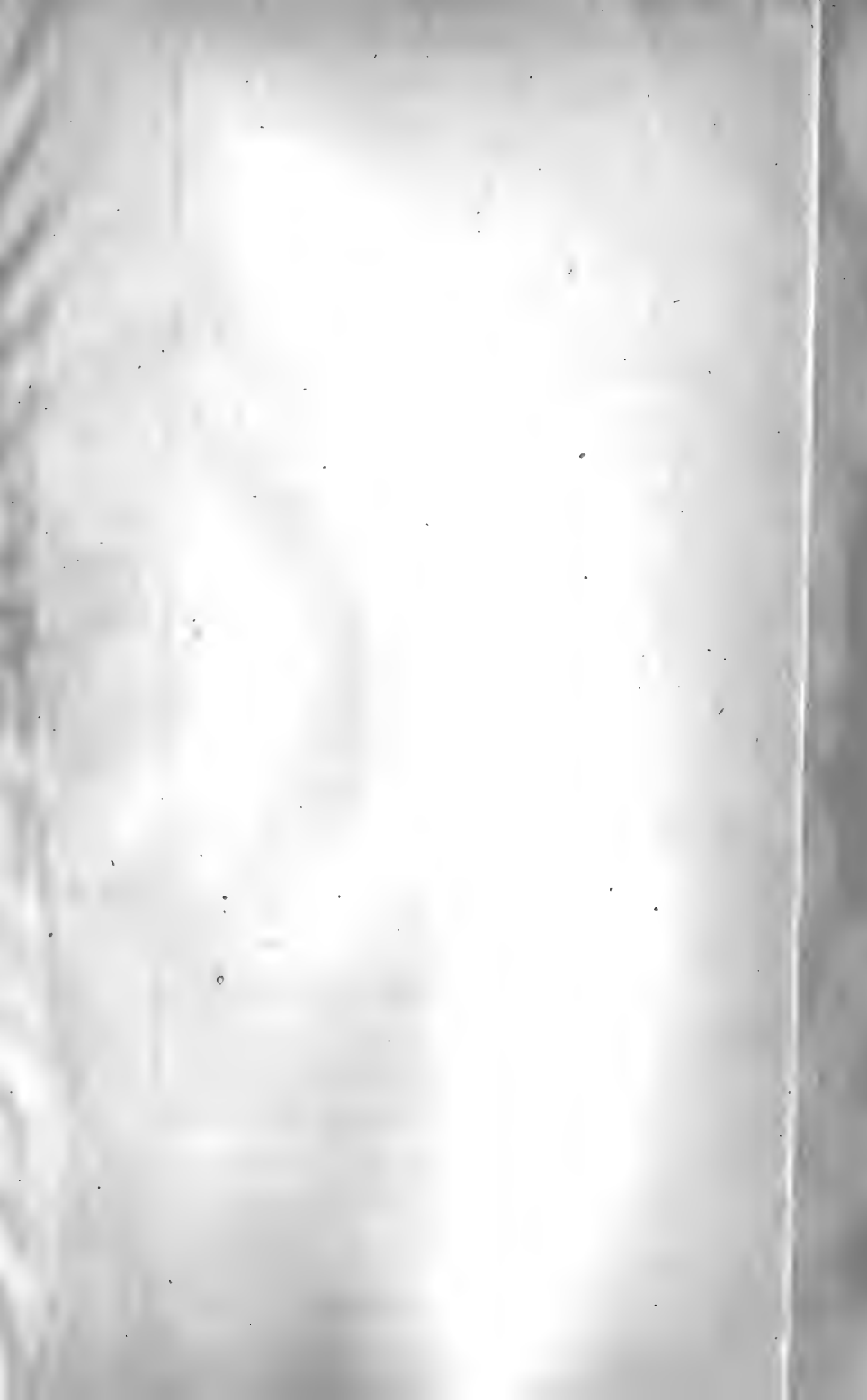

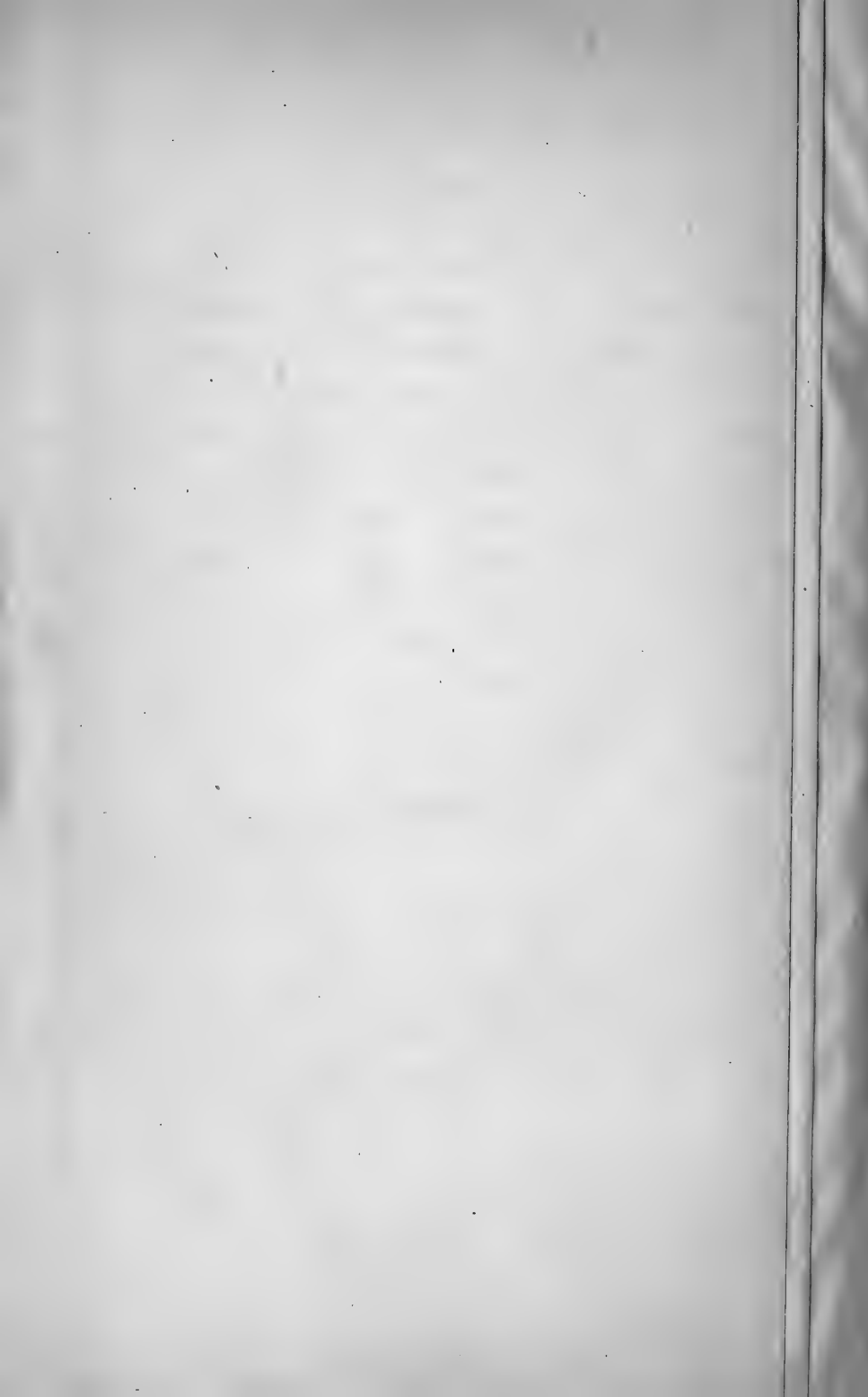

contains some chloride and other salts than the carbonate, which does the precipitation. These not being affected by the chemical action in the vat, evaporate to crystalline mass with the newly-formed chloride, when the liquor is put into the concentrating pan.

The quantity required for decomposing the chloride of calcium or *wash-liquor* will depend upon the strength of the gas-liquor. Assuming that it contains the usual average of 0.47 per cent. of dry ammonia gas, then, for every hundred pounds of hydrochloric acid of specific gravity 1.17 contained in the *wash-liquor*, there will be needed six hundred pounds of gas or crude ammonia liquor, with about twenty-five pounds additional for contingencies.

Owing to the presence of sulphate of ammonia, invariably, in the gas-liquor, the carbonate of lime precipitate will always contain more or less of sulphate of lime. The quantity of this precipitate cannot be precisely stated, on account of the variability in the composition of gas-liquor. If there is any iron present as impurity, it will give a greyish-blue colour to the precipitate, be-

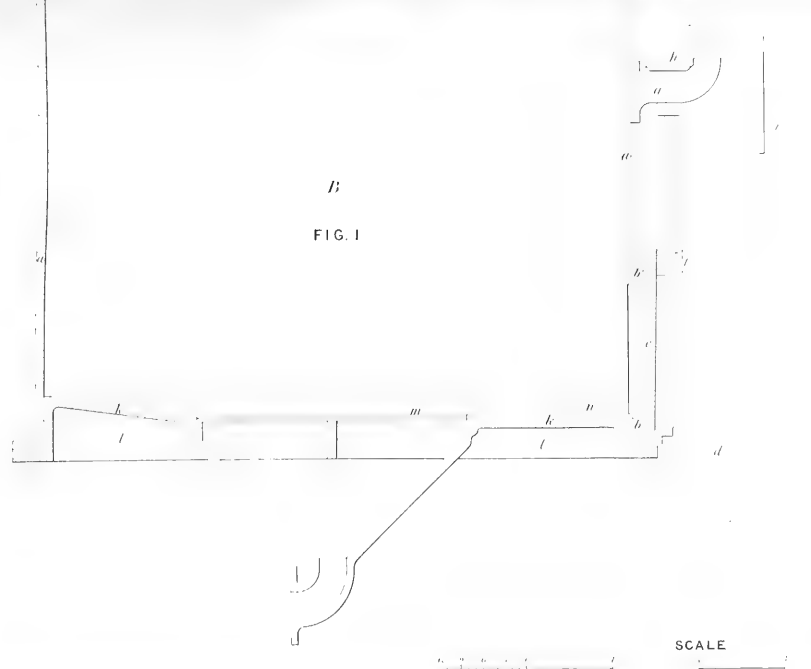

FIG. 1



FIG. 3

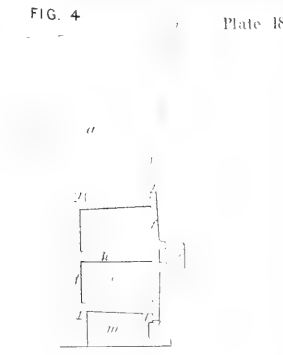

FIG. 4



FIG. 5



FIG. 6



FIG. 2

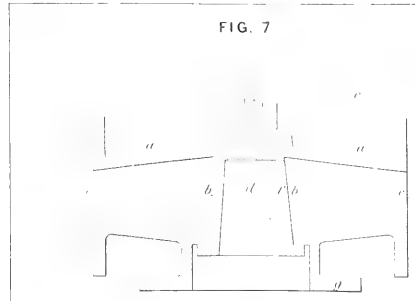

FIG. 7

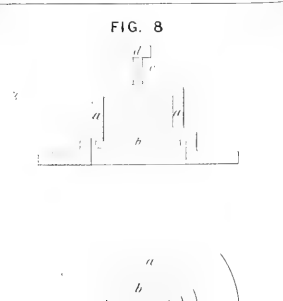

FIG. 8

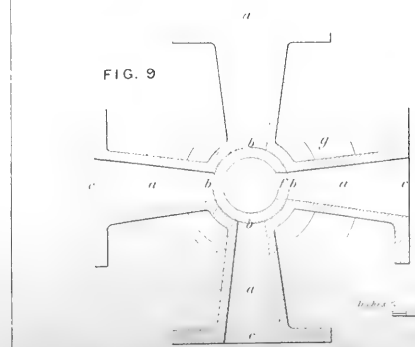

FIG. 9

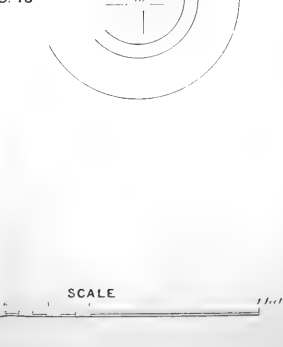

FIG. 10

DETAILS OF THE PRECIPITATION VAT & AMMONIA GENERATOR



cause of the formation of sulphuret of iron with the sulphur of the gas liquor.

Precautions must be observed to protect the workmen against the evolution of injurious sulphuretted vapour when gas-liquor is used. This is done by adding some chloride of iron to the wash-liquor, in order to precipitate the sulphuret, avoiding the use of steam, and substituting mechanical stirring.

In this case, small samples of the liquor must be drawn from the vat through try-cocks, and tested from time to time, to determine when enough of gas-liquor has been added. This will be known when a further addition ceases to throw down a precipitate.

The great profit afforded by the use of gas-liquor as the economiser renders it expedient to prefer that material to all the others, when a necessary supply can be obtained conveniently.

The abundant supply of chloride of calcium, as a cheap by-product in these processes, affords a convenient and profitable means of reclaiming from waste, as ammonia salt, the liquor of all of those gas-works which are now inaccessible to sulphuric or

hydrochloric acids. Being solid and heavy, it is indeed a most advantageous substitute for the latter in this connection, not only on account of its better transportation conditions, but for other good practical reasons.

This "mother-liquor" may be utilized, also, by passing through it concurrent streams of gaseous ammonia and carbonic acid. Carbonate of lime precipitates, and chloride of ammonium rests above as a clear liquor, to be evaporated to crystals or dryness for market.

The precipitate, on being pressed and calcined, will give quick-lime, and at the same time reproduce its carbonic acid for subsequent operations.

Phosphate of Soda as the Economiser.

Townsend's method of converting Redonda Guano into phosphate of soda (Chapter 20) gives a most advantageous liquor for converting this "mother-liquor" into pure phosphate of lime and table-salt. By mere intermixture of the two liquors, the phosphate of lime precipitates, and chloride of sodium remains in solution, to be drawn off and evaporated to dryness for market.

CHAPTER XII.

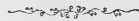

ON THE PRINCIPLES OF THE SUPER- PHOSPHATING PROCESSES.

IN the manufacture of "commercial superphosphate" by the direct action of sulphuric acid upon crude phosphate of lime, it is expedient to select that kind of the latter material which is most free from carbonate of lime, fluoride of calcium, iron and aluminium compounds, and sand or silica.

The reasons are obvious; for, phosphate of lime being the only constituent required, all of its usual associates are foreign to the process of conversion. Thus sand is a valueless component, and would dilute the product disadvantageously. Carbonate and organate of lime, oxides of iron and aluminium, are not only diluents of the product, but they invest it with a permanent tendency to dampness. Moreover, they waste both time and

acid ; being, in fact, barriers to the action of the sulphuric acid upon the tri-phosphate of lime constituent, for this last remains intact until they have been overcome chemically. I term them, therefore, profligate elements or associates.

The decomposition of tri-phosphate of lime into bi-phosphate has been explained already in full, and by diagram at p. 73, Chapter III. It has been there shown, that a very large proportion of hydrated sulphate of lime is the inevitable accompaniment of the chemical treatment of the first for conversion into superphosphate. So much is this sulphate in excess of the bi-phosphate, that even though the tri-phosphate under operation might be absolutely pure, it would not be possible to make it yield a product of better bi-phosphate strength than the following composition per cent. :—

(1) Bi-phosphate of lime (CaO, 2HO, PO ₅)	-	40·69
Hydrated sulphate of lime (CaO, SO ₃ , 2HO)	-	59·31
		100·00
		100·00

But in Nature, the instances of a pure

phosphate of lime are very rare, and on such a small scale, that they suffice only as cabinet specimens. The highest grades known are the phosphorite of Spain and certain apatites of Canada. These contain as much as ninety per cent. of phosphate of lime, when selected or so screened that the richer masses may be separated from the poorer. This culling operation shows, however, that the inferior parts form so nearly the whole amount of the mineral as to render those sources, of a very rich material for superphosphating purposes, very narrow indeed. They could not be depended upon for a supply of any greater uniform average richness than seventy per cent., even were they conveniently situated for mining and transporting the product.

Of all the raw stocks available for the manufacture of superphosphate, bone-ash is the most advantageous. This contains, on an average, seventy per cent. of tri-phosphate of lime, ten per cent. of carbonate of lime, and twenty per cent. of other, profligate constituents. The supply, though considerable, is very largely inadequate. Moreover, it

may be applied directly to the soil without any preliminary treatment, as it is sufficiently active in its natural state for enriching the soil, and thus commands a price quite too high for this manufacture.

Under the circumstances, then, which I have noted, the main reliance of the manufacturer of superphosphate for his raw basis material is, and must continue to be, coprolites, marlstones, and the so-called "Rock Guanos".

The regular and abundant supply of these materials is no unimportant consideration in their favour. But, as the best do not average uniformly more than 60 to 65 per cent. of phosphate of lime constituents, and may fall as low as 40 per cent. in that element, it follows naturally that even under the first conditions there is a large ratio of profligate elements to dilute and deteriorate the superphosphate product.

For similar reason, the lower grades yield a product in which the superphosphate holds the lowest quantitative rank of all the components. These remarks refer to the usual methods of superphosphating, by mixing the

powdered mineral phosphate of lime with dilute oil of vitriol, allowing it to dry and then powdering it.

Assuming that no earth, ground plaster, or other material has been added to promote the drying of the product, and also that bone-ash or the best available "Rock Guano" has been employed as the basis material, then, with the most careful manipulation, it is not possible to produce a "superphosphate" of greater percentage strength than is expressed by the following analytical table:—

(2) Bi-phosphate of lime ($\text{CaO}, 2\text{HO}, \text{PO}_3$)	-	32'00
Hydrated sulphate of lime ($\text{CaO}, \text{SO}_3, 2\text{HO}$)	-	58'00
Undesirable foreign matters	-	10'00
		<hr/>
Total	-	100'00
		<hr/>

Most generally, however, a more abundant material is employed, such as coprolites or marlstones, and these cannot be relied on for a higher uniform average of tri-phosphate of lime than 52 to 55 per cent. They contain, moreover, 12 to 15 per cent. of carbonate of lime. Hence, the product which represents the most of the superphosphate in the market

can have, at best, only the impoverished composition, per cent., shown by the following table:—

(3) Bi-phosphate of lime ($\text{CaO}, 2\text{HO}, \text{PO}_5$)	- 26.50
Hydrated sulphate of lime ($\text{CaO}, \text{SO}_3, 2\text{HO}$)	- 54.50
Foreign and undesirable matters	- 19.00
	100.00
	100.00

I have assumed in these calculations that no excess of acid or water has been used to prevent the “going back” of the bi-phosphate into an insoluble form or to add weight; that no foreign matter has been mixed in to promote the drying of the product; and that the manipulations have been skilful throughout, so as to assure a perfect conversion of the whole of the tri-phosphate element into soluble bi-phosphate. I have also excluded from consideration all fluoride of calcium, which is generally present in mineral phosphates of lime to an extent varying from one to ten per cent., and would reduce, consequently, the ratio of bi-phosphate in the product by raising that of the sulphate. I do this to give to the usual pro-

cess and its products the most favourable exposition that is possible. Yet, with all these concessions, its defects show forth most glaringly to reproach the manufacturer and to awaken the suspicion of the farmer or planter.

It rarely happens that a superphosphate reaches the planter in such a pure state. It is most generally degraded either through fraudulent design or unscientific and careless manipulation, to such an extent that commercial samples seldom answer to a higher test than twenty per cent., and often fall as low as fifteen to ten per cent. of bi-phosphate.

These figures refer to actual bi-phosphate ($\text{CaO}, 2\text{HO}, \text{PO}_5$), and not to their equivalent in tri-phosphate ($3\text{CaO}, \text{PO}_5$). I make this explanation because it is the custom in the English market to offer and sell "superphosphate" upon this false expression of its real strength. When it is remembered that 1.00 of tri-phosphate of lime represents only 0.75 of soluble bi-phosphate, it becomes apparent, at once, that this deception is large in measure and unjustifiable.

Evidence could not be more conclusive

than that which has been just noted against the defects of the methods in general use for making "superphosphate". It proves them to be alike discreditable to the manufacturer and unfair to his customers. Even supposing that the commercial product is always free from any designed or unintentional adulteration, and has uniformly the composition of the exemplar (3) on page 293, it is still an imposition, to a large extent, upon the credulity and confidence of the planter.

Fertilizers are manufactured almost always in great commercial centres, and the customers for them live often in distant parts not unfrequently remote from convenient channels of transportation; consequently the package and freight charges upon a manure become important items for consideration.

Sulphate of lime is a material common to every locality at trifling cost, and silica, sand, alumina, and oxide of iron are natural parts of every soil. Yet these form at least three-fourths of the "commercial superphosphate" in question; and the purchaser of every hundred pounds is compelled to pay for the packing and transportation of all that larger

worthless portion, in order to obtain the 20 to 25 per cent. of valuable bi-phosphate.

To remove these great defects and to improve the advantages of the "superphosphate" to both producer and planter, I worked out upon a scientific basis the practical methods, described minutely in Chapters XIII and XIV.

In my earlier efforts towards the construction of these processes, I cleared away first only the carbonate of lime from the raw mineral by means of hydrochloric acid. This preliminary treatment, however, while it reduced very materially the bulk and weight of the diluting influence, still left in the residue all of the sand, most of the organic matter, and much of the iron and aluminium compounds. Consequently, when sulphuric acid was added, subsequently, to convert the phosphate of lime constituent, it became not only more or less wasted, but caused a tendency to dampness in the resulting superphosphate.

Moreover, although the product was of very much higher quality than could be made from the mineral in its original crude

state, it retained a large enough proportion of foreign matters to keep down its character to that of "commercial superphosphate".

These circumstances led then to the plan of treating the mineral phosphate with hydrochloric acid and certain precipitants, so as to eliminate all the profligate elements.

The cheap hydrochloric acid is made to do well the dirty work that is generally done badly by sulphuric acid; and a pure tri- or di-phosphate of lime basis or "superphosphate" is evolved by self-compensating means, from even inferior mineral; so that all the subsequent operations of conversion are thus simplified and rendered economical to the utmost degree.

CHAPTER XIII.

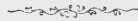

ON THE MANUFACTURE OF PURE "SUPER- PHOSPHATE" OF LIME.

THE precipitated phosphates or the Colombian phosphate of Chapters VIII, IX, and X, are to be employed as the basis material. The use of either one of them simplifies the manipulation to the utmost, and reduces the expense of labour, time, and acid to the most economical degree. At the same time, the product is eminently superior both in quality and appearance.

To convert it into "superphosphate", it is only necessary to pass the well-washed precipitate through a mixing mill with the requisite proportion of sulphuric acid, and to lead the mixture into an enclosure where it may remain to ripen and dry. For this purpose, the precipitate in its wet pulpy state may be made to fall directly from the vat

into the pug-mixer (Plate 21), by means of an inclined gutter or shoot, a stream of acid being arranged to enter at the same time into the hopper of the mill while the latter is in operation. The pulpy mass and acid are made thus to mingle thoroughly.

The enclosures into which the mixture is received are simply vats of mason-work, as presented by Plate 24. When the mass has remained in these enclosures several days it will have set hard into pure "superphosphate", which is a mixture of bi-phosphate and sulphate of lime, and contains, in this instance, more of the former than can be produced from any other known material.

Every 100 of dry tri-phosphate of lime requires 0.81 of brown oil of vitriol for its conversion into soluble bi-phosphate. No regard need be paid to the small amount of di-phosphate which is present in the pulp; for, although this requires less acid than the tri-phosphate, there are always some iron and alumina associates to make a compensation-balance in this connection.

When the "superphosphate" has become dry it is to be shovelled out, dashed to

granular powder by means of one of Carr's Disintegrators, and packed in bags for market.

The pure state of this pulpy phosphate, and its loose texture, manifest their great advantage throughout this treatment.

The composition of the product will be approximately as follows per cent. :—

Soluble bi-phosphate of lime	-	-	39'00
Hydrated sulphate of lime	-	-	55'00
Water	-	-	1'00
Sand and silica	-	-	'50
Iron and aluminium oxides and phosphates	-	-	4'50
			100'00
			100'00

Its content of soluble bi-phosphate is equivalent to 51'00 of pure tri-phosphate of lime.

If the phosphate basis has been precipitated with due care, it will be free from iron and aluminium compounds and produce an equally pure superphosphate. Indeed, the di-phosphate, as made by my processes, can only contain those impurities by accident; and, for that reason, and because it requires only half of the usual quantity of

oil of vitriol for its conversion, it is a prime basis-material for "superphosphate", in every sense.

Assuming that the di-phosphate of lime is pure and de-hydrated, then every 100 lbs. will require 50 lbs. of brown oil of vitriol, with some water of dilution; and form 160 lbs. of pure "superphosphate", having the following composition, approximately, per cent. :—

Soluble bi-phosphate of lime ($\text{CaO}, 2\text{HO}, \text{PO}_3$)	57'00
Hydrated sulphate of lime ($\text{CaO}, \text{SO}_3, 2\text{HO}$)	- 41'00
Water, accidental	- - - 1'00
Sand and silica	- - - 1'00
Iron and aluminium oxides and phosphates	- traces
	100'00

The manipulations are the same as have just been described, and the product, which is white, sets and dries very promptly. Its content of soluble bi-phosphate is equivalent to 75 per cent. of pure tri-phosphate of lime.

Owing to the concentrated nature of di-phosphate of lime and its great potentiality as a fertilizer, it is eminently suitable for

direct application to the soil; and I have mentioned it as a basis-material for pure superphosphate, rather as an item of instruction than with a view to recommend its use in that connection. It is almost too valuable for that purpose.

CHAPTER XIV.



ON THE MANUFACTURE OF PURE AND WHOLLY SOLUBLE BI-PHOSPHATE OF LIME.

THE basis-material for this product is either the precipitated or Colombian phosphate of Chapters VIII, IX, and X. It is to be taken in its wet pulpy state, after a good washing, directly from the precipitation vat, and led through a shoot to a broad box at the bottom of the elevator (Plates 5, 6, and 7), instead of into the pug-mixer (Plate 21), as was just previously directed for the manufacture of pure "superphosphate".

In this instance, also, a weaker acid than the brown oil of vitriol may be used, as the resulting superphosphate need not be dry for the subsequent operation. Indeed, a certain amount of fluidity is even desirable. The chamber acid of 1.450 will answer. This contains, in one hundred parts by weight,

57.0 oil of vitriol (SO_3 , HO) of specific gravity 1.845, or 46.48 (SO_3) of dry sulphuric acid. The use of this weak acid will be a great economy when the manure factory has a sulphuric acid work annexed, for all the expense of concentrating it by evaporation to commercial strength for exportation is thus saved.

The sulphuric acid is to be raised to the reservoir *v* (Plates 5 and 6), near the mixer *b* (Plates 5, 6, and 7), by means of the lift *u*. It may be delivered, also, to the mixer direct from a reservoir below, by means of a leaden pump, with the mouth of its delivery-tubes so adjusted as to let drop the acid in as gradual flow as may be required.

Every pound of dry tri-phosphate of lime requires 51.28 pounds of dry sulphuric acid (SO_3) for its decomposition, and this proportion is represented by 1.11 pounds of the dilute acid of specific gravity 1.450.

The mass of pulpy phosphate having been brought by a gutter from the precipitation vat to the base of the elevator, is then to be carried up the belt and cups *a a n n* (Plates 5 and 6) to the mixer. As the pulp falls into



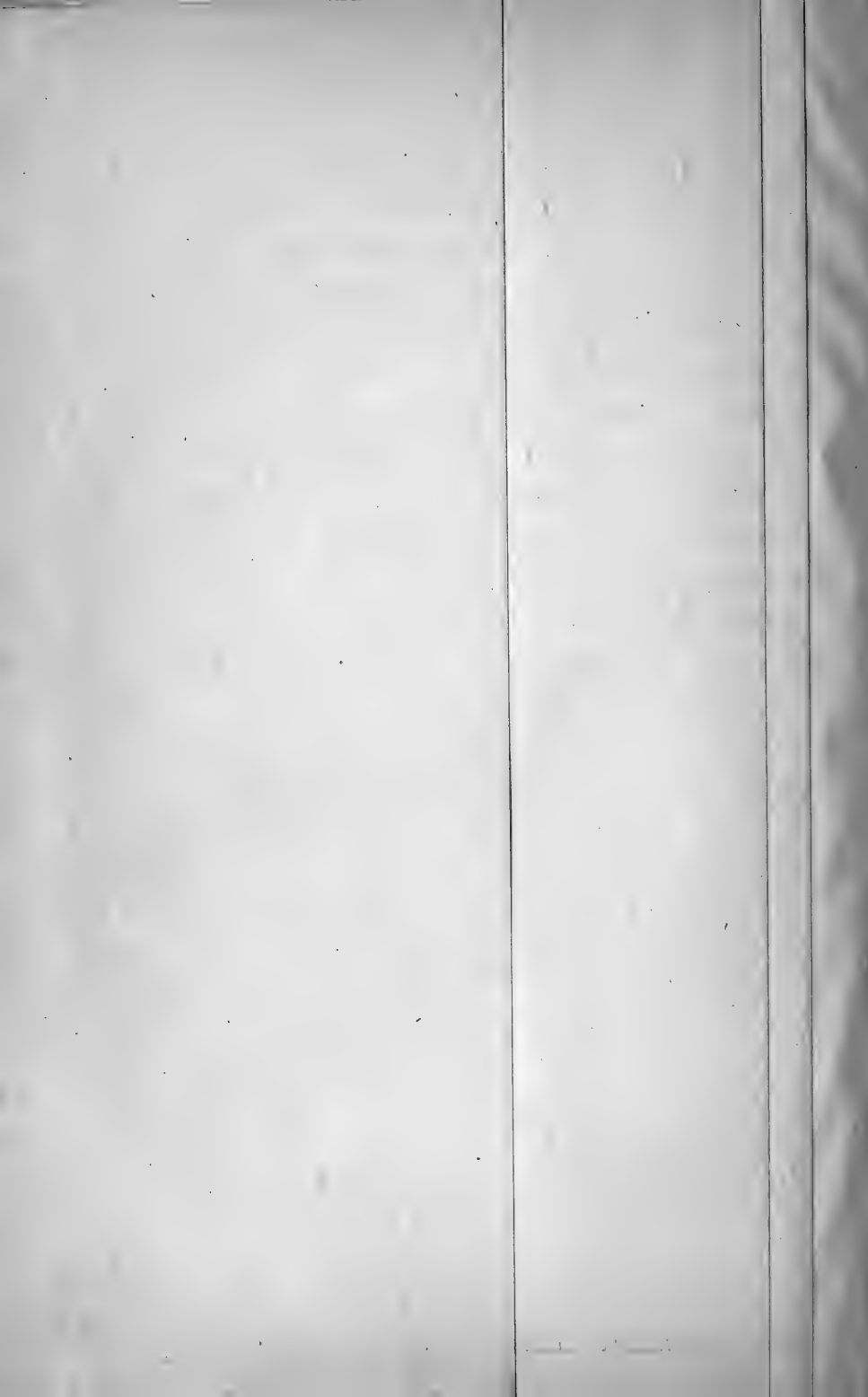

the mixer a stream of acid should enter, so that the two may meet. Chemical action begins at once, and the decomposition of the phosphate goes on and becomes complete when the mass, after having fallen into the cylindrical vat (figs. 1, 2, 3, 4, Plate 22) beneath, is stirred and heated at short intervals, during ten or twelve hours. If the contents of the vat should tend to stiffen, they must be thinned by the addition of water, for a certain fluidity is necessary. Without it the motion of the stirrer would be difficult, and the decomposition of the tri-phosphate might not be thorough.

The mass consists, now, of liquid bi-phosphate of lime holding a little sulphate in aqueous solution, and a solid which is wholly hydrated sulphate of lime.

By repose, the latter will settle with most of the former resting upon it as a clear supernatant liquor. This liquor is to be drawn off through the cocks of the vat, or by means of a syphon, into the basin portion of the kiln.

However, as the mass retains yet a considerable portion of liquor, it must be washed

DETAILS OF PLANT FOR PRECIPITATION AND FILTRATION.

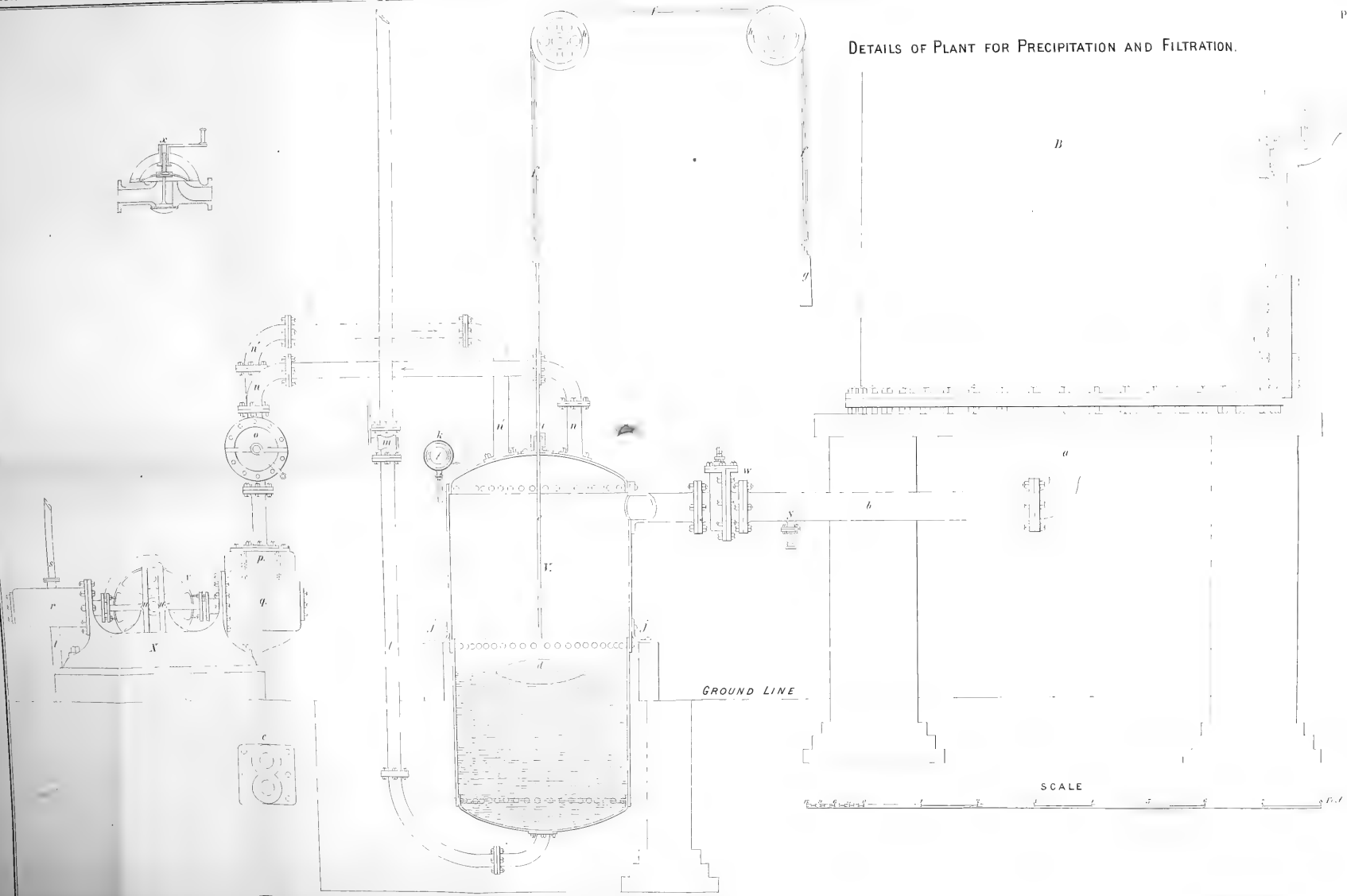

by the addition of fresh water. The liquor, instead of being drawn off as before, is allowed this time to percolate downwards through the mass into the lower chamber of the vat. To facilitate this process of displacement, the lower chamber is to be exhausted of air by means of the air-pump, for which there is a coupling-screw connection in the vat at *m*.

The vacuum thus produced in the lower chamber causes the liquor to filter through rapidly from above. The washing is to be repeated once or even twice. The mass is then clean and ready to be pushed out by the motion of the stirrers through the holes and shoots *ll*, and wheeled away for sale as a cheap substitute for ground plaster.

The wash-waters are to be run into the basin part of the kiln with the previous strong liquor, and heated until a film of crystals begins to form. At this stage, there must be great care to moderate the fire; for I have observed that the bi-phosphate of lime, when evaporated beyond the consistence of a wet crystalline mass, is apt to assume in part an allotropic condition which is com-

paratively insoluble. The heat must be stopped, therefore, when the liquor reaches the above-noted point. At this stage, also, it should receive its requisite proportion of drier. If, during the evaporation, there have been given off any white vapours of sulphuric acid, then the drier should be the Colombian phosphate, as it will thus neutralize the excess of sulphuric acid and add to the value of the product. Five to ten per cent. are to be added, and well stirred in to make a thorough mixture. The whole is then transferred to the basin of the kiln, where it is left to dry at a very moderate heat, not exceeding 180° to 200° Fahrenheit.

If there is no excess of sulphuric acid in the bi-phosphate, then the best drier is the hydrated sulphate of lime, which is deposited from the chloride of calcium or mother-liquor, treated in Chapter XI. It may be added in its pulpy or moist state to the bi-phosphate, and the whole must be mixed thoroughly by raking.

When there is any tendency to cake on the bottom or sides of the kiln, the mass must be kept detached by means of a hoe. The

mass, when dry, is to be dashed into a granular powder by means of Carr's Disintegrator, previous to being packed into barrels for market.

The product thus obtained is a mixture of 90 to 95 per cent. of pure soluble bi-phosphate of lime with 10 to 5 per cent. of whichever drier may have been used.

Formerly, I used finely-powdered mineral phosphate of lime as the drier; but I have observed more recently that this substance is apt to reduce the bi-phosphate partly into di- and tri-phosphates, more particularly when there is no free sulphuric acid present.

The chemical interaction which sets up this change is promoted by the incidental water of the mixture. Indeed, it is the undecomposed portion of tri-phosphate of lime, which exists almost invariably in the ordinary commercial superphosphates, that causes the bi-phosphate portion to "*go back*", according to trade language, or become insoluble directly in water.

Although the lift elevator and vacuum vats comprise a convenient arrangement for the manufacture of soluble bi-phosphate, they

are not indispensable implements. A much simpler plant may be made to answer with such an easy material as the "superphosphate", prepared as directed in Chapter XIII.

This material may be leached of its soluble bi-phosphate portion by simply boiling it with water in the wash-vat for half an hour. Then, by repose, it divides into an upper stratum of liquor, which is aqueous bi-phosphate of lime, and a lower deposit of solid hydrated sulphate of lime. The former is drawn off from the latter into the evaporating pan and reduced to a crystalline mass, as directed at p. 306.

The solid residue in the vat is transferred afterwards to the stands (Plate 23), and allowed to drain. These draining stands are made of wood, and consist of a funnel-portion *a*, perforated with holes throughout its lower circumference, and supported by the frame-work *c*. They must be lined with a very coarse blanket or straw to prevent the choking of the holes with the solid matter. As the liquor percolates through, it is caught in the troughs *b*, which conduct it into a reservoir.

When all the strong liquor which it retained has passed through, hot water is to be poured upon the contents of each filter, and allowed to run through. This washing is to be repeated a second time, in like manner, and the united wash-liquors or drainings are then to be reduced with the previous strong liquor in the evaporating pan.

The residual matter of the filters is the same as the exhausted matter of the cylindrical vats; or, in other words, hydrated sulphate of lime. It is far superior to ground plaster for dressing clover lands; but must be thrown out as waste where there is no market for it. The "superphosphate" and bi-phosphate of this process, unlike the bi-phosphate products of other methods of manufacture, do not "*go back*" into tri- and di-phosphate after having been put into packages.

It may be as well to note here that it has occurred recently to my mind, that the turbines used in sugar manufactories might serve well for separating the liquor from the solid portion of the superphosphate in the preparation of soluble bi-phosphate by this

process. It may be that the solid portion is too fine for this operation; but, be that as it may, the suggestion is worth a practical trial. The saving of space, time, and labour, by this means, if it can be substituted for those prescribed, would be very great indeed.

One thing is certain, that it would answer well for drying the precipitate of the wash-liquor; for there the deposit is coarse crystallized sulphate of lime, which will allow its liquor to go through the holes of the turbine without passing them itself. I, therefore, will describe this machine. It consists of an iron cage AA (fig. 6), placed in the centre of an enveloping case BB, of cast-iron, and attached to the base of a central and vertical axis CC, to which a cog DD' communicates a motion of 1200 revolutions a minute.

The walls of the cage are a fine cullender of very solid metal, and into this receptacle the stuff to be dried or cleared of liquor is to be placed. The machine being then set in motion, the very rapid rotation drives the stuff against the walls, and sends the liquid portion through the fine holes. The solid is then to be removed for a new charge. So,

also, is the liquor to be drawn out of the jacket when it has accumulated sufficiently.

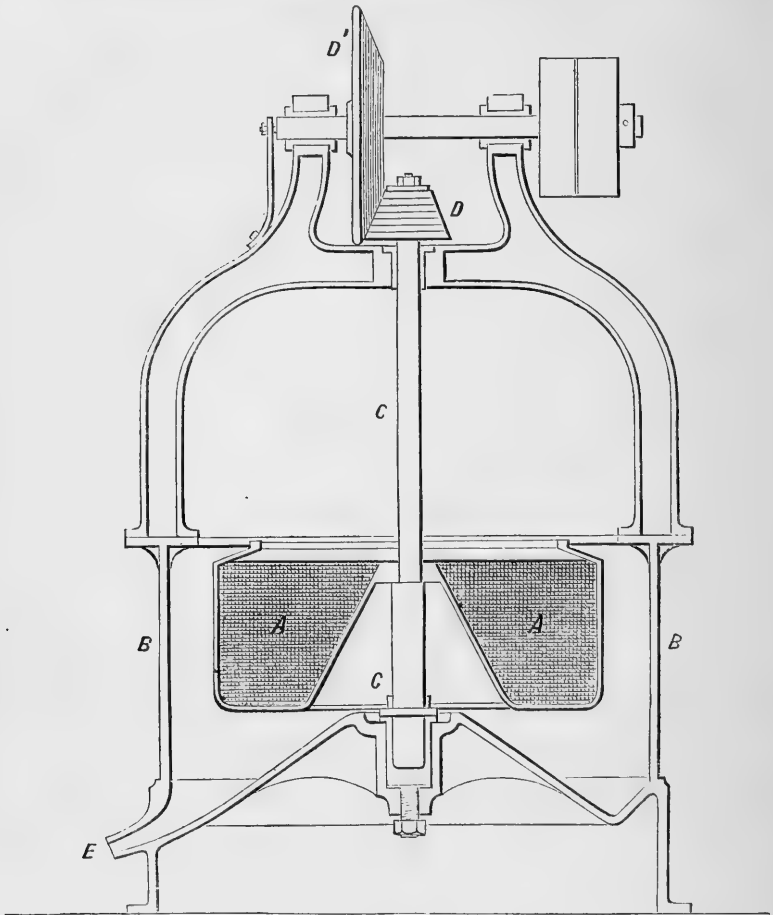

Fig. 6.

The machine must be well dried always, when it is not in use, in order to prevent its becoming rusted.

It is the utilization of the centrifugal force which constitutes the principle of this machine and its mode of operation.

The solution vat, with vacuum filter combined (Pl. 22), which has been noted, is a cast-iron cylinder ff , lined with lead or coated with stearic pitch, raised upon a brick-work foundation o , and held firmly in place by the beams ii , bolted to the floor c . The perforated diaphragm, which converts it into a filter, is in segments kk , supported, first, by means of a strong ledge bb , running around the inner circumference aa , of the vat; and, secondly, by a central column d , fastened to the bottom c , as shown by the cross section and plan views, figs. 2 and 3.

This column carries at its upper surface the wooden footstep e for the end f of the shaft of the stirrer, and also a flange to support the central portion of the segments $gggg$. These segments are cast with ribs on their upper face as rests for a plate similarly cullendered and coated. The intervening space between this double diaphragm is to be filled with clean coarse gravel or a blanket of loose texture as a filtering medium.

Fig. 4 gives an enlarged view of the stirrer, which is of wrought iron and covered with lead. Branch pipes *s s s*, leading from the steam-feeder *r r*, serve for heating the contents of the vat to facilitate solution; and they enter from the outside to prevent interference with the arms *b b b* of the stirrer.

CHAPTER XV.

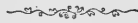

THE MANUFACTURE OF COMMERCIAL SUPER- PHOSPHATE OF LIME.

THE usual rough and ready method of preparing this fertilizer is to make a mound about two feet high and six or eight feet in diameter, with a given weight of powdered coprolites, rock guano, marlstones, or other crude phosphate of lime; then to shovel out the centre, so as to form a bowl with a rim or circumference ten or twelve inches thick, and fill the hollow with an equal weight of brown oil of vitriol previously diluted with water.

This preparation being completed, the powder removed from the centre to form the bowl is put back by degrees; that is, by shovelfuls at a time, until all has been added. By means of a hoe, the mass is mixed next into a paste, and incorporated, finally, with

the dry portion constituting the sides or walls of the bowl. It is left then for several days; and, at the end of that time, if it should not be dry, it is to be treated with a sufficient quantity of ground gypsum, powdered mineral phosphate, sawdust, peat, or kindred powder to bring it into a dry state.

Finally, it is broken down to a granular powder, by means of one of Carr's Disintegrators, and packed in bags or casks for market.

This slovenly and unscientific mode of proceeding gives a product which has the important defects of very variable composition, great dampness when iron and aluminium compounds are present, and excessive sulphuric acidity.

The sulphuric acid, although in very large excess, by acting upon the lime in this manner, causes the sulphate of lime which it forms, to envelope that portion of the bone-phosphate of lime immediately beneath the outer surface of the particles of raw material, and make a coating sufficiently hard to prevent the further penetration of the acid. Thus a thorough contact of the acid with

every particle of the mass becomes impossible, and the consequence is, that the acid does its work imperfectly.

Moreover, the quantity of water of dilution necessary to moisten the mass sufficiently is in excess of the proportion which the chemical constitution of the products demands, and this excess must be dried out, subsequently, by the use of absorbent powders which add to the expense of the fertilizer as well as to its already attenuated state, agriculturally considered, without imparting any counter-vailing advantages.

When operating in open pits the evolution of vapours is discomforting always to the workmen; and if coprolites or other raw material containing fluoride of calcium, should be under treatment, the emanations during the chemical action are positively injurious to health.

In a commercial sense, too, it is desirable to give the product as high a fertilizing strength as possible, for manures are generally distributed from grand manufacturing centres into remote and scattered corners of country often not very accessible by means of

railways or other less convenient means of transportation.

A concentrated fertilizer will cost much less for packages, packing and freight, than one of low grade, and is proportionally more economical to the planter, who can temper it as may be required, or according to his own judgment, at the moment of using it, and with dry earth, peat, or ground plaster. One or other of these materials is always ready at hand in every district of land, and costs little or nothing, comparatively.

To get rid of all the defects just specified, and to operate on large quantities of material economically as to time and labour, the work must be done by machinery. The chief implements for the purpose are an elevator and mixer, such as have been described in Chapter v, at pages 111-115. The acid reservoir, as well as the mixing box, should be protected by a lining of thin sheet-lead.

The acid may be mounted from a reservoir or trough below, by means of a lead pump, or in carboys, by means of a lift. A given weight of the crude phosphate of lime material in fine powder having been dumped on

the ground behind the mixing platform, is drawn up by the cups of the elevator, as explained heretofore at page 112, and dropped gradually into the mixer, the stirrer of which is now set in motion.

When the powder is being added, the acid must fall upon it with the proper amount of water of dilution, so that all may go through the mixing operation simultaneously, as well as continuously, but in small charges at a time. To this end, the flow of acid from the reservoir or the pump, as well as that of the water from the hydrant, must be regulated accordingly, by means of feed-pipes and cocks of suitable bores. The entrance of the acid and water in this manner causes a generation of heat, which assists the chemical action of the former upon the powdered phosphate very materially.

The mass drops from the mixer in a moist state, and is conducted into a reception vat by means of an inclined tube, according to the manner described in a previous chapter. These receptacles or wells should be of stone or brick-work, with walls at least twelve inches thick, to give strength for resisting the

internal pressure of their contents. Twelve feet high and eight feet square, are very proper dimensions for them. They should have a wooden roof covered with felt cloth or paper boards, which have been saturated with stearic pitch.

Plate 24 will give the idea of a series of eight of these wells under one roof *g g*. To the latter is fitted, by means of a coupling-joint, the tube *a* leading into the chimney hearth, for conveying away the noxious vapours generated within the vat.

To prevent the escape of these vapours into the factory, the joints of this roof must all be kept tight. There must be also an opening *d d*, for the end of the inclined tube through which the mixed mass passes into the wells.

The entrance to each vat is fitted with a very strong wooden door, about two inches thick, well steadied against the wall, as shown by *b c* when the wells are about to be filled; for, otherwise, the semi-fluid mass of the interior might press it down and cause great inconvenience and loss.

This prop arrangement *c* must be movable,

so that the doors can be put aside when the wells are to be emptied.

Brown oil of vitriol of specific gravity 1.700 is the kind of acid to be used. The total required will depend upon the composition of the raw phosphate material, which must have been determined previously by chemical analysis. This once known, it is only necessary to weigh out the acid in the ratio of 1.21 pounds to every per cent. of carbonate and of 0.81 pound to every per cent. of bone-phosphate of lime in the raw phosphatic material. A further quantity, equal to about eight to ten per cent. of the whole weight of the mineral may be added as an excess to provide for contingencies, through the presence of fluoride of calcium and iron and aluminium oxides and phosphates.

Many manufacturers who make their own acid use a weight of the latter equal to that of the raw mineral, but this great excess does not benefit the product.

The water of constitution required for the products from each per cent. of carbonate of lime and each per cent. of bone-phosphate of

lime is 0.36 and 0.12 respectively. But the heat of chemical action always dissipates a large quantity, and provision against that waste must be made by using an excess of the equivalent proportion. As, however, the brown oil of vitriol contains already a considerable quantity, it will not be necessary to make this excess greater than 20 to 30 lbs. for every 100 pounds of this same brown oil of vitriol which may be employed. In that case, there will be no unnecessary delay in the drying of the contents of the wells. The mixture of powdered phosphate, acid, and water, will reach the wells in such a state of inter-action, that it will be found, within ten days, a hard mass of thoroughly decomposed raw material, consisting of bi-phosphate of lime, sulphate of lime, and the insoluble matters of the crude phosphate mineral.

The per cent. of bi-phosphate will depend upon the per cent. of bone-phosphate which the raw matter contained. The presence of a large quantity of alumina in the latter may give rise to humidity in the product consequent upon the formation of sulphate of alumina.

At the proper time, the doors which close the openings are to be removed, and the dry mass is then shovelled out and reduced to powder by a Carr disintegrator or Howel-Hannay mill, and packed for market.

It is indispensable to the economy of this method that the raw phosphate material shall be as free from carbonate of lime and fluoride of calcium as possible; for this method, unlike the processes of the previous chapters, fails to afford a compensating product for the acid wasted by those components.

If bone-ash has been the basis-material, the product from 100 pounds will amount to 175 pounds, always provided that no excess of water or absorbent powders, as driers, have been used. This mixed product or "superphosphate", as it is called, commercially, will be made up as follows:—

Bi-phosphate of lime	-	-	-	53'00
Sulphate of lime—from carbonate	-	-	17'00	}
" " " tri-phosphate	-	-	80'00	
Silica, organic matters, accidental water, etc.	-	-	-	}
—say	-	-	-	
Total amount of product	-	-	-	175'00

This "superphosphate" will have the composition, per cent., noted at p. 292, Chapter XII.

It is not possible to make a greater strength of bi-phosphate in this way, except with certain kinds of apatite, phosphorite, and rock guanos, which contain a very high per cent. of bone-phosphate of lime with very little of other than organic matters.

In such cases, there is little or no dilution or degradation of the product by inert materials. But even with pure bone-phosphate of lime only 75.64 pounds of bi-phosphate ($\text{CaO}, 2\text{HO}, \text{PO}_5$) can be obtained from 100 pounds of the former by this process; and, at the same time, 110.25 hydrated sulphate of lime ($\text{CaO}, \text{SO}_3, 2\text{HO}$) are produced. Consequently, its *maximum* product per cent. would be only as given at pages 289 and 300, Chapter XII.

It must be remarked, that either on account of inferior mineral or bad manipulation, the admixture of absorbent powders or fraudulent practices, there is rarely more than 25 per cent. of bi-phosphate of lime at best, in commercial superphosphate. More

frequently, it falls to ten per cent., and even lower.

In corroboration, here is the calculated composition per cent. of the best possible "commercial superphosphate" that could be made with "South Carolina phosphate":—

Bi-phosphate of lime ($\text{CaO}, 2\text{HO}, \text{PO}_5$)	-	25.38
Hydrated sulphate of lime ($\text{CaO}, \text{SO}_3, 2\text{HO}$)	-	52.82
Iron oxide and alumina	-	5.78
Organic matter	-	5.14
Sand and silica	-	8.92
Water	-	1.96
		100.00

This analysis represents a product of only 155.6 pounds from 100 pounds of raw mineral; that is of the rarest purity; but in practice it would be so much larger from the presence of driers, excess of water and acid, as to depress the quality of the "superphosphate" at least twenty per cent.

In Great Britain, generally, the analytical report upon a sample gives its equivalent value in tri- or bone-phosphate as the real content, seemingly, of the bi-phosphate. Thus, a sample of superphosphate from

bone-ash containing only 31 per cent. of actual bi-phosphate will be sold as having the richness of 41.00 per cent.; these latter figures expressing the amount of tri- or bone-phosphate of lime to which the former are equivalent.

CHAPTER XVI.



HORSFORD'S BAKING POWDER

THIS modern substitute for yeast, in the manufacture of bread, originated with Eben. N. Horsford, Professor of Applied Chemistry in Harvard University, of the United States of America; but it is known in Great Britain and on the Continent as the Liebig-Horsford Baking Powder.

It is a mixture of pure bi-phosphate of lime (CaO , 2HO , PO_5) and bi-carbonate of soda (NaO , 2CO_2), in chemical equivalent proportions.

To make the acid element, it is necessary to have a very pure tri-basic or bone-phosphate of lime. This is to be prepared by dissolving bone-ash in a clean wooden vat, with *quite pure* and dilute hydrochloric acid, allowing to settle well, drawing off the clear liquor into a clean wooden vat, and then

adding pure aqua ammoniæ until there is no further precipitation, or rather until the mixture blues a piece of red litmus paper dipped into it. After repose, the clear supernatant liquor or aqueous solution of chloride of ammonium is to be drawn off, evaporated to dryness as crude crystalline ammoniacal chloride, and barreled for market. The residue is then treated with water, stirred, allowed to repose, and the clear liquor drawn off as before, and mixed and evaporated with the previous liquor. A second washing, with a fresh addition of water, is now necessary to remove the last traces of ammoniacal salt, and this wash-water must also follow the course of the preceding two into the evaporating pan.

The precipitate is next transferred to a series of filters, and there allowed to drain well. These filters are shown by Plate 25: *a* being the wooden support, *c* the coarse linen filtering cloths, and *b* the wooden pail for receiving the filtrate.

Assuming that the bone-ash under treatment contains a liberal proportion of bone-phosphate and carbonate of lime—that is,

$72 + 9 = 81$ —then the quantity of pure hydrochloric acid (specific gravity 1.170) required for the solution of every hundred pounds of ash would be 118 pounds. Should the acid be weaker than specific gravity 1.170, a proportionally greater quantity must be used. It will be more convenient and economical to make each and every operation with 1.39 tons of bone-ash, so that the amount of precipitate shall equal very closely one ton of tri-basic phosphate of lime.

The washed and drained precipitate from the 1.39 tons of bone-ash, is then to be transferred to a clean wooden circular vat, fitted with a wooden stirrer. This vat does not need any cover, nor yet to be coated with resisting paint, but is to be fitted with a "*blow-up*" or open steam-tube. Brown oil of vitriol of specific gravity 1.700, and made from sulphur, so as to be free of arsenic, is now to be poured upon the precipitate in a thin stream during constant stirring. It must be diluted previously with its weight of water, or, if more convenient, this proportion of water may be mixed instead with the precipitate in the vat. The necessary quantity of brown

acid (1·700) for the precipitate, which is equivalent to one ton of pure dry tri-phosphate of lime, will be sixteen hundred-weight. After all the acid is in, and the mixture has been well stirred, it is to be left for a week or ten days, care being observed to rouse it in the interval by frequent stirrings. The sulphuric acid abstracts two equivalents of the lime to form sulphate of lime, and leaves the remaining equivalent in combination with the whole of the phosphoric acid as soluble bi-phosphate. At the end of this time, the decomposition will have been complete, and clean water is then to be added, in order to thin out the mass. To promote this end, the stirrer must be put in motion. The whole is now left to repose, in order that the clean liquor may rise to the top. This is an aqueous solution of bi-phosphate of lime, with a little sulphate. All the rest of the sulphate of lime remains as insoluble matter. It, however, yet retains some of the soluble phosphate, which must be washed out with fresh water in the manner just described. This wash-water, when drawn off, is to be mixed with the first or previous liquor.

HORIZONTAL SIFTING MACHINE

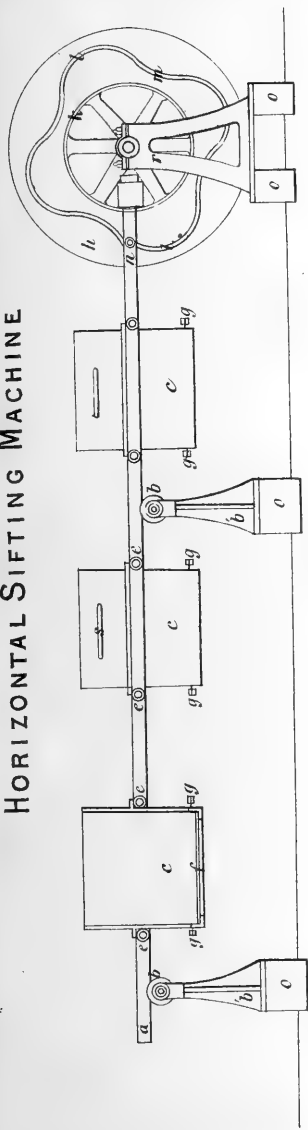

ELEVATION

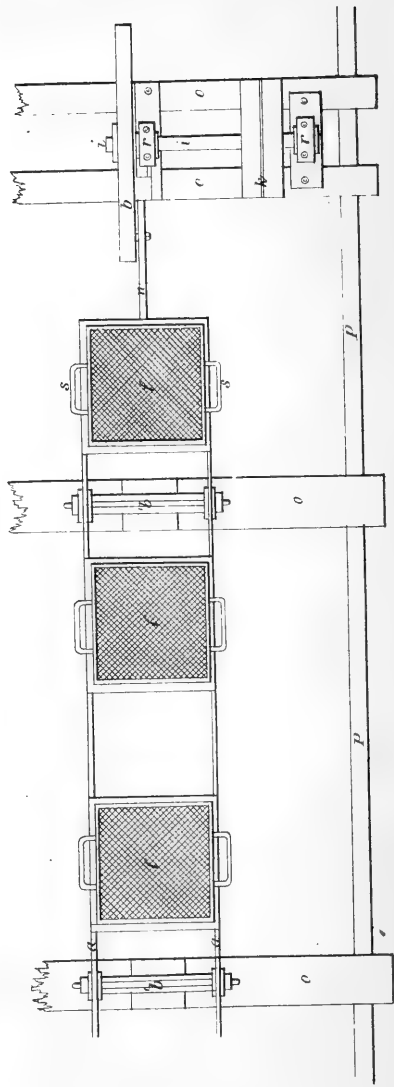

PLAN

SCALE OF FEET

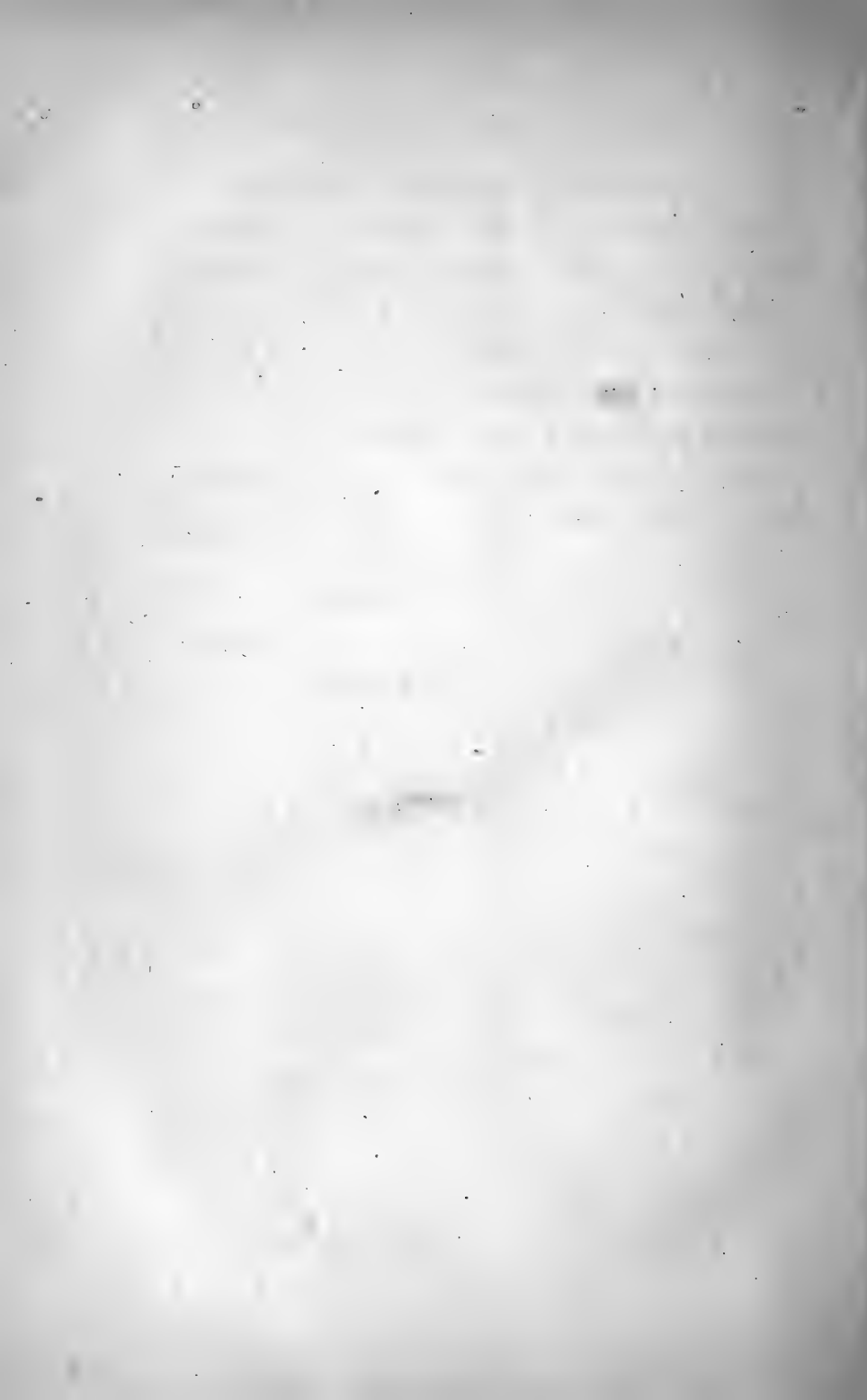

To remove all suspended matter the mixed liquors must now be strained through a filter-cloth of sufficient fineness, or allowed a day's repose, in order that it may settle clean. The clear runnings are then to be evaporated in shallow enamel-lined iron pans, to a thick syrupy liquor, at which stage sufficient wheat-flour is to be stirred in to convert it into a dry powder. These pans A (fig. 7), are made

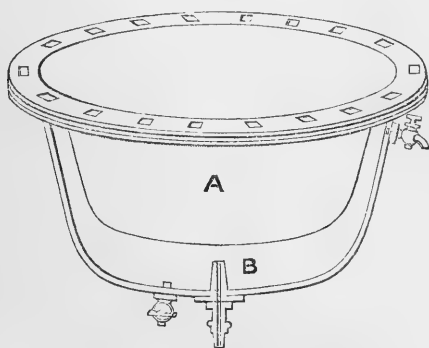

Fig. 7.

of large size and superior quality, by T. and G. Clark and Co., Wolverhampton. They can be set in brick-work, over a naked fire; but the drawing represents one with a cast-iron jacket B, so that it may be heated with steam. The price of the latter, with fittings, is £5:10 for one of 25 gallons capacity;

£11 for one of 50 gallons capacity; and £21 for one of 100 gallons capacity.

It is necessary that the powder shall be perfectly dry when cold, because any contained moisture would cause it to act prematurely upon the bi-carbonate of soda with which it is next to be mixed. The powder would thus become stale, as it were; or, in other words, inert, as a yeast substitute.

The proportion of bi-carbonate of soda to be mixed with the bi-phosphate of lime is 0·965 pound for every per cent. or pound of bone- or tri-phosphate of lime represented by the acid powder of bi-phosphate of lime. To the ton, therefore, produced, as just directed, there must be added eighteen hundred-weight and three-quarters of bi-carbonate of soda. Complete mixture of the two powders must be made by means of a Howel mill, kept well clean, interiorly, for the purpose.

The baking-powder is then ready to be packed in glass bottles with cork stoppers, containing in their centre a wooden measure for holding sufficient powder to produce the rising of two pounds of fine white flour. This sufficient quantity is one ounce. The

form of this stopper is shown by fig. 8, in which b represents the cork exterior, and a the interior wooden measure. This arrangement is not only convenient for packing, but also for the consumer, who would need, otherwise, a pair of scales to weigh out the proper quantity at each and every baking.

The two powders may be packed and sold in separate bottles, to be mixed at the time of use. In such case, the measure-

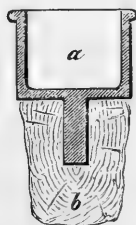

Fig. 8.

stopper of the bottle containing the acid powder must have the capacity for *exactly* one half ounce. On the other hand, the stopper-measure of the other bottle must hold *fully* one half ounce. In all cases, the measure must be "*struck*"; that is, the contents are to be level with the top, for which purpose any excess must be scraped off with a knife, so as to leave a smooth flat surface.

Directions for Use.

The flour having been sifted into a clean wooden bowl, is to be incorporated dry with the mixed powder in the proportion of one ounce for every two pounds of flour. Or, if the acid and alkaline powders are separate, then one half ounce of the first, and rather more by a grain or two of the latter, are to be used to every two pounds of flour. After thoroughly incorporating the whole by means of the hands, and throwing in a little table-salt, sufficient cold water or milk is next added to make a soft and rather thin dough. In the meantime, the pans must be made warm and the oven quite hot. Then, after having kneaded the dough only so much as is necessary to make it perfectly homogeneous, it is to be put into the pans so as to leave about one-fourth of the top space free, and baked immediately. Thorough baking is indispensable to prevent doughiness of the crumb portion of the bread when stale or cold; and, therefore, the loaves must not be removed from the oven until they are quite brown.

The pans should be of tin plate and round, about six or seven inches in diameter, and three to three and a half inches in height.

The bread as thus made from white flour is light, sweet, and very superior. Care must be taken not to use less than the prescribed quantity of flour for the bread; otherwise, the latter will have a peculiar saline taste. Two pounds of good flour yield from three to three and a quarter pounds of baked bread.

The chemical action which takes place in the mixture of flour, baking-powder, and water, is as follows:—the bi-carbonate of soda neutralizes the bi-acid equivalent of the bi-phosphate of lime, and phosphate of soda, with precipitated phosphate of lime, is formed. Carbonic acid, being thus disengaged as gas at the same instant, rises through the dough, expands it, and makes it light and porous.

There is no loss of flour as by the process of raising by yeast. Moreover, the phosphates separated by the bran are thus restored to the flour.

Brown Bread.

The ordinary bran-meal, and also the "whole ground flour", will make very superior bread with this powder, both as to lightness and agreeable taste. A little salt must be added; and, to prevent doughiness of the crumb part, the proportion of powder must not be less than one ounce of the mixed powder to two pounds of whole ground flour. Even as much as two and a quarter ounces of mixed powder may be used with four pounds of the flour without imparting any perceptible saline taste to the bread. This bread keeps well, and is far superior to that made from the same flour by any other method of raising.

The ordinary bran-bread meal requires, at furthest, only one ounce of mixed powder with two pounds of meal.

The precautions directed already, as to the baking, are to be observed more strictly with regard to these brown breads than to those from fine white flour.

Gout-Bread and Confectioners' Cakes.

The preceding mixed powder, with a certain amount of sesqui-carbonate of ammonia in place of a portion of the bi-carbonate of soda, becomes an excellent baking-powder for bread suited to gouty patients. Neutral phosphate of ammonia (2NH_3 , 2HO , PO_5 , HO) is thus introduced into the bread, and this salt entering the system, keeps in solution the uric acid and urate of ammonia, which are otherwise painful secretions in that disease. At the same time, there is given off a larger amount of carbonic acid than from the soda-powder, and this property adapts it admirably for making sweet cakes. So long as the ratio of carbonate of ammonia is not in excess, the bread and cakes will have only an agreeable taste and wholesome condition.

To prepare the powder properly, one hundred pounds of the dry bi-phosphate of lime are weighed and put into a wooden trough. Assuming that ten pounds of flour are contained as drier in this hundred of powder, then there are ninety of acid or bi-phosphate of lime to be neutralized. For this purpose

72 pounds of finely-powdered sesqui-carbonate of ammonia ($2\text{NH}_3, 2\text{HO}, 3\text{CO}_2$) are to be sifted in, and thoroughly intermixed with the acid powder. In other words, the equivalent proportion of sesqui-carbonate of ammonia is 0.80 for every per cent. (1.0) of pure, anhydrous bi-phosphate of lime.

In the same manner three hundred pounds of the acid powder are to be thoroughly intermixed with 275 pounds of bi-carbonate of soda. These two double powders are finally mixed and sifted together, so as to produce an uniform fine powder. The compound powder thus formed is the baking-powder for gout-bread and sweet cakes.

One ounce suffices for two and a half to two and three-quarter pounds of flour. It is to be used in the manner as directed for the soda powder, and the same precautions in baking are to be observed.

It is indispensable that all these powders shall be kept dry until after they have been mixed with the flour previous to making the latter into dough.

CHAPTER XVII.



GERLAND'S SULPHITE OF TRI-PHOSPHATE OF LIME.

THE action of sulphurous acid upon tri-phosphate of lime has been studied specially by Dr. B. W. Gerland, who was the first chemist to give it attention; and to him we are indebted for all of our practical knowledge on this interesting and comparatively novel subject.

Sulphurous acid in aqueous solution dissolves phosphate of lime with considerable energy; more particularly when the latter is in an artificial precipitated state. The natural mineral forms of it are only less soluble than the artificial, and in proportion to their greater or lesser density of structure. The resulting solutions are perfectly clear, and contain phosphoric acid and lime in the same proportions as the original substance.

As sulphite of lime is very largely insoluble* in water, even though the latter may be saturated with sulphurous acid, it is evident that this salt cannot have been formed; and, therefore, the sulphurous acid must have dissolved the phosphate of lime without decomposing it. The sulphurous acid thus acts quite otherwise than sulphuric acid, which latter, under corresponding circumstances, would produce sulphate of lime, together with bi-phosphate of lime.

The relative energy and proportion in which the different forms of tri-phosphate of lime are dissolved by an aqueous solution of sulphurous acid are shown by the following table. The solutions were obtained by suspending the phosphate material in water and passing sulphurous acid gas through the mixture. One thousand cubic centimetres of the solution, made in this manner, were found to contain :—

* Gerland's estimate is, that 100 cubic centimètres of the saturated solution contain 8.996 grammes of sulphurous acid and 0.258 gramme of lime, which are equivalent to 0.553 gramme of sulphate of lime.

Components.	Pure Pre- cipitated Tri-phos- phate of Lime.	Bone Ash.	Bone Ash.	Pieces of Bone.	Pieces of Bone.	Pieces of Bone.	Pieces of Bone.	Pieces of Bone.
	grammes.	grammes.	grammes.	grammes.	grammes.	grammes.	grammes.	grammes.
Sulphurous acid	218.38	141.82	159.446	36.019	36.848	35.597	33.536	32.550
Sulphuric acid	0.70	trace	—	1.664	1.748	2.058	1.320	1.185
Lime - -	101.79	59.69	51.374	20.787	19.233	20.496	18.589	19.350
Magnesia -	—	2.79	2.896	0.582	0.460	trace	trace	—
Phosphoric acid	82.89	47.42	40.093	15.287	14.508	15.925	15.030	14.451
Total -	403.76	251.72	253.809	74.339	72.796	74.076	68.475	67.536
Specific gra- vity of the solution - -	1.3000	1.1708	1.1881	1.0650	1.0600	1.0680	1.0611	1.0612
	at 48.2°F.	at 53.3°F.	at 57.1°F.	at 61°F.	at 63°F.	at 64.2°F.	at 50°F.	at 46.2°F.

These results show that in the stronger solutions there is one equivalent of tri-phosphate of lime to six equivalents of sulphurous acid; while those which are weaker contain the latter in the ratio of only five equivalents to one of tri-phosphate.

The solutions prepared from bone-ash and bone-dust contain more lime than their content of phosphoric acid requires to form tri-phosphate; but the proportion of these is nearly uniform in the bone.

The following table shows the composition

of the excess of bone-ash which was separated from solution No. 3, after having been washed and dried:—

Matters insoluble in hydrochloric acid	-	5.42
Sulphurous acid	-	trace
Sulphuric acid	-	0.29
Carbonic acid	-	0.90
Lime	-	48.25
Magnesia	-	trace
Phosphoric acid	-	38.59
Moisture and deficiency	-	6.55
		100.00

The proportion of phosphoric acid to lime is one equivalent to 3.172; whereas the liquor No. 3 held them in the ratio of one to 3.268; and, moreover, the latter contained all the magnesia. Although the excess of bone-ash had undergone only this slight chemical change, the pieces were completely disintegrated and reduced to fine powder.

These solutions have the odour of sulphurous acid, but in less degree than an aqueous solution of the gas itself; and, on exposure to air, their surface becomes covered with brilliant crystals. The weaker solutions re-

main unchanged, in closed vessels, for an indefinite length of time; but the stronger ones require to be kept at temperatures below 64° Fahrenheit, in order to maintain their preservation. Above this degree, the latter decomposes and drops a deposit which increases, progressively, for days. This deposit is a mixture of sulphite and di- or neutral-phosphate of lime, in which the former predominates. At the same time, the solution becomes richer in phosphoric acid, until finally this and the lime are present in about equal molecular proportions. The same decomposition will take place even during the preparation of the solution, if the temperature is allowed to rise above 64° Fahrenheit.

When exposed in vacuo, the solutions crystallize into well formed hexagonal pyramids composed of di- or neutral-phosphate and sulphite of lime with much water of constitution.

A mixture of variable proportions of di-phosphate and sulphite of lime is also precipitated from the solutions when the latter are boiled under reduced pressure, diluted with

alcohol, or treated with a current of carbonic acid gas.

Although solutions of phosphate of lime in sulphurous acids have the strong tendency to form the compounds as just explained, it is remarkable that they lose it when heated rapidly and boiled under atmospheric pressure. Thus manipulated, they drop their phosphate completely as a definite chemical compound of tri-phosphate of lime with sulphurous acid and water, which corresponds to the formula $3\text{CaO}, \text{PO}_5, \text{SO}_2, 2\text{HO}$. It is in the form of a crystalline white powder, which settles readily, but is very light when dried. The residual sulphurous acid escapes with the aqueous vapour.

This compound differs from other sulphites in not having any greed for the oxygen of the air, as it remains unchanged when wet, dry, or heated. It holds its water up to 284° Fahrenheit, and at higher temperatures; then water is given off with accompanying vapours of sulphur, sulphurous acid, and sulphuric acid.

The sulphite of tri-phosphate of lime is neither soluble in, nor acted upon, by cold or

boiling water. Dry chlorine and ammonia gases are without effect upon it; and aqueous ammonia affects it only slightly. A mixture of gaseous ammonia and oxygen or air is absorbed gradually by the sulphite, and proportionately sulphate of lime is formed. Sulphuretted hydrogen turns the sulphites yellow by developing free sulphur. Strong acids decompose it, oxalic acid more slowly and less perfectly, and weaker acids, like the acetic, with little or no energy, unless the air has access. A weak aqueous solution of iodine,—containing, say 12·69 grammes of iodine to the litre,—dissolves the compound by promoting the oxidation of the sulphurous acid constituent; and this reaction affords a ready means of estimating the same.

The sulphite of tri-phosphate of lime has not yet been made in any other way than that just described. Phosphate of lime, when digested with its solution in sulphurous acid, is not changed; but the contact disposes the latter to form, gradually, sulphite of lime, which becomes mixed with the phosphate. This change progresses to such an extent, within a few days, as to cause a perceptible

diminution of the specific gravity of the liquor.

Alkalies and alkaline carbonates throw down precipitates from these solutions, which differ from the sulphite of tri-phosphate of lime in both appearance and composition.

The Method of Manufacture.

The foregoing explanations will render easy the proper understanding of the preparation of the sulphite of phosphate of lime on a practical scale.

Figs. 9 and 10 show the construction and arrangement of the necessary apparatus for making it at the rate of thirty hundred-weight every twenty-four hours.

The raw phosphate material is to be placed in the four wooden cisterns or vats $C_1 C_2 C_3 C_4$, and upon a false-bottom B, in order that it may not be washed away. If the bone-ash or phosphate material is finely divided, it yields promptly to the dissolving action of the sulphurous acid which is now to be led into it; but, in order to increase the strength of the solution progressively, it must be pumped repeatedly from these cisterns or

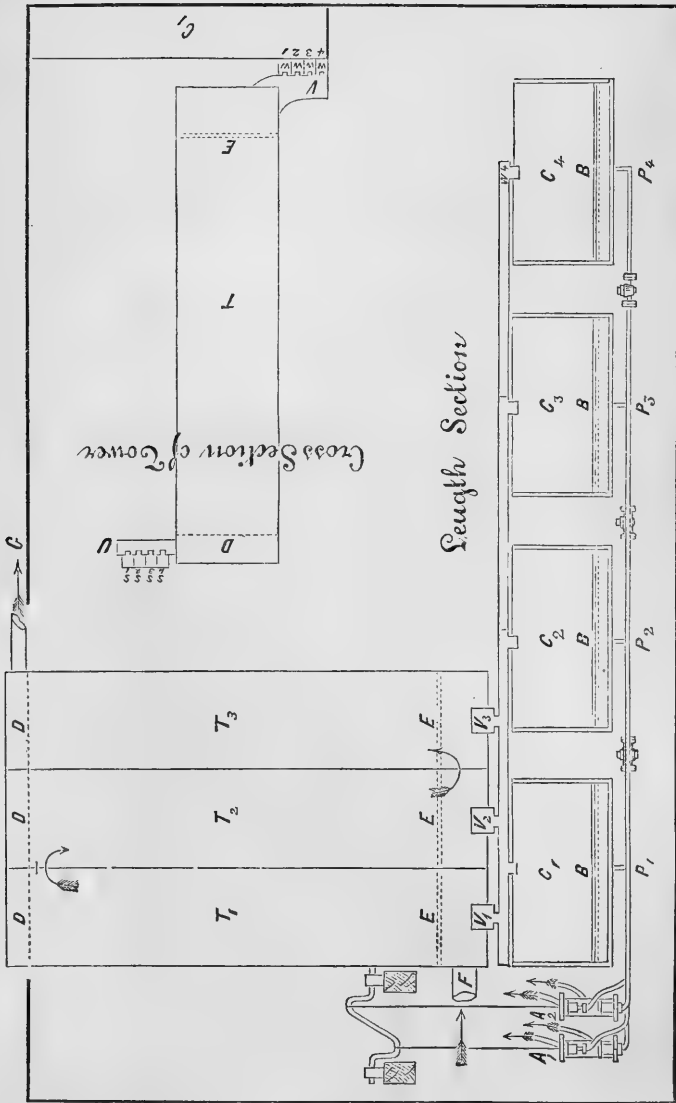

Fig. 9.

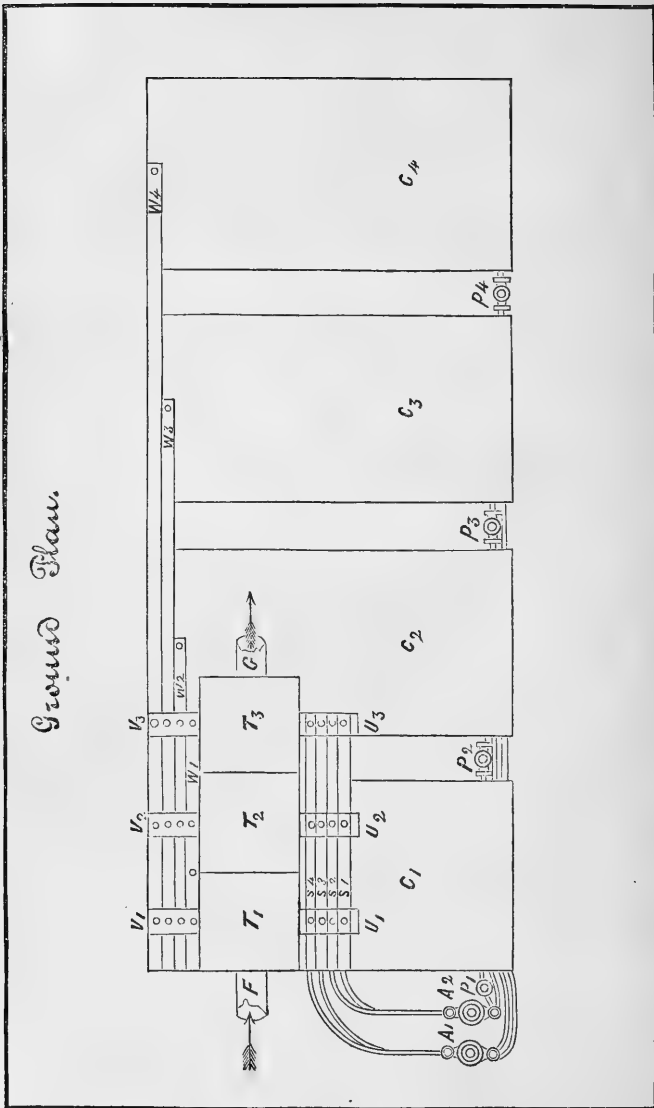

Fig. 10.

vats into the towers about to be described. The pipes $P_1 P_2 P_3 P_4$, which are fitted severally with taps, and, connected with two double-acting pumps $A A_2$, serve to produce this circulation, which is to continue until the liquor assumes a density of 12° to 15° Twaddle.

The pumps deliver the liquor at the top of the condensing towers, through the spouts $S_1 S_2 S_3 S_4$. These latter communicate by means of plug-holes with three short spouts $U_1 U_2 U_3$, placed beneath and at right angles with them. The latter pierce or extend through the sides of the three towers $T_1 T_2 T_3$, and allow the liquor to fall upon the sieve D , which promotes its uniform distribution.

The towers are built of flag-stone, after the manner of those used for condensing hydrochloric acid, or may be constructed of sheet-lead. Each one is fitted, at some distance above the bottom, with a diaphragm of lath-work E , as a support for the pieces of coke, broken tiles or twigs, with which it is to be filled. The sulphurous acid is without action on these percolating media, and they can be placed readily, so as to facilitate the free

passage of either gas or liquor through their interstices, and, at the same time, produce a wide expanse of surface. The towers are fed at the top with water which, filtrating through the coke, absorbs the gaseous sulphurous acid entering at the same time from the sulphur furnace at F. The water thus acidulated passes out at the bottom of the towers into the wooden cisterns containing the phosphate material.

The sulphurous acid is generated as gas by the combustion of sulphur on the refractory-brick floor of a suitable furnace similar to those used in the manufacture of oil of vitriol. *Sulphuretted ores may be substituted for sulphur; and this means of concentrating them, by roasting, for more economical transportation to distant markets or smelting-works, opens a way for the profitable production of the sulphite of tri-phosphate of lime in those remote places where crude phosphate material abounds and sulphuric acid is to be obtained only at a cost which is too great for its employment in the usual processes of manufacturing fertilizers.*

After the gas has entered the first tower it



PUG MIXER.

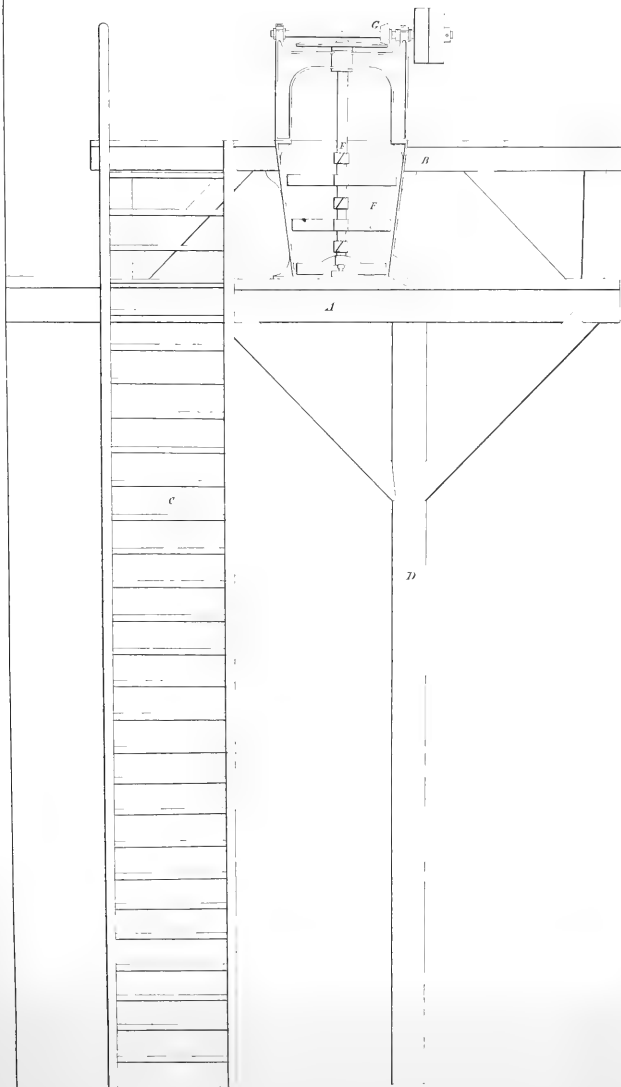

SECTIONAL ELEVATION

SCALE OF FEET





ascends to the top, thence passes into the next, and pursuing a downward course, finally ascends into the third tower, from which the uncondensed portion is conducted off through the draft pipe G, to the chimney, or by means of an aspirator. This coursing of the gas brings it into broad contact with the water, which, in its turn, is sent through the pumps and the system of spouts described already, to the top of the towers, whence it spreads itself over the coke and arrives eventually at the bottom.

The liquor in each tower is to be kept separate, in order that the contents of any one may be passed through either of the others, and delivered again into the same cistern after having become intermixed. To this end there is a cross spout $v_1 v_2 v_3$, with plug-holes through which the liquor may be conducted into either of the four-length spouts $w_1 w_2 w_3 w_4$, each of which communicates with one of the four wooden cisterns.

If a cistern is to be thrown out of operation for the purpose of emptying it, recharging it, or otherwise, the tap on its pipe must be turned off.

When the liquors have reached 12° to 15° Twaddle, they are to be conducted thence into lead or copper vessels through branch pipes fitted with a tap and connecting severally with the delivery-pipe of the pumps. Here the sulphite-phosphate solution is boiled until sulphurous acid gas ceases to escape,—an operation that will consume about six to ten hours. While the excess of sulphurous acid is passing off with aqueous vapour, the sulphite-phosphate precipitates.

The solution contained five equivalents of sulphurous acid to one of tri-phosphate of lime, and the solid product holds one equivalent; therefore, four-fifths of this gas escapes, and must be reclaimed. For this purpose, the boiling vessel is fitted with a cover which connects with a cooling worm so arranged as to allow the condensed water to return to the vessel and the escaping gas to pass into the condensing tower; for, in open vats, the concentration beyond 15° Twaddle wastes both time and sulphurous acid.

The sulphite-phosphate settles readily as it forms, and at the end of the boiling is to be collected on a drainer, pressed and dried.

It is then ready for market, and has the form of a clean white powder, which neither dirties, tarnishes, nor corrodes, and is, moreover, harmless to the taste and touch.

Its Disinfecting and Fertilizing Properties.

This product is both an effective fertilizer and potent disinfectant. Its insolubility in water and fixedness in air heretofore noted, would seem to conflict with such a character; but it happens, fortunately for these purposes, that this stability refers to the action of pure air; for, in a foul atmosphere, the sulphite-phosphate changes gradually into di-phosphate and sulphate of lime, and by this chemical alteration the air is simultaneously disinfected. The more the air is vitiated and the warmer the temperature, the greater will be the energy and rapidity of this reaction. An ounce or two of the powder distributed in the holds of ships and on the floors of stables, will remove in a few hours the disagreeable odour peculiar to those places, as well as arrest the escape of ammonia; and a daily renewal of this application will keep them sweet permanently.

In hospital wards and the chambers of the sick, it is a most useful purifying agent. Animal matter, even if putrid, loses its offensive taint when dusted with the powder or kept in its neighbourhood. Access of air renders its action more decided. The sulphite is always oxidized in these changes, and gives very often an ozone reaction.

It is of special value to the farmer for maintaining a pure atmosphere in his stables, piggeries, etc., and, at the same time, for preventing any waste of the ammoniacal emanations from the decomposing dung.

Dr. J. Dreschfeld, of Manchester, has reported a series of careful experiments with this powder as a disinfectant and deodorizer. The results obtained by him were most favourable, even in comparison with those given by well-known rival substances, which were tested at the same time.

The oxidation of the sulphite-phosphate takes place when it is sown in the soil, and the decomposition may be expressed by the following formula:—

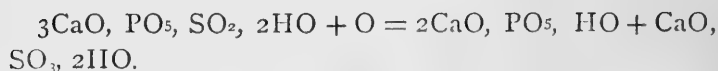

The chemical properties of the di- or neutral-phosphate thus formed have been explained already in Chapter III; but it has a characteristic energy in fertilizing which must be re-stated here, as it was determined by actual experiment.

A portion of the sulphite-product,—say a layer of one inch thickness,—was buried in a stiff clay soil under a loose cover of the latter. This soil was tested previously for lime and phosphoric acid, by boiling it with hydrochloric acid; but it did not show any traces of either. After two months—July and August—the sulphite-phosphate was exhumed with care to keep it free of any of the soil, and finally examined. All sulphite had disappeared, and the modified powder was found to consist of—

Sulphuric acid	-	-	18·59 per cent,
Phosphoric acid	-	-	24·58 „
Lime	-	-	33·66 „

In the original substance there were 34·8 per cent. of phosphoric acid for 15·8 per cent. of sulphuric acid; and if no change, or rather assimilation, had taken place, the buried

phosphate should have contained 14 per cent. of sulphurous acid for 24.58 per cent. of phosphoric acid: whereas, the analysis shows 18.59 per cent. of SO_3 , or an excess of $4\frac{1}{2}$ per cent. This excess proves that the moisture of the soil dissolved the newly-formed di-phosphate at a quicker rate than that at which it took up the sulphate of lime.

In employing the sulphite-phosphate as a fertilizer, it is expedient to mix it with other manurial matters, and more particularly those of organic nature, as its solubility in the soil is thus greatly promoted. The commercial article contains phosphoric acid in proportion equivalent to 70 per cent. of tri-phosphate of lime.

Chemical Analysis.

The method of analysis is free from difficulties, and comprises the following steps and manipulations:—

1. Weigh one gramme on a counter-balanced watch-glass, and dry in an air-chamber at 248° to 284° Fahrenheit. The loss of weight represents moisture.

2. Take a fresh quantity of one gramme,

place it in a glass flask of about 150 c. c. capacity, add boiling dilute hydrochloric acid, cover the mouth with a funnel, and boil rapidly until all the sulphurous acid is expelled. If there should be any insoluble residue it is to be collected on a filter, dried, ignited, and weighed. The filtrate is to be treated, now, with solution of chloride of barium, and the precipitate thus thrown down is to be filtered off and determined. Its amount corresponds with the quantity of sulphuric acid contained in the substance; for ordinary precaution will prevent any increase through the oxidation of some of the sulphurous acid during the manipulation.

3. Weigh another gramme of the sulphite-phosphate powder, place it in a beaker glass with some water, and treat it, drop by drop, with a standard solution of iodine. At first, the colour of the iodine disappears rapidly, and the powder loses volume by degrees, until only a few grains remain. From about this point, the decoloration of the iodine liquor proceeds very slowly; but the addition of a few drops of hydrochloric acid will hasten the action to immediate completion.

This small quantity of acid has no influence on the result. From the measure of iodine solution consumed, the quantity of sulphurous acid is to be deduced by calculation.

4. Another fresh gramme of the powder is to be dissolved in a little hydrochloric acid and water, then heated until all the sulphurous acid is expelled, next neutralized *exactly* with ammonia, and mixed finally with acetate of soda. If iron is present it falls now as phosphate, and must be filtered off. The filtrate is to be dosed with oxalate of soda, which precipitates the lime as oxalate in a granular form, and easy to be filtered; but the whole should stand twelve hours previous to filtration. The latter operation is rapid when the liquor is hot at the time of adding the oxalate.

5. From the filtrate, magnesia is to be precipitated by the addition of a large excess of ammonia; and it carries down at the same time some of the phosphoric acid.

6, and lastly. The residual phosphoric acid is to be precipitated from the preceding magnesia filtrate by the addition of an ammoniacal solution of sulphate of magnesia.

The following analytical table shows the composition, thus determined, of the several samples of sulphite-phosphate powder noted in the table at p. 341 :—

Constituents.	1	2	3	4	5	6
Sulphurous acid -	15·58	15·69	14·14	18·00	14·440	21·139
Sulphuric acid -	0·23	0·84	4·46	2·74	1·192	1·704
Phosphoric acid -	34·80	33·87	31·22	28·69	34·215	36·547
Lime - - -	39·89	40·76	40·23	40·22	40·925	42·313
Magnesia - -	—	—	trace	0·21	trace	1·184
Sand - - -	—	—	0·46	0·66	—	—
Water, accidental	0·66	}	9·24	9·46	10·00	9·228
,, constitutional	9·08					
Total - - -	100·24	100·00	100·00	100·52	100·00	100·00

According to the formula $3\text{CaO}, \text{PO}_5, \text{SO}_2, 2\text{HO}$, the calculated composition of the sulphite-phosphate of lime is,—

Sulphurous acid	-	-	-	15·61
Phosphoric acid	-	-	-	34·63
Lime	-	-	-	40·98
Water	-	-	-	8·78
				100·00

CHAPTER XVIII.



ON THE CHEMICAL TREATMENT OF "REDONDA GUANO", "ALTA VELA GUANO", AND THE MINERAL PHOSPHATES OF ALUMINA AND IRON GENERALLY, FOR THEIR CONVERSION INTO FERTILIZERS.

THESE stony substances, erroneously classified in trade as "Rock Guanos", were unknown until a comparatively recent period. Their obdurate character, in both physical and chemical senses, rendered them at first unsaleable. But time and study improved their character, and now that science has animated them with her Promethean fire they enjoy a life of commercial activity. At present, "*Redonda Guano*" and "*Alta Vela Guano*" are the only representatives in commerce of this class of materials; but others have been discovered, and will be brought

forward, sooner or later, as demand may increase.

Both take their names from the place whence they are brought. The first has its source in Redonda, one of the Leeward Islands, lat. $16^{\circ} 55'$ N., long. $62^{\circ} 18'$ W.; and the second comes from Alta Vela, an island near St. Domingo, in lat. 17° N., long. 17° W.

The annexed analytical table shows their composition per cent., and also that of several kinds from a source not yet made public, but which has been noted to me by a correspondent as "*A. R. B. phosphate rock*".

Part of the water present is constitutional, and the "Alta Vela Guano" may be considered, mineralogically, as *Gibbsite*. The very much higher ratio of phosphoric acid to the alumina in Redonda Guano and A. R. B., gives them a distinct feature in that respect, and assimilates their formula to that for pyrophosphate of alumina, which is $2\text{Al}_2\text{O}_3, 3\text{PO}_5, 10\text{HO}$ (dried at 110°).

The instructions about to be noted will apply equally well to all the members of this class.

Very little of the "Redonda" has come forward to this country; but the importation of it into the United States, for the port of Baltimore alone, amounted to 4334 tons during a recent year. The "Alta Vela" is in large supply, owing to the more enterprising management of the business of mining and shipping it. This latter, however, although a very useful raw material, is by reason of its lower ratio of phosphoric acid and large proportion of silicious matter, the least valuable of the three; for there is as much acid, labour, and time required to dissolve it as would be necessary for the solution of either of the other two. This is an important consideration in making a selection for chemical treatment by the processes of this treatise.

The precipitate thrown down by milk of lime from the "*mother-liquor*", which is left by mineral phosphates of lime when treated according to the processes in Chapters IX*

* See my patents Nos. 2341, 2344, 2357, of August 6th, 7th, and 8th, 1872. These processes are now leading me to a further improvement which will effect the recovery of

and x, is so closely allied in its nature to the Redonda and Alta Vela Guanos, that it may be considered as such for all the purposes of this treatise. Indeed, it has the great advantage of being rather purer and having a pulpy state, which latter condition renders it soluble instantaneously even in cold and diluted acids.

The chemical agents employed in the following processes are made to do their intended work in such a manner as not only to add to their original value, but to improve also the profit on the other materials.

The proportions of acid given are for the "Redonda Guano", and must be therefore modified for different phosphates according to the quantity of alumina and iron which they may contain. The larger the proportion of contained alumina and iron, the greater will be the quantity of acid required.

the hydrochloric acid, merely by the evaporation of the "*mother-liquor*" to dryness and subsequent ignition of the mass in a suitable furnacc.

	Redonda, by <i>Johnson.</i>	Alta Vela, by <i>Voelcker.</i>	"A. B. R." — Average.
Water - - -	24·67	4·19	22·55
Water of constitution	—	12·99	—
Sand and silica -	1·84	27·19	7·95
Lime - - -	·56	—	—
Magnesia - -	traces	—	—
Peroxide of iron -	6·60	2·79	7·14
Alumina - -	21·28	21·98	18·54
Phosphoric acid -	43·91	30·86	42·23
Sulphuric acid -	traces	—	1·35
Chloride of sodium -	traces	—	—
	100·00	100·00	100·70

The quantitative relation per cent. of the alumina to phosphoric acid is as follows:—

	"A. B. R."	Redonda.	Alta Vela.
Phosphoric acid -	69·50	67·36	58·41
Alumina - - -	30·50	32·64	41·59

OR—

	"A. B. R."	Redonda.	Alta Vela.
Alumina - - -	43·88	49·91	71·20
Phosphoric acid -	100·00	100·00	100·00

To carry out the processes in connection with this mineral, the first step is to reduce it to fine powder by any of the means usually adopted or prescribed in this work. The next is to charge the vat with the necessary quantity of hydrochloric acid of specific gravity 1.170. The construction and arrangement of the vat, and other necessary apparatus, are shown by Plates 26 and 27.

The vats are to be mounted upon a brick-work support, twelve inches high from the ground, as shown by B, which support must be covered with a flag-stone top C, forming the bottom of the vats A A A. Surrounding the vats and built up to their height, is a brick-work enclosure D, forming a hot-air chamber E, of six inches diameter throughout. As supports alike for the chamber and the stone walls of the vats, there should be brick pillars or abutments F F at the corners of the joints and the centres of each vat.

The brick enclosure is to be capped with a smooth stone laid very level, and kept tightly in place by iron bolts fixed tightly into the brick-work by means of lead.

These bolts are to be screw-cut at the ends

to the length of two inches, and must project above the stone-work, as shown by *g g*.

The division stones of the vats are to be cut down at the centre of the top side, so as to form a passage-way eight inches square for accidental overflow from vat to vat, in cases of uprising of the contents from violent chemical action.

Each vat is to be provided with a manhole *I*, projecting through the brick-work, for the removal of its more solid contents or for cleansing it. Also, on the bottom, but in the front of the vat, there is to be a drain-hole *J*, of four inches diameter, and fitted with a movable plug of caoutchouc in conical form, as shown by fig. 11.



Fig. 11.

Behind this drain-hole, and in an angular position, resting upon the interior bottom of the vat, is to be a stone covering pierced

with many holes and laid over with straw at the commencement of the operation, when it is intended, subsequently, to drain the liquid downwards from the solid portion of the charge.

Holes and plugs similar to those just mentioned, but of only two inches diameter, are to be placed along the whole height of each vat, at intervals of twelve inches apart, as shown by LL. These must be fitted by means of iron tubes projecting outwards through the brick-work, and fixed to the stone of the vats by means of a collar and molten lead or sulphur.

The cover of each vat is to be in two pieces, the rear part M being fixed. The other portion is movable, but can be fixed as required by means of the bolts and their nuts. The fixed part of this cover must be of cast-iron, an inch thick, so as to be sufficiently strong to bear the weight of the workman who may be charging the vat. Its under or inner side is to be covered with a thick layer of the pitchy matter from the stearic candle factories, as a protection against the corrosive action of the vapours evolved.

In this piece the box and passage-way for the stirrer *o* are to be arranged. All parts of this stirrer are to be of very hard wood or of wrought iron, with arrangement for lifting it out when not in operation, as shown at Plate 26, by means of the chains *z z* going over a pulley at the back. Towards the edge and near the corner, there is to be fitted a tube *q*, leading to the fire hearth of the factory chimney for conveying away the noxious gases as they may arise in the vat during the operation. These pipes may connect with one larger pipe *r*, fixed at the back of the vats and leading into the fire.

In the opposite corner, about a foot towards the centre, there must be a hole of six inches diameter for the entry of the acid or the powdered mineral into the vat, as may be required. This should be fitted with a hopper of hard stone *r'*, about twelve inches diameter and six inches deep. The rim should be strong and flat to form a support for the inverted carboys in the act of their being emptied.

A simple hopper arrangement, as described, will answer only when the vat is to be

charged first with acid and the mineral is to be added afterwards in dry powder.

On the other hand, if the powdered mineral is to be moistened with water previously to falling into the vat, then the hopper must be replaced by the mixer already described at p. 116.

To render the vat suitable for general service, the cover should be fitted with both a hopper and mixer.

The front part of the cover may be of wrought iron plate, a quarter of an inch thick or less, and pierced around the edge with holes $g' g'$ for the passage of the bolts $g g$. It must be lined around the inner edge with an india-rubber washer, as well as coated with stearic pitch on its inner surface, so as to form a tight joint and retain an uncorroded surface. The bolts $g g$ and the holes $g' g'$ allow the cover to be removed and put in place, at will, by the supplementary aid of the screw-nuts $g'' g''$.

It should be remarked that, in default of the cement already noted, the best hydraulic cement is the proper material for making the joints of the vats; but, to further protect

them against the action of the acid contents, they should be covered over with marine glue, or better, with the pitchy residue obtained in the distillation of fats (mixed with a little shellac), and to be bought cheaply at the stearic candle manufactories. The mode of preparing this latter is described in Chapter XXVI.

The vats are to be kept warm, when in operation, by means of steam circulating through the iron tubes *ss*, arranged in the brick chamber. These tubes should be covered with stearic pitch, or some equally good coating, to protect them against the action of acid vapours.

In the rear of the vats there must be a wooden platform apparatus *τ*, Plate 27, to facilitate the charging of the vats with the acid. That it may be moved readily from vat to vat, it is mounted on iron wheels.

To better explain, however, the operation of the lift, the manner of charging the vats with acid is as follows. The cage *w* of the lift being lowered to the level of the ground, full carboys are then placed on the trolley or bogey *τ τ*, and the whole elevated by means

ALTER.

FIG. IV.

FIG. I.

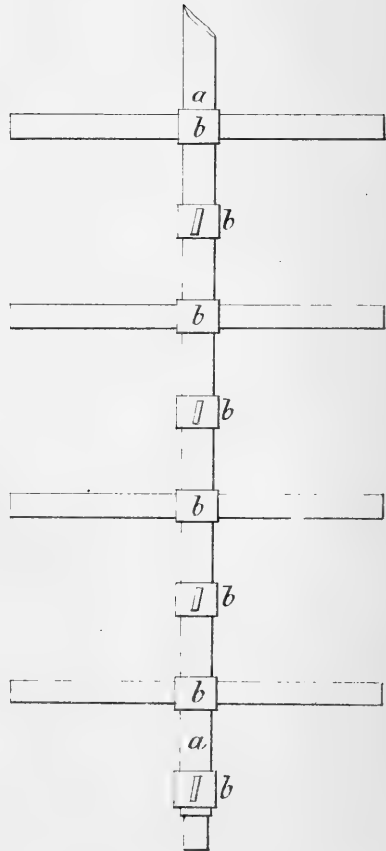

SCALE OF FEET.

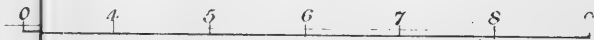

SOLUTION VAT COMBINED WITH VACUUM FILTER.

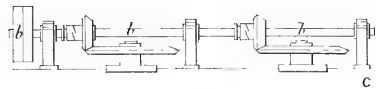

FIG. I.

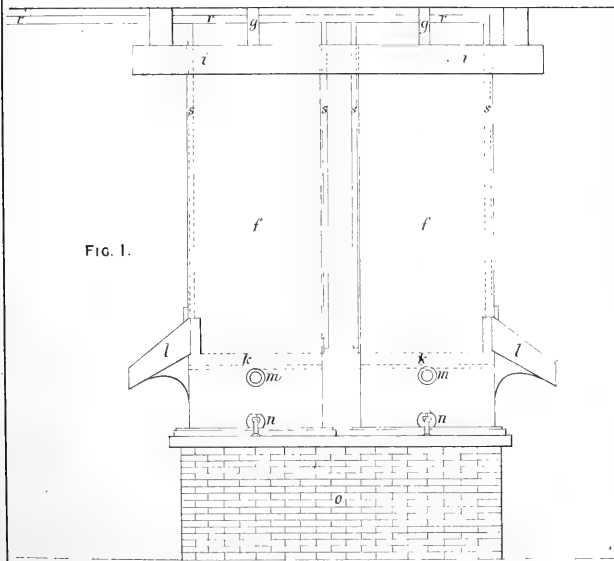

FIG. II.

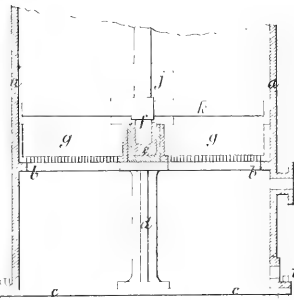

FIG. III.

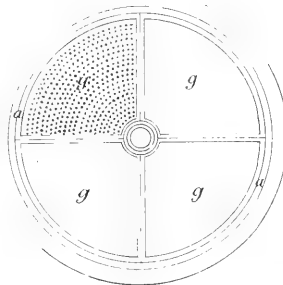
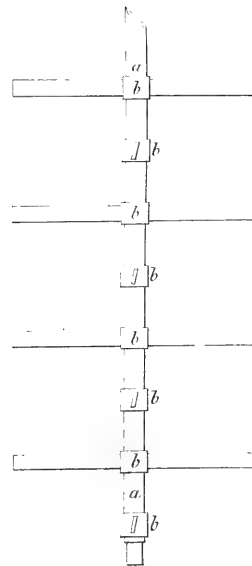
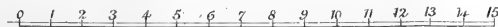

FIG. IV.



SCALE OF FEET.



SCALE OF FEET.



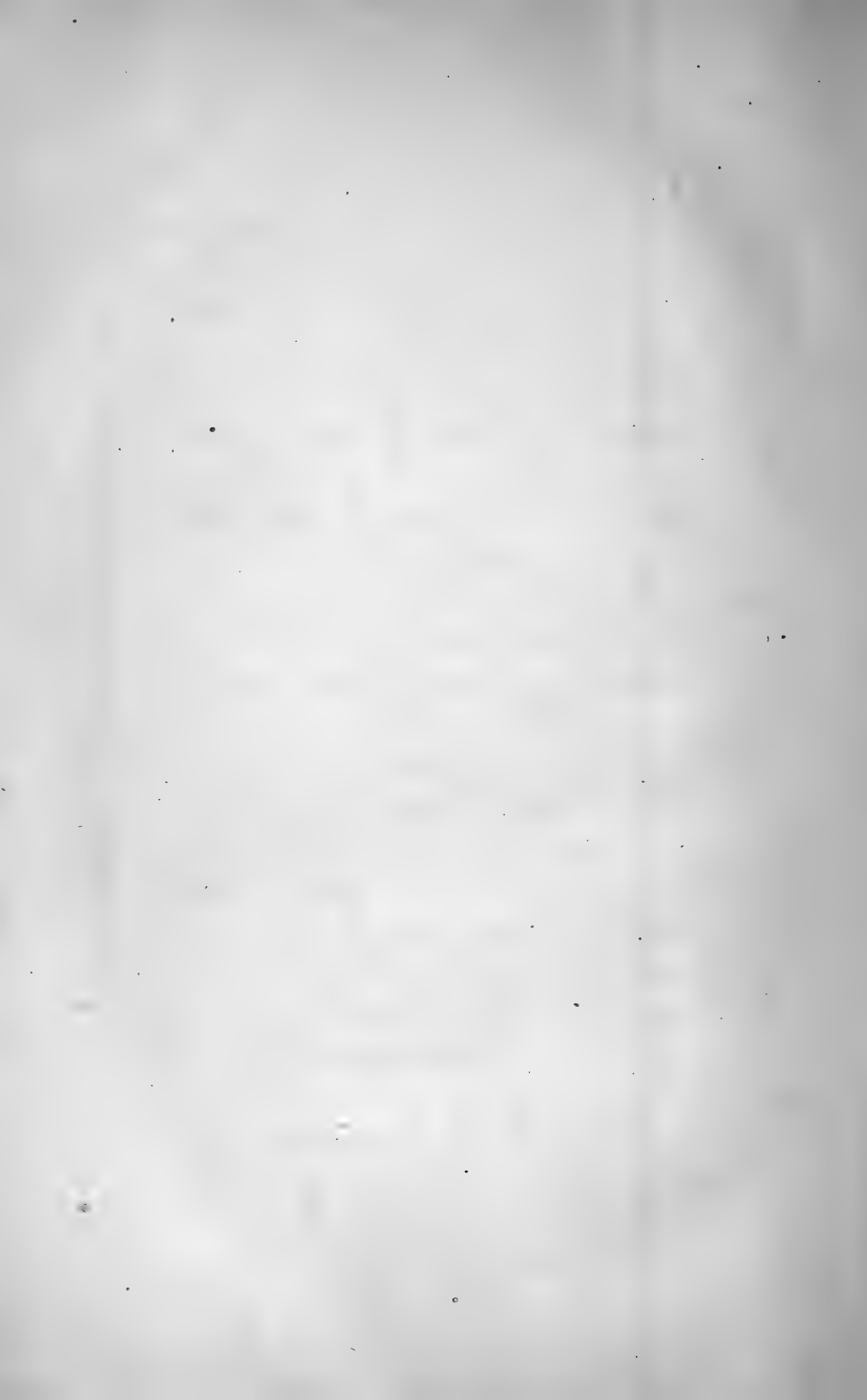

of the gearing A', until the tops of τ are level with the top of the vats. At this point, the rails on w will coincide with similar ones upon a fixed platform running in the rear of the vats A A A. The trolley τ is then advanced until it is opposite the vat requiring to be charged, and the carboys emptied into it.

The empties are taken down by the return cages. If the powdered mineral is to be dropped into the acid dry, it is brought up from the ground beneath in the cups v on the endless band u of the elevator, which is carried by strong wooden supports b' . After being emptied from the cups into the hoppers $c' c'$, it passes into the vats through the adjustable gutters $d' d'$ resting one end on the hopper r' and the other on supports $e' e'$ specially arranged for the purpose. When the powder is to be moistened with water or acid previously to falling into the vat, it must pass through the mixer instead of the hopper.

The proportion of acid will depend upon the quantity and composition of the mineral to be treated. In this instance of "Redonda

Guano", as a standard, for every ton of that material about half a ton of hydrochloric acid 1.170, or its equivalent in weaker acid, must be taken. The acid is to be raised in carboys and emptied into the vats by means of the lift, as already described in Chapter v, or it can be sent up from a reservoir in the ground by means of a monte-jus, Plate 10, Chapter v. Care must be observed in this manipulation to prevent as much as possible the escape of acid fumes into the factory, for the vats have been designed to promote convenience and comfort in this respect.

When the requisite charge of acid is in the vat, the powdered mineral must be mounted by the elevator, and dropped into it from the cups during constant stirring. The manner of gearing this latter for motion is shown at Plate 26.

All the mineral having entered the vat, and the mixing being completed, the whole is to be left for twelve hours. At the end of this time about $7\frac{1}{2}$ cwt. of commercial oil of vitriol of specific 1.846, or $9\frac{1}{2}$ cwt. of brown oil of vitriol of specific gravity 1.700, are to be added in a thin stream and during con-

stant stirring. When the acids are added in the succession just named, there is little or no intumescence. Moreover, all hardening of the mass is prevented by adding the sulphuric acid last, and *after* the preliminary action of the hydrochloric acid.

To effect the prompt and perfect solution of the mineral in any other manner was found by me to be very difficult on a practical scale.

As this treatment causes much chemical action and evolution of vapours, there should be frequent halts in adding the acid. When all the acid is in the vat, the stirring is to be stopped for an hour, and then renewed during five minutes.

The mass is to be thus roused again and repeatedly by stirring during the succeeding ten to fifteen hours. On the expiration of this interval, the mass will have become a thick syrupy fluid, which is then to be diluted with water, stirred well, and left to repose. The water of dilution should not be more than half the volume of the acid liquor.

To save time in effecting the solution of the mineral, steam should be coursing

through the tubes which warm the air-chamber of the digestion vat, as heat promotes the chemical action very sensibly.

If there is any insoluble matter in the mineral, it will now fall to the bottom of the vat, and leave a clear liquor above. This supernatant liquor is a sulphuric-hydrochloric solution of the aluminium and iron phosphates, together with more or less of the oxides of aluminium and iron which the mineral may have contained. It is to be drawn off clear through the plug-holes into a wooden vat.

The construction and arrangement of this vat have been described already at p. 127.

The insoluble matters are to be removed through the manhole at the bottom of the digestion vat, and thrown aside as waste after having been washed once or twice with relays of fresh water.

If, however, as in the case of "Redonda Guano", the insoluble matter does not exceed several per cent., it may remain, and the next operation can go on in the same or digestion vat; and thus very much time, labour, and expense will be economized.

The liquor, while still in the digestion vat, or better, after having been drawn off clear into a second vat, is next to be treated, during constant stirring, with quick-lime previously slaked and made into a smooth milk. This neutralizes the sulphuric acid by forming with it hydrated sulphate of lime.

Immediately following the addition of the milk of lime, a sufficient quantity of crude gas-liquor is to be poured in during constant stirring, to throw down all the contents of the liquor that can be thus precipitated. All of the hydrochloric acid becomes neutralized and remains in the solution as chloride of ammonia. Much carbonic and bad smelling gases are evolved during the reaction; and, therefore, the ammoniacal gas-liquor must be added slowly in an open or well-ventilated apartment.

When a red litmus paper, dipped into the liquor, may turn blue, it is a proof that enough of gas-liquor has been added.

The precipitate which settles, by repose, from the liquor is a greenish-grey-blue pulp, consisting of aluminium and iron oxides and phosphates, with sulphate of lime and some little sulphuret of iron.

For 100 tons of "Redonda Guano" there will be required 33 tons of oil of vitriol, 50 tons of hydrochloric acid, 20 tons of quicklime, and 300 tons of gas-liquor of 6° Twaddle. The dried product will be, approximately, a mixture of 75 tons of gelatinous phosphates of alumina and iron, 45 tons of hydrated sulphate of lime, and 25 tons of chloride of ammonium, making a total of 145 tons.

The precipitation may be effected wholly by gas-liquor, and in such case the precipitate would be free from lime or its sulphate; but the difficulty is to find a sufficient quantity of the gas-liquor in any one locality for large and continuous operations.

In all cases the precipitate and its liquor are to be drawn off together into a kiln, evaporated to dryness, and reduced to a granular powder by means of Carr's disintegrator. As the mass approaches dryness, the heat must not exceed 200° Fahrenheit; otherwise, it will become too hard and gritty. It is then ready for market as a fertilizer. But to make its agricultural appreciation more assured, it should be mixed with ten per cent. of bi- or di-phosphate of lime.

It is very doubtful, however, whether the phosphates of alumina, even in their tender pulpy state, will ever sustain an active competition, as fertilizers, with the phosphates of lime, so long as the supply of the latter does not diminish; for the preparation of the former is expensive, comparatively, and the actual measure of their agricultural effect has yet to be determined.

As raw material, however, for the many other useful products explained in Chapter XXI, they are of prime importance, by reason of their abundant supply and moderate price.

CHAPTER XIX.



THE MINERAL PHOSPHATES OF ALUMINA AND IRON AS RAW MATERIAL FOR THE MANU- FACTURE OF ALUM AND OTHER USEFUL PRODUCTS.

THE sphere of industrial utility pertaining to this class of substances is a very wide one, thanks to the genius and practical skill of those men of science who have given the subject their special consideration. Many and varied are the products which may be evolved from them profitably by proper chemical treatment.

The precipitate obtained from the "*mother-liquor*" of acid solutions of mineral phosphates of lime, which is left by the processes described in Chapters IX and X, having the same nature as the mineral phosphates of alumina and iron, may take the place of the latter advantageously in all the processes

about to be described. Being pulpy and easily soluble, its use will promote economy of plant and facility of manipulations throughout.

*Alum and Crude Phosphoric Acid,
etc., etc.*

The pioneer chemist in these relations of the subject is Mr. Peter Spence, of Manchester, who has published recently a valuable process. It is set forth in the following description:—

“ My invention consists in the use of compounds of alumina and phosphoric acid, such as are at present obtained in the island of Redonda, near Antigua, in the West Indies, and known under the name of Redonda Phosphate, and which contain a variable portion of iron, and of minerals of similar composition obtained in other West India islands and other places. These minerals I propose to utilize by the manufacture of alum, and by obtaining phosphoric acid or compounds thereof as by-products for use as manures or fertilizers, and for other purposes, such products, when free, or comparatively so, from alumina, being rendered valuable agents for

those purposes, especially so as manures or fertilizers. The treatment for the aforesaid purposes of the said minerals may be varied in details, but the following is a description of that which I have found to answer. I take the mineral in pieces as it comes to hand and calcine it in kilns similar to those used for lime, exposing it to a red heat by mixing it with coal or coke; or I take the mineral as obtained, and grind it so that it will pass through a sieve of, say, twenty meshes to the inch; but I prefer the former plan, as it facilitates the solution of the mineral substance, and renders a portion of the iron insoluble by oxidation. The mineral having been prepared by these or by similar means, I place it in leaden vessels and add thereto an equal weight of sulphuric acid of specific gravity 1.6 if the mineral contain twenty per cent. of alumina, but only three-fifths of its weight if it contain twelve per cent., and in similar proportions for other degrees of richness. I then apply heat, which I prefer to do by blowing steam into the vessel containing the mixture. The mineral dissolves and the specific gravity rises. I now cautiously reduce by water or weak liquors from subsequent parts of the process (especially the washings of the sediment here-

after to be mentioned), constantly boiling until all is dissolved except the insoluble sediment, and the strength of the liquor becomes 90° Twaddle or 1.45 specific gravity. I now pass this liquor into a close leaden vessel and distil into it vapour containing ammonia obtained from gas ammoniacal liquor subjected to boiling either by fire or steam injected into the said gas-liquor, and the quantity of the said gas-liquor I use is equal to 600 to 900 gallons to each ton of the mineral, according to its richness. When all the ammonia has been distilled into the mineral liquor I allow it to settle for a few hours and then run off all the clear solution (now at a strength or specific gravity of 1.4, or 80° Twaddle) into lead-coolers, to crystallize alum, as is well understood; and I allow it to remain in these coolers for some days, with frequent stirring, in order to obtain all the alum possible, and which may be purified by re-crystallization, as well known. I find that when the mineral contains twenty per cent. of alumina, I obtain about one and a half ton of alum from one ton of the said mineral. The mother-liquors having deposited all the alum that can be obtained, are now chiefly a solution of phosphoric acid with a small quantity of sulphate of alumina, iron, and sulphate or phos-

phate of ammonia. This liquid may be used directly as a fertilizing agent ; but I prefer to take the said mother-liquors direct from the coolers and add to them dry sawdust or other absorbing agent, just sufficient in quantity to absorb all the said liquors, so that none will run from the sawdust. I now take the substance and dry it at a low heat, so as not to char the sawdust, and when dry it forms an artificial manure containing phosphoric acid and ammonia in such quantities and condition as to make it a valuable fertilizer. Instead of ammonia gas-liquor, used with the mineral solution to produce alum, salts of potash may be used, either alone or in combination with ammonia ; of the former, the chloride of potassium of commerce, or, preferably, sulphate of potash ; as, although chloride of potassium will yield a sufficient product of alum, the fertilizer would, from its use, have a tendency to deliquesce, but sulphate of potash will not have that effect. From the above description, it will be seen that, by my invention, I obtain as a by-product, a large quantity of phosphoric acid ; and it has been stated how this may be used as a fertilizing agent ; but, independently of that, it may be applied to the purposes of producing phosphorus in the usual manner, or phos-

phoric salts of commerce, as phosphate of soda, by adding the required base thereto, extraneous matters in the mother-liquors being separated, if desired, by ordinary processes of precipitation and crystallization. The operations for making alum, above described, leave a sediment of insoluble matters which may be washed, and the washings used for the reduction of the dissolved mineral, as above alluded to. Having thus described and ascertained the nature of my said invention, and the manner in which it is to be performed, I desire it to be understood that I claim the use of such mineral phosphates as aforesaid, for the combined purposes of the production of alum and manures, and other substances, as mentioned."

Sulphate of Alumina.

"Redonda Guano", and other natural phosphates of alumina, have been made the basis for the preparation of sulphate of alumina and phosphate salts, according to the following process by John Berger Spence and Peter Dunn:—

"Our invention consists in a decomposition of natural phosphates of alumina, where-

by we obtain sulphate of alumina and also phosphoric acid or compounds thereof, which afford valuable fertilizing agents, or may be used for other known purposes.

“ In carrying out our process, we take the natural phosphate of alumina, and, having broken it (if necessary) into small pieces, place it in a leaden or other suitable vessel and pour sulphuric acid thereon in the proportions of about twelve hundred-weight of sulphuric acid to one ton of phosphate of alumina; but the proportion of sulphuric acid may be increased or decreased, according to the percentage of alumina contained in the phosphate of alumina. After digestion for a few hours the result will be the formation of sulphate of alumina and phosphoric acid; and, in order to separate the alumina from the acid, we introduce ammoniacal water or the products distilled therefrom until the alumina is precipitated. This substance can then be obtained by running off the supernatant liquor from the precipitated alumina. We then add sulphuric acid to the precipitate in about equal proportions, when sulphate of alumina will be formed. The phosphoric acid thus set free from the alumina may be collected and obtained or combined with any desired base, so as to form salts by any of the known processes for so doing.

“The above process may be varied by substituting alkaline sulphates or sulphurous acid for the sulphuric acid, but in this case sulphite of alumina will be produced, which will, however, be converted into the sulphate by exposure to air, so that it may take up the required proportion of oxygen.

“The process may be varied by the use of soda or potash or their carbonates in the place of ammonia.”

*Phosphate of Ammonia and Phosphates
of Lime.*

A further contribution to the practical chemistry of the natural phosphates of alumina has been made recently by John Berger Spence and Peter Dunn, in the following specification:—

“Our invention refers to certain methods of treating products arising from the practice of an invention, for which Letters Patent were granted to Peter Spence, dated Ninth June, One thousand eight hundred and seventy, No. 1676.

“According to that invention, the substance known by the name Redonda Phosphate and other phosphates of alumina, are used for

the manufacture of alum, and this having been crystallized there remains a mother-liquor, consisting chiefly of a solution of phosphoric acid; and our invention refers to certain methods of treating this mother-liquor, in order to obtain substances which may be conveniently and advantageously employed as manure.

“According to our first process, we take the said mother-liquors and cause them to be absorbed by sawdust or other convenient substance, which will, in like manner, hold them mechanically; and we then place this material in purifiers of gas-works, or in similar apparatus, so that the impure gas shall pass through, or in contact with it, as is now the case when gas is purified by other substances, and this operation is continued until all the acid in the said mother-liquor has been neutralized by the ammonia compounds which have existed in the gas. The resulting compound being chiefly phosphate of ammonia mixed mechanically with the sawdust, is available as a valuable manure, or the phosphate of ammonia may be dissolved out and thus separated from the sawdust.

“According to a second process, we distil ammonia compounds from gas ammoniacal water into the said mother-liquor, by which

means we obtain a substance which, as before, is chiefly phosphate of ammonia.

“According to a third mode of treating the said mother-liquors, we use them instead of sulphuric acid, or to replace a part thereof, in the manufacture of superphosphate of lime from the ordinary tri-basic phosphate of lime of commerce; and, by using, say, one-half of such mother-liquors, together with one-half the usual quantity of sulphuric acid, we obtain a manure much richer in soluble phosphate of lime than by the usual method.

“Fourthly. We use the said mother-liquors to produce therefrom precipitated or insoluble phosphate of lime, by adding to such liquors as much lime or carbonate of lime as will produce neutrality, which condition will easily be found by practice, and we thus obtain a compound of considerable value as a manure.

“Fifthly. We obtain from the said mother-liquors a soluble, or partly soluble, phosphate of lime, by calculating the quantity of lime in proportion to the phosphoric acid contained in the solution, so that the result may be a mono-basic phosphate of lime. As a guide for this operation, we may state that when the liquors, after the alum is extracted, are of the specific gravity of 1.4 or 80° Twaddle, we find that the quantity of dry slacked lime or

hydrate of lime required is 1 lb. for every 15 lbs. of the said mother-liquors; and we add the said quantity of lime after having boiled the liquors to such an additional strength as will produce a friable compound in suitable condition to be used alone or mixed with other manures. The extent to which the liquors are to be boiled down to afford this condition will readily be ascertained by practice. By this process, we find that a considerable portion of the phosphoric acid is combined with the lime in the state of mono-basic or soluble phosphate of lime, which is the more valuable condition as a manure.

“Having thus described and ascertained the nature of our said invention and the manner in which the same is to be performed, we desire it to be understood that we claim the use of the mother-liquors resulting from the manufacture of alum according to the patented process of the said Peter Spence aforesaid, for the production of manure by the processes substantially above described, that is to say,—

“Firstly. By submitting the said mother-liquors to illuminating gas during the purification thereof.

“Secondly. By distilling gas ammoniacal water into them.

“ Thirdly. By using them instead of the sulphuric acid or a portion thereof employed in the manufacture of superphosphate of lime from the ordinary tri-basic phosphate of lime.

“ Fourthly. By adding lime or carbonate of lime thereto in such manner as to produce precipitated or insoluble phosphate of lime.

“ Fifthly. By adding lime in such quantity as to produce a soluble or mono-basic phosphate of lime.”

Townsend's Process.

Mr. Joseph Townsend, of Glasgow, has patented, quite recently, a process for the chemical treatment of mineral phosphates of alumina, which is worthy of the best consideration, as it embraces some novel and very valuable ideas. I have not yet determined its practical economy ; but having previously worked in the same direction, there is little doubt, in my mind, that any defect in that respect, if one may possibly exist, would soon disappear through the improving effect of practical experiment. The author thus describes his invention :—

“ This method has for its object to utilize

and obtain valuable products from phosphates which contain alumina, and which are obtainable, or similar to what are obtainable, from Redonda, in the West Indies.

“And in order that the method may be properly understood, I shall proceed to particularly describe the various processes comprised in it as applied to a phosphate containing about 40 per centum of phosphoric acid and 20 per centum of alumina, and it must be understood that when the material operated upon contains other proportions of the ingredients the processes are to be correspondingly modified.

“By my first process, 50 lbs. of soda or 75 lbs. of potash, are mixed with the phosphate, and heat is by preference applied either by fusion or boiling in about 50 gallons of water. After settling, the supernatant liquor is run off, or it is filtered, and the phosphate of soda or of potash that is formed is separated by crystallizing, or by concentrating and depositing, when the remaining liquor will consist principally of aluminate of soda or of potash. When it is aluminate of potash that is wanted, aluminate of soda may be first formed as described, and the aluminate of potash be subsequently obtained by double decomposition on adding chloride of potas-

sium or carbonate of potash. If alumina is wanted, its deposition from the aluminate of soda or of potash is obtained by injecting or otherwise applying carbonic acid.

“By my second process, 12 lbs. of soda or 18 lbs. of potash and 47 lbs. of lime are added to the phosphate, and by preference heat is applied by boiling, whereby aluminate of soda or potash and phosphate of lime are formed, the former in solution, and the latter as a precipitate.

“By my third process, 47 lbs. of lime are added to the phosphate, and by preference heat is applied by boiling, whereby there is formed a mixture of alumina and phosphate of lime, which can be used as a manure or fertilizer.

“This mode of utilizing the Redonda or similar phosphates containing alumina by adding lime to form a phosphate of lime usable as a fertilizer, is obviously also applicable, although the alumina, or more or less of it, may have been separated before adding the lime. Thus, if the aluminous phosphate is first treated with sulphuric acid and sulphate of ammonia or of potash, and the alum thereby formed separated, phosphoric acid is set free, and, remaining in the mother-liquors, may have the lime, or, what will in this case

answer as well, its carbonate added to it, and so be converted into phosphate of lime; or alum may be obtained by adding chloride of potassium and sulphate of magnesia, and after it is separated by well-known means the remaining liquors will contain phosphoric acid, which may be precipitated as phosphate of lime, by adding lime or its carbonate, as before.

“By my fourth process, 58 lbs. of lime are added, and cause the formation of a mixture of phosphate and aluminate of lime, also usable as a manure or fertilizer; or aluminate of soda or of potash may be obtained from the mixture by adding 20 lbs. carbonate of soda, or 26 lbs. carbonate of potash, leaving carbonate and phosphate of lime usable as a manure or fertilizer. If phosphoric acid is wanted, nitric, sulphuric, or hydrochloric acid is added to the phosphate of soda or of potash obtained by the process hereinbefore described as my first, which sets free the phosphoric acid, forming at the same time the nitrate, sulphate, or chloride of the alkali of the phosphate, which salt can be separated by well-known means; or a phosphate of an earth can be obtained by adding to the phosphate of soda or of potash, lime, magnesia, baryta, or strontia, or a soluble salt of any of these earths.”

CHAPTER XX.

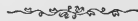

THE PHOSPHATES OF ALUMINA AND IRON AS RAW MATERIAL FOR DEFECATING TOWN- SEWAGE.

THE utilization of town-sewage is that paramount problem of hygiene and economics which finds a practical solution more nearly complete in the use of alumina and iron phosphates and oxides than can be accomplished otherwise.

The sewage of towns is a rich fertilizing material, by reason of the nitrogenous organic matter which it contains; but the putrefactive tendency of the latter invests it with unwholesome influences as to the atmosphere and vegetation. It is, at the same time, very bulky, on account of its enormous volume of water of dilution.* In dealing

* The quantity of sewage entering the Thames from

with it, consequently, there must be such an adjustment of the public and private interests involved, as will secure the entire separation, in profitable form, of all the foreign matters, whether dissolved or suspended, as well as the deliverance of the effluent water in potable condition for mixing with any stream, and by means which will not disturb social convenience or comfort.

In other words, the means which are employed must be free from engineering difficulties, very simple as to manipulation, and always under control as to economical supply and management. Therefore, the defecating agent must be from an inexhaustible source near at hand, and such a pliable material that it can be made to do its work over and over again, indefinitely, after having, at each successive operation, previously given up to commerce, agriculture, or the arts, that more valuable portion which is not needed for de-

London and its suburbs is computed to be 31,650,000,000 gallons annually; and the proportion of solid constituents varies from $3\frac{1}{2}$ to 17 ounces per ton of sewage, according to locality. This includes both the suspended matters and those in solution.

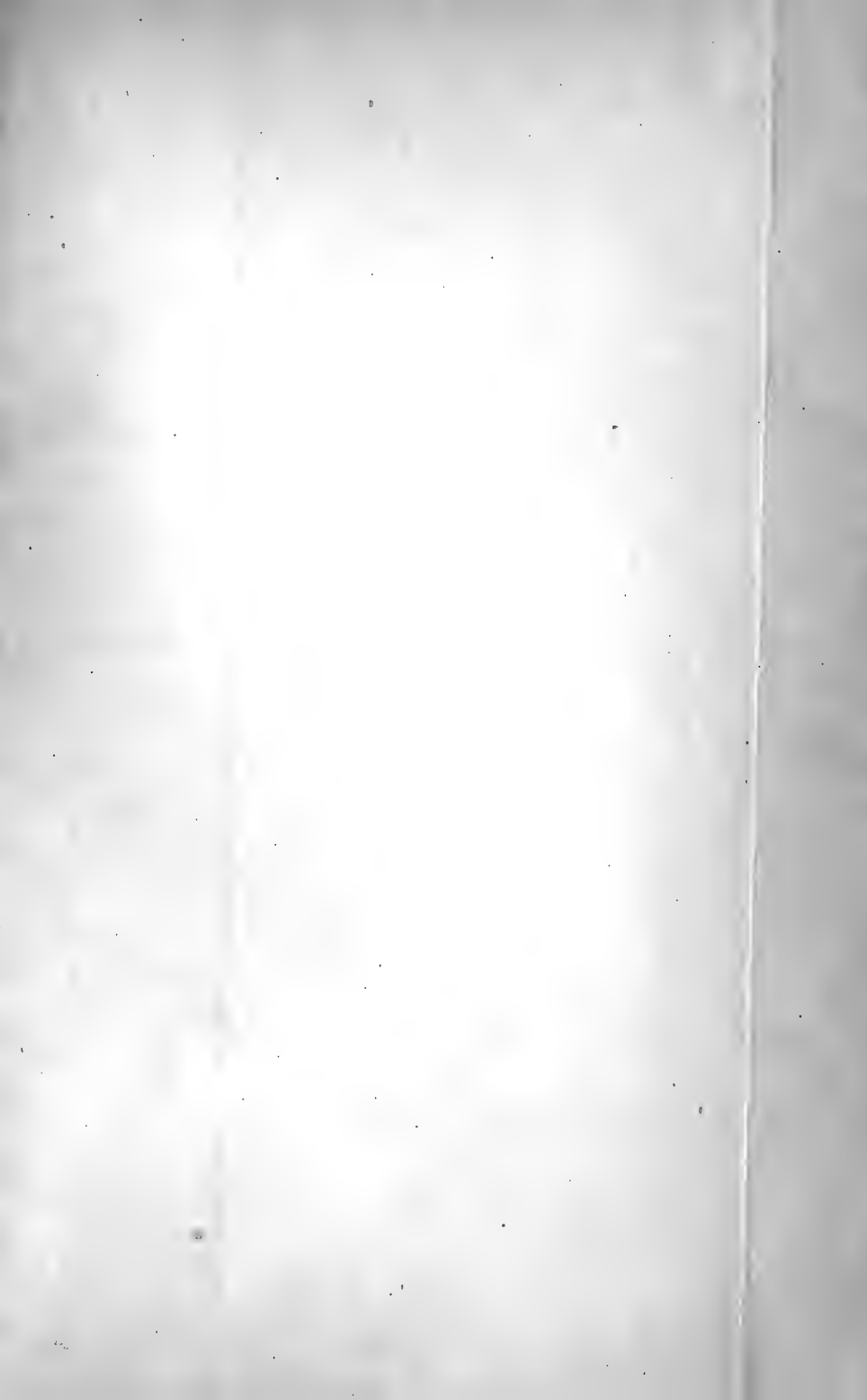

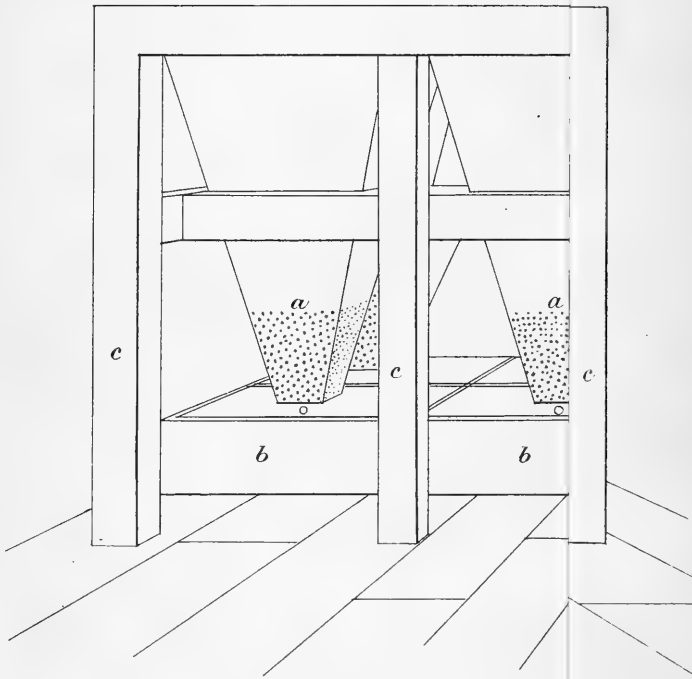

fecation. However rapidly progressive may be the daily consumption of such an agent, this constant reproduction of supply will fully keep pace with every demand upon it.

By adopting Forbes's process as the initial purifying operation, a long stride may be made towards the accomplishment of the purposes in view. The alumina and iron salts are well known to have the property, in characteristic degree, of separating organic, sulphuretted, and infectious matters from liquors; and it is only necessary, as Forbes prescribes in the case of sewage, to employ a solution of any mineral phosphate, like "Alta Vela" and "Redonda Guanos", in either sulphuric or hydrochloric acid. This solution is made to flow as a thread-like stream into the sewage, and so that it may meet, concurrently, a thin stream of milk of lime. At the moment of contact, the lime neutralizes the acid which holds the alumina and iron oxides or phosphates in solution, and, consequently, these latter, in precipitating as a solid, carry down all the suspended and some of the soluble matters of the sewage.

The precipitate is a valuable mixed matter

DRAINING VATS — PERSPECTIVE VIEW

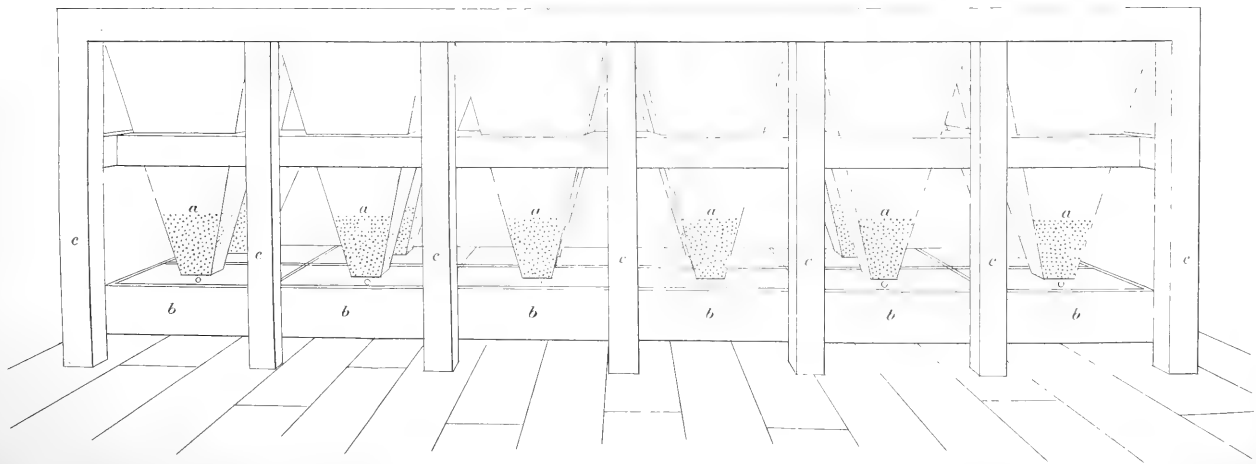

SCALE



which will receive consideration directly; and the clear fluid portion or effluent water retains, of its original impurities, only a portion of saline ammonia and other salts in solution. These must be removed, in great degree at least, by further treatment; and the best course in my judgment is to let the effluent water flow from the precipitate upon beds of peat charcoal. By infiltration through these media it becomes quite or nearly sweet and pure; for the chemico-mechanical properties of peat charcoal are peculiarly great for destroying the septicity of liquors and removing any tendency to unwholesomeness. Moreover the peat charcoal accomplishes this result by increasing its own commercial value, as a fertilizer, in degree nearly proportional to the amount of saline impurities which was contained in the infiltrating effluent water.

Though I have not yet determined the question, actually, it is my impression that the capacity of the charcoal for abstracting certain saline matters from the effluent sewage waters is so great, that it would serve for a long protracted period as a filtering medium.

In other words, the effluent water may be passed through peat charcoal in oft repeated fresh currents without producing saturation ; and that when saturated with saline matter it may be revived by calcination in suitable vessels to do its original service over and over again an indefinite number of times. Its ammonia being given off ; at the same operation could be reclaimed by simple condensation and sent to market in pure solid form.

Such a profitable mode of making the charcoal a self sustaining material on the spot would endow the enterprise of purifying and utilizing sewage with both scientific and practical perfection.

No sewage is fit for any process of filtration or irrigation until the sludge has been previously separated ; and the mass of antiseptic filtering medium required for the final treatment or infiltration of the effluent water, will be very materially lessened by using a chemical agent as described for purifying the liquor, in degree at least, while promoting the deposition of the sludge.

It is always preferable to use hydrochloric

acid as the solvent for the mineral phosphate in this connection, because sulphuric solutions cause the formation of sulphate of lime, which renders the sewage precipitate unprofitably bulky and weighty.

I propose, however, to make the sewage enterprise independent of all natural phosphates of alumina; and, indeed, to liberate it from the contingencies of a precarious supply of any defecating material. To this end only the quantity which may be necessary for the treatment of the first batch of sewage will be required; and for the purpose, I replace the natural phosphate by a new artificial material which is, in fact, a waste product at present; being the "*mother-water*" as eliminated by my processes for the precipitation of pure phosphates of lime from hydrochloric solutions of mineral phosphates of lime described in Chapters IX and X.

It consists of alumina, phosphate of alumina, oxide of iron, and phosphate of iron, in the state of liquor; and is, qualitatively, a counterpart of the acid solution of Alta Vela or Redonda Guano, but in superior degree as to the quantitative relation of the best consti-

tments. Being, moreover, a by-product, it saves all the expense and trouble of the acid and manipulation involved in the use of Alta Vela and Redonda Guano; is always very cheap, and in abundant supply on the spot, and releases the sewage-purification enterprises from all dependence upon the contingencies incident to an imported material. Being a hydrochloric solution, the sewage precipitate produced by its means has the maximum degree of concentration, as will be seen by comparing the results in the analytical table given over leaf.

The organic matter contains nitrogen in proportion equivalent to $1\frac{1}{2}$ to 2 per cent. of ammonia. The figures of the following table prove that sewage precipitate under most favourable conditions cannot contain more than 5 to 10 per cent. of phosphoric acid and $1\frac{1}{2}$ to 2 per cent. of ammonia. These are the only components of agricultural value, except the organic matters. The ammonia gives a money expression to it of 24s. to 32s. per ton; and the phosphoric acid associate being combined with alumina and iron is worth only 10s. to 15s., so that the total value

COMPONENTS.	Sewage precipitate obtained by means of a sulphuric solution of Alta Vela Guano. <i>Morfit and B.W.Gerland.</i>	Sewage precipitate obtained by means of the "mother-water". <i>Morfit.</i>
Moisture - - -	8.60	7.20
Sand and silica - -	38.04	36.49
Organic matter, insoluble -	8.35	7.18
Organic matter, soluble in water -	2.04	2.15
Organic matter, soluble in hydrochloric acid -	9.37	9.14
Alkaline and magnesian chlorides and sulphates -	.90	1.25
Sulphate of lime - -	3.18	—
Carbonate of lime - -	12.84	} 5.70
Lime, combined with organic acids	3.29	
Carbonate of magnesia -	1.07	—
Peroxide of iron - 5.35	} 15.26	} 30.09
Alumina - - 4.66		
Phosphoric acid - 5.25		
Total - - -	102.94	99.20

would be only 34s. to 47s. per ton. Hence, it follows that the use of Redonda and Alta Vela Guanos, in the defecation of sewage, becomes a profligate application of them when the precipitate is to be dried and sold as a fertilizer. Greater manurial value would

be obtained at less cost by the substitution of pure phosphate of lime.

The mineral phosphates, as well as the "mother-water", must, therefore, be emancipated in more profitable forms, after having done their work of purifying the sewage; and the practical methods for widening their sphere of industrial utility will be the subject of the following chapter. At the same time, it should be remarked that the organic matters, silica, and chemico-mechanical temperament generally, of the sewage precipitate, render it a superior special manure for clay soils.

CHAPTER XXI.



THE PROFITABLE UTILIZATION OF THE PHOSPHAT-ALUMINA PRECIPITATE FROM SEWAGE, AS RAW MATERIAL FOR VARIOUS PRODUCTS.

THE information about to be set forth refers to the profitable utilization, for sundry purposes, of the alumina-ferruginous precipitate that is formed, by means of lime acting on solutions of aluminium and iron oxides and phosphates in connection with sewage, for the defecation and deodorization of the latter.

It is indifferent whether these are specially prepared solutions of a natural phosphate of alumina and iron in sulphuric acid, like the "Alta Vela Guano"; or the "*mother-liquor*", which is left when phosphate of lime is separated in a pure state from hydrochloric solutions of mineral phosphate of lime, by the skilfully adjusted addition of lime, chalk,

whiting, oxide of aluminium, oxide of iron, phosphate of alumina, or phosphate of iron as the precipitant.

The precipitate thus formed consists of the organic matter which was suspended in the sewage, together with phosphate of alumina, phosphate of iron, oxide of aluminium, oxide of iron, sulphate of lime, and some excess of the lime-precipitant; provided the defecating agent or liquor was a solution of "Alta Vela" or kindred mineral in sulphuric acid.

But, if the hydrochloric "mother-liquor" from mineral phosphate of lime should be substituted for the sulphuric defecating liquor, then the precipitate will not contain any sulphate of lime.

Furthermore, the aluminium and iron compounds may be precipitated from the "*mother-liquor*" by means of milk of lime, *without the intermediation of sewage*. But, in such instances, the precipitate will be free from both sulphate of lime and organic matter; that is, the aluminium and iron compounds will be thrown down pure.

In each case, however, the precipitate has a pulpy condition, most easily acted upon by

dilute acids and other chemical agents, and is free from all associates which are obstructive to the purposes in view. These properties give it, therefore, a commercial value very much greater than that of the original mineral whence it was derived, even though the expense of thus improving it may be taken into calculation. Indeed, it is their application to sewage in the first instance, that gives to the mineral phosphates of alumina and iron their maximum of commercial appreciation.

The precipitate formed with sewage is a good manure, qualitatively, by reason of the nitrogen and phosphates which it contains;—all of these being in potential conditions for promoting vegetation. This effect can be realised, however, only by sowing the precipitate in its hydrated state; for, when dried into a hard powder by heat above 212° Fahrenheit, for greater economy and convenience of transportation, it loses much of the sensitiveness of its chemical temperament, and becomes less quickly assimilable by the growing crops.

This fact, and the additional circumstance

that the alumina and phosphate of alumina which it contains may be turned to better account for various technical purposes, prove, however, that the restriction of this precipitate to agricultural service, is a waste of its capacity for a wider range of utility. There need not be any sacrifice in this wider application of the nitrogenous organic contents.

The economic applications which I propose to give this new material, and the modes of treating it for them severally, are as follows :—

Firstly.

For the Reclamation of its Nitrogenous Matter as Material for the Manufacture of Ammonia Salts.

The precipitate may be made to give up all its insoluble* organic matter for indepen-

* The whole of the nitrogen could be reclaimed as ammonia salt by combustion of the dried precipitate with soda lime, as suggested at pages 51-53. The solid residue would still be a good material, both for the purposes named in page 408, and for the products noted in this chapter.

dent use as an ammonia material. It is only necessary to draw off the effluent (sewage) water, wash the residue once, then to treat the pulpy mass by means of a current of steam, and to add hydrochloric acid gradually, until the mass is dissolved. A cloudy liquor will be the result; but this liquor, on being drawn off from the vat through a cloth, leaves its suspended matter upon the filter, and runs through as a clear filtrate.

The contents of the filter are to be washed with hot-water, pressed and dried carefully in hot-air currents. It consists of the suspended organic matter of the original sewage and precipitate, together with some sulphate of lime, if a sulphuric solution of "Alta Vela" or other mineral phosphate has been the defecating agent employed.

Being composed of organic and sandy matters in chief, it would be a very advantageous addendum for rendering clay soils loamy and rich. It might, also, serve as material for the manufacture of ammonia salts, as suggested at page 49.

The clear filtrate which has run from it is

the counterpart, in a chemical sense, of a solution of "Alta Vela Guano" in sulphuric acid; excepting that it has been made with the much cheaper hydrochloric acid, and less expensively as to time, labour, or manufacturing items. In this form it is again ready for treating crude sewage, and, being a purer liquor than a special solution of raw mineral, will produce better results.

But a prime advantage which this mode of treatment possesses is, that it will, when required, render the great enterprise of sewage purification quite independent of any further supply of mineral phosphate or "*mother-liquor*" after that quantity which is consumed for the treatment of the *first* batch of sewage; for it reclaims the defecating agent over and over again for the repetition of its service an indefinite number of times. In scarcely less important degree, it exerts a valuable industrial influence by thus liberating the mineral phosphates of alumina and the "*mother-liquor*", for an expansive sphere of usefulness.

Secondly.

As Material for Alum, Pure Phosphates of Alumina, and Pure Phosphates of Lime.

The precipitate itself, whether made with or without the intervention of sewage, is, by reason of its comparative purity and great solubility in acids, a most valuable raw material in the manufacture of alum, crude phosphoric acid, pure phosphates of alumina, pure bi-, di-, and tri-phosphate of lime, and pure aluminate of soda as a ready saponifier for making superior soap.

It has, also, the capacity for being made to replace silicate of soda as a cheapener of common soaps. All of these products are in great request, though few of them have yet appeared in the market to any large extent, because hitherto an adequate source of them has been wanting.

The processes of Peter Spence, John Berger Spence, Peter Dunn, and Joseph Townsend, for converting "Redonda Guano" into alum and crude phosphoric acid, as already set forth, offer means which will apply advantageously to this precipitate. From this latter

all of the phosphates of alumina and lime can be made in pure forms most easily and profitably by direct combination.

As a basis of these processes, either the phosphate sewage precipitate or the "mother-liquor" of mineral phosphates of lime has very great advantages over "Alta Vela" and kindred minerals in all the relations of manufacturing economy and convenience.

All that remains to be added in this connection, therefore, are practical instructions for the elimination of the pure phosphate of alumina constituent, and for the manufacture of aluminate of soda.

Thirdly and Fourthly.

*Aluminate of Soda or Ready Saponifier, and
Common Salt.*

Aluminate of soda may be made either directly from the precipitate or from the solution of this latter, when it has been dissolved in hydrochloric acid for the separation of its organic matter, as explained already.

Supposing that the clear filtrate which runs through from the organic matter is taken as the basis, then it is only necessary

to bring it to boiling by steam-currents, in wooden vats lined with lead, and then to add soda-ash in just sufficient quantity to neutralize the acid and precipitate all the alumina and phosphate of alumina.

This being done, the whole is allowed to rest, but must be kept warm by enamelled tubes, through which there is a continuous circulation of steam.

Lime, as milk of lime, may be substituted for soda-ash without difference as to manipulations. Caution must be observed to add it through a fine sieve, so as to prevent the passage into the liquor of coarse particles and the presence of any great excess in the resulting precipitate. As soon as the precipitate or deposit settles at the bottom of the vat, the clear liquor above is to be drawn off into a pan and evaporated to dryness. This evaporated mass will be *common table salt* when soda-ash has been employed, and *chloride of calcium* if milk of lime was the precipitant; and both have a commercial value.

In case the hydrochloric acid may have contained any arsenic, the chloride of sodium product will be similarly contaminated, and

the use of the latter must, therefore, be restricted to the manufacture of soda-ash.

The precipitate is next to be washed with several relays of fresh water and heated by steam-currents during each washing.

When the first wash-water has been removed, commercial caustic soda of best quality is to be added to the precipitate in the same vat and during constant ebullition, by means of steam-currents.

By prolonged boiling, the alumina and phosphate of alumina become dissolved, while oxide of iron and phosphate of iron, if any are present, will remain as brown insoluble residue. To provide against any excess of soda in the solution, it were better that a small portion of the aluminium compounds should be left with this insoluble residue.

Sufficient repose must now be allowed, in order that the liquor may settle clear. This liquor is an aqueous solution of aluminate of soda, containing more or less of phosphate of soda with phosphat-aluminate of soda, which latter assimilates to the former in properties quite near enough for the practical purposes under explanation.

The liquor needs only to be drawn off into a clean pan, and evaporated to the state of a thin syrup, and left to cool, in order that most of the phosphoric acid may crystallize out as phosphate of soda. These crystals, being separated by filtration or draining, are to be washed and dried for market. The "mother-liquor" from which they are drained, on being evaporated to dryness, becomes a "*ready saponifier*" or crude aluminate of soda.

When it has reached the consistence of a mush in this pan, it is to be transferred into other and more shallow pans to cool. Thence it is to be packed in sheet-iron boxes, about two feet square and twelve inches deep, covered with closely-fitting lids. These are to be placed in large furnaces, heated to low red heat, carefully regulated, so as not to destroy the boxes.

In about an hour, the moisture will have passed off, and the contents of the boxes will be beautifully white, with a blue tinge, possibly.

After cooling, the contents of the boxes are to be emptied into barrels fitted with

tight covers and ground in a mill to coarse powder as soon afterwards as possible.

Finally, it is to be packed in paper board boxes, the joints and inner surface of which are to be fastened and coated with a dense aqueous solution of silicate of soda. On drying, this leaves a glass-like surface, which protects the box from the corrosive character of the powder.

The saponifier should be made of uniform composition always, so that a box of certain size may contain a sufficient weight to saponify a certain weight of melted fat and of water measured by the same box twice or more times filled. In this manner, weights may be dispensed with, to the great convenience of the million; for this material will enable every housewife or servant of common intelligence to make her own soap with the kitchen fat.

This saponifier is wholly soluble in water, and though the alumina acts the part of an acid to the soda base in this solution, it holds on by such a feeble tenure that it will desert its chemical union upon the slightest provocation. Thus, when the solution is

brought into contact with the melted fat, the latter seizes the soda and water to form soap; which will have a greater hardness than usual, by reason of the diffusion through the paste of the alumina and phosphate of alumina which are set free during the saponifying reaction.

Even the carbonic acid of the air would decompose it, and therefore the packages must be sealed around the joints of the cover with a narrow strip of paper; then dipped into a hot mixture of resin and pitch, and finally covered, while warm, with an envelope of strong paper to render it hermetically close.

Fifthly.

Pure Phosphate of Alumina.

If it is desired to make pure phosphate of alumina, then, instead of evaporating the previous solution of aluminate and phosphat-aluminate of soda, it must be treated in the cold with barely enough of sulphuric or hydrochloric acid to neutralize exactly the soda constituents; for, at that precise point, the alumina and phosphate of alumina will become insoluble and precipitate in a pure

state. After repose, the clear liquor above is to be drawn off, and the precipitate is to be washed thoroughly by several relays of fresh water kept at boiling temperature by currents of steam entering the mixture. Finally, it is to be drained on a filter, pressed and analyzed to determine the amount of free alumina which it may contain. It is then ready to be combined with the necessary proportion of phosphoric acid for converting it wholly into phosphate of alumina soluble or otherwise, as may be required.

The more alumina which the mineral precipitate or "mother-water" may contain, the greater is its value for these purposes; and thus, by the proposed treatment, they will acquire an appreciation per pound where they only have it now per ton.

Phosphate of Alumina in the Manufacture of Sugar.

The great advantages of the aluminium compounds in the manufacture of sugar have been recognized, since a long period, by chemists; but certain objectionable features, per-

taining to all except phosphate of alumina, have prevented their application in that art.

Until later years there was no source of a large and regular supply of phosphate of alumina at a reasonable price, and hence it was only about 1860 that it began to be employed. It was first introduced by Reynoso into the manufactory of M. de Alma, in Cuba (*Journal de Pharm. et de Chimie*, p. 232, vol. ii, 1865). The great practical success there realized with it as a means of effecting the almost absolute defecation of cane-juice, has been confirmed more recently by Dominique, in France, who has reported his experience to *The Sugar-Cane* of July, 1870, p. 415.

The phosphate of alumina, dissolved in phosphoric acid, having been poured into the cane-juice, milk of lime is then added. A precipitate of phosphate of alumina ensues, carrying down with it some alumina, all the lime in combined and free states, together with the colouring and nitrogenous matters of the original juice. The latter is thus left pure for concentration, by freezing or heating and

crystallization, as it now contains only sugar and some normal saline associates.

The precipitate, on being pressed and dried below 200° Fahrenheit, forms a rich and valuable fertilizer.

Phosphate of Alumina in Dyeing.

“M. Collas, of Paris, has succeeded recently in using phosphates as a mordant in dyeing and calico-printing. To this end, he passes the yarn or the cloth through a weak solution of a phosphate in an acid and afterwards through a dye bath or an alkaline bath, by means of which the phosphate is fixed upon the fibre.” (It may be phosphate of lime or phosphate of alumina.)

“The stuff prepared in this manner is ready to be dyed with aniline or other colours. The stuff thus prepared may be passed through a solution of tannin before being dyed or printed. Thus, for instance, in order to dye in dark colours, the yarn or cloth is immersed in a warm and clear decoction of one kilogramme of sumac in four and a half litres of water at 84° to 104° Fahrenheit, after which the stuff is wrung out.

It is then to be immersed in an acid solution of the phosphate of 50° Baumè, for twenty or thirty minutes. On being then wrung out and washed, it is ready to be dyed. Purple, especially, yields fine hues.

“In order to dye with insoluble colours, the cloth is immersed in a mixture of gelatinous phosphate with a solution of gelatine in water, at 75° to 85° Fahrenheit.

“Cochineal lake may be prepared in this manner by stirring gelatinous phosphate into a filtered decoction of cochineal.”

Phosphate of Alumina as a Glaze for Pottery.

This salt is in much request by potters, as a glaze, and would find a constant, as well as ready market, if put forward at a reasonable price.

CHAPTER XXII.



ON SPECIAL FERTILIZERS AND THEIR PREPARATION.

PRACTICALLY, the object of fertilizers is to cause small areas of land to produce the crops of very much larger ones, with the least possible amount of labour.

Chemically, they are the food of plants and act in a twofold manner: first, by nourishing them directly; and, secondly, by transmuting the inert matters of the soil into forms and conditions which will promote the growth of vegetation.

A seed which may be sown, although it is the germ of a crop, has no power to vegetate and ripen, except through the means of external stimulants.

In all the stages of vegetal growth the physical structure of the soil is only less important than its chemical composition. It

must be neither too porous, like sand, nor too compact, like clay; but should have a temperament midway between the two. Hence, in many fields it is as necessary as the application of fertilizers, to make an adjustment of this nature by suitable mixture of different kinds of soil.

A soil, to be fertile, should contain the following elements:—

Sand Clay Gravel	} = as its mechanical agents.
------------------------	-------------------------------

Organic matters containing humus Nitrates Ammoniacal salts Potassa	} = as its assimilable and active agents.
---	---

Soda Lime Magnesia Oxide of iron Oxide of manganese Sulphuric acid Phosphoric acid (partly soluble) Silicic acid (soluble) Chlorine	} = as its mineral agents.
---	----------------------------

FIG. 1.

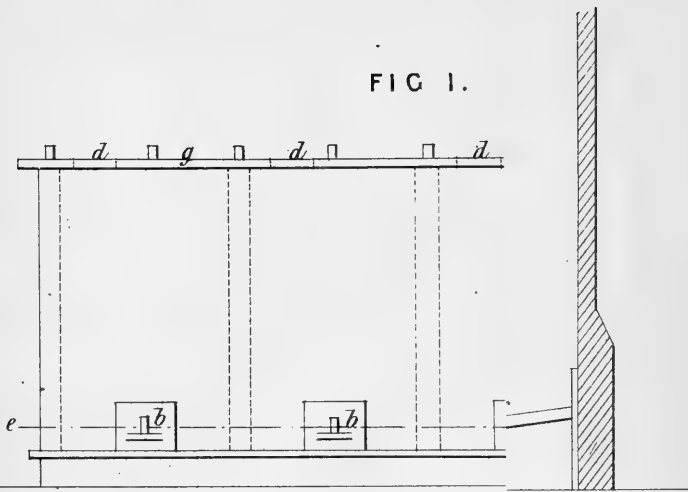
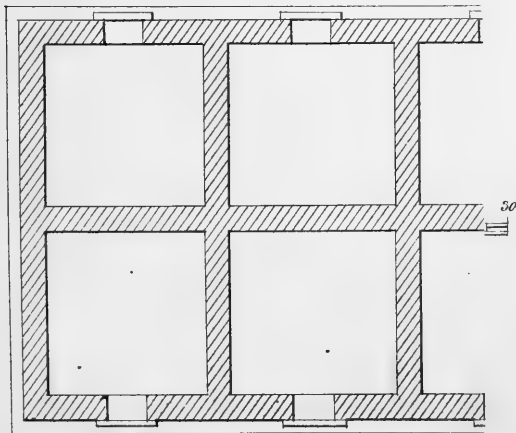

FIG. 3.



SUPERPHOSPHATE WELLS.

FIG. 1.

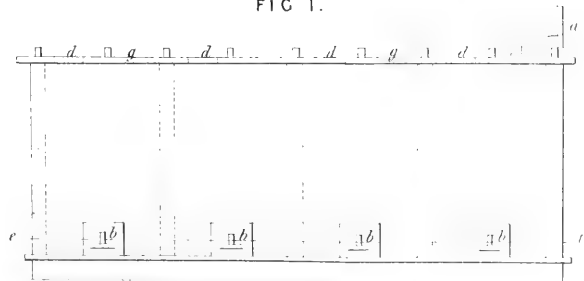

FIG. 2.

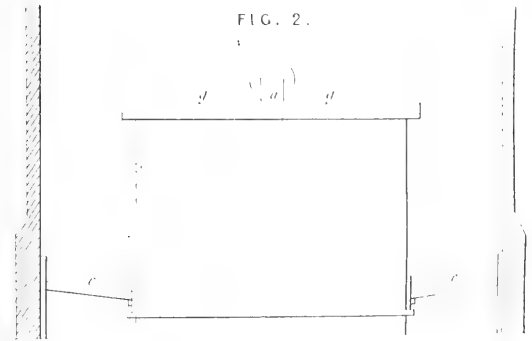
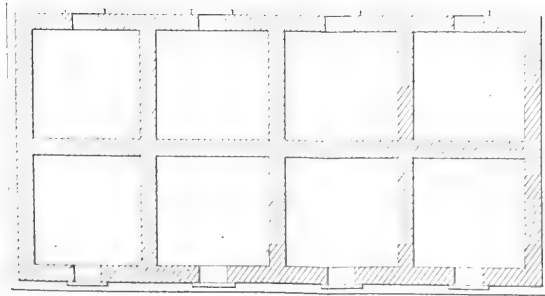

FIG. 3.



SCALE OF FEET



FRONT & END ELEVATION & SECTIONAL PLAN.

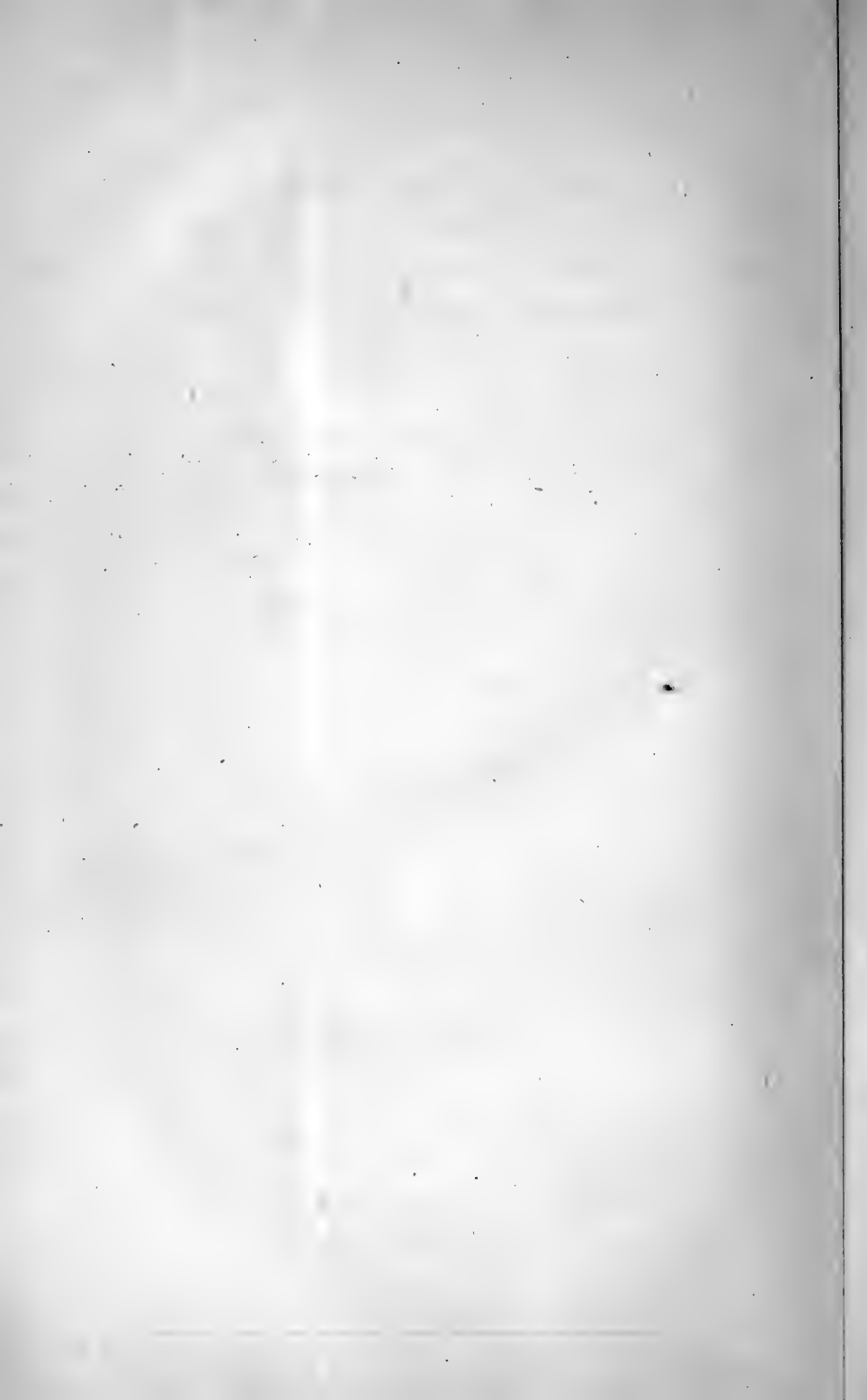

In addition, there should be a reserve of rocks and organic matters, from which the decomposing influences of air, time, and the soil, will eliminate the foregoing elements at later periods, as will be necessary to insure a *permanent* fertility.

The mechanical portion serves to facilitate the passage of water through the soil ; and, consequently, to precede its chemical action in the premises. This action consists in absorbing and dissolving carbonic acid, ammonia, and other desirable elements from the air and the soil, and rendering assimilable by these means the elements of the latter, which otherwise would remain inert. Thus it assists, not only directly, but indirectly, in the nutrition of plants, and more particularly in the development of their organic portion. A clay-soil requires, therefore, to be deeply ploughed.

The inorganic portion derives its constitution from the mineral elements of the soil.

By repeated cropping, a soil becomes exhausted of its fertilizing elements ; and they must be restored, therefore, from time to time, by means of deep ploughing, and the application of manures.

All plants are not alike, either as to the quality or quantity of their food; that is, certain species are so far eclectic in this respect, as to exercise a greater avidity for the kind which is richest in their predominant element. Therefore, each of the great families of plants must be manured according to its peculiar appetite. Thus, for example: nitrogen and phosphates of lime are the preferred nutriment of the cereals, including cotton; nitrogen and potassa are the choice of the leguminous class; and phosphates, potassa, and nitrogen that of the roots. The gramineous family differs very little from the roots in its appetite.

But even though one of these elements may be dominant in distinct or individual crops, the latter cannot attain to a normal or abundant harvest, unless their peculiar food in the soil is associated, in degree at least, with all of the other requisite elements.

The fertilizer is to be applied to the soil and intermixed thoroughly with the surrounding earth from the roots upwards. Its components must be in conditions for acting together within a given time, in order to pro-

duce a wholesome growth of the crops. Indeed, it is expedient to have a portion of the fertilizer in active forms, so that in the early stage of the development of the plants, the latter may acquire that vigorous constitution which will enable its organs to exert all their powers of assimilation and progress to a fruitful maturity.

Saline manures, or those directly soluble, are liable to diminish the crops on light soils and dry seasons, more particularly when they may be mixed in injudicious or excessive proportions. The more favourable season for applying them, therefore, is a wet one, which will promote their thorough diffusion through the soil.

Keeping in view the foregoing principles, then, the following skeleton formula will represent a fertilizer of just constituent *relations* for general purposes.

Phosphoric acid	-	-	-	35'00
Potassa	-	-	-	45'00
Ammonia	-	-	-	20'00
				100'00

These are the prime elements of fertiliza-

tion ; but, being always accompanied in natural soil or artificial fertilizers with the necessary associate elements of plants, they constitute a complete manure for any crops.

The proportion of 250 to 300 lbs. of manure containing these three prime elements in the percentage ratio above noted, will suffice to stimulate an acre of ground into the production of an abundant harvest, and leave behind some residue for the succeeding year's crops. From this reserve, however, the predominant element of the harvested crops will have been almost, or nearly, entirely exhausted.

This fact must be remembered in the rotation of crops ; so that in making one kind succeed another, the elementary relations of the subsequent fertilizer may be modified accordingly. In other words, having grown a crop of roots this year on a plot of ground manured with the normal fertilizer, then, if it is desired to prepare that plot the next year for a harvest of cereals, care must be observed to make the fertilizer richer in phosphate ; so as to restore the normal condition of the soil which has been disturbed by the peculiar

exigency of the previous root-crop as to that element.

Such are the simple rules which should regulate the composition and application of special fertilizers ; and, if faithfully practised, will, with the divine favour of rain and sunshine, eventuate in successful cultivation and profitable harvests.

Normal Fertilizer.

Bi-phosphate of lime ($\text{CaO}, 2\text{HO}, \text{PO}_5$)	-	10'00
Colombian or precipitated phosphate of lime*	-	30'00
Chloride of ammonium	- -	25'00
Chloride of potassium	- -	25'00
Chloride of sodium	- -	3'00
Sulphate of lime ($\text{CaO}, \text{SO}_3, 2\text{HO}$)	-	7'00
		100'00
		100'00

The above formula will serve for any plant, as it contains the elements of fertilization in very judicious proportions. Nevertheless, for special crops it may be modified with some advantage, and according to the

* The fertilizer must be kept dry always when it contains precipitated phosphate in association with bi-phosphate, otherwise some of the latter might "go back" into di-phosphate.

examples which will be given after the next paragraph.

Universal Dunger.

There is a popular general manure made in Germany by Hosch and Enderich, which has the following composition. It is of a greyish-yellow colour, free from strong odour, and reddens litmus paper.

Water	-	-	-	-	-	14.72
Organic and volatile matters (ammonia, 7.80)	-	-	-	-	-	26.81
Soluble bi-phosphate of lime (CaO, 2HO, PO ₅)	-	-	-	-	-	10.13
Di- and tri-phosphates of lime	-	-	-	-	-	19.48
Sulphate of potassa	-	-	-	-	-	8.46
Sulphate of lime	}	-	-	-	-	20.40
Sand, silica, etc.						
						100.00

Fertilizer for Cereal Crops.

In this family, comprising wheat, rye, rice, Indian corn, barley, and cotton, the prevailing elements of nutrition are nitrogen and phosphate of lime, with a considerable amount of alkaline salts. The normal fertilizer should, therefore, be modified and composed after this formula:—

Bi-phosphate of lime	-	-	15'00
Precipitated phosphate of lime	-	-	35'00
Chloride of ammonium	-	-	25'00
Chloride of potassium	-	-	18'00
Chloride of sodium	-	-	3'00
Sulphate of lime	-	-	4'00
			<hr/>
			100'00
			<hr/>

Fertilizer for Leguminous Plants.

Beans, peas, and other members of this family of plants contain potassa, nitrogen, and phosphoric acid, as their prevailing elements. Therefore, the following formula must be observed in preparing fertilizers for such crops :—

Chloride of potassium	-	-	40'00
Chloride of ammonium	-	-	25'00
Bi-phosphate of lime	-	-	15'00
Precipitated phosphate of lime	-	-	20'00
			<hr/>
			100 00
			<hr/>

Fertilizer for Gramineous Plants.

For the family of grasses, potassa is the dominant element; and next in order are nitrogen, lime, and phosphoric acid. Consequently, a suitable manure should consist of:—

Chloride of potassium	-	-	30'00
Chloride of ammonium	-	-	25'00
Sulphate of lime	-	-	18'00
Bi-phosphate of lime	-	-	10'00
Precipitated phosphate of lime		-	13'00
Chloride of sodium	-	-	4'00
			100'00

Fertilizer for Sugar.

Sulphate of potassa	-	-	35'00
Nitrate of soda	-	-	40'00
Bi-phosphate of lime	-	-	10'00
Precipitated phosphate of lime		-	15'00

It is a prevailing idea that alkaline chlorides should be excluded from fertilizers for sugar because of their deliquescing influence upon sugar, and it is in conformity with this prejudice that the formula has been constructed. But the true and scientific position of the question has been recently set forth by E. Feltz (*Fourn. des Fabricants de Sucre*, 1870, p. 52), and A. Marschall (*Journal of the Chemical Society*, 1870, p. 457).

The former chemist concludes, from his observations, "that uncrystallizable substances, whether invert sugar or those classed as organic non-saccharine bodies, are the true

molasses builders, and that they act as such in two ways : 1st. By preventing a sufficient degree of concentration ; and, 2nd. By rendering a boiled mass so sticky, that even if sugar crystals are formed, they cannot be separated from the syrup."

Marschall obtained results from his experiments which led to classifying salts as— " 1st. Negative molasses makers ; 2nd. Indifferent bodies ; and, 3rd. Positive molasses makers. The negative molasses makers, or bodies which diminish the solvent power of water for sugar are, sodic sulphate, nitrate, acetate, butyrate, valerate, and malate ; magnesian sulphate, nitrate, and chloride ; and calcic chloride and nitrate.

" The indifferent bodies which are without influence on the crystallization of sugar are potassic sulphate, nitrate, chloride, valerate, oxalate, and malate ; sodic chloride, carbonate, oxalate, and citrate, and caustic lime.

" Positive molasses makers are potassic carbonate (saline co-efficient 3·8), butyrate (saline co-efficient 0·9), and citrate (saline co-efficient = 0·6). Belaine was shown to be a negative molasses maker."

Haughton Gill (*Journal of the Chemical Society*, 1871, p. 269) also contributes an interesting paper on the saline compounds of sugar.

Fertilizer for Root Crops.

Potatoes, carrots, beets, turnips, and the like, require mostly potassa; next nitrogen; then lime; and, lastly, phosphoric acid. They must, therefore, be cultivated with this mixture:—

Chloride of potassium	-	-	30'00
Chloride of ammonium	-	-	25'00
Sulphate of lime	-	-	20'00
Bi-phosphate of lime	-	-	10'00
Precipitated phosphate of lime	-	-	15'00
			100'00
			100'00

Nitrate of soda may replace the ammoniacal salts as the source of nitrogen, but five parts of the former must be taken in place of three of the latter, those being their equivalent proportions.

All the other elements of fertilization will be found generally in the soil; and the plant acquiring full vigour in its early growth from

the fertilizers prescribed, will be able to assimilate whatever additional nutriment it may need from the surrounding sources of the earth and air.

In all cases, the land must have been well limed within two or three years, in order to rouse, chemically, its organic matters; but not immediately preceding the application of the fertilizers by many months. For if the lime has not been in the ground long enough to have become wholly carbonate, or combined otherwise, it would cause a waste of the ammoniacal salts.

In connection with this subject, the reader will do well to study the instructive paper of Dr. Aug. Voelcker, F.R.S., "On the Productive Powers of Soils in Relation to the Loss of Plant Food by Drainage", which is published in the *Journal of the Chemical Society* for 1871, p. 276 to 297.

CHAPTER XXIII.



FORMULÆ FOR THE CHEMICAL ANALYSIS OF PHOSPHATIC MATERIALS AND PRODUCTS.

THE phosphates of lime which come under chemical treatment for conversion into fertilizers have either an animal or mineral origin, but most generally the latter.

Mineral phosphates differ in composition with their source and the care employed in preparing them for market. It becomes, therefore, indispensable to a well regulated system of manufacture, that each and every invoice of them which may be intended for conversion into fertilizers shall undergo, previously, a *full* chemical analysis. The full analysis is particularly necessary, in order to distinguish what proportion of the phosphoric acid may belong to alumina, iron, and other bases than lime.

A correspondingly rigorous inspection

should be practised also in regard to commercial superphosphates of lime, and indeed all kinds of artificial fertilizers, for the protection of the consumer and in the cause of honest trade. The necessity for such an absolute custom will be seen in the very wide differences in the samples which may come under examination. This great diversity between their pretended and actual composition-value, is due either to fraud or unskilful manufacture, and frequently to both.

The highest *average* per cent. of soluble bi-phosphate of lime in commercial samples is 20 to 25; but this strength is peculiar to the products of certain manufacturers only. More generally they fall below 20 per cent., and often as far down as 5 to 10, without a corresponding decrease in price.

The amount of contained soluble phosphate of lime is often represented, in the analytical report, by the higher figures of bone-phosphate of lime to which it is equivalent. For example, every per cent. of soluble bi-phosphate of lime in the fertilizer is written as 1.32, which latter record is a deception, having the effect of misleading the purchaser.

As a protection against errors of either accident or intention, the following instructions in detail are given for the chemical analysis of such materials and products as come under consideration in this treatise. They are arranged to detect and estimate any and every element that is likely to be present.

It is merely necessary to add that a certain familiarity with chemical principles and manipulations is indispensable on the part of the operator who may undertake to carry through an analysis.

Bone-Ash, and Mineral Phosphates of Lime.

All of these substances may be embraced in one general formula. The water used in the analytical operations must have been distilled; and it is also imperative to have the reagents chemically pure.

Previous to commencing the analysis, one or two sheets of blank writing-paper must be folded and stitched in book form, as a laboratory record or legend of the progressive steps of the analysis.

The first step is to select a fair average

sample of about half a pound of the ash or mineral to be analysed, mix it well, and then reduce wholly to powder about an ounce of it. A clean polished mortar, of iron or steel, is best for this manipulation.

1. *Accidental Water or Moisture.*

Fifty grains of this powder are to be weighed upon a delicate balance. Besson, Rue de la Ferronnerie, Paris, makes a very suitable instrument for ordinary work at the low price of £5. But there is certain necessary supplementary apparatus which, with packing, will increase the cost to about £8. This consists, in part, of two deep watch-glasses, agreeing precisely in weight, so that one shall be a counterpoise of the other. The powder to be weighed is placed in one watch-glass; while the opposite pan of the balance contains the duplicate glass as a counterpoise, together with the required weights. This promotes both a neat and convenient manipulation.

The other supplement is a set of fine weights, ranging from 1000 grains to one-hundredth of a grain. The larger ones

should be of gilt brass, and the smaller ones of gilt aluminium. The balance is of brass, and should turn, when fully loaded, with the hundredth of a grain. This degree of delicacy must be insisted on when giving the order. Fig. 12 shows the form of the balance.

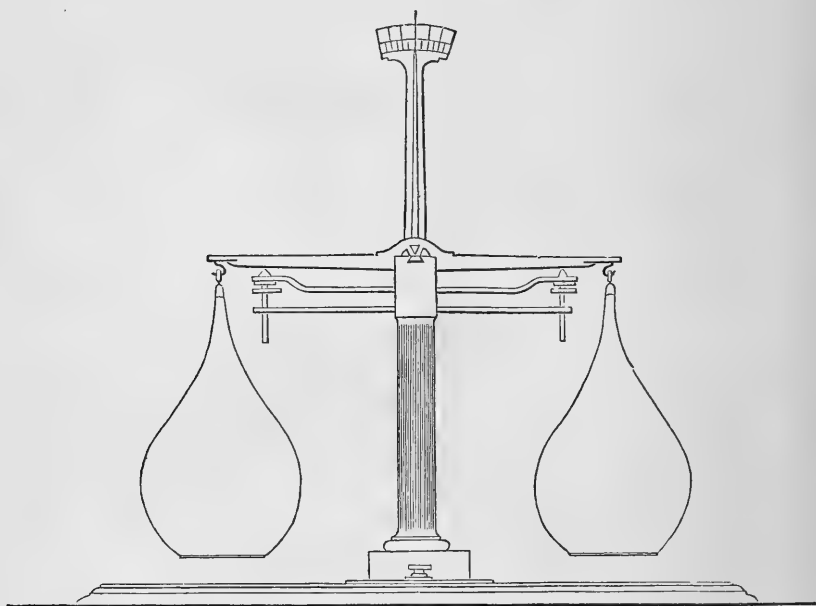

Fig. 12.

The watch-glass *a*, fig. 13, containing the 50 grains, precisely weighed, is next to be placed on a hot sand-bath *c*, with an intervening piece of hollow metal tube *b*, about two inches high, as a support, and to form a

hot-air chamber between the sand and the bottom of the watch-glass. The sand-bath may be a plain or porcelain-lined iron pie dish, containing white sand, and heated by a

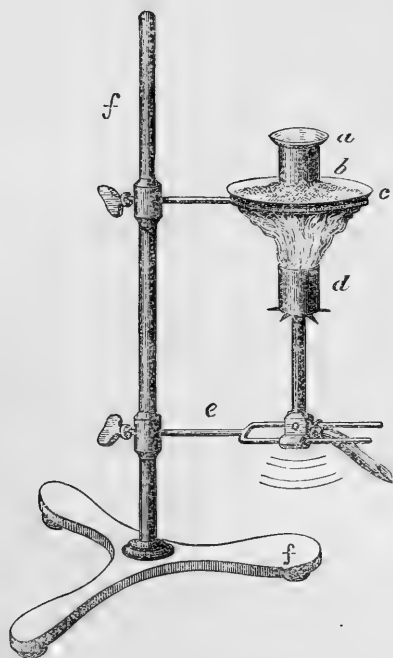

Fig. 13.

gas-burner *d*, on a sliding-holder *e*, so that it may be lowered or raised at will upon the upright support *ff*, made of iron. Here the powder is allowed to remain over a heat not exceeding 212° Fahrenheit, until it ceases to lose weight; and for determining

this point, it must be weighed from time to time, with its counterpoise-glass always in the opposite pan of the balance, until the weight becomes constant.

The constant weight shows a loss, and this loss doubled represents the per cent. of accidental water or moisture in the original sample or raw material.

If there should be any constituents of the mineral containing *constitutional* water, such as sulphate of lime or sulphate of ammonia, they will not lose it at the temperature just prescribed.

2. *Organic Matter and Constitutional Water.*

The weighed residue is next to be transferred, carefully, to a platinum crucible, and heated to redness until all volatile matter is expelled.

This is known when, after repeated weighings from time to time, the weight becomes constant, and a calx free from carbonaceous matter remains. Should any carbonate of lime be present in the raw material, this

would lose some of its carbonic acid at the heat prescribed, and thus lead to error.

As a preventive, the contents of the crucible must be cooled, then moistened with some drops of aqueous solution of carbonate of ammonia, carefully dried, and heated only to dull redness for a few moments, so as to expel the ammonia without its carbonic acid. Restitution of lost carbonic acid being thus made to the lime, the crucible is allowed to cool and then weighed. The weight thus obtained, less that of the crucible, when deducted from the previous weight, will show a loss, and this difference, multiplied by two, expresses the per cent. of organic matter and constitutional water in the raw material. The residue, or calx, multiplied by two, represents the total per cent. of fixed or earthy matters, and is to be reserved, as A, for further treatment.

Fig. 14 shows the mode of burning off the organic matter. The platinum crucible *a* is to be closed in the first part of the heating to prevent such a strong draught as might drive off unburned particles. Later, however, the cover must be removed, and placed

as shown by a' , so as to promote access of air.

The steel tongs b , of proper form for handling the crucible, are shown at the side of the gas-burner support. The trivet c , of plati-

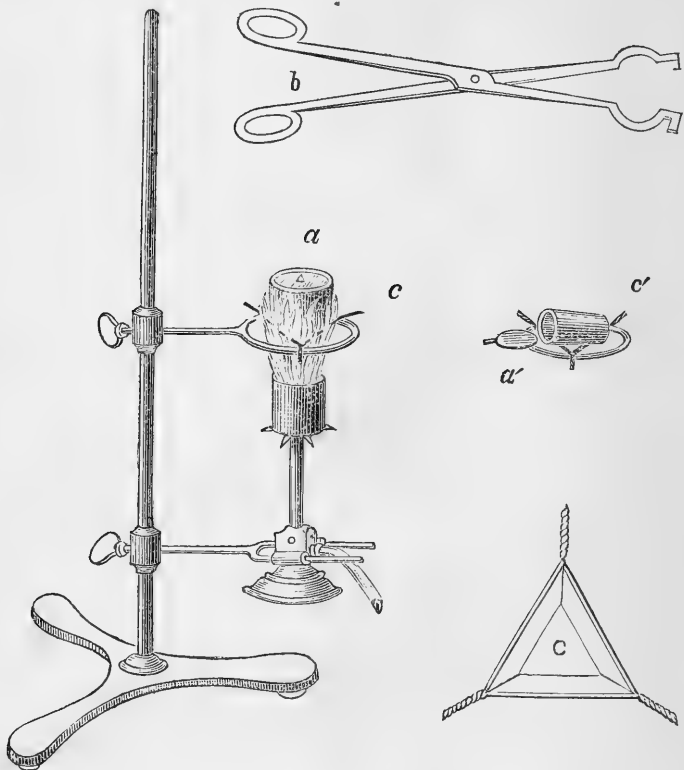
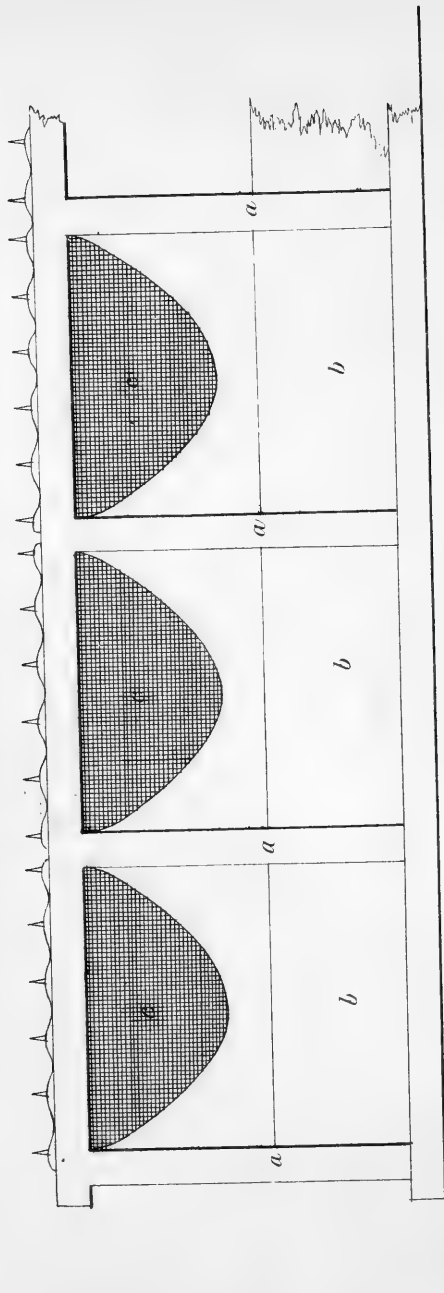

Fig. 14.

num wire, which is laid upon the ring g of the support as a rest for the crucible a , is shown by $c c'$.

FILTER STANDS



SCALE OF FEET





If, in the progress of the analysis, the presence of salts containing constitutional water should be developed,—for example, sulphate of lime,—then the figures for this constituent are to be deducted from the volatile portion expelled by ignition. The residue doubled expresses the per cent. of total organic matter in the raw material.

The precise figures for constitutional water will be obtained, as directed, a little further on, and in proper places. But, supposing, for example, that 5·8 are found to be, subsequently, the per cent. of sulphate of lime, then, as the constitutional water is 0·2647 for *every* per cent., this proportion is to be deducted from the weight of organic matter and constitutional water. The residue expresses the amount of organic matter in the raw or original material.

This constitutional water is not, however, to be formulated as a separate item, for it must be apportioned to the constituents to which it belongs, chemically. The manner of calculating it to its proper affinities will be explained hereafter.

3. *Sand and Silica; Soluble and Insoluble Organic Matters:*

Another portion of 50 grains of the powdered raw or original material is to be placed in a clean beaker glass *a*, fig. 15, drenched

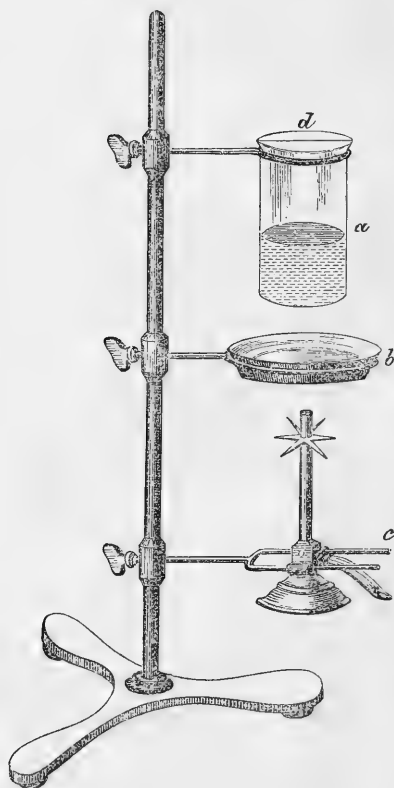

Fig. 15.

with pure hydrochloric acid, covered with a glass dish or a deep watch-glass *d*, and

digested over a gas flame *c*, until all the soluble matter has been taken up.

It should be here noticed whether there is any effervescence on the addition of the hydrochloric acid or any corrosion of the under surface of the glass cover of the beaker, for the first would denote the presence of carbonate of lime, and the latter that of fluoride of calcium. To modify the action of the flame, and to diminish the danger of fracture of the beaker glass, a fine wire gauze of brass or copper should be interposed between the former and the latter; or, better still, a sand-bath *b* may be substituted for the direct flame. In either case, when the solution is complete, the cover is to be removed and the beaker glass further heated on the sand-bath for the evaporation of its contents to dryness. This expels all excess of acid, and renders the silica insoluble. At this stage, it is to be left to cool; after which, the contents are to be moistened with pure hydrochloric acid and a little water, and again heated on the sand-bath for 15 or 30 minutes.

Water being now added for dilution, the liquor is then filtered upon a weighed or

counterpoised filter. The filtering operation is shown by figs. 16 and 17: *a* being the

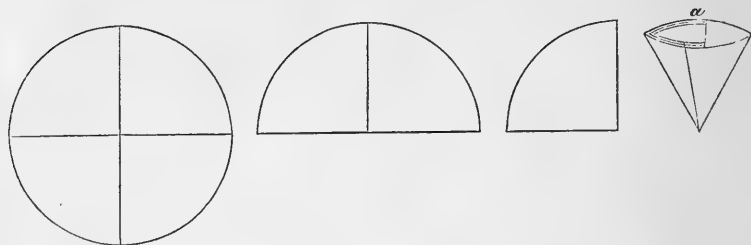

Fig. 16.

paper filter, properly folded; *b*, the glass funnel for holding it; *c*, the wooden support of

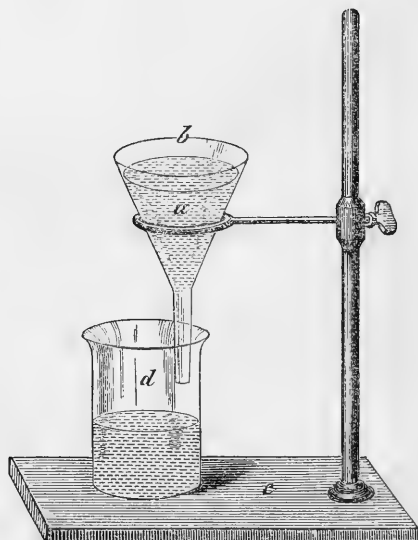

Fig. 17.

the funnel; and *d*, the beaker glass, to receive

the filtrate or clear liquor passing through the filter. White paper, of a porous but strong texture, is made both in France and Germany, for filtering purposes; and filters of different sizes may be bought ready cut at any dealers in chemicals and chemical apparatus. The weight of the ash of these filters is generally noted on the package.

A counterpoised filter is one which has been weighed, with great precision, against a duplicate; and its use becomes necessary for weighing those precipitates which must be dried instead of being ignited. Consequently, the duplicate is to be marked always, and dried with its original fellow, previous to being put into the opposite scale pan at the time of weighing.

When the contents of the beaker have been poured upon the filter, there are still some solid particles adhering to the sides and bottom of the glass. These must be loosened by a feather, and washed out by means of a spritz bottle half filled with water. This spritz bottle, A, fig. 19, is an ordinary six or eight ounce vial, fitted with a cork bored in the centre for the passage of a glass-tube,

which must be drawn out fine at one end. By blowing through this tube, the internal air is compressed, and the bottle being dexterously inverted, its water comes out with the force of a strong jet, which may be directed upon any desired point. After the entire contents of the beaker have thus been

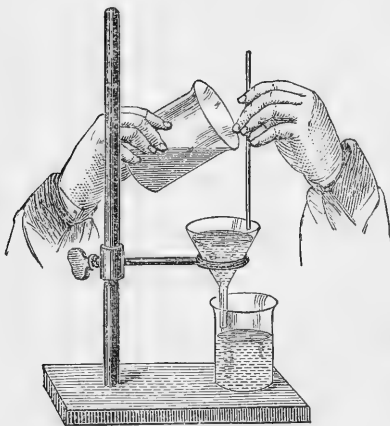

Fig. 18.



Fig. 19.

poured and spritzed upon the filter, the latter is allowed to drain. Hot water is then added three or four times, in order to wash out any traces of the solution. Each relay of water must be allowed to pass through the filter before its successor is poured on.

The filtrate is B, and the filter is C. The filter C is to be placed first between the folds

of bibulous paper, and then on a dish over a hot sand-bath, and there left to dry until it ceases to lose weight. The constant weight doubled, represents the per cent. of insoluble organic matter, sand, and silica, of the original raw material. This having been recorded in the legend, the filter and its contents are then burned to a calx in a platinum crucible. The organic matter is thus destroyed, and the calx being weighed, its weight doubled, less that of the crucible and ash, of the filter, deducted from the previous weight of the dried filter, expresses the *per cent. of insoluble organic matter*. The calx, multiplied by two, represents the *per cent. of sand and silica*.

The amount of insoluble organic matter deducted from the total organic matter previously estimated, gives the per cent. of *soluble organic matter*.

4 and 5. *Sulphate of Lime, and Lime.*

The filtrate B having been on the hot sand-bath during all the interval, is by this time reduced very much in volume by evaporation, and thus prepared to receive a dose

of alcohol about equal to double its own volume, which must now be added. This will render insoluble and precipitate all the sulphate of lime which the liquor may contain. After eight to twelve hours of repose, it is to be filtered off and washed, by passing several relays of diluted alcohol through the filter. The filtrate is D, and the filter is E. The latter must be set to dry over a sand-bath.

The filtrate D is next to be treated with pure sulphuric acid, added dropwise, until it reddens a piece of blue litmus paper dipped into it. This precipitates all the residual lime, as sulphate of lime. After eight to twelve hours of repose, it is to be filtered off, washed with diluted alcohol, and the filter (say F) dried between the folds of bibulous paper, over a hot sand-bath, as before explained. The contents are then to be carefully transferred from the paper to a platinum crucible, and the filter paper rolled up and laid loosely at the top. Heat from a gas flame is then applied, so as to produce a low redness, and when the paper is reduced to ash and the sulphate of lime has been well heated, the

crucible and contents are to be weighed. This weight, less that of the crucible and ash of the filter, when doubled, expresses the total of lime, except that existing as sulphate in the original or raw material. This lime is to be apportioned among the phosphoric, carbonic, and organic acids, as will be explained in the proper places. The filtrate, say G, is, in the meantime, set upon the hot sand-bath to lose its alcohol by evaporation.

While this operation is going on, the filter E, now dry, is to be ignited and weighed after the manner just noted. The nett weight doubled, expresses the per cent. of *dry* sulphate of lime (CaO, SO_3) in the original material. But as sulphate of lime is naturally hydrated always, it must be recorded with its proper equivalent of constitutional water affixed, which is 0.2647 for every per cent., and makes the formula $\text{CaO}, \text{SO}_3, 2\text{HO}$.

All the alcohol having been evaporated from the filtrate, aqua ammoniæ is now added to the residual solution until the odour of the reagent is strongly perceptible. After six hours of repose, it is to be filtered

and washed with water containing aqua ammoniæ. The long repose is necessary, in order that the phosphate of magnesia may separate completely by crystallization.

The filtrate is H, and the filter is J.

6. *Phosphoric Acid.*

The filtrate H contains only the phosphoric acid belonging to lime, and is to be treated at 90° Fahrenheit, first with a solution of chloride of ammonium, rendered strongly ammoniacal and carefully stirred. Solution of chloride of magnesium is now to be poured in cautiously until a precipitate or even cloudiness ceases to form. The whole is then left for four or five hours to repose in the cold; after which it is filtered, and the filter washed with water, rendered ammoniacal; then dried, finally ignited, and weighed. The precipitate formed is the phosphate of magnesia and ammonia (NH_3 , HO, 2MgO , PO_5 , 12HO); but, by ignition, it loses its ammonia, and becomes pyro-phosphate of magnesia (2MgO , PO_5). Every per cent. of this latter contains 0.639 per cent. of phosphoric acid. This phosphoric acid belongs,

as before stated, to lime, and must be written in the record as tri- or bone-phosphate of lime. To make this salt, every per cent. of phosphoric acid requires 1.166 per cent. of lime = $3\text{CaO}, \text{PO}_5$. This proportion of lime is to be deducted from the total lime already estimated.

Fresenius and many other chemists prescribe an allowance of one and three-quarter milligrammes, for every hundred cubic centimetres of the combined filtrate and washings from the ammonia-magnesian-phosphate, to compensate for an equivalent portion retained obstinately in solution. But Parnell, with whose experience my own agrees, observes that such a correction is rendered unnecessary by the presence of an excess of the strongly ammoniacal solution of magnesium salt.

7. *Phosphate of Iron.*

The contents of the filter J* are to be transferred by means of a platinum spatula

* When the alumina or iron is in large proportion it carries down, unavoidably, some of the phosphoric acid

and the spritz bottle to a small beaker, treated with pure hydrochloric acid, and digested on a hot sand-bath, until wholly dissolved. Aqueous solution of pure caustic potassa is then to be added in just sufficient excess to re-dissolve the alumina and phosphate of alumina, which it precipitates at first. Oxide of iron and phosphate of iron with phosphate of magnesia remain undissolved, and are to be filtered off, thoroughly washed with hot water to remove every trace of potassa; then dried, ignited, and weighed as filter κ . The filtrate is L.

The weight of the calcined filter κ expresses the quantity of oxide of iron, phosphate of iron, and phosphate of magnesia combined, which the raw material contains. To estimate them separately the calx is to be put into a beaker, and dissolved by the heat of a sand-bath in just sufficient hydrochloric

belonging to lime. To prevent this source of error, I am now engaged in experiments by which the manufacturing processes, described at pp. 223 and 241, will be rendered precise analytical methods for separating phosphate of lime from its association with iron and aluminium compounds.

acid for the purpose. Aqua ammonia is next added, until the liquor blues red litmus paper, and then acetic acid in excess. Oxide of iron and phosphate of magnesia are held in solution, while phosphate of iron precipitates. This latter is to be filtered off, washed with hot water, dried and ignited, and weighed. The weight doubled, expresses the per cent. of ferric phosphate in the raw material.

The composition of this ferric phosphate varies with the temperature of the liquor, its state of dilution, and the strength and proportion of the aqua ammoniæ employed as precipitant. If the quantity is large, its content of phosphoric acid must be determined by separation after the manner hereinafter described.

8. *Oxide of Iron.*

The filtrate from the phosphate of iron—containing the phosphate of magnesia and oxide of iron—is now to be diluted largely with boiling distilled water, treated with aqua ammoniæ, *just* to perfect neutralization, and filtered rapidly. The oxide of iron on

the filter is to be washed with hot water, dried, ignited, and weighed. The weight doubled, expresses the per cent. of that element contained in the original raw material. It is indispensable to have the liquor dilute, hot and free from any excess of free ammonia, so as to prevent the oxide of iron carrying with it some of the phosphate of magnesia.

9. *Phosphate of Magnesia.*

The filtrate from the oxide of iron, just mentioned, is to be evaporated to a small volume upon the sand-bath, allowed to cool, then treated with aqua ammoniæ *in excess*, and set aside for ten to twelve hours. At the end of this time, the phosphate of magnesia will have crystallized out, and is to be filtered off, washed with ammoniated water, dried, ignited, and weighed. The process of ignition drives off the ammonia, and changes it into pyro-phosphate of magnesia (2MgO , PO_5), every per cent. of which contains 0.639 of phosphoric acid.

10 and 11. *Phosphate of Alumina, and Alumina.*

The filtrate L, which was set aside previously, is now to receive attention. It contains alumina and phosphate of alumina dissolved in caustic potassa. This latter is to be fully neutralized by the addition of hydrochloric acid, which first precipitates and then re-dissolves the aluminium compounds. To throw them down wholly, it is next necessary to add carbonate of ammonia in excess. They are then filtered off, thoroughly washed with hot water, dried, ignited, and weighed. The weight expresses the *joint amount* of alumina and phosphate of alumina in the raw material, and is to be noted in the record.

The next step is to transfer the contents of the platinum crucible to a beaker glass; add hydrochloric acid; heat the solution on a sand-bath; and dilute largely with water. This done, a large quantity of solution of citric acid is to be poured in; and, finally, aqua ammonia, with a slight excess of solution of sulphate of magnesia containing chlo-

ride of ammonium. The vessel is then covered, and left to repose in a cool place for twenty-four hours; after which, its contents are to be filtered and washed with dilute ammonia water.

The filter contains the phosphoric acid as phosphate of ammonia and magnesia, but mixed with greater or smaller traces of alumina and basic citrate of magnesia. To remove these, the contents of the filter must be dissolved in hydrochloric acid, treated anew with a very small quantity of solution of citric acid, and re-precipitated by ammonia. After being washed with ammoniacal water, dried, and ignited, it is to be weighed as pyro-phosphate of magnesia (2MgO , PO_5), every per cent. of which contains 0.639 of phosphoric acid. As this portion of phosphoric acid belongs, naturally, to alumina, it must be calculated to the latter, and written down in the table of results as phosphate of alumina. Every 1.0 of phosphoric acid requires 0.722 of alumina.

The proportions of phosphoric acid and alumina thus determined being subtracted from the joint amount previously noted, give

the proportion of alumina in the mineral other than that which is combined with phosphoric acid.

As only fifty grains of raw material are taken for analysis, the figures of result must be doubled, in order to make them express the per cent.

12. *Alkaline Salts.*

The calx A from the organic matter and constitutional water determined in an earlier stage (page 439) of the process and then placed in reserve, is now to be treated for the separation of alkaline salts and fluoride of calcium.

For this purpose it is boiled with an ounce of distilled water, allowed to cool, and then filtered and washed. The filter is M, and the filtrate is N.

The filtrate N contains the alkaline salts (with some little sulphate of lime, probably), and is to be evaporated to dryness in a platinum capsule on a hot sand bath. Its constant weight less that of the capsule is then taken and noted in the tabular result as

alkaline salts. It must be doubled to express the per cent.

In rock guanos and mineral phosphates the alkaline salts consist, generally, of chloride of sodium with sulphate of soda; and their proportion is very small. But to determine whether any potassa is present, as well as to separate it in such case, the directions hereinafter given on that point, for analysis of superphosphates, must be followed.

To determine whether any appreciable quantity of sulphate of lime remains with the alkaline salts, it is only necessary to add very dilute alcohol to the latter, after weighing them, which will leave the former undissolved. It can then be separated by filtration, dried, ignited, and weighed. Its weight is to be deducted from the previous weight.

13. *Fluoride of Calcium.*

If the presence of fluoride in the raw material was made evident by the corrosion of the glass cover to the beaker, in the earlier treatment for the separation of sand and silica, its quantity is now to be determined by fusing the contents of filter M in a plati-

num crucible with a mixture of six parts of carbonates of potassa and soda and two parts of silicic acid. This operation converts all the fluorine and phosphoric acid into soluble alkaline salts. The mass, when cold, is to be treated with water, which renders liquid the soluble salts. The liquid is to be filtered off, and treated with solution of carbonate of ammonia which precipitates the silica. This latter is to be filtered off, and washed with a dilute solution of carbonate of ammonia. The liquor is now to be treated with hydrochloric acid until it reddens blue litmus paper, and afterwards with a slight excess of solution of chloride of calcium. Fluoride of calcium, together with phosphate of lime, drop from the solution, and this precipitate is to be filtered off, washed with hot water, dried, ignited, and weighed. The calx is now to be placed in a platinum capsule, and heated with sulphuric acid until all the fluorine is expelled as hydrofluoric acid. Care must be observed not to let the heat be sufficiently high to volatilize any of the sulphuric acid. The residue is then digested with hydrochloric acid to dissolve the phos-

phate of lime, and afterwards with its own volume of alcohol to precipitate the lime as sulphate. After five or six hours' repose this latter is to be filtered off, washed with alcohol, dried and weighed. Every 1·0 of dry sulphate of lime contains 0·4117 of lime or oxide of calcium.

The filtrate from the sulphate of lime is to be evaporated on a sand bath, for the volatilization of the alcohol, then treated with a mixture of sulphate of magnesia and chloride of ammonium, and finally with an excess of aqua ammoniæ. After six or eight hours' repose the phosphoric acid will have separated, wholly, as phosphate of magnesia and ammonia. This latter is to be filtered off, washed with hot water, dried, ignited, and weighed as pyrophosphate of magnesia. Every 1·0 of this latter salt of magnesia contains 0·639 of phosphoric acid.

The total of lime and phosphoric acid having now been determined, so much of the former must be apportioned, by calculation, to the latter as is necessary to make tri-phosphate of lime, or, in other words, 1·166 of lime to every 1·0 of phosphoric acid. The

3

6

4

Vincent Br

Trübner & Co. 60, Paternoster Row.

BATTERY OF STONE VATS AND ACCESSORIES

FRONT ELEVATION

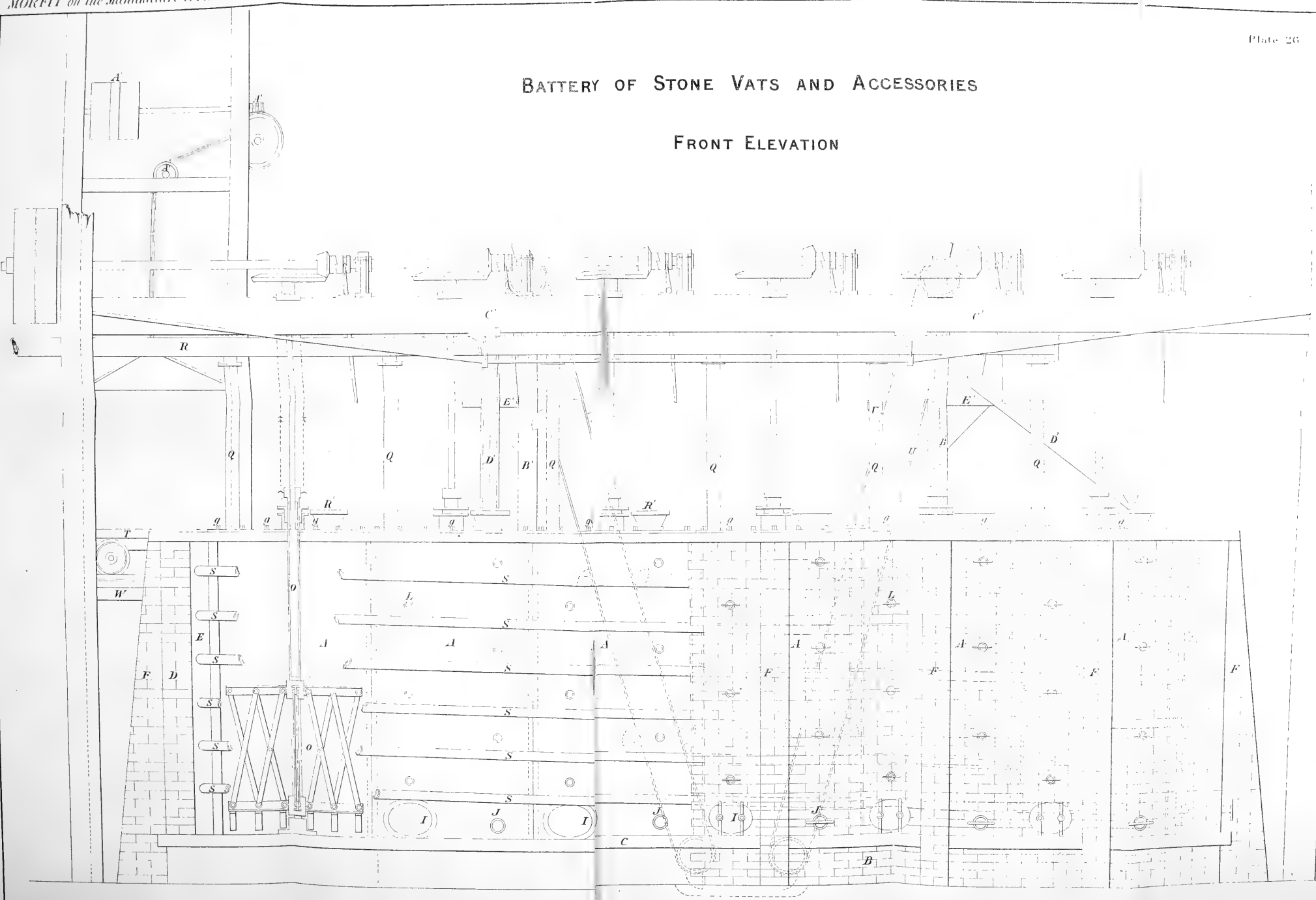

SCALE



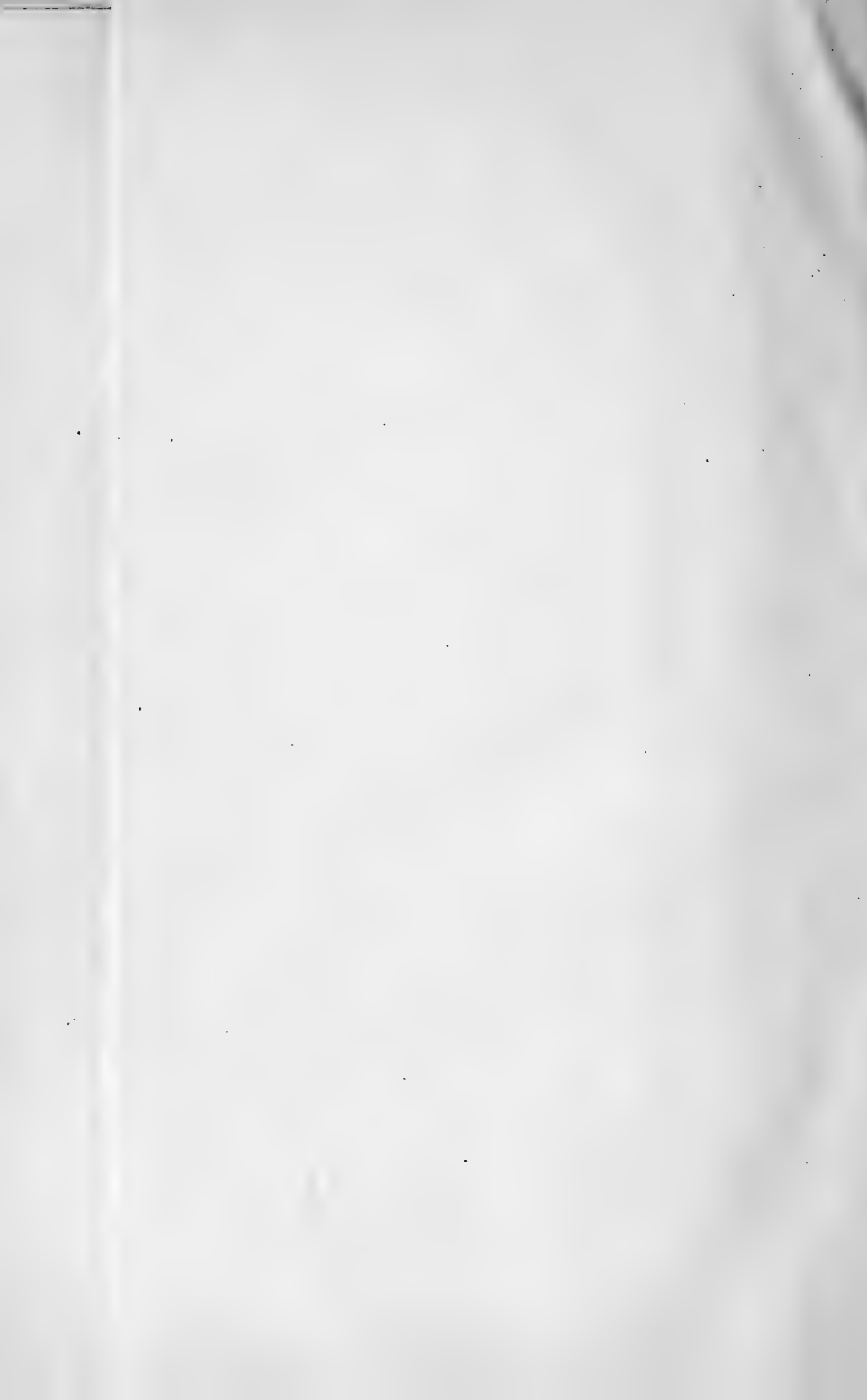

residue of lime belongs to the fluorine which is expelled, and every 1.0 of CaO makes or is equivalent to 1.40 fluoride of calcium (CaFl). The figures obtained must be doubled to express the per centage.

14. *Carbonate of Lime.*

If on the addition of acid to the raw material, there is any effervescence, this action denotes the presence of carbonate of lime. To determine the amount, a separate or new portion of fifty grains of the raw material in fine powder must be taken, and treated in a special apparatus shown by fig. 20, which is drawn one-third smaller than the natural size.

It consists of a very light glass flask *a*, as the vessel for receiving the powder; a glass pipette *b*, and a drying tube *c*, containing chloride of calcium, both of which latter connect with the former by means of a tightly adjusted cork *h*. The pipette is to be filled with either sulphuric acid or a very strong solution of tartaric acid, by dipping the lower end into the liquor and drawing the latter up into the bulb by placing the

mouth at the upper end. This portion is then fitted with a piece of india-rubber tube and one of Mohr's clamps *d*, shown enlarged by fig. *f*. The clamp and india-rubber tube serve to exclude or admit air into the flask

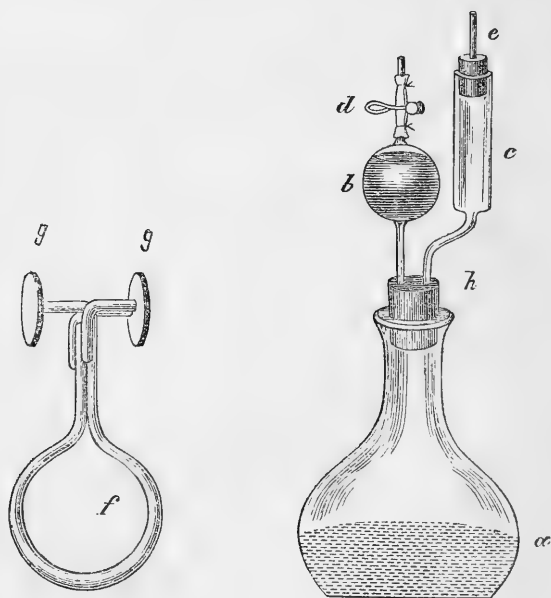

Fig. 20.

as may be required; it being only necessary to press upon the keys *g g* with the fingers when it is desired to open the tube, and to remove them when it is to be closed. When the weighed portion of powder has been put into the flask, the latter is to be closed tightly

with the cork stopper, and the whole apparatus and contents carefully weighed on the fine balance. This weight having been noted in the record, the acid is then made to flow from the pipette in drops, by pressing the keys of the clamp at short intervals.

Carbonic acid having a much feebler chemical affinity than either sulphuric or tartaric acids, is displaced by either of these latter from its combinations, and driven off in the form of gas, as indicated by the effervescence which takes place; and if in its escape it should be involved with any mechanically mixed water, this will be arrested by the chloride of calcium as it passes through the drying tube,—that salt being a hygroscopic substance. Nothing but carbonic acid escapes; and after all the acid has been allowed to fall upon the powder, and effervescence has ceased for some ten or twenty minutes, the lips are to be applied to an india-rubber tube temporarily drawn over the end of the exit tube *e*, and the residual traces of gas drawn out of the apparatus by suction. This india-rubber tube being then removed, the apparatus is to be weighed

again. The difference between this second and previous weight shows a loss which expresses the amount of carbonic acid in the raw material. The carbonic acid is to be calculated to lime (CaO) and in the proportion of 1.27 lime to every 1.0 of carbonic acid. The equivalents of lime belonging severally to the fluorine and the carbonic and phosphoric acids being now added together and deducted from the total of lime previously estimated, may leave a remainder. In that case the remainder is to be set down in the table as *Lime with organic and silicic acids, and probably also with alumina.*

The results are to be arranged in the order shown by the following table.

Recapitulation.

Moisture	-	-	-	-	say 2 00
Organic matters	-	-	-	-	„ 2 50
Sand and silica	-	-	-	-	„ 3 00
Fluoride of calcium	-	-	-	-	„ 4 00
Sulphate of lime	-	-	-	-	„ 5 00
Carbonate of lime	-	-	-	-	„ 7 00
Lime (with organic and silicic acids)	-	-	-	-	„ 2 00
Bone-phosphate of lime	-	-	-	-	„ 58 00
Bone-phosphate of magnesia	-	-	-	-	„ 3 50
Phosphate of alumina	-	-	-	-	„ 5 00

Phosphate of iron	-	-	-	say 3'00
Oxide of aluminium	-	-	-	„ 2'00
Oxide of iron	-	-	-	„ 1'00
Alkaline salts	-	-	-	„ 2'00
Total	-	-	-	<u>100'00</u>

The phosphoric acid is thus shown in its individual combinations and not totalized as tri-phosphate of lime, according to the meretricious style of "*commercial*" chemistry.

FORMULA FOR THE CHEMICAL ANALYSIS OF
MINERAL PHOSPHATES OF ALUMINA AND
IRON.

In the preceding formula, instructions have been given for the separation of the aluminium and iron compounds from those of lime, because there are very few mineral phosphates of lime which do not contain more or less of those compounds.

On the other hand, there are certain mineral phosphates of alumina and iron wholly free from lime associates. To analyze these, therefore, is a simple process, it being necessary to follow only those parts of the formula already explained, which apply

to their special components. Taking "*Redonda Guano*" as a typical specimen, these components are, in their proper order of arrangement, generally as follows:—

Water	-	-	-	-
Organic matter	-	-	-	-
Sand and silica	-	-	-	-
Sulphate of lime	-	-	-	-
Phosphate of alumina	-	-	-	-
Phosphate of iron	-	-	-	-
Oxide of aluminium	-	-	-	-
Oxide of iron	-	-	-	-
Total	-	-	-	—

a. Water.

An average sample of about four ounces having been selected, is to be reduced, wholly, to fine powder in a polished iron or steel mortar. Fifty grains are then to be heated in a platinum crucible on a very hot sand bath, until the weight becomes constant. The loss of weight thus produced expresses, when doubled, the per cent. of water in the mineral.

b. Organic Matter.

The residue is further heated, but over a

gas flame, to redness until it ceases to lose weight. The difference between its constant weight after the heating, and its previous weight, expresses, when doubled, the per cent. of organic matter in the mineral.

c. Sand and Silica.

The calx is then to be emptied from the crucible into a small beaker glass, drenched with hydrochloric acid, and heated on a sand bath. After an hour, sulphuric acid is to be added very cautiously, for otherwise too violent action may ensue, and cause the ejection of some of the contents of the glass. Enough acid must be added to thin the mass to fluidity. After which, digestion is to be continued until all the soluble matter is taken up, as will be indicated by the liquor having assumed a thick syrupy consistence without solid residue at the bottom. It is then evaporated to dryness on the sand bath, treated with a few drops of hydrochloric acid and sulphuric acid, and again digested for ten minutes. Hot water being then added to make a thin dilution, the whole is to be stirred and filtered. The

washed, dried, ignited, and weighed filter represents the sand and silica.

d. Sulphate of Lime.

The filtrate may contain, in rare instances, some small portion of sulphate of lime; therefore its volume must be reduced two-thirds by evaporation on a sand bath; after which a double volume of alcohol is to be added. If it contains sulphate of lime, this salt will precipitate, and must be filtered off, washed, dried, ignited, and weighed.

e. Alumina and Phosphate of Alumina.

The filtrate contains alumina and oxide of iron together with their phosphates, and must be evaporated to expel alcohol. Solution of caustic potassa is then added in excess, so as to hold in solution the aluminium compounds while it precipitates those of iron. These latter are to be filtered off, washed with hot water, dried, ignited, weighed and set aside as A.

The filtrate is now to be treated for the separation and estimation of its alumina,

and phosphate of alumina, precisely in the manner described, for filter K, in paragraphs 10 and 11 of the preceding formula.

f. Oxide of Iron and Phosphate of Iron.

The calx A contains only these two components, and it is to be digested in a beaker glass with sufficient hydrochloric acid to effect its solution. The further treatment is then precisely similar to that described in paragraphs 7 and 8 of the preceding formula.

FORMULA FOR THE CHEMICAL ANALYSIS OF
COMMERCIAL SUPERPHOSPHATE OF LIME;
AND COMPOUND FERTILIZERS.

The commercial superphosphates of lime vary in their composition, according to the skill and integrity which may have been practised in the manufacture of them. Chemical analysis is the only mode of determining their value previous to use, and should be made as follows.

A. *Water.*

Average the sample fairly, weigh out a portion of 50 grains in a counterpoised

watch-glass, and dry over a sand-bath at 200° to 212° Fahrenheit until weight ceases to be lost. The loss which the constant weight indicates, will, when doubled, express the per cent. of accidental water in the sample.

B. *Bi-Phosphate of Lime.*

A fresh portion of 50 grains is to be triturated in a porcelain mortar with distilled water, and poured into a small glass funnel loosely plugged in its stem with cotton-wool. When the liquor has run through into a beaker glass beneath, a fresh relay of cold water is poured on and allowed to infiltrate through as before. In this way the infiltration is further repeated thrice with cold, and subsequently several times with boiling water or until all the soluble matter has been displaced or washed out. This will be shown so soon as the filtrate, running through, no longer leaves a decided tache, when a drop has been evaporated to dryness upon a platinum spatula. The use of cold water insures the extraction of any soluble aluminium phosphate that may be present;

for, according to Warrington, *hot* water would coagulate and keep it back.

The filter is A, and must be kept in reserve as the insoluble portion. The filtrate B contains all the soluble phosphate, together with some little sulphate of lime, and any sulphates of alumina and iron that may have been in the sample.

It is to be reduced, by evaporation on a sand-bath, to a small volume, and treated with alcohol for the precipitation of the sulphate of lime. This latter is then to be filtered off, washed, and added to the reserved filter A, containing the portion of the sample insoluble in water.

Lime-water is now to be added to the filtrate c, a little at a time, until precipitation or cloudiness ceases to be formed. Great care must be observed to restrict the lime as nearly as possible to the exact quantity, and this is nice manipulation. The better way will be to keep back about one-eighth of the liquid, so that this reserve may be at hand for a readjustment of the neutrality, in case of too much lime-water having been added to the first portion. *Very thin*

milk of lime, strained through a bolting or other fine cloth, may be used instead of lime-water, and with the advantage of producing less volume of liquid; but, in this case, the manipulation must be more expert, so as to prevent the addition of any excess of lime.

This treatment throws down all the phosphoric acid as phosphate of lime, with any alumina and oxide of iron, which may have been present in the solution. The precipitate is to be filtered off, washed, and noted as D. The filtrate is E.

The filter D is to be transferred to a beaker glass, and dissolved in just sufficient hydrochloric acid, by the heat of the sand-bath. A small quantity of water is added, and afterwards a double volume of alcohol. Finally, sulphuric acid is to be added, a drop at a time, until all the lime has precipitated as sulphate. The sulphate of lime, thus formed, is then filtered off, washed, and thrown away. The filtrate contains all the phosphoric acid with the alumina and iron. It is to be evaporated on a sand-bath for the expulsion of alcohol, and then treated with ammonia to throw down the alumina and

iron. Filter, wash well with hot water, and set aside as filter F, containing iron and alumina.

The filtrate now holds only phosphoric acid, and is to be treated precisely as directed in paragraph 6 of the first formula. Every 1.0 of phosphoric acid (PO_5) is equivalent to, or makes, 1.64 of biphosphate of lime (CaO , 2HO , PO_5).

If it is only desired to estimate the amount of soluble bi-phosphate which the sample may contain, the analysis here ends. But as this component is often associated in artificial mixtures, with precipitated phosphate, bone-phosphate, ammoniacal and alkaline salts, it is proper that the formula should comprise instructions for a thorough analysis, in the progress of which, any and every probable component may be detected and estimated.

c. Alumina and Iron.

Therefore, the filter F is to be ignited and weighed. The weight having been recorded, the calx is then dissolved in hydrochloric acid by the aid of the sand-bath, and treated

with citric acid, as directed in paragraphs 7 to 11, for the separation of any phosphoric acid which it may contain. The weight of the phosphoric acid deducted from the previous total weight of the calx leaves the weight of the aluminium and iron oxides. Both weights must be doubled to express the per cent. relations, and are to be recorded in the table among the soluble constituents of the sample.

D. *Chloride of Ammonium.*

The filtrate E having been poured into a platinum capsule of known weight, is to be evaporated to dryness upon or over a sand-bath at a temperature not exceeding 212° Fahrenheit. When it ceases to lose weight, its constant weight is to be noted. The crucible and contents are then to be heated over a gas flame, much below redness, until vapours cease to be given off. Chloride of ammonium, if any is present, thus volatilizes; and the capsule being now weighed will show a loss on its previous weight. This loss, doubled, expresses the per cent. of chloride of ammonium in the sample.

EE. The residue is now dissolved in water, diluted to a given number of cubic centimetres, and then divided into two equal portions, G and H. It should be remarked here, that the solution may contain both chlorides and sulphates of the alkalies, together with sulphate of ammonia.

F. *Sulphate of Ammonia.*

The portion G must be treated with chloride of barium in a careful manner, so as to avoid an excess. The precipitate is then to be filtered off, washed with hot water, dried, ignited, and weighed. Every 1.0 of this calcined filter of sulphate of baryta (BaO , SO_3) contains 0.34335 of sulphuric acid, and this acid is to be apportioned, as will be explained hereafter.

The sulphates having been converted thus into chlorides, are to be evaporated to dryness, as before, and the constant weight noted. Afterwards, the mass is to be heated, as in the previous instance, to expel any chloride of ammonium that may have been formed from sulphate. It must be weighed, therefore, again, to determine the amount of

loss, if any. Every 1·0 of this loss, being chloride of ammonium, represents 1·257 of sulphate of ammonia.

G. *Potassium Chloride.*

The residue is then dissolved in water, and a little carbonate of soda added to precipitate any excess of baryta salt that may have been added. The liquor is then filtered and washed. The filter is thrown away; but the filtrate is to be reduced, by evaporation, to a small volume, treated with a strong solution of neutral chloride of platinum in slight excess, and evaporated in a porcelain capsule nearly to dryness over a water-bath. A mixture of alcohol, of 80 per cent. strength, and ether, is then added, and the whole left to digest for some fifteen to thirty minutes. The double salt of chloride of platinum and potassium is thus rendered wholly insoluble, and must be filtered off upon a counterpoised filter, dried, and weighed. Every 1·0 of this salt (KCl, Pt, Cl_2) contains 0·30507 of chloride of potassium, and every 1·0 of this latter salt is equivalent to 1·166 of sulphate of potassa, or 0·523 of potassium deducted from

the previous weight (paragraph F) gives the amount of chloride of sodium in the filtrate.

To determine whether any of the potassium or sodium may have existed originally as chloride, it is first necessary to test the H portion of the liquor previously noted, with nitrate of silver. If any precipitate falls, it must be filtered off upon a counterpoised paper, washed with hot water, dried, and weighed. Every 1.0 of the chloride of silver thus precipitated contains .2472 of chlorine, and every 1.0 of chlorine is equivalent to 2.10 of chloride of potassium. The chlorine is allotted to potassium, first, because this latter is a stronger base than sodium, though it is possible a part of it may belong really to the latter, if it were known how to determine that point and portion under existing circumstances.

H. *Sulphate of Potassa.*

If there should be more of potassium than the chlorine requires, this residue was originally in the form of sulphate. Therefore, as much of sulphuric acid as it may require to convert it into KO, SO₃, must be deducted

from the total baryta product of the portion of liquor G. Every 1.0 of potassium needs 1.23 of oxygen and sulphuric acid jointly, to convert it into sulphate of potassa.

J. *Chloride of Sodium.*

If the amount of chlorine obtained should be more than sufficient for all the potassium, then the excess is to be calculated to sodium as chloride of sodium. Every 1.0 of chlorine (Cl) is equivalent to 0.6486 of sodium (Na), or 1.648 of chloride of sodium (NaCl). This proportion of chloride of sodium is to be deducted from the total amount of soda salts, previously determined.

K. *Sulphate of Soda.*

The remainder of the sulphuric acid should exactly or closely fit the residual amount of chloride of sodium, already determined, as sulphate of soda is most probably the form in which it originally existed in the sample. Every 1.0 of chloride of sodium is equivalent to 0.684 of sulphuric acid, and every 1.0 of this latter makes 1.782 of sulphate of soda.

As only 50 grains of the sample were

taken for the analysis, and this portion was divided into moieties, for the estimation of the chloride of potassium and sulphates of potassa, soda, and ammonia, the figure results for these latter must be multiplied by four, in order to express the per cent. relations.

L. *Nitrate of Soda.*

Though this salt is not comprised in any of my products, it may be a component of other fertilizers, as it is now largely used in their manufacture; and, therefore, a proper formula for chemical analysis should comprise instructions for detecting and estimating it.

Its presence may be determined by leaching a sample of the fertilizer with water, filtering, and evaporating a few drops of the filtrate to dryness in a platinum crucible. If now, on adding to the dry mass a few drops of sulphuric acid and heating, there should be an appearance or smell of orange-red nitrous fumes, they are proof of the presence of a nitrate, which is most generally nitrate of soda.

In that case, then, a fresh portion of 50 grains of the original sample is to be di-

gested in a beaker glass and on a hot sand-bath with distilled water. All the soluble matter of the sample will be thus taken up; and the whole is to be filtered and washed. The filter, being foreign to this determination, is to be thrown away. The filtrate is to be treated with thin and smooth milk of lime until this latter ceases to throw down a precipitate. Filter and wash. The filter containing alumina, oxide of iron, and phosphate of lime, is to be thrown away; as all of these matters have been estimated according to the instructions in previous paragraphs.

There remains nothing in the filtrate but alkaline salts and nitrate of soda, with some sulphate of lime. It is to be evaporated to dryness and constant weight, in a platinum crucible the weight of which has been previously noted, and there is then to be added to the saline mass some pure powdered silica. The silica must be previously heated, to insure perfect dryness, and its proportion must be four to six times the supposed weight of the nitrate of soda. The mixture of the two having been made

ELEVATION.

ELEVATOR AND DIGESTION VATS - END ELEVATION.

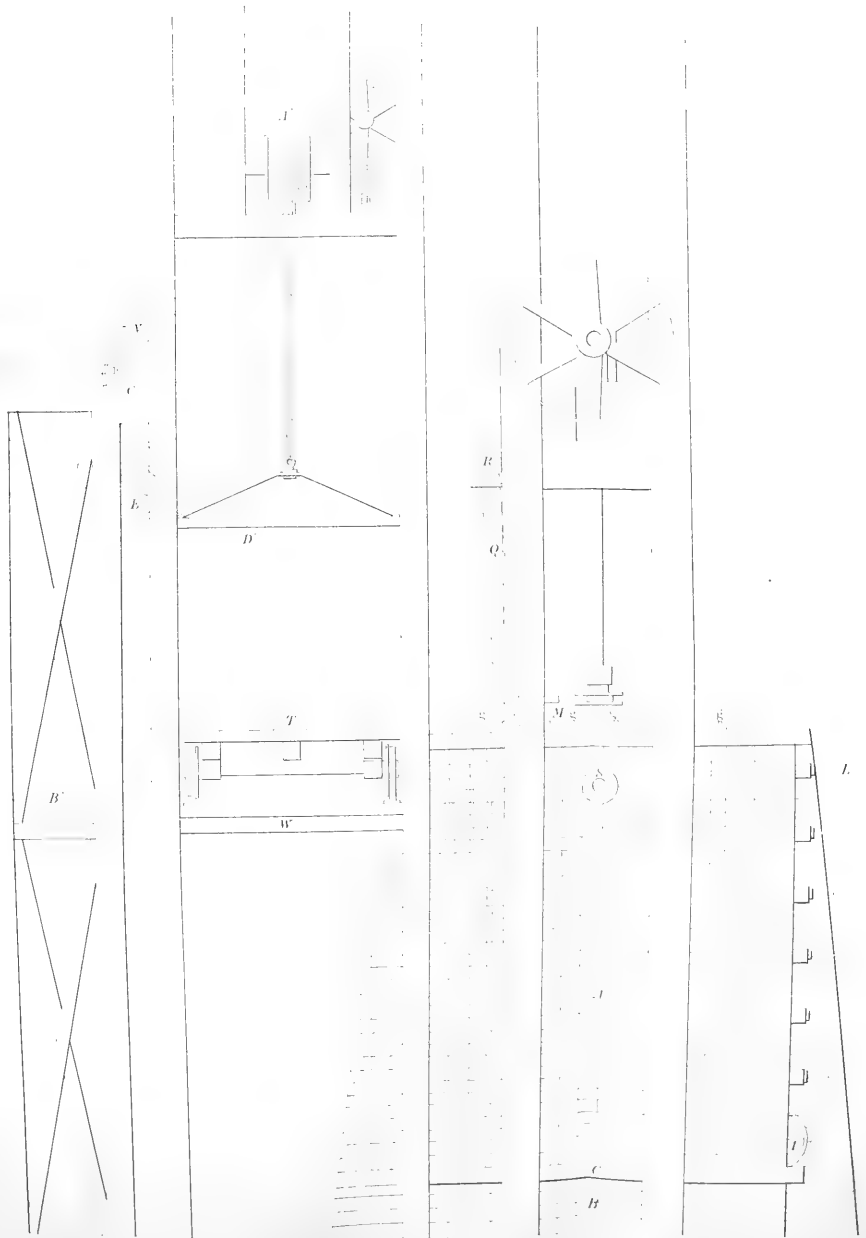



intimate by stirring with a glass rod, the whole is then carefully weighed and its exact weight recorded. The crucible being then covered, is to be heated for one half hour over a gas flame to a redness which is so low as to be only barely visible in the day time. At this temperature the nitric acid of the soda (or potassa) will pass off, while any alkaline chlorides or sulphate that may be present remains undecomposed. The crucible and contents being weighed again, when cool, will show a loss which represents the amount of nitric acid expelled. Every 1.0 of this nitric acid (NO_3) is equivalent to 0.5796 of soda (NaO), and represents 1.5796 of nitrate of soda. The result is to be multiplied, of course, by two, in order to make it express the per cent. relations.

The portion of the fertilizer soluble in water having been thoroughly analyzed, the next operations must be with the insoluble part which was placed in reserve as filter A, at an early stage of the examination. The qualitative and quantitative steps are one and the same in this formula,—that is, they proceed together.

M. Precipitated Phosphate of Lime.

The filter A having been perfectly dried, its contents are weighed and then transferred to a beaker glass. Pure concentrated acetic acid of specific gravity 1.05 is next to be added, and the whole left to digest in the cold for half an hour. By this treatment, carbonate and precipitated phosphate of lime are dissolved, while the bone-phosphate of the natural mineral remains nearly untouched, on account of its dense physical structure. The whole is then filtered and washed; the filter being J and the filtrate K.

The filtrate K is treated with a slight excess of aqua ammoniæ filtered and washed. The filter is then dried, ignited, and weighed. The weight, multiplied by two, expresses the percentage of precipitated phosphate of lime, which may contain, also, some possible trace of free carbonate of lime.

N. Carbonate of Lime.

The filtrate from the preceding filter is to be treated with oxalate of ammonia, until a precipitate or cloudiness ceases to form. The

oxalate of lime is then to be filtered off, washed, dried, ignited, and weighed. As oxalate of lime changes into carbonate by ignition, the weight, doubled, represents the per cent. of carbonate of lime in the sample.

o. Organic Matter.

The filter *j* having been thoroughly dried at 212° Fahrenheit, its contents are then weighed and afterwards calcined in a platinum crucible.

The loss of weight thus produced by ignition represents the amount of organic matter in the sample.

p. Sand and Silica.

The remaining calx is now to be treated with hydrochloric acid, and carried through the operations explained at length in paragraphs 3, 4, 6, 7, 8, 9, 10, 11, and 13 of the first formula of this chapter. In this manner, each and every one of its probable constituents will thus be detected and estimated.

The formula just given is made comprehensive, so that it may apply in the first part to commercial superphosphates of lime, and

in its entirety to any and every fertilizing mixture of artificial manufacture, however complex.

The constituents having been separated and quantitatively determined, should be formulated according to the following arrangement.

Recapitulation.

Soluble bi-phosphate of lime	-	-	-
Precipitated phosphate of lime	-	-	-
Bone- or tri-phosphate of lime	-	-	-
Bone-phosphate of magnesia	-	-	-
Chloride of ammonium	-	-	-
Chloride of potassium	-	-	-
Chloride of sodium	-	-	-
Sulphate of ammonia	-	-	-
Sulphate of potassa	-	-	-
Sulphate of soda	-	-	-
Nitrate of soda	-	-	-
Sulphate of alumina	-	-	-
Sulphate of iron	-	-	-
Phosphate of alumina	-	-	-
Carbonate of lime	-	-	-
Lime, with organic and silicic acids and alumina	-	-	-
Fluoride of calcium	-	-	-
Alumina	-	-	-
Oxide of iron	-	-	-
Sand and silica	-	-	-
Organic matter	-	-	-
Water	-	-	-
Total	-	-	_____

CHAPTER XXIV.



ON THE COMMERCIAL VALUATION OF CRUDE AND REFINED FERTILIZING MATERIALS.

IN computing the value of a fertilizing material there should be a close adjustment of its commercial and agricultural relations.

The prime elements of a profitable fertilizer are nitrogen, phosphate of lime, and potassa. To determine, however, the commercial and agricultural worth of a fertilizing material, it is necessary to ascertain its precise composition and nature by a *full* chemical analysis. The questioning, in this respect, must be both scientific and conscientious; for no mere partial investigation will serve the importance of the subject. Not only must it be learned what constituents are present, but in which forms they exist and with what associates they may be accompanied.

In a general sense, the form or state regulates the agricultural value of a fertilizing element; but the character of its associates affects, more or less, the computation.

Ammonia.

Thus, as to azotized matters, those which contain their nitrogen in the form of ammoniacal salts are the most *active*; while others, on the contrary, like woollen waste, horn, and leather clippings, which contain it in a comparatively *dormant* or *quiescent* state, acquire chemical or fertilizing momentum, so to speak, only by the aid of time and decomposition. These influences add to the first cost and change the classification or money rank of the material. Here, moreover, substances of this kind which are most prone to decomposition, are worth more, proportionally, than others of their class. Intermediate between these two, is a third form existing as urea, urate, and phosphate, in farm-yard manure, bird guanos, human excrements, and kindred substances; which, though not active or dormant, are more *potential* than either. I use this term, potential, to desig-

nate a great sensitiveness to the assimilating powers of the growing crop, whereby the plant is enabled to take up its nutriment in condition and quantity as may be wanted to produce the highest degree of progressive development with the least possible expenditure of time and fertilizer. This form of nitrogen being the most valuable, in every sense, should constitute the standard of estimation ; but, unfortunately, the supply of it is too limited, at present, to justify that position for it. Later, when its source becomes amply extended by the separation of the organic matter from the phosphate-sewage precipitate, as suggested at pp. 397 to 405, it may assume the controlling position in the appreciation of nitrogenous substances.

In the meantime, there remain only the ammonium chloride and sulphate as a solid standard of comparison. The abundant and regular production of crude ammonia liquors in the coal-gas and bone-black works, render those salts, already, the most prominent part of the ammonia supply ; and this source not only assumes a progressive increase, but is becoming widened by lateral feeders from the

utilization of woollen wastes for the purpose. Not long hence, it will expand into yet larger proportions, when the excrements of mankind are turned into this account or current, after the manner which I have noted at p. 47; or the air is exploited for the purpose.

With this explanation, therefore, ammonia must be set down at its average value in ammonia salts, which is £90 per ton or 18s. per unit; the present market price of ammonium chloride being £30 per ton, while that of sulphate of ammonia is £22 per ton. Materials containing nitrogen in a dormant or quiescent state are to be rated at a figure so much less as will cover the manufacturing expense of converting that nitrogen into its equivalent of ammonia salt, with twenty per cent. superadded for profit and contingencies.

The unit refers to the ton of 2240 pounds, and is used in accordance with the prevailing British custom, which requires that the computation shall be made by unit rather than by per cent.

Every per cent. of any constituent of a material, when multiplied by twenty, becomes

a unit. Thus, for example, if a material should contain seventeen per cent. of ammonia or the equivalent in nitrogen, with the cost of conversion added, it is said to have 17 units of ammonia, although the latter represents in fact 380 pounds of ammonia in the ton of the material.

The method of calculating by per cent. is, however, the more rational one, as it gives expression to the actual quantity or proportion of the valuable constituent of a raw material. On the other hand, the unit method excludes from the computation 240 pounds of the ton, as a concession to trade influence.

Phosphates of Lime.

Bone-ash or animal phosphate of lime is the typical expression of this material; and pure apatite and phosphorite may be taken as the best representatives of its mineral condition.

Animal Phosphate of Lime.

Bone-ash has a peculiarly sensitive temperament in its chemical relations, and is

well suited for immediate potential effect upon soils. It is more uniform in composition than any other kindred material, and contains a higher average of actual phosphate of lime. Moreover, in this material there is only an inconsiderable proportion, comparatively, of profligate matters associated with the phosphate of lime constituent.

On these accounts it holds a commercial and agricultural position apart from other kinds of its class. The laws of supply and demand regulate, therefore, its market price, which is at present £6:15 to £7 per ton, or 2s. per unit. This value refers to ash containing 70 per cent. of tri-phosphate of lime, that being the usual strength.

Bone-black and *bone-dust* are to be estimated by the above standard, for similar reasons, but according to the proportion of tri-phosphate of lime which they may contain. At the same time, their content of nitrogenous matter must be taken into consideration. This is potential in character, and its money value is to be computed, as explained already under ammonia, and added to that of the phosphate constituent.

Mineral Phosphate of Lime.

The mineral phosphates of lime, even of the highest grade, have a dense structure and rocky nature, which give them a chemical, as well as physical temperament, quite distinct from that of bones, bone-ash, or bone-black. Moreover, a greater or lesser quantity of the phosphoric acid which they may contain is combined, almost invariably, with iron and alumina; whereas, the animal phosphate of lime holds that acid wholly as tri-phosphate of lime. The presence, too, of foreign associates with the lime phosphate element is an important modifying influence in determining the commercial value of a mineral phosphate.

I restrict my remarks to the commercial value because mineral phosphates in their natural crude state are very slow indeed as direct agricultural agents. The foreign matters which they contain exert a cementing action upon the valuable phosphate of lime constituent, and thus impart to this latter an inertia which militates against its fertilizing activity. Though vegetation will draw its

nourishment from the most available source, however difficult, its vigour of structure and productive capacity will be more or less feeble if the nutriment should be either deficient in quantity or obstinate to the atmospheric and solvent influences of the soil. Plants thrive best when their food is present in assimilable or potential forms; and, consequently, time and money are both wasted in sowing fertilizers which may be tough in nature or sluggish in action.

The phosphate of lime constituent requires, therefore, to be separated from its disadvantageous association of foreign matters; and this involves the expense of chemical agents, labour, time, etc.

The foreign matters, to say the least, are unprofitable diluents of the phosphate of lime constituent. Indeed, their presence in mineral phosphates is an injurious influence of important degree. Apart from their cementing action, they have the disadvantage of importing into the products a humid property and a large degree of dilution, without any compensating advantage whatever, when the crude mineral is treated with acid for

conversion into pure phosphates of lime. They not only waste acid in this manner, but really are barriers to its free action upon the phosphate of lime constituent, as the latter remains intact until the associate matters have been overcome chemically.

As promoters of waste and excessive dilution, I term these foreign matters *profligate elements or associates*; and they consist of fluoride of calcium, carbonate of lime, organate and silicate of lime, oxide of iron and alumina, in first degree; and of sand, silica, and organic matter, in secondary importance.

Pure tri-phosphate of lime, divested of all associates passive in themselves, or which might paralyze its fertilizing action, is, therefore, the only sound basis for computing the value of a crude phosphate of lime. There is no such standard in Nature, practically considered; but if one should be found, it would be worth double the market value of a mineral containing only 50 per cent. of tri-phosphate of lime, plus the cost of the acid, labour, and manufacturing expense which the residual moiety of profligate elements would entail in the conversion of two tons of

such crude material into the one ton of pure phosphate.

As the per cent. of phosphate of lime falls, that of the profligate associates rises; and hence the convenience and expense of refining a crude mineral are dependent upon the prevailing circumstances in this respect; and, correspondingly, the value will progress downwards or upwards in regular arithmetical proportion.

The medium grades of mineral constitute the major part of the crude phosphate resources, and, being unsuited for fertilization until they have been chemically prepared, it follows that the basis for computation must be selected from them. And, as seems to me most justifiable, I take one containing 45 per cent. of *actual* tri-phosphate of lime, the present market value of which is tenpence one farthing per unit, or thirty-eight shillings and sixpence per ton. This kind of mineral phosphate of lime has expression in the Wicken and Calais Coprolites, and the best quality of "*South Carolina Phosphate*".

Taking, then, a crude mineral of 45 per cent. of lime phosphate strength, at its pre-

sent market value of £4 : 5 for 2·20 tons, the only datum that is needed to form a table of the money value of different grades of raw phosphate is the mere expense for chemicals, labour, fuel, etc., which would be consumed for refining that quantity of crude mineral into its equivalent of 1·0 ton of pure or standard phosphate of lime. This would be £5 : 15, according to my experience, and must be distributed, therefore, through all the degrees from 45 to 100 of the scale, in order to express a correct graduation of the value.

There are, consequently, fifty-five degrees which are to share the amount which is to be apportioned ; and, as the ratio of phosphate may rise degree by degree, in the raw mineral, each degree will hold not only its original value of tenpence farthing per unit, but an additional one acquired by the saving of the refining expense which, otherwise, would be involved by displacing its equivalent of profligate elements.

Starting, therefore, at tenpence farthing per unit for a raw mineral containing 45 per cent. of actual tri-phosphate of lime, there must be a progressive advance of one

farthing for each degree, so that when the natural quality of the mineral may have risen to purity, as in some specimens of apatite, it will represent a value of two shillings per unit.

In like manner, the scale may be carried downwards by diminishing the valuation, progressively, a farthing for each degree of *actual* phosphate of lime strength; but, for manufacturing purpose, the mineral should not have less than twenty-four degrees, in that respect. In other words, mineral phosphates cease to be profitable when they contain less than 24 per cent. of actual phosphate of lime.

The following table is founded upon this basis, and refers to the *actual* per cent. or degree of *phosphate of lime*, because it is my habit always to distinguish that portion of phosphoric acid thus united from that which may be combined with the oxides of iron and aluminium that are present, and for the simple reason that the latter is, agriculturally, much inferior in value to the former, and should be estimated separately.

This explanation is rendered necessary by the fact that analyses of mineral phosphates

are made often in a "*commercial*" style most discreditable to science and the chemical profession. Not only are incongruous constituents grouped together, in the report, under one head; but the *total* of phosphoric acid is expressed most frequently by its *equivalent* in tri-phosphate of lime, as if there were no other phosphate present: and when, in fact, much of the phosphoric acid is combined actually and less profitably with alumina and oxide of iron. Such a presentment implies a character which is unreal, and practises a deception which is mean. Science, in its dignity, is regardless of all interests but those of truth and humanity. Its mission is to serve the good of mankind, and not the profit of an individual or class. The chemist, then, in his professional quality, is a high priest of science, who assumes, as a trust, the obligation of administering its rites without fear or favour in respect of results or persons; and, in betraying this confidence, he becomes not only a false prophet, but deposes himself by the act from his sacred office.

Morfit's Table of the Value of Crude Phosphates of Lime of Different Grades.

Per cent. of actual tri-phosphate of lime.	Per cent. of profligate associates.	Value of the raw mineral per unit of tri-phosphate of lime.			Per cent. of actual tri-phosphate of lime.	Per cent. of profligate associates.	Value of the raw mineral per unit of tri-phosphate of lime.		
		S.	D.	F.			S.	D.	F.
45	55	0	10	1	73	27	1	5	1
46	54	0	10	2	74	26	1	5	2
47	53	0	10	3	75	25	1	5	3
48	52	0	11	0	76	24	1	6	0
49	51	0	11	1	77	23	1	6	1
50	50	0	11	2	78	22	1	6	2
51	49	0	11	3	79	21	1	6	3
52	48	1	0	0	80	20	1	7	0
53	47	1	0	1	81	19	1	7	1
54	46	1	0	2	82	18	1	7	2
55	45	1	0	3	83	17	1	7	3
56	44	1	1	0	84	16	1	8	0
57	43	1	1	1	85	15	1	8	1
58	42	1	1	2	86	14	1	8	2
59	41	1	1	3	87	13	1	8	3
60	40	1	2	0	88	12	1	9	0
61	39	1	2	1	89	11	1	9	1
62	38	1	2	2	90	10	1	9	2
63	37	1	2	3	91	9	1	9	3
64	36	1	3	0	92	8	1	10	0
65	35	1	3	1	93	7	1	10	1
66	34	1	3	2	94	6	1	10	2
67	33	1	3	3	95	5	1	10	3
68	32	1	4	0	96	4	1	11	0
69	31	1	4	1	97	3	1	11	1
70	30	1	4	2	98	2	1	11	2
71	29	1	4	3	99	1	1	11	3
72	28	1	5	0	100	0	2	0	0

Precipitated Phosphate of Lime.

This being a pure, or nearly pure, product eliminated from the raw mineral phosphates at great expense, is much more valuable than any corresponding grade of natural phosphate of lime. Being very sensitive to the atmospheric and solvent influences of the soil, it represents the *potential* condition of its class. In making the preceding table, only the bare expense of materials and manufacture, without margin for profit, was added to the first cost of the raw minerals, in order to fix the value of different grades of natural phosphate. For the reasons above noted, however, and also because there is a great economy secured, as to package and transportation charges, in connection with the pure concentrated artificial product, its value would be fairly computed by adding fifty per cent. to the figures noted in the table for natural phosphates. In other words, pure precipitated phosphate of lime has an actual worth of three shillings, at least, per unit. As it is inexpedient to dry out all its moisture, the presence of water, even to the

extent of ten per cent., should not be considered an impurity to degrade its quality and rating; which latter, however, refers here to the anhydrous state.

Colombian Phosphate of Lime.

This form of precipitated phosphate of lime contains more or less di-phosphate, and, consequently, has a higher degree of potentiality. Its value is, therefore, greater, and will be fairly computed by calculating its total of phosphoric acid to lime, and estimating the equivalent of tri-phosphate of lime, thus deduced, according to the rule prescribed above for precipitated phosphate,—that is, at three shillings per unit.

Di-phosphate of Lime.

This phase of phosphate is met with only occasionally in Nature. In such instances, its phosphoric acid must be calculated to lime as tri-phosphate, and the equivalent thus deduced is then to be rated according to the table at p. 498.

The artificial product requires a different consideration. By reason of its chemical

PAN FOR MELTING STEARIC PITCH.

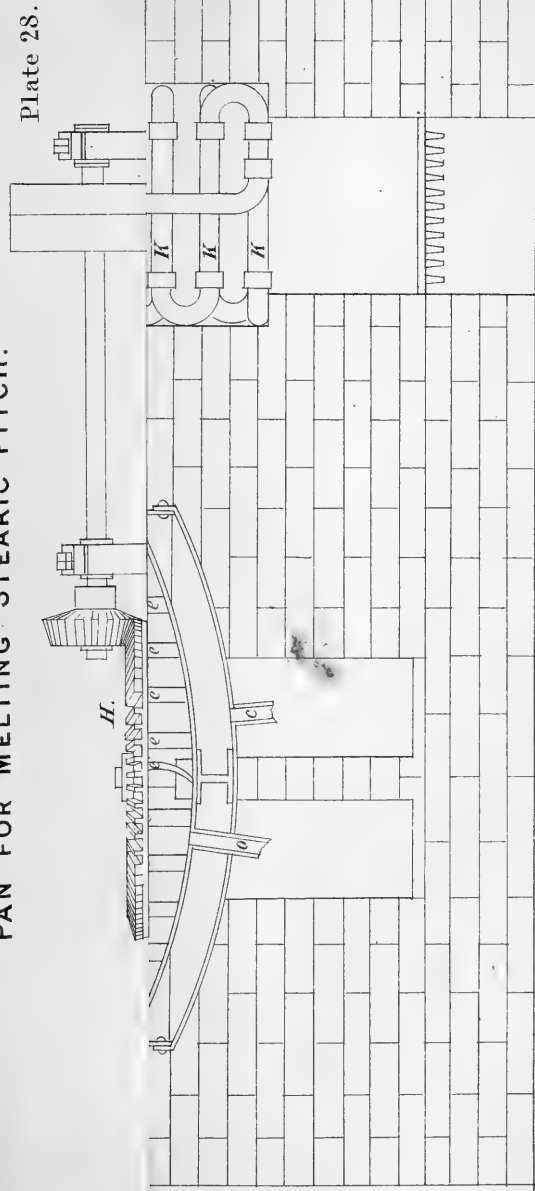

SECTION.

SCALE OF FEET.



PAN FOR MELTING STEARIC PITCH.

Plate 28.



SCALE OF FEET

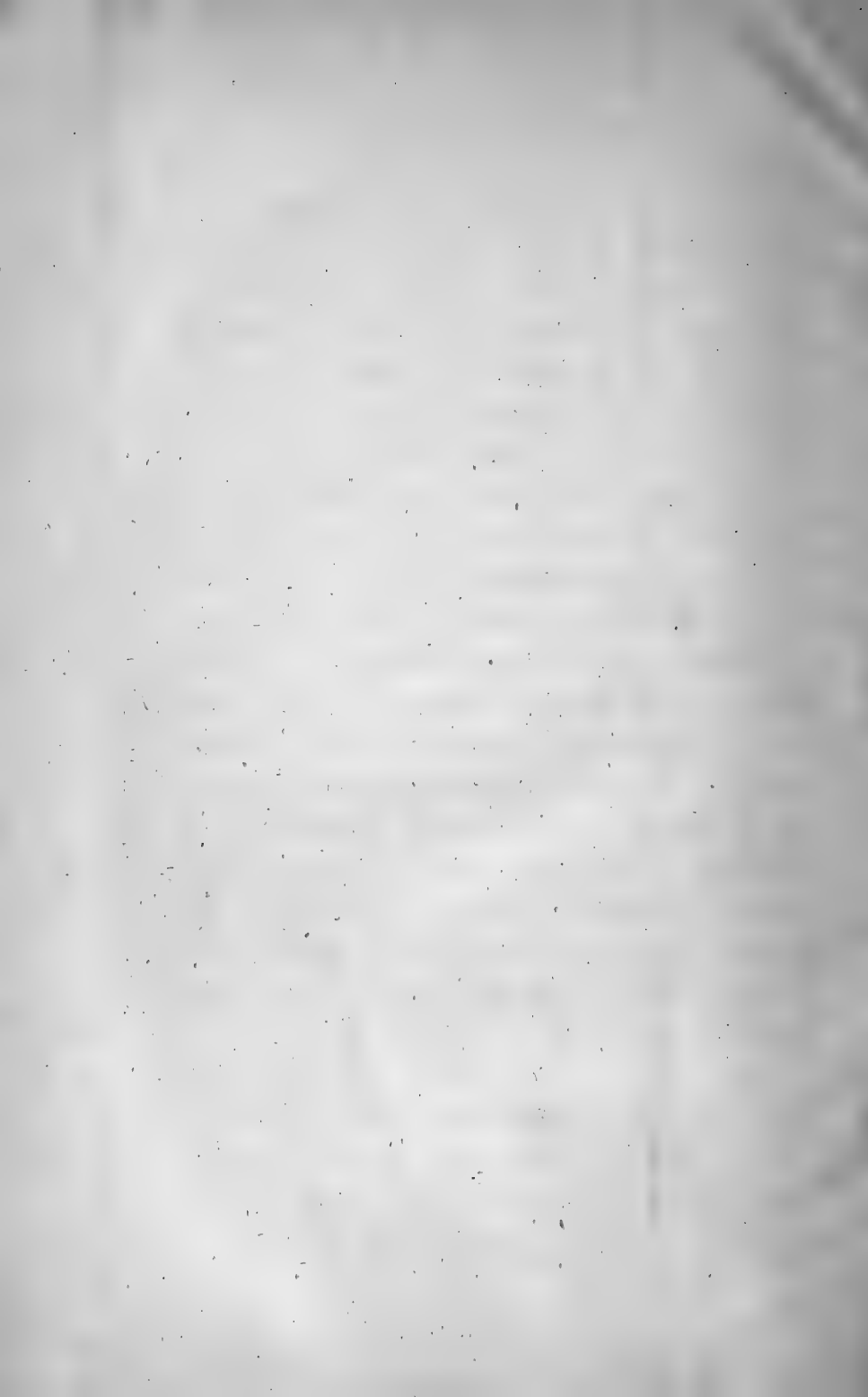

tenderness, it is in the same category for potentiality as the Colombian Phosphate, but in higher degree. Though the cost of its preparation is not greater than that of the Colombian Phosphate, it contains a much larger ratio of phosphoric acid, and, therefore, must be estimated accordingly. The proper way to determine its value will be to calculate its content of phosphoric acid to lime as tri-phosphate, and value its equivalent of the latter at three shillings per unit.

As it contains about six and a half per cent. of constitutional water, and may hold, advantageously, as much more of accidental moisture to insure impalpability of powder, 10 to 15 per cent. of water should not be allowed to disturb the valuation above given. Indeed, a product which does not contain more than 10 per cent. of water and 10 per cent. of foreign matter is pure for all practical purposes.

Bi-phosphate of Lime.

The processes for making pure precipitated or di-phosphate of lime are so simple, economical, and advantageous, in all re-

spects, that I do not recognize any other materials as a proper basis for the manufacture of bi- or superphosphate of lime. My views on this point have been set forth already in Chapters XIII and XIV. It is only necessary to remark now, that either precipitated, Colombian, or di-phosphate will yield a "superphosphate" of the highest possible quality at even a lower cost than the cheapest of crude mineral phosphates when great purity, concentrated form, and economy of packing and transportation are considered. The "superphosphate" of promiscuous composition, therefore, as made from mineral phosphates (often carrying 90 per cent. of worthless matter, and even at the best, when prepared from good bone-ash, never richer than 30.0 per cent. of anhydrous bi-phosphate of lime), is being pushed into merited disrepute by the chemical improvements of the day in connection with this subject.

As made from the pure sources, "superphosphate" will contain nothing but the chemical equivalent proportions of bi-phosphate and sulphate of lime which rightly belong to it. Its value, therefore, will be the

first cost of the precipitate, plus that of the quantity of sulphuric acid required to convert it into bi-phosphate, with 10 per cent. added for profit. Thus,—

100 tons of pure precipitated phosphate of lime	-	£1500
82 „ brown oil of vitriol of specific grav. 1·700		287
Manufacturing expenses, profit, etc.	-	150
		<hr/>
		£1937
		<hr/>

The product is, quantitatively, 190 tons of “superphosphate”, containing, practically, 39 to 40 per cent. of actual bi-phosphate of lime, or $\text{CaO}, 2\text{HO}, \text{PO}^5$. As commercial “superphosphate”, therefore, it is worth, say £10 per ton, or five shillings per unit of actual bi-phosphate of lime.

I have estimated the bi-phosphate of lime, with its constitutional water, as part of its formula, and for the reason that this water is an element of its nature, which cannot be alienated without modifying the properties of the original bi-phosphate disadvantageously.

Pure Bi-phosphate of Lime.

This salt is made from the preceding “superphosphate” by merely leaching it in water and evaporating to crystallization the

solution of bi-phosphate thus obtained. 100 tons of precipitated phosphate of lime give 75 tons of pure bi-phosphate, at a cost of £1987, plus 10 per cent. for manufacturing expense. This makes a total of £2200, which, divided by 75, gives £30 as the value per ton, or six shillings per unit of pure bi-phosphate of lime = $\text{CaO}, 2\text{HO}, \text{PO}_5$.

The usual commercial custom is to estimate the anhydrous bi-phosphate as equivalent to tri-phosphate of lime; and, by this means, 0.641 is made to appear as 1.00 per cent. Such a valuation is fictitious, and could not be evolved under a just system of computation. My figures will refer, therefore, to the actual bi-phosphate of lime as it exists, naturally, in the "superphosphate" or pure bi-phosphate of lime, according to the formula $\text{CaO}, 2\text{HO}, \text{PO}_5$.

Di-phosphate requires less acid than the precipitated phosphate of lime for its conversion into "superphosphate", but the product from it is much smaller, and this incident makes the two correspond closely in value as raw material for conversion into superphosphate. But, as the "superphosphate" from

di-phosphate of lime would contain a greater per centage of bi-phosphate than that made with precipitated tri-phosphate, a given weight of a product from the former will be worth more than a corresponding quantity of product from the latter. Degree and degree, the bi-phosphate from either source has the same value, which is five shillings per unit.

But for the obstinate popular prejudice in favour of "super-" or "bi-phosphate", di-phosphate would come into general use as a substitute for them. It is much more economical and fully as potential, if not quite as active, in fertilizing effect. Indeed, it is more than probable that most of the bi-phosphate, which may be sown, "*goes back*" into di-phosphate long before the growing crop has had time to take it up and assimilate it.

Phosphate of Magnesia.

This is to be estimated according to its ratio of phosphoric acid and after the rules prescribed for the phosphates of lime, according as it may be in a mineral or artificial state.

Phosphate of Alumina.

This salt, in its natural rocky state has only a commercial value; and, as "Alta Vela Guano" is the sole representative of its class, which comes to market at present in abundant and regular supply, it must be taken as the standard at the current price of £3:10 per ton of 35° phosphate strength, or one shilling per unit of phosphoric acid which it may contain. As the proportion of phosphoric acid may fall, that of the alumina and foreign associates must rise; and, consequently, the less valuable becomes the mineral. Owing to the uncertain composition of the phosphate of alumina as existing in this kind of mineral, the system of computing the value of the latter will be somewhat arbitrary. It may be wholly meta-phosphate of alumina ($\text{Al}_2 \text{O}_3, 3\text{PO}_5$), or a mixture of that and pyro-phosphate ($2\text{Al}_2 \text{O}_3, 3\text{PO}_5, 10\text{HO}$), when dried at 110°, together with more or less of free alumina. In any case, the greater the presence of alumina, the larger will be the quantity of acid required for the chemical treatment which it must undergo to become

serviceable in agriculture or the arts. Therefore, the value of this class of minerals is to be gauged according to the content of alumina and the composition and cost of the "Alta Vela Guano" at the present market price or rate. But it is not difficult to make a scale upon this basis, for the presence of a very large quantity of constitutional water in most cases excludes any appreciable amount of foreign or profligate matters. The small margin thus left for the latter constituents is almost wholly filled by silica and oxide of iron. There is, therefore, no disturbing element of calculation, but the variableness of the ratio of alumina to the phosphoric acid.

Assuming, then, as a starting-point, that the value of a mineral phosphate of alumina is one shilling per unit, when the ratios of alumina and phosphoric acid are as 33 to 31, and that there are no profligate constituents, for example, as in the "Alta Vela Guano"; then, for every gradation of the former downwards, there will be a proportional rise in the value of the mineral. Thus, it is only necessary to calculate the actual cost of removing the alumina degree by degree, in order to

determine the improvement in value for progressively augmenting ratios of phosphoric acid.

Morfit's Table of the Commercial Value of Different Grades of Mineral Phosphate of Alumina.

Ratio of alumina.	Ratio of phosphoric acid.	Value per unit.			Ratio of alumina.	Ratio of phosphoric acid.	Value per unit.		
		S.	D.	F.			S.	D.	F.
22'0	31'0	1	0	0	17'0	31'0	1	8	3
21'0	31'0	1	1	3	16'0	31'0	1	10	2
20'0	31'0	1	3	2	15'0	31'0	2	1	0
19'0	31'0	1	5	1	14'0	31'0	2	3	0
18'0	31'0	1	7	0	—	—	—	—	—

A range has been given to these computations which will comprise all the kinds of this mineral now known even by specimens only. As, however, the figures affixed refer exclusively to the phosphate of alumina in its crude state, there remains yet to explain the values of the phases of artificial phosphate of alumina as made in the phosphate-sewage process (Chapters xx and XXI), or other method of precipitation from an acid solution of the raw mineral. Here the same principles come into play as for the precipi-

tated phosphate of lime. The original rocky character of the mineral has changed to a soft pulpy condition, most tenderly sensitive to acids, alkalis, and the growing influences of vegetation ; so that, in fact, a new physical nature has been assumed. As, however, the *chemical composition* of the precipitate will not differ materially from that of the alumina phosphate constituent of the original mineral, the values of the different grades will be fairly expressed by adding twenty-five per cent. to the several degree-computations of the preceding table.

Phosphate of Iron.

The values of the different grades of this constituent, whether natural or prepared artificially, can only be estimated arbitrarily, but may safely be taken at half the rates computed for phosphate of alumina.

In either of the two preceding cases the valuation refers to the purposes of sewage-defecation, the alum manufacture, and agriculture ; for it will be seen in Chapters XVIII, XIX, XX, and XXI, that both the phosphate of alumina and phosphate of iron are capable of

many and profitable applications. Indeed, this wide range of practical usefulness makes the commercial appreciation of the phosphates of alumina and iron much greater than their agricultural value.

The remaining items pertaining to this subject are chlorides of potassium, sodium, and ammonium ; sulphates of potassa, soda, and lime ; nitrate of potassa and nitrate of soda, each of which has a current value varying with the supply and demand, as may be learned by reference to any market price-list of the day.

CHAPTER XXV.



THE MODE OF USING HYDROMETERS AND THERMOMETERS.

A HYDROMETER is a convenient glass instrument for measuring the density or specific gravity of fluids. It is often referred to throughout this work; for instance, in speaking of an acid, the strength is stated as being of so many degrees Baumé or Twaddle; that is, it has a specific gravity corresponding with the degree to which the hydrometer sinks in the liquid.

For those liquids lighter or rarer than water, viz., alcohol, ethers, and the like, the scale is graduated differently than for the heavier or more dense, examples of which latter are the acids, saline solutions, and syrups. There are several kinds of hydrometers; but that called Baumé's is the most used, and to this my remarks will refer.

The scale for the liquids rarer than water is graduated upwards from 0, at the bottom of the stem, as shown by fig. 21. For liquids denser than water, the graduation is reversed, as in fig. 22.



Fig. 21.

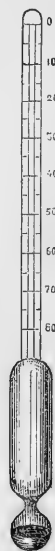

Fig. 22.

As it would be troublesome, and with many impracticable, to estimate the specific gravities of liquids in a scientific way, these little instruments are a great convenience; for, by taking out a portion of the fluid to be tested, and placing it in a tall glass cylinder (fig. 23), its degree Baumé may be ascer-

tained by noting the point to which a hydrometer sinks therein. From this datum its specific gravity is deduced by calculation, according to the proper formula on p. 514.

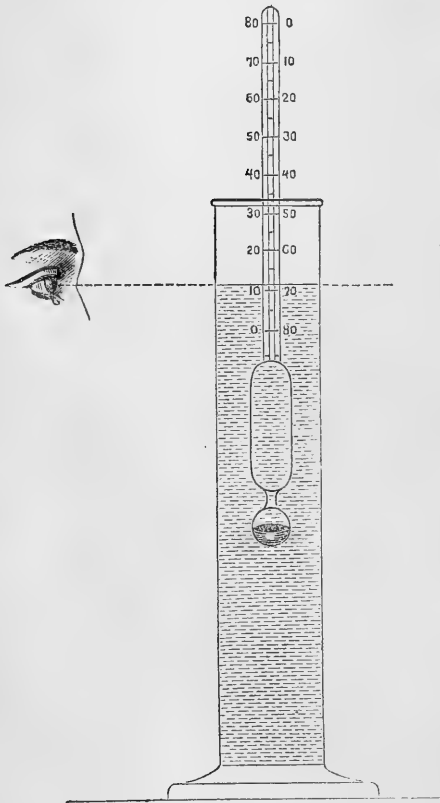

Fig. 23.

For instance, suppose the hydrometer sinks in alcohol to 35°, then its specific

gravity is 0.852, and this again can be translated into its absolute spirit strength by comparison with any accurately calculated alcohol table.

So, also, if a hydrometer for liquid denser than water sinks in acid to 66°, it denotes that the acid has a specific gravity of 1.846.

The presence of foreign matters will cause the hydrometer to give a false indication, but for nearly pure liquids the instrument answers satisfactorily; and, indeed, under all circumstances, it serves very well for noting a progressive increase or diminution in the strength of solutions or other liquids. The temperature of the liquid should be 60° to 62° Fahrenheit, at the moment of testing it.

The following rules, by Pile, in connection with hydrometers, will be found convenient:

To convert Baumé's degrees into specific gravity numbers.

For liquids lighter than water.

$$\frac{144}{B^{\circ} + 134} = \text{specific gravity.}$$

To convert specific gravity numbers into Baumé's degrees.

For liquids lighter than water.

$$\frac{144}{\text{Sp. grav.}} - 134 = B^{\circ}.$$

To convert Baumé's degrees into specific gravity numbers.

For liquids heavier than water.

$$\frac{144}{144 - B^{\circ}} = \text{specific gravity.}$$

To convert specific gravity numbers into Baumé's degrees.

For liquids heavier than water.

$$144 - \frac{144}{\text{sp. grav.}} = B^{\circ}.$$

For converting the degrees of Twaddle's hydrometer into specific gravity numbers multiply by 5, and add 1000; thus—

$$\text{Twaddle } 80^{\circ} \times 5 = 400 + 1000 = \text{sp. grav. } 1.400.$$

For converting specific gravity numbers into the degrees of Twaddle's hydrometer deduct 1000, and divide by 5; thus—

$$\text{Sp. grav. } 1.400 - 1000 = \frac{400}{5} = \text{Twaddle } 80^{\circ}.$$

Vulcanite is now substituted, sometimes, for glass, in the manufacture of hydrometer and thermometer scales. Such instruments are much more durable in every respect. They may be purchased at Blaise and Co.'s, No. 67, St. James's Street, London.

Thermometers.

The thermometer is an instrument made wholly of glass, when intended for chemical



Fig. 24.

purposes. Fig. 24 shows one with the scale graduated upon porcelain enameled upon the tube, so that the degrees may be easily read and the instrument readily kept clean. It is a measurer of the variation of temperature in bodies. The principle upon which it is constructed is the change of volume which takes place in bodies when their temperature undergoes an alteration, or, in other words, upon their expansion. In the construction of thermometers, the fluid employed for measuring the change of temperature is usually metallic mercury, because it expands uniformly and has a very wide interval between its freezing and boiling-points.

There are several different thermometrical scales, all constructed upon the same principle, but varying in their graduation; the boiling and freezing-points of each, though corresponding in fact, being represented by different numbers.

The Fahrenheit scale is most used

in this country; that of Celsius, called the centigrade, in France and the continent generally, except Spain and Germany, where Reaumur's scale is preferred.

In the Fahrenheit thermometer, the interval between the freezing and boiling-points of water is divided into 180 degrees. The freezing-point is placed at 32° , and hence the boiling-point at $32 + 180 = 212^{\circ}$. Reaumur divides the distance between the two extreme points of water into 80° , and Celsius spaces his thermometer (the Centigrade) into 100 equal intervals, the zero point, as in Reaumur's, being placed at freezing. The Fahrenheit scale is most convenient, because of the lesser value of its divisions; but, as it frequently happens that the manufacturer has no choice in the kind, but is compelled to take such as can be conveniently obtained, I give formulæ for converting the degrees of one into those of the others.

In the graduation of the scale it is only necessary to have two fixed determinate temperatures, and for these the boiling and freezing - points of water are universally

chosen. The scales can be extended beyond either of these points by continuing the graduation. Those degrees below zero or 0° have the minus (—) prefixed, to distinguish them from those above: thus 55° F. means fifty-five degrees above zero, Fahrenheit's scale; and -9° C., nine degrees below zero, centigrade scale. The thermometers for general use, very seldom, however, extend either way beyond the boiling and freezing-points of water, but they are graduated sometimes to 400° or 600° . One of 300° Fahrenheit is cheaper and convenient for general manufacturing purposes.

The following rules will be found convenient for converting the degrees of the several scales into each other:—

To convert Centigrade into Fahrenheit degrees.

Multiply by 9, divide by 5, and add 32.

To convert Centigrade into Reaumur degrees.

Multiply by 4, and divide by 5.

To convert Reaumur into Fahrenheit degrees.

Multiply by 9, divide by 4, and add 32.

To convert Reaumur into Centigrade degrees.

Multiply by 5, and divide by 4.

To convert Fahrenheit into Centigrade degrees.

Deduct 32, multiply by 5, and divide by 9.

To convert Fahrenheit into Reaumur degrees.

Deduct 32, multiply by 4, and divide by 9.

CHAPTER XXVI.



WATER AND ACID-PROOF CEMENTS AND PAINTS.

IN the construction of mason-work for chemical purposes, it is necessary that the cement employed shall be not only strong and durable, but proof against the action of water; and, if possible, also resistant of the action of acids. The following means are the best known for accomplishing those requirements.

Hydraulic Cement.

The Portland Cement, as made in London and its vicinity, fulfils all these requirements, except the last, in more eminent degree than any other; and it is best to employ that kind.

Without intending to discuss princi-

ples* which regulate the hydraulicity of cements, I will remark that the lime which is to be used for works which are to resist the action of water, must be made of a limestone containing a certain amount of clay and magnesia with some little manganese and iron. The proportion of these ingredients combined should bear the relation of 20 to 30 per cent. of the carbonate of lime constituent. In a lime-stone of such a composition the soluble silica, alumina, and magnesia, will be most likely to hold that proportional relation to the lime which seems necessary to a prompt and complete hydraulicity of a cement.

If there should be an excess of lime over and above the chemical proportion required to form the triple silicate of lime, alumina and magnesia which constitutes a good hydraulic or water-cement, it would in time be washed out gradually by the water; but the

* According to Fremy, aluminate of lime plays a most important part in the hydraulicity of cements; and he has reported the results of his researches on the subject, in the *Journal de Pharmacie et de Chimie*, at p. 20 of vol. 2 for 1865.

cement will remain hard, and unimpaired in strength and durability.

In the event of there being no excess of lime, the silicate formed by mixing the cement with water will be so closely bound as to its constituents, that it will resist to a considerable degree even the decomposing action of acids.

A very good hydraulic cement may be made according to the following formula.

The ingredients are—best quality fat lime, 68 to $74\frac{1}{2}$ parts by weight; refractory clay, $27\frac{1}{4}$ to $42\frac{3}{4}$; sulphate of lime, $4\frac{3}{4}$ to 9·0; and boracic acid, 0·105 to 0·401.

All the substances are calculated in the anhydrous state. The cements formed between these limits vary in the rapidity with which they set, but are of equal quality, and attain, in the course of time, the same degree of hardness. The substances are mixed after being ground to a fine powder. They are then made into bricks with water, and are baked at a white heat. After this, they are reduced to an impalpable powder. This powder, mixed with water, is then used as the cement, either plain or coloured, and can be moulded as required.

Böttger's Cement.

This is a very good cement for sealing joints. It is made by mixing finely-powdered chalk with an aqueous solution of silicate of soda, of 33° Baumé, so as to form a stiff mortar. It sets hard in six to ten hours.

Soré's Cement.

This is a very hard cement, and will serve for sealing the joints of mason-work. It is a hydrated basic oxychloride of magnesium, prepared by mixing calcined magnesia with an aqueous solution of chloride of magnesium of 20° to 30° Baumé. The denser the solution, the harder will be the cement.

Bituminous Cement, or Stearic Pitch.

When the digester vats are built, they may be lined with the preceding cements if intended for solutions of a neutral character. But for operations of an acid nature they must be covered with a cement or paint of thorough protective power against the chemical friction of acids. This coating must also

have a high softening-point, more particularly where heat is to be used in the vessels painted with it.

The material fulfilling more nearly than any other all these requirements, is the black pitchy residue obtained in the distillation of fats for the manufacture of stearic candles, and in the refining of "COTTON OIL FOOTS". It is black, insoluble in water and acids, and retains its hardness so obstinately, that it is difficult to melt it alone at a temperature below 300° Fahrenheit. Being a refuse article, its market price is very low.

In order to fuse it, a particular apparatus is necessary, as shown by Plate 28. It consists of a strong jacketed pan *AA'*, made of wrought iron plate, and set in brick-work. This pan is heated by steam, which enters the jacket through the pipe *B*. The condensed steam runs out through the tube *c*, which, during the heating, must be kept partly open by means of a cock as a safety-valve.

The stirrer *D* is a wrought iron shaft resting in a footstep at the bottom of the pan. Its blades or arms are of two kinds: the

lower ones being a series of loose scrapers of forged iron *eee*, and *c* strung upon a rod *f*. This arrangement insures the scraping of the bottom of the pan and prevents accumulation of lumps of bitumen upon the heated surface of that portion of the metal; while, at the same time, it is a protection against breakage, which might happen often, if the blade were more stiff, from the obstinate tenacity with which the pitch adheres to the metal when it is only partly melted.

The upper blades *gg*, are made of a form to produce agitation of the contents of the pan, and also to scrape the sides, so as to keep them clean of adhering pitch.

The stirrer is driven by steam, through means of the gearing *H*, affixed to a beam above.

The pan, as shown by the plate, has the capacity for melting five hundredweight of pitch at each operation; and four meltings may be made in twelve hours.

The temperature required to effect the fusion being about 310° Fahrenheit, and, as the generator would have to be heated up to a pressure of sixty-five pounds per square

inch, in order to give steam of that degree, it will be safer and more convenient to use a super-heater, as an auxiliary means. This apparatus, of inexpensive form, shown by o, at the side of the pan, consists of a coil made of very thick welded iron tubes $\kappa \kappa$, and put together by joints.

The connections with the generator are shown at m , and with the pan at n . The whole is set in brick-work, with a furnace beneath, and this latter has a damper-arrangement for the management of the heat, according as steam of a moderately or very high temperature may be required.

A little boiled linseed-oil will facilitate the fusion, but the addition of this fluid must be limited to ten per cent. of the pitch, for fear of lessening the hardness of the product. When the whole is fused and has become quite cold, it is to be thinned with spirits of turpentine or petroleum naphtha to such consistence as may be required.

When the pitch is to be used as a cement it must be applied in its hot fluid state, and as thick as possible; for which purpose, consequently, it should not contain any spirits

of turpentine. It takes several days to dry when mixed with oil alone; but this objection is countervailed by advantages. In this form it covers iron well with a coating which is very adhesive, though not even.

To make an even coating, turpentine must be added, so as to thin the cement to the consistency of a paint, which may be applied readily with a brush.

As the drying is very rapid, several successive coats may be put on in a day.

This latter paint, applied thick and in several coats, is the protecting covering for iron and other vessels, which has been prescribed throughout this work. It may be made even without the aid of linseed-oil or the super-heater, by means solely of turpentine and at the ordinary temperature of the atmosphere.

Vessels coated with this material will resist the action of acid liquors at temperatures even beyond 225° Fahrenheit.

Marine Glue.

This cement, which is proof against the action of both water and acids, may be made

by heating gently one pound of india-rubber with twelve pounds of coal-tar, mixing thoroughly, and then adding and melting in twenty to twenty-four pounds of powdered shellac. The whole is then to be dipped out, and poured on a slab to cool. When used, it requires to be heated above 250° Fahrenheit.

This cement is much more expensive and less advantageous than that made with the pitch from fats. Too frequent remelting spoils it.

Substitute for Marine Glue.

A good water and acid-proof cement may be made by melting together equal parts of gutta-percha and pitch, and casting into sheets or sticks on a plate. It may be made hard or soft by using less or more of gutta-percha.

Cement to Resist Sulphuric Acid.

Take caoutchouc, melt it by a gentle heat, treat with 6 to 8 per cent. by weight of tallow, taking care to keep the mass well stirred; add dry slaked lime, so as to give

the fluid mass the consistency of soft paste; and, lastly, stir in 20 per cent. of red lead, whereby the mass which would otherwise remain soft becomes hard and dry. This cement resists, according to Dr. Wagner, boiling sulphuric acid.

A solution of caoutchouc, in twice its weight of raw linseed-oil, aided by heating, and the addition thereto of an equal weight of pipe-clay, yields a plastic mass, which also resists most acids.

Cements for Steam-Pipes.

A very excellent cement, which is impermeable by air or steam, and very suitable, therefore, for making tight the joints of steam-pipes, is made by kneading together into a perfect mixture the following ingredients:—

Graphite, finely powdered	-	-	3 lbs.
Lime, slacked and sifted	-	-	3 "
Sulphate of lime, in fine powder	-	-	8 "
Boiled linseed oil	-	-	7 "

Artificial Stone.

A very excellent stone or cement may be made by melting together 200 pounds of

stearic pitch, 20 pounds of sulphur, and barely enough of spirits of turpentine to give it a thin pasty fluidity. At this stage, 50 pounds of finely-powdered lime, 200 pounds of ground plaster, and 25 cubic feet of very fine sand are to be added by degrees, and well stirred into the mixture, after which the mass is to be melted and pressed into bricks. This stone hardens in five to eight days.

INDEX.



- Acid reservoir, the, 113
- Alabaster, 83
- Alkaline salts, estimation of, in mineral phosphates, 457
- Alma, M. de, 416
- Alta Vela guano, 50, 161, 223, 237, 246, 360-363, 395, 399, 400, 402, 403, 406, 407, 409; analysis of, 364; treatment of for manure, 365; replaced by Morfit's "mother-liquor", 398; valuation of, 506, 507, 508
- Alum, from phosphate of alumina, 408
- Alumina, estimation of in mineral phosphates, 455
- phosphate of, not without fertilizing effect, 3; estimation of in mineral phosphates, 89, 408, 414, 455; commercial valuation of, 506, 508
- phosphate, left in mother-liquor when phosphate of lime is precipitated, 378; useful for defecation of sewage, 161, 402, 414; in manufacture of sugar, 415; in dyeing, 417; as glaze for pottery, 418
- phosphate of, Peter Spence's patent for treatment of mineral, 379; also J. Berger Spence and Peter Dunn's, 383, 385; also Townsend's, 389
- and iron, formula for the chemical analysis of mineral phosphates of, 465
- Aluminate of soda, a ready saponifier, 409
- Aluminium, oxide of, 88

- Ammonia, sources of, 44 ; wool, 44 ; leather clippings, 45 ; dried blood and flesh, 46 ; excreta, 47 ; sewage, 49, 399, 406 ; atmospheric air, 488
- Ammonia, its defects as a precipitant of phosphate of lime, 163
- crude liquor of, production and constitution of, 39 ; estimates of evolution from coal, 40 ; separation from gas-liquor, 41-44 ; as an economiser, 284
- generator, the, 176
- hydrochlorate of, 57
- phosphate of, 41
- sulphate of, constitution and manufacture, 55, 57 ; use as an economiser, 280, 284
- commercial valuation of, 486, 487, 488, 489
- Ammoniacal wash, 197
- Ammonium, chloride of, 7, 57 ; produced from sulphate of ammonia, 280
- Animal charcoal, 7
- Analysis, "*commercial*", meretricious character of, 465, 496, 497
- Analyses of—
- Apatite, by Hunt, 30 ; by Voelcker, 30
- German phosphorite, by Fresenius, 13
- Russian phosphorite, by Grewingk, 14
- Wicken coprolites, by Morfit, 17
- Pas de Calais coprolites, by Morfit and Gerland, 17
- Phosphorite, 30
- Suffolk and Cambridge coprolites, 30
- Sombrero guano, by Voelcker, 19
- Ditto, by Evans and Jones, 19
- Ditto, by Morfit, 30
- St. Martin's phosphate, by Voelcker, 20
- South Carolina phosphate, by Morfit and Gerland, 22, 30
- Ditto, by Voelcker, 23

Analyses of—

- French phosphorite, by Voelcker, 25
Navasa guano or Cooperite, by Morfit and Gerland,
27, 30
Bone-ash, by Morfit, 30
Bone-black, by Morfit, 30
Guaymas guano, by Morfit, 30
Marlstones, by Morfit, 30
Orchila guano, by Morfit, 30
Rossa guano, by Morfit, 30
Table of comparative composition of crude natural
phosphates, 30, 31
Wool, by Scherer, 44
Brighton chalk, by Schweitzer, 64
Tri-, di-, and bi-phosphates of lime, 68
“Superphosphate”, commercial, 289, 292, 293, 325 ;
pure, 300, 301, 323
Gerland's sulphite of tri-phosphate of lime, 341, 342, 359
Redonda guano, by Johnson, 364
Alta Vela guano, by Voelcker, 364
A. B. R. guano, 364
Sewage-precipitate by sulphuric solution of Alta Vela
guano, 400 ; by Morfit's “mother-water”, 400
Apatite, 2, 7, 290 ; characteristics and sources of, 9, 10 ;
solubility of, 28 ; analysis of Canadian, 30
A. R. B., a rock phosphate, 361 ; analysis of, 364 ; treat-
ment for manure, 365
Artificial stone, 530
Austrian phosphorite, 13
- Bahia, nitrate of soda, 66
Baking-powder, Horsford's, 327 ; directions for use, 334
Baltic, the, 8

- Barreswill on gas-liquor, 42
Baumé's hydrometer, 512
Bavaria, 10, 11
Bi-phosphate of lime, 73, 75, 303-314, 502, 503, 504
Bituminous cement, 524
Black Sea, the, 8
Blair, Harrison, 123
Blake's crusher, 96, 97; table of sizes of, 100
Blood, dried, a source of ammonia, 46
"Blow-up, the", 229, 234, 241, 242, 244
Bohemia, 10
Boiler, steam, the, 109
Bone-ash, the typical phosphate of lime, 2, 67; its sources, 8; value as a fertilizer, 9; its solubility, 28; analysis of by Morfit, 31; the best material for "superphosphate", 200; but too good for the purpose, 291; method of analysis, 434; commercial valuation of, 489
Bone-black, made by calcining bones, 7; value as a fertilizer, 9; analysis of by Morfit, 31; ammonia incident to its production, 44; its solubility in soil, 69; commercial valuation of, 490
Böttger's cement, 523
Bone-dust, commercial valuation of, 490
Bread, brown, 336; gout and confectioners' cakes, 337
Brighton chalk, 64
Bristles, ammonia in, 44
- Calcium, chloride of, constitution and properties of, 81, 85; reaction with sulphate of potassa, 86; how utilized, 155, 277, 286
——— fluoride of, 84; estimation of in mineral phosphates, 458
——— oxide of, 61

- Calcium, phosphate, sulphite of, 78
Cambridgeshire coprolites, 15
Canadian apatite, 9, 10; coprolites, 15
Carolina, South, phosphates, 20; analysis of by Morfit and Gerland, 22, and by Voelcker, 23; 170, 202, 204, 206, 208, 325
Carr, Thomas, his disintegrator, 133, 244, 376
Celsius's or centigrade thermometer, 518
Cement for steam-pipes, 529
Cements, water and acid proof, 520, 523, 528, 529, 530
Cereal crops, fertilizer for, 426
Chalk, 64
Charcoal, animal, 7; peat, for sewage, 396
Chemical analysis of phosphatic materials and products, formulæ for, 432
Chemistry, "*commercial*", style of analytical, 465, 496, 497
Chilian nitre, 66
Chloro-phosphate of lime, Way's, 263
Church, A. H., 2, 12
Clark's enamel, 232
Clegg, on ammonia in gas-liquor, 40
Cliff, 127
Collas, M., uses phosphate of alumina for dyeing, 417
Colombian guano or phosphate, 71, 72, 75, 78, 130, 160, 162, 216, 278, 301, 307; manufacture of, 203; first process, 204; the mother-liquor or wash, 221; second process, 222; formation of, 241, 298
Confectioners' cakes, 337
Cooperite or Navasa guano, 25, 237: analysis of, 31
Coprolites, 2; their nature and sources, 15, 16; Wicken and Pas de Calais, analysis by Morfit and Gerland, 17; value of, 494
Deligny, 227; his process for di-phosphate of lime, 259-263

-
- Digester, the, or solution vat, 117
Digestion, first fractional, 165 ; second ditto, 169
Di-phosphate of lime, 70, 72, 226, 227, 238, 501
Disinfectant, sulphite of tri-phosphate of lime as a, 353
Disintegrator, Carr's, 133, 244, 300, 316, 323
Dominique, his report on phosphate of alumina in the purification of sugar, 416
Dreschfeld, Dr. J., experiments with Gerland's sulphite of tri-phosphate of lime, 354
Drying-kiln, the, 129
Dunger, universal, 426
Dunn, Peter, 41 ; patent for treatment of mineral phosphate of alumina, 383, 385, 408
Dyeing, use of phosphate of alumina in, 417
Dyer, W. J. T., 2, 12
- Elevator, the, 111
Engine, the steam, 109
Estremadura phosphorite, 11
Etchells, W. G., on supply and market values of woollen waste, 45
Evans and Jones, analysis of Sombrero guano, 19
Evaporating-pan, the, 131
Excreta, human, a source of ammonia, 47
- Fahrenheit's thermometer, 517-519
Factory plant, arrangement of, 147
Feathers, ammonia in, 44
Feltz, E., on sugar fertilizers, 428
Fertilizers, normal, 425 ; universal dunger, 426 ; for cereal crops, 426 ; for leguminous plants, 427 ; for gramineous plants, 427 ; for sugar, 428 ; for root crops, 430
————— compound, formula for analysis of, 469

- Fertilizing materials, commercial valuation of, 485
- Filter vats, 171
- Flesh, dried, a source of ammonia, 46
- Fluoride of calcium or fluor spar, constitution of, and presence in rock guanos, 15, 84; estimation of in mineral phosphates, 458
- Forbes's defecation of sewage by phosphates of alumina and iron, 395; should be supplemented by filtration through peat charcoal, 396
- Formulæ for chemical analyses, 432; of phosphates of alumina and iron, 465; commercial "superphosphate", 469; compound fertilizers, 470
- French coprolites, 15; phosphates, 24
- Fremy on cements, 521
- Fresenius, 13; analysis of German phosphates, 30
- Furnace, the roasting, 109
-
- Gas-liquor, as a source of ammonia, 40; its extensive production, 43
- Generator, the ammonia, 176
- Geological distribution of the mineral phosphates, 2
- Gerland, Dr. B. W., analyses of Pas de Calais coprolites, 17; of South Carolina phosphates, 22; of Cooperite or Navasa guano, 27; his sulphite of tri-phosphate of lime, 338; method of manufacture, 346; its properties, 353; and analysis, 356
- German phosphates, 11; coprolites, 15
- Gibbsite or Alta Vela guano, 361
- Glue, marine, 527, 528
- Gill, Haughton, on sugar, 430
- "Going-back" of commercial "superphosphate", 293, 308, 310, 505
- Gossage's coke-towers, 36

- Gout bread, 337
Gramineous plants, fertilizer for, 427
Grewingk's analysis of Russian phosphorite, 14
Grinding apparatus, 92; roller mill, 93; sifter, 95; Blake's
 crusher, 97; Howel-Hannay mill, 102
Guaymas guano, 17, 71
Gypsum, 83
- Hayti, 25
Henry, Michael, 260
Herepath, analysis of Suffolk coprolites, 31
Horn, ammonia in, 44
Horsford's baking-powder, 327
Hosch and Enderisch's universal dunger, 426
Howel-Hannay mill, 97, 102, 323
Hunt, T. S., on apatite, 10; analysis of Canadian apatite, 30
Hydraulic cement, 520
Hydrochloric acid, its constitution and production, 36;
 Ure's table of specific gravities, 38; preferred to sul-
 phuric acid for solution of phosphates, 156
Hydrometers, mode of using, 511
- Inertia, fertilizing, of certain mineral phosphates, 3
Iron, oxide of, in mineral phosphates, 87, 453
— phosphate of, not without value as manure, 3; espe-
 cially when freshly precipitated, 88; estimation of in
 mineral phosphates, 87, 451; left in mother-liquor
 when phosphate of lime has been precipitated, 378;
 conjoined with phosphate of alumina for sewage pre-
 cipitation, 402
— phosphate of, commercial valuation of, 509
- Johnson, analysis of Redonda guano, 364

- Kamrodt, on sources of ammonia, 44
Kiln, the drying, 129
Knapp, on gas-liquor, 42
- La Plata, 8
Leather clippings a source of ammonia, 45
Leguminous plants, fertilizer for, 427
Lerverd, A., et Cie., 127
Liebig-Horsford baking-powder, 327
Lift, the, 112
Limburg and Staffel phosphorite, 12
Lime, constitution and diffusion of, 61
— carbonate of, its constitution and diffusion, 63, 288 ; disadvantages of in association with phosphate of lime, 79-82 ; estimation of in mineral phosphates, 461
— chloro-phosphate of, 226 ; Way's process for production of, 263-276
— Colombian phosphate of, 78, 203, 221, 241, 298, 500
— Gerland's sulphite of tri-phosphate of, 338 ; method of manufacture, 346 ; its properties, 353 ; analysis, 356
— mineral phosphates of, method of analyses, 434 ; valuation of, 491. Table of their value per cent., 498
— organate of, 82
— phosphate of, its three chemical phases, 67 ; tri- or bone-phosphate, 68 ; its solubility in the soil, 69 ; various characteristics, 70 ; pure rare in Nature, 290 ; errors or tricks in estimation of, 326, 432. Commercial valuation of, 493-497
— bi-phosphate of, 73 ; favoured by agriculturists, but inferior to precipitated phosphate, 75 ; production of pure and wholly soluble, 303-314. Commercial valuation of, 502, 503, 504

- Lime, di- or neutral-phosphate of, 70-72 ; manufacture of, 226 ; ought to have first place among fertilizers, 227 ; Morfit's process (A), 227 ; and process (B), 238. Commercial valuation of, 501
- precipitated phosphate of, its solubility in the soil, 75 : its production and characteristics, 76-78 : pulpy condition, 157 ; only less potent than Colombian guano, 162 ; eminently suited for conversion into "superphosphate", 163 ; but almost too good for the purpose, 302. Valuation of, 499
- precipitated phosphate of, process of manufacture, 164 ; the purge or first fractional digestion, 165 ; the solution or second fractional digestion, 169 ; the precipitation and the vacuum filter vats, 171 ; the ammonia generator, 176 ; the ammoniacal wash or mother-liquor, 197 ; the purge-liquor, 199
- sulphite of, 340
- "superphosphate" of, principle of production of, 288 ; manufacture of commercial, 315-326 ; delusive analyses of, 325
- sulphate of, 65 ; constitution and presence in rock guanos, 83
- Magnesia, phosphate of, 79 ; estimation of in mineral phosphates, 454 ; commercial valuation of, 505
- Maracaibo, Colombian guano from, 71
- Marl-stones, 2, 7, 20, 30
- Marine glue, 527, 528
- Marschall, on sugar fertilizers, 429
- Martin's, St., phosphate, 20
- Mediterranean, the, 8
- Mill, the roller, 93

- Mineral phosphates of lime, commercial valuation of, 491,
492
————— alumina, 3; standard for valuation
of, 494-495
————— commercial valuation of, 508
- Mixer, the, 115; mixing machines, 132
- Monte-jus, the, 125, 169, 372
- Morfit's "mother-liquor" as substitute for Alta Vela and
Redonda guanos, 398; comparative composition of
several precipitates, 400
——— table of the value of crude phosphates of lime, 498
——— table of the value of crude phosphates of alumina,
508
- Morris and Penny's ammonia process, 50-55
- Mother-liquor or wash and mode of reclaiming its mate-
rials, 197, 221, 277-287; its merits in sewage defeca-
tion, 223, 235, 243, 378, 398, 402-418
- Nassau phosphorite, 13
- Navasa guano or Cooperite, 25; analysis of by Morfit and
Gerland, 27; by Morfit, 31, 237
- New Jersey, 10
- New York, 10
- Nitrate of soda, 66
- Norway, 9, 10
- Ogston, analysis of Spanish phosphate, 30
- Oil of vitriol, 32, 321
- Orchila guano, 27; analysis of by Morfit, 31
- Organate of lime, 82
- Organic matter in phosphates, 90

- Pan, the evaporating, 131
- Paints, water and acid proof, 526
- Passive condition of certain mineral phosphates, 3
- Pearl-ash, 60
- Peat-charcoal, in the defecation of sewage, 396
- Penny and Morris's ammonia process, 50-55
- Peru, nitrate of soda from, 66
- Phosphate of ammonia, 41
- Phosphates, mineral, their wide diffusion in nature, 1 ; their constitution, 2 ; comparative solubility of, 28 ; must be finely powdered, 4 ; South Carolina, 20 ; analyses by Morfit and Gerland, 22, and Voelcker, 23 ; St. Martin's analysis by Voelcker, 20 ; French, 24 ; analysed by Voelcker, 25 ; organic matter in, 90 ; sand and silica, 91, 442 ; water, 91 ; South Carolina, 164, 166, 170, 202, 204, 208, 494 ; Colombian, 203
- Phosphates, super, manufacture of, 288, 298-302, 315-326 ; delusive analyses of, 325
- of alumina. *See* Alumina
- of lime, analytical tables of, 30, 31. *See* Lime
- of magnesia. *See* Magnesia
- of iron. *See* Iron
- of soda. *See* Soda
- Phosphorite, 2, 7 ; characteristics and sources of supply, 11 ; Welsh, 11 ; German, 12 ; analysis, 13 ; Russian and Austrian, 13 ; Spanish, 290 ; analysis of Russian, 14 ; and of Spanish, 30
- Phosphoric acid in sewage, 399 ; estimation of in mineral phosphates, 450
- Phosphorus, 226
- Pile, 514
- Pitch, stearic, 113, 231
- Plant, the, for manufacture of fertilizers, 108-146 ; arrangement of, 147-152 ; steam-boiler and engine, 109 ;

- roasting-furnace, 109 ; platform and accessories, 110 ; elevator, 111 ; lift, 112 ; acid reservoir, 113 ; mixer, 115 ; digester or solution vat, 117 ; syphon, 123 ; the monte-jus, 125 ; precipitation vat, 127 ; drying-kiln, 129 ; wash-vat, 130 ; evaporating-pan, 131 ; mixing-machines, 132 ; Carr's disintegrators, 133-146 ; Poole and Hunt's mixer, 145
- Plaster of Paris, 83
- Platform, the, and its accessories, 110
- Pockston on ammonia, 40
- Poole and Hunt, Baltimore, their mixer, 145
- Portland cement, 521
- Potassa, carbonate of, 60
—— sulphate of, 58, 282, 283, 284
- Potassium, chloride of, 59
- Potential, the application of the term in this treatise, 486, 499
- Pottery, phosphate of alumina as a glaze for, 418
- Precipitation, the, 171
- Process, Morfit's (A), 227 ; and (B), 238
- Profligate constituents of mineral phosphates, 493
- Purge, the, or first fractional digestion, 165
—— liquor, the, 199
- Ransome's artificial stone, 155, 221, 278
- Redonda guano, 50, 237, 246, 287, 360, 361, 362, 371, 374, 376, 379, 383, 385, 390, 395, 399, 400, 408 ; analysis of, 364, 466 ; treatment for manure, 365 ; P. Spence's treatment of, 379 ; also J. B. Spence and Dunn's, 383 ; Townsend's, 389 ; replaced by Morfit's "mother-liquor", 398 ; commercial valuation of, 508
- Reservoir, the acid, 113

- Reynoso introduces phosphate of alumina to sugar-refining, 416
- Roasting-furnace, the, 109
- Rock guanos erroneously classified, 360
- Roller-mill, the, 93
- Reaumur's thermometer, 519
- Root crops, fertilizers for, 430
- Rossa or Guaymas guano, 17, 30, 71
- Russian phosphorite, 13
-
- Sal ammoniac, 57
- Salt, table, 409, 410
- Salt of tartar, 60
- Salts, alkaline, estimation of in mineral phosphates, 457
- Saponifier, a ready, in aluminate of soda, 409; method of use, 413
- Saxony, 10
- Scherer, on ammonia in wool, 44
- Schwachofter, on Russian phosphorite, 14
- Selinite, 83
- Sewage, the natural means of fertilization, 1; a source of ammonia, 47, 406; suggested method of treatment, 47-49; phosphate of alumina for defecation of, 161; Morfit's "mother-water" an admirable precipitant of, 223, 237, 402-418; its utilization a paramount problem of hygiene and economics, 1, 393; analysis of precipitates by Morfit, 400
- of the Thames, 393
- Shoddy a source of ammonia, 53
- Siebenthal, B. de, 164
- Sifter, the, 95
- Silver, nitrate of, 220

- Soda, aluminate of, 409
— nitrate of, 66
— phosphate of, 48; as an economiser, 287
- Soda-lime, 51, 52
- Soil, elements of fertility in, 420; variety of fertilizers, 422
- Sombrero guano, 18; value first recognised by Morfit, 18; analyses by Voelcker, 18, Evans and Jones, 19, and Morfit, 31
- Sorél's cement, 523
- Spanish phosphorite, 290
- Spence, John Berger, 41; his patent for treatment of phosphate of alumina, 383, 385, 408
— Peter, his process for producing alum from phosphate of alumina, 379, 408
- Stassfurt, 59
- Steam-boiler and engine, 109
- Stearic pitch, 113, 231, 523
- Suffolk coprolites, 15
- Sugar, phosphate of alumina, use in manufacture of, 415; fertilizers for, 428
- Sugar-cane*, the, cited, 416
- Sulphite of calcium phosphate, 78
- Stone, artificial, 530
- Sulphite of tri-phosphate of lime, Gerland's, 338; method of manufacture, 346; its properties, 353; analysis, 356
- Sulphuric acid, its slovenly use in treating mineral phosphates, 4; constitution and manufacture of, 32; tables of specific gravity, 34, 35
- Superphosphate of lime, manufacture of, 288, 298, 315, 326; formula for analysis of, 469
- Sweden, 9
- Switzerland, 10
- Syphon, the, 123

-
- Thames sewage, 393
Thermometers, mode of using, 515
Townsend, Joseph, his conversion of Redonda guano into
 phosphate of soda, 287; his patent for treatment of
 phosphate of alumina, 389, 408
Turbines, 310
Twaddle's hydrometer, 515
- Universal dunger, 426
Ure, sulphuric acid table, 35; hydrochloric acid table, 38
- Vacuum filters, the, 171
Valuation of crude and refined fertilizing materials, 485
Vat, cast-iron, 232
Vat, the solution, 117; the precipitation, 127; the wash,
 130
Vats, the filter, 171
Venezuela, 27
Vitriol, oil of, 32, 321
Voelcker, Dr. Augustus, on apatite, 10; analysis of Ger-
 man phosphorite, 13; of Sombrero guano, 18; of St.
 Martin's phosphate, 20; of South Carolina phosphate,
 23; of French phosphate, 25; of Alta Vela guano,
 364; on soils and drainage, 431
- Wagner, 529
Wanklyn, analysis of Way's di-phosphate of lime, 247
Warrington on action of carbonate of lime, 80; on coagu-
 lation of alumina salts by hot water, 471
Wash-vat, the, 130

-
- Way, J. T., analysis of Cambridge coprolites, 31 ; his process for di-phosphate of lime, 227, 247-259 ; and for chloro-phosphate of lime, 263-276
- Welsh phosphorite, 11
- Whiting, 64
- Wicken coprolites, 16, 17, 494
- Williams, Charles P., on solubility of crude phosphates of lime, 28
- Williman's Island, 22
- Wool, as a source of ammonia, 44
- Woollen waste, 45
- Wright, on ammonia, 40

THE END.

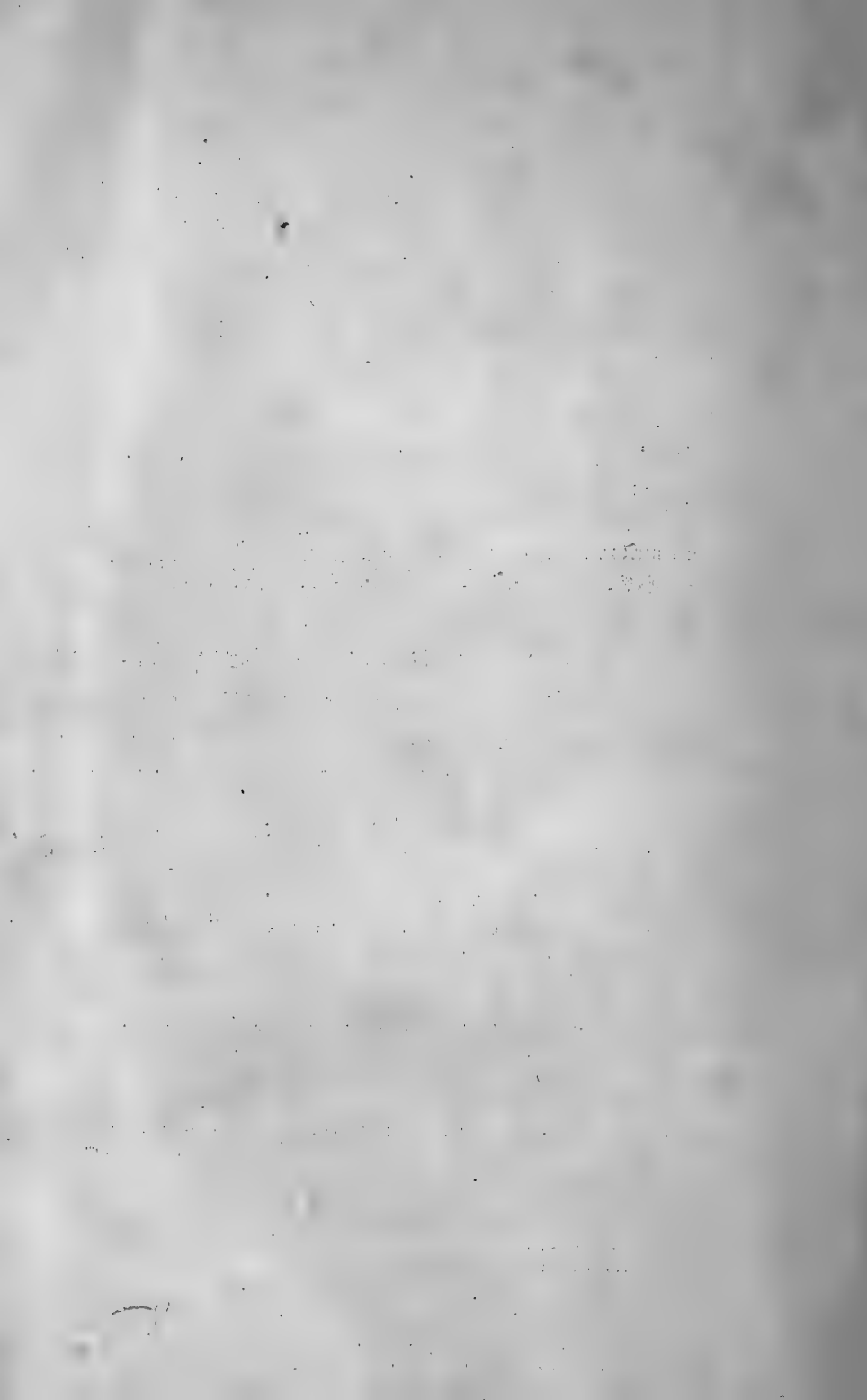





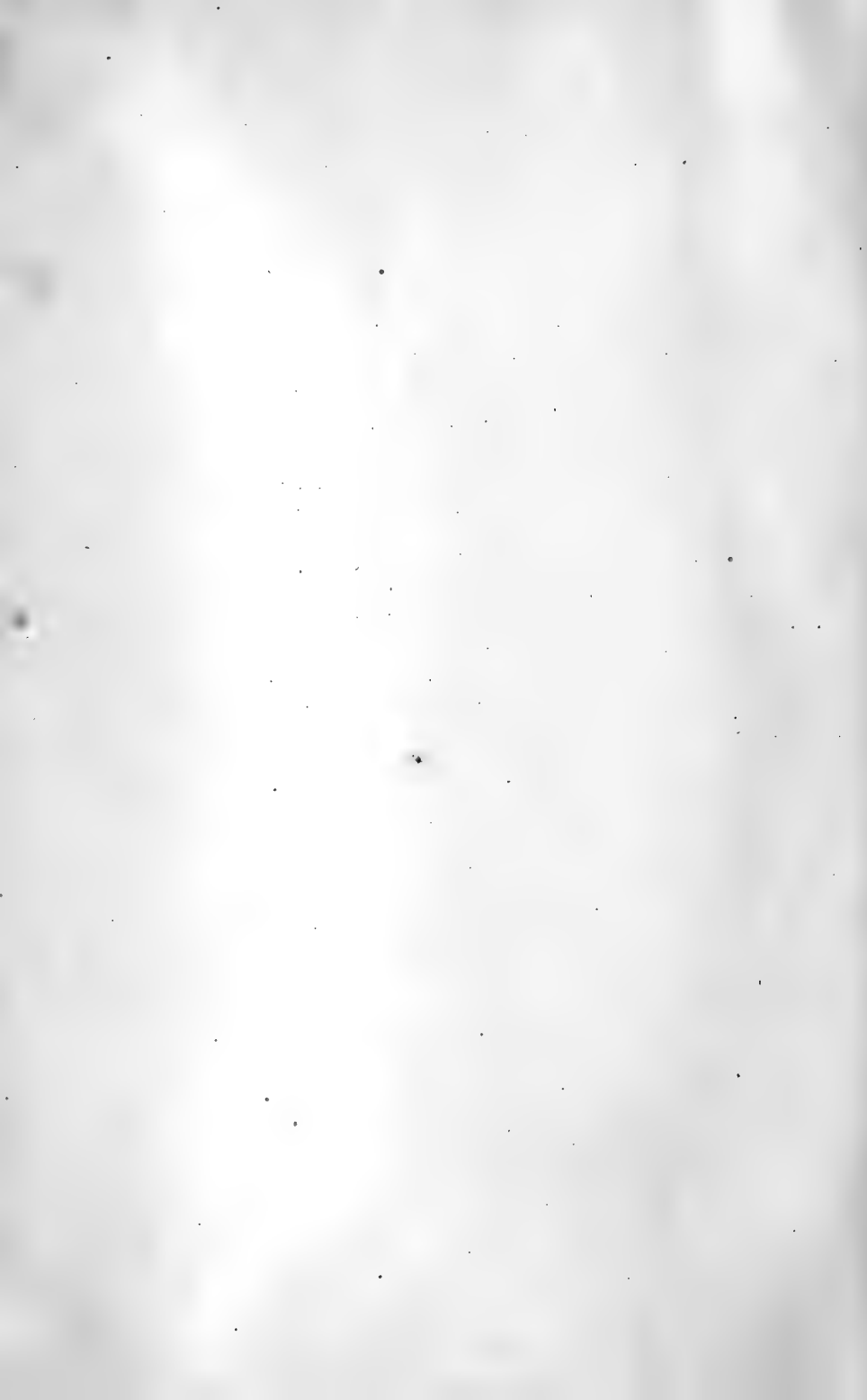





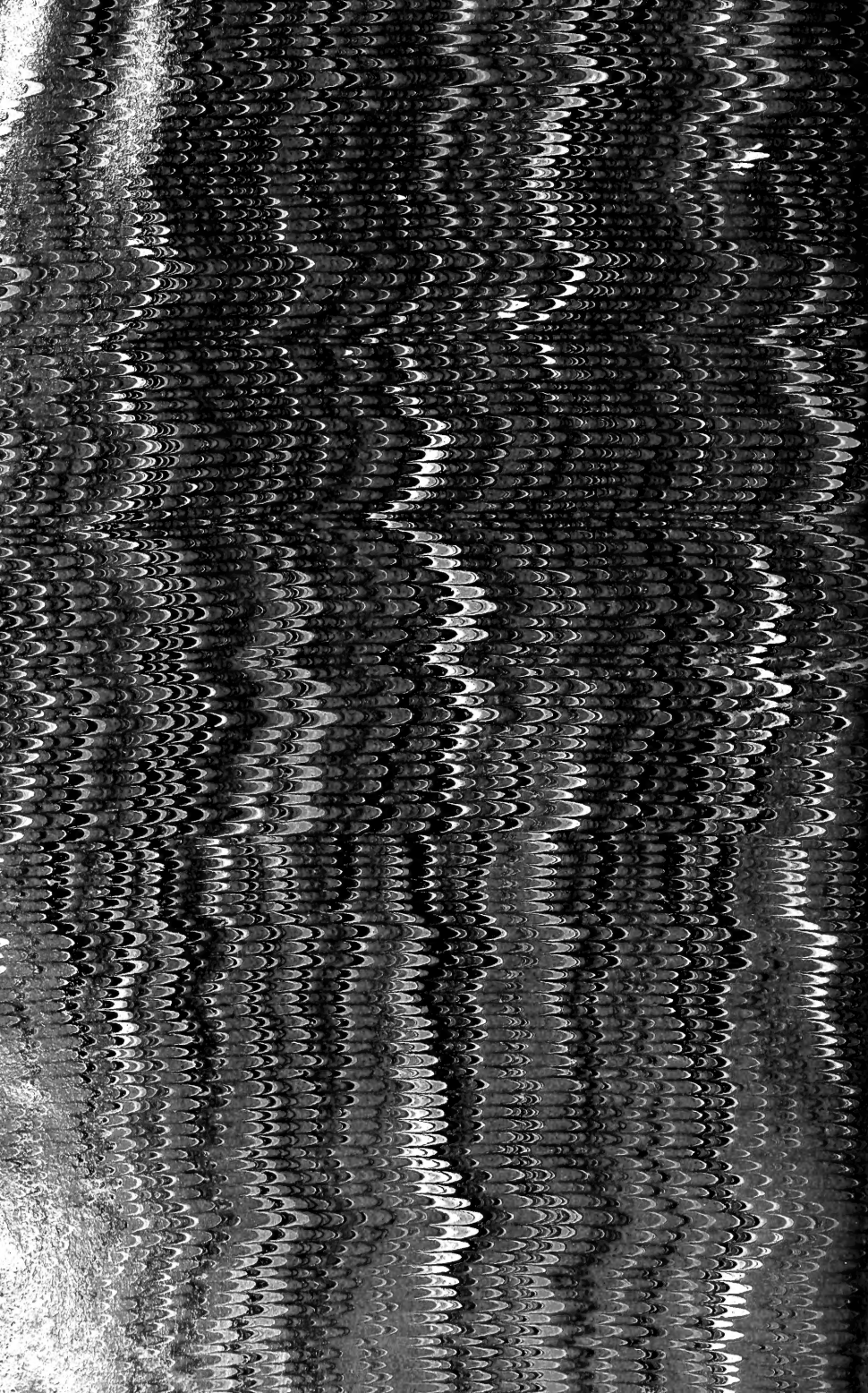

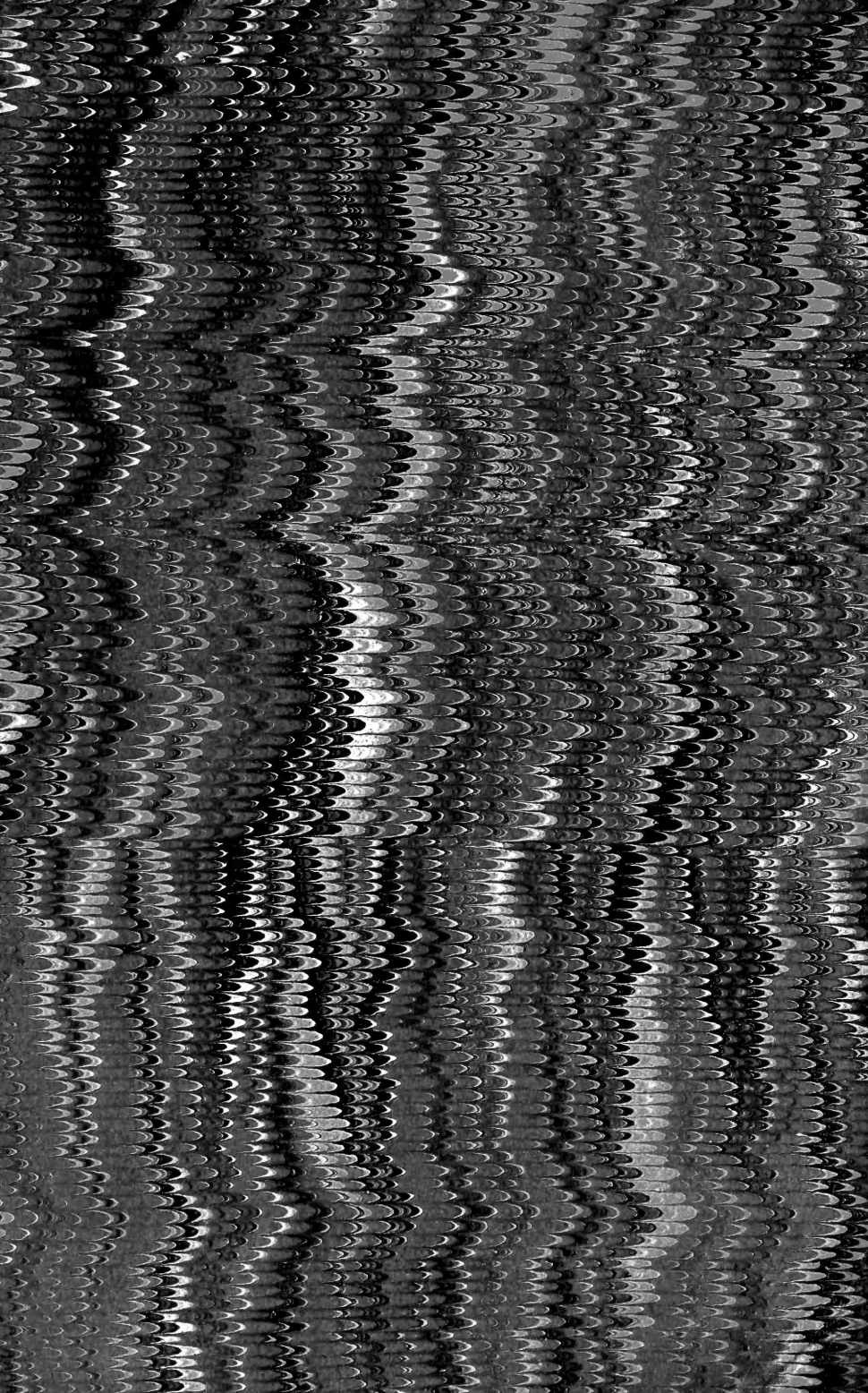

LIBRARY OF CONGRESS



00027557508 ●