

UC SOUTHERN REGIONAL LIBRARY FACILITY  
A  
0  
0  
1  
3  
7  
8  
7  
4  
4

A PRIMER OF ORGAN  
REGISTRATION  
—  
GORDON BALCH NEVIN

ornia  
al  
7





200



# A PRIMER OF ORGAN REGISTRATION





Digitized by the Internet Archive  
in 2007 with funding from  
Microsoft Corporation



CHAPEL OF THE INTERCESSION, NEW YORK  
(Austin Organ Co., Hartford)



# A PRIMER OF ORGAN REGISTRATION

BY

GORDON BALCH NEVIN

WITH

NUMEROUS ILLUSTRATIONS AND A  
DICTIONARY OF ORGAN STOPS



BOSTON  
OLIVER DITSON COMPANY

NEW YORK  
CHAS. H. DITSON & CO.

CHICAGO  
LYON & HEALY

*Copyright MCMXX*  
BY OLIVER DITSON COMPANY  
*International Copyright Secured*

## CONTENTS

PREFACE . . . . .	I
A BRIEF SURVEY OF THE SUBJECT . . . . .	III
CHAPTER I—First Steps in Registration . . . . .	1
CHAPTER II—Tone Classification and Pitch . . . . .	10
CHAPTER III—Registration of Exercises in Duct and Trio Form . . . . .	17
CHAPTER IV—Mass Registration; Tone Families . . . . .	21
CHAPTER V—Two-color and Solo Effects . . . . .	31
CHAPTER VI—The Use of Couplers . . . . .	38
CHAPTER VII—Choir, Solo Voice and Hymn Accompanying . . . . .	47
CHAPTER VIII—Some Practical Suggestions . . . . .	55
CHAPTER IX—The Crescendo Pedal . . . . .	65
CHAPTER X—A Glance at Organ Construction . . . . .	69
CHAPTER XI—Dictionary of Organ Stops . . . . .	83



# LIST OF ILLUSTRATIONS

## ORGAN FRONTS

	Page
CHAPEL OF THE INTERCESSION, New York . . . . .	Frontispiece
EMMANUEL CHURCH, BOSTON . . . . .	10
FIRST BAPTIST CHURCH, Pittsburgh . . . . .	17
FIRST CHURCH OF CHRIST SCIENTIST, THE, Boston . . . . .	21
ST. THOMAS' CHURCH, New York . . . . .	31
OLIVER HOLDEN'S ORGAN, <i>circa</i> 1790, Boston . . . . .	69
GREAT ORGAN IN MUSIC HALL, 1863, Boston . . . . .	73

## ORGAN CONSOLES

CONSOLE with stops arranged in tiers . . . . .	38
CONSOLE with stops arranged in jambs at 45° . . . . .	47
CONSOLE with inclined manuals and stop-keys . . . . .	55
CONSOLE with stops operated by tilting tablets . . . . .	65
PNEUMATIC COUPLER-STACK showing valves and tubing . . . . .	83

## FIGURES AND DIAGRAMS

ACTION, adjustable combination stop . . . . .	78
ACTION, electro-pneumatic . . . . .	76
ACTION, tracker . . . . .	71
ACTION, tubular-pneumatic . . . . .	74
BELLOWS AND FEEDERS . . . . .	70
CONSOLE, inefficient and efficient movements at the . . . . .	61
COUPLERS, four types of control of . . . . .	6
COUPLERS, analogy of electric light switches to . . . . .	39
PIPES, Clarabella, Clarinet, Diapason, Gedeckt and Gems- horn . . . . .	86
PIPES, Doppel Floete, section of . . . . .	81
PIPES, Oboe, Salicional, Trumpet and Vox Humana . . . . .	91
PIPES, various forms of . . . . .	12
PIPES, Viol, section of small scale . . . . .	81
REGISTRATION POSSIBILITIES for duets with an organ of six manual-stops . . . . .	18
RELATIONSHIP of clavier and organ proper . . . . .	2
SWELL-BOX, closed . . . . .	80
SWELL-BOX, partly open . . . . .	80



## PREFACE

In preparing this *Primer of Organ Registration* for the use of teachers and pupils, the author has been led in his work by the realization of two important facts: *first*, that the potential organist is greatly in need of help in grasping the principles of registration; *second*, that it is an utter physical impossibility to formulate *rules* which will be operative in enough cases to justify their own existence!

The first point is enlarged upon in the *Brief Survey* with which this work begins. A word on the second point may not be inappropriate.

The organ of today, wonderful instrument that it is, presents to the careful investigator a range of variability in design, equipment and tonal scope which is without even a remote parallel in other musical instruments. Not only do the voicing practices of various builders offer the widest dissimilarities but the various instruments of any one builder will abundantly show that anything approaching *standardization* is a dream for the future.

It is this very element of dissimilarity that faces him who would write a text-book on Organ Registration; he is dealing with a varying number of *quantities*—each and every one of which is *variable*. In this respect the problem is vastly more difficult than would be, for instance, the writing of a text-book on Orchestration. The Symphony Orchestra has become a reasonably well standardized aggregation of units; its size does not vary greatly (barring a few “tone-poem” productions emanating principally from Germanic sources) and its com-

## PREFACE

ponent units vary tonally only to the extent to which the human factor enters. Roughly speaking, the tonal factors may be said to be constant.

With the organ there are virtually no such things as constant factors; every organ presents new inter-relationships between the various units (stops) and it is folly supreme to attempt to reduce these irreconcilable factors to a system. *Until the organ becomes standardized to a reasonable extent the complete text-book on registration will be an anachronism.*

The author has therefore refrained from advocating definite combinations of stops for selected compositions, being well aware that such directions would have but slight value and then in only occasional circumstances.

Instead, the work has been developed along the modern principles of self-teaching, and aims, first and foremost, to awaken the dormant faculties of self-criticism in the potential organist and thus cause him to *desire* better effects and to search after them. The principles of quantitative investigating having stood several of our greatest inventors in good stead, it seems not improbable that a similar course may be constructive in the art under discussion.

August 1, 1919

THE AUTHOR



## A BRIEF SURVEY OF THE SUBJECT

The art of *registration*—that branch of organ technique pertaining to the use of the stops, couplers and accessories of the modern organ—is a subject of great importance in the development of fine organ playing, and must, indeed, be simultaneously pursued along with the usual mechanical practice if the desired perfection is to be finally achieved. Nevertheless, most teachers will freely admit that they find it a physical impossibility to include in the already over-crowded lesson period any *comprehensive* instruction in this branch of the art—for the simple reason that every available moment is required to cover with reasonable thoroughness the purely mechanical processes.

Organ students as a class, moreover, are peculiarly and noticeably ambitious to attain the material evidences of success—church positions and the emoluments attending such positions, and so are prone to desire a quick and early digital and pedal dexterity with which to impress the proletariat; granted such desire it cannot cause surprise that a branch of the art so esthetic in its nature often languishes in partial or even greater neglect.

As all teachers know and realize, to thus neglect this part of organ study is a great error—regrettable in the extreme, but the majority of teachers are honestly unable to see their way clear to remedy the matter, and so it is postponed—temporarily “shelved”—“until the technique has developed more,” with the inevitable result that faulty, stereotyped methods are acquired; this must be the expected result unless from the very first the student’s mind is directed to new paths of endeavor.

To wilfully neglect the study of registration is as absurd as would be the course of one studying to become an orchestral conductor who would content himself with a knowledge of the compass of the various instruments, together with the purely metronomic phases of his art—time, rhythm, accent, etc., and were to disregard the elements of tone, *timbre*, relative strength and blending properties of the tones which he would utilize. It would seem ridiculous for an embryo conductor to so pursue his study, but not a bit more so than for the organ student to follow a course which parallels it in all its unfortunate elements. Each is a worker in tones—a *tonal artist*, and each must be possessor of well trained, keen perception, nice discrimination, and well ordered imagination, schooled to select and blend with exquisite taste.

This book has been undertaken with a full knowledge of the existence of these conditions and a desire to furnish some aid to busy and earnest teachers and pupils; no attempt has been made to exhaust the possibilities of the subject, for such a course would have defeated the aim of the book, *viz.*: to be a compact and brief but easily understood aid—pointing the way to a systematic progress in the study of the art. The work has been cast in such form as to be progressive along with the work mapped-out by the teacher; *from the very first lesson* the student is aided in comprehending what always appears to be a maze of stops and accessories.

The *Dictionary of Stops*, with which the work concludes, has been made “inter-locking,” so to speak, in as far as was possible, and presents a refuge to the bewildered pupil who—unable to find a desired stop needed in some composition—helplessly asks: “What stop shall I use instead?” Presenting with each stop treated a list of possible substitutes which may be used, the pupil is enabled not only to proceed with his practice uninterrupted, but by frequent turning to the dictionary, he acquires a working knowledge of the names of stops,

and—more important—by using the substitutes suggested gains some idea of the tone of the stop wished for *by the use of the nearest substitute for it*, thus becoming in a measure prepared in advance as to the quality of tone which may be expected in the desired stop itself; this is a very elementary principle, but a well-tested one.

Nothing is advocated herein which has not been well tried in the furnace of practical teaching experience; much of the work is the outgrowth of ideas which have originated during actual teaching, and the other ideas—those formulated away from the studio—have first been well and thoroughly tested before being set down here. It is the author's hope that the book may be of aid to his colleagues, and of help to the army of students—the earnest pupils who make teaching worth while.



# *A PRIMER OF ORGAN REGISTRATION*

## CHAPTER I

### FIRST STEPS IN REGISTRATION

You have had your first lesson in organ playing; very likely it was taken at the instrument over which your teacher presides, and the problem now before you is to begin work on the instrument on which your practising will be done.

Among other things your teacher has doubtless explained to you that the keyboards on which the hands perform are correctly termed *Manuals*, you should immediately commence using the correct terms when speaking of the different parts of the organ, and so should always refer—when speaking of the actual *claviers*—to the Swell *Manual*, the Great *Manual*, as the case may be, thus differentiating the clavier from the portion of the organ which it controls.

You have doubtless expressed curiosity as to the reason for the multiplicity of these manuals (from two to four being commonly found, and occasionally even five) and have been told that the varying number of manuals is made necessary by the great elasticity in size of the organ, and that the increase of size so prevalent to-day has made imperative more keyboards for the easy and *facile* handling of these monsters. Authorities differ as to the exact number of stops which should be appor-tioned to a particular section of the organ, but it is pretty generally accepted that two manuals are sufficient

for an organ of about twenty-five stops, and that a larger number of stops would best be distributed upon three manuals; similarly that above forty or forty-five stops it is well to provide four manuals for the convenience of the player. Rapid changes of tone-color or

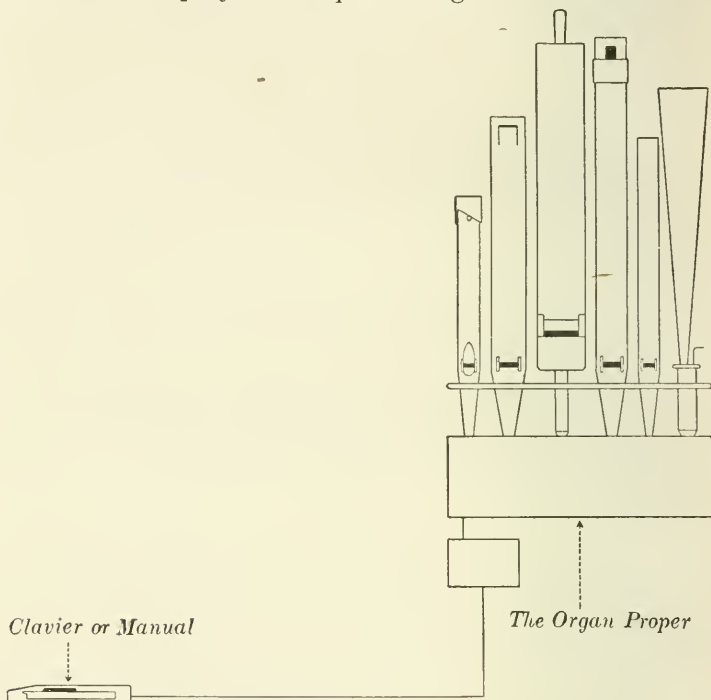

FIG. 1. RELATIONSHIP OF CLAVIER AND ORGAN PROPER

power, the necessity for quick and easy access to "solo stops," these and similar considerations account for the varying number of manuals found in organs today.

As a step in comprehending the organ as a whole, the author would advise that you persuade your teacher or some organ expert to show you the internal mechanism of an organ and explain the general operation of the same; the organ of today is such a vast and bewildering

piece of mechanism, the operation of the action is now so silent and unobtrusive, and the whole construction so mystifying to the uninitiated that a visit to the internal departments cannot help but be enlightening—particularly if the operation is explained step by step by an expert. In this way you will gain some understanding of the results following upon varying processes at the console, and at the same time a wholesome respect for the minds that fabricate such marvelous pieces of mechanism and no less a respect for those who cause it to speak forth its inspiring harmonies; moreover you will be more inclined to handle it with the respect and care that it deserves. Do not, however, go exploring by yourself—lest it require the services of an expert to right matters after you are through!

Some book of progressive technical material, frequently but incorrectly called a “method,” has undoubtedly been designated for you to use in commencing your work—such an one most likely as *The Organ* by Sir John Stainer (edited and enlarged by James H. Rogers), and you have been assigned a certain amount of work to prepare. Your next problem is to discover “what stops to use” in beginning your work, and with that problem will begin your initiation into the mysteries of registration.

Here at the very start we will diverge from the usual cut-and-dried formulæ, and show you how by use of simple common-sense principles you will be able to quickly grasp the essence of the matter, and at the same time begin without loss of time upon your technical work—gaining familiarity with the different stops as you go along.

Seat yourself at the console of the organ at which your studying will be done and turn to your book of exercises; the first thing you will take up will undoubtedly be the rudiments of pedal technic—or as it is crudely put—“playing with the feet!” In *The Organ*, these exer-



cises are found on page 37, headed: "Exercises for Finding Pedal-Keys without Looking at the Feet"; now how will you proceed? A moment ago we spoke of the varying number of manuals provided for the control of the organ; each of these manuals is provided with its own set of stops for the controlling of the section of the organ to which it appertains; this being the case, and with the point firmly in mind that *the organ as a whole is composed of a varying number of smaller organs—each complete in itself*, though inter-related, would it not be reasonable to suppose that there would be stops provided *controlling that portion of the organ appertaining to the pedal clavier?* This, in fact, is exactly what you *will* find to be the case, and so we will direct you to look over the stops carefully and see if you cannot find some of them with the abbreviation *Ped.* inscribed on them, or perhaps a group of stops with no such inscription, but grouped under one common name-plate with the word *Pedal* thereon. There may be but a few stops so designated,—indeed on the very smallest organs there may be but one such stop! But do not let that alarm you; the problem is not one of resources but rather of utilization of resources.

Having located the Pedal Stops now search for a stop labeled *Bourdon—16'* or *Subbass—16 ft.* Having found the stop, draw it and then try out the quality of the tone by playing a few notes in different portions of the pedal-board, listening to the quality of the tone, taking note of the amount of volume, and striving to *fix in the memory* a picture of *the tone* of the stop.

If there be other pedal stops, draw them in *rotation*, testing them out in the same way in all parts of the pedal-board, and comparing each stop with its neighbors; do this several times over, and while doing it strive to associate the name of the stop with the quality of tone produced when it is drawn, and *vice versa*.

You will discover that a majority of the stops, perhaps



even all of them, are of 16 ft. pitch — so marked; in the next chapter we shall go into matters of pitch a little more carefully, but at present it will be sufficient if you take careful cognizance of the fact that these stops are (particularly in the lower octave) of a very deep tone—somewhat hard to recognize accurately as to pitch, and it may occur to you that there must be some way of *adding* to these stops other stops of more easily recognizable pitch. Your glance falls on the manuals and you think of the bright, clear tones which you have heard issue from those parts of the organ, and you wonder if there is not some way of combining or *coupling* these higher pitches with the grave tones of the pedal organ. And in that one word *Couple* you have the key to the situation; a *coupler* is what is needed to achieve the desired end. Look over the console for a *coupler*; it may be in the form of a stop, a stop-key, a domino-tablet, or a piston (see Fig. 2) with the inscription: *Sw. to Ped.* (Swell to Pedal)

You have it? If it is a stop, draw it; if a stop-key, press it down; if a domino-tablet, press in at the bottom; if a piston—there will be an *on* and an *off* piston—press the *on* piston. You have now effected a mechanical connection which will permit you to play from the pedal-clavier, or *pedal-board* as it is generally called, that section or unit of the organ primarily commanded by the Swell manual. It now remains but to draw a suitable stop or stops from the Swell organ (with which your connection is made) to furnish the brightening effect, and you are ready to proceed with your practice of the pedal exercises.

However, delay for a moment your work on these studies, and devote a brief space of time to familiarizing yourself with the stops of the *Swell* section—in just the same way as you did with the *Pedal* stops a moment ago. Proceed in the same manner; first locate the stops, either under a common name-plate, or each with the

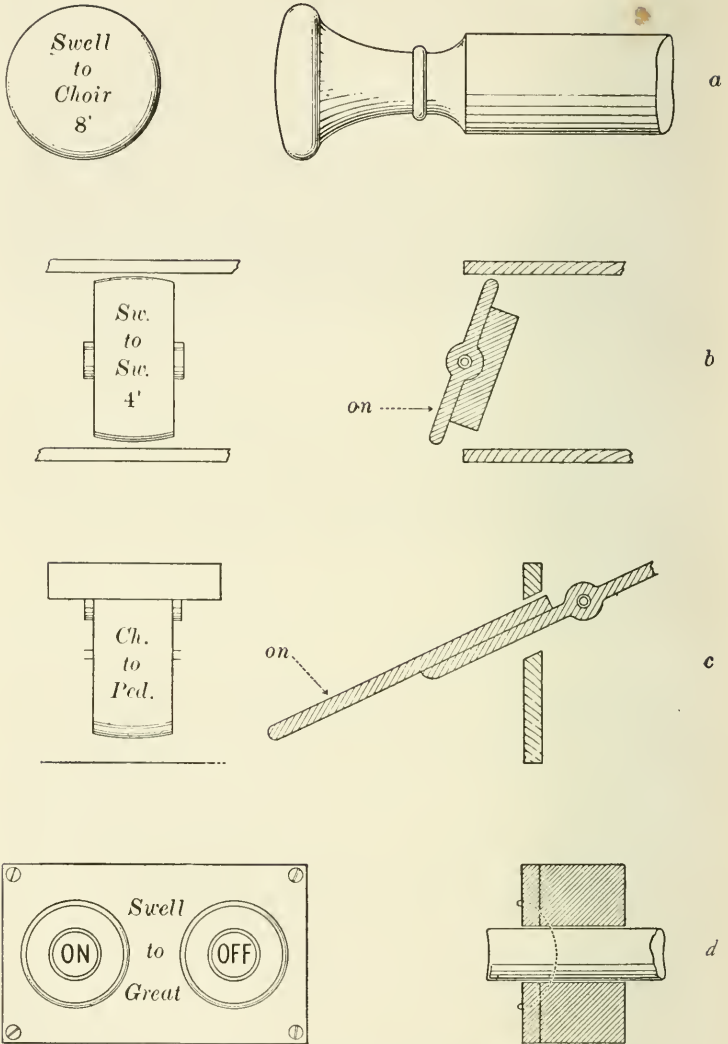
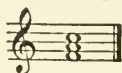

FIG. 2. THE FOUR TYPES OF COUPLER CONTROL  
*a*, Stop; *b*, Tablet; *c*, Stop-Key; *d*, Piston

common abbreviation *Sw.* engraved upon it. Then, having located the stops, submit them to a thorough testing out, holding a common chord in the middle portion of the clavier (See Fig. 3) and drawing the stops in rotation, holding each a moment and *striving to associate the tone which you hear with the name on the stop.* Go over these stops several times in the same manner as



thing which will make an audible noise—and with that one combination is content to let the matter of registration rest. How much better is a plan, simple it is true, which takes for its prime principle that of seeking variety from the very start! And this is what we are urging upon you.

And now let us carry the idea to its logical conclusion: on the second day of your practice begin changing the stops a little more frequently—let us say in the middle of the assignment as well as at the end of each repetition. The next day, increase the frequency a little more until, at the end of a week, you are changing stops with each exercise.

Having done this, transfer your attention to another manual, using next the *Great*; with this transference of attention, your need of the *Swell to Pedal* coupler will temporarily vanish, but a similar need for a coupler rendering available the *Great* stops on the *Pedal Clavier* will arise, and you will of course find the *Gt. to Ped.* coupler and bring it into play, silencing at the same time the *Sw. to Ped.* coupler which you have been using. Proceed with the *Great* stops in the same way, and do not be in too much of a hurry with it! Stick to single stops for the present; it will be less confusing, you will gain a better knowledge of their individualities, and you will have ample opportunity for experimentation with them in combinations at a later time. Pursue this method with reasonable thoroughness and you will soon notice that your hand seeks the stops with a degree of facility and that you are beginning to know what to expect when you draw any given stop; this is an indication that without undue effort on your part you are absorbing the rudiments of tone-color—a knowledge that you can acquire in no other way than by some system that has as its basis repetition and comparison, and which is made available for you in this very easy form.

In connection with this work you may be given exercises leading to the formation of a correct manual touch; in *The Organ* by Stainer, edited by Rogers, this matter comprises pages 43 to 47 inc. With these, too, proceed in a similar manner, using *single* stops, changing them frequently and concentrating your attention on *hearing* what the tones really sound like. A word of caution: avoid for the present stops of 16 ft. pitch, also *Mixture* stops (3-rank *Cornet*, 4-rank *Mixture*, etc.) and very powerful stops of the *Trumpet* and *Tuba* type; this caution is given because these stops are not suitable for protracted use in such exercises as you are using at this early stage. It is also well to avoid stops of 2 ft. and 2 and 2-3rds ft. pitch for use in these exercises, their pitch being so high.

In the next chapter matters of pitch will be taken up, but for some little time you should confine yourself to a thorough working-out and study of the prime stops as suggested above; this work requires several weeks at least, and should not be slighted. The study of prime tones is the rock foundation of a sure technic of registration; its value cannot be over-estimated.

## CHAPTER II

### TONE CLASSIFICATION AND PITCH

During the investigations outlined in the first chapter you have discovered that the stops command tones of varying quality, volume and pitch; we shall in this chapter show you how the apparently numberless characteristics of the stops may be very easily reduced to groups and classified with ease.

Let us first consider the question of pitch. As we noted in the preceding chapter, there are to be found on the stop-knobs numerals denoting the pitch-length of the respective stops, viz.: 16 ft., 8 ft., 4 ft., and 2 ft., together with these other designations: 3 rank, 4 rank, etc. The former relate to the pitch-length of the stop in question, the latter to the number of ranks of pipes present in the particular stop under consideration.

In the first class mentioned in the preceding paragraph, the numerals indicate the theoretical (and rather arbitrary) measurement of the tone-length of the pipe producing the lowest note of the particular stop (*CC* on the manuals and *CCC* on the pedals). Note that this length is only expressed with approximate accuracy, and is not by any means a mathematical statement of the length; there are countless variations from the denoted length due to different methods of construction in the different pipes, and also the employment of various wind-pressures and styles of voicing. These all have their effect on the exact length of the tone-wave, but as we are considering these matters from a viewpoint in which questions of physics and science have little place it will be sufficient for you to remember that the figures denote



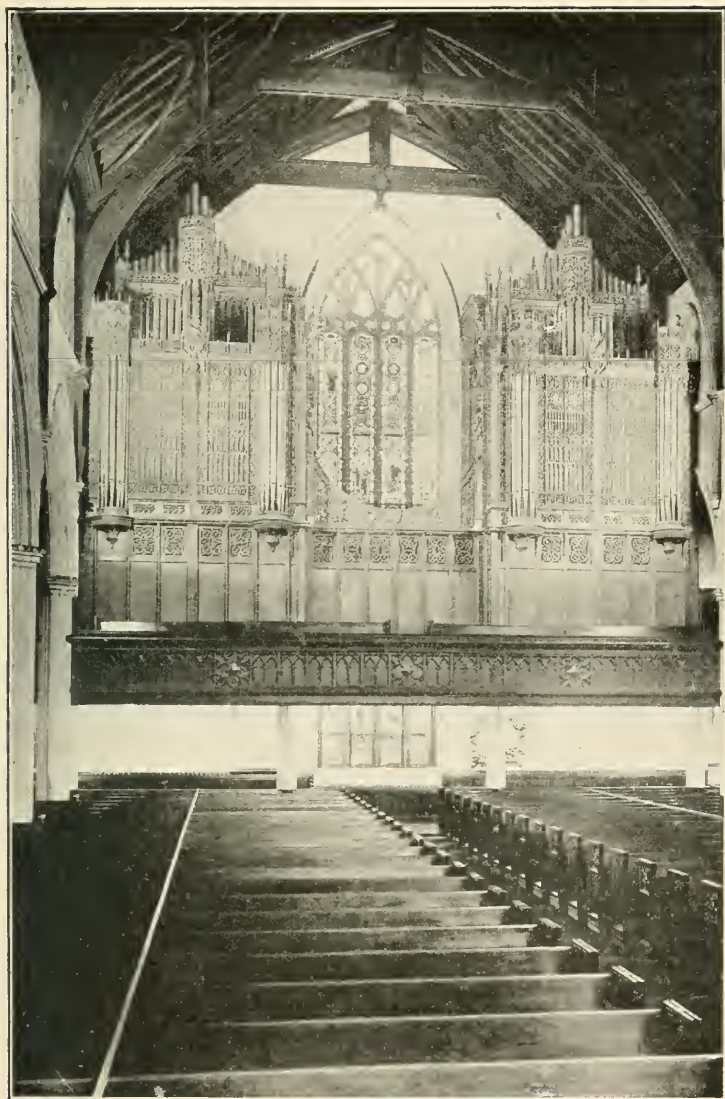

EMMANUEL CHURCH, BOSTON.  
(Casavant Frères, St. Hyacinth, Quebec)





the *approximate tone-length of the lowest pipe in the particular stop under consideration.*

With regard to the second class of nomenclature referred to above, a word of explanation is advisable. In the earlier days of organ building it was discovered that an organ composed entirely of stops of normal (8 ft.) pitch was incapable of producing effects of any degree of brilliancy; this, as is now known, was the result of the very low wind pressures employed—which wind pressures made it impossible to develop from the pipes then in use an adequate degree of harmonic brilliancy. The tones achieved were sweet, mellow and pleasing most assuredly, but a full organ composed of them was dull and lacked “fire” and incisiveness; to remedy this condition was adopted the expedient of including stops speaking the octave above the normal pitch. This was found to be a great step forward and, very naturally, the plan was extended and stops of two octaves above normal pitch were included. From this start it naturally came about that the builders soon included stops speaking a twelfth (octave and fifth) above unison, and later other stops producing tones found necessary by the scientific analysis of the production of *tone-harmonics* generated (in a greater or lesser degree) by a prime tone and necessary to its usefulness. Prime tone devoid of any harmonic development (were such tone possible to produce) would be entirely useless, for it is the presence of these harmonics or overtones—in varying degrees in different tones—which gives the distinguishing characteristics to the tones. *Mixture* stops therefore were adopted as a means of supplying artificially certain of the harmonics needed to give character and brilliancy to the tone; but like most excellent things they were much abused and over-done, and are today looked upon with disfavor in many quarters. Nevertheless, they have their sphere of usefulness, and when well made and properly voiced they add much of richness to the tone of the organ.

This function of stops of other than unison (or below unison) pitch can be easily demonstrated by the pupil himself, and will greatly assist in clearing away a point of mystery which troubles many organ players as well as pupils; we will ask you to seat yourself at the organ and with your own ears as jury, test the case in this simple manner: draw all the stops of 8 ft. pitch on both the Swell and the Great, couple the Swell to the Great,

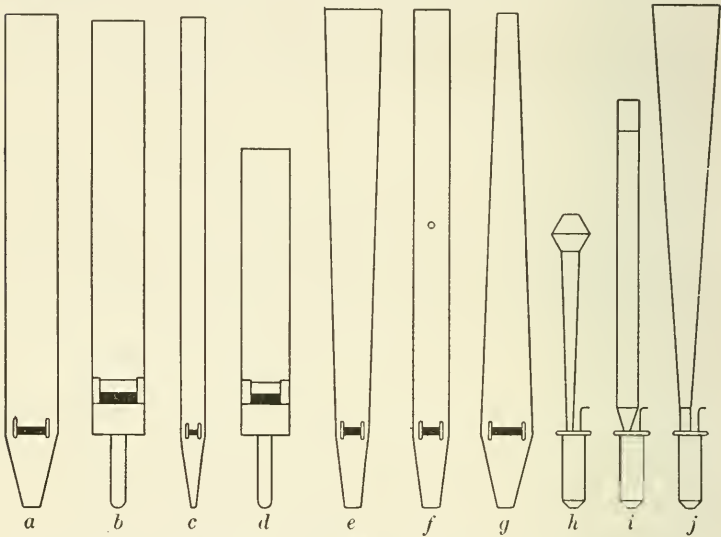

FIG. 4. VARIOUS FORMS OF ORGAN PIPES

*a*, Diapason; *b*, Clarabella; *c*, Viol; *d*, Gedeckt; *e*, Dolce; *f*, Harmonic Flute; *g*, Gemshorn; *h*, Cor Anglais; *i*, Clarinet; *j*, Trumpet.

and play through on the Great some simple hymn, chorale, or similar piece of music, listening carefully to the resulting effect. Immediately after this, add all the stops of 4 ft., 2 and 2/3rds ft., 2 ft., and Mixtures (*Cornet, Furniture, Sesquialtera*, etc.,) if they be present, and again play through the same selection used a moment ago; do not your ears tell you why we have these stops of higher pitch in organs? Do you not see that

without these elements of clear pitch definition, so clarifying in their effect, the organ would be a monstrosity?

In like manner can be explained the presence of stops speaking an octave below unison pitch (16 ft. pitch for the manuals)—for these stops furnish the element of support necessary, particularly in organs of medium or larger size, to prevent a *top-heavy* or “screamy” effect. It is this fact which accounts for the inclusion in all large specifications of stops of 32 ft. pitch on the Pedal Organ—the grand, majestic, rolling effect of such stops being one of the prime features which have caused the organ to be called the “King of Instruments.” Especially in the happy balance of these two classes of stops is the hand of a Master Builder shown.

From these questions we pass on to consideration of tone qualities; here we have a complex matter, but one which may be denuded of many of its difficulties by gathering together for consideration the various stops and arranging them in four principal groups, or “tone-families.” Subdivisions of these groups would, from a technical standpoint, be desirable, but for this first step we will omit such division and will arbitrarily arrange the stops in the four main divisions into which they easily resolve themselves.

These divisions are:

1. Diapason, or organ foundation tone.
2. Flute tone, including *Gedeckt* tone.
3. String tone, including *Gamba* tone.
4. Reed tone, both *Clarinet* and *Trumpet* tone.

Continuing along the lines indicated in the first chapter, we will now ask you to seat yourself at the console, having provided yourself with a sheet of paper ruled with vertical lines dividing it into *four* columns; at the top of the sheet place in order the names of the tonal divisions as given above, and you are ready to begin your investigating.

The process will be simple and will reduce itself to an orderly working over or trying-out of the stops, drawing them—*one at a time*, playing a few notes or chords on each one, *listening* to each tone carefully and then trying to decide into which of the groups its peculiarities will entitle it to fall. We will suppose that you have drawn, for instance, the *Swell Open Diapason*; with this stop you will have not a bit of difficulty; with its name as a guide, and with its tone so characteristic of the organ, you will immediately assign it to column one.

Next we will suppose may come a *Flute* of 4 ft. pitch; the name of this, too, will guide you, and the tone—clear, liquid and vividly imitative of its orchestral prototype will serve to place this stop in its proper class without further consideration. Get these two stops firmly fixed in mind and make a mental note of their tone colors so that with the consideration of another stop of the same families there will be no doubt as to which is its kin.

And now for one not quite so easy! The *Oboe*; what family will this stop claim? Well, perhaps this can be best answered by comparison and gradual elimination; you are certain, of course, that it cannot belong to either the *Diapason* or the *Flute* family, for you have compared the *Oboe* with representatives of these two families. It must then belong to either the String or the Reed family; now which one presents the logical claim? Possibly a mental reference to the instruments of the orchestra may help at this point, for you must realize that the modern organ has many stops whose tone is patterned after orchestral prototypes and whose faithfulness of delineation is frequently little short of the incredible.

First think of the instruments of the string band: violin, viola, violoncello, double-bass; does it seem likely that this tone under consideration can be analogous to that of any of these instruments? Is there any “resin” in the tone, such as is common to all bowed instruments? Does not the tone suggest, by its name, of course, but

equally by its tone "acid-sweet and cloying" a kinship to the wood-wind band, and if so, will it not at once fall under the classification of *reed* instruments and, in our distribution, of *reed stops*? And this is, quite correctly, its place.

Finally will present itself some such stop as the *Salicional* or *Viol d'Orchestre*, and with it you will have come to the last of the divisions (the *third* column, however) and the family of stops which undertakes the imitation of the string band of the orchestra. It must be admitted, at the outset, that the exercise of not a little imagination is often needed to see the analogy between the string stops and their orchestral prototypes, but, as a rule, in at least some portion of their compass (most often in the lower octaves) a considerable likeness may be discerned, while in many modern examples the faithfulness of imitation is absolutely startling.

You now have found one specimen of each of the tone families indicated on your chart; proceed at once with all the remaining stops of your organ in the same manner using as tests those stops already assigned to their places and by comparison deciding upon the place of each of the other stops. A word of caution may be given: do not let the *name* of such a stop as the *Stopped Diapason* (truly a misnomer) deceive you; rather let its *quality of tone*—so very different from that of the real Diapason family—tell you in which class to place it. Decide by tone, rather than by name!

When you have run through the whole gamut of stops at your disposal, *then—and only then*—turn to the Dictionary of Stops in the back of this book, and compare your findings with the definitions of the stops there given, check up your errors and note where your judgment was wrong. Finally, at the organ, go over the table of stops, noting where the stops should correctly be placed and where your untrained ear led you astray.

As a commentary on this work and finally to fix the

correct grouping of the stops in your memory, go over at the console the families of stops of like tone, each list by itself, endeavoring to fix in the memory the stops of each tone division, and so to train the memory that the mere act of thinking of any stop name will at once call to mind the quality of tone commanded by that stop. Thus a reciprocal training will be achieved:—the mind to recognize and classify any tone heard, and the imagination to form a mental picture of the tone which will be heard when a given stop is drawn. This will not be accomplished in a day, but by firm concentration the time necessary will be reduced to the minimum and the desired mastery attained; in this respect all details of organ study are alike.





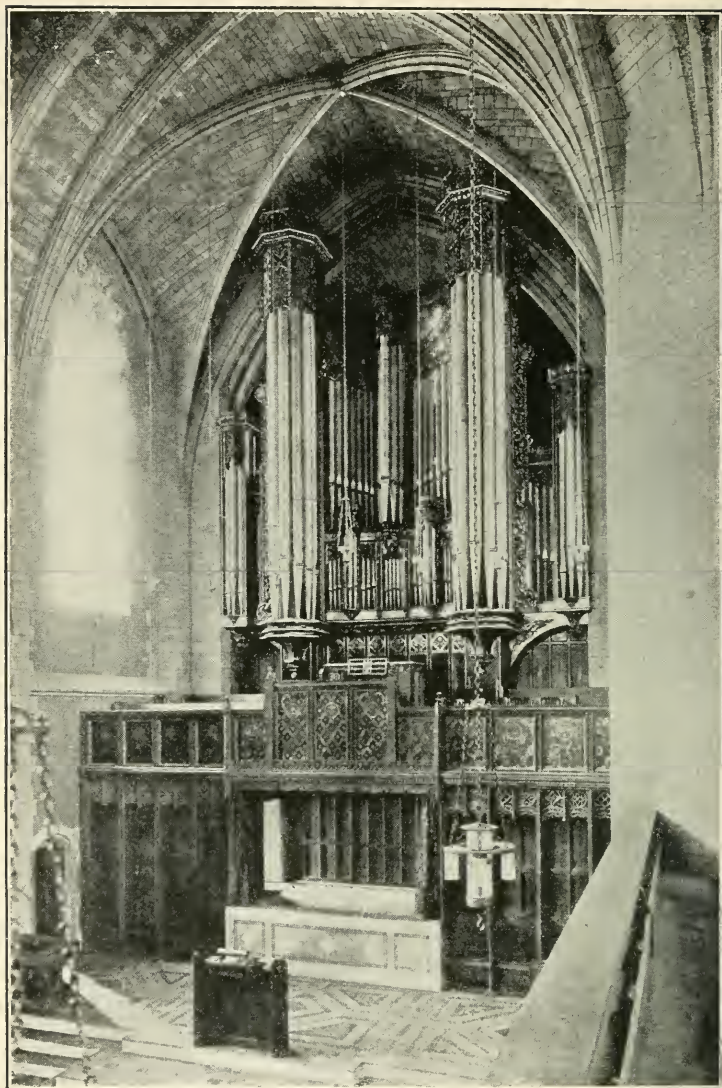

FIRST BAPTIST CHURCH, PITTSBURGH, PA.  
(M. P. Möller, Hagerstown, Md.)



## CHAPTER III

### REGISTRATION OF EXERCISES IN DUET AND TRIO FORM

Having mastered the simple manual and pedal exercises discussed in the first two chapters you will be introduced next to duets or two-part exercises between the hands (alternately) and the pedals—"Scale Passages for Alternate Toes"—*The Organ*, pages 49-52 inclusive, the purpose of these being to cultivate independence of motion between the hands and feet. During the study of these exercises you will have opportunity further to progress in your acquaintance with tone colors.

In taking up these duets the method of procedure should be similar to that adopted for the work already done: first couple one of the manuals to the pedals, the Great—let us say; draw now on the Great some stop of medium strength of tone—such as the *Gamba*, *Melodia*, or *Second Diapason*. To this add a pedal stop of not too strong tone—the *Bourdon 16 ft.*, in all probability, and consider this as your fixed tone for the bass for a little while.

Now against this fixed bass, you are to select in rotation the various stops of medium strength tone of the Swell organ, as the tones for the other voice of the duet; first, the *Open Diapason*, then the *Salicional*, then the *Oboe*, etc., changing the stops with each exercise as at first. In this way you will absorb the elementary principles of blending and contrast—and in this the work is the logical expansion of that done in the preceding chapters.

Extend the principle to its fullest ramifications,

changing the combination selected for the bass voice of the duet, and again going through the exercises with the change of registration for the upper voice with each new exercise. Finally, try your hand at combining some of the soft 8 ft. and 4 ft. stops to form the combination for the treble voice of the duct, such combinations as the *Salicional* and *Flute*, *Gedeckt* and *Flute*, etc.

Having exhausted the possibilities of the Swell stops as directed above, reverse the arrangement and couple the *Swell* to the Pedals, now playing the manual part of the duet on the *Great*—varying the stops of this manual

	<u>Swell</u>			<u>Great</u>			<u>Swell</u>			<u>Great</u>			
	Sal.	Ged.	Flute	Dul.	Mel.	Flute	Sal.	Ged.	Flute	Dul.	Mel.	Flute	
1	○						○						10
2		○					○				○		11
3			○				○					○	12
4	○				○			○			○		13
5		○			○			○			○		14
6			○		○			○				○	15
7	○					○			○			○	16
8		○				○			○			○	17
9			○			○			○			○	18

FIG. 5. REGISTRATION POSSIBILITIES FOR DUETS WITH AN ORGAN OF SIX MANUAL STOPS

in exactly the same way as before, and finally trying a few combinations of 8 ft. and 4 ft. stops before going further. Countless changes of effect and contrasting shades of tone are thus introduced to the ear, and the resulting *ear-training* is of the greatest value. Before leaving this work it will be well to make use—though sparingly—of some of the more powerful stops—the *Great Open Diapason*, *Swell Cornopean*, and the heavier Pedal stops—16 ft. *Open Diapason*, etc., using these stops only during short spaces of time—an admonition which is equally applicable at all stages of progress.

When you have covered this duet work to your teacher's satisfaction you will pass on to the study of trios employing simultaneously *both* hands and the feet; pages 56 to 59 inc., *The Organ*—headed: "Easy Exercises for Producing Independence of Hands and Feet."

Should you be so fortunate as to have the use of a *three*-manual organ for your practice, the logical thing, of course, will be to couple one of the manuals to the pedals, reserving for each of the hands one of the other two manuals not so coupled, thus giving free scope for changes of tone in all three parts of the trios. But if, as is more likely, the organ is a *two*-manual instrument you probably will be compelled to limit yourself to but two distinct qualities of tone, coupling one of the manuals to the pedals for the purpose of rendering the pedal notes easily distinguishable. *Note carefully*, however, that this direction does not retain its force should your organ be equipped (as should all organs, large or small) with a clear incisive stop of 8 ft. pitch such as the *Violoncello*; the possession of such a stop will render the pedal part quite clear and decisive, and no resort to coupling will be necessary. Unfortunately, stops of this character are omitted from the pedal resources of many medium size organs and practically *all* small organs, so that in a great majority of cases coupling is imperative; commercial exigencies of the day dictate the specifications of all too many organs so that in countless cases the result is a collection of solo stops—attractive in themselves no doubt, but included by the sacrifice of vitally needed foundation work.

In these trios the course to follow will, logically, be an expansion of the work done on the duets; vary the stops first on one manual, then on the other, and—if it be possible—finally on the pedals; try to approach the maximum number of effects possible. Given even a dozen stops the mathematical possibilities of re-arrangement are astounding; let your endeavor be (as

nearly as possible) to exhaust these possibilities before going further in the work.

Quite possibly your studies may at about this point be amplified by excursions into one of a number of books of rather more advanced studies in trio form, and in them you will find a splendid field for cultivating tonal control; in most of them slight registrative directions are given which will furnish the clue to the general effect desired by the composer. First follow these directions as closely as possible, and later seek to vary them considerably—still not altering the basic intention; you will learn much from this experimentation and derive not a little pleasure therefrom. Use different gradations of power, of contrast, of quality, and above all strive to really *hear* what you are doing, for in the degree of accuracy with which you hear may be said to be written the degree of proficiency which you will attain as a tonal artist. The countless throngs of organ students (and organists) who plod along, year after year, using the same limited, unbalanced, raw, tiresome combinations are a pathetic but arresting indication of the fact that the average untrained person is not developed to the point of accurate *hearing*, to say nothing of possessing ability to register properly.

*From the first day* at the organ your purpose must be to truly hear, *hear*, HEAR, and your intention must be firm to use as much care and thought in working out beautiful effects *during your practice*, as you would desire to secure during a public performance. Be always striving for perfection—both in your registrative explorations and in your mechanical processes.



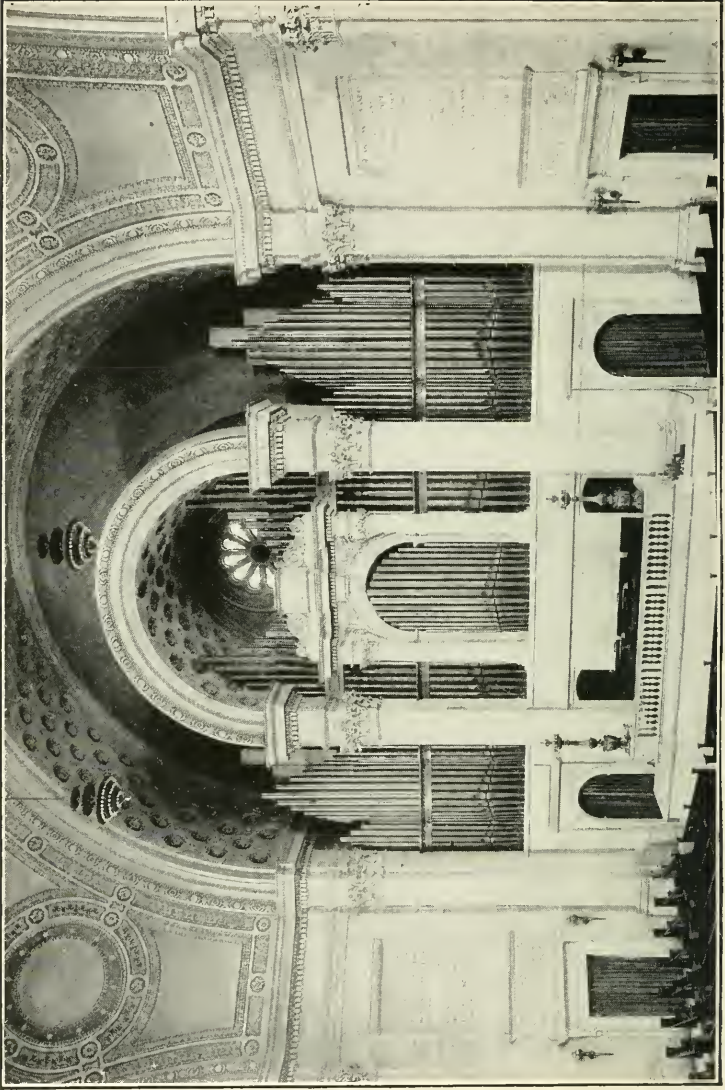

**THE FIRST CHURCH OF CHRIST, SCIENTIST, BOSTON.**  
(Hook and Hastings Co., Kendall Green, Mass.)



## CHAPTER IV

### MASS REGISTRATION: TONE FAMILIES

And now to begin the fascinating though difficult art of combining in mass the tones which you have so far been studying as individuals! Very few rules can be laid down for this work; no list of "stops that combine well" will be offered you, indeed we wonder by what authority certain persons can state that some stops do and other stops do not combine! Such dogmatic assertions we regard as arbitrary, to say the least, and would rather suggest that all stops (granted, of course, that they are of excellent character as individuals) combine well for certain effects; these effects would in some cases be of use only in the rarest cases, we grant, but such would not affect the contention we have just made.

Moreover in many cases it will be discovered that where it has been stated that certain stops do not combine well what is actually the case is that the combination was not in good *balance* for the particular use made of it. Indeed it is an open question whether one may not say that any combination is good and useful,—provided it is used at a time and with a composition to which it is suited.

The first steps in this work will engage your attention with the combining of stops of near tonal relationship, as: *Flutes* and *Diapasons*, first on the Swell organ, and then on the Great. This can well be taken in conjunction with the study of the rudiments of hymn-playing—which study many teachers wisely introduce during the first three months of instruction.

The process will be very simple, and is as follows: draw first on the Swell organ the 8 ft. *Flute*—which will probably be found under one of the following names: *Gedeckt*, *Stopped Diapason*, *Clarabella*, etc. Now play over a line of a hymn to familiarize the ear with the tone quality. Push in this stop and, drawing the *Open Diapason*, play another line of the hymn to fix in the mind its quality. Having heard both singly, draw them together and play through the entire hymn noting carefully the resulting blend of the tones; it will be well, at this stage, to test the effect of the balanced expression lever—commonly called the swell pedal—on the volume (and to a lesser degree on the quality) of the stops under its control. A word of caution may be extended—that you endeavor to use the expression levers in a smooth, restrained, and artistic manner, avoiding the spasmodic, jerky, “pump-handle” style so painfully common with tyros.

Proceed in the same manner with stops of similar tone and name from the Great organ and—having done so—pass on to stops of wider dissimilarity of tone, as for instance some of these:

Swell 8 ft. Flute with 8 ft. String (Salicional, Viol).

Swell 8 ft. Flute with 8 ft. Aeoline.

Swell 8 ft. Diapason with 8 ft. String.

Swell 8 ft. Reed (Oboe) with 8 ft. Flute.

And all the others which you may be able to devise—including the stops of the Great organ in exactly the same way. “Ring the changes” on the many combinations possible—even on a small organ—testing the tone colors with short melodic phrases in different parts of the keyboard as well as with the harmony of the hymns—and above all seeking to really *hear* what you are producing. A simple, well-written piece of music such as William Faulkes’ *Prelude Solennel*, Fig. 6, will afford excellent opportunity for the forming of simple registrations; note the composer’s intention that the piece be



# PRELUDE SOLENNEL

Pi-<sup>re</sup>pare { Swell 8'  
Great 8'  
Choir 8' & 4'  
Pedal 16'

WILLIAM FAULKES

Larghetto

MANUALS

*p* Gt. 8'

PEDAL

16 (uncoupled)

quietly played throughout, and select your registration accordingly.

The next step will be the constructing of "tone families," or mass groups of the different pitched stops of the same tone color; at this point it is fitting to remark that with all small organs, and indeed with many organs of fair size, it will not be possible to build complete families of all tones. The commercial exigencies of the day are such as to preclude the possibility of even approximately scientific specifications; however, as a rule, fairly complete families of *Flute* and *Diapason* tone will be found available.

Let us therefore take first the Flute family, first on the Swell organ, then on the Great, finally combining the two. On the Swell you will find some or all of these stops:

- 16 ft. Bourdon, Gedeckt, or Double Diapason.
- 8 ft. Bourdon, Gedeckt, Stopped Diapason, or Flute.
- 4 ft. Flute (Travers, Harmonic, Chimney, d'Amour).
- 2 ft. Piccolo, Flageolet, Fifteenth.

A selection from these stops will comprise your Swell family of Flutes, and you should now continue your hymn-playing selecting from them stops at three different pitches; starting first with the 8 ft., adding the 4 ft., and lastly the 2 ft. Then you should throw off one of the stops and add the 16 ft., etc. Having thus obtained a glimpse of the composite effect of a family of tone, you should investigate the possibilities of pairs of stops of the same tone: 16 ft. and 4 ft., 8 ft. and 2 ft., 16 ft. and 2 ft., etc., in short all combinations possible with the resources at hand.

In the same manner study the resources of the Great organ, for though they will be of more limited scope they are nevertheless of much importance; finally couple the Swell to the Great and try the greatly increased scope thus made available. Certain simple compositions may at this point be examined with regard to utilizing the

knowledge acquired in the previous work: The beautiful Bach chorale-vorspiel *Alle Menschen müssen sterben* can be charmingly registrated for soft flutes with swell-box

### SCHERZO in D Minor

Meno mosso

GOTTFRIED H. FEDERLEIN

Ch. Flutes 8'

MANUALS

Sw. to Ch. off

PEDAL

16' 8' 4

Sw.

Flute, Gamba

Gt.

Copyright MCMXI by Oliver Ditson Company  
International Copyright Secured

FIG. 7

closed; Gottfried Federlein's *Scherzo in D-minor* contains an episode requiring flutes at various pitches; A. Walter Kramer, in his *Morning Song* Op. 28, No. 2, has made

a felicitous use of the soft flutes in the second theme, and numerous compositions and arrangements of the

## MORNING SONG (CHANSON MATINALE)

A. WALTER KRAMER  
Op. 28, No 2

*L'istesso tempo* Ch. Flutes 8, 4

MANUALS

*p* *mp*

PEDAL

*tranquillo*

*p*

Gt. *mf*

Copyright MCMXIII by Oliver Ditson Company  
International Copyright Secured

FIG. 8

French school, notably in the compositions of Guilmant, Widor, Bonnet and Vierne, and certain arrangements

from the works of Claude Debussy afford ample opportunity for the display of flute tone.

Turn now\* to the Diapason family; only on the Great are you likely to find a complete family of tone, and it will be—in whole or part—as follows:

- 16 ft. Double Open Diapason.
- 8 ft. Open Diapason.
- 4 ft. Principal or Octave.
- 2  $\frac{2}{3}$  ft. Twelfth.
- 2 ft. Fifteenth or Super Octave.

And perhaps a *Mixture* of 3, 4, 5, or even 6 ranks. In this table you will note two pitches so far unfamiliar to you: the Twelfth, and the Mixture.

We cannot give space to a digression into acoustical matters to thoroughly explain the *necessity* for these stops; all that has been covered in many available treatises and manuals of science. Suffice it to say that these stops supply certain tonal ingredients (harmonics, or upper partials) which are but weakly produced in normal pitched stops; their presence adds a brilliancy, a “clang” to the tone—especially the mezzo-forte or forte tone—without which a feeling of dulness might be noticed. This you can quickly prove for yourself: first draw all the 8 ft. Flute and Diapason stops and play through a hymn; add all the 4 ft. and 2 ft. stops and play through another verse of the same hymn. Finally add all the higher pitched stops: the  $2\frac{2}{3}$  ft., 2 ft., and Mixtures, and listen to the transformation which they work. Some one has characterized the addition of a good Mixture to a full combination as “falling like a *shower of stars*” over the tone mass—a most felicitous description!

Having worked out separately the possibilities of the Flutes and Diapasons, try your hand at combining them, proceeding from the soft stops to those of mezzo-forte strength, adding soft 4 fts., then stronger 8 fts., etc., finally the “upper-work”—generally drawing Flutes

before Diapasons to avoid sharp "cutting-in" effects—and thus achieving a reasonably smooth *creseendo* from the two families. In connection with this work some such composition as William Reed's *Triumphal March* will be useful; particular thought should be given to obtaining a reasonable amount of variety in the registration of such numbers—without diverging too far from the composer's frequent dynamic (*f*, *mf*, *ff*, and *sf*) marks. In such pieces—where it is the intention of the composer that considerable power be utilized—the variety must be attained by changes of tone *color*, rather than by the more usual varying of intensity.

The String and Reed families will, by reason of their universal incompleteness, furnish obstacles to their study by similar methods; they are so generally limited by commercial necessity that single stops are the rule rather than the exception. String tone is, however, being more appreciated at its true worth, and it is a pleasure to note that fair-sized organs are now being equipped with something approximating a complete string family on at least one manual.

On large organs, too, it is not uncommon to find reeds at 16, 8 and 4 ft. pitches on at least one manual—generally the Solo or Great; these are of the same tone quality as a rule, and in fact are frequently the very *same stop* rendered available on two manuals. On the Swell, it is common practice to include a 16 ft. of *mezzo-forte* strength, and 8 ft. stops of two or three tone qualities and strengths. These, however, can hardly be classed as *families, per se*, as the voicing will render them so *individual* that they can be classed as a family only in regard to their *construction* and not in regard to their tonal characteristics. Nevertheless, you should experiment with these also, seeking to become so familiar with their characteristics that you will at once recognize the quality—even if a stop be drawn at random with the eyes closed.

# SORTIE, in F Major

Prepare {  
Swell: Full  
Great: *ff* without reed  
Choir: Flute 8'  
Solo: Tubas 16' & 8'  
Pedal: *ff* without reed

JAMES H. ROGERS

Vivace, ma non troppo

MANUALS

Gt. *ff* Sw. to Gt. and Ped.  
Gt. to Ped.

PEDAL

CODA

Meno mosso

rall.

Add Solo reeds

Vivo

*sempre ff*

Copyright MCMXI by Oliver Ditson Company  
International Copyright Secured

FIG. 9



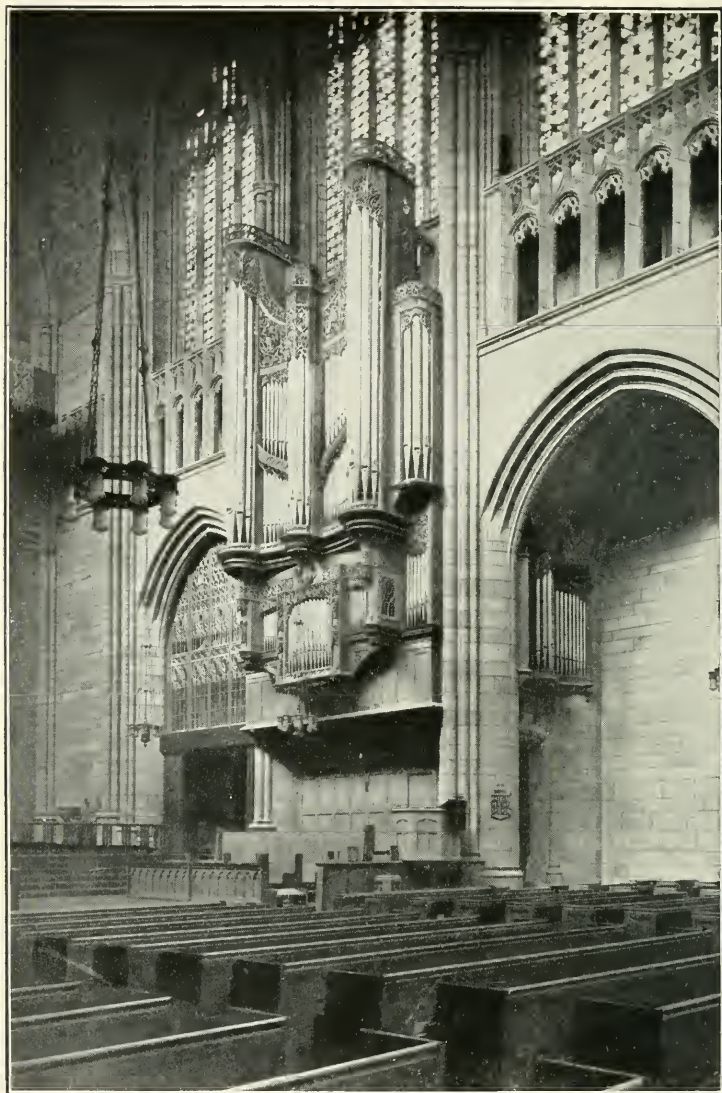

FIG. 9 (Con.)

An artistic use of powerful reed stops is seen in the coda of James H. Rogers' *Sortie in F-major*; despite the buoyant and vivacious character of the piece, the composer designates the omission of the heavy solo reeds (*Tuba*) until the last sixteen measures—thus retaining a store of power for his final, closing climax.

In concluding this chapter, mention should be made of the omission of treatment pertaining to the Pedal organ; this has been done intentionally, and for the reason that—in the present day, when the *majority* of organs are being built with sadly incomplete apologies for pedal organs—it is virtually a waste of time and space to direct that the pedal organ be studied with any pre-determined system. Pedal stops—as now furnished—are usually of so limited variety that the best that can be asked of this department is that it furnish a bass of approximately correct *volume* to balance the manual combinations in use; the pedal organ will be considered in later chapters, however, in its relation to this aspect of the matter.





ST. THOMAS' CHURCH, NEW YORK.  
(Ernest M. Skinner Co., Boston)

## CHAPTER V

### TWO-COLOR AND SOLO EFFECTS

The study of solo effects—the methods by which one voice is thrown into prominence, the blending of prime tones to form both the solo voice and parts accompanying—these are the logical outgrowth of the preceding study of single tones and families of tones; perhaps no stage of registration study holds out more alluring prospects to the student than this upon which we now emerge.

A solo voice may be contrasted with and given prominence above its accompaniment either by *difference of volume* as the preponderant factor, by *the use of dissimilar tone color*, or—as most often happens—by *a combination of the two methods*.

The first method of differentiating solo and accompaniment is in reality an expansion of the monochrome principle which we have up to this time been using very considerably, and it is—moreover—the simplest to grasp; for these reasons we will give a brief illustration of the possibilities of the idea—selecting for use that family which perhaps more than any other presents *less* variance of tone from accepted ideals—*viz.*: the Diapason family, using the stops of that name at different pitches, and also the very soft form commonly known as the Dulciana. Only a few of the combinations would be of practical usefulness, but as a key we give below a table of several of the most obvious arrangements:

SOLO COMBINATION	ACCOMPANYING COMBINATION
Swell Diapason.	Great Dulciana.
Great Diapason.	Swell Diapason.
Great 16 ft. and 4 ft. Diapasons.	Swell Diapason.
Great 8 ft. and 4 ft. Diapasons.	Swell Diapason.
Great 4 ft. Diapason (Sw. to Gt.).	Swell Diapason.

These obtain the effect of solo and accompaniment by no other means than that of relative strength or dynamic value. You should now study the possibilities of this tone utilized as above suggested, using in all probability hymn tunes and chorales as before—but playing the soprano part as a solo, the left hand taking the alto and tenor voices, and the pedals playing the bass (with the accompanying manual coupled to the pedals); you will find this work approached in pages 87 and 88 of *The Organ* and from those pages you will doubtless first study this phase of the technic.

In the same way should be studied the Flute and String families, endeavoring to discover all the solo and accompaniment combinations possible for use. It is frequently found to assist greatly if the student will first write out a list of the stops found in the organ on which he practises, grouping them as families of tone and checking up the list with the dictionary of stops found in the back of this book, then proceeding with the study of the available contrasts as outlined above. Forming a list of the available stops tends to clarify the matter, as it quickly summarizes in immediately available form the exact resources at hand.

It is altogether likely that during this investigation some doubts may arise as to the effectiveness of certain of these arbitrarily formed combinations; these doubts *may in some cases* have not a little foundation for their existence, but frequently it will be found that the difficulty lies in their employment in an unfortunate position on the keyboard. What the singers describe as the *tessitura* or *location* of a passage—whether it be high, low or medium, is an important factor which must be considered when forming combinations for public performance; in other words, what might sound well in one part of the keyboard on a given stop, might sound abominably on another stop in exactly the same *locale*. These are matters which, later on, will demand your

attention constantly, but for the present it will be well to give free rein to your experimentation—noting what effects are good for *general* use and what for *bizarre* and special use only. In a very general way it may be stated that Flutes are most effective in the higher portions of their compass, Diapasons and Reeds in the middle and lower octaves, and Strings especially are most pleasing in the lower octaves.

We now turn to the subject of contrast by *dissimilar tone color*, and a complex matter it is; with the limited number of stops of even a very small organ the possible number of combinations runs into the dozens, and it is this fact that makes a comprehensive analysis virtually impossible. Here it is, indeed, that the musician possessing an *imaginative* mind so completely overshadows his less gifted brother; such a man will sit at a strange console and draw from the organ effect after effect that his less naturally gifted *confrere* has never dreamed could be drawn from it! This would seem to be the result of intuitively forming a mental picture of the tone effects possible, and the process seems to defy analysis; however, it is fortunate for the great majority who do not possess this Heaven-sent gift that there is a possible method of exploration available to any and all, and that by a logical (one might say a mathematical) scheme the resources may be completely utilized. It seems almost trite to point out that anyone by an expansion of the simple principles of investigation which we have been urging can inevitably discover all the effects possible—if the process be but continued long enough! But the fact remains that—with all the resources conveniently at hand, and with the stops fairly crying to be experimented with—the great majority of pupils never even think of branching out on any independent trips of discovery on their own initiative. Because of this, we have kept reiterating this point throughout the work so far, and we cannot too often urge



that *the constant aim be to seek out some new effect each day*. To demonstrate how numerous are the possible effects on even a very small organ we have tabulated below a list (not exhaustive by any means) of effects possible on an organ of but ten speaking stops—about as small an organ as will commonly be encountered. The specification of stops of the organ will be as follows:

SWELL	GREAT
8 ft. Open Diapason	8 ft. Open Diapason
8 ft. Gedeckt	8 ft. Melodia
8 ft. Salicional	8 ft. Dulciana
8 ft. Aeoline	4 ft. Flute d'Amour
4 ft. Flute Harmonic	

#### PEDAL

16 ft. Bourdon

And here are some of the combinations of these stops as solo and accompaniment considered *without* the effects possible by use of couplers:

SOLO	ACCOMPANIMENT
Sw. Open Diapason	Gt. Melodia
Sw. Salicional	Gt. Dulciana
Sw. Gedeckt and Flute	Gt. Dulciana
Sw. Diapason and Salicional	Gt. Melodia
Sw. Salicional and Flute	Gt. Dulciana
Sw. Diapason, Gedeckt and Flute	Gt. Melodia
Sw. Full (all stops)	Gt. Melodia and Dulciana with or without Flute
Gt. Open Diapason	Sw. Open Diapason, or Salicional and Gedeckt
Gt. Melodia and Flute	Sw. Salicional, or Gedeckt and Aeoline
Gt. Dulciana	Sw. Aeoline
Gt. Flute	Sw. Aeoline
Gt. Full (all stops)	Sw. Full (all stops)

And these are, of course, not all of the effects possible—or anything like it; consider how the vistas widen when the increased flexibility of octave couplers is added! And if such a variety of results is possible with the small resources of a little organ such as the above—have we



not a right to expect from larger instruments a most varied scheme of registration?

In addition must be considered the factor of control introduced by the swell-boxes of the organ; the degree to which the box is open is often the determining factor in producing a good effect. Frequently when the student is wondering "why that combination sounds badly" the answer will be found to be that the swell-box is either not open enough or is too widely open; it is a curious fact that combinations which are raw to the extreme with the box open take on qualities of charm with the box partly or altogether closed, and conversely—others seem to suffocate with the box closed more than a very little. Reeds need the refining influence of the swell-shutters, while Flutes seem to undergo a change of quality with suppression and lose their "bloom" as the voicers term it. The student should therefore try the effect of the swell-boxes on combinations while exploring for new effects.

At this point (if indeed not earlier) the student will inevitably cast longing eyes toward some of the myriad "solo-stop" pieces, and—granted that the study of advanced technic be not neglected—there is no good reason why some of the "syrup" should not be included along with the heartier fare! But it should be pointed out that this relaxation should not be permitted to result in playing nothing but this type of music; melody pieces have their place and use, but they are not the end and aim of organ music by any means.

In taking up such pieces the safest rule is to stick to *single solo stops* at first—*prime timbres* as the French say, and then very slowly progress into the field of solo combinations.

Such pieces as Adolphe M. Foerster's really excellent *Pastorale*, Roland Diggle's *Reverie Triste*, J. Frank Frysinger's *Berceuse in A-flat*—to name but a few—are of great value at this point, and have the additional

# PASTORALE

ADOLPHE M. FOERSTER  
Op. 62, No 4

Moderato  
Sw. Oboe

ORGAN

*pp*

Ch Flute

Ch. Clar.

Sw. Diap.  
Salicional

Sw.

*allargando*

Copyright MCMXVI by Oliver Ditson Company  
International Copyright Secured

FIG. 10

value of being worth playing long after this period of experimentation is passed. The first mentioned is such an interesting example of registration in contrasted prime colors that we present a series of short selections from it and strongly advise all students to include it among their study material for this period.

The simplest principle which can be laid down for this work is this: First form your solo combination, or select your solo stop; if it be a combination of stops first select *two* that together please you, and if more stops are wished, build upon these two, adding others which will blend well with them. When you have your solo combination arranged, select from the stops on another manual a stop or stops which will render adequate support, a certain amount of contrast, and *not too great a volume* of tone. As a rule, the student does not err in this latter respect—but in the converse—using too weak an accompaniment, with the result that the effect is all “top and bottom,” the melody strong, pedal ample, but accompaniment almost inaudible; *guard against this with care*. It might be well to hint that you will do well to be more *sparing in the volume of the pedal organ* than of the manual accompaniment. Much guidance may be derived from observation of the balance effected by famous accompanists in the recital world of the day and their work should be studied with these points in mind.

## CHAPTER VI

### THE USE OF COUPLERS

Consideration of those important mechanical aids known as *couplers* has been left until this point—as discussion of such a complicated subject prior to attainment of a fair mastery of the speaking-stops would in all probability only result in confusion to the student.

Couplers are mechanical devices by which different units or sections of the organ may be played from claviers or manuals other than their own proper claviers; through their use increased sonority is achieved—as the tonal resources of two, three or more units may be controlled as a concrete whole. With them varied and complex blending of tones, both in solo and harmony, is secured, and by their use not only are many unique and unusual effects made possible, but—with exercise of good judgment—it is possible to greatly alleviate inherent faults in the tonal design of the organ itself—faults such as improper balance of tone, and missing stops of special qualities.

An analogy may be drawn between the couplers of the organ and the electric switches in the lighting system of one's house; the lights in the different rooms may be considered as representing the different organs (Swell, Great, Pedal, etc.), the player himself may be likened to the main switch of the whole house—through which the energy is transmitted, and the couplers stand in the same relationship to the different organs and the player as do the individual switches in each room of the house. It is easy to see that the act of turning on the main switch of the house will have no effect on the lights in



CONSOLE WITH STOPS ARRANGED IN TIERS; COUPLERS CONTROLLED BY  
TILTING TABLETS  
(M. P. Möller, Hagerstown, Md.)



the different rooms if the individual switches controlling those rooms be left in the "off" position, and that in like manner the player may press the key to no avail unless the needed coupler be used to bridge the gap between the key-circuit and the particular section of the organ which it is desired to use. An electrician would speak

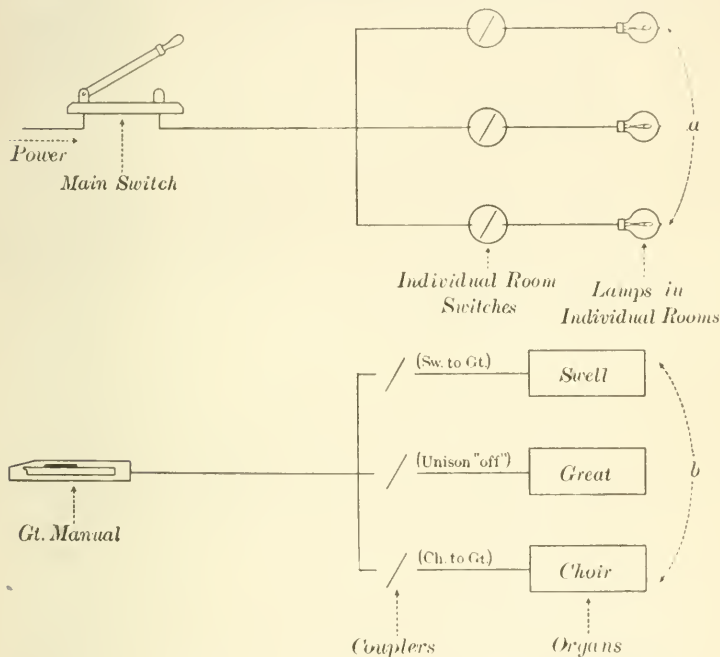

FIG. 11. ANALOGY OF ELECTRIC LIGHT SWITCHES TO COUPLERS

of the couplers of an organ as "gang switches" or *multiple-contact switches*—and in truth this is exactly what they are; they are *selective, multiple distributors* of energy.

There are two principal varieties of coupler: those coupling at unison pitch (operating the note of corresponding pitch on another unit as of the key depressed), and those coupling at the octave higher or lower than



the pitch of the key depressed—these latter being known as *octave*, or *sub* and *super couplers*. The effect of the different couplers is shown in Fig. 12.

Of the two kinds the *unison* couplers are, of course, the most constantly in demand, and are found in organs of every size; the octave couplers, however, are more and more becoming a part of the equipment of all organs—

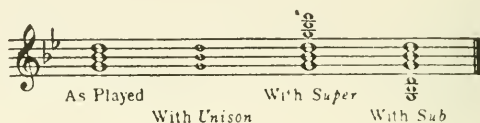

FIG. 12. EFFECT OF OCTAVE COUPLERS

even the very smallest—and are of great value in building up quasi-orchestral effects, unique and odd solo combinations, and also—it must be confessed—in securing increased power and brilliancy from the full organ. This latter use should not be required of them, but we regret to state that it is frequently necessary to put them to this use; the effect of the full complement of speaking stops should be sufficient in itself, and it should not be necessary to alter the supposedly scientific balance of the full-organ by the addition of sub and super couplers. Unfortunately the question of expense limits the specifications in so many cases that it is impossible to gainsay the fact that couplers must very often be used for the purpose of increasing the brilliancy and “smash” of the “full organ” of almost all small organs and indeed of many of medium size.

The unison couplers may be subdivided into two classes: those operating between manuals, and those serving to couple a manual to the pedals. The former bring under control of the hands the combined sonorities of two or more units, while the latter furnish the means whereby the pedals may control the proportionate and correct bass for the manual combinations in use.

The most commonly found manual couplers of unison pitch are these: *Swell to Great*, *Swell to Choir*, *Choir to Great*, and on the larger organs: *Solo to Great*, *Solo to Swell*, etc. In making your acquaintance with these devices remember in reading them to think of them thus: *Swell to Great*—the Swell organ coupled to the Great manual; also fix firmly in mind the fact that the part “to Great,” “to Pedal” gives the clue as to which manual or clavier will receive the tonal reinforcement mentioned by the first term.

No system for becoming familiar with the couplers will be laid down, and, in fact, none will be needed; their use is constantly directed in the registration of all organ music, and moreover—as the need for them is felt the student will instinctively experiment with them and will quickly find the proper one for the need felt.

With regard to the manual to pedal couplers a few words of advice may be given; the prime purpose of these couplers is to place under control of the pedals those notes—musically necessary—which cannot be encompassed by the player’s hands. Considered in another light—they supply resources needed to supplement the usually limited number of pedal stops, and as the pedal organ is usually deficient in both variety and 8 ft. pitch tone, it becomes necessary to use, for the most part, the bass of the manual tones in use at the time, supplementing this with a correct amount of 16 ft. tone (and 8 ft. if available) from the pedals. In this respect we work in a totally different manner from European organists who have—in most cases—sufficient pedal stops available to enable them to form their pedal registrations with but little recourse to couplers.

And so in general the student may be directed to form his pedal combinations by coupling the manual (accompanying manual if a “solo-stop piece” is in question) or manuals in use to the pedals—then adding such pedal stops as will bring up the bass to its proportionate

strength. As an example: when using the *full* Great organ, couple the *Great* to the pedals, then add such pedal stops as may be necessary to support this volume of tone—in all probability the *Open Diapason* of 16 ft., together with the *Violone* 16 ft., and 8 ft. *Violoncello*—if these be available, or perhaps the 16 ft. *Bourdon*, and 8 ft. *Flute*, depending—of course—on the power of the Great organ, and the selection of Pedal stops at hand.

When the proposition is such an one as a solo for the *Oboe*, with accompaniment on the *Great Dulciana* or *Melodia*, do not make the mistake so common among beginners of letting the *Bourdon* 16 ft. do all the work, but rather first couple the accompanying stop to the pedals, and then add the softest 16 ft. stop available (*Gedeckt*) to give the soft, unobtrusive but permeating foundation to support the whole. In the first case the result is one of “top and bottom”—and the pedal notes—being of low pitch—are exceedingly difficult to distinguish; in fact the result as a whole lacks pitch definition and clarity. In the second case the result is logically produced and will approximate scientific balance. As a practical demonstration of the folly of omitting the couplers (in the majority of cases) the following illustration has been included:

Ped.
♭
♭

As played
Without Manual to
With  

Pedal Coupler
Coupler

FIG. 13. EFFECT WITH AND WITHOUT COUPLER

Note in the second chord the tremendous gap between the manual chord and the lonely pedal note far below it—a result which can in no manner be construed as

good—transgressing as it does all the laws of scientific chord construction; observe how the coupler supplies the needed connection.

The uses of the sub and super, or 4-ft. and 16-ft. couplers—as they are often termed, will be learned most easily by the student devoting a portion of his time to experimenting with them—noting their effect on different combinations. While no rules can be given for their use, a few hints may be included which may help in comprehending their most effective uses.

First and foremost this advice may be offered: use sub- and super-couplers as producers of new effects among *soft* and *mezzo* combinations for the most part, reserving their use as producers of power and brilliancy for rare cases where absolutely needed. The English composer, Lemare, has—probably more than any other composer of organ music—pointed out the effects of most value obtainable with octave couplers, and his works should be studied for the light they throw on these matters; in his charming *Spring Song* (to note but one example) he directs that the accompaniment to the cello-like solo shall be on the Strings with *Gedeckt* and Super-coupler—an effect which—simple as it is, and not by any means novel today—seems to shimmer like the sunlight. In the forming of solo combinations such a grouping as: Swell Strings and 4 ft. Flute with *Sub-coupler* gives an effect which cannot be produced from speaking-stops alone. A very good example of sub-coupling on a melody is to be found in William Reed's *Intermezzo*.

Instances could be multiplied *ad infinitum*; trumpet passages such as fanfares are often rendered doubly effective by the addition of a sub- or super-coupler (rarely both) which coupler depending upon the *tessitura* of the particular passage and the amount and character of the accompaniment to it.

Cross-coupling of manuals on even a fair-sized organ

opens a tremendous field of color work; super-couple a combination from the Choir organ to the Great, sub-

### INTERMEZZO

Tempo I

WILLIAM REED

MANUALS

Chmp Clar. with Sub octave  
*mp*  
 Sw p 8 (without reed)

PEDAL

*cresc.*

*off sub octave rit.*  
*dim.*

Copyright MCMVII by Oliver Ditson Company  
 International Copyright Secured

FIG. 14

couple a Swell combination to the Great—use unison combinations from these manuals to the Great—or omit

one of them for sake of experiment, draw soft combinations on all manuals—with the Great and Choir slightly predominating, and the result will astound you. Pronounced orchestral effects are obtained by these methods, and enough has doubtless been said to lead you to experiment freely in this wonderfully prolific field of color.

On organs lacking a full complement of “upper-work,” *i. e.*, stops of 4 ft.,  $2\frac{2}{3}$  ft., 2 ft., and Mixtures, or perhaps only partially complete in these lines, you will be compelled to resort to the use of super-coupling to relieve the effect of “muddiness” and lack of brilliancy; do this with the most extreme moderation, however, and whenever possible *omit the supers*—if it be for only a few measures. Nothing is more wearying than long-continued use of super-couplers!

If you have a Swell organ of ten stops and if—as happens all too frequently these days—eight of these are of 8 ft. pitch, and the others comprise a 16 ft. Bourdon, and a  $\frac{1}{4}$  ft. Flute, it is self-evident that you must of necessity use super-couplers to a greater or lesser degree in very much of your work; it will be practically essential on almost all full Swell combinations, and with full Great combinations you will many times need to couple the Swell at the super-octave as well as at the unison pitch for the sake of brilliancy. Let your ear be the judge, however, and whenever the “lay” of the music takes you into the higher octaves of the claviers for any length of time try to do without the super-couplers if possible.

In leading and accompanying the singing of a congregation the slightest tendency to flatten in pitch should be the signal to you for additional higher-pitched stops or super-couplers; in the organ selections, however, the ear must be the judge as to the *clarity* of the effects being produced.

In like manner but in the opposite direction are the



*sub-couplers* useful—though not to anything like the extent to which the *super-couplers* are; should a combination seem “top-heavy” or “screamy”—as it is sometimes described—it is because there is wanting tone of graver pitch, *i. e.*, 16 ft. pitch, and you should supply this either by stop or coupler, preferably the former of course but using the latter where adequate tonal provision has not been made. *Sub-couplers must be used with even greater moderation than supers*; in general it may be said that *sub-couplers* are most useful on *solo* combinations, and *super-couplers* on *mezzo* effects in full harmony. But with all octave couplers it is wise to be most sparing, cautious and moderate.





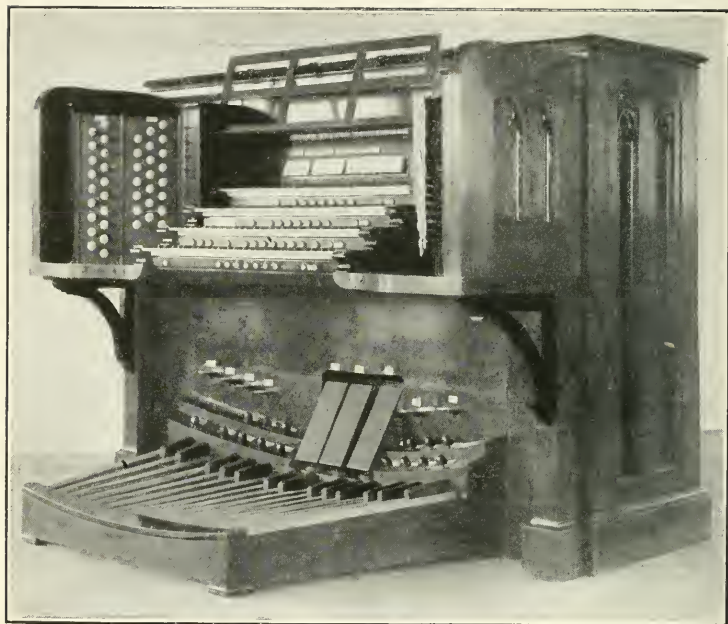

FOUR MANUAL CONSOLE WITH SPEAKING STOPS ARRANGED IN JAMBS  
PLACED AT 45°; COUPLERS CONTROLLED BY TILTING TABLETS.  
(E. M. Skinner Co., Boston)

## CHAPTER VII

### CHOIR, SOLO VOICE AND HYMN ACCOMPANYING

As we near the end of our brief survey of the art of registration it seems well to include a few general remarks on the subject of registration in connection with the use of the organ as an accompanying instrument. In the work of the services of the church the student should at once realize that the organ cannot and must not be regarded as a *solo* instrument, for the obtrusion of personality is contrary to the spirit of things ecclesiastical; the organist must in this phase of his work be willing to submerge himself and his personal claims for attention as a performer, contenting himself with the knowledge that those among his listeners whose opinions he values will appreciate him at his true worth even though his service work be characterized by the utmost degree of self-effacement. The whole perspective in church service work is totally different from the requirements for recital work, and the remarks in this chapter must be regarded as bearing only on the former phase of the work.

We will consider the use of the organ in this work—First: In the accompanying of solo voices and the choir, and, Second: In accompanying the congregational singing.

The first attribute of a successful accompanist of both solo voices and also voices in groups is a *feeling for balance*—good judgment as to the proper volume and quality of tone to employ together with that subtle sense of understanding of a singer's needs which for a better term may be defined as "team-work." Moreover, the

really fine accompanist must know when to play the subordinate part, and when to assume the temporary leadership—"taking the reins" to save some struggling singer from disaster; this is a matter of instinct with some fortunate persons, but it can be cultivated to some degree by all. Extreme watchfulness in all relations between the instrumental and the vocal forces may in truth be urged, for then—if ever—are the calls upon the player most complicated; technical mastery of the instrument is almost imperative.

It may be asked what quality or qualities of tone are generically best suited to the different voices, and to this query a definite answer is virtually impossible; but it may be stated in a general way that predominance of Flute tone is advisable with many Soprano voices, that frequently it will be found well to rely mostly on Strings for support of Altos, that Tenors as a class are safely accompanied by a combination of Strings and Flutes, and that soft Reeds in combination with other soft stops are of value with many Bass voices.

Little more can be said. Voices are—like organ tones—of thousand-fold varieties, and the casual hints given above should be regarded as only suggesting the *predominating* tone to try with the voice. Much can be done however to alleviate deficiencies in the voice to be accompanied by a skillful selection of tones calculated to neutralize or relieve an unpleasant quality in a voice; with voices inclined to the hard, penetrating type it is well to be sparing with Reeds or Strings—relying mostly on full, round-tone Diapasons and Flutes, while with voices of a muffled, throaty or "fuzzy" quality a rather more decisive, keen quality of accompaniment may be desirable—thus supplying the element of definition lacking in the voice. Were the registration adapted with any other principle in view it would be quickly found that the unpleasant characteristic was only aggravated and rendered more noticeable.

Singers frequently wander from the pitch, and the organist can be of great assistance in such cases. If the trouble is a tendency to *flatten* it is a sure indication that more of the "upper-work" (stops of 4 ft. 2 ft. pitch) is needed; should the rarer *sharping* be encountered add more Reed and String tone, and during the interludes thicken the tone with Diapasons. In both cases slightly increasing the power during the interludes will help, and should the case be a very pronounced one it is wise to be fairly generous with the power supporting the singer—for a reasonable increase of power will often carry a singer through where a meticulous withholding of it might result in a complete and ignominious collapse! In the accompanying of *all* singers however, it is well to make your maxim that of giving support with *blending* tones—reserving the stops that *contrast* for more limited use in the interludes and in short thematic passages; variety, therefore, is to be sought only as secondary to support and aid for the singer.

The questions of fitting tone quality do not apply in anything like as great a degree to the accompanying of the choir (either the chorus or quartet forms) as is the case with individual singers; the problem becomes largely one of balance fittingly achieved and selection of quality or qualities of tone which shall make most effective the part assigned to the organ. If the music be so scored that the main interest is with the voices and but little of independent interest is given the organ, it is clearly the duty of the organist to furnish an *unobtrusive support* for the voices and nothing more than that! But, should the organ part contain thematic matter of independent interest (as is becoming more and more the case as composers are writing anthems of greater effectiveness)—then surely this part also should be so treated that it will prove interesting as well. The singers should not be submerged—far from it; but the player should cause his part of the composition to stand forth enough to be

realized—or as it has been put: “to *cut through* without overpowering”; this is best produced by a *contrast of quality*, whenever possible, and not through mere domination by strength alone.

Turning to the subject of congregational singing, and the accompanying of it by the organist, we are confronted by a matter of the utmost importance: the singing of the people, accompanied and led by the choir and organ is the musical backbone of the service.

The organist's part in the congregational singing is a two-function one: he must *accompany* and he must also lead. He must enunciate the tempo and rhythm—the two essentials of all singing by masses; he must see to it that the tempo he designates is adhered to—permitting no “dragging” whatsoever, and he should try to lead the people (in so far as is humanly possible) in bringing out at least the principal moods and meanings of the text of the hymns. By this is not meant that he should be ceaselessly varying the volume of tone, tempi and tone-color in that pernicious manner which has developed of late years—and which is often called “accompanying the hymns”—a procedure which is to be mercilessly condemned as theatrical, secular in feeling, and distracting and disturbing to the members of the congregation.

It is not necessary or artistic to give out one line fortissimo, following it immediately by a sentimental pianissimo on the next line; this is not art, indeed it is not even good taste! If it seems best to obtain variety by this line-by-line method let it be in the manner suggested in the registration of the hymn *Laudes Domini* as shown in Fig. 15, where it will be seen that the changes are of *quality* rather than quantity—thereby mirroring the spirit of the text and with all the volume will not vary in a greater degree than would be expressed by the marks *mf* and *f*. In brief, the congregation should be led to sing the hymn in the *general mood* and style of the entire hymn, and not in a petty line-by-line attempt

at interpretation; *Rock of Ages* demands one mood throughout, and *How Firm a Foundation* a totally different one. If the words demand a change of mood—then let the organ denote that change as subtly as a pool

## WHEN MORNING GILDS THE SKIES

LAUDES DOMINI

JOSEPH BARNBY

ORGAN

*f* (Gt. Full to Diapason, with Sw. *mf*) (Open Sw.)

When morn-ing gilds the skies, My heart a-wak-ing cries

(Add Full Sw.) (Gt Diapason off)

May Je-sus Christ be praised A like at work and prayer

*f* (Add diapason)

To Je-sus I re-pair: May Je-sus Christ be praised

FIG. 15

mirroring the changing clouds above it, with an almost imperceptible dissolving of one mood into another; sudden and unlooked-for changes are most disconcerting to the layman in the congregation and if persisted in will result in but one thing:—the layman will shut his



hymn-book and stop trying to sing—and this should be the last thing permitted to happen.

In “giving-out” the hymn some latitude in the matter of variety is of course permissible; we here give a simple registration for the hymn *Seymour*—showing what can be done in the line of varying the solo stops without resorting to abrupt dynamic changes.

## SOFTLY NOW THE LIGHT OF DAY

SEYMOUR

Arr. from WEBER

MANUALS

PEDAL

Gt. Gamba (Sw. to Gt.)      Gamba off add 8' Flute

*mp* Sw. soft 8' stops

Soft 16' Sw. to Ped.

Add 4' Flute      Flutes off, add Gamba

Detailed description of the musical score: The score is for the hymn 'Softly Now the Light of Day' (Seymour). It is arranged by Weber. The key signature has one flat (B-flat) and the time signature is 2/4. The piece is marked *mp* (mezzo-piano). The score is divided into two systems. The first system consists of three staves: a right-hand manual staff, a left-hand manual staff, and a pedal staff. Above the right-hand manual staff, the registration is 'Gt. Gamba (Sw. to Gt.)'. Above the left-hand manual staff, the registration is 'Sw. soft 8' stops'. Above the pedal staff, the registration is 'Soft 16' Sw. to Ped.'. The second system also consists of three staves. Above the right-hand manual staff, the registration changes to 'Gamba off add 8' Flute'. Above the left-hand manual staff, the registration is 'Flutes off, add Gamba'. Above the pedal staff, the registration is 'Add 4' Flute'. The music features a melody in the right hand and a bass line in the left hand, with the pedal providing a harmonic foundation.

FIG. 16

With all quartet choirs and with the majority of small chorus choirs the author would urge that the leader adopt unison singing for most of the hymn work; the united volume and decisiveness of the combined voices singing the melody supported by ample volume from the organ will raise the standard of congregational singing in any church in a marvelously short time. Make no mistake: we do not urge that choirs of 40 to 50

or more voices cease singing in parts, although even with such bodies of singers there are times when unison singing lends a majesty and dignity of effect simply overwhelming; rather do we plead that it is absurd to expect one soprano voice to furnish sufficient strength and leading power on the melody against three other voices and the organ. In fact with small chorus choirs (up to 16 or 20 in number) the leading power of the sopranos is so limited as to render the adoption of some other factor desirable; this factor will be discovered in the *united singing of the melody by all the voices*. There will be times when it will be desirable to transpose a hymn a tone or two lower to render it comfortable for the altos and basses, but this is more or less true of all hymns as sung in the ordinary manner, and so does not complicate the matter at all, and makes it much easier for the lay singer to add his voice to that of the trained singers in the choir-loft. The voices so united should be supported by a "fat" registration: Diapasons, Flutes—in both 8 ft. and 4 ft., as the foundation, with a judicious admixture of strings and reeds—together or alternately—to give the element of variety.

Such a heavy mass of foundation tone is really a necessity in leading the singing of the congregation; most untrained singers are literally afraid of the sound of their own voices and before they can be persuaded to attempt singing must be made to feel that there is sufficient volume from organ and choir to make it unlikely that their individual voices will be heard all over the church! The author hopes that those reading these paragraphs will not regard this as a plea for thundering blasts from the organ during the hymns; nothing could be less desired. The plea is for *support*, not *noise*; support enough to reach and reassure the timid soul in the last pew, but still not of such a nature as to deafen the ones in the front of the church. Virility, strong accent, rhythm, and ample volume of Diapasons and Flutes

(with little of heavy reeds)—these are the essential requirements.

And finally—do not become *standardized* in your registrations—satisfied with a few stock combinations to be used on any and all hymns. Try to make some slight variation in the registration of each hymn during a service; the practical combinations which may be used in accompanying a congregation are quite numerous. Super-coupling soft Swell combinations to the foundation tone of the Great organ opens countless beautiful effects and does so without disturbing the supporting qualities in the least. With these suggestions we leave the reader to study the matter for himself; we cannot urge too emphatically, however, the importance of giving careful study to these—and all other—details of church work, for after all it is in the church that the organ finds its greatest sphere of usefulness. True—it is fast becoming converted to secular uses and will probably be so used more and more with each passing year; but it is likely that the student will continue to find the most frequent opportunity for his work *in the church*, and the proper use of the instrument in church surroundings must be thoughtfully considered by all who would make a success of their work.





CONSOLE WITH INCLINED MANUALS AND STOP-KEYS CONTROLLING  
SPEAKING STOPS AND COUPLERS.  
(Austin Organ Co., Hartford, Conn.)

## CHAPTER VIII

### SOME PRACTICAL SUGGESTIONS

There remain some thoughts on registration which it has not seemed wise to include in any of the foregoing chapters, together with a few suggestions as to special but useful effects which should be added. These thoughts will be set down in no preconsidered order and must be regarded as hints to be referred to from time to time—especially during the frequent self-catechismal questionings which should be made a matter of routine by all musicians, young or old.

*First.* Endeavor to assimilate and incorporate in your work the principle of moderation in tonal changes; make it a cardinal rule to avoid unpleasantly sharp contrasts—laying-on or taking-off the color *in thin layers*, so to speak, rather than by applications of huge splotches thrown at the tonal canvas. This is, of course, only another plea for smoothness and technical finish, but it is a most important point.

*Second.* While bearing in mind the above point we would also advise the student to make a practice of sometimes *totally changing* the *character* of the tone in use—*without necessarily changing its volume to any extent*. As an example: during some selection you have been using combinations of strings and flutes for the most part; if the construction of the piece will permit, try using, during some passage, or passages, the totally different tone of the *Swell Open Diapason*, and note what an agreeable contrast is offered to the ear. Or, if you have been mainly using strings, try using the pure *Flutes* alone for a part of the piece; this occasional use of

prime tones is a grateful relief to the ear and furnishes valuable contrast to the more constant use of mixed combinations.

At first glance it might be thought that this suggestion and the one preceding are of antipathetic nature, but such in reality is not the case; the explanation is this: gradual changes are best for use during the progress of sections of a composition, while the sharp contrasts naturally are most valuable at those points where the natural sectional divisions of a composition occur. To illustrate: a composition written in "song form with trio section" will call into play both principles of registration, for during the progress of the first two or three divisions the registration should be of a *gradually changing nature* which moderation will meet with an effective contrast if—upon arrival at the trio section—the registration be *decidedly altered*, both as to quality and volume, and a reinforcement of contrast will be attained by a decided return to the tonal methods of the first sections upon the re-statement of them in the composition.

The plan of contrasting tones at the principal points of division of a composition has the desirable effect of aiding the listener in grasping at least the elements of the design of the composition. An effective use of the Solo *Tuba* for phrase contrast (which is only an elementary form of the sectional contrast we speak of) has been made in Richard Keys Biggs' arrangement for organ of Charles Fonteyn Manney's *Prelude and Christmas Pastoral* from "The Manger Throne"—the tonal contrast aiding and abetting the natural musical contrast of the phrases in which it is employed.

A similar treatment may well be accorded Marcus H. Carroll's *Festival March*—the first six measures being given to stops of the Tuba or Trumpet type, the Great organ entering with the chords of measure 7, thus showing plainly that the first measures are in reality an introduction to the main body of the composition which



# PRELUDE and CHRISTMAS PASTORAL

From "THE MANGER THRONE"

Prepare { Swell: Diapasons (Sw to Gt.)  
 Great: Diapasons *ff*  
 Choir: Full (Ch. to Gt.)  
 Ped: *ff* (Coup to Sw. & Gt.)  
 Solo: Tuba

CHARLES FONTEYN MANNEY  
 Arranged by Richard Keys Biggs

Moderato maestoso (♩ : 110)

MANUALS

PEDAL

Copyright MCMIII by Oliver Ditson Company  
 International Copyright Secured  
 Copyright MCMXXVI by Oliver Ditson Company

FIG. 17

## FESTIVAL MARCH

Prepare { Great: Reeds and Foundation Stops 8'  
Swell: Full  
Choir: Flutes 8, 4'  
Pedal: 16', 8'

MARCUS H CARROLL

Tempo di Marcia

MANUALS

PEDAL

*stacc sempre*

Copyright MCMXI by Oliver Ditson Company  
International Copyright Secured

FIG. 18

follows. Instances could be multiplied indefinitely but enough has undoubtedly been said to illustrate the worth of this simple principle.

*Third.* Learn *when, and when not* to use tremolos and stops of the Celeste (vibrato) type; for many years it has been the fad of purists to practically insist that these stops were the desolation of all that was abominable—a viewpoint not without some foundation when based on early specimens of the stops in question. However, with the present perfection of the tremolo and the various beautiful String and Flute Celeste stops these mandates can well be relegated to the forgotten past; the modern tremolo is in reality a slow-speed vibrato—quite different from the old fluttering-bird-wing devices, and the Celeste stops infuse an orchestral warmth in the same way as the duplication of string instruments in the orchestra produces a “liveness” of tone attainable in no other way. It may well be pointed out that the tremolo is most desirable with those stops which in the orchestral instruments of which they are the representatives are naturally susceptible to vibrato treatment, viz: the String stops (*Cello, Viol d’Orchestre, Viol Celeste, Vox Celeste*). It is particularly desirable also, that when playing transcriptions of music written for the orchestra the tremolos be omitted from the stops representing the wood-wind band (*Oboe, Clarinet, Bassoon, English Horn, etc.*)—thus preserving more nearly the natural color and technic of the original; note that we do not advise that the tremolos be unused with these stops as a general practice, but *especially and particularly with orchestral transcriptions*. It is also the part of wisdom to omit tremolos during passages of short and rapid notes—as the occasional conjunction of some of the short notes at the exact moments when the tremolo is releasing a puff of air will often result in faulty speech or incorrect intonation from a reed pipe; naturally therefore, tremolos are most effective with long, flowing and expressive

melodies—such passages as a violinist would naturally treat with considerable of the “wrist-vibrato.” Our best players are making use of these stops to an extent undreamed of even by performers of a generation ago, and too much thought cannot be given to their artistic use.

*Fourth.* In playing passages which lack inherent rhythmic interest—*i. e.*, passages of notes of the same time value, etc.—use an expressive division of the organ, or such a division *coupled* to an unexpressive one if the latter be thought necessary; the reason for this should be self-evident: to substitute for the lack of rhythmic interest the delicious dynamics produced by the *expression levers*. The modern organ—in common with all instruments of true artistic capacity—offers ample facilities for shading and there is absolutely no justification for continuance of the methods which were fostered by and which were the result of the limitations of the organ of a generation ago; therefore, you should not be content to pursue archaic methods when more artistic ones have been made possible. Make your playing as *expressive* as that of any other solo instrument.

*Fifth.* Try to make your console manipulations in a systematic manner; avoid a wild and fluttering uncertainty of the hands—here, there and everywhere among the stops and couplers! Plan just what changes will be needed at each point in a composition and then arrange a logical order for making them. Try to work around from one side of the console to the other, or from the center out (fan-shape) or, occasionally, from the extreme edges in toward the center, etc. Perhaps the changes will be partially accomplished by use of pistons: if so decide with which hand the pistons shall be manipulated; if two pistons must be used at nearly the same moment *decide which one* shall be used first, and if couplers are also to be changed plan in advance whether the stops or the couplers shall be changed first and which hand can best be spared for the operation.

Not This—

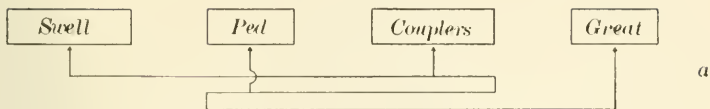

But This—

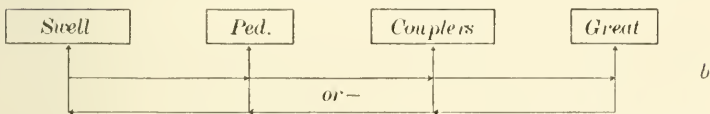

FIG. 19. (a) INEFFICIENT AND (b) EFFICIENT MOVEMENTS AT THE CONSOLE

A quiet demeanor at the console is most restful to the observer, and unquestionably tends to inspire confidence in the members of the choir; a choir can be thrown into confusion by the sight of their leader floundering among the stops in nervous uncertainty. It is much better to limit your registration changes to the irreducible minimum—making those only which you can make with sureness and speed—than to run the risk of breaking the rhythmic flow of the choir selections, for even a trained choir can be badly disconcerted by even a very slight *unexpected* pause.

*Sixth.* Avoid uneven and spasmodic use of the expression levers. It is trite to direct that swell pedals be not “pumped”; however, many students fail to realize that the vital point of the matter is that it is not necessary to open the box to its widest limits every time it is desired to make a crescendo! Your teacher will undoubtedly see to it that you do not acquire the vicious pumping habit, but you, yourself, must be always striving to attain mastery of the more *delicate* and *subtle shading* made possible by the modern swell-box—“The

Soul of the Organ”—as it has been rightly called. Make no mistake: we are not directing that the swells be always used for gradual crescendos—quite the contrary! One of the most valuable possibilities of the modern electric swell engine is the ability to produce short, emphatic *sforzando* accents by quick pressure and immediate return of the pedal through a short distance. What we aim to make clear is the vital fact that it is not necessary *nor desirable* that the swell-box be completely opened and closed every time it is desired to make use of it; rather may it be said that the swells should be used with *considerable frequency*—but with *extreme moderation* in the *degree* to which they are used.

*Seventh.* If the pistons on your organ are of the adjustable type set on them the combinations for which you will have most constant need; it is well to have ready for instant use several pistons with combinations of general use in connection with choir and congregational accompanying. A couple of pistons set with stops for hymn playing are exceedingly handy—especially where the service moves rapidly and there is little time for hand setting, as for instance where a hymn follows immediately upon an anthem. Do not set many pistons with loud combinations; leave the last stop or two (the most powerful as a rule) for adding by hand, or by crescendo or *sforzando* pedal. By doing so you always have something left, after running-up on the pistons, for a final addition to the climax; a more gradual crescendo and diminuendo is thus possible than where the full organ is set on the pistons themselves. Should the pistons be of the non-adjustable type—happily becoming rarer with every passing year—you will be compelled to rely more upon hand manipulation, using where possible a piston drawing nearly what you require and then altering by hand the stops drawn by that piston. Use the flat of the hand, the back of the hand, or even the wrist at times, in making changes; it is often possible



to so spread the hand that with one motion as much can be accomplished as would require two or three motions of the fingers in the conventional position.

*Eighth.* When you have passed the novice stage, do not be afraid to completely alter the registration of a composition if you can find one better suited to it on your particular organ. The chances are that the composer—were he to come to your organ—would himself use a very different scheme of registration from the one indicated on the printed copy; knowing the manifold variations in voicing of organ stops and the innumerable differences in specifications and equipment of organs, composers are virtually driven to indicating upon their works only the most general and superficial hints as to the registration desired. Regard all indicated registrations as clues only, not as hard-and-fast commands to be slavishly followed; the tempo, *tessitura*, mood, degree of complexity, etc.—all these factors must be taken into consideration.

*Ninth.* Although this is not a textbook of organ playing in general, the author cannot refrain from making a plea—in closing—for greater *clarity* in playing. *Clarity*—that essence of all fine art, without which the efforts of the most heav'n-endowed genius stand for naught! Co-existent with striving for good *effects* should be an equally strong desire for clean-cut phrasing, accurate finger work, clear "live" pedaling, a staccato touch which "ripples," a pearly semi-staccato, a legato which connects but does not overlap—in short, all the technical details that taken together consummate in artistic organ playing. The day of slipshod, muddy playing has gone, and in its place we find the day of modern technical methods as applied to the organ; it can safely be stated that no organist—however highly endowed by nature—can, in this day, reach to and continue to hold any considerable degree of success unless adequately equipped technically. The wide scope of usefulness for the King of Instruments has opened



a vast field for players well equipped, and the sphere is still broadening with each passing year; to those of requisite ability and equipment the modern organ offers a scope of usefulness equal to that of other solo instruments and in keeping with its inducements as a solo instrument by its own right.





STOPS AND COUPLERS OPERATED BY TILTING TABLETS.  
(Wirsching Organ Co., Salem, O.)

## CHAPTER IX

### THE CRESCENDO PEDAL

The Crescendo Pedal is perhaps the least understood and worst manipulated accessory of the modern organ. It is constantly used in places and ways in which it should not be. The result is that strong prejudice has sprung up in certain quarters against the crescendo pedal, *per se*, whereas the criticism should be directed toward the abuse of the pedal and not hurled at the innocent accessory itself.

As an extreme example of prejudice developed to the point of a fetish may be instanced the attitude of a famous English organist who requires the crescendo pedal on all organs on which he performs to be locked firmly, so that by no possibility can the pedal be brought into use.

It is an open question whether or not the name Crescendo Pedal—in so far as it applies to the majority of organs—is not a misnomer; in connection with an organ of few stops it is really a farce, because in all small organs the *breaks* caused by the wide difference of scale and power of some of the stops render anything like a smooth crescendo impossible. Moreover the order of arrangement of the stops adopted by some builders is quite inartistic. On large organs it is possible to plan a fairly smooth crescendo of stops, and in such cases the name is more justifiable.

Sub- and super-couplers should rarely if ever be included in the range of the crescendo pedal, and it is an open question whether the same may not be said of the heavy reed stops, *i. e.*—solo reeds. String stops also,

indeed all stops of highly individual quality, should also come on very near to the end of the crescendo rather than at the beginning. Where the pedal is made adjustable, as is sometimes the case, the organist will be in a position to work out by experimentation the most perfect crescendo possible.

But as a rule the organist must concern himself with making the best use of the accessory as he finds it provided for him. So let us inquire into the best usage of the device.

*First:* Regard the crescendo pedal more as a means of producing "graduated accents" than as a purely crescendo builder. The occasional *sforzando* or accent is of the greatest value in correcting the tendency of organ music to be devoid of vitality. A *sforzando* may, of course, be of any degree of power greater than the volume which has been in use prior to its advent; it need not be of *ff* strength—far from it! The average of power in use during a certain section of a composition may have been not greater than *mp*, but a *sforzando* will be produced—just as truly as if it were on a larger dynamic scale—if there is added for an accent touch merely an *mf* degree of power. Or to put it another way: the addition of a *single stop* will produce a degree of *sforzando* for a soft combination just as truly as will the addition of three or four reeds to a *ff* full Diapason organ. It is truly remarkable how much our best players are using the crescendo pedal for this *sforzando* work, and it is probably in just this field that its greatest usefulness lies.

Moreover the crescendo pedal is, by reason of the facts stated above, of vastly greater value than the totally misnamed *sforzando* or—in reality—*full organ* pedal; this latter accessory is of no value whatever other than that it gives instantaneous command of the full organ. With it only one degree of *sforzando* is possible—and that the most powerful; naturally this limits its usefulness to the moments when great power is needed—

and those moments are rare. The crescendo pedal, on the contrary, presents a large number of possible degrees of accent from the softest to the very loud.

*Second:* A very excellent usage of the crescendo pedal is in connection with passages in sequences, where—with each repetition of the sequential passage or phrase—an increase (or decrease, as that use also is possible) is given to the volume of tone employed; the addition of tone will be needed most often with rising sequences, and the subtraction with falling ones. Both should be done with great moderation, and not too frequently.

*Third:* Crescendo by chords, that is, minute increases of power with each chord, or with the strongly accented chords of each measure, is also possible, and often relieves the monotony of passages made up of chords of the same time value.

*Fourth:* Do not use the crescendo pedal to obtain *mf*, *f*, and *ff* degrees of power for any extended periods; the lazy habit of doing this instead of manipulating stops has been the cause of much of the criticism of the device. It is evident on a moment's thought that if this is resorted to there will be produced a most stereotyped effect; the quality of tone produced is invariably the same at any given point in the progress of the pedal. Rather obtain the effects for use for any length of time by means of stops (pistons if necessary) and thus reserve the crescendo pedal for its most effective function, *i. e.*—as a producer of accent and *sforzando* effects. There lies in this course at least the chance that the effects will be varied, but if the former procedure be followed even that chance is eliminated.

Analysis of these points will reveal the fact that they are based on the premise that the pedal is only an *accessory*, and not something to be fallen back upon because of lazy habits. It must not be thought of as a short cut to registrative work, for such it emphatically is not. It is not a device for eliminating hand manipulation

of the stops. It is first and foremost a producer of graded accents, and secondly—and to a much less important degree—a builder of crescendos and diminuendos, and it must be regarded in this light if it is to be artistically used.





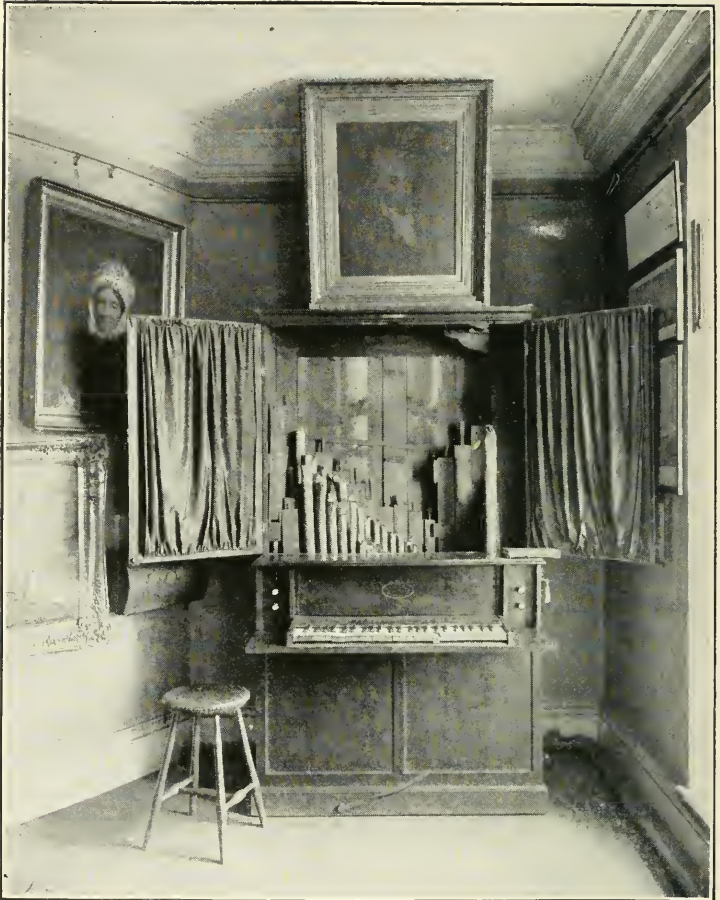

OLIVER HOLDEN'S ORGAN

(circa 1790)

## CHAPTER X

### A GLANCE AT ORGAN CONSTRUCTION

In this chapter we will endeavor to give you an insight into the mysterious functioning of the interior mechanism of the modern organ. From a purely mechanical standpoint the organ is unapproached by any other musical instrument in complexity, variety of application of energy and number of mechanical motions employed. The modern grand pianoforte, with its beautifully perfect action, is not of one-twentieth the complexity of an electro-pneumatic organ, and yet—as Sir John Stainer truly states—“The history of the organ is nothing more than a narrative of the efforts of men to bring under the control of one performer a large number of the instruments called flutes.” How well this effort has been realized may be judged from the fact that the largest organ in the world at the present time (the great organ in the Wanamaker Store, Philadelphia) contains 17,954 pipes, all readily controlled by one player!

In marked contrast to this mammoth instrument is the little organ of Oliver Holden, the composer of the hymn-tune: *Coronation*. Because of its unique historical value we include a reproduction of this early organ. Holden was a carpenter and joiner by trade, but dropped his tools to become a teacher of music. This organ, of which he was extremely fond, dates from about the year 1790, and is now in the custody of the Bostonian Society in the Old State House, Boston.

The first requisite of an organ is an ample and steady supply of wind with which to blow the various pipes. For many years this has been produced by a *bellows* and

*double feeders*, these latter operated by either human muscles or by a water motor, steam or gas engine—the final application of the power being the same in all cases. As will be seen in Fig. 20 the contrivance consists of a horizontal frame surmounted by a series of flexible folds, quite similar to the folds of a *Concertina*—these latter supporting a top board on which are placed weights or springs to restrain the upward motion of the top board and thus confine the wind under pressure. Below the horizontal frame, generally called the *trunk*, are to be found the *feeders* which are smaller replicas of the construction above the trunk; these feeders are moved up

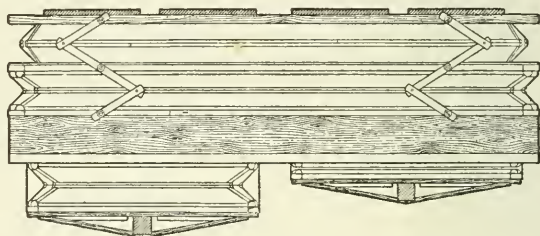

FIG. 20. BELLOWS AND FEEDERS

and down by the particular power source in use, and function in the same manner as the simple hand bellows used by our ancestors in starting a wood fire in the grate. With each upward motion the air is compressed and forced into the trunk and reservoir; during the downward stroke the feeders are again filled with air which is again delivered to the reservoir above, this cycle being repeated as long as the organ is in use.

The desire for a more steady and unshaken supply of wind for the organ led to the introduction of the modern *Centrifugal*, or *Fan* blower, and this type of wind supply has become the generally accepted equipment for all modern organs. Several styles of this machine are in use but the principle of all is the same, *viz*: a rapidly



sticks, levers, wires, etc.—known collectively as the *tracker action*.

It is not our purpose to enter into an exhaustive discussion of this action; it was for many years the one and only action for the organ. It has undoubtedly served its purpose, and served nobly, and we may remember that the action of the organ of Bach's day was of this type; but it is—as far as construction of new organs goes—a thing of the past, and its interest for us now is mostly historical. In Fig. 21, we show a drawing of this action as introduced in a two-manual organ.

The drawing shows clearly the arrangement of the different levers utilized; the dotted lines used in three places indicate the position of the coupler *stickers* when the coupler is in the *off* position. It will also be noticed that because of limitations of space the *chest* for the *swell organ* is not indicated; this chest is exactly like the one illustrated and would be placed to the right of the great chest in the illustration.

While on the subject of the chests it may be well to state that the pipes are not arranged, in the best organs, in the same manner as the strings of a pianoforte, *viz*: in regular chromatic order from lowest note to highest, but are usually placed alternately on either side beginning at the ends of the chest with the largest pipes. This means that the pipes slope upward from the smallest pipes—which are in the middle of the chest—to the largest which are on the ends. The order on one side is this:



and on the other side this:









GREAT ORGAN IN MUSIC HALL, BOSTON, 1863.

This fact is worth noting, as, if you are ever compelled to tune an organ, or are requested to hold keys while a tuner is at work, it will be in the above orders that you will be required to do it; much time would be lost if an attempt was made to tune upward in straight chromatic order as the tuner would be obliged to move back and forth from side to side with each new note!

About fifty years ago the first successful attempts to remedy the manifold defects of the tracker action were consummated; the tracker action—heavy, lacking sensitiveness and quick recovery—had long been a bar to the growth of the organ, limiting decidedly the possible number of stops which could be played by an average human being, and also barring progress in tonal improvement which it had been vaguely foreseen was possible through use of heavier wind-pressures.

It may be noted that at about this time there was built the first thorough concert organ for this country:—the great organ in Boston Music Hall. This instrument was formally opened on November 2, 1863, by a notable group of recitalists, including B. J. Lang, John K. Paine and Eugene Thayer. The organ contained every known feature and accessory of artistic worth and was, for its time, a remarkable instrument; but so great has been the development of the powers of the modern organ as a concert instrument that this marvel of the sixties would be regarded as a very limited vehicle of expression by a present-day recitalist. Truly, the expansion of the organ in the last fifty years has been a process of startling rapidity.

There was then introduced the first forerunners of the present day *tubular-pneumatic* action; the principle of this action is, crudely put, this: that if pressure be applied to the air in a tube at one end of the tube, the same pressure—roughly—will be available at the other end of the tube. It is this principle which permits piping gas and water through our streets to our houses.

In the organ the tubes are provided, one for each key, manual and pedal, running from the keyboards to the chests; they are generally of small diameter—the size of a thin lead pencil—and made of lead for easy bending around corners, etc. By utilizing a puff of wind in these tubes a valve in the chest is opened and the chest action set in motion just the same as if a tracker were employed—and with no more exertion to the performer than would depress the keys of a pianoforte.

The system most generally adopted at the present time is known as the *exhaust* system, and is satisfactory when used in situations where the console is not placed at any

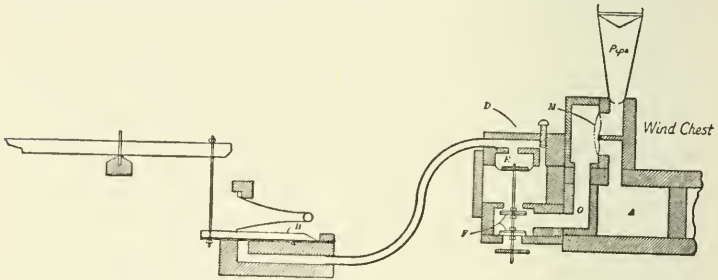

FIG. 22. TUBULAR-PNEUMATIC ACTION

great distance from the organ proper; this system presents the advantage of having the fewest moving parts, and gives very little trouble. It is illustrated in Fig. 22.

The tube connecting the key and the chest is kept full of wind from a small *bleed-hole* (controlled by the set-screw which can be seen on top of the chest) except at the times when the key is depressed by the performer; when this is done the wind in the tube exhausts (whence comes the name of the action) and the pneumatic *E* raises, carrying with it the double valves *F*; the change in position of these valves releases the air in the chamber *G*, the diaphragm *M* being allowed to bulge into the channel *G* and thus permit the air in the chest to pass

from the chamber *A* into the pipe. When the performer releases the key the cycle of actions is reversed and the action resumes the position shown in the drawing—silencing the pipe. In a perfectly designed and built action this cycle can take place very rapidly indeed, providing only that the tubes be not of too great length. The greater part of the little regulation needed by this action can be secured by slightly turning the screw governing the aperture of the bleed-hole mentioned above; outside of the chance that a speck of dirt may lodge between the valve and the valve-seat there is little or nothing about this action to get out of order.

With the introduction of electricity into the mechanism of the organ began the period of its greatest development as an instrument worthy of a great artist. The idea of using this force in the action of the organ originated, curiously enough, about the same time as the inception of the pneumatic action, but the first electric action organ in this country was not built until 1878, when Hilbourne L. Roosevelt introduced it into his organ in Grace Church, New York City. Since then it has undergone a constant refining process, the late Robert Hope-Jones being the principal figure in its development, and it is now the only action employed in instruments of any calibre and is being increasingly employed in even very small organs; it is instantaneous—no matter how far the console and organ may be separated—repeats with lightning-like rapidity, and when well made is quite as reliable as the tubular-pneumatic action. Before many years it will probably be the exception to find a modern organ with any other action.

In Fig. 23 will be found a sectional view of the main elements of a modern electro-pneumatic action.

It will be noticed that the action much resembles the tubular-pneumatic just discussed—the tube and key-valve being missing, and in their place a magnet, armature-valve, contacts, battery and wire being found.

Depressing the key closes the circuit at the key-contact *N*—just as the act of ringing an electric door-bell is accomplished—and energizes the magnet *L*; this causes the small metal armature-valve *H* (a thin circular wafer of metal) to be attracted to the magnet *L*, and in rising it uncovers the vent *K*. This vent being opened to the outside atmosphere the wind from the pneumatic pouch *E* exhausts through the vent—drawing upward the double-valves *F*—from which point the cycle of operations is the same as with the tubular-pneumatic action described above. When the key is released the electric circuit is broken, the magnet loses its power of attraction, the

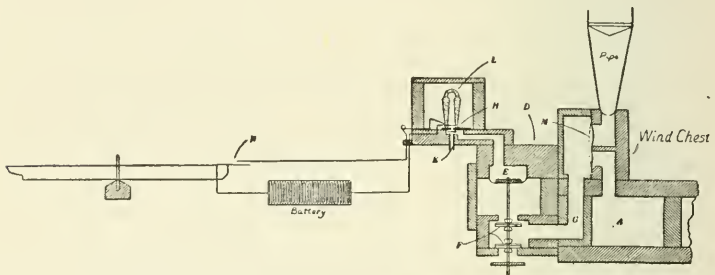

FIG. 23. ELECTRO-PNEUMATIC ACTION

armature-valve resumes its position over the exhaust-vent *K*, and the action resumes the position shown in the drawing.

In the modern organ it should be understood that the current is furnished, not by batteries—as was the case in the early experiments—but by a small dynamo, or generator, which is belted to the motor which drives the fan blower supplying the wind for the organ. The couplers are also eliminated from the drawing, as their introduction would tend to bewilder the non-technical reader; they are, however, merely multiple-contact switches, or gang-switches for the diverting of the current from one normal path, into two, three or more paths—all originat-



ing from a single starting point (one-key contact), and their position is in the circuit between the key contact and the magnet.

Probably the greatest single convenience which has been invented for the comfort of the organist is the Adjustable Combination Action; with it he is able to command any desired arrangement of stops at any instant. All modern organs are provided with *Pistons* located immediately below the manual, the stops of which they control; *Pedal Studs*, having the same function and operated by the feet, are also being fitted somewhat frequently of late.

There are two systems of stop combination control in use, known as the *Blind* (non-movable) and the *Visible* (movable) systems; in the former, which is employed on only a very small percentage of the modern organs, the stops do not move in and out in accordance with the setting on the pistons; the stops proper can be moved only by the hand of the performer and the combination action is in reality a kind of an appendage to the organ instead of a complete, absolute system of control. It is not being used in the work of any of the notable builders, and will doubtless fall into disuse ere long. The *Blind* system is generally found constructed with a small plug-board—like a telephone control-board, or with a small switch-board; in either case there is a plug-hole or switch for every stop for each piston on each manual, or pedal organ, *viz*: if there are ten stops on a manual and five pistons controlling them, there will be fifty plug-holes or switches; by plugging-in or turning the switches the stops which will be added by the pistons are selected.

The *Visible*, or movable system, while more expensive to construct than the one just described, presents so many points of superiority that it is being used by all the best builders of the country. In this system the *stop-knobs* move in and out in accordance with the setting on the piston, thus furnishing an absolute indication of the

status of the organ at any instant. The method of setting-up varies—there being three methods of control commonly found: *first*, the setting being fixed by drawing a stop-knob numbered to correspond with the number of the particular piston; *second*, by pressing a general *setter-piston* and then pressing the piston desired while holding in the setter; *third*, a system in which the piston is held in while the stops are smartly rapped into position—on or off—by the fingers of the performer, there being a friction slide fitted to stops in this case which permits this motion but still does not allow them

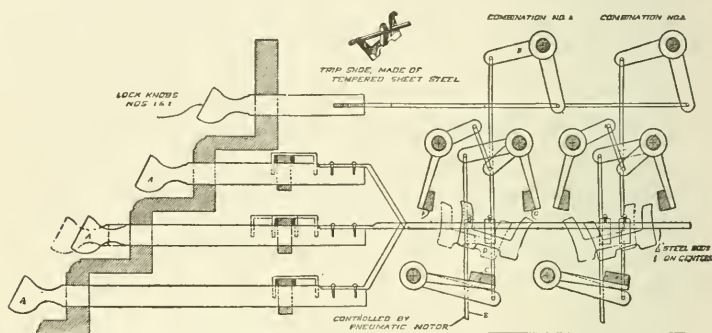

FIG. 24. ADJUSTABLE COMBINATION STOP-ACTION

to slip when using the piston in the usual manner. The process is the same in each case but the last; the stops are prepared and then the setting is done; with the last the setting is done during the preparing process, so to speak, the two being really simultaneous. Fig. 24 illustrates the mechanism employed in this type of combination action, two pistons only being indicated.

In the drawing the stop-knobs to be controlled are indicated at *A, A, A*. To set the combinations first arrange desired stops for piston No. 1, then draw the Lock-Knob No. 1; this knob is connected by rods and a bell-crank to the bar *C*, which throws the *trip-shoes, D*,



into *on* or *off* position. The one movement tilts *down* the trippers on the *on* stops, and tilts *up* those on the *off* position; these trip-shoes are constructed to move with a certain amount of stiffness.

This preparation being made and the lock-knob pushed in again, the act of pressing the piston No. 1, will cause a pneumatic motor to be inflated which will raise the rod *E*; this rod connects with the two fans, *F*, and *G*; these two fans move toward each other, the one pushing out all stops set to be out, the other pushing in all stops not so set.

This same mechanism is duplicated for each piston provided for the particular section of the organ, and the action in the case of every one of them is the same. As there is no interference between this action and the playing part of the organ, it is perfectly possible to change the setting of combinations at any time, even during the actual performance of a composition.

One of the biggest factors in developing the organ into a highly *expressive* musical instrument has been the development of perfect *Swell-Boxes*, and the inclusion of from one to six of them in the instrument; from two to three are commonly found of late. By this means an unparalleled flexibility is secured, and the organ is no longer limited to music of a strictly contrapuntal nature.

In Figures 25 and 26, we illustrate the working principle of the Swell-Box, looking at the box from the top.

Swell-Boxes very often are veritable *rooms*, as now constructed, with wide passageways to all parts of the box; in this respect they are a far cry from the small, cramped boxes of early days—in some of which only a small boy could enter! They are all alike in one respect, however; the front consists of a series of shutters swinging on pivots (similar to the familiar Venetian blind) and controlled by the action of the expression lever, or swell pedal. In the modern organ electricity is again

relieving the player of much of the labor of playing by interposing a "swell engine" between the swell pedal, and the shutters; when this is done the most delightful

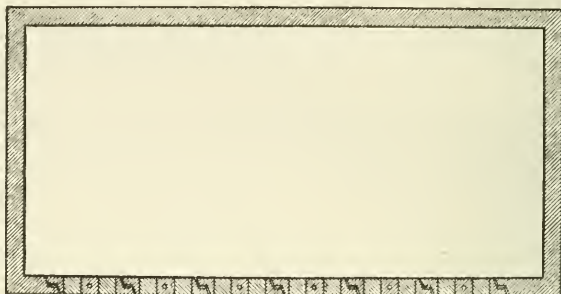

FIG. 25. CLOSED SWELL-BOX

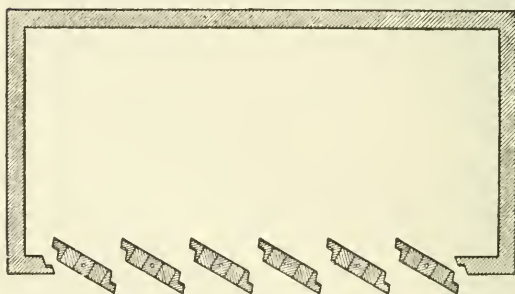

FIG. 26. PARTLY OPEN SWELL-BOX

effects (slow or quick swells, accents, sforzandos) are possible.

A few words also on the subject of organ pipes may be of value to the student. All commonly found organ pipes are developments of the primitive flute instruments, or of those with a reed—of which the modern clarinet is an example. The materials commonly employed are wood, tin and lead mixtures, and zinc; a few

others, as for instance sheet steel, are occasionally met with. The seal—*i. e.*, the relative diameter to the length—varies tremendously; an 8 ft. *Open Diapason* pipe may be as much as 6 inches in diameter at the lowest note, while a *Viol D'Orchestre* pipe of the same note might be only about  $1\frac{5}{8}$  inches in diameter. The wind pressures employed also vary wonderfully; four to six inches pressure is generally found nowadays, but for solo organ purposes the pressures run up to fifteen, twenty, thirty, and in rare cases as high as fifty inches. Great refinement of tone as well as terrific power may be secured at will from these increased pressures; the skill of the voicer is the determining factor as to which it shall be. In Fig. 27, we illustrate a type of flute formerly much used as the heavy 8 ft. flute for the Great organ, *viz*: the *Doppel Flute*; this type of stop is interesting in that it possesses *two* mouths to the pipe instead of the usual single mouth.



FIG. 27.  
SECTION  
OF DOPPEL  
FLOETE

Of great value to the development of variety in organ tone has been the introduction of the small scale *Viols* which act as the organ counterparts of the stringed

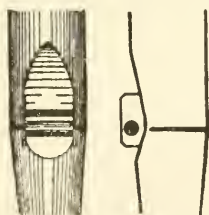
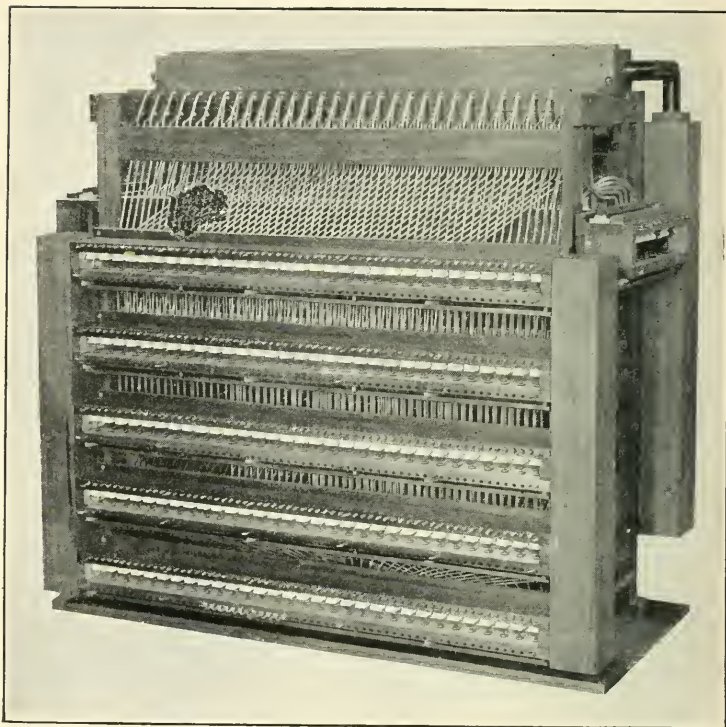

FIG. 28. SECTION OF SMALL SCALE VIOL

instruments of the orchestra. They are slender pipes, made of fine tin, and their voicing is a test of the skillfulness and patience of any voicer.

The improvement in reed voicing has been largely one of perfection of design, more accurate manufacture of reed pipes, and the wonderful advantage given by higher wind pressures than were possible before the days of modern actions; practically all of the orchestral instruments are imitated with incredible faithfulness by some of our best builders, the *French Horn*, *English Horn* and *Clarinet* stops being especially successful. So much has been accomplished that it seems possible that future developments may have to be along the lines of varied applications of percussion effects; certain it is that the instrument now more than merits the words of Honore de Balzac when he says: "The organ is in truth the grandest, the most daring, the most magnificent of all instruments invented by human genius."





PNEUMATIC COUPLER-STACK SHOWING VALVES AND TUBING BY WHICH  
COUPLING IS ACCOMPLISHED IN TUBULAR ACTION.  
(Wirsching Organ Co., Salem, O.)

## CHAPTER XI

### DICTIONARY OF ORGAN STOPS \*

**Aeoline**—8 ft., rarely 16 ft., 4 ft.

Usually the softest stop in the organ and of a slightly stringy character of tone; usually in the Swell organ. (Aeolian, Harp Acolian, Vox Angelica) = Dolce, Dulciana, Echo Salicional, Muted Viol.

**Acoustic Bass**—see Resultant Bass.

**Bass Flute**—8 ft.

The name frequently given to the octave stop of the 16 ft. Bourdon although occasionally (and erroneously) used for the octave of the 16 ft. Open Diapason; almost invariably a Pedal organ stop. (Flauto Dolce, Flute, Gedeckt, Gross Flute) = Violoncello, or couple a manual Flute stop to the pedals.

**Bassoon**—8 ft., 16 ft.

In American organs this stop appears most often as the bass octave of the Oboe stop—and in reality is very often not at all a true specimen of Bassoon stop proper; the 16 ft. form appears in large organs as a Contra Fagotta—and is usually available on both the Pedals and on one (or occasionally two) manual section—being made thus available by borrowing or duplexing. The tone is somewhat on the common Oboe type but more hollow and with a slight raspiness; it is a most useful stop when well made. (Bassoon, Fagotto, Double Trumpet) = Posaune, Violone, Contra Viol, Double Dulciana, or sub-couple a reed of Oboe type.

**Bombarde**—32 ft., 16 ft., very rarely 8 ft.

A very powerful reed stop of majestic effect; tone of Trombone quality. Found in most cases in the Pedal organ, where its sonority causes it to excel in nobility the Double Open Diapason of 32 ft. pitch. (Bombardon, Bombardone, Contra Trombone) = Contra Trombone, Contra Tuba, Tuba Profunda, Ophicleide, or full pedal organ.

**Bourdon**—see Gedeckt.

**Carillons**—8 ft., 4 ft.

Term denoting a set of tubular or flat bars of metal—graduated as to size and tuned to the notes of the scale; equipped with tuned resonators and struck by a hammer-action similar to that of the Piano-forte. The stop, in one of its various forms, is becoming quite a usual part of the equipment of large organs; it is frequently called the *Harp* stop—to which instrument

\* The names following the sign = denote stops or combinations of stops which may be used as substitutes should the desired stop be unavailable.



it has in many cases not a little resemblance. The term is sometimes used to indicate a set of tubular *Chimes*—to which use it should not be put; the imitative tubular Chimes should invariably be designated by a name which will clearly indicate that the stop is of the imitative bell type; for stops of the plate-and-resonator type the terms *Carillon* or *Celesta*, or the more easily and generally understood *Harp*, are adequate. (Glockenspiel, Carillon, Tubular Bells)=a Gross Flute played staccato will sometimes simulate a Carillon effect, as will the combination of a 16 ft. Bourbon and a soft 2 ft. stop with tremulant and swell-shades closed.

### Celeste

Denotes a stop of two ranks—one of which may or may not be available as a single stop for general use; the extra rank is termed the *Celeste* rank and is to be invariably used with the similar stop provided in the specification. The Celeste stop is tuned slightly sharp or flat to the pitch of the relative stop, thus producing when the two are used together a delightful wave-like or vibrato effect of considerable value in lending warmth to the tonal effect. The most common form is the *Vox Celeste*, or *String Celeste*—in which stop the simulation of the wrist-vibrato of string instrument players is most marked; of late Flute Celeste stops have been introduced, sometimes under the name *Unda Maris*, and these stops also are of very great usefulness. It may be remarked that where these stops are provided the player need not employ the tremolo to anything like the extent necessary when such is not the case, as the stops in themselves provide the vibrato formerly the exclusive production of the tremolo.=Where Celestes are not available the Tremolo is the one and only possible means of assistance.

**Cello**—see Violoncello.

**Clarabella**—8 ft., rarely 4 ft., 16 ft.

A bright-toned flute which of late has been largely supplanted by the less attractive *Melodia*; the tone is purer and more liquid than the latter stop. It is an accompanying stop *par excellence* and is usually scaled and voiced with that purpose in view. (*Melodia*, Concert Flute, Claribel Flute) =Use a Gedeckt or a soft flute or Dulciana as a substitute.

**Chimes**—pitch indefinite.

Tubular bells struck by a hammer-action similar to that of the piano-forte and connected with one or more of the keyboards; they should be as remote from the main organ and the listeners as can be arranged, and in playing them it is well to keep the swell-shades almost entirely closed—else the effect will resemble fire-gongs more than the desired church chimes! No really effective substitute is possible; where a Celesta is available it is sometimes possible to produce a passable imitation by playing staccato on the combination of Celesta and Gross Flute—if the latter is not too loud. But as a general thing it is better not to attempt any literal imitations.

**Clarinet**—8 ft., occasionally 16 ft.

The modern Clarinet stop is perhaps the very closest imitation of the orchestral prototype which the modern organ affords; sweet and clear in tone and with a peculiar hollow warmth in the lower or *chalmey* register, it combines well with other stops (much better than the common Oboe) and its voice in solo passages does not cloy as quickly as the latter stop. (Corno di Bassetto, Corno di Caccia, Cremona, Krummhorn, Orchestral Clarinet) =Oboe, Salicional and 4 ft. Flute, soft Gamba.

**Clarion**—4 ft.

An octave reed stop usually of considerable brilliancy; generally the octave stop of the Great or Solo Tuba or Trumpet stops. (Clarione, Harmonic Clarion, Tuba Clarion, Trumpet Clarion)=Use a super coupler or couplers where absolutely necessary.

**Concert Flute**—8 ft., 4 ft.

Until recent years this was most often a 4 ft. stop of somewhat imitative voicing, its prototype being the orchestral flute; recently the name has been also utilized for a stop of quiet, un-orchestral flute tone—not unlike the Melodia but rather softer and somewhat more pure in quality. (Orchestral Flute, Concert Flute, Konzertfloete) = Melodia, Clarabella, Flauto Dolce, Flute d'Amour or a soft Gedeckt stop if no open flute is available.

**Contra**—(Latin prefix)

Term denoting stops of sub-octave pitch—*double* stops, as Contra Bourdon, *i.e.*,—of pitch an octave below the normal Bourdon. Applied to many classes of stops.

**Contra Bass**—16 ft.

Should be invariably reserved for the Violone or similar stops, but is wrongly used occasionally for the pedal 16 ft. Open Diapason. Should be imitative of the Double-Bass of the Orchestra. (Violon Bass, Contre-Basse) = Bourdon, Dulciana, Gedeckt, Gamba.

**Cor Anglais**—8 ft., rarely 16 ft.

Imitative of the English Horn of the orchestra; purely a solo stop, and does not combine at all well, and moreover—it has an unhappy faculty for getting out of tune very rapidly. (English Horn, Corno Inglese) = Gamba (soft) and Flute d'Amour, Clarinet and 4 ft. Gemshorn.

**Cornet**—see Mixture.

**Corno**—8 ft.

Generally the most powerful stop of the Swell organ; a reed of rather more round and full tone than that of the Trumpet. A fine solo stop when well voiced; with the swell shades closed it gives a fine imitation of the baritone Horn of the brass band and in chords a suggestion of Trombone quality. (Horn, Posaune, Tuba) = Combinations of Diapasons, Flutes and Oboe will suggest the Corno quality.

**Coupler**

A mechanical aid for combining at various pitches the different departments of the organ. See Chapter on Couplers and their use.

**Diapason**—32 ft., 16 ft., 8 ft., 4 ft., 2 ft., and Mixture work.

The Diapason family—the backbone of the organ—are unique in that they produce a quality of tone having no prototype among orchestral or other instruments; the tone may therefore be considered as one of the (if indeed not *the*) most characteristic attributes of the organ, and in truth it is this quality of tone which—more than any other—distinguishes the organ from all other instruments. The nearest resemblance is to that of softly played Trombones in the middle register of 8 ft. stops; above and below that there

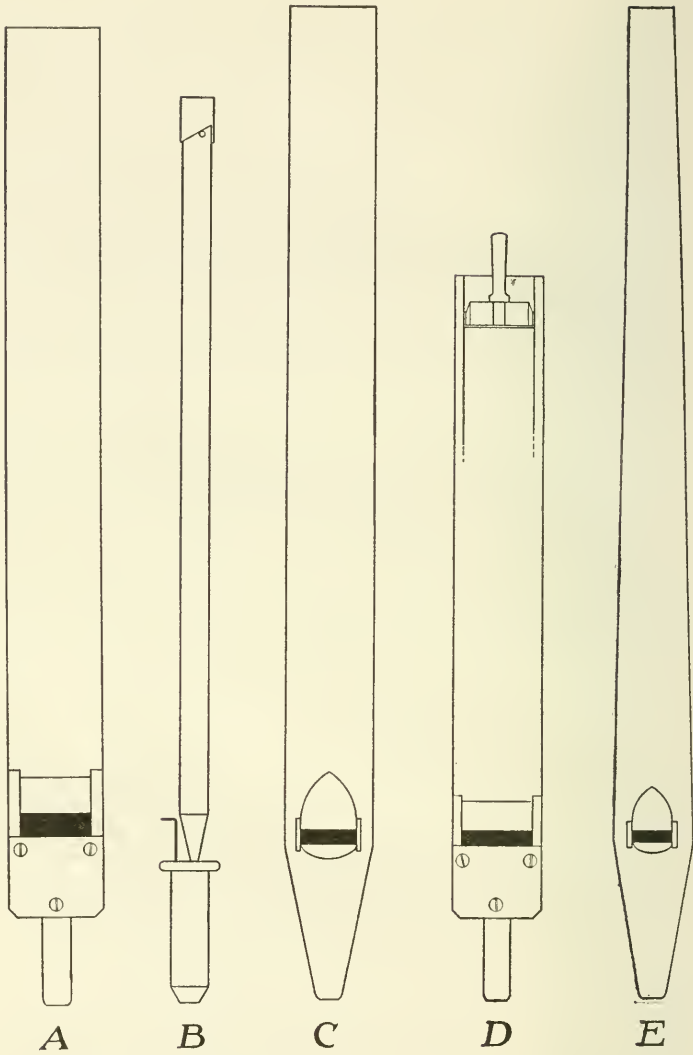

FIG. 29. *a*, Clarabella; *b*, Clarinet; *c*, Diapason; *d*, Gedeckt;  
*e*, Gemshorn.

is absolutely no other tone to which it can be likened. Despite this extreme distinctiveness the character of Diapason tone varies considerably, and so we find it appearing in many forms which partake somewhat of the characteristics of other tone-families, *i.e.*—the Geigen-Principal—with a trace of the String, the Leathered-Lip Diapason—with something of a fluty nature, etc. The old Bell Diapason, in which the pipes were surmounted by a conical bell is now obsolete, due largely to the over-crowded condition of present-day organ chambers. The Diapason Phonon, invented by the late Robert Hope-Jones, is a leathered-lip variety speaking on heavy wind-pressure, and producing a tone of much combinational as well as individual worth. (Principal, Montre, Flûte de Huit)=No substitutes are possible, and indeed none will be needed—except that perhaps in the very smallest organs (we are tempted to say “toy” organs!) it may be necessary to use combinations of other stops to supply a substitute for a missing Diapason on one or more manuals. In Pedal organs where—through lack of sufficient funds—the Open Diapason of 16 ft. has been omitted it is necessary to utilize the usually present stops of Bourdon type—although with an entire loss of that grandeur and majestic dignity so characteristic of the organ at its best.

**Diaphone**—32 ft., 16 ft., 8 ft.

Stops developed by the late Robert Hope-Jones. The principle used is that of a vibrating diaphragm or tremulant—the frequency of which is governed by the length of the resonator with which it is employed, while the power is limited only by the available wind pressure, a corresponding increase of power following the raising of the pressure. Various qualities of tone may be produced, although at present the only forms in use partake of the nature of the Diapason or Tuba families; in some of these latter forms the power is almost unbearable. The Diaphone presents interesting features but cannot be said to be a fully developed proposition as yet. It is unlikely that any specific call for the stops will be found indicated in printed music.

**Dolce**—8 ft. Sometimes 16 ft., 4 ft. See Dulciana.

**Dolcissimo**—8 ft., 16 ft. See Dulciana.

**Doppel Floete**—8 ft. Rarely 16 ft., 4 ft.

A flute provided with *two* mouths; tone thick, rather colorless. Formerly considered the best flute for the Great organ, but happily now being much less utilized; as a solo stop it is worthless. It is being supplanted by stops of the Gross Flute type. (Doppel Gedackt)=Gross Flute, Clarabella, Gross Gedackt, Melodia, or a soft Diapason—if of smooth tone.

**Double Diapason**—32 ft., 16 ft.

Sub-octave stops of the Diapason family—which see.=Double Gedeckt or Bourdon, Contra Dulciana, or perhaps a sub-octave coupler.

**Dulciana**—8 ft., also 16 ft., 4 ft.

Soft, sweet-toned stops, somewhat of the Diapason quality of tone but voiced with a slightly *horny* timbre; of prime worth as accompanying stops. Found most often as the softest stop of the Great or Choir organs. (Echo Dulciana, Dolce, Dolcissimo, Duleet)=Aoline, Vox Angelica, Echo Salicional, Muted Viol, Melodia.

**Contra Fagotta**—16 ft. See Bassoon.

**Fern Flute**—4 ft., rarely 8 ft.

Generally a very soft flute of somewhat imitative tone; the name is loosely employed, however, in this country.=Use any available soft flute as substitute.

**Fifteenth**—2 ft.

Of Diapason tone at super-octave pitch; adds brilliancy and pitch-definition to the normal and octave pitch Diapasons. See Diapason. (Super Octave)=Piccolo, Flageolet, Flautina, or a super-octave coupler.

**Flageolet**—2 ft.

Softer and of more fluty tone than the Fifteenth, which see.

**Flauto Amabile**—8 ft., 4 ft

Similar to the Concert Flute, which see.

**Flauto Traverso**—4 ft. Rarely 8 ft., 2 ft.

Should be the nearest imitation possible of the orchestral Flute, and in some examples a close resemblance is attained. But in all too many cases it is nothing but a soft sweet-toned flute of no particular distinction. See Flute.

**Flauto Harmonique**—See Harmonic Flute.

**Flute**—32 ft., 16 ft., 8 ft., 4 ft., 2 ft. (Rarely Mutation.)

A generic term—covering a great variety of tone; runs the gamut from common organ tone (such as Melodia), used primarily for accompanying work, to imitative stops of much beauty. The term may even be regarded for practical purposes, as covering the Gedeckt stops. Roughly classified Flute stops fall into two divisions:

- 1st. Solo Flutes, mostly at 4 ft., but also occasionally at 8 ft. Such are the Flute Harmonique, Flute d'Orchestre, Flute d'Amour, Traverso Flute, Gross Flute, etc.
- 2d. Accompanimental Flutes, and Flutes intended for Pedal organ and combinational use primarily. Such include Melodia, Clarabella, Concert Flute (as often voiced), Gedeckts, Bourdons, etc.

These stops are, of course, freely interchangeable among members of their own class, but care must be taken not to use as a substitute for a quiet accompanimental stop a flute of pronounced solo attributes.

**French Horn**—8 ft.

The most successful type of this stop is that invented by Mr. Ernest M. Skinner, of Boston, Mass., and the stop is found on few organs other than his; a triumph of fidelity to its orchestral model.=A soft Gross Flute, or leathred-lip Diapason may be substituted; the Swell Open Diapason alone, with closed Swell-shades is often a fairly good effect.

**Gamba**—16 ft., 8 ft., 4 ft. (rarely.)

The original string stops of the organ, the Gambas were of a hard, horny and rather raspy tone—even strident in some examples; from them have been developed the modern String stops which can truly be said to represent one of the *great advancements* of modern organ building. However, a modern softly voiced Gamba is a valuable stop for the Great organ, producing a

soft 'cello-like tone of considerable warmth. (Viola da Gamba, Gambette, Bell Gamba, Contra Gamba)=When not present use a modern Viol, Salicional or a soft Oboe or Clarinet if on a manual where the Strings cannot be utilized.

**Gedeekt**—32 ft., 16 ft., 8 ft., 4 ft.

Stops of a dull, unimitative flute tone, cloying and wearisome if used alone for any length of time; these stops are also called Stopped Diapason—misleadingly, however, as they are in no sense of the Diapason family. This faulty terminology is, fortunately, being less employed of recent years (Bourdon, Stopped Diapason, Tibia)=Flutes are the natural substitutes, or a soft Dulciana type of stop if needed for accompanying purposes.

**Geigen-Principal**—8 ft., 4 ft.

A variety of Diapason voiced with a bite to the tone which in some examples is positively fiery; partakes of the characteristics of both Diapason and Gamba. (Violin Diapason)=Some such combination as Salicional and Diapason, or Gamba and Gedeekt.

**Gemshorn**—4 ft., occasionally 8 ft.

Tone soft and sweet and rather reedy in timbre, something half-way between string and flute tone; pipes are conical in shape.=Use a soft flute or very soft Diapason or Dulciana.

**Gloekenspiel**—See Carillons.

**Gross Flute** (Grosse Floete)—8 ft., 16 ft.

A full-toned flute of large-scale Clarabella pipes, much used in Great and Solo organs, and of much value both as a solo stop and for combinational purposes; it has really remarkable "filling" properties and supports heavy reeds most admirably. (Grossfloete, Grosshohlfloete, Gross Gedackt)=Any flute of full tone, or where necessary—Clarabella or Melodia.

It is to be regretted that this polyglot stop name has been so generally adopted throughout the country; either the original German form given in parentheses should be used, or much better and clearer would be the literal English translation *Great Flute*—a very happy terminology in view of the almost universal custom of placing the stop in the Great Organ. Bi-lingual stop-names are much too prevalent with us and should be suppressed as rapidly as possible by those who have to do with writing organ specifications.

**Harmonia Aethera**—8 ft., or Mutation.

In two forms, *1st.* Similar to the Aeoline. *2d.* As a soft Mixture stop. See Mixture.

**Harmonic Flute**—4 ft., rarely 8 ft.

Flutes of rather strong intonation; the pipes (in at least a portion of the compass) are of double length, pierced with a hole near the middle of the pipe, and over-blown. The most usual form of flute for the Swell organ; the Flauto Traverso is often made in this way. (Flauto Harmonique, Flauto Armonica, Flute Octavante)=Fernflute, Flute d'Amour, Chimney Flute, or other flute.

**Harp**—8 ft.

Generally a modified form of Carillon—which see.



**Hautboy**—See Oboe.

**Hohl Flute**—8 ft., occasionally 16 ft., 4 ft.

A flute of rather hollow though smooth tone, not being used as much of recent years as formerly; the stop was made in many different forms. (Hohlfloete, Rohrfloete, Waldfloete)=Gross Flute, Doppel Floete, Clarabella, or other flute.

**Horn**—8 ft.

Practically the same as the Cornopean, which see.

**Horn Diapason**—8 ft.

A species of hard-toned Diapason, not unlike the Geigen Principal, but less pleasing than that stop; the tone becomes very wearisome after a brief time. See Diapason.

**Keraulophon**—8 ft.

A peculiar, almost indescribable tone characterizes this stop; soft, a little muffled, even a bit like the tone of muted Horns in the orchestra. It is a great pity that this stop is not more often used than is at present the case.=Dulciana, Spitzfloete, Salicional.

**Lieblich**—German prefix meaning *lovely*, applied to various stops.

**Major Bass**—32 ft., 16 ft.

Denoting the Pedal Open Diapason, which see.

**Melodia**—8 ft., rarely 16 ft., 4 ft.

Much employed as the soft Flute for the Great or Choir organs; akin to the Clarabella, but not so colorful as that stop, and—in many examples—inclined to be rather “breathy” in speech.=Any soft flute may substitute.

### Mixture

Harmonic-corroborating, or mixture stops are composed of from two to six ranks of pipes—these pipes speaking, in part, other notes than the unison or octave pitches of the notes played; the notes are those which compose the harmonic-series of tones—which taken together determine the timbre of the tones. It was early discovered that Diapasons in themselves were deficient in brilliancy and that any effort to force these higher partials by increasing wind-pressure or treatment in voicing only resulted in giving the pipes a hard and unpleasant tone; it was therefore necessary to resort to stops which would produce the needed tones as accessories to the Diapason stops themselves. Mixtures were the result; like all good things their purpose was misunderstood by some—with the result that they were in some examples simply intolerable: screaming, noisy, un-musical things. Present-day taste has now swung to the other extreme, and many organs are being built without any mixtures whatsoever; this is to be regretted, as they are of great value when properly designed, scaled, and voiced. (Rauschquint, Cornet, Acuta, Full Mixture)=Where not present, add in the order needed: 4 ft. stops, 2 ft. stops, and if essential, super couplers.

**Montre**—French name for Diapason, which see.

**Mutation Stop**—Generic term for Mixture stops, which see.



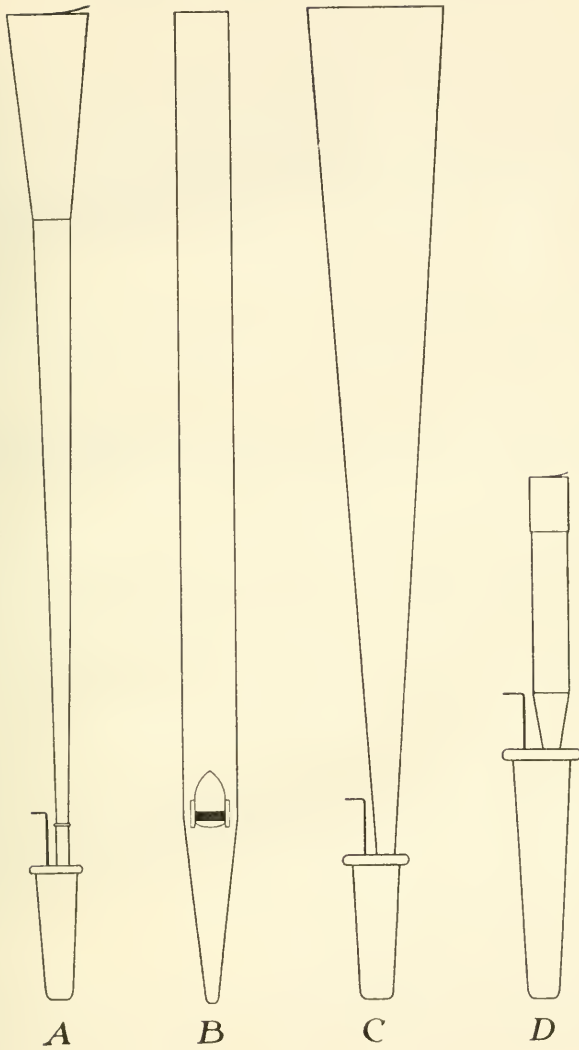

FIG. 30.

*a*, Oboe; *b*, Salicional; *c*, Trumpet; *d*, Vox Humana.

**Muted Viol**—see Viol Sourdine.

**Oboe**—8 ft., occasionally 16 ft., 4 ft.

Without doubt the most used reed stop in organs, and while it is rarely a good imitation of the orchestral instrument (barring the few successful Orchestral Oboe specimens) it is a solo stop *par excellence*, and generally a fair combinational stop. Generally found in the Swell organ; when of the Orchestral type it possesses no combining ability whatsoever. (Hautboy, Hautbois, Hoboe, Echo Oboe, Oboe d'Amour)=A fair substitute in solo work is the combination of Salicional and 4 ft. Flute, or—better still—Clarinet and 4 ft. Flute.

**Octave**—4 ft., manual; 8 ft., pedal.

Name given to octave stops of the Diapason family on the manuals and pedals respectively. See Diapason.

**Octave Coupler**—see Coupler.

**Piccolo**—2 ft.

A super-octave stop of fluty tone, more liquid and pleasing than the Fifteenth and fuller than either the Flageolet or Flautina; usually on either the Choir or Swell organs. (Piccolo Harmonic).

= Fifteenth, Flageolet, Flautina, or super couple if necessary.

**Posaune** (Trombone)—8 ft., 16 ft. (Contra Posaune.) Also on Pedal organ where the Contra term denotes a 32 ft. stop.

A reed stop of Trombone quality, sometimes rather rough; a cross between the smooth Tuba and the more cutting Trumpet.=Trumpet, Tuba, Tromba, Cornopean, Trumpet and Diapason.

**Principal**—4 ft.

Same as Octave Diapason. See Diapason.

**Quint**—10—2—3rds ft., 5—1—3rd ft., 2—2—3rds ft.

A mutation stop sounding the interval of the fifth above the unison pitch; the 2—2—3rds ft. variety is the most common—and speaks the octave—fifth above unison—thus filling up the harmonic series. The 10—2—3rds ft. form is found frequently on the Pedal organ where it produces, in combination with the 16 ft. stops, a soft Resultant 32 ft. effect. (Acoustic Bass, Harmonic Bass; rarely: Gravissima and Gravitone)=Some players achieve the effect—on rare instances where it is felt to be absolutely necessary—by playing the interval of the fifth above on the pedals along with the pedal notes. This should be resorted to most infrequently.

**Quintaton**—8 ft. Rarely 16 ft., 4 ft.

A stop composed of closed pipes voiced to sound the interval of the twelfth, or octave-fifth, above and with the prime tone, giving something of the effect of two pipes speaking at once; a very valuable combinational stop, and occasionally of solo value. (Quintadena, Quintaten, Quintaden)=No substitutes possible, but soft Viols are recommended where the stop is especially called for.

**Resultant Bass**—32 ft.

The effect produced by the combination of the Pedal 16 ft. Open Diapason

and a 10—2—3rds ft. Quint stop; the coincidence of beats of different frequency gives rise to the effect of a 32 ft. tone. See Quint.

**Rohrfloete** (Chimney Flute)—8 ft. See Flute.

**Salicional**—8 ft., 16 ft., 4 ft.

Stops originally of horny timbre, later voiced somewhat stringy and at present varying from this quasi-stringy quality to a frankly and decidedly stringy tone. They were developed from the Gamba tribe and from them have been developed the modern Viols. They still appear in many organs as the only strings included—partly because they combine with other stops rather better than do the true Viols. (Salicet, Gambette)=Viols, or soft Gambas.

**Spitzfloete**—8 ft.

Of a peculiarly thin, nasal quality of flute tone; very useful.

= Any soft flute may substitute; very soft Salicional (or Aeoline) and Soft Flute sometimes good.

**Stopped Diapason**—16 ft., 8 ft., 4 ft. See Gedeckt.

**Super Octave**—Name used for the Fifteenth, which see.

**Tibia**—Various pitches.

A tribe of foundational stops claim this title—all of them inclining more or less to the Flute quality; the name has been in use for some years, but the most recent and striking examples of Tibias are to be found among the developments of the late Robert Hope-Jones. *Tibia Clausa*: a very large scale Gedeckt of copious liquid tone. *Tibia Plena*: similar, but of open pipes. *Tibia Dura*: tone bright and clear, if somewhat hard, and quite penetrating. *Tibia Minor*: somewhat akin to the *Tibia Clausa*, but softer. *Tibia Major*: a full toned and powerful flute, similar to the *Hohlfloete*. *Tibia Profunda*, generally a Pedal stop of one of the above.

= Powerful flute stops, or Diapasons and Flutes as substitutes.

**Tremulant**—Also more generally Tremolo.

A mechanical device for imparting a wave-like motion to the wind supplying the organ—thus producing a delightful undulatory effect from the pipes; a perfect Tremulant is a rarity, but when achieved is a real delight. Found in all organs, large or small.

**Tromba**—see Tuba.

**Trombone**—see Tuba.

**Trumpet**—8 ft., also 16 ft.

A powerful reed stop usually found on the Great organ; tone is cutting, blattant in many instances and many times thinner than that of its orchestral namesake. The modern Tuba is a vastly better stop in every way. = Full complement of stops or all the 8 ft. stops.

**Tuba**—16 ft., 8 ft., 4 ft.

Reed stops of thick, fat tone—often the most powerful stops in the organ; the quality is smoother, warmer, more rounded and in every way better than

the Trumpet—which stop the Tuba is fast supplanting. The Tuba *Mirabilis* (wonderful) voiced on very heavy wind pressure, dominates the whole of a large organ; tremendously effective to imitate the brass section of the orchestra. = Any powerful reed (Trumpet or Cornopean) combined with Diapasons and heavy Flutes may be used for substitute.

**Twelfth**—2—2—3rds ft.

Mutation stop similar to the Quint—which see. No substitutes.

**Unda Maris**—8 ft.

The name is carelessly used in this country; some denote by it a Celeste stop of Flute pipes (Spitzfloete or Clarabella pipes), while at least one builder is using it for a Celeste stop composed of two ranks of Aeoline or soft Dulciana pipes and of exceedingly beautiful tone. However, there is a degree of satisfaction in knowing that one may expect a soft Celeste of one or the other qualities of tone! = Use a soft Flute, Dulciana or Aeoline.

**Viol Da Gamba**—see Gamba.

**Viol D'Orchestre**—8 ft. Also Contra Viol—16 ft.

The organ has been wonderfully enriched of recent years by the development of the modern family of keen-toned viols. or string stops. Founded upon the Gamba and Salicional type they have been developed to a point where the tone is of delightful keenness and—in the best examples—they achieve a particularly happy imitation of the solo Violin—especially when they are in the Celeste form, the slight wavering or vibrato of the tone recalling the wrist-vibrato of the violinist. The Contra Viol is a stop that is found all too rarely. (Viola, Viola d'Orchestra, Cello, Violoncello, String) = Salicionals or Gambas.

**Viol Sourdine**—8 ft.

The thinnest tone obtainable from a flue pipe; the Viol stop pushed to its extremest limit. Tone beautifully quiet, soft but penetrating—and with a real suggestion of the “resin in the tone!” (Muted Viol.) Of most ethereal beauty when in the Celeste form.

= Aeoline or Dulciana as substitute.

**Violone**—16 ft.

Generally a Pedal string stop—imitative of the double-bass of the orchestra; the tone possesses some of the weight of the Double Dulciana, but has more cut to it—in fact in many examples the “rasp of the bow” is plainly recognizable. = Bourdons or Gedeckts.

**Violoncello**—8 ft.

Most often a pedal stop, sometimes the upper extension of the Violone; tone quite imitative of the orchestral 'Cello, and lends a fine incisiveness to the Pedal Organ. (Cello) = Bass Flute, or couple a manual String stop to the Pedals.

**Vox Celeste**—see Celeste.

**Vox Humana**—8 ft. Occasionally 16 ft.

A reed stop, originally supposed to imitate the human voice; this it does not do and never did, but—being of a thin, nasal, smothered quality—some good people are led (by the assistance which the name gives to the imagina-

tion!) to think that the resemblance is really achieved. However, it is (despite all the abuse which has been hurled upon it) a valuable stop, particularly when used in combination with modern String and Flute Celeste stops, and when so used has the faculty of adding to the tone a suggestion of the "resin of the strings" of the orchestra. It must be admitted, too, that in especially fine examples, and in locations where the acoustic conditions are particularly favorable, there is often a considerable resemblance in the lower octaves to the tone of a male choir heard from afar. (Voix Humaine) = Clarinet and 4 ft. Flute with Tremolo and Swell-shades closed sometimes give a passable imitation of the Vox Humana; otherwise use Strings.

**Wald Flute** (Waldfloete)—8 ft., 4 ft.

Valuable as a solo stop; tone slightly honny but of some little volume and very pleasing. In some examples the voicing is similar to the Gross Flute: this is not to be encouraged. (Feldflöte) = Any medium strength Flute may substitute.



# THE MUSIC STUDENTS LIBRARY

A series of Educational Text-Books suited to the requirements of the average student and covering every essential branch of musical instruction.

## PIANO

R

<b>Burrowes' Piano Primer.</b> Fred. Field Bullard, Ed. Enlarged edition with pronouncing dictionary.	\$1 00
do. .... <i>Paper</i>	50
<b>Ears, Brain and Fingers.</b> Howard Wells. Combines ear training with piano technic. .... <i>Illus.</i>	1 25
<b>Half Hour Lessons in Music.</b> Mrs. Hermann Kotzschmar. Class work and games for beginners. For teachers and mothers. .... <i>Illus.</i>	1 25
<b>Interpretation of Piano Music.</b> Mary Venable. Studies in the meaning of printed signs used in music, and their bearing on the interpretation of standard works. ....	2 00
<b>Natural Laws in Piano Technic.</b> Mary Wood Chase. Presents the essential laws of a sound piano technic. .... <i>Illus.</i>	1 50
<b>Piano Teaching: Its Principles and Problems.</b> Clarence G. Hamilton, A.M. Written by a practical man to meet practical needs. .... <i>Illus.</i>	1 50

## ORGAN

<b>Primer of Organ Registration.</b> Gordon Balch Nevin. Clear, concise, fully illustrated and with interlocking Dictionary of Organ Stops. ....	1 50
--	------

## VIOLIN

<b>How to Master the Violin.</b> Pavel L. Bytovetzski. A practical guide for students and teachers. . . <i>Illus.</i>	1 25
<b>How to Study Kreutzer.</b> Benjamin Cutter. What every violin teacher discusses and illustrates in the lesson room. ....	1 00

Note:—These books are bound in neat, serviceable cloth.

## VOICE

<b>A B C of Music.</b> Auguste Mathieu Panseron. (Ed. by N. C. Page.) A standard primer of vocalization	1 50
<b>Commonplaces of Vocal Art.</b> Louis Arthur Russell. The plain truths of vocal art presented in simple untechnical language. ....	1 25

<b>English Diction for Singers and Speakers.</b> Louis Arthur Russell. For all who seek refined or artistic use of the English language.....	R 1 25
<b>French Diction for Singers and Speakers.</b> William Harkness Arnold. The elements of French pronunciation reduced to a few fundamental principles, readily mastered.....	1 25
<b>Head Voice and Other Problems.</b> D. A. Clippinger.....	1 25

### PRACTICAL TALKS ON SINGING

<b>Resonance in Singing and Speaking.</b> Thomas Fillebrown, M.D. An exposition of fundamentals, with breathing, and vocal exercises..... <i>Illus.</i>	1 50
<b>Training of Boys' Voices.</b> Claude Ellsworth Johnson. A guide to the correct "placing" of boys' voices....	1 00
<b>Twelve Lessons in the Fundamentals of Voice Production.</b> Arthur L. Manchester. Presents clearly the fundamentals illustrated by exercises.	1 25

### EAR TRAINING, HARMONY AND COUNTERPOINT

<b>Ear Training for Teacher and Pupil.</b> C. A. Alchin. Designed to teach the pupil to think in tones, and so to sing, name, write, and play what he hears.....	1 50
<b>Intervals, Chords, and Ear Training.</b> Jean Parkman Brown. Exercises and examples in rudimentary harmony and ear training for use in conjunction with piano study.....	1 25
<b>Harmony.</b> Sir John Stainer, Mus. Doc. A standard text-book presenting the principles of harmony with conciseness and lucidity.....	1 50
<b>Harmony Simplified.</b> Francis L. York. A practical text-book presenting in a concise manner the fundamental principles of harmony, with non-essentials omitted.....	1 50
<b>Manual of Harmony.</b> Ernst Friedrich Richter. Trans. by J. C. D. Parker. A practical guide to the study of harmony.....	2 00
<b>Harmonic Analysis.</b> Benjamin Cutter. Teaches one to analyze the harmonic structure of both classic and modern music.....	1 50
<b>Counterpoint.</b> Sir J. Frederick Bridge. Combines freshness and plainness with thoroughness.....	1 50
<b>Counterpoint Simplified.</b> Francis L. York. A concise text-book of formal counterpoint. (Sequel to author's "Harmony Simplified").....	1 50



<b>Guide to Musical Composition.</b> H. Wohlfahrt. Tr. by J. S. Dwight. On the invention of melodies, their transformation, development and suitable accompaniment.....	R 1 25
---	-----------

### FORM, INSTRUMENTATION AND ACOUSTICS

<b>Instrumentation.</b> Ebenezer Prout, Mus. Doc. A valuable guide and assistant to students who wish to gain a knowledge of the proper blending of orchestral instruments, their compass, capabilities, etc.....	1 50
<b>Lessons in Music Form.</b> Percy Goetschius, Mus. Doc. A manual of analysis of all the structural factors and designs employed in musical composition.....	1 50
<b>Musical Forms.</b> Ernest Pauer. A compendium of the various styles or species of composition with analysis of their structure.....	1 50
<b>Sound and Its Relation to Music.</b> Clarence G. Hamilton, A.M. A handbook of acoustics as relating to music. Based on the latest discoveries and experiments. Fully illustrated.....	1 50

### CONDUCTING, HISTORY, MUSIC APPRECIATION AND DEFINITIONS

<b>Essentials in Conducting.</b> Karl W. Gehrrens, A.M. On personal requirements, technic of the baton, interpretation, rehearsing, program making, etc.	1 50
<b>Outlines of Music History.</b> Clarence G. Hamilton, A.M. A compact, clearcut work for class use and the general reader. Fully illustrated.....	1 75
<b>Music Appreciation.</b> Clarence G. Hamilton, A.M. Based on methods of literary criticism, this unique text-book is for those who wish to listen to music with quickened hearing and real understanding. With 24 portraits, 28 diagrams and over 200 music cuts.....	1 75
<b>Music Club Programs from All Nations.</b> Arthur Elson. Outlines the various schools from all nations with a rich series of programs and over one hundred portraits.....	1 75
<b>Some Essentials in Musieal Definitions.</b> M. F. MacConnell. A manual of definite information concerning the points every music student should be sure of.....	1 25



MT  
189  
N44

University of California  
SOUTHERN REGIONAL LIBRARY FACILITY  
305 De Neve Drive - Parking Lot 17 • Box 951388  
LOS ANGELES, CALIFORNIA 90095-1388

Return this material to the library from which it was borrowed.

Q  
N  
J  
J  
R



3 1205 00155 1363

*ej*

UC SOUTHERN REGIONAL LIBRARY FACILITY



**AA** 000 137 874 4

Univers  
South  
Libr