



This is a digital copy of a book that was preserved for generations on library shelves before it was carefully scanned by Google as part of a project to make the world's books discoverable online.

It has survived long enough for the copyright to expire and the book to enter the public domain. A public domain book is one that was never subject to copyright or whose legal copyright term has expired. Whether a book is in the public domain may vary country to country. Public domain books are our gateways to the past, representing a wealth of history, culture and knowledge that's often difficult to discover.

Marks, notations and other marginalia present in the original volume will appear in this file - a reminder of this book's long journey from the publisher to a library and finally to you.

Usage guidelines

Google is proud to partner with libraries to digitize public domain materials and make them widely accessible. Public domain books belong to the public and we are merely their custodians. Nevertheless, this work is expensive, so in order to keep providing this resource, we have taken steps to prevent abuse by commercial parties, including placing technical restrictions on automated querying.

We also ask that you:

- + *Make non-commercial use of the files* We designed Google Book Search for use by individuals, and we request that you use these files for personal, non-commercial purposes.
- + *Refrain from automated querying* Do not send automated queries of any sort to Google's system: If you are conducting research on machine translation, optical character recognition or other areas where access to a large amount of text is helpful, please contact us. We encourage the use of public domain materials for these purposes and may be able to help.
- + *Maintain attribution* The Google "watermark" you see on each file is essential for informing people about this project and helping them find additional materials through Google Book Search. Please do not remove it.
- + *Keep it legal* Whatever your use, remember that you are responsible for ensuring that what you are doing is legal. Do not assume that just because we believe a book is in the public domain for users in the United States, that the work is also in the public domain for users in other countries. Whether a book is still in copyright varies from country to country, and we can't offer guidance on whether any specific use of any specific book is allowed. Please do not assume that a book's appearance in Google Book Search means it can be used in any manner anywhere in the world. Copyright infringement liability can be quite severe.

About Google Book Search

Google's mission is to organize the world's information and to make it universally accessible and useful. Google Book Search helps readers discover the world's books while helping authors and publishers reach new audiences. You can search through the full text of this book on the web at <http://books.google.com/>



REPAIRED BY

WISCONSIN

W P A

BOOK REPAIR

PROJECT NO.

94.21.

Date July 19.39.



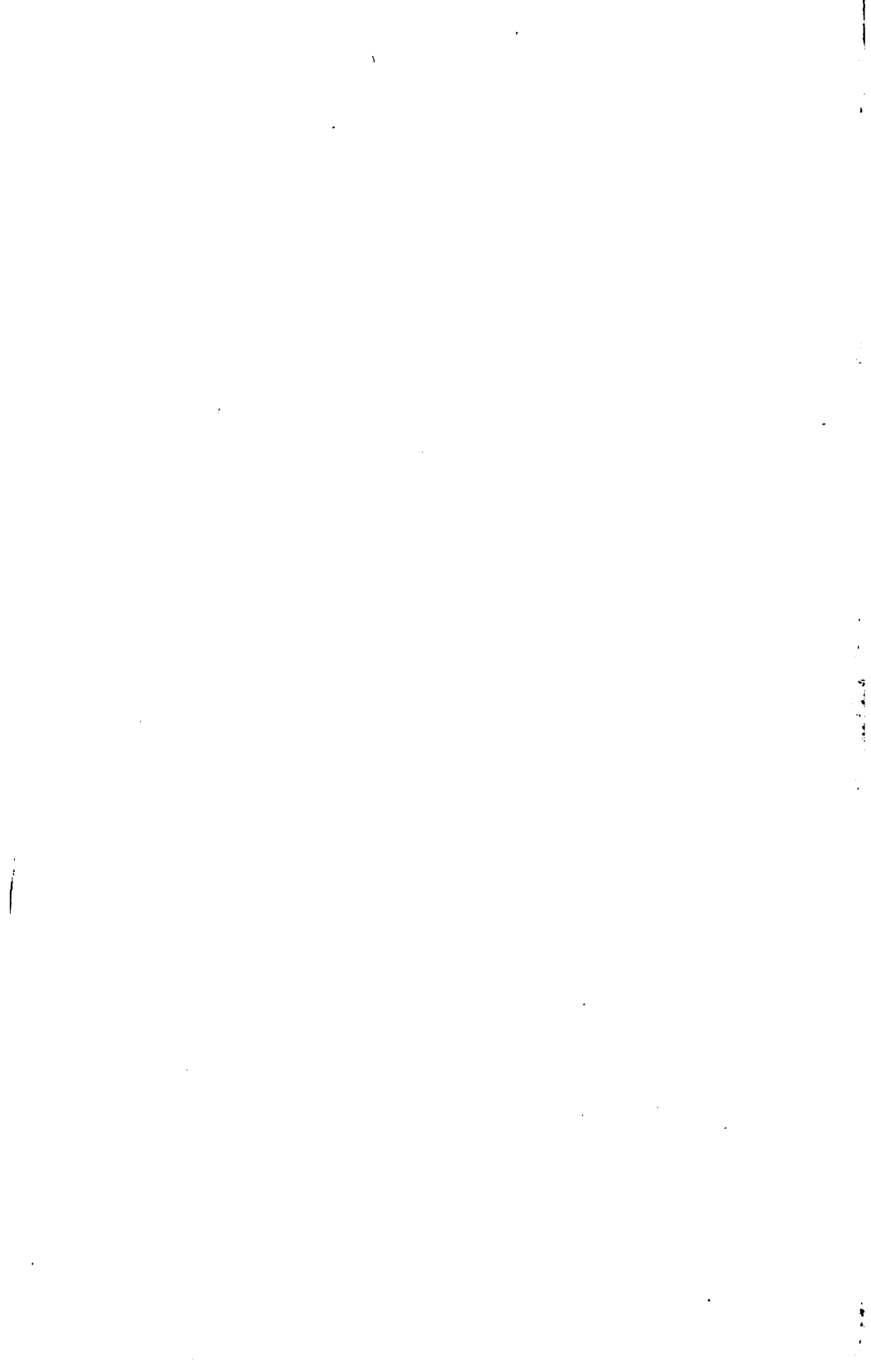



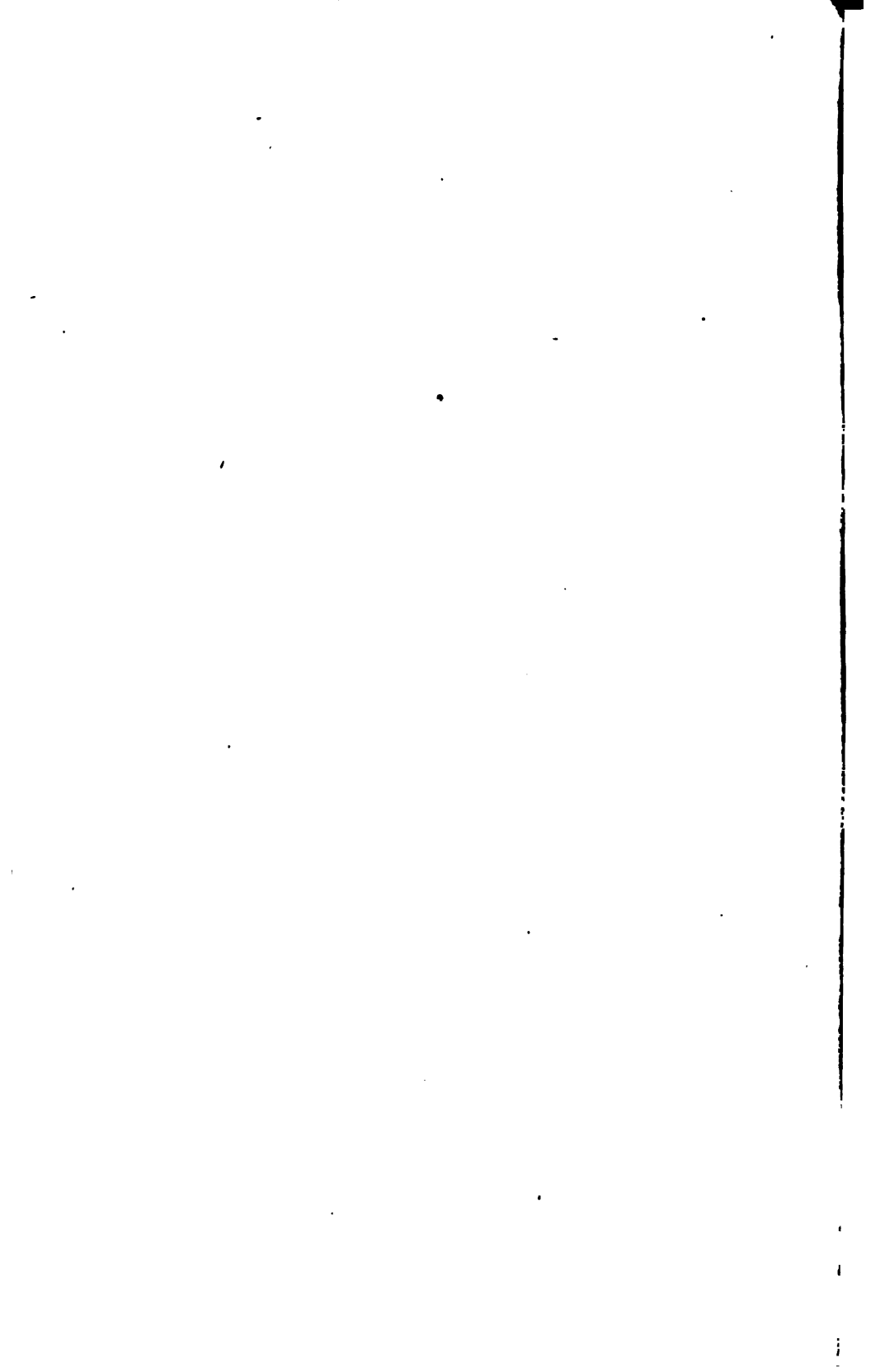

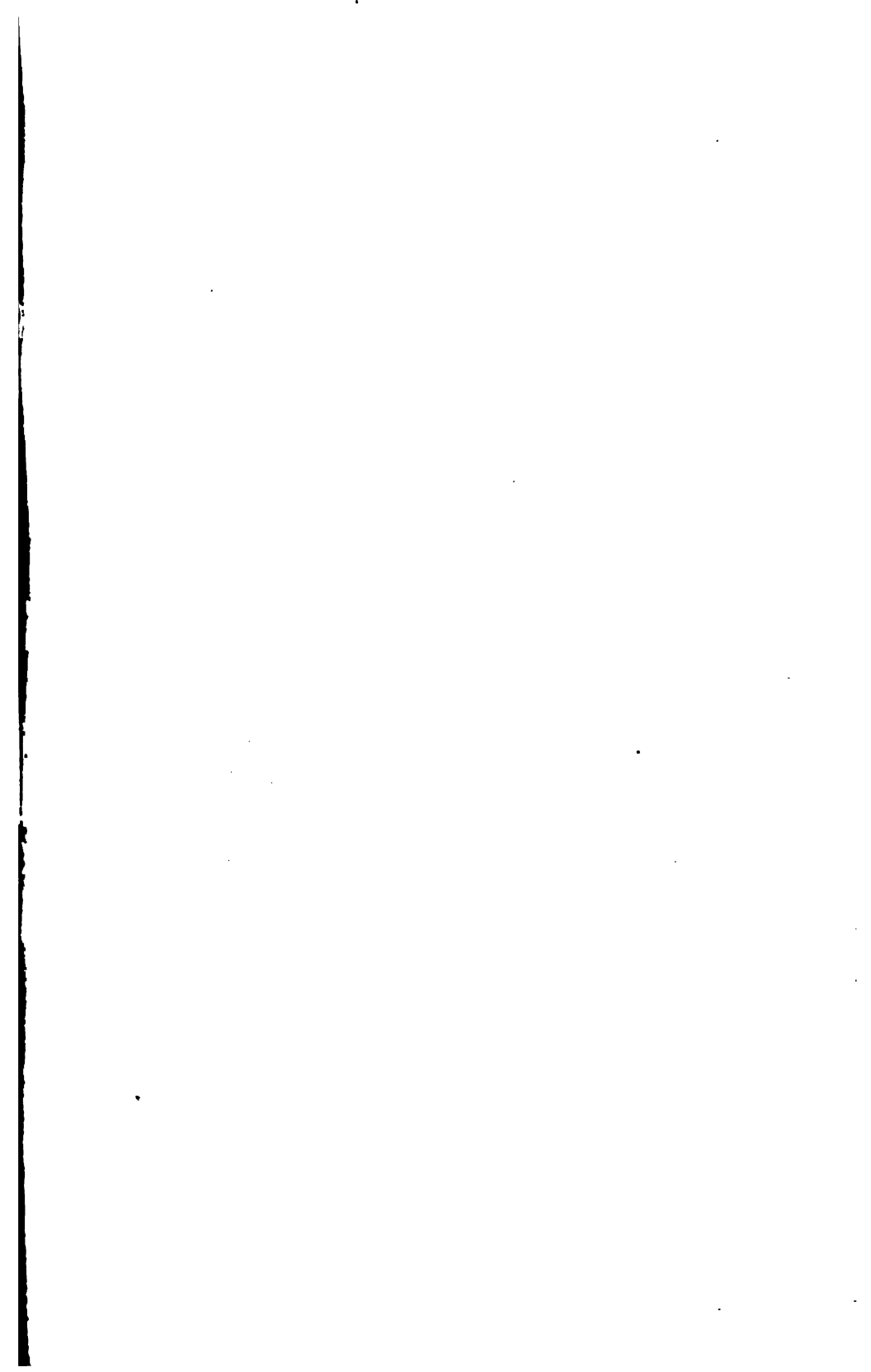

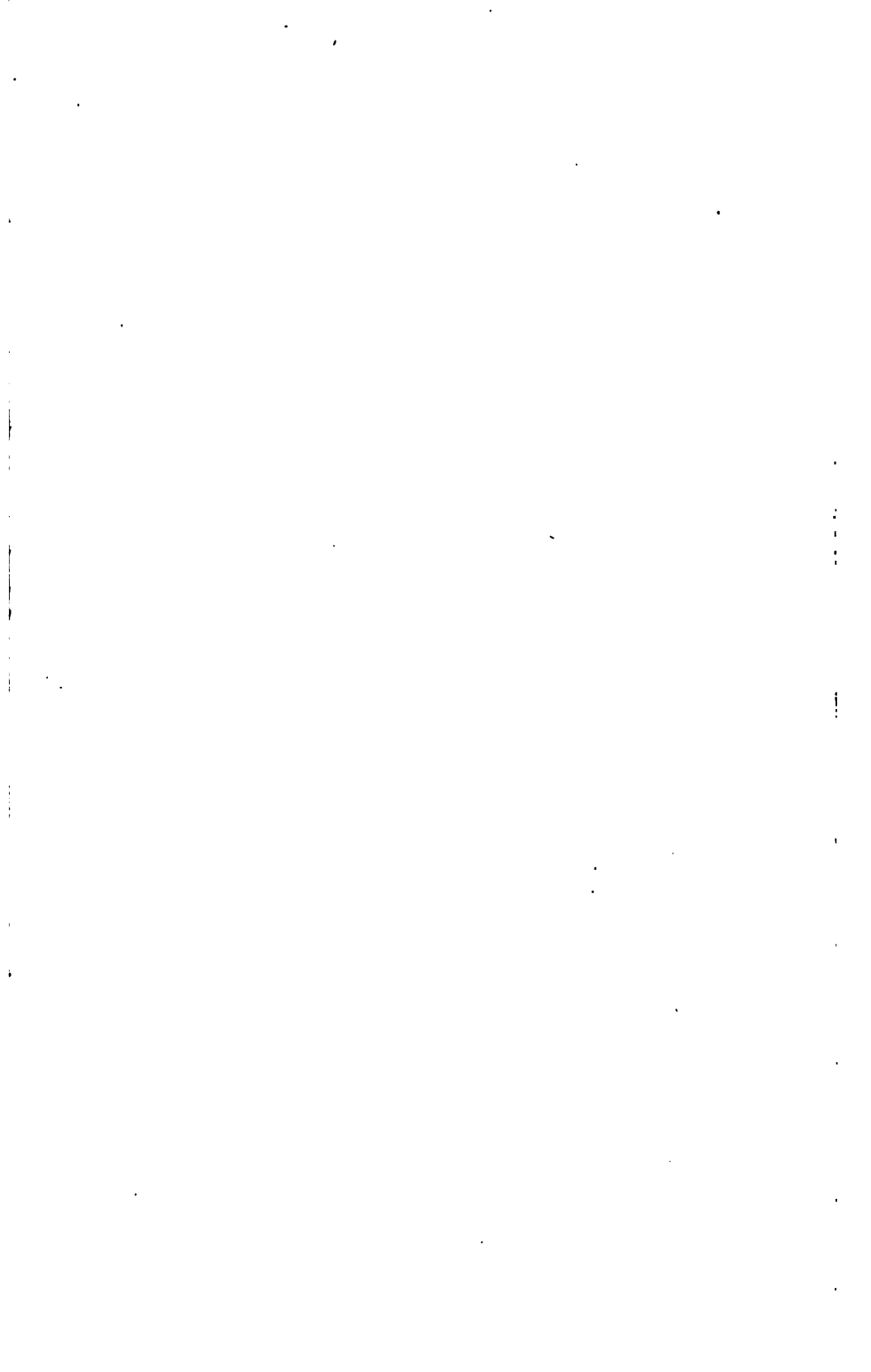

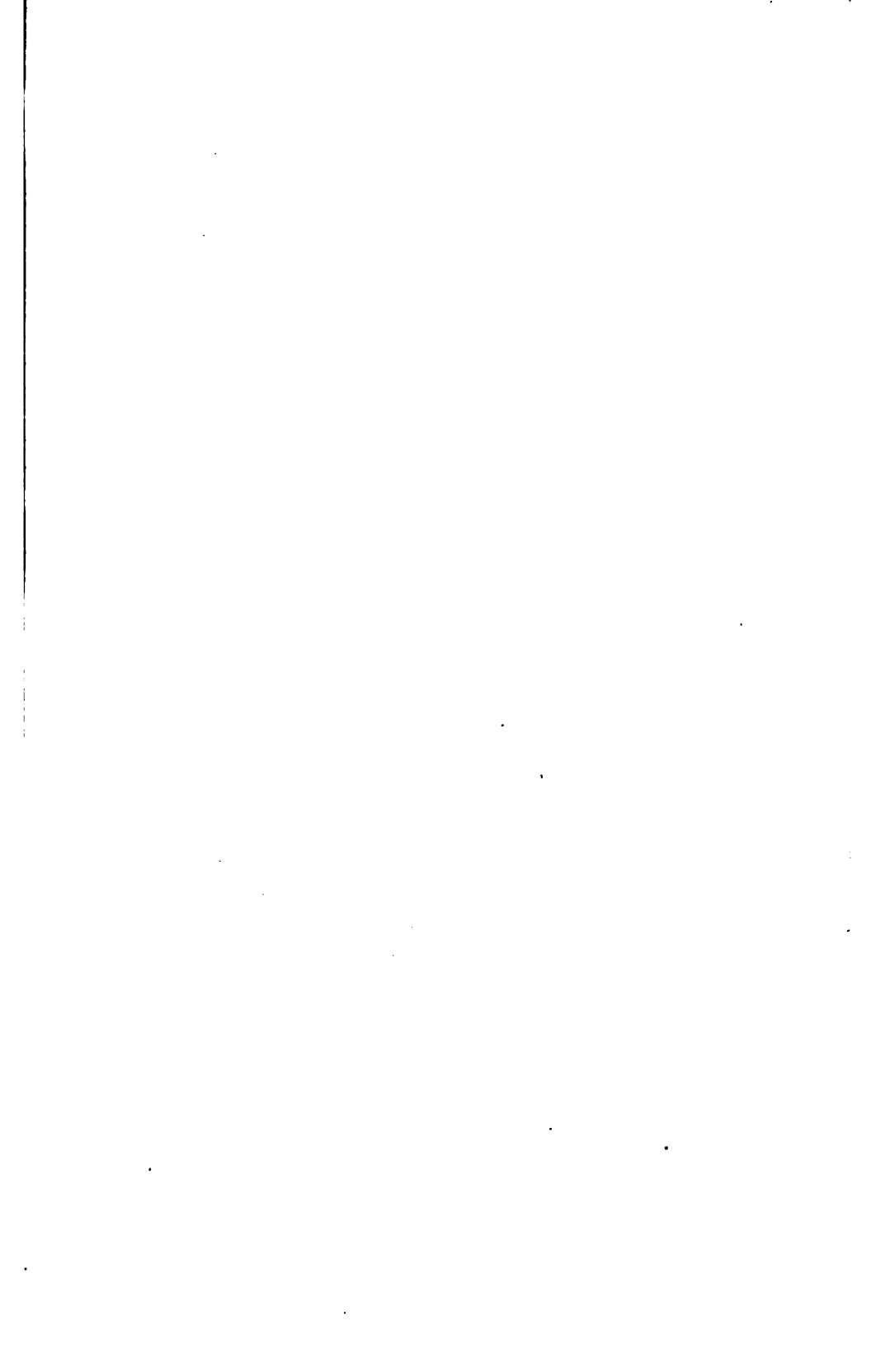

IN PREPARATION

ADVANCED SURVEYING

BY

C. B. BREED AND G. L. HOSMER

THE
PRINCIPLES AND PRACTICE
OF
SURVEYING

BY
CHARLES B. BREED AND GEORGE L. HOSMER
INSTRUCTORS IN CIVIL ENGINEERING, MASSACHUSETTS
INSTITUTE OF TECHNOLOGY

FIRST EDITION

NEW YORK
JOHN WILEY & SONS

LONDON: CHAPMAN & HALL, LIMITED
1906

COPYRIGHT, 1906
BY
CHARLES B. BREED AND GEORGE L. HOSMER

Stanbope Press
F. H. GILSON COMPANY
BOSTON, U. S. A.

105155
APR 23 1907

SQB
B74
T

PREFACE

In the preparation of this volume, it has been the authors' chief purpose to produce a text-book which shall include the essentials of a comprehensive knowledge of practical surveying and at the same time be adapted to the use of teachers and students in technical schools. In this book, which is essentially an elementary treatise, such subjects as stadia, plane table, hydrographic and geodetic surveying, are entirely omitted, these subjects being left for a later volume.

Considerable stress is laid upon the practical side of surveying. The attempt is made not only to give the student a thorough training in the fundamental principles and in approved methods of surveying, computing, and plotting, but also to impress upon him the importance of accuracy and precision in all of his work in the field and the drafting-room. In carrying out this purpose it has seemed necessary to lay particular stress upon some points which to the experienced engineer or the advanced student may appear too obvious to require explanation, but which teaching experience has shown to be most helpful to the beginner. The most common errors and mistakes have therefore been pointed out and numerous methods of checking have been explained. Every effort has been made to inculcate right methods even in minor details, and for this purpose a large number of examples from actual practice have been introduced.

In arranging the subject matter of the work, the four parts are presented in what appears to be a logical sequence. First, the use, adjustment, and care of instruments are taken up; then the next three parts, surveying methods, computations, and plotting, are taken in the order in which they are met in the daily practice of the surveyor. To show more clearly the steps in the process, the notes which are used as illustrations in surveying methods are calculated in the computation section, and

are treated again under the methods of plotting, finally appearing as a completed plan.

While the authors recognize fully their indebtedness to those who have preceded them in this field, they hope that they have made some useful contributions of their own to the treatment of the subject. Thus in the section on Surveying Methods, many practical suggestions have been inserted which they have found of value in their own work and which, so far as they are aware, now appear in a text-book for the first time. On the subject of Computations, much emphasis is laid upon the proper use of significant figures and the arrangement of the work, matters which heretofore have not been adequately treated in books on surveying. The section on Plotting contains many hints referring particularly to surveying drafting, which are not given in the published books on drawing and lettering. It is hoped also that the complete set of original illustrations which have been introduced throughout the book will aid materially in making the text clear.

A comprehensive cross-reference system giving the page as well as the article number has been adopted : this, together with the complete index at the end of the book and the many practical hints throughout the volume will, it is hoped, render it useful to the practical surveyor as a reference book.

The authors desire to acknowledge their indebtedness to their various associates in the teaching and engineering professions who have kindly responded to requests for information and assisted in the preparation of this work, particularly to Blamey Stevens, M. Sc., of Ellamar, Alaska, who supplied the entire chapter on Mining Surveying. They are also under obligations for the use of electrotype plates of tables : to W. H. Searles for Tables IV, V, and VI ; to Professor J. C. Nagle for Tables II and III ; and to Professor Daniel Carhart for Table I ; all of these plates were furnished by John Wiley & Sons. The authors are under special obligation to Professors C. F. Allen, A. G. Robbins, and C. W. Doten of the Massachusetts Institute of Technology, and to H. K. Barrows, Engineer U. S. Geological Survey, who have read the entire manuscript and who have offered many valuable suggestions in preparing the work for the press.

The authors also desire to express their appreciation of the excellent work of W. L. Vennard, who made the drawings for illustrations.

No pains has been spared to eliminate all errors, but the authors cannot hope that their efforts in this line have been completely successful, and they will consider it a favor if their attention is called to any which may be found.

Boston, Mass., September, 1906.

C. B. B.

G. L. H.

CONTENTS.

PART I.

USE, ADJUSTMENT, AND CARE OF INSTRUMENTS.

CHAPTER I.—GENERAL DEFINITIONS.—MEASUREMENT OF LINES.

ART.	PAGE
1. DEFINITION	3
2. PURPOSES OF SURVEYS	3
3. HORIZONTAL LINES	3

INSTRUMENTS FOR MEASURING LINES.

4. THE CHAIN	3
5. METRIC CHAIN	5
6. THE TAPE	5
7. STEEL TAPES.	5
8. THE STADIA	6
9. OTHER INSTRUMENTS; — WOODEN RODS, TWO-FOOT RULE, ODOMETER.	6

MEASUREMENT OF LINES.

* 10. MEASUREMENT OF A HORIZONTAL LINE WITH A CHAIN	7
* 11. MEASUREMENT OF A HORIZONTAL LINE WITH A CHAIN ON SLOPING GROUND	9
* 12. MEASUREMENT WITH A STEEL TAPE	10
13. COMMON SOURCES OF ERROR IN MEASUREMENT OF LINES	11
14. COMMON MISTAKES IN READING AND RECORDING MEASUREMENTS	11
15. AVOIDING MISTAKES	11
16. ACCURACY REQUIRED	12
17. AMOUNT OF DIFFERENT ERRORS	12
18. PULL	12
19. TEMPERATURE	13
20. ALIGNMENT	13
21. SAG	13
22. EFFECT OF WEARING ON LENGTH OF THE CHAIN	14
23. ACCURACY OF MEASUREMENTS	14
PROBLEMS	15

CHAPTER II.—MEASUREMENT OF DIRECTION.

24. THE SURVEYOR'S COMPASS	16
25. THE POCKET COMPASS	18
26. METHOD OF TAKING A MAGNETIC BEARING	18

ART.	PAGE
27. THE EARTH'S MAGNETISM, — DIP OF THE NEEDLE	19
28. DECLINATION OF THE NEEDLE	19
29. VARIATIONS IN DECLINATION.	20
30. ISOGONIC CHART	25
31. OBSERVATIONS FOR DECLINATION.	25
 ADJUSTMENTS OF THE COMPASS.	
33. ADJUSTMENT OF THE BUBBLES	25
34. DETECTING ERRORS IN ADJUSTMENT OF THE NEEDLE	25
35. TO STRAIGHTEN THE COMPASS-NEEDLE	26
36. TO CENTER THE PIVOT-POINT	27
37. TO REMAGNETIZE THE NEEDLE	28
38. COMMON SOURCES OF ERROR IN COMPASS WORK	28
39. COMMON MISTAKES	28
40. DETECTING LOCAL ATTRACTIONS OF THE NEEDLE.	29
41. CALCULATING ANGLES FROM BEARINGS	30
PROBLEMS	30
 CHAPTER III. — MEASUREMENT OF ANGLES.	
THE TRANSIT.	
42. GENERAL DESCRIPTION OF THE TRANSIT	31
45. THE TELESCOPE	34
46. THE OBJECTIVE	35
47. CROSS-HAIRS	36
48. EYEPIECE	37
49. MAGNIFYING POWER	37
51. FIELD OF VIEW	38
52. THE VERNIER	38
53. VERNIERS USED ON TRANSITS	39
54. ECCENTRICITY	44
 USE OF THE TRANSIT.	
56. SETTING UP THE TRANSIT	45
58. TO MEASURE A HORIZONTAL ANGLE	47
59. TO MEASURE AN ANGLE BY REPETITION	48
61. TO LAY OFF AN ANGLE BY REPETITION	50
62. RUNNING A STRAIGHT LINE — ONE POINT VISIBLE FROM THE OTHER	51
63. NEITHER POINT VISIBLE FROM THE OTHER	51
64. PROLONGING A STRAIGHT LINE.	52
65. METHODS OF SHOWING SIGHTS.	52
66. SIGNALS	53
67. TO MEASURE A VERTICAL ANGLE	54
68. PRECAUTIONS IN THE USE OF THE TRANSIT	55
 ADJUSTMENTS OF THE TRANSIT.	
70. ADJUSTMENT OF THE PLATE BUBBLES	56
71. ADJUSTMENT OF THE CROSS-HAIRS	57

CONTENTS

ix

ART.	PAGE
73. ADJUSTMENT OF THE STANDARDS	59
74. ADJUSTMENT OF THE TELESCOPE BUBBLE	59
75. ADJUSTMENT OF THE AUXILIARY LEVEL ON THE VERNIER OF THE VERTICAL ARC	59
76. ADJUSTMENT OF THE VERNIER OF THE VERTICAL CIRCLE	60
77. ADJUSTMENT OF THE OBJECTIVE SLIDE	60
78. SHOP ADJUSTMENTS	61
79. HOW TO ELIMINATE THE EFFECT OF ERRORS OF ADJUSTMENT IN THE TRANSIT.	61
80. CARE OF INSTRUMENTS	61
81. COMMON SOURCES OF ERROR IN TRANSIT WORK.	62
82. COMMON MISTAKES IN TRANSIT WORK	62
 THE SOLAR ATTACHMENT.	
83. DESCRIPTION OF SOLAR ATTACHMENT	65
84. THE CELESTIAL SPHERE	65
85. OBSERVATION ON THE SUN FOR MERIDIAN WITH SOLAR ATTACHMENT	66
86. COMPUTATION OF DECLINATION SETTINGS	68
87. COMSTOCK'S METHOD OF FINDING THE REFRACTION	69
89. MISTAKES IN USING THE SOLAR ATTACHMENT	70
 ADJUSTMENTS OF THE SOLAR ATTACHMENT.	
90. ADJUSTMENT OF THE POLAR AXIS	70
91. ADJUSTMENT OF THE CROSS-HAIRS	70
92. ADJUSTMENT OF TELESCOPE BUBBLE	71
PROBLEMS	71
 CHAPTER IV. — MEASUREMENT OF DIFFERENCES OF ELEVATION.	
93. LEVEL SURFACE	72
94. THE SPIRIT LEVEL	72
95. ANGULAR VALUE OF ONE DIVISION OF THE LEVEL TUBE	73
 THE LEVEL.	
97. THE WYE LEVEL	73
98. THE DUMPY LEVEL	74
99. COMPARISON OF WYE AND DUMPY LEVELS	77
100. THE LOCKE HAND LEVEL	77
 LEVELING RODS.	
102. BOSTON ROD	78
103. NEW YORK ROD	80
104. PHILADELPHIA ROD	81
105. SPECIAL SELF-READING RODS	81
106. TAPE ROD	81
107. PRECISE LEVEL ROD	82
108. ADVANTAGES OF THE SELF-READING ROD	82
109. ATTACHMENTS TO THE ROD FOR PLUMBING	83
110. EFFECT OF HEAT AND MOISTURE	83

USE OF THE LEVEL AND ROD.

ART.	PAGE
112. TO LEVEL THE INSTRUMENT	83
113. TO TAKE A ROD-READING	84
114. WAVING THE ROD	84
115. SIGNALS	85
116. DIFFERENTIAL LEVELING	85
117. THE PROPER LENGTH OF SIGHT	87
118. EFFECT OF THE EARTH'S CURVATURE AND OF REFRACTION ON LEVELING	87
119. PRECAUTIONS IN LEVEL WORK	88

ADJUSTMENTS OF THE LEVEL.

I. ADJUSTMENTS OF THE WYE LEVEL.

120. ADJUSTMENT OF THE CROSS-HAIR	88
122. ADJUSTMENT OF THE LEVEL TUBE	89
123. ADJUSTMENT OF THE LEVEL TUBE BY INDIRECT METHOD	89
125. ADJUSTMENT OF THE WYES	90

II. ADJUSTMENTS OF THE DUMPY LEVEL.

126. ADJUSTMENT OF THE CROSS-HAIRS	91
127. ADJUSTMENT OF THE BUBBLE TUBE	91
128. THE DIRECT OR "PEG" ADJUSTMENT	91
129. ADJUSTMENT OF THE LOCKE HAND LEVEL	93
130. COMMON SOURCES OF ERROR IN LEVELING	94
131. COMMON MISTAKES IN LEVELING	94
PROBLEMS	94

PART II.

SURVEYING METHODS.

CHAPTER V. — LAND SURVEYING.

132. SURVEYING FOR AREA	99
133. SURVEYING FOR AREA WITH COMPASS AND CHAIN	99

SURVEY OF FIELD WITH TRANSIT AND TAPE.

134. SURVEY OF A FIELD BY A TRAVERSE	101
137. IRREGULAR CURVED BOUNDARIES	105
138. SURVEY OF A FIELD WITH A SINGLE SET-UP OF THE TRANSIT	105
139. SURVEY OF A FIELD WITH A TAPE ONLY	106
140. SELECTING THE CORNERS	106
141. METHOD OF PROCEDURE	107
142. TIES	107
143. MEASUREMENT OF THE ANGLES OF THE TRAVERSE	108
144. MEASUREMENT OF AZIMUTH ANGLES	108
145. CHECKING THE FIELDWORK	109

CONTENTS

xi

ART.		PAGE
146.	ACCURACY REQUIRED	111
147.	ORGANIZATION OF TRANSIT PARTY	111
148.	NOTE-KEEPING	112
149.	SURVEY OF A FIELD FOR A DEED	114
150.	DEED DESCRIPTION	115
151.	JUDICIAL FUNCTIONS OF THE SURVEYOR	116
152.	RERUNNING OLD SURVEYS FROM A DEED	118
153.	HOW TO LOOK UP A RECORDED DEED	120

THE UNITED STATES SYSTEM OF SURVEYING THE PUBLIC LANDS.

154.	THE SYSTEM	121
155.	INITIAL POINTS	124
156.	BASE LINE	124
157.	PRINCIPAL MERIDIAN	126
158.	STANDARD PARALLELS	126
159.	GUIDE MERIDIANS	126
160.	TOWNSHIP EXTERIORS	127
161.	METHOD OF SUBDIVIDING	128
162.	MEANDERING	134
163.	SUMMARY OF OBJECTS AND DATA INTERSECTED BY THE LINE OR IN ITS VICINITY, TO BE NOTED	139
164.	PREScribed LIMITS FOR CLOSINGS AND LENGTHS OF LINES	141
165.	FIELD NOTES	142
166.	MARKING THE CORNERS	147
167.	TO ESTABLISH A PARALLEL OF LATITUDE	148
168.	THE SECANT METHOD	148
169.	TANGENT METHOD	150
170.	CONVERGENCE OF THE MERIDIANS	154

CHAPTER VI. — TRAVERSE LINES — LOCATION OF BUILDINGS — MISCELLANEOUS SURVEYING PROBLEMS.

TRAVERSE LINES.

171.	TRAVERSES WHICH DO NOT FORM CLOSED FIGURES	156
172.	METHOD OF CHECKING TRAVERSES WHICH DO NOT FORM CLOSED FIGURES, — CHECKING BY ASTRONOMICAL METHOD	156
173.	CHECKING BY CUT-OFF LINES	157
174.	CHECKING BY ANGLES TO A DISTANT OBJECT	158
175.	CHECKING BY CONNECTING WITH TRIANGULATION POINTS	158

LOCATION OF BUILDINGS FROM TRANSIT LINE.

176.	METHODS OF LOCATING BUILDINGS	159
177.	GEOMETRIC PRINCIPLES	159
178.	TIES, OFFSETS, SWING OFFSETS, AND RANGE LINES	159
179.	GENERAL SUGGESTIONS	160
180.	TYPICAL CASES	160
181.	BUILDING NEAR TRANSIT LINE AND NEARLY PARALLEL TO IT	160
	PLOTING	161
182.	BUILDING NEAR TRANSIT LINE, MAKING A SLIGHT ANGLE WITH IT	161
	PLOTING	162

ART.	PAGE
183. BUILDING LOCATED ENTIRELY BY DIRECT TIES	162
PLOTING	163
184. BUILDING LOCATED AT A CONSIDERABLE SKEW TO THE TRANSIT LINE	163
PLOTING	164
185. BUILDINGS AT A LONG DISTANCE FROM THE TRANSIT LINE	164
PLOTING	164
186. BUILDINGS LOCATED FROM OTHER BUILDINGS	165
187. BUILDINGS OF IRREGULAR SHAPE	166
188. LARGE CITY BUILDINGS	166
189. LOCATION OF BUILDINGS BY ANGLES AND DISTANCES	167
190. LOCATION OF BUILDINGS AND FENCES FROM TRANSIT LINE	167

MISCELLANEOUS SURVEYING PROBLEMS.

191. RANDOM LINE	169
192. OBSTACLES ON LINE	170
193. OFFSETTING TRANSIT LINE	170
194. SHORT TRANSIT SIGHTS	172
195. BISECTION METHOD	172
196. MEASURING AROUND A SMALL OBSTACLE	173
197. EQUILATERAL TRIANGLE METHOD	174
198. INACCESSIBLE DISTANCES	174
199. BY RIGHT TRIANGLE METHOD	174
200. INTERSECTING TRANSIT LINES	175
201. BY SWING OFFSET METHOD	175
202. BY TANGENT OFFSET METHOD	176
203. BY OBLIQUE TRIANGLE METHOD	177
204. TO OBTAIN THE DISTANCE BETWEEN TWO INACCESSIBLE POINTS BY OBSERVATION FROM TWO ACCESSIBLE POINTS.	178
205. TO OBTAIN THE INACCESSIBLE DISTANCE BETWEEN TWO ACCESSIBLE POINTS BY OBSERVATION ON TWO INACCESSIBLE POINTS OF KNOWN DISTANCE APART	179

CHAPTER VII.—OBSERVATION FOR MERIDIAN AND LATITUDE.

OBSERVATIONS FOR MERIDIAN.

206. TO ESTABLISH A TRUE MERIDIAN LINE BY OBSERVATION ON POLARIS WITH THE TRANSIT	180
207. OBSERVATION FOR MERIDIAN ON POLARIS AT ELONGATION	182
208. OBSERVATION FOR MERIDIAN ON POLARIS AT CULMINATION	185
209. TO FIND THE STANDARD TIME OF CULMINATION AND ELONGATION.	186
210. MERIDIAN OBSERVATIONS ON POLARIS WITH THE COMPASS	187
211. MERIDIAN OBSERVATION ON POLARIS AT ANY TIME WITH THE TRANSIT	188
212. SOLAR OBSERVATIONS	190
213. OBSERVATION FOR MERIDIAN BY EQUAL ALTITUDES OF THE SUN IN THE FORENOON AND AFTERNOON	190
214. OBSERVATION FOR MERIDIAN BY A SINGLE ALTITUDE OF THE SUN	193
215. OBSERVATION FOR MERIDIAN BY MEANS OF THE SOLAR ATTACHMENT	195

CONTENTS

xiii

OBSERVATIONS FOR LATITUDE.

ART.	PAGE
216. BY THE ALTITUDE OF POLARIS AT UPPER OR LOWER CULMINATION	196
217. BY THE ALTITUDE OF THE SUN AT NOON	196
PROBLEMS	197

CHAPTER VIII. — LEVELING.

218. DEFINITIONS	198
219. LEVELING TO ESTABLISH BENCH MARKS.	198
222. DOUBLE RODDED LINES	201
224. BENCH MARKS AND TURNING POINTS	202
225. LEVELING FOR PROFILE	203
227. CROSS-SECTIONING	206
228. USE OF THE TAPE ROD IN CROSS-SECTION WORK	206
229. CROSS-SECTIONING FOR EARTHWORK	207
230. ROAD CROSS-SECTIONS	207
231. SETTING SLOPE STAKES.	208
232. EARTHWORK NOTES FOR ROAD CROSS-SECTIONS	209
233. CROSS-SECTIONS FOR BORROW-PITS	210
234. CROSS-SECTIONS FOR TRENCH EXCAVATION	210
235. LEVELING TO ESTABLISH A GRADE LINE	210
236. "SHOOTING IN" A GRADE LINE.	211
237. TO ESTABLISH A DATUM PLANE BY MEANS OF TIDAL OBSERVATIONS	211
238. THE STAFF GAUGE	212
239. LEVELING ACROSS A RIVER	213
PROBLEMS	215

CHAPTER IX. — CITY SURVEYING

240. INSTRUMENTS USED	216
241. TAPES AND TAPE MEASUREMENTS	216
242. TRANSITS AND LEVELS	217
243. CITY STANDARD	218

CITY LAYOUTS.

245. STREETS	219
246. LOCATION OF STREETS	220
247. SIZE OF BLOCKS AND LOTS	222
248. WIDTH OF STREETS	222
249. STREET GRADES.	224
250. THE DATUM PLANE	226
251. ESTABLISHING BENCH MARKS	226
252. WATER AND SEWER SYSTEMS	227

STAKING OUT CITY WORK.

253. STAKING OUT A NEW DISTRICT	227
254. MONUMENTS	228
255. SETTING STONE BOUNDS	230

ART.	PAGE
256. CURVED LAYOUTS	232
257. ELEMENTS OF A CIRCULAR CURVE.	233
258. STAKING OUT CIRCULAR CURVES	234
259. DEFLECTION ANGLES	234
260. KEEPING THE NOTES	237
261. WHEN THE ENTIRE CURVE CANNOT BE LAID OUT FROM ONE END	238
262. FIRST METHOD	238
263. SECOND METHOD	239
264. CURVED STREET CORNERS	239
265. ONE STREET LINE STRAIGHT, THE OTHER CURVED	239
266. BOTH STREET LINES CURVED	240
267. STAKING OUT STREET GRADES	241
268. VERTICAL CURVES	242
269. CROSS-SECTION OF STREET	243
270. GUTTERS AT SAME ELEVATION	244
271. ONE GUTTER HIGHER THAN THE OTHER	244
273. IRREGULAR SHAPED BLOCKS	247
274. STAKING OUT CITY LOTS	248
275. STAKING OUT CURB LINES AND GRADES	249
276. STAKING OUT SEWERS	251
277. STAKING OUT STREET RAILWAY TRACKS	251
278. RERUNNING STREET LINES AND GRADES	251
279. REVISING STREET LINES	252
280. REVISING STREET GRADES	252
281. SETTING BATTER-BOARDS FOR A BUILDING	253
282. CITY PLANS AND RECORDS	255
RECTANGULAR COÖRDINATE SYSTEM OF SURVEYING CITIES.	
283. GENERAL DESCRIPTION	255
284. TRIANGULATION SCHEME	256
285. MEASUREMENT OF BASE-LINE.	261
286. MEASUREMENT OF ANGLES	261
287. ADJUSTMENT OF THE ANGLES	262
288. AZIMUTH	262
289. SECONDARY AND TERTIARY TRIANGULATION	263
290. TRAVERSES	263
291. METHOD OF LOCATING PROPERTY LINES AND BUILDINGS	263
CHAPTER X. — TOPOGRAPHICAL SURVEYING.	
293. TRIANGULATION FOR CONTROL	264
294. LOCATION OF POINTS FROM THE TRANSIT LINE	265
295. CONTOUR LINES	265
296. CHARACTERISTICS OF CONTOURS	268
297. RELATION BETWEEN CONTOUR MAP AND PROFILE	270
298. RELATION BETWEEN CONTOUR MAP AND SIDE ELEVATION OR PRO- JECTION	271
299. DRAINAGE AREAS	273
300. SKETCHING CONTOURS FROM STREAMS AND SUMMITS	273
301. SKETCHING CONTOURS FROM KNOWN ELEVATIONS	276

CONTENTS

XV

Art.	PAGE
302. MISTAKES IN SKETCHING CONTOURS	276
303. LOCATING CONTOURS	277
304. LOCATING CONTOURS BY CROSS-SECTIONS	278
305. LOCATING CONTOURS BY PROFILES	278
306. LOCATING POINTS ON CONTOURS	278
307. LOCATING CONTOURS BY MEANS OF THE HAND LEVEL	278
308. LOCATION OF STREAMS AND SHORE LINES	280
309. CONTOUR PROBLEMS	280
310. INTERSECTION OF PLANE WITH SURFACE OF GROUND	280
311. INTERSECTION OF CURVED SURFACE WITH SURFACE OF GROUND	281
312. INTERSECTION OF SIDE SLOPES OF ROAD WITH SURFACE OF GROUND	283

CHAPTER XI. — MINING SURVEYING.

313. GENERAL REMARKS	285
314. DEFINITIONS OF MINING TERMS	285

MINING INSTRUMENTS.

315. MINING TRANSITS	287
316. SIDE TELESCOPE	287
317. TOP TELESCOPE	287
318. ADJUSTMENTS OF SIDE TELESCOPE	287
319. ADJUSTMENT OF TOP TELESCOPE	290
320. INTERCHANGEABLE SIDE AND TOP TELESCOPE	290
321. ECCENTRIC BEARING TELESCOPE	290
322. COMBINED SOLAR ATTACHMENT AND TOP TELESCOPE	292
324. USE OF THE ORDINARY TRANSIT IN MINING SURVEYING	292
325. COMPASSES USED IN MINES	293

UNDERGROUND SURVEYING.

326. TRANSFERRING A MERIDIAN INTO A MINE BY USE OF THE TRANSIT	294
327. PLUMBING THE MERIDIAN DOWN A SHAFT	296
328. TRANSFERRING A MERIDIAN INTO A MINE WHEN THERE ARE TWO SHAFTS	298
329. UNDERGROUND TRAVERSES	299
330. ESTABLISHING STATION POINTS	300
331. NOTES OF A MINE TRAVERSE	305
332. PLOTTING A MINE TRAVERSE	305
333. UNDERGROUND LEVELING	306
334. MINE MAPS AND CHARTS	306
335. LAYING OUT MINING WORK	307
336. UNDERGROUND SURVEYING PROBLEMS	307
337. VERTICAL ANGLE CORRECTION FOR ECCENTRICITY OF THE TOP TELESCOPE	308
338. VERTICAL ANGLE CORRECTION FOR ECCENTRIC BEARING TELESCOPE	308
339. TO ESTABLISH A BOUNDARY LINE OF THE CLAIM UNDERGROUND	309
340. TO LAY OUT A CONNECTION IN A MINE	309
341. HYDRAULIC SURVEYING FOR MINES	310
342. TESTING FOR ORE BY ELECTRIC CURRENTS	311

SURFACE SURVEYING.

ART.	PAGE
343. SURFACE SURVEYING IN RUGGED MOUNTAIN REGIONS	311
344. MINE BOUNDARIES. APPROPRIATIONS UNDER UNITED STATES LAWS	312
345. SURVEYING FOR PATENT	314
346. THE SURVEYING OF BOREHOLES	315
347. STAKING OUT THE PROBABLE APEX OF A VEIN	316
348. ECONOMIC PRINCIPLES	316
PROBLEMS	318

PART III.

COMPUTATIONS.

CHAPTER XII. — GENERAL PRINCIPLES — MISCELLANEOUS PROBLEMS — EARTHWORK COMPUTATIONS.

349. GENERAL REMARKS	323
354. LOGARITHMIC OR NATURAL FUNCTIONS	327
355. SHORT CUTS	328
357. ARRANGEMENT OF COMPUTATIONS	330
358. CHECKS	330
359. SLIDE RULE	330
360. THACHER SLIDE RULE	333
361. REDUCING THE FIELD NOTES FOR COMPUTATIONS.	333
362. CURVED BOUNDARY BY OFFSETS	333
363. TRAPEZOIDAL RULE	334
364. SIMPSON'S ONE-THIRD RULE	334
365. STRAIGHTENING CROOKED BOUNDARY LINES	336
366. AREA BY TRIANGLES	336
367. AREA OF A QUADRILATERAL BY TRIANGLES	337
368. AREA OF A CURVED CORNER LOT	338
369. ROUGH CHECKS ON AREAS	339
370. PLANIMETER.	339
371. DEFLECTION ANGLES AND CHORDS FOR A CIRCULAR CURVE	341
372. COMPUTATIONS OF OBSERVATIONS	342
COMPUTATION OF VOLUME.	
373. BORROW-PITS	342
374. VOLUME OF PRISMOID	344
375. END AREA FORMULA	344
376. PRISMOIDAL FORMULA	344
378. ESTIMATES FOR GRADING	345
382. ROUGH ESTIMATES	349
PROBLEMS	350

CHAPTER XIII. — AREA BY DOUBLE MERIDIAN DISTANCES —
COORDINATES.

ART.	PAGE
383. COMPUTATION OF AREA	352
384. AREA BY DOUBLE MÉRIDIAN DISTANCE METHOD	352
386. COMPUTATION OF AREA OF COMPASS SURVEY	356
387. BALANCING A CHAIN AND COMPASS TRAVERSE	358
390. DOUBLE PARALLEL DISTANCE	359
391. ERROR OF CLOSURE	360
392. COMPUTATION OF AREA OF A TRANSIT AND TAPE SURVEY.	360
395. BALANCING A TRANSIT AND TAPE SURVEY	364
396. FRACTIONAL AREAS	365
397. SUPPLYING MISSING DATA	366
401. DETECTING MISTAKES	368
402. THE SUBDIVISION OF LAND	368
403. TO CUT OFF FROM A TRAVERSE A GIVEN AREA BY A STRAIGHT LINE STARTING FROM A KNOWN POINT ON THE TRAVERSE	369
404. TO CUT OFF FROM A TRAVERSE A GIVEN AREA BY A LINE RUNNING IN A GIVEN DIRECTION	369
405. TO FIND THE AREA CUT OFF FROM A TRAVERSE BY A LINE RUN- NING IN A GIVEN DIRECTION FROM A GIVEN POINT IN THE TRAV- ERSE	370

CALCULATIONS RELATING TO TRAVERSES WHICH DO NOT CLOSE.

406. TO CALCULATE THE TOTAL DISTANCE BETWEEN END POINTS	371
407. CUT-OFF LINES	371
408. COMPUTATION OF AZIMUTHS WHEN CHECKING ANGLES TO A DIS- TANT OBJECT	372
409. CALCULATION OF TRIANGULATION	372
410. COÖRDINATES	373
411. TO DETERMINE THE AREA OF A FIELD BY RECTANGULAR CO- ÖRDINATES	374
PROBLEMS	376

PART IV.

PLOTTING.

CHAPTER XIV. — DRAFTING INSTRUMENTS AND MATERIAL.

ENGINEERING DRAFTING INSTRUMENTS.

415. STRAIGHT EDGE	381
416. ENGINEER'S SCALE	382
417. PROTRACTOR	382
418. SEMICIRCULAR PROTRACTOR	382
419. FULL-CIRCLE PROTRACTOR	384
421. THREE-ARMED PROTRACTOR	384

ART.	PAGE
423. PANTOGRAPH	385
424. PARALLEL RULER	386
425. BEAM COMPASS	386
426. CONTOUR PEN	386
427. PROPORTIONAL DIVIDERS	387
429-31. RAILROAD CURVES, FRENCH CURVES, FLEXIBLE CURVES, AND SPLINE	387
 DRAWING PAPERS.	
433. DRAWING PAPER FOR PLANS	388
434. TRACING PAPER AND TRACING CLOTH	389
436. CROSS-SECTION AND PROFILE PAPERS	390
438. PROCESS PAPERS, — BLUE-PRINTS	391
441. VANDYKE SOLAR PAPER	393
442. ELECTRICAL PRINTING FRAMES	395
443. INKS AND WATER-COLORS	395
 CHAPTER XV. — METHODS OF PLOTTING.	
444. LAYING OUT A PLAN	397
445. SCALE	397
 METHODS OF PLOTTING TRAVERSES.	
446. PLOTTING BY PROTRACTOR AND SCALE	398
447. CHECKS	398
448. PROTRACTOR AND T-SQUARE	400
449. PLOTTING BY RECTANGULAR COÖRDINATES	401
454. CHECKS	405
455. PLOTTING BY TANGENTS	405
456. CHECKS	407
457. PLOTTING BY CHORDS	408
458. USE OF THE SINE	409
459. CHECKS	409
 METHOD OF PLOTTING DETAILS.	
460. BUILDINGS, FENCES, STREAMS, ETC.	410
461. CONTOURS	410
462. CROSS-SECTIONS	411
463. PROFILES	411
467. CHECKS	413
PROBLEMS	413
 CHAPTER XVI. — FINISHING AND FILING DRAWINGS.	
468. WHAT SHOULD APPEAR ON A DRAWING	415
469. TRAVERSE LINES	415
470. PHYSICAL FEATURES	416
471. TOPOGRAPHIC CONVENTIONAL SIGNS	416

CONTENTS

xix

ART.	PAGE
473. LETTERING	422
474. TITLES	423
475. NOTES	426
476. BORDER LINES	427
477. MERIDIANS	427
478. SCALES	428
479. SHRINKAGE OF DRAWING PAPERS	428
480. MAPS OF LARGE EXTENT	429
481. INKING IN A PROFILE	430
482. CLEANING DRAWINGS	430
483. FILING DRAWINGS	431
484. INDEXING DRAWINGS	432
485. FILING NOTE-BOOKS	432
486. INDEXING NOTES	433
487. OTHER RECORDS	433

TABLES.

I. LOGARITHMS OF NUMBERS	437
II. LOGARITHMIC SINES AND COSINES	455
III. LOGARITHMIC TANGENTS AND COTANGENTS	470
IV. NATURAL SINES AND COSINES	485
V. NATURAL TANGENTS AND COTANGENTS	494
VI. LENGTHS OF CIRCULAR ARCS: RADIUS = 1	506
VII. MEAN REFRACTIONS IN DECLINATION	507
VIII. TRIGONOMETRIC AND MISCELLANEOUS FORMULAS	511
IX. CIRCULAR CURVE FORMULAS	513
X. GEOMETRIC FORMULAS	513
XI. LINEAR MEASURE	514
XII. SQUARE MEASURE	514
XIII. LINEAR MEASURE — METRIC SYSTEM	514
XIV. SQUARE MEASURE — METRIC SYSTEM	514
XV. CONSTANTS	515
GREEK ALPHABET	516



**THE PRINCIPLES AND PRACTICE OF
SURVEYING.**

PART I.

USE, ADJUSTMENT, AND CARE OF INSTRUMENTS.

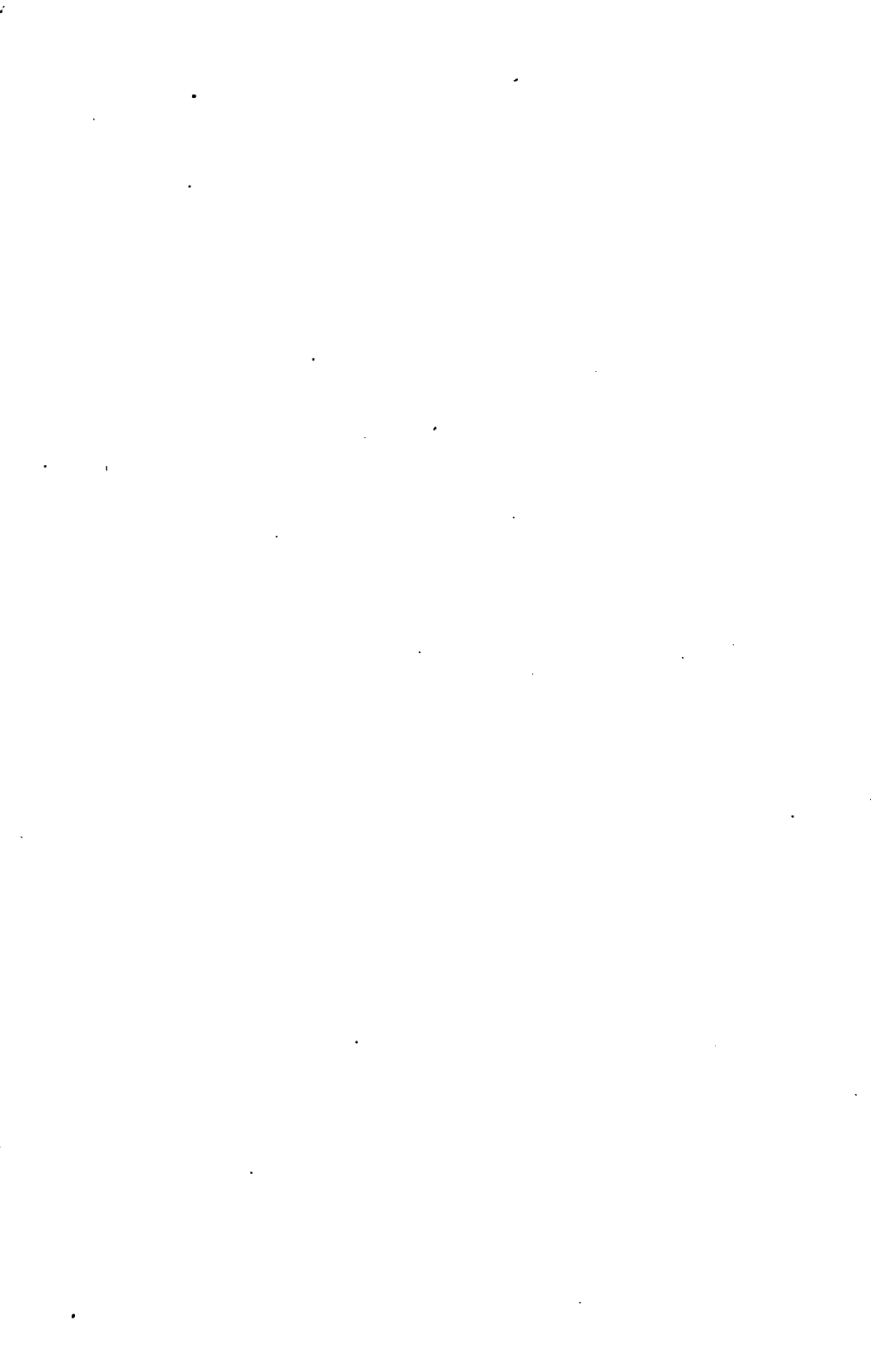

CHAPTER I.

GENERAL DEFINITIONS.—MEASUREMENT OF LINES.

1. **DEFINITION.**—Surveying is the art of measuring and locating lines and angles on the surface of the earth. When the survey is of such limited extent that the effect of the earth's curvature may be safely neglected it is called *Plane Surveying*. When the survey is so large that the effect of curvature of the earth must be taken into account as, for instance, in the survey of a state or a country, it is called *Geodetic Surveying*.

2. **Purposes of Surveys.**—Surveys are made for a variety of purposes such as the determination of areas, the fixing of boundary lines, and the plotting of maps. Furthermore, engineering constructions, such as waterworks, railroads, mines, bridges, and buildings, all require surveys.

3. **Horizontal Lines.**—In surveying, all measurements of lengths are **horizontal** or else are subsequently reduced to horizontal distances. As a matter of convenience, measurements are sometimes taken on slopes, but the horizontal projection is afterward computed. The distance between two points as shown on a map then is always this horizontal projection.

INSTRUMENTS FOR MEASURING LINES.

4. **THE CHAIN.**—There are two kinds of chain in common use, the *Surveyor's (or Gunter's) Chain*, and the *Engineer's Chain* (Fig. 1). Gunter's chain is 66 feet long, and its use is confined chiefly to land surveying on account of its simple relation to the acre and to the mile.

1 Gunter's Chain	= 4 Rods = 100 Links.
1 Mile	= 80 Chains.
1 Acre	= 10 Square Chains.

Evidently each link is $\frac{66}{100}$ of a foot (or 7.92 inches) long. The inch, however, is never used in surveying fieldwork.

The engineer's chain is 100 feet long and is divided into one hundred links of one foot each. Each end link is provided with a handle, the outside of which is the zero point, or end, of the chain. In these chains, every tenth link counting from either end is marked by a brass tag having one, two, three, or four points corresponding to the number of tens which it marks. The middle of the chain is marked by a round tag. In the engineer's chain then the 10-ft. and 90-ft. points, the 20-ft. and 80-ft. points, etc., are marked alike; hence it is necessary to ob-

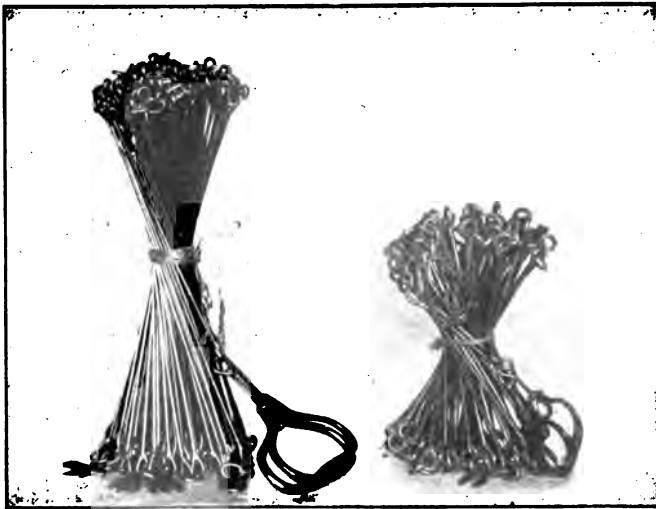

ENGINEER'S CHAIN.

GUNTER'S HALF-CHAIN.

FIG. 1.

serve on which side of the 50-ft. point a measurement falls in order to read the distance correctly. Distances measured with the surveyor's chain are recorded as *chains and links*, (or in *chains and decimals*); while those measured with the engineer's chain are recorded as *feet and decimals*.

On account of the large number of wearing surfaces and the consequent lengthening with use, the chain should be frequently compared with a standard of length (Art. 243, p. 218). It may be adjusted to agree with the standard, by means of a nut at the

handle, which allows the length of the chain to be altered by lengthening or shortening the end link.

5. **Metric Chain.** — The *Metric Chain* is usually 20 meters long and is divided into one hundred links, each 2 decimeters long.

6. **THE TAPE.** — There are three kinds of tape in common use, — *cloth, metallic, and steel*. Cloth tapes stretch so easily that they are of little use in surveying. The so-called metallic tapes are cloth tapes having very fine brass wires woven into them to prevent stretching. They are usually graduated into feet, tenths, and half-tenths and are made in lengths of 25 ft., 50 ft., and 100 ft. When precise results are required a steel tape should be used. While a steel tape varies a slight amount in length with the temperature and with the pull, it is possible to determine the amount of these variations and hence to arrive at accurate results.

7. **Steel Tapes.** — Steel tapes may be obtained in lengths up to 500 ft., but the most common in use are the 50-ft. and 100-ft. lengths. While the shorter tapes are usually made of thin steel ribbon the longer ones are of sufficiently large cross-section to withstand hard usage. These heavy tapes are generally marked every 10 ft. by a brass tag, the 10-ft. length at one end of the tape being marked at every foot, and the last foot divided into tenths. Some of these tapes are marked every foot throughout their entire length. The light tapes are divided throughout their entire length into feet, tenths, and hundredths, each line being etched on the steel. The numbering is continuous from 0 ft. to 100 ft. These tapes are more convenient to handle than the heavy ones, but are not suited to very rough work as they are easily kinked and broken. They can be readily mended, however, by riveting to the back of the tape a piece of tape of the same width.

Since the surveyor's measurements are usually in feet and decimals, they are not in convenient form for use by mechanics in construction work. It is therefore often necessary to convert decimals of a foot into inches and *vice versa*. The following table shows the general relation between these two and is sufficiently close for most work

TABLE 1.
DECIMALS OF FOOT IN INCHES.

DECIMAL OF FOOT.	=	INCHES.
.01	=	$\frac{1}{4}$ -
.08	=	1 -
.17	=	2 +
.25	=	3 (exact)
.50	=	6 (exact)
.75	=	9 (exact)

Decimals of a foot can easily be converted mentally into inches, by use of the equivalents in the above table, for example, $0.22 \text{ ft.} = .25 - .03 = 3'' - \frac{3}{8}'' = 2\frac{5}{8}''$.

In surveying farms, timber lands, or other property of low value, chain measurements are usually of sufficient accuracy and the chain is well adapted to work in rough country. In city surveys, and in fact in all surveys where great accuracy is demanded, the steel tape is indispensable. In preliminary railroad surveys the engineer's chain, which formerly was used exclusively, is gradually being replaced by the long heavy tape which, while adapted to rough work, will at the same time give accurate results.

8. THE STADIA. — Where it is desired to measure distances with great rapidity but not with very great accuracy the *stadia* method is coming to be very generally used. The distance is obtained by simply sighting with a transit instrument at a graduated rod held at the other end of the line and noting the space on the rod included between two special cross-hairs set in the instrument at a known distance apart. From this observed interval on the rod the distance from the transit to the rod can be easily calculated.

9. OTHER INSTRUMENTS. — *Wooden Rods* are used in certain kinds of work for making short measurements, usually less than 15 ft.

The *Two-Foot Rule* divided into tenths and hundredths of a foot is very convenient for short measurements.

The *Odometer* is an instrument which may be attached to a carriage in such a manner as to register the number of revolutions of one of the wheels. The circumference of the wheel being known the approximate distance traversed is easily determined.

MEASUREMENT OF LINES.**10. MEASUREMENT OF A HORIZONTAL LINE WITH A CHAIN.**

— This work is done by two chainmen using a chain and a set of eleven steel marking pins. One man, called the head-chainman, carries ten of the marking pins and the front end of the chain. The rear-chainman takes the eleventh pin and the other end of the chain. The head-chainman then goes forward keeping as nearly on the line as he can. The rear-chainman holds his end of the chain just to one side of the initial point, as in Fig. 2, so that any jerking of the chain will not disturb the pin at which he is holding. The rear-chainman, with his eye over the point, places the head-chainman in line with some object, such as a



HEAD-CHAINMAN.

REAR-CHAINMAN.

FIG. 2. MEASURING A HORIZONTAL LINE WITH A CHAIN.

sighting-rod, which marks the other end or some point on the line. When the head-chainman is nearly in line he takes a pin and, standing to one side of the line, holds it upright on the ground a foot or so short of the end of the chain and the rear-chainman motions him to the right or left until his pin is on the line. When the head-chainman has the pin in line he stretches the chain taut, seeing that there are no "kinks" and that no obstructions cause bends in the chain. The rear-chainman at the same time holds his end of the chain at his pin and when he calls out, "All right here," the head-chainman stretching the

chain past his line pin, removes this line pin, places it at the end of the chain, as in Fig. 2, and presses it vertically into the ground. When the chainmen are experienced the pin may be set for both line and distance at the same time. When the pin is in place the head-chainman calls, "All right," the rear-chainman takes the pin left at his end of the line and they proceed to the next chain-length. The pin that the rear-chainman has is a record of the first chain-length. Just before reaching the second pin the rear-chainman calls out; "Chain," to give the head-chainman warning that he has nearly reached a chain-length. The process of lining in the head-chainman and measuring a chain-length is then repeated. When the third pin is stuck in the ground the rear-chainman pulls the second pin; in this way the number of pins the rear-chainman holds is a record of the number of chain-lengths measured. There is always one pin in the ground which simply marks the distance and is not counted.

When 10 chains have been measured the head-chainman will be out of pins and calls to the rear-chainman, who brings forward 10 pins. The pins are then counted by **both chainmen**. Every time 10 chains are measured a record of it is made in note-books kept by **both men** and the process is repeated until the end of the line is reached.

In measuring the fraction of a chain the head-chainman holds his end of the chain at the required point and the fractional distance is read by the rear-chainman at the last pin. In some kinds of work, however, it is more convenient to draw the chain ahead past the end point and, while the rear-chainman holds his end of the chain at the last pin, the head-chainman reads the fractional measurement. The links are read by counting from the proper tag and the tenths of a link are estimated. Great care should be taken to count the tags from the proper end of the chain since the 10-ft. points each side of the center, as has been explained, are marked alike.

It can be easily shown that if a pin is placed a few tenths of a foot to the right or left of the line the resulting error in the **distance** is very small and consequently "lining in" by eye is accurate enough, so far as the **distance** is concerned. But when

any side measurements or angles are to be taken the points should be set accurately on line by means of a transit instrument.

The chain should always be kept stretched out full length; it should never be doubled back on itself as it may become tangled and the links bent.

Much time can be saved if the head-chainman will pace the chain-length and then place himself very nearly in the line by means of objects which he knows to be on line as, for example, the instrument, a pole, or the last pin. The beginner should pace, several times, some line of known length so as to determine approximately how many steps he takes in 100 ft. In doing this he should take his natural step and avoid any attempt to take steps just 3 ft. long.

11. Measurement of a Horizontal Line with a Chain on Sloping Ground.— If the measurement is not on level ground the chain must be held horizontal and the distance transferred to the ground by means of a plumb-line. This is difficult to do accurately and is a fruitful source of error. Beginners usually hold the downhill end of the chain too low. Horizontal lines on buildings are very useful in judging when the chain is level. Since it is supported only at the ends its weight will cause it to sag so that the distance between the ends is less than a chain-length. The pull exerted on the chain should be such that it will stretch enough to balance as nearly as possible the shortening due to sag.

Whenever a slope is so steep that the chainman on the lower end cannot plumb high enough to keep the chain horizontal the measurement must be made in sections, 50-ft., 20-ft., or even 10-ft. lengths being used. Mistakes will be avoided if the rear-chainman comes forward at each measurement and holds the same fractional point on the chain that the head-chainman held, and so on until a whole chain-length has been measured. In this way it will be unnecessary to count the fractional distances, but care should be taken that these pins which marked the intermediate points are returned to the head-chainman so that the count of the chain-lengths will not be lost. Chaining downhill will, in general, give more accurate results than chaining uphill, because in the former case the rear end is held firmly at a point

on the ground so that the head-chainman can pull steadily on the chain and transfer the distance to the ground by means of the plumb-line; in the latter case the rear-chainman is plumbing his end of the chain over the point and it is difficult to hold it steady. The result is that the head-chainman cannot easily judge where the pin should be placed.

12. MEASUREMENT WITH A STEEL TAPE. — In measuring with the steel tape the process is similar to that described for the chain. As the tape is used for more precise work than the chain it is necessary to employ more exact methods of marking the intermediate points. In some cases stakes are driven into the ground and tacks or pencil marks used to mark the points. A small nail pressed into the ground so that the center of the head is in the proper position makes a good temporary mark, but of course is easily lost. In measuring on the surfaces of hard roads, spikes are used for permanent marks.

Measurements of important lines which are not checked by some geometric test should be checked by repeating the measurement, and in such a way as not to use the same intermediate points taken in the first measurement.*

Where distances are to be measured continuously from the initial point of a line without regard to angles in the line, as in railroad surveys, it is customary to establish the 100-ft. points. Mistakes will often be avoided by setting the 100-ft. points as follows: — suppose an angle to occur at 870.1 ft. from the point of beginning; this would be called "Station 8 + 70.1." To set "Station 9" the 70.1-ft. point of the tape should be held on stake 8 + 70.1 and the stake at station 9 placed at the 100-ft. point of the tape. This is preferable to making a measurement of 29.9 ft. from the zero end of the tape.

* In measuring with the tape some prefer to make a series of measurements between points set in the ground a little less than 100 ft. apart, summing up the partial measurements when the end of the line is reached. This guards against the mistake of omitting a whole tape-length. Another advantage is that it is easier to read the distance to a fixed point than to set a point accurately at the end of the tape; this is especially true in measurements where plumbing is necessary. This method takes less time than the usual method, but it is not applicable when it is necessary to mark the 100-ft. points on the line.

13. COMMON SOURCES OF ERROR IN MEASUREMENT OF LINES. —

1. Not pulling chain or tape taut.
2. Careless plumbing.
3. Incorrect alignment.
4. Effect of wind.
5. Variation in temperature.
6. Erroneous length of chain or tape.

14. COMMON MISTAKES IN READING AND RECORDING MEASUREMENTS. —

1. Failure to observe the position of the zero point of the tape.
(In some tapes it is not at the end of the ring.)
2. Omitting a whole chain-or tape-length.
3. Reading from wrong end of chain, as 40 ft. for 60 ft., or in the wrong direction from a tag, as 47 ft. for 53 ft.
4. Transposing figures, e.g., 46.24 for 46.42 (mental); or reading tape upside down, e.g., 6 for 9, or 86 for 98.
5. Reading wrong foot-mark, as 48.92 for 47.92.

15. AVOIDING MISTAKES. — Mistakes in counting the tape-lengths may be avoided if more than one person keeps the tally. Mistakes of reading the wrong foot-mark may be avoided by noting not only the foot-mark preceding, but also the next following foot-mark, as, "46.84 . . . 47 feet," and also by holding the tape so that the numbers are right side up when being read.

In calling off distances to the note keeper, the chainman should be systematic and always call them distinctly and in such terms that they cannot be mistaken. As an instance of how mistakes of this kind occur, suppose a chainman calls, "Forty-nine, three;" it can easily be mistaken for "Forty-nine feet." The note keeper should repeat the distances aloud so that the chainman may know that they were correctly understood. It is frequently useful in doubtful cases for the note keeper to use different words in answering, which will remove possible ambiguity. For example, if the chainman calls, "Thirty-six, five," the note keeper might answer, "Thirty-six and a half." If the

chainman had meant 36.05 the mistake would be noticed. The chainman should have called in such a case, "Thirty-six naught five." The following is a set of readings which will be easily misinterpreted unless extreme care is taken in calling them off.

40.7 — "Forty and seven."

47.0 — "Forty seven naught."

40.07 — "Forty, — naught seven."

All of these might be carelessly called off, "Forty-seven."

In all cases the chainmen should make **mental estimates** of the distances when measuring, in order to avoid large and absurd mistakes.

16. ACCURACY REQUIRED. — If, in a survey, it is allowable to make an error of one foot in every five hundred feet the chain is sufficiently accurate for the work. To reach an accuracy of 1 in 1000 or greater with a chain it is necessary to give careful attention to the **pull**, the **plumbing**, and the deviation from the **standard length**. With the steel tape an accuracy of 1 in 5000 can be obtained without difficulty if ordinary care is used in plumbing and aligning, and if an allowance is made for any considerable error in the length of the tape. For accuracy greater than about 1 in 10,000 it is necessary to know definitely the temperature and the tension at which the tape is of standard length and to make allowance for any considerable variation from these values. While the actual deviation from the U. S. Standard under ordinary conditions may be 1 in 10,000, still a series of measurements of a line taken under similar conditions may check **themselves** with far greater precision.

17. AMOUNT OF DIFFERENT ERRORS. — The surveyor should have a clear idea of the effects of the different errors on his results. For very precise work they should be accurately determined, but for ordinary work it is sufficient to know approximately the amount of each of them. A general idea of the effect of these errors will be shown by the following.

18. Pull. — At the tension ordinarily used, the light steel tape will stretch between 0.01 and 0.02 ft. in 100 ft. if the pull is increased 10 pounds.

19. **Temperature.** — The average coefficient of expansion for a steel tape is nearly 0.0000063 for 1° F. Hence a change of temperature of 15° produces nearly 0.01 ft. change in the length of the tape. Tapes are usually manufactured to be of standard length at 62° F., with a pull of 12 lbs. on them while supported throughout their entire length.

20. **Alignment.** — The error in length due to poor alignment can be calculated from the approximate formula

$$c - a = \frac{h^2}{2c} *$$

where h is the distance of the end of the tape from the line, c is the length of the tape, and a is the distance along the straight line. For example, if one end of a 100-ft. tape is held 1 ft. to one side of the line the error produced in the length of the line

will be $\frac{1^2}{2 \times 100} = 0.005$ ft., (about $\frac{1}{16}$ inch). The correction to be applied to the distance when the two ends of the tape are not at the same level is computed in the same way.

21. **Sag.** — If a tape is suspended only at the ends it will hang in a curve which is known as the “catenary.” On account of this curvature the distance between the end points is evidently less than the length of the tape. The amount of this shortening, called the *effect of sag*, depends upon the weight of the tape, the distance between the points of suspension, and the pull exerted

* In the right triangle,

$$c^2 - a^2 = h^2,$$

$$(c + a)(c - a) = h^2,$$

assuming $c = a$ and applying it to the first parenthesis only,

$$2c(c - a) = h^2 \text{ (approximately)}$$

$$\therefore c - a = \frac{h^2}{2c} \text{ (approximately)}$$

Similarly $c - a = \frac{h^2}{2a} \text{ (approximately)}$

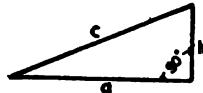

It is evident that the smaller h is in comparison with the other two sides the more exact will be the results obtained by this formula. This formula is even correct to the nearest $\frac{1}{16}$ ft. when $h = 14$ ft. and $a = 100$ ft., or when $h = 30$ ft. and $a = 300$ ft.

at the ends of the tape. With a 12-lb. pull on an ordinary 100-ft. steel tape supported at the ends the effect of sag is about 0.01 ft.

22. Effect of Wearing on Length of the Chain. — When a chain is new it is very nearly the standard length. During its first use the links become bent and the chain thus shortened. But there are nearly six hundred wearing surfaces and before long the small amount of wear on each surface lengthens the chain an appreciable amount. It is very common to find chains which, after considerable use, have lengthened 0.3 ft. or more.

23. ACCURACY OF MEASUREMENTS. — In surveying we are dealing entirely with measurements. Since absolute accuracy can never be attained, we are forced to make a careful study of the errors of measurement. Extremely accurate measurements are expensive, and the cost of making the survey usually limits its accuracy. On the other hand, if a given degree of accuracy is required, the surveyor must endeavor to do the work at a minimum cost. In most surveys certain measurements are far more important than others and should therefore be taken with more care than the relatively unimportant measurements.

The surveyor should distinguish carefully between errors which are of such a nature that they tend to balance each other and those which continually accumulate. The latter are by far the more serious. Suppose that a line 5000 ft. long is measured with a steel tape which is 0.01 ft. too long and that the error in measuring a tape-length is, say, 0.02 ft., which may of course be a + or a - error. There will then be 50 tape-lengths in the 5000-ft. line. A study of the laws governing the distribution of accidental errors (Method of Least Squares) shows that in such a case as this the number of errors that will probably remain uncompensated is the square root of the total number of opportunities for error, i.e., in the long run this would be true. Hence the total number of such uncompensated errors in the line is 7; and $7 \times 0.02 = 0.14$ ft., which is the total error due to inaccuracy in marking the tape-lengths on the ground. Since the error due to erroneous length of tape increases directly as the number of measurements, and since these errors are not compensating, the total error in the line due to the fact that the tape is 0.01 ft. too

long is $50 \times 0.01 = 0.50$ ft. The small (0.01) accumulative error is therefore seen to have far greater effect than the larger (0.02) compensating error.

PROBLEMS.

1. A distance is measured with an engineer's chain and found to be 796.4 ft. The chain when compared with a standard is found to be 0.27 ft. too long. What is the actual length of the line?

2. A metallic tape which was originally 50 ft. is found to be 50.14 ft. long. A house 26 ft. \times 30 ft. is to be laid out. What measurements must be made, using this tape, in order that the house shall have the desired dimensions?

3. A steel tape is known to be 100.000 ft. long at 62° F. with a pull of 12 lbs. and supported its entire length. Its coefficient of expansion is 0.000063 for 1° F. A line was measured and found to be 142.67 ft. when the temperature was 8° below zero. What is the true length of the line?

4. In chaining down a hill with a surveyor's chain the head-chainman held his end of the chain 1.5 ft. too low. What error per chain-length would this produce?

5. In measuring a line with a 100-ft. tape the forward end is held 3 ft. to the side of the line. What is the error in one tape-length?

CHAPTER II.

MEASUREMENT OF DIRECTION.

24. **THE SURVEYOR'S COMPASS.**—The surveyor's compass (Fig. 3) is an instrument for determining the direction of a line with reference to the direction of a magnetic needle. The needle is balanced at its center on a *pivot* so that it swings freely in a horizontal plane. The pivot is at the center of a horizontal circle which is graduated to degrees and half-degrees, and numbered from two opposite zero points each way to 90° . The zero points are marked with the letters N and S, and the 90° points are marked E and W. The circle is covered with a glass plate to protect the needle and the graduations, the part enclosed being known as the *compass-box*. A screw is provided for raising the needle from the pivot by means of a lever. The needle should always be raised when the compass is lifted or carried, to prevent dulling the pivot-point; a dull pivot-point is a fruitful source of error. Both the circle and the pivot are secured to a brass frame, on which are two vertical sights so placed that the plane through them also passes through the two zero points of the circle. This frame rests on a tripod and is fastened to it by means of a ball-and-socket joint. On the frame are two spirit levels at right angles to each other, which afford a means of leveling the instrument. This ball-and-socket joint is connected with the frame by means of a spindle which allows the compass-head to be revolved in a horizontal plane, and to be clamped in any position.

The magnetic needle possesses the property of pointing in a fixed direction, namely, the *Magnetic Meridian*. The horizontal angle between the direction of this meridian and of any other line may be determined by means of the graduated circle, and this angle is called the *Magnetic Bearing* of the line, or simply its *Bearing*. By means of two such bearings the angle between two lines may be obtained. Bearings are reckoned from 0° to 90° ,

the 0° being either at the N or the S point and the 90° either at the E or the W point. The quadrant in which a bearing falls is designated by the letters N.E., S.E., S.W., or N.W. For example, if a line makes an angle of 20° with the meridian and is in the southeast quadrant its bearing is written S 20° E. Sometimes the bearing is reckoned in a similar manner from



FIG. 8. SURVEYOR'S COMPASS.

the geographical meridian, when it is called the *true bearing*. In general this will not be the same as the magnetic bearing. True bearings are often called *azimuths*, and are commonly reckoned from the south point right-handed (clockwise) to 360° ; i.e., a line running due West has an azimuth of 90° , a line due North an azimuth of 180° . Sometimes, however, the azimuth

is reckoned from the north as in the case of the azimuth of the Pole-Star (Art. 206, p. 180).

25. **THE POCKET COMPASS.** — The *pocket compass* is a small hand instrument for obtaining roughly the bearing of a line. There are two kinds, the *plain* and the *prismatic*. The former is much like the surveyor's compass, except that it has no sights. In the prismatic compass the graduations, instead of being on the compass-box, are on a card which is fastened to the needle (like a mariner's compass) and which moves with it. This compass is provided with two short sights and the bearing can be read, by means of a prism, at the same instant that the compass is sighted along the line.

26. **METHOD OF TAKING A MAGNETIC BEARING.** — The surveyor's compass is set up (and leveled) at some point on the line whose bearing is desired. The needle is let down on the pivot; and the compass is turned so that the sights point along the line. While looking through the two sights the sur-

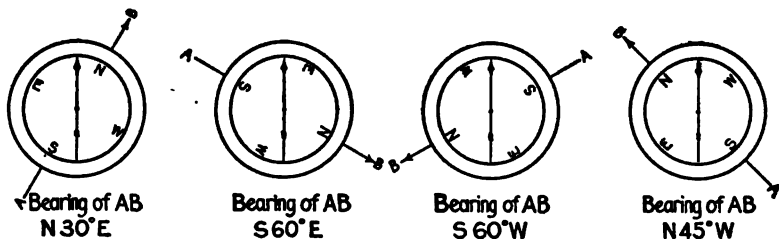

FIG. 4. DIAGRAM ILLUSTRATING READING OF BEARINGS.

veyor turns the compass-box so that they point exactly at a lining pole or other object marking a point on the line. The glass should be tapped lightly over the end of the needle to be sure that the latter is free to move. If it appears to cling to the glass this may be due to the glass being electrified, which condition can be removed at once by placing the moistened finger on the glass. The position of the end of the needle is then read on the circle and recorded. Bearings are usually read to the nearest quarter of a degree.

Since the needle stands still and the box turns under it, the letters E and W on the box are reversed from their natural position so that the reading of the needle will not only give the

angle but also the proper quadrant. Reference to Fig. 4 will show the following rule to be correct: — **When the north point of the compass-box is toward the point whose bearing is desired, read the north end of the needle.** When the south point of the box is toward the point, read the south end of the needle. If a bearing of the line is taken looking in the opposite direction it is called the *reverse bearing*.

Since iron or steel near the instrument affects the position of the needle, great care should be taken that the chain, axe, or marking pins are not left near the compass. Small pieces of iron on the person, such as keys, iron buttons, or the iron wire in a stiff hat, also produce a noticeable effect on the needle. Electric currents are a great source of disturbance to the needle and in cities, where electricity is so common, the compass is practically useless.

In reading the compass-needle, the surveyor should take care to read the farther end of the needle, always looking **along** the needle, not across it. By looking at the needle sidewise it is possible to make it **appear** to coincide with a graduation which is really at one side of it. This error is called *parallax*.

27. THE EARTH'S MAGNETISM. — Dip of the Needle. — The earth is a great magnet. On account of its magnetic influence a permanent magnet, such as a compass-needle, when freely suspended will take a definite direction depending upon the direction of the lines of magnetic force at any given **place** and **time**. If the needle is perfectly balanced before it is magnetized it will, after being magnetized, dip toward the pole. In the northern hemisphere the end of the needle toward the north pole points downward, the inclination to the horizon being slight in low latitudes and great near the polar region. In order to counteract this dipping a small weight, usually a fine brass wire, is placed on the higher end of the needle at such a point that the needle assumes a horizontal position.

28. DECLINATION OF THE NEEDLE. — The direction which the needle assumes after the counterweight is in position is called the magnetic meridian and rarely coincides with the true meridian. The angle which the needle makes with the true meridian is called the *declination of the needle*. When the north

end of the needle points east of the true, or geographical, north the declination is called *east*; when the north end of the needle points west of true north it has a *west* declination.

29. **Variations in Declination.** — The needle does not constantly point in the same direction. Changes in the value of the declination are called *variations of the declination*.* The principal variations are known as the *Secular, Daily, Annual, and Irregular*.

The *Secular Variation* is a long, extremely slow swing. It is probably periodic in character but its period covers so many years that the nature of it is not thoroughly understood. The following table shows the amount of secular variation as observed in Massachusetts during two centuries.

TABLE 2.
OBSERVED DECLINATIONS OF NEEDLE IN EASTERN MASSACHUSETTS.†

YEAR.	DECLINATION.
1700	10° 31' W.
1750	7° 13' W.
1800	6° 28' W.
1850	9° 10' W.
1900	12° 00' W.

In the United States all east declinations are now gradually decreasing and all west declinations are gradually increasing, at an average rate of about 2 minutes per year.

The *Daily Variation* consists of a swing which averages about 7 minutes of arc from its extreme easterly position at about 8 A.M. to its most westerly position at about 1.30 P.M. It is in its mean position at about 10 A.M. and at 5 or 6 P.M. The amount of daily variation is from 3 to 12 minutes according to the season and the locality.

The *Annual Variation* is a periodic variation so small (about one minute a year) that it need not be considered in surveying work.

* The angle called *Declination* by surveyors is usually called *Variation* by navigators.

† See p. 107 of U. S. Coast and Geodetic Survey special publication entitled "U. S. Magnetic Declination Tables and Isogonic Chart for 1902, and Principal Facts Relating to the Earth's Magnetism," by L. A. Bauer, issued in 1902.

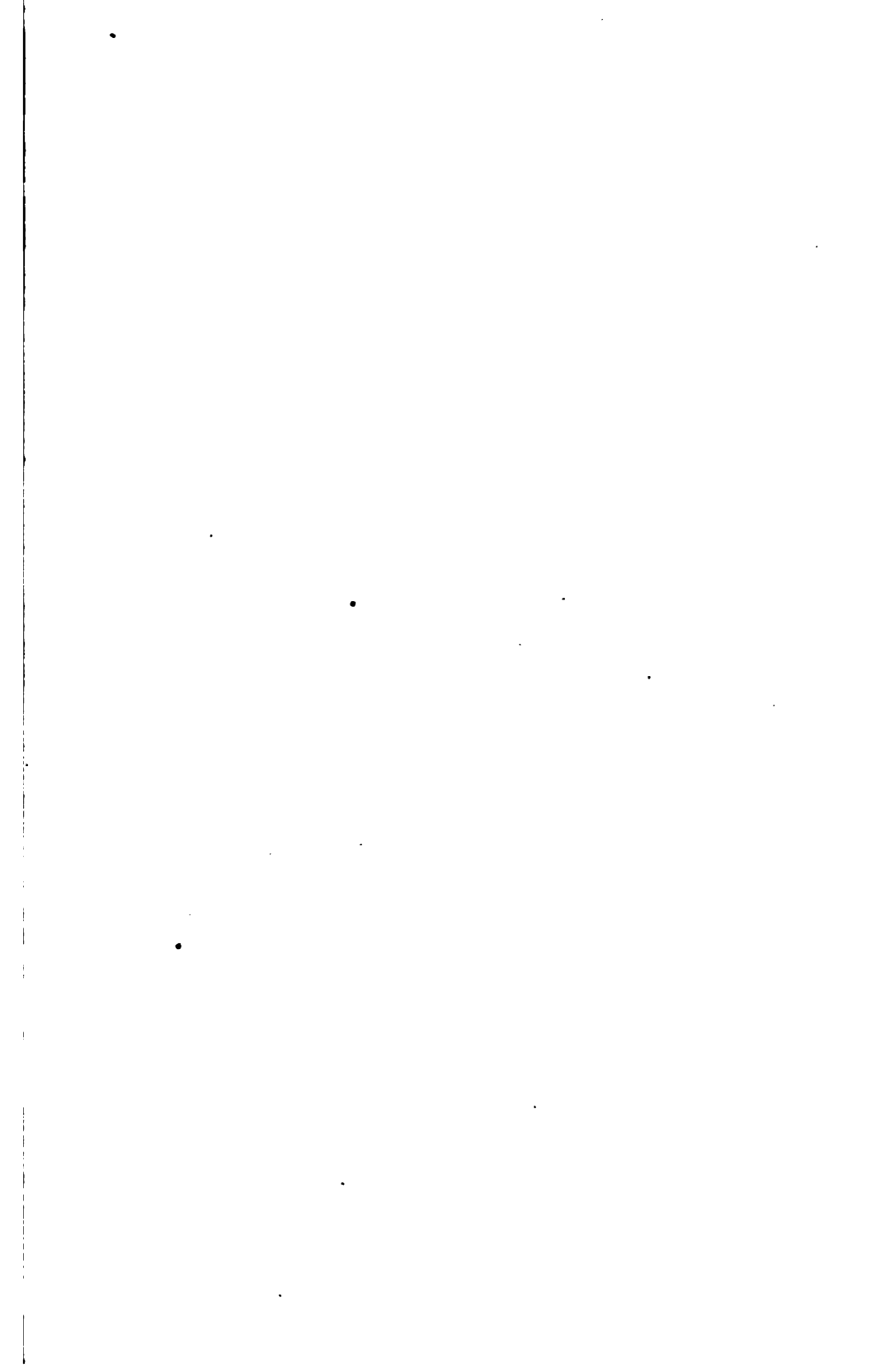

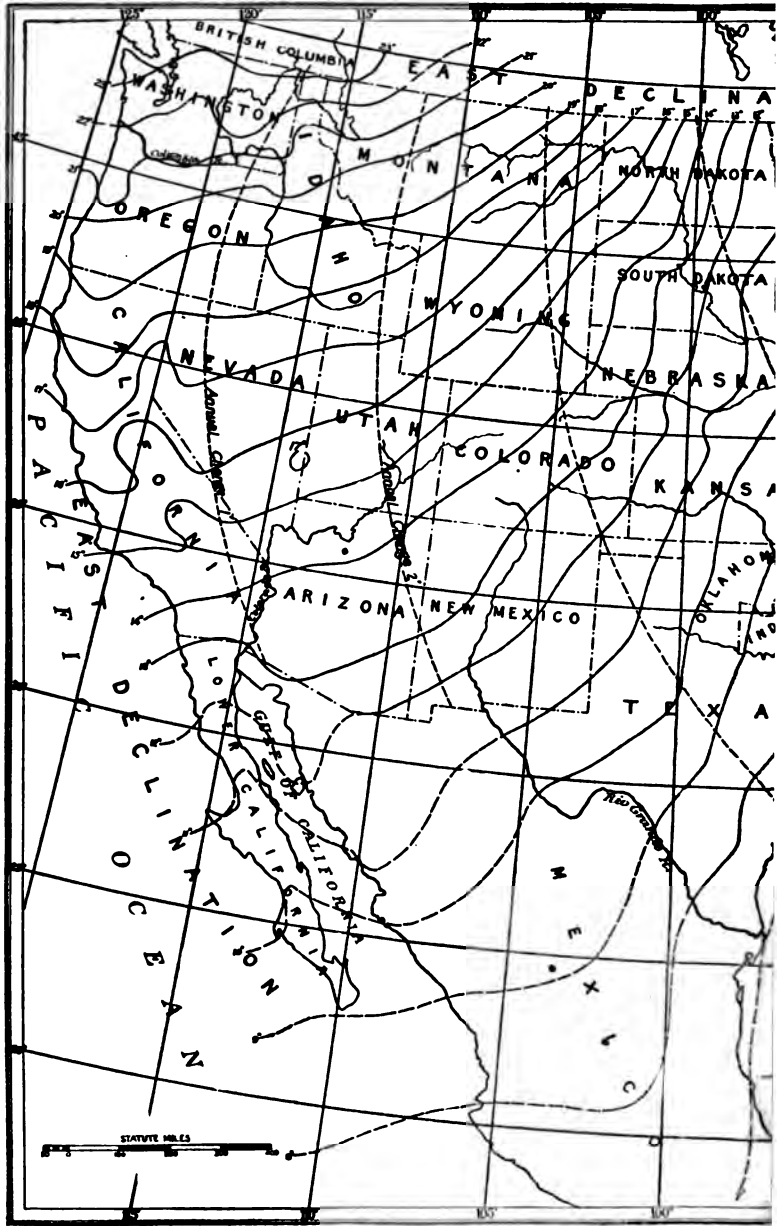
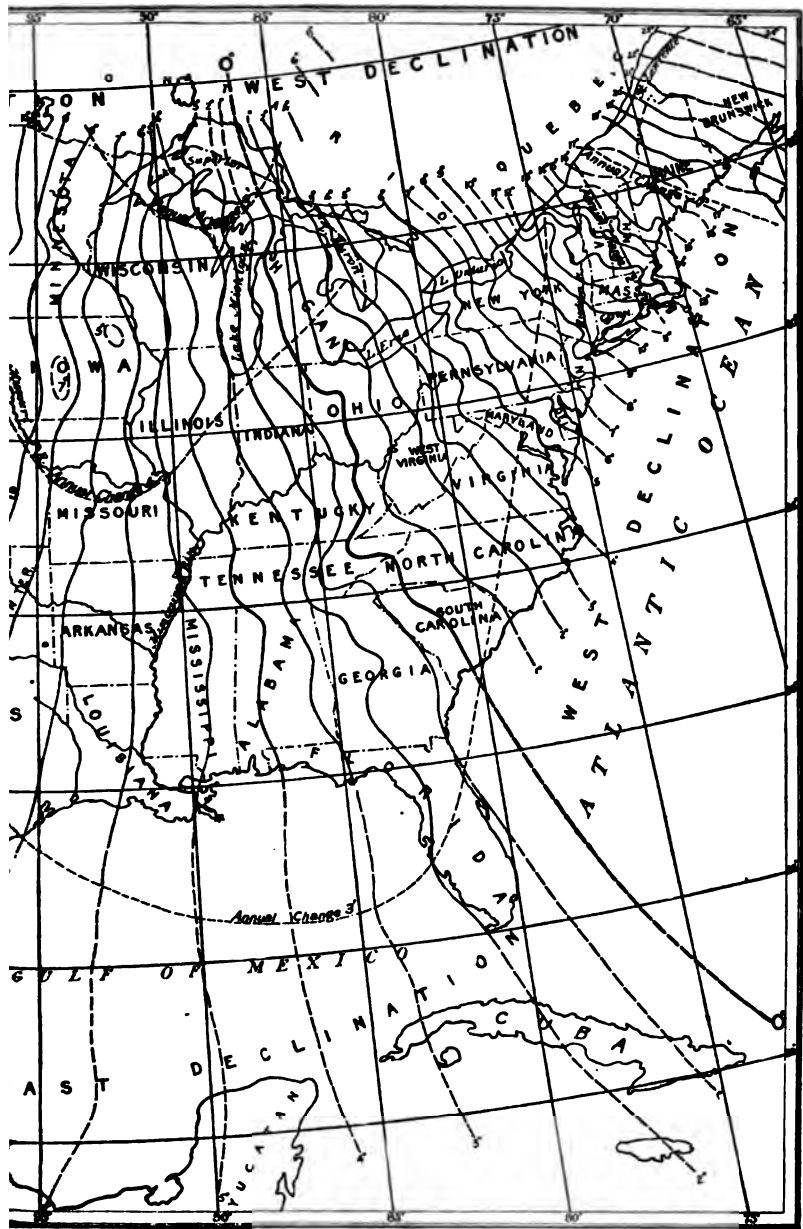

FIG. 5. ISOGONIC CHART OF THE UNITED STATES

(From the U. S. Coast and Geodetic Survey special publication entitled "U. S. Magnetic Declination Tables" by L. A. B.)



UNITED STATES FOR THE EPOCH JANUARY, 1902

(See Tables and Isogonic Chart for 1902, and Principal Facts Relating to the Earth's Magnetism," issued in 1902.)



Irregular Variations in the declination are due chiefly to magnetic storms. They are uncertain in character and cannot be predicted. They are, however, usually observed whenever there is a display of the Aurora Borealis. Such storms often cause variations of from ten to twenty minutes in the United States and even more in higher latitudes.

30. Isogonic Chart.— If lines are drawn on a map so as to join all places where the declination of the needle is the same at a given time, the result will be what is called an *isogonic chart*. (See Fig. 5.) Such charts have been constructed by the United States Coast and Geodetic Survey. While they do not give results at any place with great precision they are very useful in finding approximate values of the declination in different localities.

An examination of the isogonic chart of the United States shows that in the Eastern States the needle points west of north while in the Western States it points east of north. The line of no declination, or the *agonic line*, passes at the present time (1906) through the Carolinas, Ohio and Michigan.

31. OBSERVATIONS FOR DECLINATION.— For any survey where the value of the present declination is important, it should be found by special observations. The value found at one place may be considerably different from that of a place only a few miles distant. The method of finding the declination by observation on the Pole-Star (Polaris) is described in Art. 210, p. 187.

ADJUSTMENTS OF THE COMPASS.

32. The three adjustments which need to be most frequently made are (1) adjusting the bubbles, (2) straightening the needle, (3) centering the pivot-point.

33. ADJUSTMENT OF THE BUBBLES.— To make the Plane of the Bubbles Perpendicular to the Vertical Axis.— Level the instrument in any position. Turn 180° about the vertical axis and, if the bubbles move from the center, bring each half-way back by means of the adjusting screws; and repeat the process until the desired fineness of adjustment is secured.

34. DETECTING ERRORS IN ADJUSTMENT OF THE NEEDLE.— If the readings of the two ends of the needle are not 180°

apart, this may be due to the needle being bent, to the pivot-point not being in the center of the graduated circle, or to both. If the difference of the two readings is the same in whatever

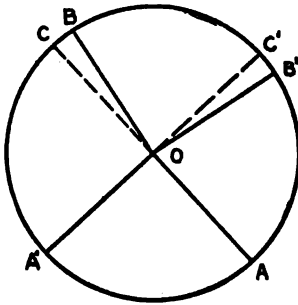

FIG. 6. BENT COMPASS-NEEDLE.

direction the compass is turned, it follows that the needle is bent but the pivot-point is in the center of the circle. (See Fig. 6.) The bent needle is represented by the line AOB and the position of a straight needle shown by the line AOC . In the two positions shown it is seen that the difference in readings will be the same, i.e., arc $CB = \text{arc } C'B'$. If the difference of the readings varies as the compass is turned around it follows that the

pivot-point is not in the center, and the needle may or may not be bent. Suppose the needle is straight but the pivot is not in the center, then the effect in different parts of the circle is shown in Fig. 7. When the needle is in the position AD , perpendicular to CC' , (where C is the true center and C' is the position of the pivot-point), then the error is a maximum. If B is a point 180° from A then the difference of the two readings is BD . When the needle is at $A'D'$ the error is less than before and equals $B'D'$. When the needle is in the line CC' , i.e., in the position $A''D''$, the ends read alike.

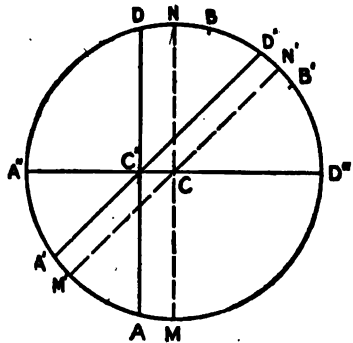

FIG. 7. PIVOT-POINT OUT OF CENTER.

In making these adjustments it is better to first straighten the needle, because the error due to the needle being bent can be detected independently of the error of the pivot.

35. TO STRAIGHTEN THE COMPASS-NEEDLE.—Level the instrument and let the needle down on the pivot. Remove the glass cover. By means of a brass wire or a light stick of wood

steady the needle so that one end of it, say the south end, is opposite some graduation on the circle as *A* in Fig. 8. Note the position of the north end of the needle *C*. Now, without moving the compass itself, turn the needle around so that the north end is at the graduation *A*. Hold it in this position with the brass wire and read the position of the south end *C'*. One-half the difference of the readings, or, the distance *C'D* is the amount by which the needle is bent.

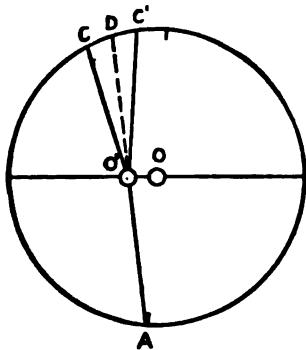

FIG. 8. STRAIGHTENING THE COMPASS-NEEDLE.

Carefully remove the needle from the pivot and bend it by the amount *C'D* in the direction which will move the south end half-way back from *C'* toward *C*. It is better not to touch the needle with the hands more than is absolutely necessary as this weakens the magnetism. Instrument makers usually leave the central part of the needle quite soft so that it can be easily bent in making this adjustment.

Since the amount by which the needle is bent is a matter of estimation it should be replaced on the pivot and the test repeated until it is found that reversing the needle does not change the readings.

36. TO CENTER THE PIVOT-POINT. — If the difference of readings of the two ends of the needle varies in different parts of the circle it is due to the pivot-point being out of center. Take readings of the two ends of the needle in various positions of the compass and find the position of the needle in which the difference of the two readings is greatest (Art. 34, p. 25). The pivot is to be bent at right angles to this direction an amount equal to half this difference. Remove the needle and bend the pivot by means of a pair of small flat pliers. Replace the needle and see if the difference of end readings is zero. If not, the pivot must be bent until this condition is fulfilled. As the pivot may become bent somewhat in a direction other than that intended, a complete test for adjustment must be made again, and the process continued until the difference in the readings of the ends of the needle is zero in all positions of the compass. The

metal at the base of the pivot is left soft so that it can be easily bent.

37. TO REMAGNETIZE THE NEEDLE. — Rub each end of the needle from the center toward the end several times with a bar-magnet, using the N end of the magnet for the S end of the needle and *vice versa*. (The N end of the magnet attracts the S end of the needle and repels its N end.) When the magnet is drawn along the needle it should move in a **straight line**, parallel to the axis of the needle. When returning the bar from the end of the needle toward the center, lift it several inches **above** the needle as indicated in Fig. 9.

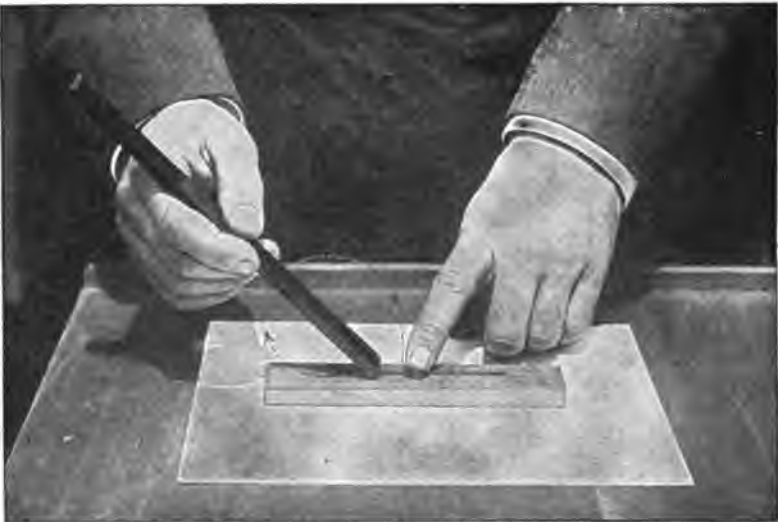

FIG. 9. REMAGNETIZING THE COMPASS-NEEDLE.

38. COMMON SOURCES OF ERROR IN COMPASS WORK. —

1. Iron or steel near compass.
2. Parallax in reading needle.

39. COMMON MISTAKES. —

1. Reading wrong end of needle.
2. Not letting needle down on pivot.
3. Reading the wrong side of the 10th degree, viz., reading 61° instead of 59° .

40. DETECTING LOCAL ATTRACTION OF THE NEEDLE.—As the needle is always affected by masses of iron near the compass it is important that the bearings in any survey should be checked. This is most readily done by taking the bearing of any line from both its ends or from intermediate points on the line. If the two bearings agree it is probable that there is no local magnetic disturbance. If the two do not agree it remains to discover which is correct.

In Fig. 11 suppose that the compass is at *A* and that the

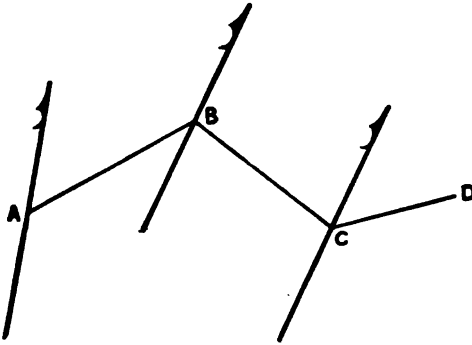

FIG. 11. DIAGRAM ILLUSTRATING LOCAL ATTRACTION AT *A*.

bearing of *AB* is $N 50^{\circ}\frac{1}{4} E$, and with the compass at *B* the bearing *BA* is found to be $S 49^{\circ} W$. It is evident that there is local attraction at one or both points. In order to ascertain the correct magnetic bearing, turn the compass toward a point *C* which is apparently free from magnetic disturbance, and observe the bearing of *BC*, which is, say, $S 72^{\circ} E$. Now move the compass to *C* and observe the bearing *CB*. If this is $N 72^{\circ} W$ it indicates that there is no local attraction at *C* or *B*, hence $S 59^{\circ} W$ is the correct bearing of line *BA*, and there is $1^{\circ}\frac{1}{4}$ error in all bearings taken at *A*. If the bearings of *BC* and *CB* had not agreed it would have been necessary to take the bearing and reverse bearing of a new line *CD*. This process is continued until a line is found whose bearing and reverse bearing differ by exactly 180° .

41. CALCULATING ANGLES FROM BEARINGS.—In calculating the angle between two lines it is necessary only to remember that the bearing is in all cases reckoned from the meridian, either N or S, toward the E and W points. In Fig. 10,

AOB = difference of bearings.

AOC = 180° — sum of bearings.

AOD = 180° — difference of bearings.

AOF = sum of bearings.

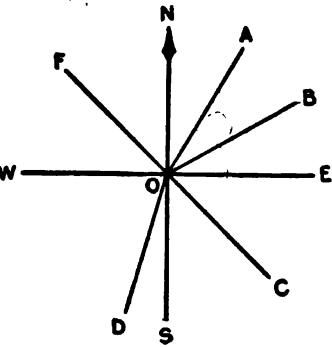

FIG. 10.

PROBLEMS.

1. Compute the angle AOB from the given bearings in each of the following cases.

(a) OA , $N 39^\circ \frac{1}{4}$ E.

OB , $N 76^\circ \frac{1}{4}$ E.

(b) OA , $N 35^\circ 15'$ E.

OB , $S 88^\circ 00'$ W.

(c) OA , $N 15^\circ$ E.

OB , $S 36^\circ$ E.

(d) OA , $N 40^\circ 15'$ E.

OB , $N 66^\circ 45'$ W.

2. The bearing of one side of a field in the shape of a regular hexagon is $S 10^\circ \frac{1}{4}$ E. Find the bearings of the other sides taken around the field in order.

3. (a) In 1859 a certain line had a bearing of $N 21^\circ$ W. The declination of the needle at that place in 1859 was $8^\circ 39'$ W. In 1902 the declination was $10^\circ 58'$ W. What was the bearing of the line in 1902?

(b) In 1877 a line had a bearing of $N 89^\circ 30'$ E. The declination was $0^\circ 13'$ E. In 1902 the declination was $1^\circ 39'$ W. Find the bearing of the line in 1902.

(c) At a certain place the declination was $4^\circ 25'$ W in 1700, $1^\circ 39'$ W in 1750, $0^\circ 21'$ E in 1800, $1^\circ 03'$ W in 1850, $4^\circ 00'$ W in 1900. If a line had a bearing of $S 65^\circ \frac{1}{4}$ W in 1900, what was its bearing in 1700, 1750, 1800, and 1850?

4. The following bearings were observed with a compass: AB , $N 27^\circ \frac{1}{4}$ E; BA , $S 25^\circ \frac{1}{4}$ W; BC , $S 88^\circ$ W; CB , $N 87^\circ \frac{1}{4}$ E; CD , $N 47^\circ \frac{1}{4}$ W; DC , $S 47^\circ \frac{1}{4}$ E. Find the true bearing of AB . Where is the local attraction? Which way is the needle deflected at each point, and how much?

CHAPTER III.

MEASUREMENT OF ANGLES.

THE TRANSIT.

42. **GENERAL DESCRIPTION OF THE TRANSIT.**—The engineer's transit is an instrument for measuring horizontal and vertical angles. A section of the transit is shown in Fig. 12.

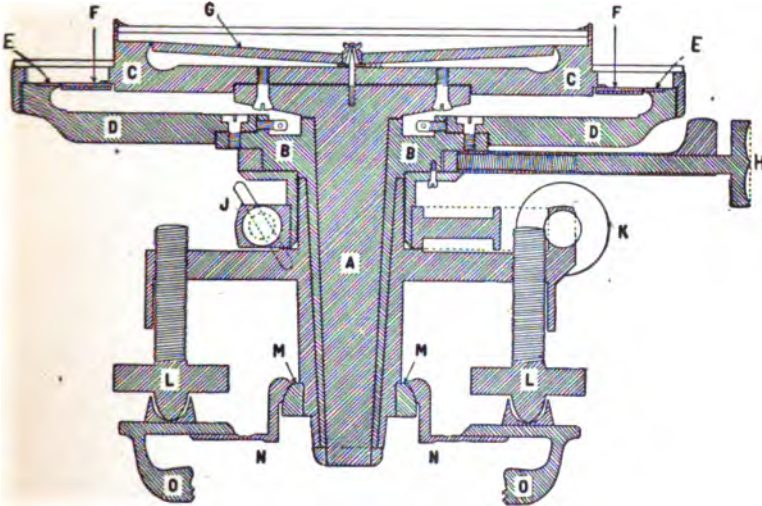

FIG. 12. SECTION OF TRANSIT.

A, inner spindle; *B*, outer spindle; *C*, upper plate; *D*, lower plate; *E*, graduated circle; *F*, vernier; *G*, magnetic needle; *H*, upper clamp (turned 90° from its normal position so as to show in section, corresponding tangent screw not shown); *J*, lower clamp; *K*, lower tangent screw; *L*, leveling screws; *M*, ball-and-socket joint; *N*, shifting head; *O*, base of transit.

Two spindles, one inside the other, are each attached to a horizontal circular plate, the outer spindle being attached to the lower plate and the inner one to the upper plate. Except in some older instruments, the lower plate carries a graduated circle and the upper plate carries the *verniers* for reading the circle. On this upper plate are two uprights or *standards*

supporting a horizontal axis. The length of the telescope and the height of the standards are commonly such as to allow the telescope to make a complete rotation on its horizontal axis. The motion of this axis is usually controlled by a clamp and a *slow-motion screw* called a *tangent screw*. In older instruments this often consisted of two opposing screws; in modern instruments it usually consists of a single screw with an opposing spring. At the center of the horizontal axis is a telescope attached at right angles to it.

For leveling the instrument, there are two spirit levels on the upper plate, one parallel and the other at right angles to the horizontal axis. The spirit level which is parallel to the axis is the more important one because it controls the position of the horizontal axis of the telescope; it should be and generally is made more sensitive than the other. In the transit, the leveling is done by means of four (sometimes three) leveling screws.

The upper plate is usually provided with a magnetic needle and a graduated circle so that the transit may be used as a compass. The lower spindle is attached to the base of the instrument by means of a ball-and-socket joint the same as in the compass. Both the upper and lower plates are provided with clamps for holding them in any desired position and with tangent screws for making exact settings.

At the center of the ball-and-socket joint is a ring to which the plumb-line may be attached. The plumb-bob used with the transit is generally heavier than that used in taking tape measurements. Modern transits are so made that the entire head of the instrument can be shifted laterally with reference to the tripod and can thus be readily placed exactly over a point on the ground.

The horizontal circle is usually graduated either to half-degrees or to 20-minute spaces. The graduations are often numbered from 0° to 360° by two rows of figures running in opposite directions. In some transits they are numbered from 0° to 360° in a right-hand direction and, by a second row of figures, from 0° each way to 180° ; and still others (older types) are numbered from 0° to 90° in opposite directions, like a compass circle. Transits are all provided with two opposite verniers.



FIG. 13. ENGINEER'S TRANSIT.

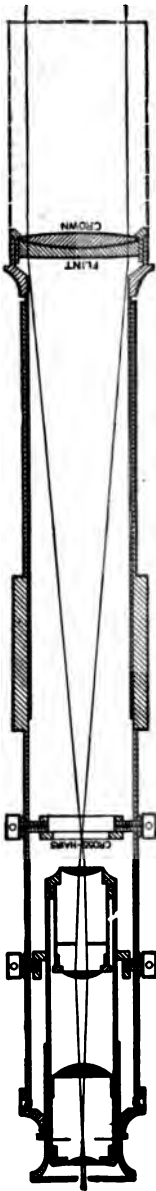

FIG. 14. LONGITUDINAL SECTION OF A TRANSIT TELESCOPE.

43. The *normal* or *direct* position of the transit is with the upper clamp and its tangent screw nearest the observer and the focusing screw of the telescope on the right-hand side (in some instruments, on top) of the telescope. When the instrument is turned 180° in azimuth from the direct position and the telescope is *inverted* (turned over about the horizontal axis) it is said to be in the *reversed* position.

44. If the telescope is provided with a long level tube and a vertical circle, or arc, it is called an *Engineer's Transit*, or *Surveyor's Transit*. (Fig. 13.) If it does not have these attachments it is called a *Plain Transit*.

45. **THE TELESCOPE.** — The essential parts of the telescope are the *objective*, the *cross-hairs*, and the *eyepiece*. (See Fig. 14.)

The line of sight, or *line of collimation*, is the straight line drawn through the optical center of the objective and the point of intersection of the cross-hairs. When light from any point *A* falls on the objective, the rays from *A* are bent and brought to a focus at a single point *B* called the *image*. The only exception to this is in the case when *A* is on the optical axis; the ray which coincides with the optical axis is not bent. The cross-hairs are placed in the telescope tube near where the image is formed, as shown in Fig. 14. The objective is screwed into a tube, which is inside the main tube and which can be moved by means of a rack-and-pinion screw so as to bring the plane of the image of the object into coincidence with the plane of the cross-hairs. The instrument is so constructed that the motion

of this tube is parallel to the line of sight. The eyepiece is simply a microscope for viewing the image and the cross-hairs. When the plane of the image coincides with the plane of the cross-hairs, both can be viewed at the same instant by means of the eyepiece. The adjustment of the eyepiece and the objective, to enable the cross-hairs and the image to be clearly seen at the same time, is called *focusing*.

In focusing, first the eye-piece tube is moved in or out until the cross-hairs appear distinct; then the objective is moved until the image is distinct. If it is found that the cross-hairs are no longer distinct after moving the objective the above process is repeated until both image and cross-hairs are clearly seen **at the same instant**. The focus should be tested for parallax by moving the eye slightly from one side to the other; if the cross-hairs appear to move over the image the focus is imperfect. In focusing on objects at different distances it should be remembered that the nearer the object is to the telescope, the farther the objective must be from the cross-hairs; and that for points near the instrument the focus changes rapidly, i.e., the objective is moved considerably in changing from a focus on a point 10 ft. away to one 20 ft. away, whereas for distant objects the focus changes very slowly, the focus for 200 ft. being nearly the same as that for 2000 ft. An instrument can be quickly focused on a distant object if the objective is first moved in as far as it will go and then turned out slowly until the image is distinct. The objective should not be turned too rapidly as it may pass the correct position before the eye can detect the distinct image. If an instrument is badly out of focus it may be pointing directly at an object and yet the image may not be visible.

46. The Objective.—The objective might consist of a simple bi-convex lens, like that shown in Fig. 15, which is formed by the intersection of two spheres. The line OO' joining the centers of the two spheres is called the *optical axis*. If rays parallel to the optical axis fall on the lens those near the edge of the lens are bent, or refracted, more than those near the center, so that all the rays are brought to a focus (nearly) at a point F on the optical axis called the *principal focus*. If light falls on the lens from any direction there is one of the rays such as

AC or BD which passes through the lens without permanent deviation, i.e., it emerges from the other side of the lens parallel to its original direction. All such rays intersect at a point X on the optical axis which is called the *optical center*.

A simple bi-convex lens does not make the best objective because the rays do not all come to a focus at **exactly** the same point. This causes indistinctness and also color in the field of

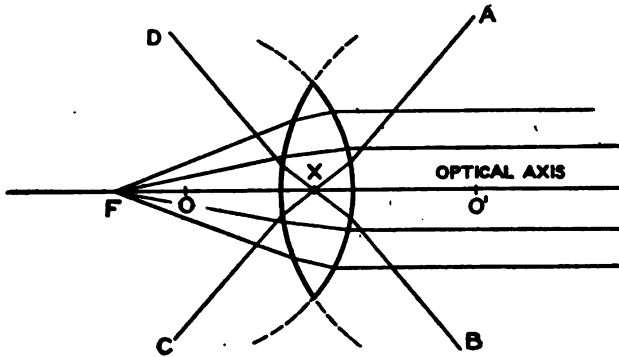

FIG. 15. BI-CONVEX LENS.

view, particularly near the edges. This difficulty is overcome by using a combination of lenses, consisting of "crown" and "flint" glass as shown in Fig. 14, which very nearly corrects these imperfections.

The position of the image of any point is located on a straight line (nearly) through the point and the optical center; hence it will be seen that the image formed by the objective is inverted.

47. Cross-Hairs. — The cross-hairs consist of two very fine spider threads stretched across a metallic ring at right angles to each other and fastened by means of shellac. The cross-hair ring (Fig. 16) is held in place by four capstan-headed screws which permit of its being moved

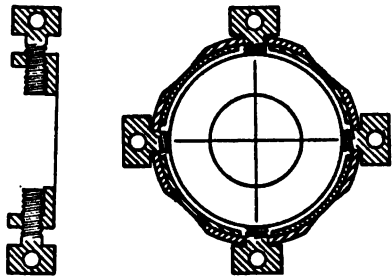

FIG. 16. CROSS-HAIR RING.

vertically or horizontally in the telescope tube. The holes in the tube through which the screws pass are large enough to allow some motion of the ring in adjusting.

48. Eyepiece. — The eyepiece of the ordinary transit telescope may be either of two kinds, that which shows an inverted image or that which shows an erect image. An erecting eyepiece requires two more lenses than the inverting eyepiece, which add to its length and also absorb light ; but in spite of these disadvantages the erecting eyepiece is generally used on ordinary transits. It will be seen, however, that with the same length of telescope a greater magnifying power and a clearer definition of the image can be obtained by the use of the inverting eyepiece. These advantages are so important and the disadvantage of seeing objects inverted is so slight that inverting eyepieces should be used more generally than they are at present.

49. Magnifying Power. — The magnifying power is the amount by which an object is increased in apparent size. It is equal to $\frac{\tan \frac{1}{2} A}{\tan \frac{1}{2} a}$, (or nearly equal to $\frac{A}{a}$), A being the angle subtended by an object as seen through the telescope and a the angle as seen by the unaided eye.

50. The magnifying power may be measured in two ways.
(1) The dimensions on a graduated rod will appear magnified when viewed through a telescope. If, with one eye at the telescope, the rod is viewed directly with the other eye it will be noticed that one space as viewed through the telescope will appear to cover a certain number of spaces as seen with the naked eye. This number is approximately the magnifying power of the telescope.

(2) Viewed through a telescope wrong-end-to, an object is reduced in apparent size in the same ratio that it is magnified when seen through the telescope in the usual manner. Measure with a transit some small angle A between distant points and then place the telescope to be tested in front of the transit, with its objective next the objective of the transit. Measure the angle a between the same points ; this new angle will be smaller. Then the Magnifying Power = $\frac{\tan \frac{1}{2} A}{\tan \frac{1}{2} a}$. The magnifying power

of the ordinary transit telescope is between twenty and thirty diameters.

51. **Field of View.**—The field of view is the angular space that can be seen at one time through the telescope. It is the angle subtended at the optical center of the objective by the opening in the eyepiece. In the ordinary transit this angle is about one degree, but in some instruments it is considerably more.

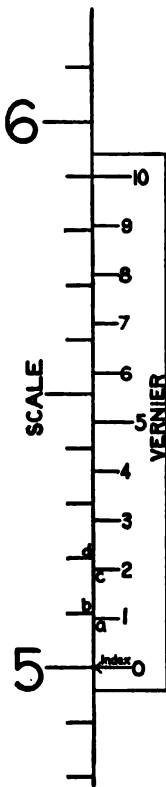

FIG. 17.

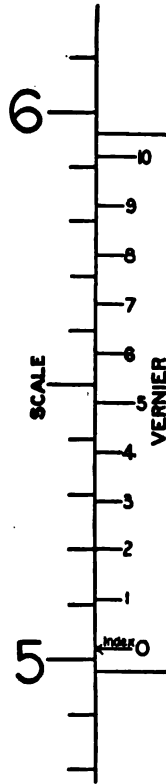

FIG. 18.

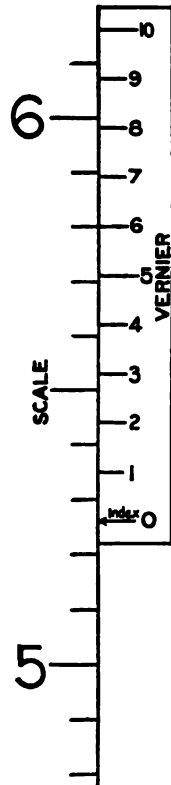

FIG. 19.

52. **THE VERNIER.**—The vernier is a device for determining the subdivision of the smallest division of a scale more accu-

rately than can be done by simply estimating the fractional part. It depends upon the fact that the eye can judge much more exactly when two lines coincide than it can estimate a fractional part of a space.

A simple form of vernier, shown in Fig. 17, is constructed by taking a length equal to 9 divisions on the scale and dividing this length into 10 equal parts. One space on the vernier is then equal to $\frac{9}{10}$ of a space on the scale, i.e., it is $\frac{1}{10}$ part shorter than a space on the scale, hence $ab = \frac{1}{10}$ of a space on the scale, $cd = \frac{2}{10}$ of a space, etc. Now if the vernier is raised until a coincides with b , i.e., until the first line on the vernier coincides with the next higher line on the scale, then the index line has moved over $\frac{1}{10}$ of a space and the reading will be 501. If the vernier is moved $\frac{2}{10}$ space higher then line 2 coincides with the next higher line on the scale and the reading is 502, as shown in Fig. 18. Similarly Fig. 19 shows reading 526. Thus it is seen that the number of the line on the vernier which coincides with a line on the scale is the number of tenths of the smallest division of the scale that the index point (zero) lies above the next lower division on the scale. Furthermore it will be seen from its construction that it is impossible to have more than one coincidence at a time on a single vernier. The type of vernier just described is used on leveling rods.

53. Verniers used on Transits.—In transits, since angles may be measured in either direction, the verniers are usually double, i.e., there is a single vernier on each side of the index point, one of which is to be used in reading angles to the right, and the other in reading angles to the left.

The vernier most commonly found on the transit reads to one minute of arc (Fig. 20). When this vernier is used the circle is divided into degrees and half-degrees. The vernier scale is made by taking a length equal to 29 of the half-degree spaces and subdividing it into 30 equal parts. Each space on the vernier is then equal to $\frac{29}{30} \times 30' = 29'$. Therefore the difference in length of one division on the circle and one division on the vernier is equal to the difference between the 30' on the circle and the 29' on the vernier, or one minute of arc. In

Fig. 20 the zero of the vernier coincides with the 0° mark on the circle. The first graduation on the vernier to the left of the zero fails to coincide with the $0^\circ 30'$ line by just $1'$ of arc.

- The second line on the vernier falls $2'$ short of the 1° mark, the third line $3'$ short of the $1^\circ 30'$ mark, etc. If the vernier should be moved one minute to the left the first line would coin-

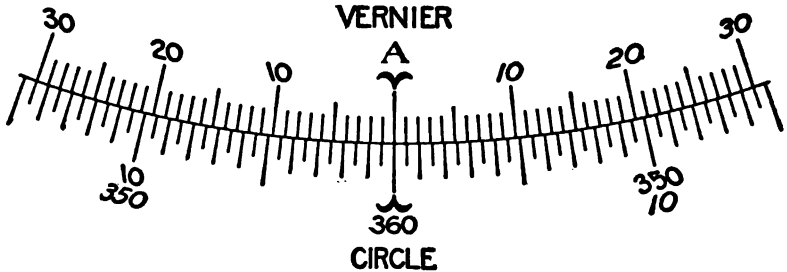

FIG. 20. ONE-MINUTE VERNIER SET AT 0° .

cide and the reading would be $0^\circ 01'$. If the vernier were moved one minute more the second line would coincide and the reading would be $0^\circ 02'$, etc. Therefore the number of the line on the vernier which coincides with **some** line on the circle is the number of minutes to be added to 0° . After the vernier has moved beyond the point where the $30'$ line coincides, it begins subdividing the next space of the circle, and we must then add the vernier reading to $0^\circ 30'$.

The following figures show various types of vernier commonly used on transits.

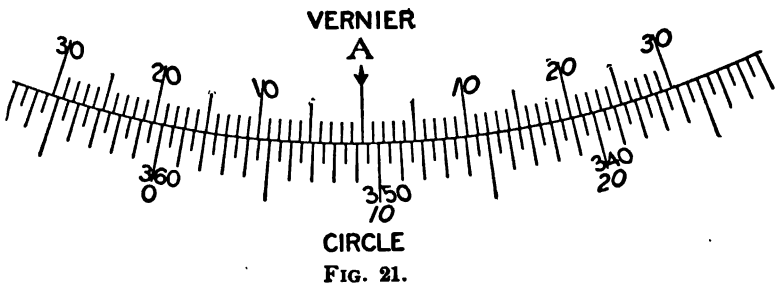

FIG. 21.

Fig. 21. — Double vernier reading to 1'. Circle divided into 30' spaces. 29 divisions of the circle divided into 30 parts to make one division of the vernier.

Reading, inner row of figures, $9^{\circ} 16'$.

Reading, outer row of figures, $350^{\circ} 44'$.

Since the vernier moves with the telescope, read the angle on the circle in the same direction that the telescope has moved. Read the number of degrees and half-degrees the index has passed over and estimate roughly the number of minutes beyond the last half-degree mark. Then follow along the vernier in the same direction and find the coincidence. The number of this line is the number of minutes to be added to the degrees and half-degrees which were read from the circle. An estimate of the number of minutes should always be made as a check against large mistakes in reading the vernier or in reading the wrong vernier.

Fig. 22. — Double vernier reading to 30''. Circle divided

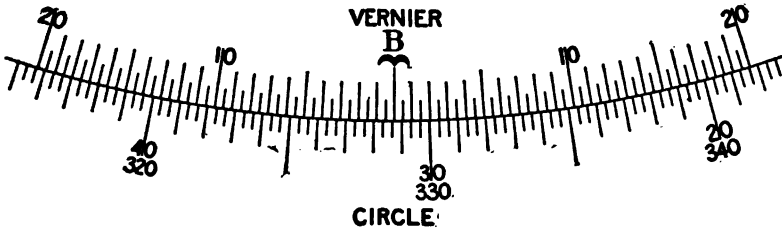

FIG. 22.

into 20' spaces. 39 divisions of the circle divided into 40 parts to make one division of the vernier.

Reading, inner row of figures, $31^{\circ} 17' 30''$.

Reading, outer row of figures, $328^{\circ} 42' 30''$.

Fig. 23. — Single vernier reading to 20". Circle divided into 20' spaces. 59 divisions of the circle divided into 60 parts to make one division of the vernier.

Reading, $73^{\circ} 48' 40''$.

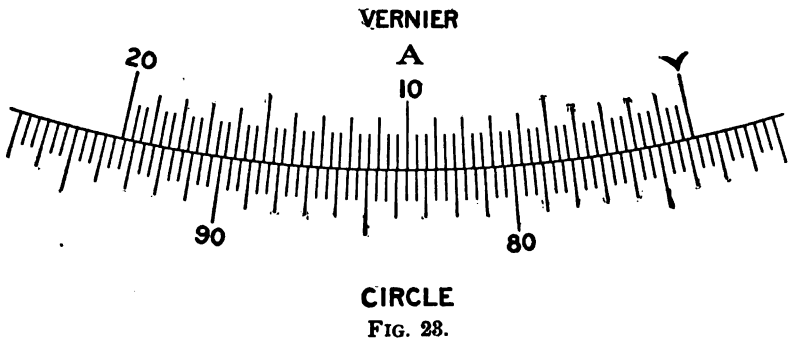

On account of the length of this vernier it is impracticable to use a double vernier. Where it is desirable to read the angles in either direction the circle has two rows of figures as shown in Fig. 24.

Fig. 24 — Reading, inner row of figures, $73^{\circ} 48' 40''$.
Reading, outer row of figures, $266^{\circ} 31' 20''$.

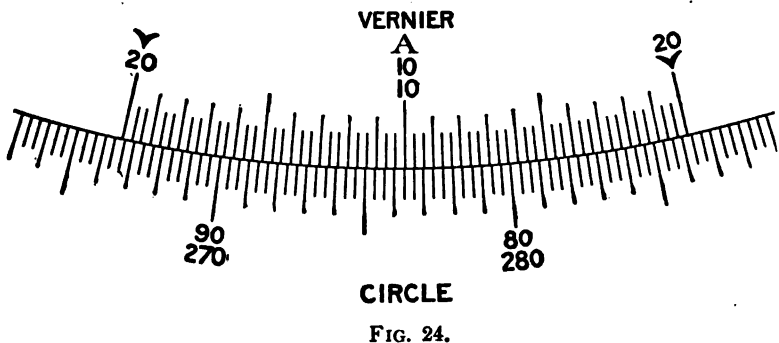

It is evident that if angles are to be read "clockwise" the index at the right end of this vernier should be set at 0° . If

angles are to be measured in the opposite direction the index at the left end should be set at 0° . To avoid this inconvenience of resetting, some surveyors set the middle line ($10'$ line) of the vernier on 0° and disregard the numbering on the vernier, reading it as explained under Fig. 26.

Fig. 25. — Single vernier reading to $10''$. Circle divided

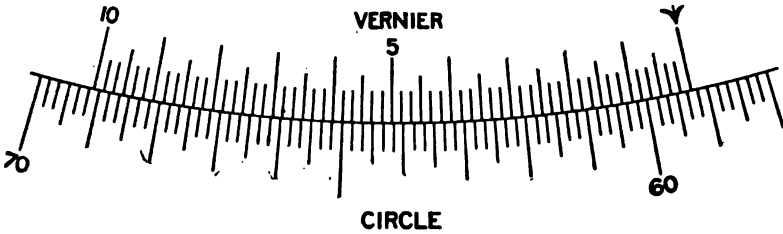

FIG. 25.

into $10'$ spaces. 59 divisions of the circle divided into 60 parts to make one division of the vernier.

Reading, $59^\circ 15' 50''$.

Fig. 26. — Single vernier reading in either direction to $1'$.

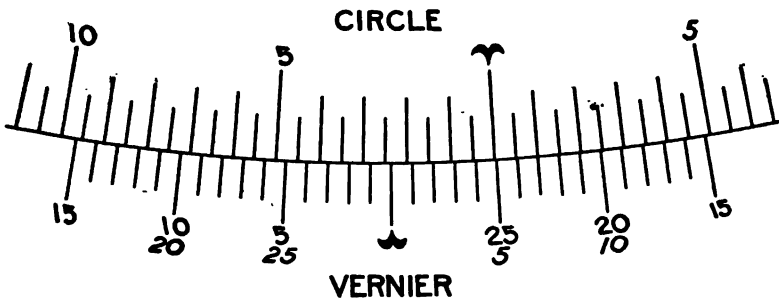

FIG. 26.

Circle divided into $30'$ spaces. 29 divisions of the circle divided into 30 parts to make one division of the vernier.

Reading, $2^\circ 23'$.

This vernier is read like the ordinary v' vernier except that if a coincidence is not reached by passing along the vernier in the direction in which the circle is numbered, it is necessary to go to the other end of the vernier and continue in the same direction, toward the center, until the coincidence is found. This vernier is used on the vertical circle of transits when the space is too small for a double vernier.

There is another type of transit vernier, which is occasionally used, in which the degree is divided into hundredths instead of minutes.

54. ECCENTRICITY. — If the two opposite verniers of a transit do not read exactly alike it is usually due to a combination of two causes, (1) because the center of the vernier plate does not coincide with the center of the graduated circle, (2) because the vernier zeros have not been set exactly 180° apart. The first cause produces a variable difference while the second produces a constant difference.

It will be noticed that the effect of these errors is similar to that described in Art. 34, p. 25, on Adjustments of the Compass; the eccentricity of the circles of the transit corresponding

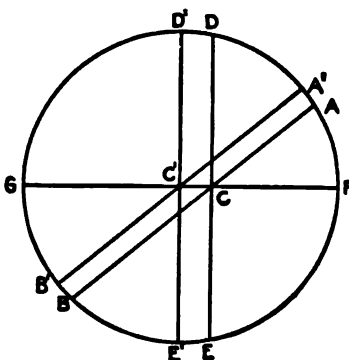

FIG. 27. ECCENTRICITY OF CIRCLE.

to the bent pivot of the compass and the error in the position of the verniers of the transit corresponding to the bent needle of the compass.

With reference to the eccentricity of the plates, let C in Fig. 27 be the center of the vernier plate and C' the center of the circle. Let GF be a line through the two centers. When one vernier is at F and the other is at G the vernier readings will be the same as though C

and C' were coincident, since the displacement of the center of the circle occurs in the direction of the lines of graduation at F and G . If the telescope is then turned at right angles to its former position, the verniers then being at D and E , the readings

of opposite verniers will differ by the maximum amount. Suppose that the graduations are numbered from 0° right-handed to 360° . When the vernier is at an intermediate position, as at A , it will be seen that it reads too much by the amount AA' . The opposite vernier at B reads too little by the amount BB' . Since AB and $A'B'$ are parallel, BB' and AA' are equal. Consequently the mean of the two vernier readings will be the true reading and the eccentricity is in this way eliminated. Since the effect of eccentricity is never more than a very few minutes it is customary to read the degrees and minutes on one vernier and the minutes only on the other.

55. In spite of the fact that the two verniers are not 180° apart no error is introduced provided; (1) that the same vernier is always used, or (2) that the mean of the two vernier readings is always taken. But if vernier A is set and the angle is read on vernier B an error does enter. Where only one vernier is read **always read the vernier that was set at 0° .**

In good instruments both of these errors are very small, usually smaller than the finest reading of the vernier.

USE OF THE TRANSIT.

56. **SETTING UP THE TRANSIT.**— In setting the transit over a point, place one leg of the tripod in nearly the right position on the ground, then grasp the other two and move the instrument in such a way as to bring the head over the point and at the same time keep the plates of the instrument **approximately level**, giving the tripod sufficient spread to insure steadiness. The tripod legs should be pressed firmly into the ground. The nuts at the top of the tripod legs should be tight enough so that the legs are just on the point of falling of their own weight when raised from the ground. If they are loose the instrument is not rigid; if they are too tight it is not in a stable condition and may shift at any moment.

If the point is on sloping ground it is often convenient, and usually insures greater stability, to set two legs on the downhill side and one leg uphill. When the center of the instrument is over the point but the tripod head is not nearly level it can be

leveled approximately without moving the instrument away from the point by moving one, sometimes two, of the tripod legs in an arc of a circle about the point. Nothing but practice will make one expert in setting up the transit.

It is desirable to bring the instrument very nearly level by means of the tripod; this is really a saving of time because under ordinary conditions it takes longer to level up by the leveling screws than by the tripod. It also saves time on the next set-up to have the leveling screws nearly in their mid position. If the transit is set by means of the tripod, say, within 0.01 or 0.02 ft. of the point, the exact position can be readily reached by means of the *shifting head*, which may be moved freely after any two adjacent leveling screws are loosened. When the transit has been brought directly over the point, the leveling screws should be brought back to a bearing. In the first (rough) setting the plumb-bob should hang, say, an inch above the point, but when the shifting head is used it should be lowered to within about $\frac{1}{4}$ inch or less of the point.

57. In leveling the instrument, first turn the plates so that each plate level is parallel to a pair of **opposite** leveling screws.

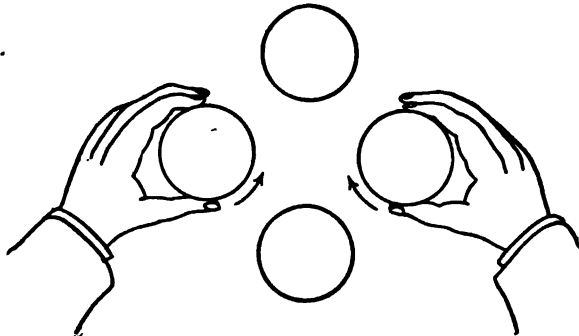

FIG. 28. CUT SHOWING HOW FINGERS MOVE IN LEVELING.

Each level is therefore controlled by the pair of leveling screws which is parallel to it. Great care should be used in leveling. The screws must not be loose as this will cause the plates to tip and perhaps to move horizontally which would change the position of the plumb-bob over the point. On the other hand they

must not be too tight as this will not only injure the instrument but will cause errors due to strains in the metal. To level the instrument, grasp one pair of opposite screws between the thumbs and forefingers and turn so that the thumbs move either **toward** each other or **away from** each other, as illustrated in Fig. 28. In this way one screw is tightened as much as the other is loosened. The motion of both screws must be uniform ; if they bind, the one which is being loosened should be turned faster. If this does not appear to remedy matters then the other pair of screws is binding and should be loosened slightly. Only experience will teach one to level an instrument quickly and correctly. It may be convenient for beginners to remember that in leveling the instrument the bubble will move in the same direction as the left thumb moves. After one bubble has been brought nearly to the center of its tube the other bubble is centered in a similar manner by its pair of leveling screws. Instead of trying to center one bubble **exactly** before beginning on the second one it is better to get both of them approximately level, after which first one bubble and then the other may be brought exactly to the center. After the instrument is leveled the plumb-bob should be examined to see that it has not been moved from over the point during the process of leveling.

58. TO MEASURE A HORIZONTAL ANGLE. — After setting the instrument up over the point, first set the zero of one of the verniers opposite the zero of the circle. This is done by turning the two plates until the two zeros are nearly opposite, clamping the plates firmly together with the **upper clamp**, and then bringing the two into exact coincidence by means of the tangent screw which goes with the **upper clamp**. If a line on the vernier is coincident with a line on the circle then the two adjacent lines on the vernier will fail to coincide with the corresponding lines on the circle by **equal amounts** (Art. 53, p. 39). Hence the coincidence of any line on the vernier with a line on the circle can be more accurately judged by examining also the adjacent divisions and noting that they are symmetrical with respect to the coincident lines. A pocket magnifier, or "reading glass," is generally used for setting and reading the vernier. **Never touch the clamp after a setting has been made by means of the**

tangent screw. In setting with the tangent screw it is better to do this by a **right-hand turn**, i.e., by turning the screw in the direction which **compresses** the spring against which it works. If the screw needs to be turned back, instead of turning it to the exact setting turn it back too far and then bring it up to the accurate setting with a right-hand motion, thereby insuring a firm bearing of the spring against the screw. The two plates which are now clamped in proper position are free to turn together about the vertical axis. Turn to the first object and point the telescope at it approximately by looking over the top of the telescope. When turning the instrument so as to sight the first point it is good practice to touch the lower plate only. Focus the telescope by moving the eyepiece until the cross-hairs are distinct and then moving the objective until the image is distinct. It is sometimes convenient to point the telescope at the object when focusing the cross-hairs so that they can be readily seen.* Test for parallax by moving the eye slightly from one side to the other. Move the telescope until the vertical cross-hair is very nearly on the point. It is better to use that part of the cross-hair which is near the center of the field of view. Clamp the lower plate by means of the **lower clamp**, and set exactly on the point by the **lower tangent screw**. The line of sight is now fixed on the first object. To measure the angle loosen the **upper clamp**, turn the telescope to the second point, and focus the objective if necessary. Set nearly on the point, clamp the **upper plate**, and set the vertical cross-hair exactly on the point by means of the **upper tangent screw**. The angle is then read **on the vernier which was set at 0°**.

The tangent screws should **not** be used to move the plates over large angles. Acquire the habit of setting closely by hand and using the tangent screw for slight motions only.

59. TO MEASURE AN ANGLE BY REPETITION.— The eyepiece magnifies the image so much that it is possible to set the cross-hair on a point much more closely than the vernier will

* If the eyepiece is focused on the cross-hairs with the telescope pointing at the sky, as is frequently done, they will be found to be approximately in focus when looking at the object; but for accurate work the eyepiece should be focused on the cross-hairs when the objective is in focus on the object.

read. The graduation of the circle is very accurate and can be depended upon closer than the vernier can be read, consequently the full value of the instrument is not utilized by single readings of an angle. To obtain the value of an angle more accurately proceed as follows. After the first angle has been measured leave the two plates clamped together, loosen the **lower clamp** and turn back to the first point. Set on the first point, using the **lower clamp** and its tangent screw. Then loosen the upper clamp and set on the second point, using the **upper clamp** and its tangent screw, thus adding another angle, equal to the first one, to the reading on the circle. Repeat this operation, say, six times. The total angle divided by six will give a more precise result than the first reading. Suppose that the angle is actually $18^{\circ} 12' 08''$; if a "one-minute" instrument is being used it is impossible to read the $08''$ on the vernier, so the reading will be $18^{\circ} 12'$. Each repetition will add $08''$ (nearly) and after the 6th repetition, the amount will be $48''$ which will be read as $1'$. After the 6th pointing the total angle will then be read $109^{\circ} 13'$ which divided by 6 gives $18^{\circ} 12' 10''$, a result in this case correct to the nearest $10''$. To eliminate errors in the adjustment of the transit the above process should be repeated with the instrument reversed and the mean of the two values used. (See Art. 79, p. 61.) It is customary to take only the 1st and 6th readings, but as a check against mistakes it is well for the beginner to examine the vernier reading after each repetition and see that $\frac{1}{2}$ the second reading, $\frac{1}{3}$ the third, etc., nearly equals the first reading.

Repetition has also the advantage of eliminating, to a great extent, errors of graduation. If an angle is about 60° and is repeated 6 times it will cover a whole circumference. If there are systematic errors in the graduations the result is nearly free from them. The effect of accidental, or irregular, errors of graduation is decreased in proportion to the number of repetitions. In the best modern instruments the errors of graduation seldom exceed a few seconds.

Little is gained by making a very large number of repetitions as there are systematic errors introduced by the action of the clamps, and the accuracy apparently gained is really lost on this

account. Three repetitions with the telescope normal and three with the telescope inverted are sufficient for anything but very exact work.

It is desirable that as little time as possible should elapse between pointings, as the instrument cannot be relied upon to remain perfectly still. As a matter of fact it is vibrating and "creeping" nearly all the time from numerous causes. For example, when the instrument is set up on frozen ground, it will quickly change its position on account of the unequal settlement of the tripod legs. Changes of temperature, causing expansion or contraction of the metal of the instrument, and the effect of wind introduce errors. The more rapidly the measurements can be made, consistent with careful manipulation, the better the results will be. If the transit is set up on shaky ground the transitman should avoid walking around his instrument.

60. Repetition is useful not only to secure precision, but also as a check against mistakes. If a mistake is made on the first reading of an angle the vernier, on the second reading, falls in a new place on the circle so that the mistake is not likely to be repeated. It is common practice to repeat, or "double," all important angles and divide the second reading by 2 simply as a check on the first reading.

61. **TO LAY OFF AN ANGLE BY REPETITION.** — There is no direct method of laying off an angle by repetition as in the case of measuring an angle, therefore the following indirect method is used. With the vernier set at 0° and the telescope sighted on the first point the angle is carefully laid off on the circle and the second point set in line with the new position of the telescope. Then this angle which has been laid off is **measured** by repetition as precisely as is desired as described in Art. 59. The resulting angle obtained by repetition is a more precise value than the angle first set on the vernier. The difference between this value and the angle desired is the correction which should be made at the second point. This can be readily done by measuring approximately the distance from the instrument to the second point, and computing the perpendicular offset to be laid off at the second point. (The offset for an angle of one minute at a distance of 100 ft. is nearly 0.03 ft.)

62. RUNNING A STRAIGHT LINE — One Point Visible from the Other. — There are several ways in which a straight line may be fixed on the ground, depending upon the existing conditions. If the line is fixed by the two end points one of which is visible from the other, the method of setting intermediate points would be to set the transit over one point, take a "fore-sight" on the other and place points in line. For very exact work the instrument should be used in both the direct and reversed positions (Art. 79, p. 61). This will eliminate errors of adjustment such as failure of the telescope to revolve in a true vertical plane, or failure of the objective tube to travel parallel to the line of sight.

63. RUNNING A STRAIGHT LINE — Neither Point Visible from the Other. — If neither point can be seen from the other then it is necessary to find some point, by trial, from which the terminal points can be seen. The transit is set up at some point estimated to be on the line, a "backsight" is taken on one of the points and the instrument clamped. The telescope is then reversed on its horizontal axis. If the vertical cross-hair strikes the second point the instrument is in line; if not, then the error in the position of the instrument must be estimated (or measured) and a second approximation made. In this way, by successive trials, the true point is attained. The final tests should be made with the instrument in direct and reversed positions to eliminate errors of adjustment of the line of sight and the horizontal axis. To eliminate errors in the adjustment of the plate bubbles the plate level which is perpendicular to the line should be leveled just before making the second backsight and while the telescope is pointing in that direction. This can be more readily done if, when the transit is set up, one pair of opposite leveling screws is turned so as to be in the direction of the line; then the other pair will control the level which is perpendicular to the line of sight. After one point has been found by this method other points may be set as described in the previous article.

Another method of running a line between two points one of which is not visible from the other would be to run what is called a *random line* as described in Art. 191, p. 169.

64. Prolonging a Straight Line. — If a line is fixed by two points A and B and it is desired to prolong this line in the direction AB , the instrument should be set up at A , a sight taken on B and other points set in line beyond B . When it is not possible to see beyond B from A , the transit should be set up at B and points ahead should be set by the method of backsighting and foresighting as follows. With the transit at B a backsight is taken on A and the instrument clamped. The telescope is inverted and a point set ahead in line. The process is repeated, the backsight being taken with the telescope in the inverted position. The mean of the two results is a point on the line AB produced. The transit is then moved to the new point, a backsight is taken on B , and another point set ahead as before.

In this last case, if a line is prolonged several times its own length by backsighting and foresighting, there is likely to be a constantly increasing error. In the first case, where the line is run continually toward a point known to be correct, the errors are not accumulating.

65. Methods of Showing Sights. — If the point sighted is within a few hundred feet of the instrument, a pencil may be used and held vertically in showing a point for the transitman to sight on. Sighting-rods are used on long distances.* Where only the top of the rod or pole is visible a considerable error is introduced if it is not held plumb. A plumb-line is much more accurate for such work but cannot be easily seen on long sights. Under conditions where the plumb-line cannot be readily seen some surveyors use for a sight an ordinary white card held with one edge against the string or held so that the center of the card is directly behind the string. If the edge of the card is held against the string, the transitman must be extremely careful that he is sighting on the proper edge.†

* It is desirable that the foresight should be of a color such that the cross-hair is clearly seen, and of a width such that the cross-hair nearly (but not quite) covers it.

† It is common among some surveyors to use a two-foot rule for a sight. The rule is opened so that it forms an inverted V (Δ). The plumb-string is jammed into the angle of the Δ by pressing the two arms of the rule together. The rule is then held so that the plumb-string as it hangs from the rule appears to bisect the angle of the Δ .

Another device is to attach to the plumb-line an ordinary fish-line float (shaped

Whenever the instrument is sighted along a line which is to be frequently used or along which the transit is to remain sighted for any considerable time the transitman should if possible select some well-defined point which is in the line of sight, called a "foresight." If no definite point can be found one may be placed in line for his use. By means of this "foresight" the transitman can detect if his instrument moves off the line, and can set the telescope exactly "on line" at any time without requiring the aid of another man to show him a point on the line.

66. Signals. — In surveying work the distances are frequently so great that it is necessary to use hand signals. The following are in common use.

"Right" or "Left." — The arm is extended in the direction of the motion desired, the right arm being used for a motion to the right and the left arm for a motion to the left. A slow motion is used to indicate a long distance and a quick motion a short distance.

"Plumb the Pole." — The hand is extended vertically above the head and moved slowly in the direction it is desired to have the pole plumbed.

"All Right." — Both arms are extended horizontally and moved vertically.

"Give a Foresight." — The transitman, desiring a foresight, motions to the rodman, by holding one arm vertically above his head.

"Take a Foresight." — The rodman desiring the transitman to sight on a point, motions the transitman by holding one arm vertically above his head and then he holds his lining-pole vertically on the point.

"Give Line." — When the rodman desires to be placed "on line" he holds his lining-pole horizontally with both hands over his head and then brings it down to the ground in a vertical position. If the point is to be set carefully, as a transit point,

like a plumb-bob). This may be fastened so that its axis coincides with the string and so that it can be raised and lowered on the string. It should be painted with such colors that it can be seen against any background.

The man showing the sight for the transitman should always try to stand so that the sun will shine on the object he is holding; on long sights it is difficult (sometimes impossible) to see an object in a shadow.

the rodman waves the top end of pole in a circle before bringing it to the vertical position.

"Pick up the Transit." — When the chief of the party desires to have the instrument set at another point he signals to the transitman by extending both arms downward and outward and then raising them quickly.

All signals should be distinct so as to leave no doubt as to their meaning. Care should be taken to stand so that the background will not prevent the signals being distinctly seen. The palms of the hands should be shown in making the signals, and for distant signals a white handkerchief is often used. Where much distant signaling is to be done flags are attached to the lining-poles. Special signals may be devised for different kinds of work and conditions.

67. TO MEASURE A VERTICAL ANGLE. — In measuring a vertical angle with a transit, first point the vertical cross-hair approximately at the object, then set the horizontal cross-hair exactly on the point by means of the clamp and tangent screw controlling the vertical motion. Next read the vertical arc or circle. Then, **without disturbing the rest of the transit**, unclamp the vertical arc, and bring the telescope to the horizontal position by means of the level attached to the telescope, and the clamp and tangent screw of the vertical arc. When the telescope bubble is in the center read the vertical arc again. This gives the *index correction*, to be added or subtracted according to whether the two readings are on opposite or on the same side of zero. In some forms of transit the vernier is on a separate arm which also carries a level. By bringing this level to the center of the tube by means of its tangent screw the index correction is reduced to zero each time and the true angle read directly. Instruments provided with this form of level have no level attached to the telescope.

If the transit has a complete vertical circle errors in the adjustment of the bubble and the horizontal cross-hair may be eliminated by inverting the telescope, turning it through 180° azimuth, and remeasuring the angle. The mean of the two results is free from such errors. If the transit is provided with only a portion of a circle the vernier will be off the arc when

the telescope is inverted, consequently with a transit of this type the elimination cannot be effected.

68. PRECAUTIONS IN THE USE OF THE TRANSIT.— In the preceding text several sources of error and also precautions against mistakes have been mentioned, but in order that the beginner may appreciate the importance of handling the instrument carefully he should make the following simple tests.

1. Set the transit up with the three points of the tripod rather near together so that the instrument will be high and unstable. Sight the cross-hair on some definite object, such as the tip of a church spire, so that the slightest motion can be seen. Take one tripod leg between the thumb and forefinger and twist it strongly; at the same time look through the telescope and observe the effect.

2. Press the tripod leg laterally and observe the effect on the level attached to the telescope; center the bubble before testing.

3. Step on the ground about 1 or 2 inches from the foot of one of the tripod legs and observe the effect on the line of sight.

4. Breathe on one end of the level vial and observe the motion of the bubble.

5. Press laterally on the eyepiece and observe the effect on the line of sight.

These motions, plainly seen in such tests, are really going on all the time, even if they are not readily apparent to the observer, and show the necessity for careful and skillful manipulation. The overcoat dragging over the tripod, or a hand carelessly resting on the tripod, are common sources of error in transit work.

Before picking up the transit center the movable head bring, the leveling screws back to their mid position, loosen the lower clamp, and turn the telescope either up or down.

ADJUSTMENTS OF THE TRANSIT.

69. If an instrument is badly out of adjustment in all respects, it is better not to try to completely adjust one part at a time but to bring the instrument as a whole gradually into adjustment. If this is done, any one process of adjusting will not disturb the preceding adjustments, the parts are not subjected to strains, and the instrument will be found to remain in adjustment much longer than it would if each adjustment were completed separately.

Nearly all adjustments of the transit, in fact of nearly all surveying instruments, are made to depend on the principle of *reversion*. By reversing the position of the instrument the effect of an error is doubled.

70. ADJUSTMENT OF THE PLATE BUBBLES. — To adjust the Plate Levels so that Each lies in a Plane Perpendicular to the Vertical Axis of the Instrument. Set up the transit and bring

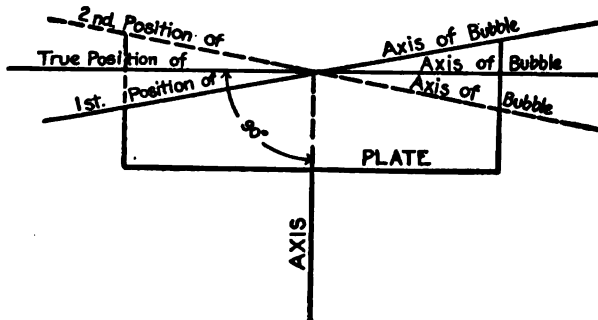

FIG. 29. ADJUSTMENT OF THE PLATE BUBBLES.

the bubbles to the center of their respective tubes. Turn the plate 180° about its vertical axis and see if the bubbles remain in the center. If they move from the center, half this distance is the error in the adjustment of the tube. (See Fig. 29.) The adjustment is made by turning the capstan-headed screws on the

bubble tube until the bubble moves half-way back to the center as nearly as this can be estimated. Each bubble must be adjusted independently. The adjustment should be tested again by releveling and reversing as before, and the process continued until the bubbles remain in the center when reversed. When both levels are adjusted the bubbles should remain in the centers during an entire revolution about the vertical axis.

71. ADJUSTMENT OF THE CROSS-HAIRS. — 1st. To put the **Vertical Cross-Hair in a Plane Perpendicular to the Horizontal Axis.** Sight the vertical hair on some well-defined point, and, leaving both plates clamped, rotate the telescope slightly about the horizontal axis (see Fig. 30).

The point should appear to travel on the vertical cross-hair throughout its entire length. If it does not, loosen the screws

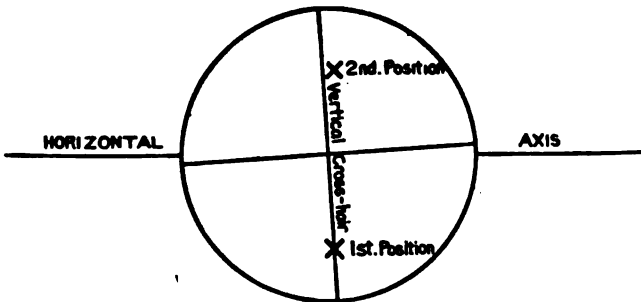

FIG. 30. ADJUSTMENT OF THE CROSS-HAIRS (FIRST PART).

holding the cross-hair ring, and by tapping lightly on one of the screws, rotate the ring until the above condition is satisfied. Tighten the screws and proceed with the next adjustment.

72. 2nd. To make the Line of Sight Perpendicular to the Horizontal Axis.* (See Fig. 31.) Set the transit over a point

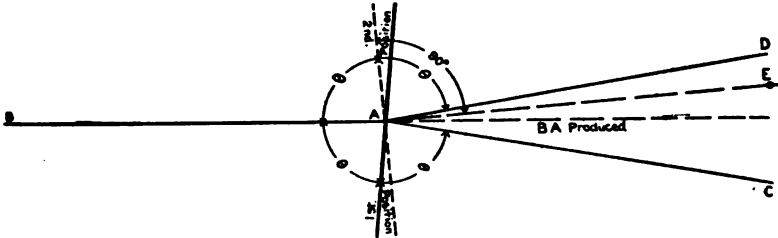

FIG. 81. ADJUSTMENT OF THE CROSS-HAIRS (SECOND PART).

A. Level up, clamp both plates, and sight accurately on a point *B* which is approximately at the same level as *A*. Reverse the telescope and set *C* in line with the vertical cross-hair. *B*, *A*, and *C* should be in a straight line. To test this, turn the instrument about the vertical axis until *B* is again sighted. Clamp the plate, reverse the telescope, and observe if point *C* is in line. If not, set point *D* in line just to one side of *C* and then the cross-hair ring must be moved until the vertical hair appears to have moved to point *E*, one-fourth the distance from *D* toward *C*, since, in this case, a **double reversal** has been made.

The cross-hair ring is moved by loosening the screw on one side of the telescope tube and tightening the opposite screw. If *D* falls to the right of *C* then the cross-hair ring should be moved to the left; but if the transit has an erecting eyepiece the cross-hair will appear to move to the right when viewed through the telescope. If the transit has an inverting eyepiece the cross-hair appears to move in the same direction in which the cross-hair is actually moved.

The process of reversal should be repeated until no further adjustment is required. When finally adjusted, the screws should hold the ring firmly but without straining it.

* In making the adjustment in the shop with collimators instrument makers seldom level the transit carefully. In field adjustments it is desirable, although not necessary, to level the instrument. The essential condition is that the vertical axis shall not alter its position.

73. ADJUSTMENT OF THE STANDARDS. — To make the Horizontal Axis of the Telescope Perpendicular to the Vertical Axis of the Instrument. (See Fig. 32.) Set up the transit and sight the vertical cross-hair on a high point *A*, such as the top of a church steeple. Lower the telescope and set a point *B* in line, on the same level as the telescope. Reverse the telescope, turn the instrument about its vertical axis, and sight on *B*. Raise the telescope until the point *A* is visible and see if the cross-hair comes on *A*. If not, note point *C* in line and at same height as *A*. Then half the distance from *C* to *A* is the error of adjustment. Loosen the screws in the pivot cap and raise or lower the adjustable end of the horizontal axis by means of the capstan-headed screw under the end of the axis. Repeat the test until the high and the low points are both on the cross-hair in either the direct or reversed positions of the transit. The adjusting screw should be brought into position by a right-hand turn, otherwise the block on which the horizontal axis rests may stick and not follow the screw. The cap screws should then be tightened just enough to avoid looseness of the bearing.

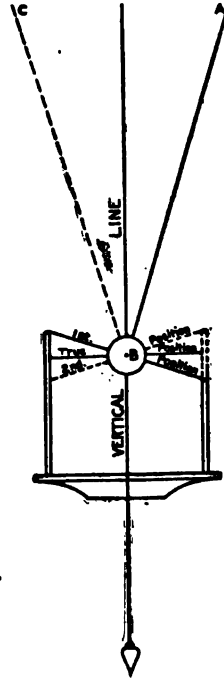

FIG. 32. ADJUSTMENT OF THE STANDARDS.

74. Adjustment of the Telescope Bubble. — This is adjusted by the "peg" method, or *direct method*, as explained in Art. 128, p. 91. This consists in first determining a level line by using the instrument in such a way as to eliminate the error of the bubble, and then centering the bubble while the line of sight is horizontal.

75. Adjustment of the Auxiliary Level on the Vernier of the Vertical Arc. — (See Art. 67, p. 54.) To adjust the Level so that it is in the Center of the Tube when the Line of Sight is Level and the Vernier reads 0° . This is adjusted by the "peg

method" (Art. 128, p. 91). The bubble is first brought to the center of the tube by means of its tangent screw. Then the telescope is moved until the vernier of the vertical arc reads 0° . The instrument is then in condition to be used as a leveling instrument and is adjusted by the "peg method."

If the telescope is provided with an attached level the auxiliary level could be adjusted by comparing it with the telescope level as follows. Level the telescope by means of its attached level, make the vernier read 0 by means of the tangent screw of the vernier, and then bring the bubble of the auxiliary level to the center by means of its adjusting screws.

76. Adjustment of the Vernier of the Vertical Circle.—To make the Vernier read 0° when the Telescope Bubble is in the Center of the Tube. If there is any index error (Art. 67, p. 54) bring the bubble to the center, loosen the screws holding the vernier, and tap lightly until the zeros coincide. Tighten the screws and test again. In some instruments the vernier is controlled by a slow-motion screw for setting the index at the zero of the circle.

77. Adjustment of the Objective Slide.—To make the Objective Slide move Parallel to the Line of Sight. If the tube holding the objective is adjustable it must be placed so that the direction of the line of sight will not be disturbed when the telescope is focused. The adjustment may be made as follows. Adjust the line of sight as in Art. 72, using very distant points. This will require the objective to be drawn in nearly as far as it will go and hence the position of the objective will be changed but little by any subsequent lateral adjustment of the tube. Next repeat the test for the adjustment of the line of sight by using two points which are very near the instrument. In sighting on these points the objective must be run out and any error in its adjustment will change the direction of the line of sight so that it is no longer perpendicular to the horizontal axis of the instrument. In case the instrument fails to stand this test the objective slide does not move parallel to the line of sight. The adjustment is made by moving the adjustment screws of the objective slide so as to apparently increase the error making, by estimation, one-quarter the correction required.

The adjustment of the line of sight should be again tested on two distant points and the cross-hairs moved in case the second adjustment appears to have disturbed the first.

78. SHOP ADJUSTMENTS. — The adjustment of the objective slide and other adjustments such as centering the eyepiece tube and centering the circles are usually made by the instrument maker.

79. HOW TO ELIMINATE THE EFFECT OF ERRORS OF ADJUSTMENT IN THE TRANSIT. — Errors of adjustment in the plate bubble may be avoided by leveling up and reversing as when adjusting. Then, instead of altering the adjustment, simply move the bubble half-way back by means of the **leveling screws**. This makes the vertical axis truly vertical. Then the bubbles should remain in the same parts of their respective tubes as the instrument revolves about its vertical axis.

Errors of the line of sight and errors of the horizontal axis are eliminated by using the instrument with the telescope in the direct and then in the reversed position and taking the mean of the results whether the work is measuring angles or running straight lines.

Errors of eccentricity of the circle are completely eliminated by reading the two opposite verniers and taking the mean.

Errors of graduation of the circle are nearly eliminated by reading the angle in different parts of the circle or by measuring the angle by repetition.

80. Care of Instruments. — A delicate instrument like the transit requires constant care in order that the various parts may not become loose or strained. Care should be taken that the tripod legs do not move too freely, and that the metal shoes on the feet of the tripod do not become loose. The transit should be securely screwed to the tripod. In caring for the lenses a camel's hair brush should be used for dusting them and soft linen with alcohol for cleaning them. The objective should not be unscrewed except when absolutely necessary, and when replaced it should be screwed in to the reference mark on the barrel of the telescope. Grease should never be used on exposed parts of an instrument, as it collects dust. Care should be taken not to strain the adjusting screws in making adjustments.

The instrument should be protected as much as possible from the sun, rain, and dust. If the instrument is carried in the box it is less likely to get out of adjustment than when carried on the shoulder, but the former is often inconvenient. It is customary in traveling by carriage or rail to carry the transit in its box. While being carried on the shoulder the lower clamp should be left unclamped so that in case the instrument strikes against anything, some parts can give easily and save the instrument from a severe shock. When the transit is in use, be careful not to clamp it too hard, but clamp it firmly enough to insure a positive working of the tangent screws and so that no slipping can occur.

81. COMMON SOURCES OF ERROR IN TRANSIT WORK. —

1. Nonadjustment, eccentricity of circle, and errors of graduation.
2. Changes due to temperature and wind.
3. Uneven settling of tripod.
4. Poor focusing (parallax).
5. Inaccurate setting over point.
6. Irregular refraction of atmosphere.

82. COMMON MISTAKES IN TRANSIT WORK. —

1. Reading in the wrong direction from the index on a double vernier.
2. Reading the opposite vernier from the one which was set.
3. Reading the circle wrong, e.g., reading 59° for 61° . If the angle is nearly 90° , reading the wrong side of the 90 point, e.g., 88° for 92° .
4. Using the wrong tangent screw.





FIG. 83. SOLAR ATTACHMENT TO TRANSIT.

(The authors are indebted to C. L. Berger & Son for the photograph from which this cut was made.)

THE SOLAR ATTACHMENT.

83. DESCRIPTION OF SOLAR ATTACHMENT. — One of the most important auxiliaries to the engineer's transit is the solar attachment, one form of which is shown in Fig. 33. This is a small instrument which may be attached to the telescope and by means of which a true meridian line can be found by an observation on the sun. In the form here shown the principal parts are the *polar axis*, which is attached to the telescope perpendicular to the line of sight and to the horizontal axis, and a small telescope which is mounted on the polar axis. This telescope can be revolved about the polar axis and can be inclined to it at any desired angle. The polar axis is provided with four adjusting screws for making it perpendicular to the line of sight and to the horizontal axis.

Another form of attachment has the solar telescope replaced by a lens and a screen on which the sun's image can be thrown. This defines a line of sight and is in reality the equivalent of a telescope. This instrument is provided with the arc of a circle known as the *declination arc*, the use of which will be explained later.

Still another form consists of a combination of mirrors (similar to those of a sextant) which can be placed in front of the objective. In this form the telescope of the transit serves as the polar axis.

While these various solar attachments differ in the details of construction, they all depend upon the same general principles.

84. THE CELESTIAL SPHERE. — In order to understand the theory of this instrument it will be necessary to define a few astronomical terms. Fig. 34 represents that half of the celestial sphere which is visible at one time to an observer on the surface of the earth. For the purposes of this problem the celestial sphere may be regarded as one having its center at the center of the earth and a radius equal to the distance of the sun from the earth. The sun in its apparent daily motion would then move around in a circle on the surface of this

sphere. The circle $NESW$ is the observer's *horizon* and is the boundary between the visible and invisible parts of the celestial sphere. The point Z is the *zenith* and is the point where a plumb-line produced would pierce the celestial sphere. The circle $SZPN$ is the observer's *meridian* and is a vertical circle through the pole. The circle EQW is the *celestial equator*. The circle AMB , parallel to the equator, is a *parallel of declination*, or the path described by the sun in its apparent daily

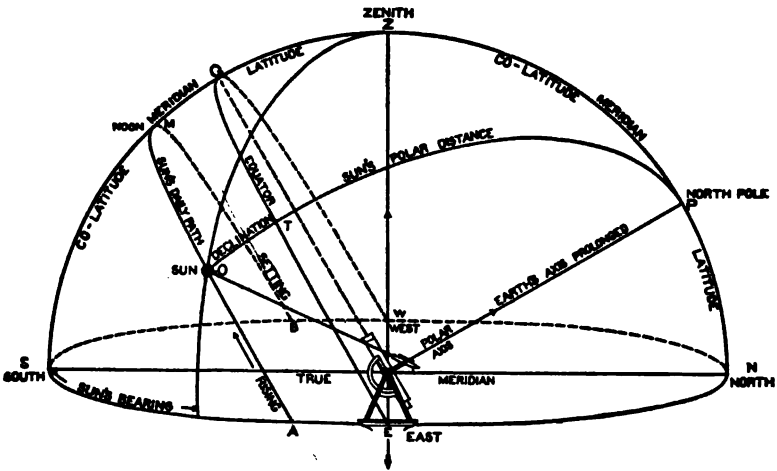

FIG. 34. DIAGRAM OF THE CELESTIAL HEMISPHERE.

motion from east to west. The *sun's declination* is its angular distance from the equator, or the arc OT . The declination is considered **positive** when north and **negative** when south. The *polar distance* of the sun is the complement of the declination represented by the arc OP .

85. OBSERVATION ON THE SUN FOR MERIDIAN WITH SOLAR ATTACHMENT. — If the polar axis of the instrument is made to point to the celestial pole, i.e., made parallel to the earth's axis, then the small telescope can be made to follow the sun in its daily path by simply giving it an inclination to the polar axis equal to the sun's polar distance and revolving it about the polar axis.

(1) To find the true meridian by an observation on the sun first make the angle between the polar axis and the solar telescope equal to the sun's polar distance at the time of the observation. This is done by turning the solar telescope into the same plane as the main telescope by sighting both on some distant object, and then making the angle between the two telescopes equal to the sun's declination. Some instruments are provided with a *declination arc* upon which the declination angle can be laid off directly. Others have a small spirit level attached to the small telescope, in which case the vertical circle of the transit is used for laying off the declination angle. Incline the main telescope until the reading of the vertical circle equals the declination, and clamp; then level the solar telescope by means of the attached level. The angle between the polar axis and the solar telescope is then 90° plus or minus the reading of the vertical circle.

(2) By means of the vertical circle of the transit incline the polar axis to the vertical by an angle equal to the **co-latitude of the place**, which is 90° minus the latitude. The polar axis now has the same angle of the elevation as the celestial pole.

(3) If the observation is in the forenoon, place the solar telescope on the left of the main telescope (on the right if in the afternoon); then, by moving the whole instrument about the vertical axis and the solar telescope about the polar axis, point the solar telescope at the sun. The sun's image is brought to the center of the square formed by four cross-hairs, or ruled lines, in the solar telescope. The final setting is made by the tangent screw controlling the horizontal motion of the transit and the one controlling the motion of the solar about the polar axis. **Only one position can be found where the solar telescope will point to the sun.** In this position the vertical axis points to the zenith, the polar axis to the pole, and the solar telescope to the sun. The instrument has thus solved mechanically the spherical triangle having these three points (Z, P, O) as vertices. The horizontal angle between the two telescopes is equal to the sun's true bearing. Since the solar telescope is pointing to the sun the main telescope must be in the plane of the meridian. If all of the work has been correctly done it will be observed

that the sun's image will remain between the cross-hairs set parallel to the equator, and therefore the sun can be followed in its path by a motion of the solar telescope alone. If it is necessary to move the instrument about the vertical axis to point the solar telescope again at the sun this shows that the main telescope was not truly in the meridian.

After the meridian has been determined the main telescope may then be lowered and a point set which will be due north or due south of the instrument.

86. Computation of Declination Settings.—The sun's polar distance may be obtained from the "American Ephemeris and Nautical Almanac," published by the Government. The polar distance is not given directly, but its complement, the *sun's apparent declination*, is given for each day and for the instant of *Greenwich Mean Noon*. The rate of change of the declination, or the *difference for 1 hour*, is also given. In order to use this for any given locality, it is first necessary to find the local or the standard time corresponding to mean noon of Greenwich. In the United States, where standard time is used, the relation to Greenwich time is very simple. In the *Eastern* time belt the time is exactly 5 hours earlier than at Greenwich; in the *Central*, 6 hours earlier; in the *Mountain*, 7 hours earlier; in the *Pacific*, 8 hours earlier. If a certain declination corresponds to Greenwich mean noon, then the same declination corresponds to 7 A.M. in the Eastern belt or 6 A.M. in the Central belt, etc. The declination for any subsequent hour of the day may be found by adding (algebraically) the difference for 1 hour multiplied by the number of hours elapsed. Declinations marked *North* must be regarded as *positive* and those marked *South* as *negative*. An examination of the values of the declination for successive days will show which way the correction is to be applied. It will be useful also to remember that the declination is 0° about March 21, and increases until about June 22, when it is approximately $23^\circ 27'$ North; it then decreases, passing the 0° point about September 22, until about December 21 when it is approximately $23^\circ 27'$ South; it then goes North until March 21 when it is 0° again.

After the correct declination is found it has still to be cor-

rected for refraction of the atmosphere. The effect of refraction is to make the sun appear higher up in the sky than it actually is. In the northern hemisphere, when the declination is North this correction must be added, when South, subtracted; or algebraically it is always added.

The refraction correction may be taken from Table VII, p. 507.

The co-latitude which must be set off on the vertical circle may be obtained from a map or may be determined by an observation which is made as follows. Set off the sun's declination for noon, as for any other observation, the two telescopes being in the same vertical plane, and point the small telescope at the sun. By varying the angle of elevation of the main telescope, keep the solar telescope pointing at the sun until the maximum altitude is reached. The angle read on the vertical circle is the co-latitude (see also Art. 217, p. 195).

EXAMPLE.

Latitude 40° N.	Longitude 4h 45m W.
	Jan. 10, 1900.
Declination for Greenwich mean noon	21° 59' 04"
Difference for 1h	+ 22".25

TIME.	DECLINATION.	REFRACTION.	SETTING.
7 h. A.M.	21° 59' 04"		
8	58 42	5' 40"	21° 53' 02"
9	58 20	2 51	21 55 29
10	57 57	2 07	21 55 50
11	57 35	1 51	21 55 44
12 M.	57 13	(1 47)	(21 55 26)
1 P.M.	56 51	1 51	21 55 00
2	56 28	2 07	21 54 21
3	56 06	2 51	21 53 15
4	55 44	5 40	21 50 04

87. * Comstock's Method of finding the Refraction. — Set the vertical cross-hair on one edge (or *limb*) of the sun and note the instant by a watch. Set the vernier of the plate 10' ahead and note the time when the limb again touches the cross-hair.

* See Bulletin of the University of Wisconsin, Science Series, Vol. I, No. 3.

Call the number of seconds between these observations n . Read the altitude h . Then the refraction in minutes will be nearly equal to $\frac{2000}{hn}$.

88. Observation for meridian should not be made when the sun's altitude is less than about 10° , because the refraction correction will be unreliable. Observations near noon are to be avoided because a slight error in altitude produces a large error in the resulting meridian. For good results therefore the observation should be made neither within an hour of noon nor near sunrise or sunset.

89. MISTAKES IN USING THE SOLAR ATTACHMENT. —

1. Solar on wrong side of main telescope.
2. Refraction correction applied wrong way.

ADJUSTMENTS OF THE SOLAR ATTACHMENT.

90. **ADJUSTMENT OF POLAR AXIS. —**To make the Polar Axis Perpendicular to the Plane of the Line of Sight and the Horizontal Axis. Level the transit and the main telescope. Bring the bubble of the solar telescope to the center of its tube while it is parallel to a pair of opposite adjusting screws which are at the foot of the polar axis. Reverse the solar telescope 180° about the polar axis. If the bubble moves from the center position, bring it half-way back by means of the adjusting screws just mentioned and the other half by means of the tangent screw controlling the vertical motion of the solar. This should be done over each pair of opposite adjusting screws and repeated until the bubble remains central in all positions.

91. **ADJUSTMENT OF THE CROSS-HAIRS. —**To make the Vertical Cross-Hair truly Vertical. Sight on some distant point with all the clamps tightened and, by means of the tangent screw controlling the vertical motion of the solar, revolve the solar telescope about its horizontal axis and see if the vertical cross-hair remains on the point. If not, adjust by rotating the cross-hair ring, as described in Art. 71, p. 57.

92. ADJUSTMENT OF TELESCOPE BUBBLE. — To make the Axis of the Bubble Parallel to the Line of Sight. Level the main telescope and mark a point about 200 ft. from the instrument in line with the horizontal cross-hair. Measure the distance between the two telescopes and lay this off above the first point which will give a point on a level with the center of the solar telescope. Sight the solar at this point and clamp. Bring the bubble to the center by means of the adjusting screws on the bubble tube.

PROBLEMS.

1. Is it necessary that the adjustments of the transit should be made in the order given in this chapter? Give your reasons.

2. A transit is sighting toward B from a point A . In setting up the transit at A it was carelessly set 0.01 ft. directly to one side of A , as at A' . What would be the resulting error, i.e., the difference in direction (in seconds) between AB and $A'B$, (1) when $AB = 40$ ft., (2) when $AB = 1000$ ft.?

3. An angle of 90° is laid off with a "one minute" transit, and the angle then determined by six repetitions, the final reading being $179^\circ 58' + 360''$. The point sighted is 185 feet from the transit. Compute the offset to be laid off in order to correct the first angle. Express the result in feet and also in inches.

4. An angle measured with a transit is $10^\circ 15' 41''$. The telescope of a leveling instrument is placed in front of the transit (with its objective toward the transit) and the angle again measured and found to be $0^\circ 18' 22''$. What is the magnifying power of this level telescope?

5. Compute the declination setting for every hour when observations on the sun for meridian can be made at Boston (Lat. $42^\circ 21' N$, Long. $71^\circ 04' 30'' W$) on each of the following dates.

January 1, 1906.

Decl. S $23^\circ 03' 27''.9$

Diff. for 1 hour, $+ 11''.70$

April 16, 1906.

Decl. N $9^\circ 53' 34''.2$

Diff. for 1 hour, $+ 53''.44$

July 2, 1906.

Decl. N $23^\circ 05' 49''.5$

Diff. for 1 hour, $- 10''.39$

Sept. 25, 1906.

Decl. S $0^\circ 35' 49''.4$

Diff. for 1 hour, $- 58''.51$

CHAPTER IV.

MEASUREMENT OF DIFFERENCE OF ELEVATION.

93. **LEVEL SURFACE.** — A level surface is a curved surface which at every point is perpendicular to the direction of gravity at that point, such, for example, as the surface of still water. Any line of sight which is perpendicular to the direction of gravity at a given point is therefore tangent to the level surface at that point and is called a *horizontal line*.

94. **The Spirit Level.** — In nearly all instruments the direction of gravity is determined by means of either a plumb-line or a spirit level. A spirit level is a glass tube, the inside of which is ground to a circular curve longitudinally, and nearly filled with a liquid such as alcohol or ether, leaving enough space to form a bubble. The grinding is usually done only on the inside upper surface of the tube. The radius of the curve varies according to the use which is to be made of the level; a very short radius makes a slow moving bubble while a long radius makes a very sensitive bubble. It is important that the curve should be exactly circular so that equal distances on the tube should subtend equal angles at the center. The level is provided with a scale of equal parts, which may be either a metallic scale screwed to the brass case holding the glass bubble tube, or it may consist of lines etched on the glass itself. A point near the middle of the tube is selected as the *zero point* and the graduations are numbered both ways from that point. The straight line tangent to the curve at the zero point of the scale is called the *axis of the bubble*. The position of the bubble in the tube is determined by noting the positions of both ends. The bubble will change its length with changes in temperature, consequently the reading of one end is not sufficient to determine the position of the bubble. On account of the action of gravity the bubble will always move toward the higher end of the tube; hence, when the bubble is central the axis of the tube is horizontal.

95. Angular Value of One Division of the Level Tube. — The angular value of one division of a level tube is the angle, usually expressed in seconds, through which the axis of the tube must be tilted to cause the bubble to move over the length of one division on the scale. The simplest way of finding this in the field consists in moving the bubble over several divisions on the scale by means of the leveling screws and observing the space on a rod passed over by the horizontal cross-hair, the rod being placed at a known distance from the instrument. The space on the rod divided by the distance to the rod gives the natural tangent of the angle through which the line of sight has moved. Since the angle is very small its value in seconds of arc may be obtained by dividing its tangent by the tangent of one second, ($\log \tan 1'' = 4.6855749 - 10$). Dividing the angle found by the number of divisions of the scale passed over on the bubble tube, gives a result which is the average number of seconds corresponding to a single division.

In a properly constructed leveling instrument the value of one division of the level should have a definite relation to the magnifying power of the telescope. The smallest angular movement that can be detected by the level bubble should correspond to the smallest movement of the cross-hairs that can be detected by means of the telescope.

THE LEVEL.

96. The instruments chiefly used for the direct determination of differences of elevation are known as the *Wye Level*, the *Dumpy Level*, and the *Hand Level*. The *Precise Level* differs in its details from the others but does not really constitute a different type; it is essentially a wye level or a dumpy level, according to the principle of its construction. The engineer's transit, which has the long level attached to the telescope, is frequently used for direct leveling. All of these instruments are so constructed that the line of sight is horizontal when the bubble of the attached spirit level is in the middle of its tube.

97. THE WYE LEVEL. — In the wye level (Figs. 35 and 36) the spirit level is attached to the telescope tube which rests in

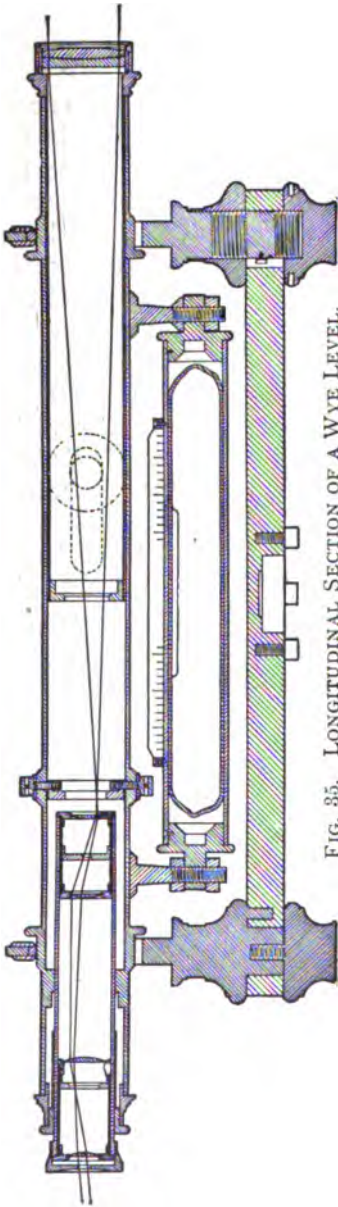

FIG. 85. LONGITUDINAL SECTION OF A WYE LEVEL.

two Y shaped bearings from which it derives its name. Those parts of the telescope which bear on the wyes are made cylindrical and are called *rings* or *pivots*. The telescope is held in the wyes by means of two *clips*. The level is attached to the telescope by means of screws which allow vertical and lateral adjustments. The two wye supports are secured, by means of adjusting screws, to a horizontal bar which is attached rigidly at right angles to a spindle, or vertical axis, similar to that of a transit. The instrument is provided with leveling screws, clamp, and tangent screw, but has no shifting head nor plumb-line attachment. The whole upper portion of the instrument is screwed to a tripod in the same manner as a transit. The characteristic feature of the wye level is that the telescope can be lifted out of its supports, turned end for end and replaced, each ring then resting in the opposite wye.

98. THE DUMPY LEVEL. —

In the dumpy level (Fig. 37) the telescope, the vertical supports, the horizontal bar and the vertical spindle are all made in one casting or else the parts are fastened together rigidly so as to be essentially one piece. The

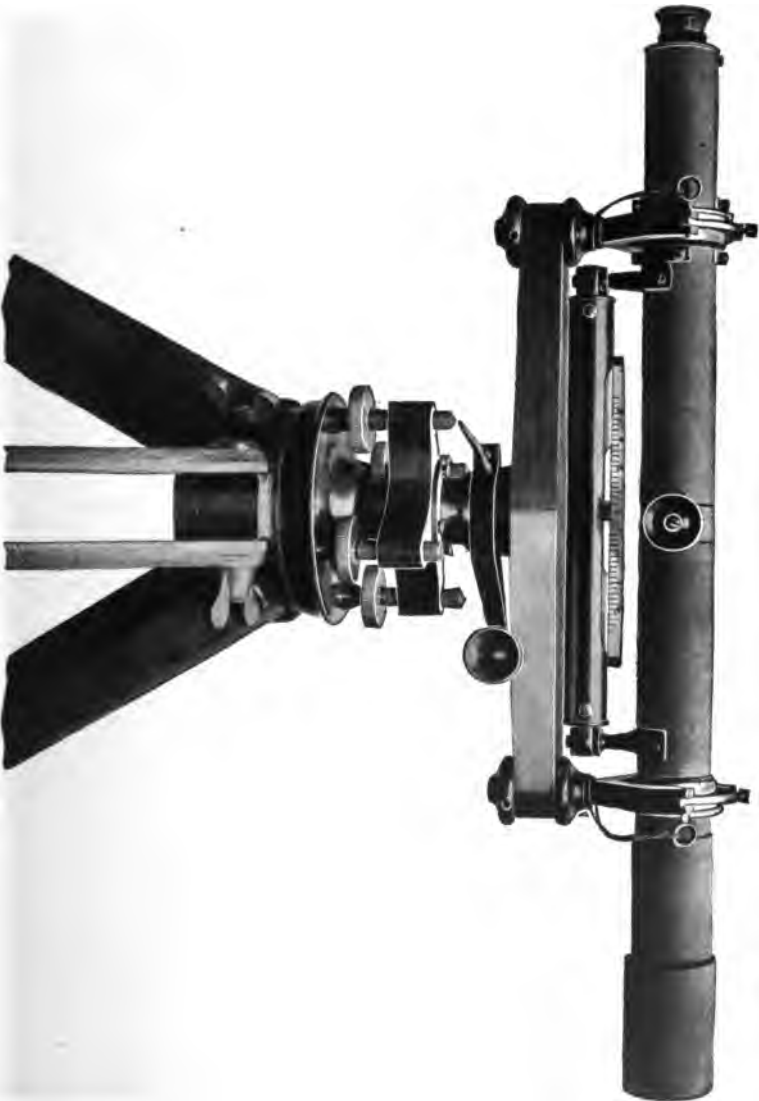

FIG. 86. THE WYE LEVEL.

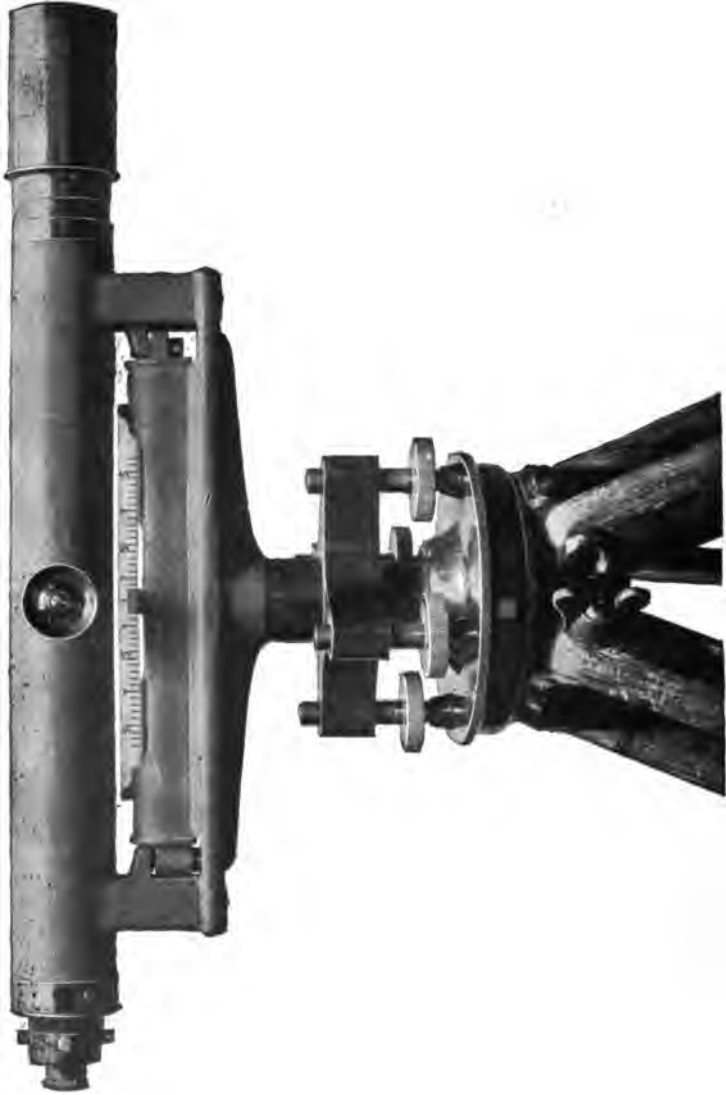

FIG. 37. THE DUMPY LEVEL.

spirit level is fastened to the horizontal bar and can be adjusted in the vertical plane; there is no other adjustable part except the cross-hair ring.

99. Comparison of Wye and Dumpy Levels. — The wye level has long been a favorite in this country, chiefly on account of the ease with which it can be adjusted, which depends upon the fact that when the telescope is reversed in the wye supports the line through the centers of the pivots is exactly coincident with its first position. While this feature of the wye level is of practical advantage in adjusting the instrument it is based on the assumption that both pivots are **circular** and of **exactly the same diameter**, which may or may not be true. For, even supposing the pivots to be perfect when new, they soon wear, and perhaps unevenly, and consequently the method of adjusting by reversal will then fail and the "*peg*" *adjustment*, or *direct* method, must be used. (See Art. 128, p. 91.) It is not uncommon to find a wye level of excellent manufacture which, after being adjusted by reversals, fails to stand the test by the direct method, but which is capable of excellent work when adjusted by the latter method.

The dumpy level has very few movable parts, and consequently it does not easily get out of adjustment even when subjected to rough usage.* Furthermore the recent work of the United States Coast and Geodetic Survey with a new precise level, which is really a dumpy level with certain refinements, indicates the superiority of the dumpy form for the most precise work.



FIG. 38. THE LOCKE HAND LEVEL.

100. THE LOCKE HAND LEVEL. — The hand level (Fig. 38) has no telescope, but is simply a metal tube with plain glass

* See Reports of the Superintendent of the U. S. Coast and Geodetic Survey for the year 1898-99, p. 351, and the year 1900, p. 525.

covers at the ends and with a spirit level on top. When looking through the tube one sees the level bubble on one side of the tube in a mirror set at 45° with the line of sight, and the landscape on the other side. In order that the eye may see the bubble and the distant object at the same instant the instrument is focused on the bubble by means of a lens placed in a sliding tube. The level line is marked by a horizontal wire, which can be adjusted by means of two screws. The instrument is held at the eye and the farther end is raised or lowered until the bubble is in the center of the tube. At this instant a point in line with the horizontal wire is noted. In this way approximate levels may be obtained.

LEVELING RODS.

101. According to their construction rods are either *Self-reading* or *Target* rods, or a combination of the two. Self-reading rods are those which can be read directly from the instrument by the levelman whereas target rods can be read only by the rodman. The commonest forms of leveling rods are known as the *Boston*, the *New York*, and the *Philadelphia* rods. (See Fig. 39.)

102. **BOSTON ROD.** — The Boston rod (Fig. 39) is a target rod of well seasoned wood about $6\frac{1}{2}$ ft. long, made in two strips, one of which slides in a groove in the other. A target is fastened rigidly to one of these strips about 0.3 ft. from one end. Clamps are provided for holding the two parts in any desired position. There is a scale on each side of the rod, one starting from either end, graduated to hundredths of a foot and each with a vernier placed about the height of the eye and reading to thousandths of a foot. When the rod-reading is less than 5.8 ft. the rod is first placed on the ground with the target near the bottom. Then the strip carrying the target is raised to the proper height while the bottom of the other strip rests on the ground, as shown in Fig. 39. For readings over 5.8 ft. the rod is turned end for end so that the target is at the top and can be moved from 5.8 to 11.4 ft., the limit of the rod. The terms



Tape Rod.



Self-Reading Rod.

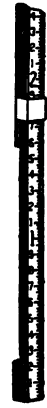

Philadelphia Rod.



New York Rod.



Boston Rod.

FIG. 89. LEVELING RODS.

"*short rod*" and "*long rod*" are used to distinguish these two positions.

The common form of target used on the Boston rod is shown in Fig. 40. Instead of this target one of a design similar to that in Fig. 41 is sometimes used, in which the white strip in the center may be bisected by the horizontal cross-hair. Bisection is more precise under all conditions than setting on a

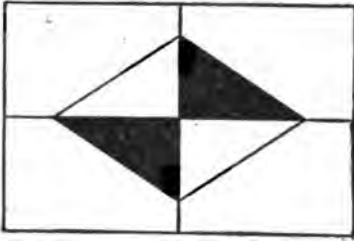

FIG. 40. BOSTON ROD TARGET.

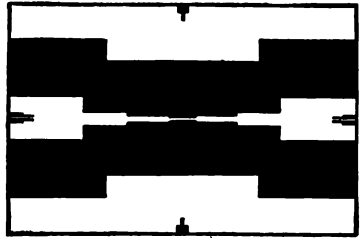

FIG. 41. BISECTION TARGET.

single line or on the division line between two surfaces of different color.

A serious objection to the Boston rod is that in reversing it (changing from long to short rod) any error in the position of the target with reference to the scale is doubled by the reversal, and such an error is not readily eliminated.

103. NEW YORK ROD.—The New York rod (Fig. 39) consists of two strips of wood, arranged similarly to those of the Boston rod. Unlike the latter the target on the New York rod is **movable**. For "*short rod*" the target is moved up or down on the rod until the proper height is reached. The face of the rod is graduated to hundredths of a foot. The vernier is on the target itself and reads to thousandths of a foot. The graduations on the rod cannot be read from the instrument except at short distances. For "*long rod*" the target is set at the highest graduation, usually 6.5 ft., and clamped to one of the sliding strips which is then raised until the target is in the right position. A clamp is provided for holding the two strips together. The reading for "*long rod*" is found on the side of the strip that is raised, and opposite the vernier which is on the

other strip, the scale reading downward. In this case the rod cannot be read directly from the instrument.

104. PHILADELPHIA ROD. — This rod has the graduations plainly painted on its face so that it can be used as a self-reading rod (Fig. 39). It has also a target the arrangement of which is similar to that of the New York rod. The target has no vernier but is graduated directly to 0.005 ft.; the thousandths can be readily estimated. The rod is extended in the same manner as the New York rod, and it can be read to 0.005 ft. and estimated to 0.001 ft. by means of a scale fastened on the back of the rod. When the rod is fully extended, the graduations on the front face are continuous and the readings can be made directly by the levelman if desired.

105. SPECIAL SELF-READING RODS. — There are a large number of self-reading rods of special design. One of the commonest types shown in Fig. 39, is similar to the Philadelphia rod except that it has no target and is not graduated closer than tenths. The figures on the face of the rod are made of definite height (0.06 or 0.08 ft.) and of definite thickness (0.01 or 0.02 ft.) so that it is easy for the levelman to estimate the readings to hundredths of a foot. These rods are usually constructed so that they can be extended for "long rod" readings.

106. Tape Rod.* — The tape rod (Fig. 39) is a self-reading rod of decidedly different design from the Philadelphia rod. It is a wooden rod made in one piece with a metal roller set in it near each end. Passing over these rollers is a continuous steel band 20 ft. long and 0.1 ft. wide, on the outside of which for its entire length is painted a scale graduated to feet, tenths, and half-tenths, with the details of the numbers so designed that readings to the nearest 0.01 ft. can readily be made. Unlike the other rods mentioned the scale reads **down** on the face of the rod instead of up. It is provided with a clamp so that the metal band, or tape, can be set at any desired reading and held firmly in that position. The use of this type of rod is limited to cer-

* This rod was invented by Thomas F. Richardson and is used extensively by the Metropolitan Water and Sewerage Board of Boston, Mass.

tain kinds of work, its advantage being the time saved in calculations as explained in Art. 228, p. 206.

107. Precise Level Rod.—The self-reading rod used by the U. S. Coast and Geodetic Survey is made of a single piece of wood, soaked in paraffin to prevent changes in length due to moisture. Metal plugs are inserted at equal distances so that changes in length can be accurately determined. It is divided into centimeters, painted alternately black and white. The bottom of the rod carries a foot-plate. The meters and centimeters are read directly and the millimeters estimated. This rod has attached to it a thermometer, and a level for plumbing.

108. Advantages of the Self-Reading Rod.—While the advantage in the speed with which leveling can be accomplished by use of the self-reading rod is well understood, it is also true



FIG. 42. ROD LEVELS.

although not so generally recognized that very **accurate** results can be obtained. For any single reading the error may be larger than with the target rod, but the errors of estimating fractional parts are **compensating**, so that in the long run the results are found to be very accurate. Precise leveling carried on by the U. S. Coast and Geodetic Survey and by European surveys has demonstrated the superiority of such rods. The

self-reading rod might to advantage be more generally used than it is at present.

109. Attachments to the Rod for Plumbing.— In accurate work it will be convenient to use some device for holding the rod plumb. Spirit levels attached to brass "angles" which may be secured to a corner of the rod are very convenient. Two patterns are shown in Fig. 42. In some rods the levels are set permanently into the rod itself.

110. Effect of Heat and Moisture.— Changes of temperature do not have a serious effect on rods since the coefficient of expansion of wood is small. The effect of moisture is greater, however, and consequently if very accurate leveling is to be done the rod should be compared frequently with a standard. Rods soaked in paraffin are less affected by moisture than those which have not been so treated.

USE OF THE LEVEL AND ROD.

111. In order to obtain the difference in elevation between two points, hold the rod at the first point and, while the instrument is level, take a rod-reading. This is the distance that the bottom of the rod is below the line of sight of the level. Then take a rod-reading on the second point and the difference between the two rod-readings is the difference in elevation of the two points.

112. TO LEVEL THE INSTRUMENT.— Set up the instrument in such a position that the rod can be seen when held on either point and at such height that the horizontal cross-hair will strike somewhere on the rod. In setting up the level, time will be saved if the habit is formed of doing nearly all of the leveling by means of the tripod legs, using the leveling screws only for slight motions of the bubble in bringing it to the middle of the tube. Turn the telescope so that it is directly over two opposite leveling screws. Bring the bubble to the center of the tube **approximately**; then turn the telescope until it is over the other pair of leveling screws and bring the bubble **exactly** to the center. Move the telescope back to the first position and level carefully, and again to the second position if

necessary. If the instrument is in adjustment and is properly leveled in both directions, then the bubble will remain in the center during an entire revolution of the telescope about the vertical axis. The instrument should not be clamped ordinarily, but this may be necessary under some circumstances, for example, in a strong wind.

113. TO TAKE A ROD-READING. — The rodman holds the rod on the first point, taking pains to keep it as nearly plumb as possible. The levelman focuses the telescope on the rod, and brings the bubble to the center **while the telescope is pointing at the rod**, because leveling over both sets of screws will not make the bubble remain in the center in **all** positions unless the adjustment is perfect. If a target rod is used, the target should be set so that the horizontal cross-hair bisects it **while the bubble is in the center of the tube**. It is not sufficient to trust the bubble to remain in the center; it should be examined just before setting the target and immediately afterward, **at every reading**. The levelman signals the rodman to move the target up or down. When the center of the target coincides with the horizontal cross-hair the levelman signals the rodman, "All right" (Art. 115), and the rodman clamps the target and reads the rod. This reading is then recorded in the note-book. In accurate work the levelman should check the position of the target after it has been clamped to make sure that it has not slipped in clamping. For readings to hundredths of a foot it is not necessary to clamp the target; the rodman can hold the two parts of the rod firmly together while he reads it.

While the levelman is sighting the target, the rodman should stand **beside** the rod so that he can hold it as nearly vertical as possible in the direction of the line of sight. The levelman can tell by means of the vertical cross-hair whether it is plumb in the direction at right angles to the line of sight. **It is extremely important that the rod be held plumb**. Vertical lines on buildings are a great aid to the rodman in judging when his rod is plumb. If the wind is not blowing the rodman can tell when the rod is plumb by balancing it on the point.

114. WAVING THE ROD. — In careful work when the "long rod" is used it may be plumbed in the direction of the line of

sight by "*waving the rod.*" To do this the rodman stands directly behind the rod and inclines it toward the instrument so that the target will drop below the line of sight. He then slowly draws it back, causing the target to rise. It will be highest when the rod is plumb. If at any point the target appears above the cross-hair it should be lowered. If, while the rod is being waved, the target does not reach the cross-hair the target must be raised and the process repeated until as the rod is waved there appears to be just one place where the target coincides with the horizontal line of sight. Whenever close results are desired it will be well to take several readings on each point and use the mean.

115. Signals. — While the rodman is seldom very far away from the levelman in this work still it is often convenient to use hand signals. The following are commonly used in leveling.

"*Up*" or "*Down.*" — The levelman motions to the rodman by raising his arm above his shoulder for an upward motion and dropping his arm below his waist for a downward motion. A slow motion indicates that the target should be moved a considerable amount and a quick motion indicates a short distance.

"*All Right.*" — The levelman extends both hands horizontally and waves them up and down.

"*Plumb the Rod.*" — The hand is extended vertically above the head and moved slowly in the direction it is desired to have the rod plumbed.

"*Take a Turning Point.*" — The arm is swung slowly in a circle above the head.

"*Pick up the Level.*" — When a new set-up of the level is desired the chief of party signals the levelman by extending both arms downward and outward and then raising them quickly.

Some surveyors use a system of signals for communicating the rod-readings, but mistakes are liable to be made unless great care is used.

116. DIFFERENTIAL LEVELING. — Differential leveling is the name given to the process of finding the difference in elevation of any two points. In Art. 111 the simplest case of differential leveling is described. When the points are far apart the instrument is set up and a rod-reading is taken on the first point.

This is called a *backsight* or *plus sight* and is usually written *B. S.* or $+ S.$ Next the rod is taken to some well-defined point which will not change in elevation (such as the top of a firm rock) and held upon it and a reading taken. This is called a *foresight* or *minus sight* and is written *F. S.* or $- S.$ The difference between the two readings gives the difference in elevation between this new point and the first point. This second point is called a *turning point* and is written *T. P.* The level is next set up in a new position and a backsight taken on the turning point. A

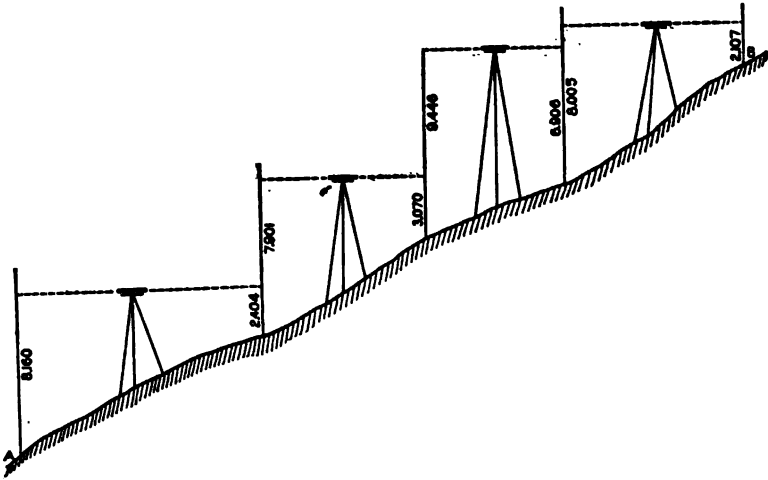

FIG. 43. DIAGRAM ILLUSTRATING DIFFERENTIAL LEVELING.

new turning point is then selected and a foresight taken upon it. This process is continued until the foresight is taken on the final point. The elevation of the last point above the first is equal to the sum of all the backsights minus the sum of all the foresights. If the result is **negative**, i.e., if the sum of the foresights is the **greater**, then the last point is **below** the first. The form of notes for this work is shown below, and the fieldwork is illustrated by Fig. 43.

POINT	B. S.	F. S.	REMARKS
A.	8.160	Highest point on stone bound, S. W. cor. X and Y Sts.
T. P.	7.901	2.404	
T. P.	9.446	3.070	
T. P.	8.005	6.906	
B.	2.107	N. E. cor. stone step No. 64 M St.
	33.512	14.487	
	14.487		

Diff. 19.025 B above A.

117. The Proper Length of Sight.— The proper length of sight will depend upon the distance at which the rod appears distinct and steady to the levelman, upon the variations in readings taken on the same point, and upon the degree of precision required. Under ordinary conditions the length of sight should not exceed about 300 ft. where elevations to the nearest 0.01 ft. are desired. "Boiling" of the air due to irregular refraction is frequently so troublesome that long sights cannot be taken accurately.

If the level is out of adjustment the resulting error in the rod-reading is proportional to the distance from the instrument to the rod. If the level is at equal distances from the rod the errors are equal and since it is the **difference** of the rod-readings that gives the difference in elevation, the error is eliminated from the final result if the rodman makes **the distance to the point where the foresight is taken equal to the distance to the backsight** by counting his paces as he goes from one point to the other.

118. Effect of the Earth's Curvature and of Refraction on Leveling.— Since the surface of the earth is very nearly spherical,

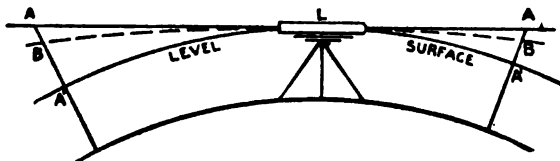

FIG. 44. DIAGRAM ILLUSTRATING EFFECT OF EARTH'S CURVATURE AND OF REFRACTION.

any line on it made by the intersection of a vertical plane with the earth's surface is practically circular. In Fig. 44 the distance AA' varies nearly as $\sqrt{L^2}$ (see foot-note, p. 339). The effect of

the refraction of the atmosphere is to make this offset from the tangent appear to be $A'B$ which is about one-seventh part smaller than $A'A$. This offset, corrected for refraction, is about 0.57 ft. in one mile; for 300 ft. it is 0.002 ft.; for 500 ft., 0.005 ft.; for 1000 ft., 0.020 ft. If the rod is equally distant from the instrument on the foresight and backsight the effect of curvature and refraction is eliminated from the result.

119. PRECAUTIONS IN LEVEL WORK. — Nearly all of the precautions mentioned in Art. 68, p. 55, for the transit instrument, are also applicable to the level. Care should be taken not to strike the rod on the ground after it has been clamped and before it has been read.

ADJUSTMENTS OF THE LEVEL.

I. ADJUSTMENTS OF THE WYE LEVEL.

120. ADJUSTMENT OF THE CROSS-HAIRS. — (a) To make the Horizontal Cross-Hair truly Horizontal when the Instrument is Leveled. This may be done by rotating the cross-hair ring as in the case of the transit (Art. 71, p. 57), if the instrument is so constructed that the telescope cannot be rotated in the wyes. In many instruments the telescope can be rotated in the wyes. In some levels the telescope is always free to rotate in the wyes, while others are provided with a stop regulated by an adjusting screw, which prevents the telescope from rotating beyond a certain point.

The instrument is leveled and some point found which is covered by the horizontal cross-hair. The telescope is turned slowly about the vertical axis so that the point appears to traverse the field of view. If the point remains on the cross-hair the adjustment is perfect. If it does not, then an adjustment must be made, the manner of doing this depending upon the construction of the instrument. If the telescope cannot be rotated in the wyes the adjustment is made by rotating the cross-hair ring, similar to the adjustment described in Art. 71, p. 57. If the telescope has a stop-screw this must be moved until the instrument

satisfies this test. If the telescope can rotate freely in the wyes it can be turned by hand until it satisfies the test. Since there is nothing to hold the telescope in this position the adjustment in the last case is likely to be disturbed at any time.

121. (b) When the above adjustment is completed the **Line of Sight should be made to Coincide with the Axis of Pivots, or Parallel to it.** (See Fig. 45.) Pull out the pins which hold the clips on the telescope and turn the clips back so that the telescope is free to turn in the wyes. Sight the intersection of the cross-hairs at some well-defined point, using the leveling screws for the vertical motion and the clamp and tangent screw for the horizontal motion. Then rotate the telescope 180° in the wyes, so that the level tube is above the telescope. The intersection of the cross-hairs should still be on the point. If not, move the horizontal cross-hair half-way back to its first position by means of the upper and lower adjusting screws of the cross-hair ring. Then move the vertical cross-hair half-way back to its first position by the other pair of screws. Repeat the test until the adjustment is perfect.

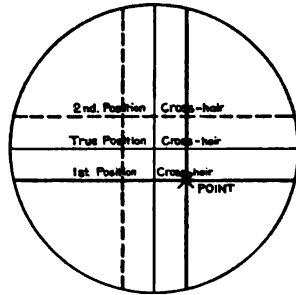

FIG. 45. ADJUSTMENT OF THE CROSS-HAIRS (SECOND PART).

122. **ADJUSTMENT OF THE LEVEL TUBE.** — To make the **Line of Sight and the Level Tube Parallel to Each Other.** Two methods are used, — the *direct*, or “*peg*,” method and the *indirect* method. While the former is the only one applicable to the dumpy level either one can be used for the wye level, although the indirect method is the simpler.

123. **ADJUSTMENT OF THE LEVEL TUBE BY INDIRECT METHOD.** — (a) To put the **Axis of the Bubble Tube in the Same Plane with the Line of Sight.** Bring the bubble to the center of the tube and rotate the telescope in the wyes for a few degrees (very little is necessary); if the bubble moves toward one end of the tube that end must be the higher, which indicates the direction in which the adjustment should be made. Move

the screws controlling the lateral movement of the tube until the bubble returns to the center. Test the adjustment by rotating the telescope each way.

124. (b) To make the Axis of the Bubble Tube and the Line of Sight Parallel to Each Other. First clamp the instrument (over a pair of leveling screws), then bring the bubble to the center of the tube, lift the telescope out of the wyes, turn it end for end and set it down in the wyes, the eye end now being where the objective was originally. (See Fig. 46.) This operation must be performed with the greatest care, as the slightest jar of the instrument will vitiate the result. If the bubble returns to the center of the tube, the axis of the tube is in the correct position. If it does not return to the center, the end of the tube provided

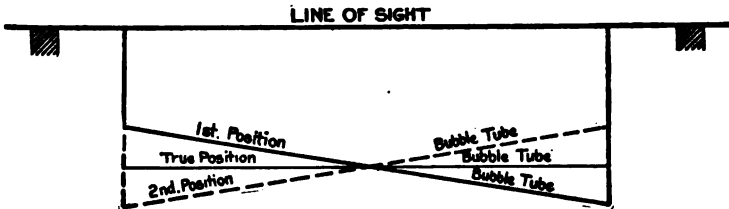

FIG. 46. ADJUSTMENT OF THE BUBBLE TUBE BY INDIRECT METHOD.

with the vertical adjustment should be moved until the bubble moves half-way back to the center. This test must be repeated to make sure that the movement is due to defective adjustment and not to the jarring of the instrument.

125. ADJUSTMENT OF THE WYES. — To make the Axis of

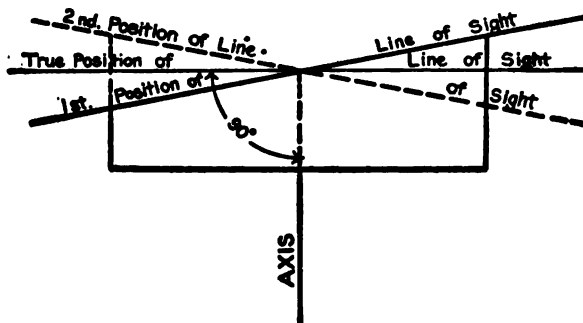

FIG. 47. ADJUSTMENT OF THE WYES.

the Level Tube Perpendicular to the Vertical Axis of the Instrument. Bring the two clips down over the telescope and fasten them. Level the instrument, bring the bubble precisely to the middle of the tube over one set of leveling screws, and then turn the telescope 180° about the vertical axis. If the bubble moves from the center bring it half-way back by means of the adjusting screws at the foot of one of the wye supports. (See Fig. 47.)

Since the bubble is brought to the center of the tube each time a rod-reading is taken this last adjustment in no way affects the accuracy of the leveling work but is a convenience and a saving of time.

II. ADJUSTMENTS OF THE DUMPY LEVEL.

126. ADJUSTMENT OF THE CROSS-HAIR. — If the horizontal cross-hair is not truly horizontal when the instrument is level it should be made so by rotating the cross-hair ring as described in the adjustment of the transit, Art. 71, p. 57.

127. ADJUSTMENT OF THE BUBBLE TUBE. — **To make the Axis of the Bubble Tube Perpendicular to the Vertical Axis.** Owing to the construction of the dumpy level it is necessary to make this adjustment before making the line of sight parallel to the bubble tube. It is done by centering the bubble over one pair of leveling screws, and turning the instrument 180° about the vertical axis. If the bubble does not remain in the center of the tube, move it half-way back to the center by means of the adjusting screws on the level tube.

128. THE DIRECT, OR "PEG," ADJUSTMENT. — **To make the Line of Sight Parallel to the Axis of the Bubble.** (See Fig. 48.) Select two points *A* and *B*, say, 200 ft. or more apart. Set up the level close to *A* so that when a rod is held upon it the eye-piece will be only about a quarter of an inch from the rod. Look through the telescope **wrong end to** at the rod and find the reading opposite the center of the field. After a little experience it will be found that this can be done very accurately. From the fact that only a small portion of the rod is visible it will be found convenient to set a pencil-point on the rod at the center of

the small field of view. Turn the telescope toward *B* and take a rod-reading on it in the usual way, being certain that the bubble is in the middle of the tube. The difference between these two rod-readings is the difference of elevation of the two points **plus** or **minus** the error of adjustment. The level is next taken to *B* and the above operation is repeated. The result is the difference in elevation **minus** or **plus** the same error of adjustment. The mean of the two results is the true difference in elevation of points *A* and *B*. Knowing the difference in elevation between the two points and the height of the instrument above *B* the rod-reading at *A* which will bring the target on the same level as the instrument may be computed. The bubble is brought to the center of the tube and the horizontal cross-hair raised or lowered by means of the adjusting screws on the cross-hair ring until the line of sight strikes the target. In this method the small error due to curvature of the earth (nearly 0.001 ft. for a 200-ft. sight) has been neglected.

EXAMPLE.

(See Fig. 48.)

Instrument at A.

Rod-reading on A = 4.062

Rod-reading on B = 5.129Diff. in elev. of A and B = 1.067

Instrument at B.

Rod-reading on B = 5.076

Rod-reading on A = 4.127Diff. in elev. of B and A = 0.949

Mean of two diff. in elev. = $\frac{1.067 + 0.949}{2} = 1.008$ true diff. in elev.

Instrument is now 5.076 above B.

Rod-reading at A should be $5.076 - 1.008 = 4.068$ to give a level sight.

The peg method may be used for adjusting the wye level or the transit, the difference being that in the dumpy level the axis of the bubble tube is first made horizontal and then the line of sight is brought parallel to it, while in the wye level and in the transit the line of sight is first made horizontal and then the axis of the bubble tube is made parallel to it. Consequently, in the former case the cross-hair ring is moved in adjusting whereas in the latter case the adjustment is made in the bubble tube. This

adjustment in its simplest form is described in the following article.

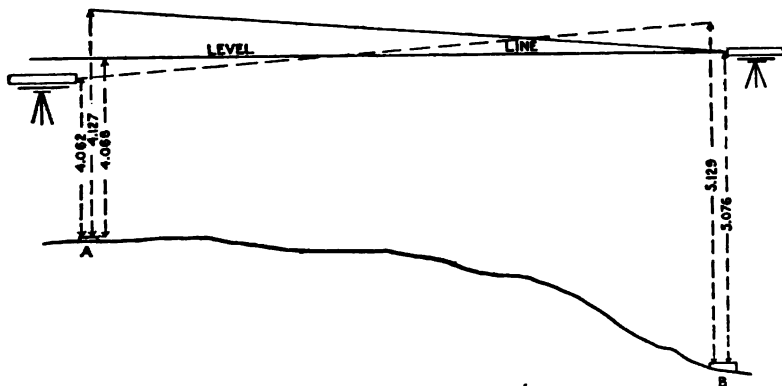

FIG. 48. PEG ADJUSTMENT.

129. ADJUSTMENT OF THE LOCKE HAND LEVEL. — In adjusting the hand level the principle of the peg adjustment is used. The level is placed at a mark *A* (Fig. 49) and another mark *B* in line with the cross-hair is made, say, 100 ft. away,

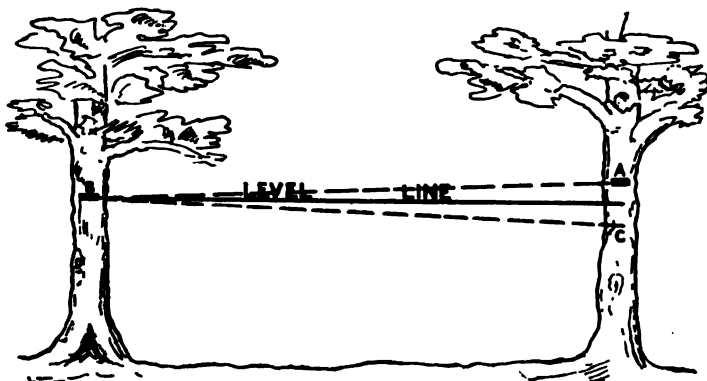

FIG. 49. PEG ADJUSTMENT FOR HAND LEVEL.

when the bubble is in the middle. The level is then taken to *B*, held so that its center is at the height of this mark, and sighted toward the first point. A third point *C* is marked in

line with the cross-hair when the bubble is in the middle. The point midway between A and C is at the same level as B . The adjustment is made by screws which move the horizontal wire.

130. COMMON SOURCES OF ERROR IN LEVELING. —

1. Improper focusing (parallax).
2. Bubble not in middle of tube at instant of sighting.
3. Rod not held plumb.
4. Foresights and corresponding backsights on turning points not equally distant from the instrument.
5. Poor turning points selected. (See Art. 224, p. 202.)

131. COMMON MISTAKES. —

1. Foresight and Backsight not taken on exactly the same point.
2. Neglecting to set target accurately when "long rod" is used.
3. In the use of the self-reading rod neglecting to clamp the rod at the proper place when "long rod" is used.
4. Reading the wrong foot-mark or tenth-mark.
5. In keeping notes, — getting F. S. in B. S. column or *vice versa*.
6. In working up notes, adding F. S. or subtracting B. S.

PROBLEMS.

1. A wye level was tested for the sensitiveness of the bubble, as follows: the rod was held on a point 200 ft. away; the bubble was moved over 13.6 divisions of the scale; the rod-readings at the two extreme positions of the bubble were 4.360 and 4.578. Compute the average angular value of one division of the level.

2. A dumpy level was tested by the peg method with the following results.

Instrument at A : —

B. S. on A , 4.139

F. S. on B , 4.589

Instrument at B : —

B. S. on B , 3.900

F. S. on A , 3.250

Find the rod-reading on A to give a level line of sight, the instrument remaining 3.900 above B . Was the line of sight inclined upward or downward? How much?

3. The target on a Boston rod has been disturbed and it is desired to find out if the target is in the correct position with reference to the scale. Describe a method by which the amount of this error can be determined.

4. A New York rod is found to be 0.002 ft. short, due to wear on the brass foot-plate. Explain what effect this will have in finding the difference in elevation between two points.

5. (a). A level is set up and a B. S. of 5.098 is taken on a point 400 ft. away, then a F. S. of 3.260 is taken on a point 900 ft. away. What is the curvature and refraction correction? What is the difference in elevation of the two points?

(b). In another case a B. S. of 8.266 was taken on a point 100 ft. away and a F. S. of 6.405 taken on a point 600 ft. away. What is the curvature and refraction correction? What is the difference in elevation of the two points?

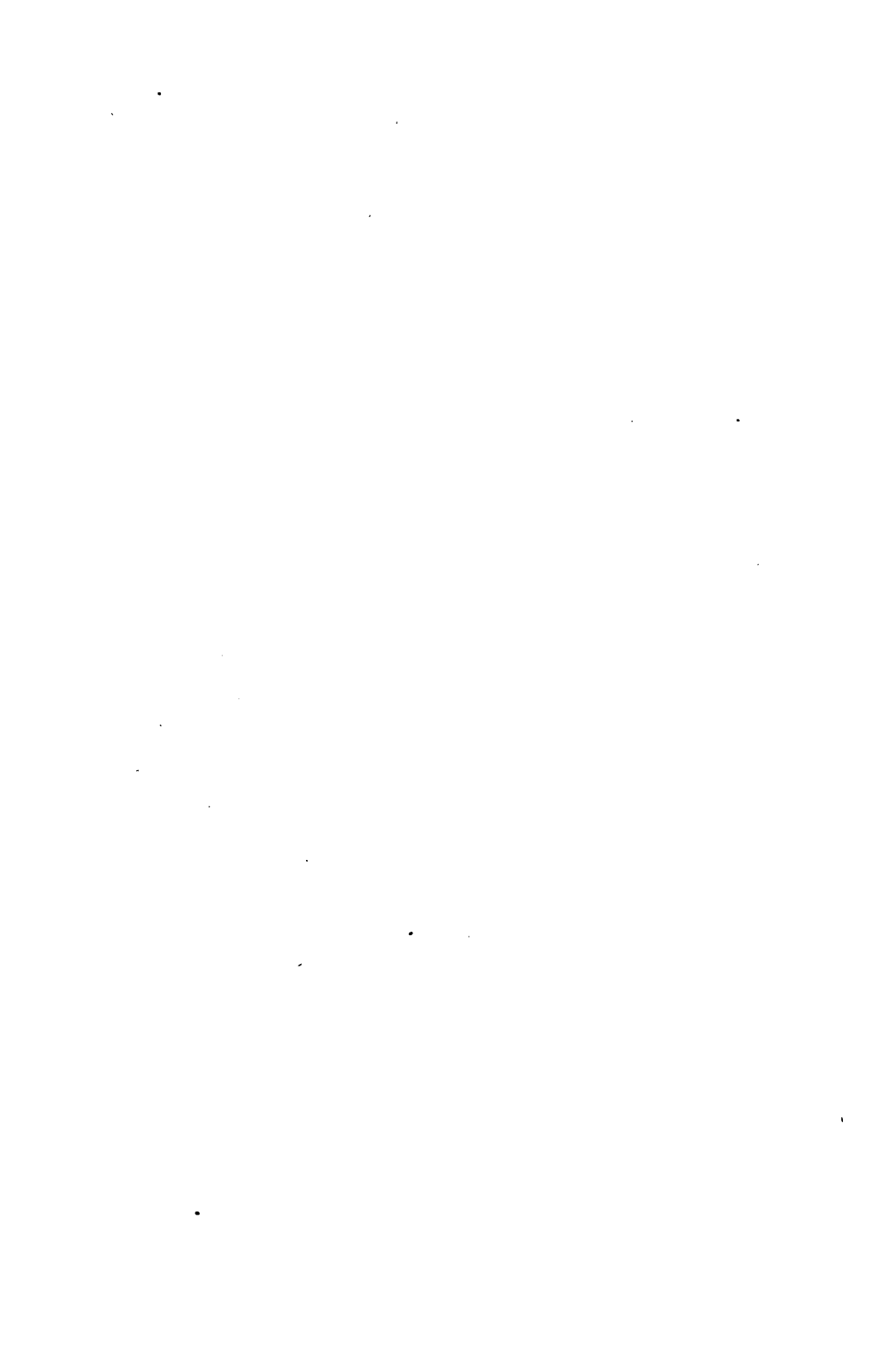

PART II.
SURVEYING METHODS.

PART II.
SURVEYING METHODS.

CHAPTER V.

LAND SURVEYING.

132. SURVEYING FOR AREA.—In surveying a field for the purpose of finding its area the instruments and methods used will be determined largely by the degree of accuracy required. If it is permissible to have an error in the area of, say, 0.5 per cent then the compass and chain may be used. If accuracy much greater than this is required it will be necessary to use the transit and the steel tape. At the present time, however, in nearly all work except surveys of farms and woodlands, the transit is used even under conditions where the compass would give the required accuracy.

In surveying a field all the angles and lengths of the sides are determined consecutively, the survey ending at the point from which it was started. Then by trigonometry the position of the final point or of any other point with relation to the starting point can be readily calculated. If the survey were absolutely accurate the last point as calculated would coincide with the first, but this condition is never attained in practice. The calculated distance between the two, divided by the perimeter of the field, is usually called the *error of closure*;* it is often expressed in the form of a fraction in which the numerator is unity. In surveying with a compass and chain the error of closure expected is about 1 part in 500, expressed as $\frac{1}{500}$.

133. SURVEYING FOR AREA WITH COMPASS AND CHAIN.—If the area alone is desired the surveyor's 4-rod chain will be

* The term *error of closure* more properly applies to the actual distance by which the survey fails to close, but as this is generally expressed in the form of a fraction the term has commonly been applied to the latter.

convenient on account of the simple relation existing between the square chain and the acre (Art. 4, p. 3). In making a survey enclosing an area it is customary to begin at some convenient corner and to take the bearings and the distances in order around the field. As the measurements are made they are recorded in a field note-book. It is not necessary to take the sides in order, but since they must be arranged in order for the purpose of computing the area it will be convenient to have them so arranged in the original notes. If the length and bearing of any side are omitted the area is nevertheless completely determined (Art. 397, p. 366), but as these two measurements furnish a valuable check on the accuracy of all the measurements

(LEFT-HAND PAGE)

(RIGHT-HAND PAGE)

Survey of Wood Lot of John Smith, Northboro, Mass.				A. Brown, Surveyor J. Loon, Chainman Oct. 7, 1856.	
Sta.	Bearing	Measured Distance	Distance (Chains)	2 rod chain - Range Compass - Chain 0.1 link too long.	
				Remarks	
A	Due E	N 32° W	77.75	Stone and stones cor. J. Smith, B. White and L. Richardson.	
B	N 50° E	N 65° W	13.55	Pine Stump	
C	N 17° E	S 59° W	32.36	Oak Stump	
D	S 65° W	S 7° W	22.25	Cedar St. S. S. E. of large oak.	
E	S 23° W	N 65° E	30.94	Stone bound, E. side Pine St.	
F	S 32° E	N 23° E	11.16	Stone bound, E. side Pine St.	

FIG. 50. NOTES OF CHAIN AND COMPASS SURVEY.

they never should be omitted if they can be taken. It is of the utmost importance in every survey that check measurements should be taken. Even a few rough checks taken in the field which will require only a little extra time often prove to be of great value in detecting mistakes. Both a forward bearing and a back (or reversed) bearing should be taken at each corner; from these the angle at a corner can be obtained free from error due to any local attraction of the needle. The above process gives a series of connected straight lines and their bearings (or the angles between them), which is called a *traverse*.

It is often impossible to set the compass up at the corners of the property, and in such cases assumed lines running parallel or approximately parallel to the property lines can be

surveyed as described in Art. 134, and its area determined. In some cases the compass can be set on the property line at an intermediate point and the bearing obtained, but the surveyor must be sure that there is no local attraction of the needle at this point. All points where the compass is set should be marked and described so that they can be found again. If any instrument point is not otherwise defined it may be temporarily marked by a small stake and several reference measurements made from this stake to prominent objects nearby, so that its position can be relocated if the stake is lost. These measurements are called *ties*.

Notes of the traverse are usually recorded as shown in Fig. 50.

SURVEY OF FIELD WITH TRANSIT AND TAPE.

134. SURVEY OF A FIELD BY A TRAVERSE. — Surveying a field for area can usually be done in one of the three following ways.

(1). By setting up the transit at the corners of the property and measuring the angles directly; the distances being measured directly along the property lines.

(2). When the property lines are so occupied by buildings or fences that the transit cannot be set up at the corners, but the distances can still be measured along the property lines, then the angles at the corners are obtained by measuring the angles between lines which are parallel to the property lines.

(3). If the boundaries of the property are such that it is not practicable to set the transit up at the corners nor to measure the distance directly on the property lines, a traverse is run approximately parallel to the property lines and these lines connected with the traverse by means of angles and distances.

135. In the case (2) the parallel lines are established in the following manner. Set the transit up at some point *E*

(Fig. 51) within 2 or 3 ft. of the corner A . Establish the line EF parallel to AD by making $DF = AH$ by trial. Point H cannot be seen through the telescope, but it is so near the instrument that by means of the plumb-line on the transit it can be accurately sighted in by eye. Similarly EG is established parallel to AB . Then the angle FEG is measured; and this is the property

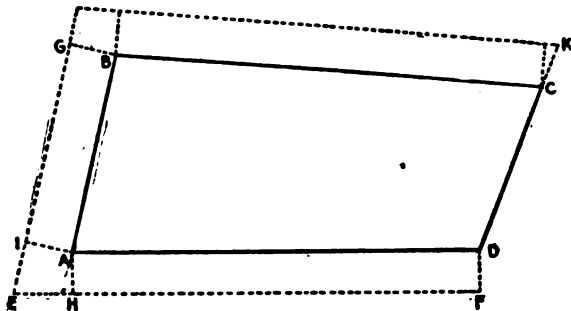

FIG. 51. TRANSIT LINES PARALLEL TO THE SIDES OF FIELD.

angle at A . It is evident that the values of AH and DF and of AI and BG are of no permanent use and are therefore not recorded in the notes. When practicable it is advisable to choose the transit point, K for example, on one of the property lines or its prolongation. Fig. 52 is a set of notes illustrating either case (1) or (2).

136. In the case (3) the transit can be set up at an arbitrary point marked by a stake and chosen far enough from one of the corners so that the telescope can be focused on it. In this way all the corners of the traverse are chosen so that the traverse will be approximately parallel to the sides of the field. The angles and distances of this traverse are then measured. To connect the property lines with this traverse, angles and distances are measured to the respective corners of the property before the instrument is moved to the next point. Fig. 53 is a set of notes illustrating this case. Time can be saved in the computations and a good check on the work may be obtained if the property lines are also measured when possible. These are not only useful as checks on the accuracy of the survey, but the

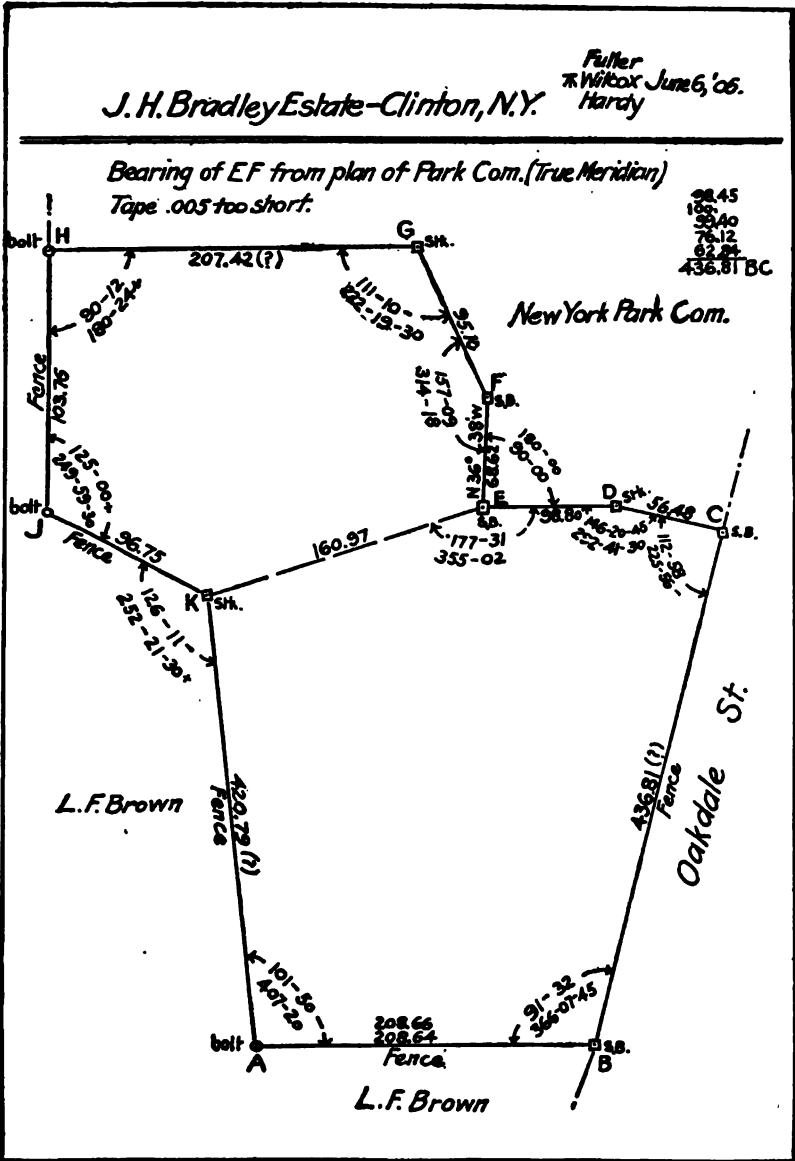

FIG. 52. NOTES OF SURVEY WITH TRANSIT AND TAPE.

length of the sides will be needed in giving a description of the property.

These three methods which have been described may be combined in any survey according to circumstances.

137. Irregular Curved Boundaries. — When a tract of land is bounded by an irregular curved line such as a brook it is customary to run the traverse line near it, sometimes crossing it several times, and to take perpendicular offsets to the brook. If it is a winding brook with no distinct turns in it, offsets at regular intervals are measured from the transit line as in the portion near point *A* of Fig. 53. Near point *B* in this figure the brook has practically a direct course between its turns, in which case the proper measurements to make are the offsets to those points where the course of the brook changes and the distances along the transit line between these offset lines. Since they are usually short the right-angle offset lines are laid off by eye.

138. SURVEY OF A FIELD BY A SINGLE SET-UP OF THE TRANSIT. — When it is necessary to economize time in the field at the expense of accuracy and of the time required to calculate the survey the following method may be used. If possible set up at a point within the field, preferably near the middle, from which all the corners can be seen, and measure the angles and distances to each corner. In this way the field is divided into several oblique triangles in each of which two sides and the included angle have been measured and from these the area and third side (property line) can be computed. As a check on the measured angles their sum should be 360° ; there is no check on the property lines unless they are measured directly.

This method of surveying a field may be employed as a check on one of the other methods which have already been described, but is not recommended as a method to be used by itself except in emergencies. The weak point in it is the low degree of precision with which the angles are usually measured. Here the effect of an error of, say, 30 seconds in an angle may often be much larger than the errors in the measured distances (Art. 352, p. 325). The additional measurement of the property line gives the length of all three sides of the various triangles into which

the field is divided. If the area is calculated from the three sides of the triangles, using the measured angles as checks only, an accurate result may be obtained, but at the expense of considerable office work.

139. SURVEY OF A FIELD WITH A TAPE ONLY. — Sometimes it may be necessary to survey a field when a transit is not at hand. This can be done by dividing the field into several triangles and measuring all their sides. To insure accuracy of results the triangles should be so chosen that there are no angles in them less than 30° or greater than 150° . This method will require a large amount of computation if the angles as well as the area of the field are desired. Lining in by eye will give accurate results in distances along the line, but only approximate side measurements can be obtained from such a line.

140. Selecting the Corners. — If a corner is marked by a stone bound the exact point may be easily found; but where it is simply defined as the intersection of stone walls or fences the surveyor will have to examine all evidence as to its position and use his judgment in deciding where the true corner is located (Art. 151, p. 116). When the property is bounded by a public way or a town boundary such data relating to the location of these lines must be obtained from the proper local authorities. After determining the position of the corner points, the surveyor should use precisely the same points in all distance or angle measurements. If stakes are used the exact point is marked by a small tack driven into the top of the stake.

In deciding upon the location of the boundary lines from an examination of artificial features it should be borne in mind that it is customary to build fences or walls along highways entirely on private property so that the face of the wall or fence is on the side line of the highway. In cities the base-board of a fence is usually built so that its face is on the street line, but the location of the fences has no weight when the street line is defined by stone bounds or other permanent marks (Art. 253, p. 227). For boundaries between private lands the legal line is, in the case of a stream, the thread (not necessarily the center) of the stream; the center of the stone wall or Virginia rail fence; the line between the bottom stringer and the boarding or pickets of an

ordinary fence, the fence-posts being entirely on one side of the boundary line. Not infrequently woodland is marked off by blazing the trees on one or both sides of the boundary line, the blazing being done on the side of the tree nearest the boundary line. If a tree comes directly on the line it is blazed on both sides where the line strikes it. A small pile of stones, sometimes with a stake in the center of the pile, is often used to mark the corners of such land.

141. Method of Procedure. — In deciding where the traverse shall be run the surveyor should keep in mind both convenience in fieldwork and economy in office work. Frequently a method of procedure which shortens the time spent in the field will greatly increase the amount of the labor in the office. Circumstances will determine which method should be used. If there is no special reason why the time in the field should be shortened, the best arrangement of the traverse will be the one that will make the computation simple, and hence mistakes will be less liable to occur. If the lines of the traverse coincide with the boundary, as in cases (1) and (2), the amount of office work will be the least. If in case (3) the traverse lines are approximately parallel and near to the boundaries of the property the computation of the small areas to be added to or subtracted from the area enclosed by the traverse is simplified to some extent.

142. TIES. — All important points temporarily marked by stakes should be "tied in," i.e., measurements should be so taken that the point may be readily found or replaced in the future. There should be at least three horizontal ties which intersect at angles not less than 30° . They should be taken from easily recognized definite points, such as blazed trees, stone bounds, fence posts, or buildings. All such measurements should be carefully recorded, usually by means of a sketch Fig. 54 shows a stake located by ties measured to tenth of a foot; these are taken

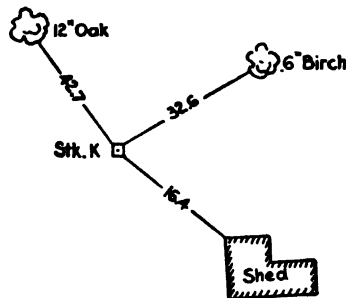

FIG. 54. APPROXIMATE TIES.

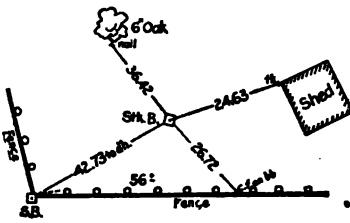

FIG. 55. EXACT TIES.

simply to aid in finding the stake.

It is often desired to take the ties so that the exact point can be replaced. In such cases the surveyor should mark carefully by tack or crow-foot the exact points from which measurements (taken to $\frac{1}{100}$ ft.) are

made, and record the entire information in the notes as shown in Fig. 55.

143. Measurement of the Angles of the Traverse. — The angles of the traverse may be measured in any one of three ways; by measuring the *interior angle*, by measuring the *deflection angle*, which is the difference between the interior angle and 180° , or by measuring the *azimuth angle*.

In practice the deflection angle is measured directly by sighting back on the previous point with the vernier at 0° and the telescope *inverted*, then revolving the telescope about its horizontal axis to the *direct* position and turning the upper limb to the right or left until the next point is sighted. The deflection angle as recorded in the notes is marked *R* or *L* to indicate whether the telescope was turned to the right or left. It is evident that a single measurement of the deflection angle is affected by any error in the adjustment of the line of sight as well as of the standards. If the deflection angle is "doubled" by turning to the backsight with the instrument *direct* and the angle repeated a check on the angle is obtained and the errors of adjustment are also eliminated (Art. 79, p. 61). Where this procedure is followed it will be convenient to make the first backsight with the instrument *direct* so that when the second foresight is taken the instrument will again be in the *direct* position and ready for lining in.

144. MEASUREMENT OF AZIMUTH ANGLES. — By the azimuth method the angles are measured as follows. The transit is set up at a point *A* (Fig. 56), the vernier set at 0° , the telescope turned until it points to the south, and the lower plate clamped. Either the true or the magnetic south may be used,

but if neither is known any arbitrary direction may be assumed. The upper clamp is loosened and the telescope sighted on B . The angle read on the vernier is the azimuth of AB , the circle being read in a clockwise direction (Art. 24, p. 16). The transit is next moved to B .

The azimuth of BC may be obtained in one of two ways. (1) Invert the telescope and backsight on A , the vernier remaining at the reading it had at A ; then clamp the lower plate, turn the telescope to its direct position, and sight on C . The angle on the vernier is the azimuth of BC referred to the same meridian as the azimuth of AB . The disadvantage of this method is that the error of collimation enters the azimuth angle each time. (2) (Add 180° to the azimuth of AB , set this off on the vernier, and sight on A . The telescope may then be turned directly to C (without inverting) and the azimuth of BC can be read directly on the vernier. The disadvantages of this method as compared with the former are that the error of eccentricity of the circle enters, that time is consumed in setting the vernier at each set-up of the instrument, and that there is an opportunity for mistakes in calculating and in making the setting on the vernier.

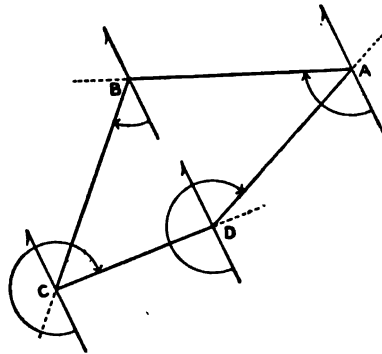

FIG. 56. AZIMUTH ANGLES.

In the azimuth method the angles of the traverse are checked by the fieldwork. After point D has been occupied, the transit is again set up at A and the azimuth of AB determined from a backsight on D . This azimuth of AB should agree with the original azimuth of this line. In ordinary land surveying the azimuth method of measuring the angles is little used.

145. Checking the Fieldwork. — The transit is set over the selected points and the angles between the adjacent lines measured. If the work is not to be of unusual precision a

transit reading to one minute will be sufficient. A single measurement will give the angle with sufficient precision, but as it is important in all cases to have a check on the work it is advisable to "double the angle" (Art. 60, p. 50), even though it is not necessary to use this method for the purpose of precision. Referring to Fig. 52, p. 103, it will be seen that the angles were quadrupled where the sides were long, and doubled where they were short. In this case the angles were repeated to obtain greater precision.

As an additional check against large errors in the angles, the magnetic bearing of each line should be read, thus enabling one to detect mistakes greater than a quarter of a degree and to guard against reading Right for Left in deflection angles. These bearings also show the approximate directions of the lines of the survey. This check should always be applied **in the field** so that any mistake in reading the angles can be rectified before leaving the work. This may be done by calculating each angle from the **observed bearings** of the adjacent sides; or by starting with one observed bearing (assumed to be correct), calculating the other bearings in succession by means of the measured angles, and noting whether the observed bearings agree approximately with the *calculated bearings*.

After the angles have been measured, the accuracy of the transit work may be tested by adding them together. The sum of the interior angles of the field should equal $(n-2) \times 180^\circ$, where n is the number of sides in the field. If the deflection angles are used the sum of all the right deflections should differ from the sum of all the left deflections by 360° , or in other words, **the algebraic sum of the deflection angles should be 360° .**

It is frequently important to check the distances before leaving the field. If there is any doubt as regards the correctness of the measurement of a line it should be remeasured, preferably in the **opposite direction**, so that the same mistake will not be repeated. (See line AB in Fig. 52, p. 103.) If the traverse lines do not coincide with the boundaries, an independent check is obtained by measuring along the boundaries as well as on the traverse line, as in Fig. 53, p. 104. This furnishes at once a

rough check on the distances in the field and a **close** check after the survey has been calculated. It is often advisable to run a line across the traverse, especially when there are many sides to the field, thus dividing the field into two parts, as in Fig. 52, p. 103. If any mistake has been made it is then possible to tell in which portion of the traverse it occurred (Art. 407, p. 371).

146. Accuracy Required. — In order that the accuracy in the measurement of distances shall be consistent with that of the angles it is necessary that great care should be exercised in holding the tape horizontal, in the plumbing, in the aligning, and in securing the proper tension.

If the angles are measured to the nearest minute and the distances to the nearest tenth of a foot, it will be sufficiently accurate to use sighting-rods in "giving line." The error of closure of such a survey should be not greater than $\frac{1}{50000}$, but would seldom be less than $\frac{1}{100000}$ (Art. 132, p. 99).



If the property is very valuable, as in the case of city building lots, it is well to use a transit reading to 30" or 20". The angles should be repeated, not only as a check against mistakes, but to increase the precision of the measurement (Art. 59, p. 48). The tape measurements should be made with special care, and should be taken to the nearest hundredth of a foot. In the best work the temperature correction should be applied, a spring balance should be used to give the right pull on the tape, the correction to the standard distance should be determined (Art. 241, p. 216), the alignment given with the transit, and great care taken in plumbing. Sights are given by holding a pencil vertically on top of the tack on the stake or by plumb-line (Art. 65, p. 52). In this work it is important that the property line should be followed, when possible, to insure the most accurate results. In such work an error of closure of $\frac{1}{400000}$ or better is expected. It is customary on most city work to neglect the effect of temperature and to omit the use of the spring balance, the pull being carefully judged. This sort of work should give results as close as $\frac{1}{200000}$, and an accuracy of $\frac{1}{400000}$ is sometimes reached.

147. Organization of Transit Party. — Transit surveys can be readily carried on by a party of three men. The note keeper

who is in charge of the party directs the entire work ; the transitman who has the instrument always in his care sets it up where directed by the note keeper, reads the angles and gives line when desired; the chainman generally acting as head-chainman and the note keeper as rear-chainman, measure all distances.

148. Note Keeping. — All measurements should be recorded in a special note-book as soon as they are made and never left to be filled in from memory. **The notes should be neat and in clear form so that there will be no doubt as to their meaning.** Great care should be taken so that they shall not be susceptible of any interpretation except the right one. They are generally recorded in pencil, but they should always be regarded as permanent records and not as temporary memoranda. As other persons who are not familiar with the locality will probably use the notes and will depend entirely on what is recorded, it is very important that the notes should contain all necessary data without any superfluous information. If the note keeper will bear in mind constantly how the survey is to be calculated or plotted it will aid him greatly in judging which measurements must be taken and which ones are unnecessary. Clearness is of utmost importance in note keeping, and to attain it the usual custom is not to attempt to sketch to scale ; and yet in surveys where considerable detail is desired it is sometimes well to carry out the sketches in the note-book approximately to scale. Care should be taken not to crowd the notes, — paper is cheap, — and an extra page of the note-book devoted to a survey may save hours of time in the office consumed in trying to interpret a page of crowded data. Too much stress cannot be laid on the importance of being careful not to lose the note-book ; not infrequently a note-book contains data which thousands of dollars could not replace.

Although sufficient fulness to make the notes clear is desirable, it is customary to abbreviate the names of the artificial features most commonly met with by the surveyor. To properly understand a set of notes one must be familiar with these abbreviations, some of the more common of which are enumerated.

SB.	Stone bound.
Mon.	Monument.
▲	Triangulation Station.
Stk.	Stake.
tk	Tack.
na.	Nail.
Spk.	Spike.
dh.	Drill-hole.
c.f.	Crow-foot (a mark like this ∇ or ψ).
c.c.f.	Cut crow-foot (cut into wood or stone).
C.	Center.
CL	Center line.
cb	Curb.
C.B.	Catch basin.
M.H.	Manhole.
TeL	Telegraph pole.
— · — · — ·	Fence.
	Fence, showing on which side the posts are.
bb.	Base-board of fence.
	Line of building; the outside line is the base-board, the cross-hatched part is the line of the stone or brick underpinning.

Distances should always be recorded in such a way as to indicate the precision with which they were taken. For example, if they were taken to hundredths of a foot and a measurement happened to be just 124 ft. it should be recorded as 124.00, not as 124. The two zeros are of as much consequence as any other two digits which might have come in their places. Angles which have been read to the nearest half-minute, however, are recorded as follows: $6^{\circ} 47' 30''$. It will be seen that this is not consistent with the foregoing. A more

proper way of reading this angle would be $6^{\circ} 47\frac{1}{2}'$, but this is not common practice.

In addition to the measurements every set of notes should contain the following information:—the kind of work, the locality, the date, and the names of members of the field party. It is well to also state the names or numbers of the instruments used and their errors. Where a survey is continued for several pages the date may be placed at the top of every page; other data need not be repeated. Fig. 50, p. 100, Fig. 52, p. 103, and Fig. 53, p. 104, are good examples of field notes.

149. SURVEY OF A FIELD FOR A DEED.—In this case the lengths and bearings of all the boundaries are desired. The traverse lines should therefore follow the property lines, if possible. The bearings desired are not the observed magnetic bearings, but are those calculated by means of the transit angles as explained in Art. 145, p. 110, and therefore are relatively as accurate as the angles themselves. In case a true meridian is found by observation (Chapter VII) the bearings should be referred to this and marked **true bearings** by a note on the plan, and this information should also be contained in the deed.

A plan which is to accompany a deed should show such features as watercourses, highways, buildings, and adjoining property lines, as well as stone bounds, stakes, fences, walls, or other artificial objects which mark the boundaries of the property.

This plan should contain the following information.

- (1) Lengths of all property lines together with their calculated bearings or the angles at the corners.*
- (2) Location and description of corner bounds.
- (3) Conventional sign or name on walls, fences, etc.

* It is customary with many surveyors to omit from the plan certain data such as the angles or bearings, so that, while it may answer the purpose for which it was made, it does not contain all the data and frequently not enough to enable another surveyor to relocate the property by means of it. This is done, of course, so that when the tract is to be resurveyed or plotted it will be necessary to employ the same surveyor who has in his possession data for which the owner has paid and which the surveyor should have turned over to him. For a valuable paper on this subject see "The Ownership of Surveys, and what Constitutes a Survey and Map," by Professor William G. Raymond, published in *The Polytechnic*, the student journal of the Rensselaer Polytechnic Institute, Troy, N. Y., January, 1894.

(4) Names of highways, streams or ponds, and names of adjacent property owners.

(5) Scale of drawing and direction of the meridian used (true or magnetic). It is better to refer all bearings to the true meridian when possible, and in such a case the direction of the magnetic needle should also be shown.*

(6) The title should include a simple and complete statement giving the name of owner, place, date, and name of surveyor. An explanatory note such as a statement as to whether bearings refer to true or magnetic meridian may also be necessary. (See Art. 468, p. 415.)

150. Deed Description. — The written description of the property which is recorded in the deed should be given by bearings (or angles) and distances, stating in every case how the sides of the property are marked and whether bounded by a highway, stream, or private property, giving the name of the present owner of the adjacent property. The following is an example of a deed description of the property shown in the form of notes in Fig. 53, p. 104.

“Beginning at a point in the northerly line of Willow Road in the town of Bancroft Mills, Maine, at an iron pipe sunk in the ground at the S.E. corner of land now or formerly belonging to Nathan H. Barnes, and running along the said northerly line N 85° 34' E a distance of two hundred ninety-seven and seven-tenths (297.7) feet to the thread of channel of Stony Brook at land now or formerly belonging to James F. Hall; thence turning and running in a northerly direction, by thread of channel of said Stony Brook and land of said Hall, a distance of about three hundred and eight (308 ±) feet to a stone wall at land now or formerly belonging to Hiram Cole; thence turning and running along the middle of said stone wall and by land of said Cole

* As magnetic bearings are unreliable (Art. 28, p. 19) true bearings should be used wherever their adoption does not entail too much additional expense. In those parts of the country which have been subdivided by the U. S. General Land Office true meridians can be readily obtained from the government surveys; in many of the older (Eastern) states true meridians have been established by local authorities. If the survey can be connected with any triangulation system such as that of the United States or state surveys then, since the true bearings of all of the triangulation lines are known, the bearings of the traverse lines can be obtained.

N $86^{\circ} 45'$ W a distance of two hundred and five and eight-tenths (205.8) feet to the middle of another stone wall at land of said Barnes; thence turning and running by latter stone wall and land of said Barnes S $0^{\circ} 53'$ E a distance of one hundred and seventy-seven and two-tenths (177.2) feet to a fence; thence turning and running by said fence and land of said Barnes N $87^{\circ} 09'$ W a distance of ninety-three and three-tenths (93.3) feet to an iron pipe sunk in the ground; thence turning and running by a fence and land of said Barnes S $1^{\circ} 51'$ W a distance of one hundred and sixty-nine and four-tenths (169.4) feet to the point of beginning; all the bearings being magnetic and the parcel containing a calculated area of 79,270 square feet more or less."

It is unfortunate that the description of the property in deeds in the vast majority of cases, does not define the property in such a manner that it can be plotted from the description. Some deeds are so loosely written as to contain only the names of the owners of adjacent property, no bearings or distances being given.

151. JUDICIAL FUNCTIONS OF THE SURVEYOR. — In rerunning old property lines which have been obliterated, the surveyor is called upon to set aside temporarily his strict adherence to the mathematical side of surveying and must endeavor to find if possible **where the lines originally ran**. He should therefore be familiar with the relative importance of various evidence regarding the location of the property lines, as determined by court decisions. It is distinctly his duty to **find the position of the original boundaries** of the property and **not attempt to correct the original survey** even though he may be sure that an error exists in it. Very often it is true that, owing to the cheapness of land, the original survey was roughly made with little thought of the effect it would have when the land became valuable.

The surveyor therefore must first of all hunt for all physical evidence of the location of the boundaries * and failing in this he

* It must not be assumed that a boundary is missing because it is not at once visible. Stone bounds are often buried two or three feet deep; the top of a stake soon rots off, but evidences of the existence of the stake are often found many years after the top has disappeared, and the supposed location should be carefully dug over to find traces of the old stake. The shovel and common sense are of as much use as the transit and tape in relocating an old corner.

will base his judgment on any other reliable evidence such as occupancy or the word of competent witnesses. It is obvious that this is along equitable lines, since the property was originally purchased with reference to the actual or visible bounds which vest the owner with rights to the property bounded by these lines.

If there is a dispute between adjoining owners over the location of a boundary line this presents a question which must be settled by the courts unless the parties can come to an agreement themselves. In such cases the surveyor acts simply as an expert in judging where the line originally ran and has no power to establish a new line. He can, however, be employed by the disputing parties as an arbitrator to decide on the equitable line, but they are not necessarily obliged to accept his judgment.

If they come to an agreement between themselves, however, regarding the location of the line and occupy to that line, this agreement is binding even though no court has intervened in the matter.

It is to be assumed that the deed was drawn by the grantor with honest intent to convey the property to the grantee. It is intended then that it shall be interpreted if possible so as to make it effectual rather than void. The deed should also be construed in the light of what was known at the time when the title was transferred.

In the interpretation of a deed it is assumed that it was intended to convey property the boundaries of which will form a closed traverse. Therefore it is within the jurisdiction of the surveyor to reject any **evident** mistake in the description when running out the property line, e.g., a bearing may have been recorded in the opposite direction or an entire side omitted. Where artificial features are mentioned as boundaries, these always take precedence over the recorded measurements or angles, but these marks must be mentioned in the deed in order to have the force or authority of monuments. When the area does not agree with the boundaries as described in the deed the boundaries control. All distances unless otherwise specified are to be taken as straight lines; but distances given as so many feet along a wall or highway are supposed to follow these lines even if they are not

straight. When a deed refers to a plan the dimensions on this plan become a part of the description of the property.

Where property is bounded by a highway the abutters usually own to the center line, but where it is an accepted street each abutter yields his portion of the street for public use; if, however, the street is abandoned the land reverts to the original owners. If a street has been opened and used for a long period bounded by walls or fences, and there has been no protest regarding them, these lines hold as legal boundaries. In the case of a line between private owners acquiescence in the location of the boundary will, in general, make it the legal line. But if there is a mistake in its location and it has not been brought to the attention of the interested parties or the question of its position raised, then occupancy for many years does not make it a legal line.

Where property is bounded by a non-navigable stream it extends to the thread of the stream. If the property is described as running to the bank of a river it is interpreted to mean to the low water mark unless otherwise stated. Where original ownership ran to the shore line of a navigable river and the water has subsequently receded the proper subdivision is one that gives to each owner along the shore his proportional share of the channel of the river. These lines will therefore run, in general, perpendicular to the channel of the stream from the original intersection of division lines and shore lines.

A more complete statement of the principles mentioned above particularly with reference to the U. S. Public Land Surveys will be found in an address on "The Judicial Functions of Surveyors," by Chief-Justice Cooley of the Michigan Supreme Court, read before the Michigan Association of Engineers and Surveyors, and published in the proceedings of the society for 1882, pp. 112-122.

152. RERUNNING OLD SURVEYS FROM A DEED. — The visible marks which are mentioned in a deed are of primary importance in determining the extent of a piece of property; the lengths of the sides and the bearings (or angles), which should agree with the boundaries, are of secondary importance. It sometimes occurs, however, that all evidences of artificial bound-

aries of the property or of portions of it are missing, and the surveyor must then fall back on the dimensions given in the deed as the best information available (Art. 150, p. 115). Furthermore it is sometimes necessary to "run out" an old deed to determine which of two lines is the correct boundary, or in some cases to find how close the actual boundaries of a property agree with the original deed.

If the directions of the boundaries are defined in the deed by the magnetic bearings, as was formerly the usual custom, it is necessary first to find the declination of the needle at the date of the original survey as well as the present declination of the needle and to correct all the bearings accordingly (Art. 29, p. 20). The declination of the needle should appear on the original deed or plan; but unfortunately it seldom does, and the year the survey was made must then be obtained either from the deed, the old plan, or from witnesses, and the declination of the needle at that time computed. Observations at different places and times have been compiled by the U. S. Coast and Geodetic Survey, and these results may be found in convenient form for calculation in the annual Reports of the Superintendent, particularly the 1886 report.* From these observations the approximate change in declination may be obtained. In this way the magnetic bearings, corrected to date, can be determined as closely probably as the original bearings were taken. It is evident that the change in the declination of the needle between the date of the original survey and the present time is what is desired. If there exists therefore one well-defined line which is known to be one of the original boundary lines, a bearing taken on this line and compared with that given in the deed will determine directly the change in declination. There may be more than one well-defined line whose bearings can be obtained and a comparison of the results on these different lines will give an idea of the reliability of the original survey as well as a more accurate determination of the change in declination.

* In 1902 the U. S. Coast and Geodetic Survey issued a special publication entitled, "Magnetic Declination Tables and Isogonic Charts for 1902," in which is given a very complete list of declinations for various places in the United States.

Not infrequently in attempting to rerun old compass surveys it is found that the traverse as described in the deed does not "close," i.e., the last point does not coincide with the first. If this error of closure is small it may be due to the difference in length between the chain used for the original survey and the one being used. Before any attempt is made to run out the old survey this difference should be determined by measuring one or more of the well-defined lines of the property, if any can be found, and comparing the measurements obtained with the recorded distances.

Occasionally it is found that the traverse will not close by a large amount owing to a mistake in the original survey. Often in such cases the deeds of **adjacent** property will show what the mistake was, and in such cases it is allowable to make a correction if it will give a description that is consistent. For example, it occasionally happens that a bearing has been recorded in the reverse direction so that no area is enclosed by the boundaries. Sometimes an entire chain-length has been omitted in one of the lines and by supplying this the description is made consistent. Other inconsistencies are to be dealt with in the same general manner, or as suggested in the preceding article.

153. How to Look Up a Recorded Deed. — In all the states of the Union the transfer of real property must be recorded in the respective county Registry of Deeds or in the office of the city or town clerk. At the Registry of Deeds is kept an exact copy of the deed, which can be examined by any one. It is frequently necessary for the surveyor to make use of these copies when it is not convenient to obtain the deed from the owner of the property or when it is necessary to look up the deed of adjacent property or previous transfers of any of them.

In every Registry of Deeds an index of the deeds is kept, which is divided into two parts, the *grantor* index and the *grantee* index; the grantor being the party who sells the land and the grantee the one who buys it. These indexes are frequently divided by years and for this reason the surveyor should know not only the name of the party who bought or sold the property (both if convenient to get them), but also the approximate date of the transaction. With this information he can readily find

in the proper index the name of the party, opposite which will appear the date of the transaction and the number of the deed book and page on which the copy of the deed is recorded. He then finds the deed book, from which he can copy whatever data he desires from the deed ; usually the description of the property is all that concerns the surveyor. In the deed book is usually a reference number in the margin or in the text of the deed which refers to the next preceding transfer of the same property or to any attachments, assignments, and the like which may have been made on it. This method of indexing and filing deeds is used in the New England States and in many of the other states ; in fact the general principles are the same throughout the country although the details may differ to some extent.

THE UNITED STATES SYSTEM OF SURVEYING THE PUBLIC LANDS.*

154. THE SYSTEM.— The United States System of Surveying the Public Lands, which was inaugurated in 1784, and modified since by various acts of Congress, requires that the public lands “shall be divided by north and south lines run according to the true meridian, and by others crossing them at right angles so as to form townships six miles square,” and that the corners of the townships thus surveyed “must be marked with progressive numbers from the beginning.” Also, that the townships shall be subdivided into thirty-six sections, each of which shall contain six hundred and forty acres, as nearly as may be, by a system of two sets of parallel lines, one governed by true meridians and the other by parallels of latitude, the latter intersecting the former at right angles, at intervals of a mile.

Since the meridians converge it is evident that the require-

* The work of surveying the government lands is carried on under the direction of the Commissioner of the General Land Office. In each of the districts where such surveys are made is a Surveyor General, appointed by the President. The work is usually done under contract by experienced surveyors, called Deputies. The Deputies are paid by the mile, according to classified rates. All surveys, before being accepted, are inspected by a corps of Examiners of Surveys, who are appointed especially for this duty.

ment that the lines shall conform to true meridians and also that townships shall be six miles square, is mathematically impossible.

In order to overcome this difficulty the subdivision is carried on as follows:— (See Fig. 57.)

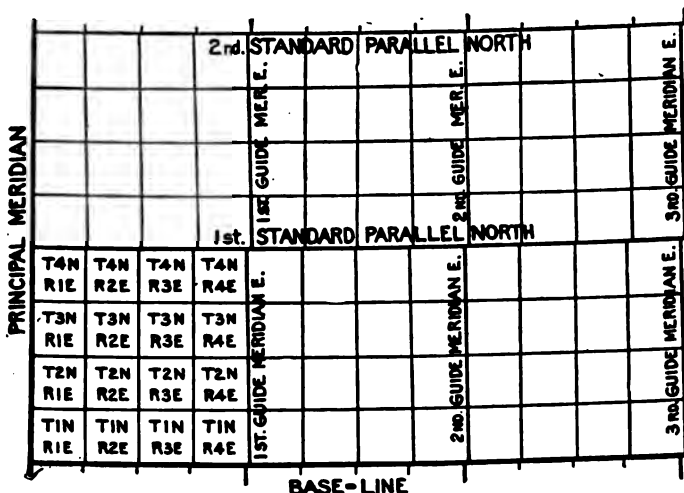

FIG. 57. DIAGRAM ILLUSTRATING MERIDIAN, BASE-LINE, STANDARD PARALLELS, RANGES, AND TOWNSHIPS.

FIRST. The establishment of a *principal meridian* conforming to the true meridian, and at right angles to it, a *base-line* conforming to a parallel of latitude, as is described in Art. 156, p. 124, and Art. 157, p. 126.

SECOND. The establishment of *standard parallels* conforming to parallels of latitude, initiated from the principal meridian at intervals of 24 miles and extended east and west of the same.

THIRD. The establishment of *guide meridians* conforming to true meridians, initiated upon the base-line and successive standard parallels at intervals of 24 miles, resulting in tracts of land 24 miles square, as nearly as may be, which shall be subsequently divided into tracts of land 6 miles square by two sets of lines, one conforming to true meridians, crossed by others conforming to parallels of latitude at intervals of 6 miles, containing 23,040 acres, as nearly as may be, and designated *townships*.

Such townships are divided into 36 tracts, called *sections*, each of which contains 640 acres, as nearly as may be, by two sets of parallel lines, one set parallel to a true meridian and the other conforming to parallels of latitude, intersecting at intervals of 1 mile, and at right angles, as nearly as may be, as shown in Fig. 57.

Any series of contiguous townships or sections situated north and south of each other constitutes a *range*, while such a series situated in an east and west direction constitutes a *tier*.

Section lines are surveyed from south to north, and from east to west, in order to place the excess or deficiency, according to the requirement of the law, on the north and west sides of the townships.

The tiers of townships are numbered, to the north or south, commencing with No. 1 at the base-line; and the ranges or townships, to the east or west, beginning with No. 1 at the principal meridian of the system.

The thirty-six sections into which a township is subdivided are numbered, commencing with No. 1 at the northeast angle of the township, and proceeding west to No. 6, and then proceeding east to No. 12, and so on, alternately, to No. 36, in the southeast angle as illustrated by Fig. 58. In all cases of surveys of fractional townships the sections will bear the same numbers they would have if the township were complete.

Standard parallels (formerly called *correction lines*) are established at intervals of 24 miles, north and south of the base line, and guide meridians at intervals of 24 miles, east and west of the principal meridians; thus confining

6	5	4	3	2	1
7	8	9	10	11	12
18	17	16	15	14	13
19	20	21	22	23	24
30	29	28	27	26	25
31	32	33	34	35	36

FIG. 58. DIAGRAM OF A TOWNSHIP ILLUSTRATING METHOD OF NUMBERING THE SECTIONS.

the errors resulting from convergence of meridians and inaccuracies in measurement within comparatively small areas.

“ 155. Initial Points.* — Initial points from which the lines of the public surveys are to be extended will be established whenever necessary, under such special instructions as may be prescribed in each case by the Commissioner of the General Land Office. The locus of such initial points will be selected with great care and due consideration for their prominence and easy identification, and must be established astronomically.

“An initial point should have a conspicuous location, visible from distant points on lines; it should be perpetuated by an indestructible monument, preferably a copper bolt firmly set in a rock edge; and it should be witnessed by rock bearings, without relying on anything perishable like wood.

“The initial point having been established the lines of public-land surveys will be extended therefrom. They are classified as follows:

“Class 1. Base lines and standard parallels.

“Class 2. Principal and guide meridians.

“Class 3. Township exteriors (or meridional and latitudinal township boundaries).

“Class 4. Subdivision and meander lines.

“Only the base line and principal meridian can pass through the initial point.

“ 156. Base Line. — From the initial point the base line will be extended east and west on a true parallel of latitude, [Art. 168, p. 148,] by the use of transit or solar instruments, as may be directed by the surveyor general in his written special instructions. The transit will be used for the alinement of all important lines.

“The direction of base lines will conform to parallels of latitude and will be controlled by true meridians; consequently the correct determination of true meridians by observations on Polaris at elongation is a matter of prime importance.

“Certain reference lines, called tangents and secants, having

* These instructions are taken from the “Manual of Surveying Instructions for the Survey of the Public Lands of the United States,” prepared by the Commissioner of the General Land Office in 1902.

a known position and relation to the required parallel of latitude, will be prolonged as straight lines. Two back and two fore sights are taken at each setting of the instrument, the horizontal limb being revolved 180° in azimuth between the observations, in one method, taking the mean of observations. Another method, called double back and fore sights, is still more exact, and therefore preferable. In this process the vertical cross-wire is fixed upon two transit points at some distance apart, in the rear, and then reversed to set one or two new points in advance. This not only insures a straight line, if the transit is leveled, but also detects the least error of collimation.

“Where solar apparatus is used in connection with a transit, the deputy will test the instrument, whenever practicable, by comparing its indications with a meridian determined by Polaris observations; and in all cases where error is discovered he will make the necessary corrections of his line before proceeding with the survey. All operations will be fully described in the field notes.

“The proper township, section, and quarter-section corners will be established at lawful intervals, and meander corners at the intersection of the line with all meanderable streams, lakes, or bayous.

“In order to detect errors and insure accuracy in measurement, two sets of chainmen will be employed; one to note distances to intermediate points and to locate topographical features, the other to act as a check. Each will measure 40 chains, and in case the difference is inconsiderable, the proper corner will be placed midway between the ending points of the two measurements; but if the discrepancy exceed 8 links on even ground, or 25 links on mountainous surface, the true distance will be found by careful re-chaining by one party or both.

“The deputy will be present when each corner is thus established, and will record in the body of his field notes the distances to the same, according to the measurement by each set of chainmen.

“To obviate collusion between the sets of chainmen, the second set should commence at a point in advance of the beginning corner of the first set, the initial difference in measurement thus obtained being known only to the deputy.

157. "Principal Meridian.— This line shall conform to a true meridian [Chapter VII] and will be extended from the initial point, either north or south, or in both directions, as the conditions may require, by the use of transit or solar instruments, as may be directed by the surveyor general in his special written instructions. The methods used for determination of directions, and the precautions to be observed to secure accuracy in measurement, are fully stated above under the title "Base Line," and will be complied with in every particular.

"In addition to the above general instructions, it is required that in all cases where the establishment of a new principal meridian seems to be necessary to the surveyor general, he shall submit the matter, together with his reasons therefor, to the Commissioner of the General Land Office, and the survey of such principal meridian shall not be commenced until written authority, together with such special instructions as he may deem necessary, shall have been received from the Commissioner.

158. "Standard Parallels.— Standard parallels, which are also called correction lines, shall be extended east and west from the principal meridian, at intervals of 24 miles north and south of the base line, in the manner prescribed for running said line, and all requirements under the title 'Base Line' will be carefully observed.

"Where standard parallels have been placed at intervals of 30 or 36 miles, regardless of existing instructions, and where gross irregularities require additional standard lines, from which to initiate new, or upon which to close old surveys, an intermediate correction line should be established to which a local name may be given, e.g., 'Cedar Creek Correction Line'; and the same will be run, in all respects, like the regular standard parallels.

159. "Guide Meridians.— Guide meridians shall be extended north from the base line, or standard parallels, at intervals of 24 miles east and west from the principal meridian, in the manner prescribed for running the principal meridian, and all the provisions for securing accuracy of alignment and measurement, found or referred to under the titles Base Line and Principal Meridian, will apply to the survey of said guide meridians.

"When existing conditions require that such guide meridians

shall be run south from the base or correction lines, they will be initiated at properly established corners on such lines, marked as closing corners.

“Where guide meridians have been improperly placed at intervals greatly exceeding the authorized distance of 24 miles, and standard lines are required to limit errors of old, or govern new surveys, a new guide meridian may be run from a standard, or properly established closing corner, and a local name may be assigned to the same, e.g., ‘Grass Valley Guide Meridian.’ These additional guide meridians will be surveyed in all respects like regular guide meridians.

160. “Township Exteriors. — Whenever practicable, the township exteriors in a block of land 24 miles square, bounded by standard lines, will be surveyed successively through the block, beginning with those of the southwestern township.

“The meridional boundaries of townships will have precedence in the order of survey and will be run from south to north on true meridians, with permanent corners at lawful distances; the latitudinal boundaries will be run from east to west on random or trial lines, and corrected back on true lines.

“The falling of a random, north or south of the township corner to be closed upon, will be carefully measured, and, with the resulting true return course, will be duly recorded in the field notes.

“Should it happen, however, that such random intersects the meridian of the objective corner, north or south of said corner, or falls short of, or overruns the length of the south boundary of the township by more than three chains (due allowance being made for convergency), said random, and, if necessary, all the exterior boundaries of the township, will be retraced and remeasured to discover and correct the error.

“When running random lines from east to west, temporary corners will be set at intervals of 40.00 chains, and proper permanent corners will be established upon the true line, corrected back in accordance with these instructions, thereby throwing the excess or deficiency against the west boundary of the township, as required by law.

“Whenever practicable, the exterior boundaries of town-

ships belonging to the west range, in a tract or block 24 miles square, will first be surveyed in succession, through the range, from south to north; and in a similar manner, the other three ranges will be surveyed in regular sequence.

“In cases where impassable obstacles occur and the foregoing rules cannot be complied with, township corners will be established as follows:

“In extending the south or north boundaries of a township to the west, where the southwest or northwest corners cannot be established in the regular way by running a north and south line, such boundaries will be run west on a true line, allowing for convergency on the west half mile; and from the township corner established at the end of such boundary, the west boundary will be run north or south, as the case may be. In extending south or north boundaries of a township to the east, where the southeast or northeast corner cannot be established in the regular way, the same rule will be observed, except that such boundaries will be run east on a true line, and the east boundary run north or south, as the case may be. Allowance for the convergency of meridians will be made whenever necessary.

161. “**Method of Subdividing.** — The exterior boundaries of a full township having been properly established so far as possible, the subdivision thereof will be made as follows:

“At or near the southeast corner of the township, a true meridian will be determined by Polaris or solar observations, and the deputy's instrument will be tested thereon; then from said corner the first mile of the east and south boundaries will be retraced, if subdivisions and survey of the exteriors have been provided for in separate contracts; but, if the survey of the exterior and subdivisional lines are included in the same contract, the retracements referred to will be omitted. All discrepancies resulting from disagreement of bearings or measurements will be carefully stated in the field notes.

“The meridional sectional lines will be made parallel to the range line or east boundary of the township, by applying to the bearing of the latter a small correction, dependent on the latitude, taken from the following table, which gives, to the

nearest whole minute, the convergency of two meridians 6 miles long and from 1 to 5 miles apart; and supplies directly the deviation of meridional section lines west of north, when the range line is a true meridian. Add the correction to the bearing of the range line, if the same is west of north, but subtract when it bears east of north.

TABLE 3.

CORRECTIONS FOR CONVERGENCY WITHIN A TOWNSHIP.

Latitude.	Correction to be applied to bearing of range lines at a distance of —				
	1 mile.	2 miles.	3 miles.	4 miles.	5 miles.
30 to 35	1	1	2	2	3
35 to 40	1	1	2	3	3
40 to 45	1	2	2	3	4
45 to 50	1	2	3	4	5
50 to 55	1	2	3	5	6
55 to 60	1	3	4	5	7
60 to 65	2	3	5	7	8
65 to 70	2	4	6	8	10

Example.—Latitude, 47°. Range line bears N. 0° 2' E. then parallel meridional section lines will be run as follows:

From the corner for sections—

- 35 and 36, N. 0° 1' E.
- 34 and 35, north.
- 33 and 34, N. 0° 1' W.
- 32 and 33, N. 0° 2' W.
- 31 and 32, N. 0° 3' W.

“After testing his instrument on the true meridian thus determined, the deputy will commence at the corner to sections 35 and 36, on the south boundary, and run a line parallel to the range line, establishing at 40.00 chains, the quarter-section corner between sections 35 and 36, and at 80.00 chains the corner for sections 25, 26, 35, and 36.

“ From the last-named corner, a random line will be run eastward, without blazing, parallel to the south boundary of section 36, to its intersection with the east boundary of the township, placing at 40.00 chains from the point of beginning, a post for temporary quarter-section corner. If the random line intersects said township boundary exactly at the corner for sections 25 and 36, it will be blazed back and established as the true line, the permanent quarter-section corner being established thereon, midway between the initial and terminal section corners.

“ When the objective corner is in sight from the starting corner, or the deputy has evidence of its location to prove that a different random course would fall closer to the corner, he may use such changed course for his random. A line may be run as a “ random for distance only,” when the course is certain.

“ If the random intersects said township boundary to the north or south of said corner, the falling will be carefully measured, and from the data thus obtained, the true return course will be calculated, and the true line blazed and established and the position of the quarter-section corner determined, as directed above.

The details of the entire operation will be recorded in the field notes.

“ Having thus established the line between sections 25 and 36, from the corner for sections 25, 26, 35, and 36, the west and north boundaries of sections 25, 24, 13, and 12, will be established as directed for those of section 36; with the exception that the random lines of said north boundaries will be run parallel to the established south boundary of section 36; e.g., the random line between sections 24 and 25 will be run parallel to the established south boundary of section 25, etc.

“ Then, from the last established section corner, i.e., the corner of sections 1, 2, 11, and 12, the line between sections 1 and 2 will be projected northward, on a random line, parallel to the east boundary of the township, setting a post for temporary quarter-section corner at 40.00 chains, to its intersection with the north boundary of the township. If the random intersects said north boundary exactly at corner for sections 1 and 2, it will be blazed back and established as the true line, the tem-

porary quarter-section corner being established permanently in its original position, and the fractional measurement thrown into that portion of the line between said corner and the north boundary of the township.

"If, however, said random intersects the north boundary of the township, to the east or west of the corner for sections 1 and 2, the consequent falling will be carefully measured, and from the data thus obtained the true return course will be calculated and the true line established, the permanent quarter-section corner being placed upon the same at 40.00 chains from the initial corner of the random line, thereby throwing the fractional-measurement in that portion lying between the quarter-section corner and the north boundary of the township.

"When the north boundary of a township is a base line or standard parallel, the line between sections 1 and 2 will be run parallel to the range line as a true line, the quarter-section corner will be placed at 40.00 chains, and a closing corner will be established at the point of intersection with such base or standard line; and in such case, the distance from said closing corner, to the nearest standard corner on such base or standard line, will be carefully measured and noted as a connection line.

"Each successive range of sections progressing to the west, until the fifth range is retained, will be surveyed in a similar manner; then, from the section corners established on the west boundary of said range of sections, random lines will be projected to their intersection with the west boundary of the township, and the true return lines established as prescribed for the survey of the first or most eastern range of sections, with the exception that on the true lines thus established the quarter-section corners will be established at 40.00 chains from the initial corners of randoms, the fractional measurements being thereby thrown into those portions of the lines situated between said quarter-section corners and the west boundary of the township.

"The following general requirements are reiterated for emphasis:

"The random of a latitudinal section line will always be run parallel to the south boundary of the section to which it belongs, and

with the true bearing of said boundary; and when a section has no linear south boundary, the random will be run parallel to the south boundary of the range of sections in which it is situated, and fractional true lines will be run in a similar manner.

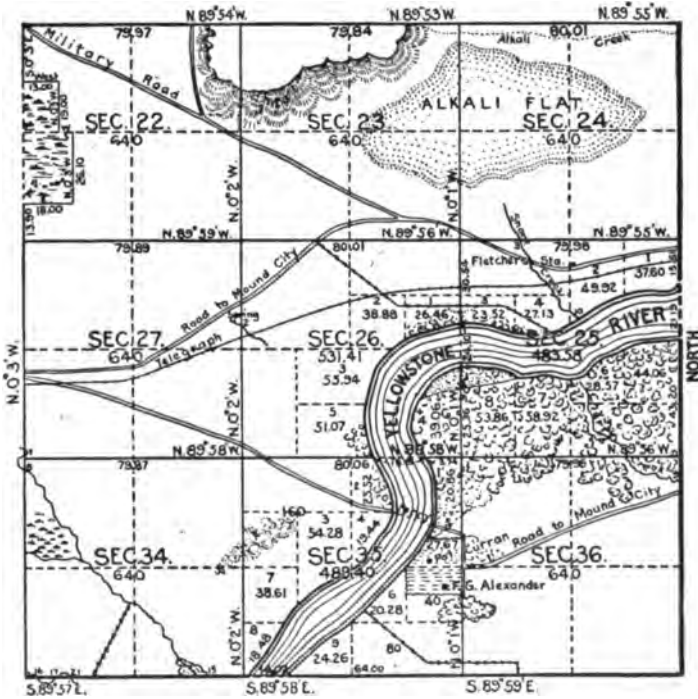

FIG. 59. PORTION OF TOWNSHIP ILLUSTRATING SUBDIVISION OF SECTIONS.

“The deputy is not required to complete the survey of the first range of sections from the south to north before commencing the survey of the second or any subsequent range of sections, but the corner on which any random line closes shall have been previously established by running the line which determines its

position, except as follows: Where it is impracticable to establish such section corner in the regular manner, it will be established by running the latitudinal section line as a true line, with a true bearing, determined as above directed for random lines, setting the quarter-section corner at 40.00 chains and the section corner at 80.00 chains.

“Quarter-section corners, both upon meridional and latitudinal section lines, will be established at points equidistant from the corresponding section corners, except upon the lines closing on the north and west boundaries of the township, and in those situations the quarter-section corners will always be established at precisely forty chains to the north or west (as the case may be) of the respective section corners from which those lines respectively start, by which procedure the excess or deficiency in the measurements will be thrown, according to law, on the extreme tier or range of quarter sections, as the case may be. (See Fig. 59.)

“Where by reason of impassable objects only a portion of the south boundary of a township can be established, an auxiliary base line (or lines, as the case may require) will be run through the portion which has no linear south boundary, first random, then corrected, connecting properly established corresponding section corners (either interior or exterior) and as far south as possible; and from such line or lines, the section lines will be extended northwardly in the usual manner, and any fraction south of said line will be surveyed in the opposite direction from the section corners on the auxiliary base thus established.

“Where by reason of impassable objects or other reasons no part of the south boundary of a township can be regularly established, the subdivision thereof will proceed from north to south and from east to west, thereby throwing all fractional measurements and areas against the west boundary, and the meanderable stream or other boundary limiting the township on the south.

“If the east boundary is without regular section corners and the north boundary has been run eastwardly as a true line, with section corners at regular intervals of 80.00 chains, the subdivision of the township will be made from west to east, and

fractional measurements and areas will be thrown against the irregular east boundary.

“When the proper point for the establishment of a township or section corner is inaccessible, and a witness corner can be erected upon each of the two lines which approach the same, at distances not exceeding twenty chains therefrom, said witness corners will be properly established, and the half miles upon which they stand will be recognized as surveyed lines.

“The witness corner will be marked as conspicuously as a section corner, and bearing trees will be used wherever possible.

“The deputy will be required to furnish good evidence that the section corner is actually inaccessible.

“Where impassable precipices, deep canyons, or lands otherwise quite unsurveyable, prevent the extension of regular lines, deputies are not authorized to set meander corners, nor to meander the line separating lands that can be traversed from those that cannot. In place of meandering, they are to set witness corners on line, near the intersection of section lines with the brink or foot of the impassable cliffs, or at the margin of the impracticable marsh, to represent an inaccessible regular section or quarter-section corner if within twenty chains. Such quarter sections thus marked may be platted as surveyed.

“Where a large or desirable track is found to have its accessible section lines too short to justify the erection of such witness corners, and to render it regularly surveyed, offset lines may be run on lines of legal subdivision, far enough to show, by necessary witness corners, the 40-acre tracts that would otherwise have been excluded from survey.

“The topographic sketches of mesas and impassable canyon regions, returned by deputies, will show as nearly as practicable the location of these features and their margins; and where possible the corners on opposite sides of a canyon should be connected by triangulation at least once in each township.

162. “**Meandering.**—The running of meander lines has always been authorized in the survey of public lands fronting on large streams and other bodies of water, but does not appear to have been proper in other cases. The mere fact that an irregular or sinuous line must be run, as in case of a reservation bound-

ary, does not entitle it to be called a meander line except where it closely follows a stream or lake shore. The legal riparian rights connected with meandered lines do not apply in case of other irregular lines, as the latter are strict boundaries.

“Lands bounded by waters are to be meandered at mean high-water mark. This term has been defined in a State decision (47 Iowa, 370) in substance as follows: High water mark in the Mississippi River is to be determined from the river-bed; and that only is river-bed which the river occupies long enough to wrest it from vegetation.

“In another case (14 Penn. St. 59) a bank is defined as the continuous margin where vegetation ceases, and the shore is the sandy space between it and low-water mark.

“Numerous decisions in State and U. S. Supreme Courts, assert the principle that meander lines are not boundaries defining the area of ownership of tracts adjacent to waters. The general rule is well set forth (10 Iowa, 549) by saying that in a navigable stream, as the Des Moines River in Iowa, high-water mark is the boundary line. When by action of the water the river bed changes, high-water mark changes and ownership of adjoining land changes with it. The location of meander lines does not affect the question.

“Inasmuch as it is not practicable in public land surveys to meander in such a way as to follow and reproduce all the minute windings of the high-water line, the U. S. Supreme Court has given the principles governing the use and purpose of meandering shores, in its decision in a noted case (*R. R. Co. v. Schurmeier*, 7 Wallace, 286-7) as follows:

“In cases where the deputy finds it impossible to carry his meander line along mean high-water mark, his notes should state

“Meander lines are run in surveying fractional portions of the public lands bordering on navigable rivers, not as boundaries of the tract, but for the purpose of defining the sinuosities of the banks of the stream, and as the means of ascertaining the quantity of land in the fraction subject to sale, which is to be paid for by the purchaser. In preparing the official plat from the field notes, the meander line is represented as the border line of the stream, and shows to a demonstration that the water-course, and not the meander line as actually run on the land, is the boundary.

the distance therefrom, and the obstacles which justify the deviation.

“Proceeding down stream, the bank on the left hand is termed the left bank and that on the right hand the right bank. These terms will be universally used to distinguish the two banks of a river or stream.

“Navigable rivers, as well as all rivers not embraced in the class denominated ‘navigable,’ the right-angle width of which is three chains and upwards, will be meandered on both banks, at the ordinary mean high-water mark, by taking the general courses and distances of their sinuosities, and the same will be entered in the field book. Rivers not classed as navigable will not be meandered above the point where the average right-angle width is less than three chains, except that streams which are less than three chains wide and which are so deep, swift, and dangerous as to be impassable through the agricultural season, may be meandered, where good agricultural lands along the shores require their separation into fractional lots for the benefit of settlers. But such meander surveys shall be subject to rejection if proved unnecessary by field inspection.

“Shallow streams, without any well-defined channel or permanent banks, will not be meandered ; except tide-water streams, whether more or less than three chains wide, which should be meandered at ordinary high-water mark, as far as tide-water extends.

“At every point where either standard, township, or section lines intersect the bank of a navigable stream, or any meanderable shore, corners will be established at the time of running these lines. Such corners are called meander corners, and the deputy will commence at one of these corners, follow the bank or boundary line, and take the bearing and measure the length of each course, from the beginning corner to the next meander corner.

“All courses reported are to be compass courses, taken or counted from the meridian, and not from a latitudinal line ; and ‘transit angles’ showing only the amount of deviation from the preceding course, are not allowed in field notes of meanders.

“For convenience of testing by traverse, the courses of

meander lines should be given by the nearest quarter degree. As meandered lines are not strict boundaries, this method will give results with approximate accuracy for good closings within the limits of a section. Meander lines will be examined in the field as well as rectangular lines, before acceptance.

“All meanders should be traversed before leaving the vicinity, and if misclosure is found, indicating error in measurement or in reading courses, the lines must be re-meandered.

“The crossing distance between meander corners on same line, and the true bearing and distance between corresponding meander corners, will be ascertained by triangulation or direct measurement, in order that both shores may be protracted. The particulars will be given in the field notes.

“For convenience of platting and computation, the deputy is required to use in meanders distances having whole chains, or multiples of ten links, with odd links only in closing distances.

“The meanders of all lakes, navigable bayous, and deep ponds of the area of twenty-five acres and upwards, will be commenced at a meander corner and continued, as above directed for navigable streams; from said corner, the courses and distances of the entire margin of the same, and the intersections with all meander corners established thereon, will be noted.

“All streams falling into the river, lake, or bayou will be noted, and the width at their mouths stated; also, the position, size, and depth of springs, whether the water be pure or mineral; also, the heads and mouths of all bayous; all islands, rapids, and bars will be noted, with intersections to their upper and lower ends, to establish their exact situation. The elevation of the banks of lakes, bayous, and streams, the height of falls and cascades, and the length and fall of rapids will be recorded in the field notes.

“To meander a lake or deep pond lying entirely within the boundaries of a section, two lines will be run from the two nearest corners on different sides of such lake or pond, the courses and lengths of which will be recorded, and if coincident with unsurveyed lines of legal subdivisions, that fact will also be stated in the field notes, and at each of the points where said lines intersect the margin of the pond or lake, a special meander corner will be established as above directed.

“A special meander corner is one established on a line of legal subdivision, not a standard, township, or section line.

“The relative position of these points being thus definitely fixed in the section, the meandering will commence at one of them and be continued to the other, noting the intersection, and thence to the beginning. The proceedings are to be fully entered in the field notes.

“Meander lines will not be established at the segregation line between dry and swamp or overflowed land, but at the ordinary high-water mark of the actual margin of the rivers or lakes on which such swamp or overflowed lands border.

“The precise relative position of an island, in a township made fractional by a river or lake in which the island is situated, will be determined by triangulation from a special and carefully measured base line, initiated upon the surveyed lines, on or near the lake or river bank on the mainland, so as to connect by course and distance on a direct line, the meander corner on the mainland with the corresponding point on the island, where the proper meander corner will be established.

“In making the connection of an island lying entirely within a section, with the mainland, a special base will be measured from the most convenient meander corner, and from such base, the location of an auxiliary meander corner (that is, one not on a line belonging to the system of rectangular surveying) will be determined by triangulation, at which the meanders of the island will be initiated.

“In the survey of lands bordering on tide waters, meander corners may be temporarily set at the intersection of the surveyed lines with the line of mean high tide, but no monument should be placed in a position exposed to the beating of waves and the action of ice in severe weather. In all such cases, the rule given in section 90 must be observed, by establishing a witness corner on line at a secure point near the true point for the meander corner.

“The field notes of meanders will show the dates on which the work was performed.
 The field notes of meanders will state and describe the corner from which the meanders commenced, and upon

which they closed, and will exhibit the meanders of each fractional section separately; following, and composing a part of such notes, will be given a description of the land, timber, depth of inundation to which the bottom is subject, and the banks, current, and bottom of the stream or body of water meandered. The utmost care will be taken to pass no object of topography, or change therein, without giving a particular description thereof in its proper place in the notes of the meanders.

163. "Summary of objects and data intersected by the line or in its vicinity, to be noted. — 1. The precise course and length of every line run, noting all necessary offsets therefrom, with the reason for making them, and method employed.

" 2. The kind and diameter of all bearing trees, with the course and distance of the same from their respective corners; and the precise relative position of witness corners to the true corners.

" 3. The kind of materials of which corners are constructed.

" 4. Trees on line. The name, diameter, and distance on line to all trees which it intersects.

" 5. Intersections by line of land objects. The distance at which the line intersects the boundary lines of every reservation, town site, donation claim, Indian allotment, settler's claim, improvement, or rancho; prairie, bottom land, swamp, marsh, grove, and windfall, with the course of the same at all points of intersection; also, the distances at which the line begins to ascend, arrives at the top, begins to descend, and reaches the foot of all remarkable hills and ridges, with their courses, and estimated height in feet, above the level land of the surrounding country, or above the bottom lands, ravines, or waters near which they are situated. Also, distance to and across large ravines, their depth and course.

" 6. Intersections by line of water objects. All rivers, creeks, and smaller streams of water which the line crosses; the distances measured on the true line to the bank first arrived at, the course down stream at points of intersection, and their widths on line. In cases of navigable streams, their width will be ascertained between the meander corners, as set forth under the proper head.

" 7. The land's surface — whether level, rolling, broken, hilly, or mountainous.

" 8. The soil — whether rocky, stony, sandy, clay, etc., and also whether first, second, third, or fourth rate.

" 9. Timber — the several kinds of timber and undergrowth, in the order in which they predominate.

" 10. Bottom lands — to be described as wet or dry, and if subject to inundation, state to what depth.

" 11. Springs of water — whether fresh, saline, or mineral, with the course of the streams flowing from them.

" 12. Lakes and ponds — describing their banks and giving their height, and whether it be pure or stagnant, deep or shallow.

" 13. Improvements. Towns and villages; houses or cabins, fields, or other improvements with owners' names; mill sites, forges, and factories, U. S. mineral monuments, and all corners not belonging to the system of rectangular surveying; will be located by bearing and distance, or by intersecting bearings from given points.

" 14. Coal banks or beds; peat or turf grounds; minerals and ores; with particular description of the same as to quality and extent, and all diggings therefor; also salt springs and licks. All reliable information that can be obtained respecting these objects, whether they be on the line or not, will appear in the general description.

" 15. Roads and trails, with their directions, whence and whither.

" 16. Rapids, cataracts, cascades, or falls of water, with the estimated height of their fall in feet.

" 17. Precipices, eaves, sink holes, ravines, remarkable crags, stone quarries, ledges of rocks, with the kind of stone they afford.

" 18. Natural curiosities, interesting fossils, petrifications, organic remains, etc.; also all ancient works of art, such as mounds, fortifications, embankments, ditches or objects of like nature.

" 19. The magnetic declination will be incidentally noted at all points of the lines being surveyed, where any material change in the same indicates the probable presence of iron ores; and

the position of such points will be perfectly identified in the field notes.

164. **“Prescribed Limits for Closings and Lengths of Lines.** — If in running a random township exterior, such random exceeds or falls short of its proper length by more than three chains, allowing for convergency, or falls more than three chains to the right or left of the objective point (or shows a proportionate error for lines of greater or less length than six miles), it will be re-run, and if found correctly run, so much of the remaining boundaries of the township will be retraced, or resurveyed, as may be found necessary to locate cause of misclosure.

“Every meridional section line, except those which terminate upon a fractional side of a township, will be 80 chains in length, without allowance of 50 links per mile for difference of measure, or any other allowance beyond a small reasonable discrepancy according to the nature of the surface, to be determined after examination.

“The random meridional or latitudinal lines through a tier or range of fractional sections shall fall within 50 links of the objective corners, and a greater falling will indicate negligence or error.

“The actual lengths of meridional section lines through a fractional north or south tier of sections shall be within 150 links of their theoretical length. The latter will be determined from the given lengths of meridional boundaries on the east and the west range lines.

“Each latitudinal section line, except in a fractional east or west range of sections, shall be within 50 links of the actual distance established on the governing north or south boundary of the township for the width of the same range of sections.

“The north boundary and the south boundary of any section, except in a fractional range, shall be within 50 links of equal length.

“The meanders within each fractional section or between any two successive meander corners, or of an island or lake in the interior of a section, should close by traverse within a limit to be determined by allowing five-eighths of a link for each chain

of such meander line. This rule does not apply to irregular boundaries of reservations or private claims, except as far as the same are natural water boundaries. The total misclosure of meanders will not be permitted to exceed 150 links, except in large private land claims, which are governed by a different rule and limit.

“In closing upon accepted surveys, when irregularities beyond the allowable limits are developed, either in the length or direction of the closing lines, closing corners will be set, with quarter-section corners at 40 chains from the last interior section corner ;

“And, in general, when conditions are met which result in a random line being defective, either in length or direction, such procedure will be adopted as will secure the greatest number of new rectangular legal subdivisions, without disturbing the condition of accepted surveys.

165. “**Field Notes.**—The proper blank books for original field notes will be furnished by the surveyor general, and in such books the deputy surveyor will make a faithful, distinct, and minute record of everything done and observed by himself and his assistants, pursuant to instructions, in relation to running, measuring, and marking lines, establishing corners, etc., and present, as far as possible, full and complete topographical sketches of all standard and exterior lines, drawn to the usual scale of township exteriors. These ‘original field notes’ are not necessarily the entries made in the field, in the deputy’s pocket note books called tablets ; but they are to be fully and correctly written out in ink, from such tablets, for the permanent record of the work. Tablets should be so fully written as to verify the original field notes whenever the surveyor general requires them for inspection.

“A full description of all corners belonging to old surveys, from which the lines of new surveys start, or upon which they close, will in all cases be furnished the deputy from the surveyor general’s office, when authority is given for commencing work ; then, if the old corners are found to agree with said descriptions, the deputy will describe any one of them in this form, ‘which is a —— firmly set, marked and witnessed as described

by the surveyor general ;' but, should a corner not answer the description supplied, the deputy will give a full description of such corner and its accessories, following the proper approved form given in these instructions.

"A full description of each corner established under any one contract will be given once only ; subsequent reference to such corner will be made in the form, 'heretofore described,' or 'the corner of sections 2, 3, 10, and 11,' as the case may require.

"In all cases where a corner is reestablished, the field notes will describe fully the manner in which it is done.

"The field notes of the survey of base, standard, and meridian lines will describe all corners established thereon, how established, the crossings of streams, ravines, hills, and mountains ; character of soil, timber, minerals, etc. ; and after the description of each township corner established in running such lines, the deputy will note particularly in the 'general description' the character of townships on each side of the lines run.

"The field notes of the survey of exterior boundaries of townships will describe the corners and topography, as above required, and the 'general description' at the end of such notes will describe the townships as fully as possible, and also state whether or not they should be subdivided.

"The field notes of the subdivisational survey of townships will describe the corners and topography as above required, and the 'general description' at the end of such notes will state minutely the character of the land, soil, timber, etc., found in such townships.

"The topography will be given on the true line in all cases, and will be taken correctly, not estimated or approximated.

"With the field notes of the survey of base lines and standard parallels, and principal and guide meridians forming a tract 24 miles square, including those of the township exteriors therein, the deputy will submit a diagram of the lines surveyed, drawn to a scale of half an inch to one mile, upon which will be written the true bearings and lengths of all surveyed lines, except the lengths of those which are actually 40.00 or 80.00 chains. These diagrams will exhibit all water courses, with the direction of each indicated by an arrow head pointing down stream ; also,

the intersection of the lines with all prairies, marshes, swamps, ravines, lakes, ponds, mountains, hills, and all other natural or artificial topographical features mentioned in the field notes, to the fullest extent possible.

“With the special instructions for making subdivisional surveys of townships into sections, the deputy will be furnished by the surveyor general with blank township diagrams drawn to a scale of one inch to forty chains, upon which the true bearings and lengths of the township and section lines, from which the surveys are to be projected, or upon which they are to close, will be carefully marked; and on such diagrams the deputy who subdivides will make appropriate sketches of the various objects of topography as they occur on his lines, so as to exhibit not only the points of intersection therewith, but also the directions and relative positions of such objects between the lines, or within each section, as far as practicable, so that every topographical feature may be properly completed and connected in the showing.

“Triangulations, offsets, or traverses, made to determine distances that cannot be directly measured, such as those over deep streams, lakes, impassable swamps, cañons, etc., will be made on the random lines, when random lines are run. All particulars will be fully stated in the field notes.

“The exhibition of every mile of surveying, whether on standard, township, or subdivision lines, and the meanders in each section, will be complete in itself, and will be separated from other records by a black line drawn across that part of the page containing the body of notes. The description of the surface, soil, minerals, timber, undergrowth, etc., on each mile of line will follow the notes of survey of such line, and not be mingled with them.

“Particular care will be taken to record at the end of each mile the number of chains of mountainous land, heavily timbered land, or land covered with dense undergrowth.

“The date of each day's work will immediately follow the notes thereof.

“Near the end of the field notes of exteriors and immediately before the ‘general description,’ the deputy surveyor will add,

in the form shown in the specimen field notes, a tabular statement of the latitude and departure of all boundary lines of the township, derived from a traverse table, and will give the totals, and the errors in latitude and departure; said errors shall in no case exceed three chains, the prescribed limit for the falling of the random north boundary of a township. If a part or the whole of one or more boundaries is made up of meander lines, the northings, southings, eastings, and westings of the full section lines, nearest said meanders, will replace the missing N., S., E., or W. township lines, as the case may require, thereby presenting the errors of said boundaries of a closed survey.

“If all the exterior lines have been surveyed by the deputy, the bearings and distances for the table will be taken from his own notes. In a case where some of the boundaries have been surveyed under another contract, the deputy will use the bearings and distances supplied by the surveyor general, in connection with those of his own lines; and, if errors exceed the allowance of three chains, specified in paragraph 1 of the “Prescribed Limits,” the deputy will determine by retracement where the error occurs, correct the same before he leaves the field, and place the table in his original field notes.

“Besides the ordinary notes taken on line (and which will always be written down on the spot, leaving nothing to be supplied by memory), the deputy will subjoin, at the conclusion of his book, such further description or information touching any matter or thing connected with the township (or other) survey which he may be able to afford, and may deem useful or necessary to be known — with a general description of the township in the aggregate, as respects the face of the country, its soil and geological features, timber, minerals, waters, settlements, etc.

“Following the general description of the township will be placed ‘A list of the names of the individuals employed to assist in running, measuring, and marking the lines and corners described in the foregoing field notes of township No. _____ of the base line of range No. _____ of the _____ meridian, showing the respective capacities in which they acted.’”

SPECIMEN OF FIELD NOTES.

SUBDIVISION OF T. 15 N., R. 20 E.

- Chains. I commence at the cor. of secs. 1, 2, 35, and 36, on the S. bdy. of the Tp., which is a sandstone, $6 \times 8 \times 5$ ins. above ground, firmly set, and marked and witnessed as described by the surveyor general.
- Thence I run
N. 0° or' W., bet. secs. 35 and 36.
Over level bottom land.
- 4.50 Wire fence, bears E. and W.
20.00 Enter scattering cottonwood timber, bears E. and W. F. G. Alexander's house bears N. 28° W.
29.30 Leave scattering cottonwoods, bearing E. and W.; enter road, bears N. SE. cor. of F. G. Alexander's field; thence along west side of road.
39.50 To crossroads, bears E. to Mound City; N. to Lake City. F. G. Alexander's house bears S. 40° W. The $\frac{1}{4}$ sec. cor. point will fall in road; therefore
Set a cedar post, 3 ft. long, 3 ins. sq., with quart of charcoal, 24 ins. in the ground, for witness cor. to $\frac{1}{4}$ sec. cor., marked W C $\frac{1}{4}$ S 35 on W. and 36 on E. face; dig pits, $18 \times 18 \times 12$ ins. N. and S. of post, 3 ft. dist.; and raise a mound of earth, $3\frac{1}{2}$ ft. base, $1\frac{1}{2}$ ft. high. W. of cor.
- 40.00 Point for $\frac{1}{4}$ sec. cor. in road.
Deposit a marked stone, 24 ins. in the ground, for $\frac{1}{4}$ sec. cor.
The SE. cor. of Pat. Curran's field bears W., 5 lks. dist.
- 40.50 Set a limestone, $15 \times 8 \times 6$ ins. 10 ins. in the ground, for witness cor. to $\frac{1}{4}$ sec. cor., marked W C $\frac{1}{4}$ S on W. face; dig pits, $18 \times 18 \times 12$ ins. N. and S. of stone, 3 ft. dist.; and raise a mound of earth, $3\frac{1}{2}$ ft. base, $1\frac{1}{2}$ ft. high, W. of cor.
Thence along E. side of field.
- 50.50 NE. cor. of Pat. Curran's field, bears W. 4 lks. dist.
51.50 Leave road; which turns to N. 70° W., leads to ferry on Yellowstone River; thence to Lake City.
- 57.50 Enter dense cottonwood and willow undergrowth, bears N. 54° E. and S. 54° W.
72.50 Leave undergrowth, enter scattering timber, bears N. 60° E. and S. 60° W.
- 80.00 Set a locust post, 3 ft. long, 4 ins. sq., 24 ins. in the ground, for cor. of secs. 25, 26, 35 and 36, marked
T 15 N S 25 on NE.,
R 20 E S 36 on SE.,
S 35 on SW., and
S 26 on NW. face; with 1 notch on S. and E. faces; from which
An ash, 13 ins. diam., bears N. 22° E., 26 lks. dist., marked T 15 N R 20 E S 25 B T.
A sycamore, 23 ins. diam., bears S. $71\frac{1}{4}^\circ$ E., 37 lks. dist., marked T 15 N R 20 E S 36 B T.
A walnut, 17 ins. diam., bears S. 64° W., 41 lks. dist., marked T 15 N R 20 E S 35 B T.
A cottonwood, 13 ins. diam., bears N. $21\frac{1}{4}^\circ$ W., 36 lks. dist. marked T 15 N R 20 E S 26 B T.
- Last 20.00 chs. of this mile subject to overflow, 2 to 4 ft. deep.
Land, level bottom.
Soil, alluvial; 1st rate. No stones were obtainable.
Timber, scattering cottonwood, sycamore, ash, and walnut; undergrowth, cottonwood and willow.
Dense undergrowth, 15.00 chs.

166. Marking the Corners. — After the positions of the corners are determined they are marked according to instructions issued by the Land Office. The character of the monuments set will depend upon the kind of corner to be marked, the character of the country, and the existing conditions. There are fourteen different classes of corners, as follows :

1. Standard township corners.
2. Closing township corners.
3. Corners common to four townships.
4. Corners common to two townships only.
5. Corners referring to one township only.
6. Standard section corners.
7. Closing section corners.
8. Corners common to four sections.
9. Corners common to two sections only.
10. Corners referring to one section only.
11. Quarter-section corners.
12. Standard quarter-section corners.
13. Meandered corners.
14. Corners on reservation or other boundaries not conforming to the regular system.

There are eight different classes of monuments allowed, depending upon the character of the country and the difficulty of transportation.

1. Stone, with pits and mounds of earth.
2. Stone, with mounds of stone.
3. Stone, with bearing trees.
4. Post, with pits and mounds of earth.
5. Post, with bearing trees.
6. Mound of earth, with deposit, and stake in pit.
7. Tree corner, with pits and mounds of earth.
8. Tree corner, with bearing trees.

There are many details in regard to the proper marking of corners which can only be learned by experience in this kind of surveying.

167. TO ESTABLISH A PARALLEL OF LATITUDE.— A parallel of latitude on the surface of a sphere is a curved line. This may be understood from the facts that the meridians converge toward the pole, and that a parallel is at every point at right angles to the meridian at that point. If vertical lines are drawn through every point on a parallel of latitude they will form a conical surface, the apex of the cone being at the center of the sphere. In the case of a straight line all of the verticals would lie in the same plane, and this plane would intersect the sphere in a great circle.

A parallel of latitude may be run out by means of the solar attachment to the transit, since by means of this instrument the direction of the meridian may be quickly found whenever the sun is visible (Art. 85, p. 66). A line which at every point is at right angles to the meridian will be a true parallel of latitude. This method, however, is found to give results less accurate than are required, chiefly on account of the errors in the adjustment of the solar attachment.

A better method of establishing a parallel is by taking offsets from a straight line. Two methods of doing this, known as the *Secant Method* and the *Tangent Method*, are used in the Public Land Surveys.

168. The Secant Method.—(Fig. 60.) " This method consists of running a connected series of straight lines, each six miles long,

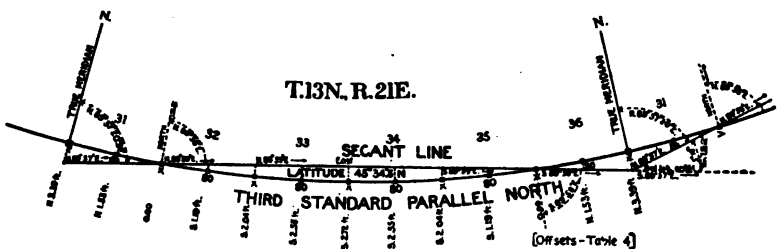

FIG. 60. SECANT METHOD FOR ESTABLISHING A PARALLEL OF LATITUDE.

on such courses that any one of the lines will intersect the curve of the parallel of latitude in two points, separated by an interval of four miles; and from this line thus established, measuring north

TABLE 4.

AZIMUTHS OF THE SECANT, AND OFFSETS, IN FEET, TO THE PARALLEL.

Latitude in left-hand column and distance from starting point at top or bottom of the table.

Latitude	Azimuths and offsets at —						Deflection Angle and nat. tan. to Rad. 66 ft.	
	0 miles.	½ mile.	1 mile.	1½ miles.	2 miles.	2½ miles.		3 miles.
30	89° 58' 5 1.93 N.	89° 58' 7 0.87 N.	89° 59' 0 0.00	89° 59' 2 0.67 S.	89° 59' 5 1.15 S.	89° 59' 7 1.44 S.	90° (E. or W.) 1.54 S.	3' 00'' 2 0.69 ins.
31	89° 58' 4 2.01 N.	89° 58' 6 0.91 N.	89° 58' 9 0.00	89° 59' 2 0.70 S.	89° 59' 5 1.20 S.	89° 59' 7 1.50 S.	90° (E. or W.) 1.60 S.	3' 07'' 4 0.72 ins.
32	89° 58' 4 2.09 N.	89° 58' 6 0.94 N.	89° 58' 9 0.00	89° 59' 2 0.73 S.	89° 59' 5 1.25 S.	89° 59' 7 1.56 S.	90° (E. or W.) 1.67 S.	3' 15'' 0 0.75 ins.
33	89° 58' 3 2.17 N.	89° 58' 5 0.97 N.	89° 58' 8 0.00	89° 59' 1 0.76 S.	89° 59' 4 1.30 S.	89° 59' 7 1.62 S.	90° (E. or W.) 1.73 S.	3' 22'' 6 0.78 ins.
34	89° 58' 2 2.25 N.	89° 58' 5 1.01 N.	89° 58' 8 0.00	89° 59' 1 0.79 S.	89° 59' 4 1.35 S.	89° 59' 7 1.69 S.	90° (E. or W.) 1.80 S.	3' 30'' 4 0.81 ins.
35	89° 58' 2 2.33 N.	89° 58' 5 1.05 N.	89° 58' 8 0.00	89° 59' 1 0.82 S.	89° 59' 4 1.40 S.	89° 59' 7 1.75 S.	90° (E. or W.) 1.87 S.	3' 38'' 4 0.84 ins.
36	89° 58' 1 2.42 N.	89° 58' 4 1.09 N.	89° 58' 7 0.00	89° 59' 0 0.85 S.	89° 59' 4 1.46 S.	89° 59' 7 1.82 S.	90° (E. or W.) 1.94 S.	3' 46'' 4 0.87 ins.
37	89° 58' 0 2.51 N.	89° 58' 3 1.13 N.	89° 58' 6 0.00	89° 58' 9 0.88 S.	89° 59' 3 1.51 S.	89° 59' 7 1.89 S.	90° (E. or W.) 2.01 S.	3' 55'' 0 0.90 ins.
38	89° 58' 0 2.61 N.	89° 58' 3 1.17 N.	89° 58' 6 0.00	89° 58' 9 0.91 S.	89° 59' 3 1.56 S.	89° 59' 7 1.95 S.	90° (E. or W.) 2.08 S.	4' 03'' 6 0.93 ins.
39	89° 57' 9 2.70 N.	89° 58' 2 1.21 N.	89° 58' 6 0.00	89° 58' 9 0.94 S.	89° 59' 3 1.62 S.	89° 59' 7 2.02 S.	90° (E. or W.) 2.16 S.	4' 12'' 6 0.97 ins.
40	89° 57' 8 2.79 N.	89° 58' 1 1.25 N.	89° 58' 5 0.00	89° 58' 9 0.98 S.	89° 59' 3 1.68 S.	89° 59' 7 2.10 S.	90° (E. or W.) 2.24 S.	4' 21'' 6 1.00 ins.
41	89° 57' 7 2.89 N.	89° 58' 0 1.30 N.	89° 58' 4 0.00	89° 58' 8 1.02 S.	89° 59' 2 1.74 S.	89° 59' 6 2.17 S.	90° (E. or W.) 2.32 S.	4' 31'' 2 1.04 ins.
42	89° 57' 7 3.00 N.	89° 58' 0 1.35 N.	89° 58' 4 0.00	89° 58' 8 1.05 S.	89° 59' 2 1.80 S.	89° 59' 6 2.25 S.	90° (E. or W.) 2.40 S.	4' 40'' 8 1.08 ins.
43	89° 57' 6 3.11 N.	89° 58' 0 1.40 N.	89° 58' 4 0.00	89° 58' 8 1.08 S.	89° 59' 2 1.86 S.	89° 59' 6 2.33 S.	90° (E. or W.) 2.48 S.	4' 50'' 8 1.12 ins.
44	89° 57' 5 3.22 N.	89° 57' 9 1.45 N.	89° 58' 3 0.00	89° 58' 7 1.12 S.	89° 59' 2 1.93 S.	89° 59' 6 2.41 S.	90° (E. or W.) 2.57 S.	5' 01'' 0 1.16 ins.
45	89° 57' 4 3.33 N.	89° 57' 8 1.50 N.	89° 58' 3 0.00	89° 58' 7 1.16 S.	89° 59' 1 2.00 S.	89° 59' 5 2.49 S.	90° (E. or W.) 2.66 S.	5' 11'' 8 1.20 ins.
46	89° 57' 3 3.44 N.	89° 57' 7 1.55 N.	89° 58' 2 0.00	89° 58' 6 1.21 S.	89° 59' 1 2.07 S.	89° 59' 5 2.59 S.	90° (E. or W.) 2.76 S.	5' 22'' 8 1.24 ins.
47	89° 57' 2 3.57 N.	89° 57' 6 1.61 N.	89° 58' 1 0.00	89° 58' 6 1.25 S.	89° 59' 1 2.14 S.	89° 59' 5 2.67 S.	90° (E. or W.) 2.86 S.	5' 34'' 2 1.28 ins.
48	89° 57' 1 3.70 N.	89° 57' 5 1.66 N.	89° 58' 0 0.00	89° 58' 5 1.30 S.	89° 59' 0 2.22 S.	89° 59' 5 2.78 S.	90° (E. or W.) 2.96 S.	5' 46'' 2 1.33 ins.
49	89° 57' 0 3.82 N.	89° 57' 5 1.72 N.	89° 58' 0 0.00	89° 58' 5 1.34 S.	89° 59' 0 2.30 S.	89° 59' 5 2.87 S.	90° (E. or W.) 3.06 S.	5' 58'' 6 1.38 ins.
50	89° 56' 9 3.96 N.	89° 57' 4 1.78 N.	89° 57' 9 0.00	89° 58' 4 1.39 S.	89° 59' 0 2.38 S.	89° 59' 5 2.97 S.	90° (E. or W.) 3.17 S.	6' 11'' 4 1.43 ins.
Latitude.	6 miles.	5½ miles.	5 miles.	4½ miles.	4 miles.	3½ miles.	3 miles.	Deflection Angle and nat. tan. to Rad. 66 ft.
	Azimuths and offsets at —							

or south, as the case may be, to attain other required points on the latitude curve." The 0 and 6 mile points of a parallel will be north of the secant, and the 2, 3, and 4 mile points will be south of the secant.

The instrument is set up south of the township corner where the survey is to begin, the distance from the corner being found in Table 4 in the column headed "0 miles." For example, in latitude 40° the transit would be set 2.79 ft. south of the corner. The direction of the first secant at its initial point is found by observing on Polaris (Chapter VII) to obtain the true meridian and then laying off the azimuth angle found in Table 4 under "0 miles." (See Fig. 60.) This angle should be repeated several times to determine accurately the direction of the secant. This direction is then prolonged 6 miles. At each mile and half-mile point an offset is measured to establish a point on the curve, the distance and direction of the offset being shown in Table 4. When the 6-mile point is reached the direction of a new secant is found by turning off to the north the deflection angle given in the right-hand column of Table 4. The offsets are then measured from this line as from the preceding one. The chief advantage

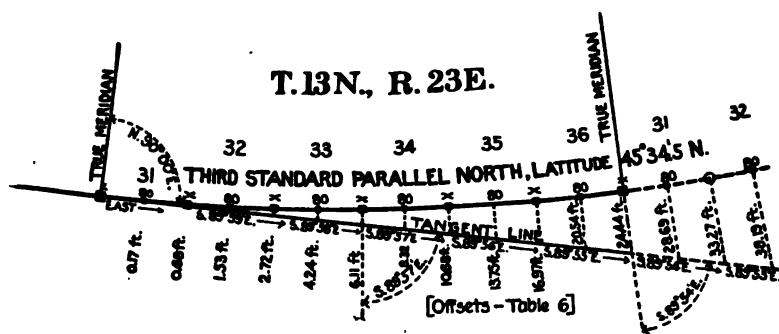

FIG. 61. TANGENT METHOD FOR ESTABLISHING A PARALLEL OF LATITUDE.

of this method is that the offsets are short and hence much cutting is saved in wooded regions.

169. "Tangent Method. — This method consists in laying off from a true meridian, established by observations on Polaris at elongation, an angle of 90°, producing the direction thus

determined, a distance of 6 miles, in a straight line, and measuring north therefrom, at half-mile intervals, distances of correct length, taken from Table 6 (interpolated if necessary), for the given latitude, to attain other points on the latitude curve passing through the tangential or initial points.

“The azimuth or bearing of the tangent at successive mile points will be taken from Table 5 to the nearest whole minute only, and will be inserted in the field notes, no interpolation being required, except when test sights are taken. The true bearing between two points on a standard parallel will be derived from Table 5 by taking it in the column headed with one-half the distance between said points. The offsets at intervals of one mile are inserted in Table 6; to obtain the length of offsets at the half-mile points, take one-fourth of the offset corresponding to twice the distance of the half-mile point from the tangential point.

“This method is suitable for running standard parallels and latitudinal township lines in a level open country, where no intersections with topographical features will be required; but, in all cases the secant method will be found most convenient.”

TABLE 5.

AZIMUTHS OF THE TANGENT TO THE PARALLEL.

[The azimuth is the smaller angle the tangent makes with the true meridian and always measured from the north and towards the tangential points.]

Latitude.	1 mile.			2 miles.			3 miles.			4 miles.			5 miles.			6 miles.		
	°	'	''	°	'	''	°	'	''	°	'	''	°	'	''	°	'	''
30	89	59	30.0	89	58	59.9	89	58	29.9	89	57	59.9	89	57	29.9	89	56	59.8
31	89	59	28.8	89	58	57.5	89	58	28.3	89	57	55.0	89	57	23.8	89	56	52.5
32	89	59	27.5	89	58	55.0	89	58	22.5	89	57	50.0	89	57	17.5	89	56	45.0
33	89	59	26.2	89	58	52.5	89	58	18.7	89	57	44.9	89	57	11.2	89	56	37.4
34	89	59	24.9	89	58	49.9	89	58	14.8	89	57	39.7	89	57	04.6	89	56	29.6
35	89	59	23.6	89	58	47.2	89	58	10.8	89	57	34.4	89	56	58.0	89	56	21.6
36	89	59	22.2	89	58	44.4	89	58	06.8	89	57	28.9	89	56	51.1	89	56	13.4
37	89	59	20.8	89	58	41.6	89	58	02.5	89	57	23.3	89	56	44.1	89	56	05.0
38	89	59	19.4	89	58	38.8	89	57	58.2	89	57	17.5	89	56	36.9	89	55	56.3
39	89	59	17.9	89	58	35.8	89	57	53.7	89	57	11.6	89	56	29.6	89	55	47.5
40	89	59	16.4	89	58	32.8	89	57	49.2	89	57	05.5	89	56	21.9	89	55	38.3
41	89	59	14.8	89	58	29.6	89	57	44.4	89	56	59.3	89	56	14.1	89	55	28.9
42	89	59	13.2	89	58	26.4	89	57	39.6	89	56	52.8	89	56	06.0	89	55	19.2
43	89	59	11.5	89	58	23.1	89	57	34.6	89	56	46.2	89	55	57.7	89	55	09.2
44	89	59	09.8	89	58	19.6	89	57	29.5	89	56	39.3	89	55	49.1	89	54	58.9
45	89	59	08.0	89	58	16.1	89	57	24.1	89	56	32.1	89	55	40.2	89	54	48.2
46	89	59	06.2	89	58	12.4	89	57	18.6	89	56	24.8	89	55	31.0	89	54	37.2
47	89	59	04.3	89	58	08.6	89	57	12.9	89	56	17.1	89	55	21.4	89	54	25.7
48	89	59	02.3	89	58	04.6	89	57	06.9	89	56	09.2	89	55	11.5	89	54	13.8
49	89	59	00.2	89	58	00.5	89	57	00.7	89	56	00.9	89	55	01.2	89	54	01.4
50	89	58	58.1	89	57	56.2	89	56	54.3	89	55	52.6	89	54	50.5	89	53	48.5

Latitude.	7 miles.			8 miles.			9 miles.			10 miles.			11 miles.			12 miles.		
	°	'	''	°	'	''	°	'	''	°	'	''	°	'	''	°	'	''
30	89	56	29.8	89	55	59.8	89	55	29.8	89	54	59.7	89	54	29.7	89	53	59.7
31	89	56	21.3	89	55	50.0	89	55	18.8	89	54	47.6	89	54	16.3	89	53	45.1
32	89	56	12.5	89	55	40.0	89	55	07.6	89	54	35.1	89	54	02.6	89	53	30.1
33	89	56	03.6	89	55	29.9	89	54	56.1	89	54	22.3	89	53	48.5	89	53	14.8
34	89	55	54.5	89	55	19.4	89	54	44.4	89	54	09.3	89	53	34.2	89	52	59.1
35	89	55	45.2	89	55	08.8	89	54	32.3	89	53	55.9	89	53	19.5	89	52	43.1
36	89	55	35.6	89	54	57.8	89	54	20.0	89	53	42.3	89	53	04.5	89	52	26.7
37	89	55	25.8	89	54	46.6	89	54	07.4	89	53	28.2	89	52	49.1	89	52	09.9
38	89	55	15.7	89	54	35.1	89	53	54.5	89	53	13.9	89	52	33.2	89	51	52.6
39	89	55	05.4	89	54	23.3	89	53	41.2	89	52	59.1	89	52	17.0	89	51	34.9
40	89	54	54.7	89	54	11.1	89	53	27.5	89	52	43.8	89	52	00.2	89	51	16.6
41	89	54	43.7	89	53	58.5	89	53	13.4	89	52	28.2	89	51	43.0	89	50	57.8
42	89	54	32.4	89	53	45.6	89	52	58.8	89	52	12.0	89	51	25.2	89	50	38.4
43	89	54	20.8	89	53	32.3	89	52	43.8	89	51	55.4	89	51	06.9	89	50	18.5
44	89	54	08.7	89	53	18.5	89	52	28.4	89	51	38.2	89	50	48.0	89	49	57.8
45	89	53	56.3	89	53	04.3	89	52	12.3	89	51	20.4	89	50	28.4	89	49	36.4
46	89	53	43.4	89	52	49.5	89	51	55.7	89	51	01.9	89	50	08.1	89	49	14.3
47	89	53	30.0	89	52	34.3	89	51	38.6	89	50	42.9	89	49	47.2	89	48	51.4
48	89	53	16.1	89	52	18.4	89	51	20.7	89	50	23.0	89	49	25.3	89	48	27.6
49	89	53	01.7	89	52	01.9	89	51	02.1	89	50	02.4	89	49	02.6	89	48	02.8
50	89	52	46.6	89	51	44.7	89	50	42.8	89	49	40.9	89	48	39.0	89	47	37.1

TABLE 6

OFFSETS, IN CHAINS, FROM TANGENT TO PARALLEL.

Latitude.	1 mile.	2 miles.	3 miles.	4 miles.	5 miles.	6 miles.
0	<i>Chains.</i>	<i>Chains.</i>	<i>Chains.</i>	<i>Chains.</i>	<i>Chains.</i>	<i>Chains.</i>
30	0.006	0.023	0.053	0.09	0.14	0.21
31	0.006	0.024	0.055	0.10	0.15	0.22
32	0.006	0.025	0.057	0.10	0.16	0.23
33	0.007	0.026	0.059	0.10	0.16	0.24
34	0.007	0.027	0.061	0.11	0.17	0.25
35	0.007	0.028	0.064	0.11	0.18	0.25
36	0.007	0.029	0.066	0.12	0.18	0.26
37	0.008	0.031	0.068	0.12	0.19	0.27
38	0.008	0.032	0.071	0.13	0.20	0.28
39	0.008	0.033	0.074	0.13	0.20	0.29
40	0.008	0.034	0.076	0.13	0.21	0.30
41	0.009	0.035	0.079	0.14	0.22	0.32
42	0.009	0.036	0.082	0.14	0.23	0.33
43	0.009	0.038	0.085	0.15	0.24	0.34
44	0.010	0.039	0.088	0.16	0.24	0.35
45	0.010	0.040	0.091	0.16	0.25	0.36
46	0.010	0.042	0.094	0.17	0.26	0.37
47	0.011	0.044	0.097	0.17	0.27	0.39
48	0.011	0.045	0.101	0.18	0.28	0.40
49	0.012	0.046	0.104	0.19	0.29	0.42
50	0.012	0.048	0.108	0.19	0.30	0.43

Latitude.	7 miles.	8 miles.	9 miles.	10 miles.	11 miles.	12 miles.
0	<i>Chains.</i>	<i>Chains.</i>	<i>Chains.</i>	<i>Chains.</i>	<i>Chains.</i>	<i>Chains.</i>
30	0.29	0.37	0.47	0.58	0.71	0.84
31	0.30	0.39	0.49	0.60	0.74	0.88
32	0.31	0.40	0.51	0.63	0.76	0.91
33	0.32	0.42	0.53	0.65	0.79	0.95
34	0.33	0.43	0.55	0.68	0.82	0.98
35	0.35	0.45	0.57	0.70	0.86	1.02
36	0.36	0.47	0.59	0.73	0.89	1.06
37	0.37	0.48	0.61	0.75	0.91	1.10
38	0.38	0.50	0.64	0.78	0.95	1.14
39	0.40	0.52	0.66	0.81	0.99	1.18
40	0.41	0.54	0.68	0.84	1.02	1.22
41	0.43	0.56	0.70	0.87	1.06	1.26
42	0.44	0.58	0.73	0.90	1.09	1.31
43	0.46	0.60	0.75	0.93	1.14	1.35
44	0.48	0.62	0.79	0.97	1.18	1.40
45	0.49	0.64	0.81	1.00	1.22	1.45
46	0.51	0.66	0.84	1.04	1.26	1.50
47	0.53	0.68	0.87	1.07	1.31	1.56
48	0.55	0.71	0.91	1.12	1.35	1.61
49	0.57	0.74	0.93	1.16	1.40	1.67
50	0.59	0.77	0.97	1.20	1.45	1.73

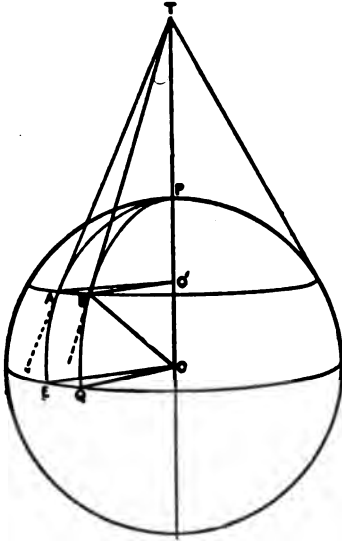

FIG. 62.

170. CONVERGENCE OF THE MERIDIANS. — The angular convergence of the meridians, given in Table 3, may be computed as follows. In Fig. 62 *AB* is an arc of a parallel of latitude and *EQ* the arc of the equator intercepted by the meridians through *A* and *B*. *AT* and *BT* are lines tangent to the meridians at *A* and *B*, meeting the earth's axis, prolonged, at *T*. It will be seen that the angle *BTO* equals the angle *BOQ*, which is the latitude of points *A* and *B*. The angle *AO'B* is the difference in longitude of points *A* and *B*. The angle

between the meridians at *A* and *B* is the angle *ATB*

In the triangle *BOO'*,

$$\begin{aligned} BO' &= BO \cos O'BO \\ &= BO \cos BOQ \end{aligned}$$

In the sector *AO'B*,

$$\frac{AB}{BO'} = \text{angle } AO'B$$

In the sector *ATB*,

$$\frac{AB}{BT} = \text{angle } ATB \text{ (approximately)}$$

But $BT = \frac{BO'}{\sin BTO} = \frac{BO'}{\sin BOQ}$

$$\begin{aligned} \therefore \text{angle } ATB &= \frac{AB}{BO'} \sin BOQ \\ &= \text{angle } AO'B \sin BOQ, \end{aligned}$$

i.e., the angular convergence equals the difference in longitude times the sine of the latitude.

Example. — To find the angular convergence between two meridians 6 miles apart in latitude 37°. The length of 1° of longitude in latitude 37° is 55.30 miles (Table 7).

$$\frac{6}{55.30} \times \sin 37^\circ \times 60 = 3'.9.$$

TABLE 7.

LENGTH OF A DEGREE IN LONGITUDE.

Lat.	Degree of Longitude Statute Miles.	Lat.	Degree of Longitude Statute Miles.	Lat.	Degree of Longitude Statute Miles.
0	69.160	30	59.944	60	34.666
1	.150	31	.334	61	33.615
2	.119	32	58.706	62	32.553
3	.066	33	.060	63	31.481
4	68.992	34	57.396	64	30.399
5	68.898	35	56.715	65	29.308
6	.783	36	.016	66	28.208
7	.647	37	55.300	67	27.100
8	.491	38	54.568	68	25.983
9	.314	39	53.819	69	24.857
10	68.116	40	53.053	70	23.723
11	67.898	41	52.271	71	22.582
12	.659	42	51.473	72	21.435
13	.400	43	50.659	73	20.282
14	.120	44	49.830	74	19.122
15	66.820	45	48.986	75	17.956
16	.499	46	.126	76	16.784
17	.158	47	47.251	77	15.607
18	65.797	48	46.362	78	14.425
19	.416	49	45.459	79	13.238
20	65.015	50	44.542	80	12.047
21	64.594	51	43.611	81	10.853
22	.154	52	42.667	82	9.656
23	63.695	53	41.710	83	8.456
24	.216	54	40.740	84	7.253
25	62.718	55	39.758	85	6.048
26	.201	56	38.763	86	4.841
27	61.665	57	37.756	87	3.632
28	.110	58	36.737	88	2.422
29	60.536	59	35.707	89	1.211

CHAPTER VI.

TRAVERSE LINES. — LOCATION OF BUILDINGS. — MISCELLANEOUS SURVEYING PROBLEMS.

TRAVERSE LINES.

171. TRAVERSES WHICH DO NOT FORM CLOSED FIGURES. —

A great many surveys, such, for example, as the preliminary surveys for railroads or pipe lines, call for traverses which do not return to the starting point. In this work the line is usually measured continuously from one end to the other, and the form of notes is commonly as follows. The starting point of the traverse is called "Station 0," the next station 100 ft. away is "Station 1," the next "Station 2," etc. Every 100-ft. length is a *full station* and any fractional distance is called the *plus*. The distance from Station 0 to any point, **measured along the traverse line**, is the station of that point and is recorded always by the number of the last station with the plus station in addition, e.g., the station of a point at 872.4 ft. from Station 0 is 8 + 72.4.

At the angle points it is customary to measure the **deflection angles** rather than the interior angles because the former are usually the smaller. These should be checked in the field by "doubling" the angles (Art. 143, p. 108).

The notes are kept so as to read **up the page**. The left-hand page is for the traverse notes and the right-hand page for the sketch, the stations in the sketch being opposite the same station in the notes. Fig. 63 is a set of notes illustrating this type of traverse. Frequently no notes are kept in tabular form, all of the data being recorded on the sketch.

172. METHODS OF CHECKING TRAVERSES WHICH DO NOT FORM CLOSED FIGURES. — **Checking by Astronomical Methods.** —

The angles of any traverse can be checked by determining the azimuth of the first and last lines by astronomical methods. (See Chapter VII.) But since the meridians converge it is neces-

sary to make proper allowance for this convergence, the amount of which can be obtained from Table 3, p. 129.

173. **Checking by Cut-Off Lines.**— The angles may also be checked in some cases by cutting across from one point on the traverse to another at a considerable distance ahead, and measuring the angles from the traverse line at each end of this cut-off

(LEFT-HAND PAGE.)

(RIGHT-HAND PAGE.)

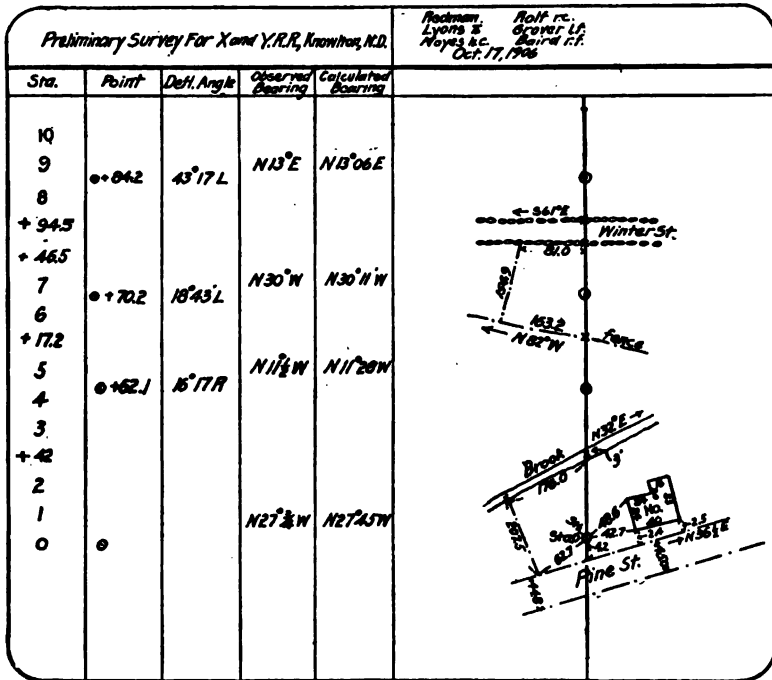

FIG. 63. TRAVERSE NOTES.

line, thereby obtaining all the angles of a closed traverse in which the length of one side only (the cut-off line) is missing. Sometimes the angle at only one end of the cut-off line can be measured, in which case the calculations for checking are not so simple as in the former case. When both angles have been measured the check consists in simply obtaining the algebraic sum of the deflection angles, while in the latter case the traverse must be computed.

174. Checking by Angles to a Distant Object.— A practical and very useful method of checking the azimuth of any line of the traverse is as follows. At intervals along the line, measure carefully the angle from the traverse line to some well-defined distant object, such as a distinct tree on a hill or the steeple of a church. If the survey is plotted and it is found by laying off the angles taken to the distant object that these lines do not meet at one point on the plan there is a mistake in the angles, and a study of the plot will show the approximate location of the mistake. If convenient, an angle to the distant object should be taken at every transit point. When plotted, if these lines meet at the same point in one section of the traverse and in another section meet at another point, then there is a mistake in the line which connects these two parts of the traverse. Frequently this distant point is so far away that it cannot be plotted on the plan. In this case as well as when it is desired to check more accurately than by plotting, the location of the distant point with reference to the traverse line can be computed by using these measured angles, as explained in Art. 408, p. 372. Plotting will not disclose minor errors of a few minutes only.

175. Checking by Connecting with Triangulation Points.— An accurate and practical method of checking both the angles and distances of a traverse is to connect the traverse with reliable *triangulation points* which can be easily identified. (See Art. 283, p. 255.) The latitude and longitude of these triangulation points and the distances between them can be obtained from the proper authorities. Sometimes the distances between them are not known but they can be computed. Then by connecting the traverse lines with these triangulation points by angles and distances a closed traverse is obtained, which serves as a good check.

Many surveyors fail to appreciate the value of this method of checking and do not realize how many such points are available. The information concerning such triangulation points can be obtained from The U. S. Coast and Geodetic Survey, The U. S. Geological Survey, State surveys, and frequently from City or Town surveys.

LOCATION OF BUILDINGS FROM TRANSIT LINE.

176. METHODS OF LOCATING BUILDINGS. — Many objects, such as buildings, are plotted directly from the survey line. In this case the measurements taken should be such as will permit the most accurate and rapid plotting. Sometimes where it is desirable to shorten the amount of fieldwork, the methods used are such as to gain time at the expense of accuracy or of simplicity in plotting. The accuracy with which such locations are made will depend upon the purpose of the survey. In city plans the accurate location of buildings is of great importance, while in topographic maps a rough location is often sufficient. There are so many different cases which will arise that this work requires considerable skill and judgment on the part of the surveyor.

177. GEOMETRIC PRINCIPLES. — Whether the locations are accurate or only rough, the principles involved are the same. In order to make clear the various methods used in the location of buildings it will be well to enumerate the geometric principles involved before giving particular cases occurring in practice.

A point may be located : —

- (1) By rectangular coördinates, i.e., by its station and perpendicular offset.
- (2) By two ties from known points.
- (3) By an angle and a distance from a known point.
- (4) By an angle at each of two known points.
- (5) By a perpendicular swing offset from a known line and a tie from a known point.
- (6) By perpendicular swing offsets from two known lines.

A line may be located : —

- (1) By two points on the line.
- (2) By one point on the line and the direction of the line.

178. TIES, OFFSETS, SWING OFFSETS, AND RANGE LINES. — In the above, the word *tie* is used as meaning a direct horizontal measurement between two points.

An *offset* is the distance from a line, usually at right angles.

A *swing offset* is the perpendicular distance to a line and is found by trial. The zero end of the tape is held at the point to be located and the tape is swung in a short arc about the point as a center, the tape being **pulled taut and kept horizontal**. The tape is read from the transit in various positions, and the shortest reading obtainable is the perpendicular distance desired.

A *range line* is a line produced to intersect the transit line or some other line.

179. GENERAL SUGGESTIONS.—By whatever method the buildings are located the following suggestions should be carried out.

(1) All the sides of the building should be measured and checked by comparing the lengths of opposite sides.

(2) Other things being equal, a long side of a building should be located in preference to a short side.

(3) Ties should intersect at an angle as near 90° as practicable, and never less than 30° .

(4) One or more *check measurements* should be taken in every case.

(5) In order to secure the best location the surveyor should keep constantly in mind how the building or other object which is being located is to be plotted.

In most work of this character it is customary to record the measurements to tenths of a foot. How precisely the measurements should be taken, however, depends upon the scale to which they are to be plotted.

180. TYPICAL CASES.—Although each case will have to be dealt with according to circumstances there are certain typical cases which will serve as guides. These are illustrated by the following examples.

181. Example I. Building Near Transit Line and Nearly Parallel to it.—As will be seen in Fig. 64 swing offsets are taken at the two front corners which, together with the tie from *A* to station *I* and the length of the front of the building locate points *A* and *B*. Then the general dimensions of the building are sufficient to plot and check the remaining sides. It is assumed that the corners of the building are square unless it is

obvious that they are not. The tie from C to station 2 is a check against an error in the other measurements.

PLOTTING.— This building would be plotted thus:— scale the distance AX perpendicular (estimated) to the transit line

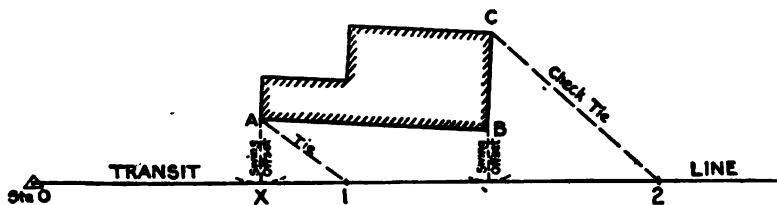

FIG. 64.

and draw a line with triangles parallel to the transit line; then scale $A1$ from station 1 to this parallel line. Point A is then located. Point B is located in the same way, AB being used as the tie from A . Then by means of triangles and scale the building is completed and the distance $C2$ scaled and compared with the notes. Another way to plot point A would be to set on the compass the distance $1A$ and swing an arc about 1 as a center; then, keeping the scale perpendicular to the transit line, find where the distance XA will cut this arc, thus locating point A . Point B can be similarly located after A has been plotted. For the same degree of accuracy distances can be measured more rapidly with a scale than they can be laid off with a compass, therefore the former method is usually more practicable.

This building might have been located by four ties AO , $A1$, $B1$, and $B2$. The plotting in this case would be slow because at least two of the ties must be swung by use of a compass, and inaccurate because the intersections would be bad.

182. Example II. Building Near Transit Line and Making a Slight Angle with it.— Fig. 65 illustrates two ways of locating a building in such a position that the intersection of the transit line by the long side (produced) can be readily obtained.

The left-hand building is located by the method of Example I. The tie $B1$ could have been taken instead of $B2$. It would have given a better intersection at B , but since it is a longer tie than $B2$ the fieldwork necessary is slightly greater. If $B2$ is

taken BI might be measured as a check tie although AI would make a better check tie since it will also check the measurement of the side AB .

The right-hand figure illustrates another method of locating such a building. The front and side of the building are ranged out by eye, a method which is thoroughly practical and sufficiently precise for all ordinary purposes, and the plus stations of points E and F are measured. The range lines CE and DF are also measured and the check tie $C\mathcal{B}$. $C\mathcal{B}$ could have been taken as a check tie; it would have given a better intersection at C than the tie $C\mathcal{B}$, but it is much longer.

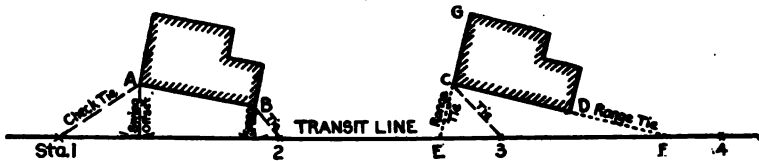

FIG. 65.

PLOTTING. — The left-hand building is plotted as described in Example I. In plotting the right-hand building the plus stations on the transit line are first scaled. Then with the compass set at the distance EC an arc is swung from E as a center. From F the distance FC is scaled to intersect the arc, which locates point C and the direction of the side CD . The building is then plotted with triangles and scale. The check tie $C\mathcal{B}$ should scale to agree with the notes and the line GC produced should strike point E .

There is little difference between these two methods in the amount of fieldwork, there being only one more measurement in the right-hand than in the left-hand figures, but one extra check is thereby obtained. In plotting, the method used in the right-hand figure is shorter.

183. Example III. Building Located Entirely by Direct Ties. — Any building not far from the transit line can be located and checked by four ties as in Fig. 66. This method has the advantage of being very simple and direct, especially in the field, but the plotting of the building calls for the use of the compass in two of the ties and hence is less rapid and accurate than where swing offsets or ranges can be used.

PLOTTING. — The plotting of this building is done by swinging the tie from one station to a corner of the building and scaling from the other station the tie to the same corner. Then the

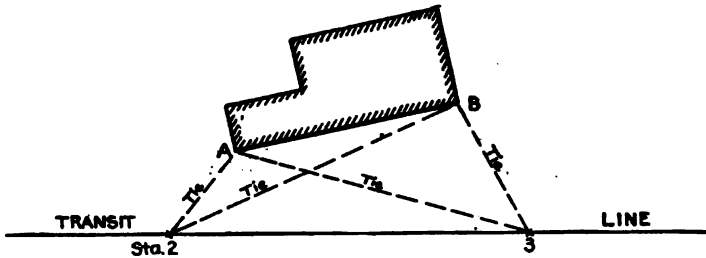

FIG. 66.

other corner is plotted in the same way or by using the side of the building as one of the ties in case it gives a better intersection.

184. **Example IV. Building Located at a Considerable Skew to the Transit Line.** — A building which is at a considerable skew to the transit line can best be located by range ties as illustrated in Fig. 67. The range ties through *A* are sufficient to

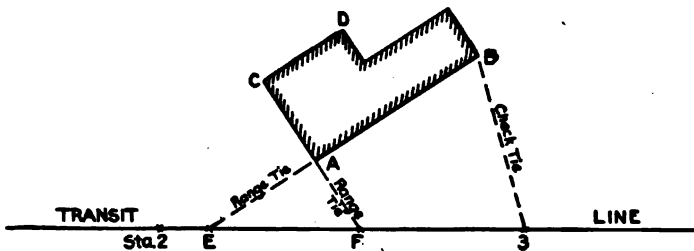
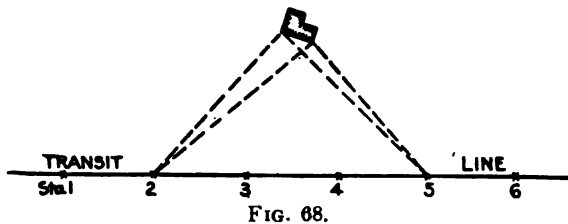

FIG. 67.

locate the building, provided *AE* and *AF* are not too short in comparison with the sides of the building. If the seranges are long enough, then *B3* is a check tie; but if the ranges are short, *B3* must be depended upon to determine the position of point *B* and in this event one of the range ties becomes a check. But if *A* is within two or three feet of the transit line it will be well to omit one of the ranges and take the additional tie *2C* or the range tie *DC* produced.

PLOTTING. — If the ranges are of fair length the building is plotted as explained for the right-hand building in Art. 182, but if the range ties are short point B is located either by swinging the arc with radius EB and scaling $B\mathcal{B}$ or by arc $\mathcal{B}B$ and scaling EB . Then the direction of AB is determined and the building is plotted. CA produced should strike at F , and AF should scale the measured distance.

185. Example V. Buildings at a Long Distance from the Transit Line. — It is evident that in this case (Fig. 68) the tape



is not long enough to allow the use of swing offsets. Range ties may be used provided the building is not so far away that the eye cannot judge the range line with reasonable accuracy. Sometimes the only methods available are long ties or angles or a combination of the two. In any specific case there may be some objections to any of these methods, and the surveyor will have to decide according to circumstances which method he will use. For example, where there are obstacles to the measurement of ties, the corners of the building may have to be located entirely by angles from two points on the transit line. Location by angles is objectionable because it is difficult to plot an angle quickly and at the same time accurately. It often happens, however, that when a building is at a considerable distance from the transit line its accurate position is not required, since as a rule the features near the transit line are the important ones. This method of "cutting in" the corners of the building by angle is often used in rough topographic surveying and is decidedly the quickest of all methods so far as the fieldwork is concerned.

PLOTTING. — The angles are laid off from the transit line

with a protractor and the proper intersections determine the corners of the buildings. If the building is measured the side between the corners located will be a check tie.

In some cases, e.g., in making a topographic map on a small scale, the buildings are not measured at all, their corners being simply "cut in" by several angles from different transit points, and the shape of the building sketched in the notes.

186. Example VI. Buildings Located from Other Buildings. — Buildings which cannot be conveniently located from the transit line on account of intervening buildings may be defined by ties from the ones already located. Fig. 69 shows several ways

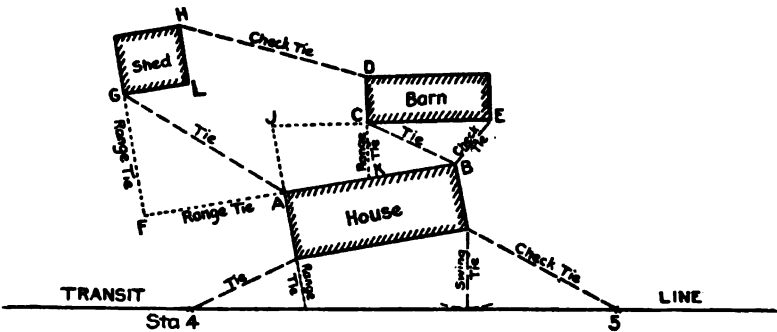

FIG. 69.

in which such buildings may be located. Any of the preceding methods are applicable, using the side of the house as a base-line, but it will be found that range ties are almost always preferable. For example, the barn is located by the distance BK , the range tie KC and the tie BC , and checked by the tie BE . Another location of the barn is the distance AK or BK , the range tie KC , and the two range ties AJ and CJ . By this latter method the directions of both sides of the barn are checked. Still another location of the point C would be to substitute in the place of the range tie CK a swing offset from C to the house. The shed is located by the range ties AF and FG and by the tie AG . The check tie HD in general checks the location of both the barn and the shed. If the side HL is ranged out instead of the opposite side it will be seen that the tie AL will give a

poorer intersection at L . If convenient a tie from L to q or the range GF continued to the transit line may be measured as a check.

187. Example VII. Buildings of Irregular Shape. — Occasionally a building of irregular shape has to be located. For example, the shop in Fig. 70 is located on the front by ties and

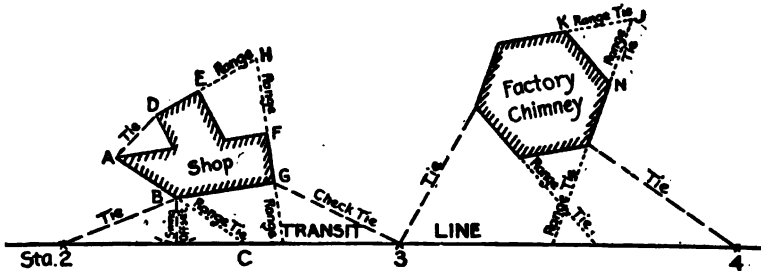

FIG. 70.

swing offsets like Example I; then the direction of AB is determined by the range tie BC . The back corner E is determined by the ranges FH and EH , and by the dimensions of the building; FA is assumed parallel to GB . If the angle F is a right angle the tie EF may be taken instead of the range ties FH and EH , but even when F is a right angle it will be well if time will permit to take these range distances as they give valuable checks on the other measurements which the single tie EF does not furnish. ED is scaled along HE produced and the rest of the building plotted by its dimensions and checked by AD .

The ties shown on Fig. 70 to locate the factory chimney will locate its sides even if they do not form a regular polygon. If such a structure is situated at a considerable distance from the transit line probably the best way to locate it is by angles and distances to the corners, by the measurements of the sides, together with a few such ranges as NJ or KJ .

188. Example VIII. Large City Buildings. — Fig. 71 illustrates the location of several buildings in a city block where the transit line runs around the block. The fronts of the buildings are located from the transit line and the rear corners are tied together. The range ties are shown by dotted lines and other ties by dashes. The angles measured are marked by

arcs. At the curve AB , the side lines of the building are ranged out to point C which is located from the transit line by an angle

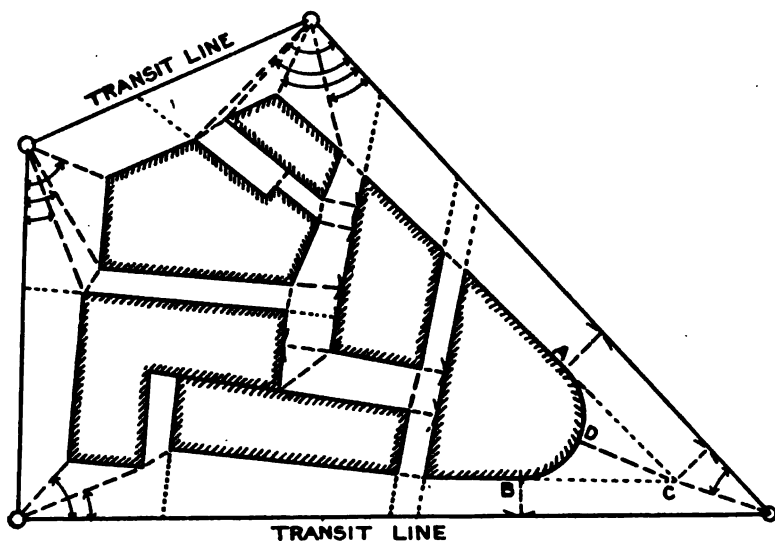

FIG. 71.

and distance and checked by a swing offset; CD is also measured to locate point D on the curve.

Frequently large buildings have their walls reinforced by pilasters, and care should be taken in such cases not to confuse the neat line of the wall with the line of the pilasters.

189. Example IX. Location of Buildings by Angles and Distances. — It will be seen from Figs. 71 and 72 that some of the buildings have been located by angles and distances from transit points. Any of the buildings in the above examples could be located by this method, and on account of the rapidity with which the work can be done in the field many surveyors prefer to use it almost exclusively.

190. Location of Buildings and Fences from Transit Line. — Fig. 72 is a sample page from a note-book illustrating the above principles. It will be noticed that in the field notes the letter R appears where the lines are ranges.

MISCELLANEOUS SURVEYING PROBLEMS.

191. **RANDOM LINE.** — Not infrequently in attempting to run a straight line between two points A and B (Fig. 73) it is impossible to see one point from the other or to see both points A and B from an intermediate set-up on a straight line between them. When this condition exists it is necessary to start at one point, e.g., A , and run what is called a trial, or *random*, line AC by the method explained in Art. 64, p. 52, in the direction of the other end of the line as nearly as can be judged.

Where the random line passes the point B the perpendicular offset YB is measured and also the distance to point Y along AC . Unless the random line is very close, say, within about two feet of the line AB , the point Y where a perpendicular to AC will pass through B cannot be accurately chosen by eye. The method resorted to in this case is one which has very general application in all kinds of surveying work, and is as follows.

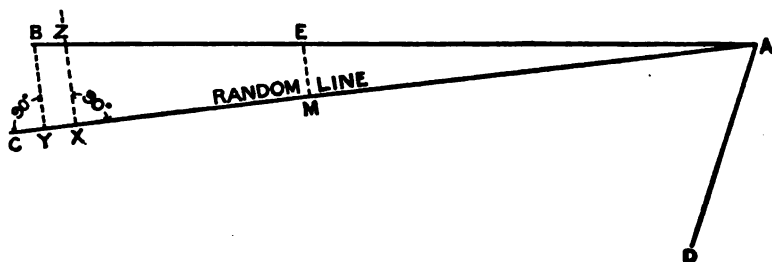

FIG. 73.

With the transit at A point X is set carefully on the line AC and as nearly opposite point B as possible. Then the instrument is set up at X and 90° turned off in the direction XZ . If this line does not strike B (and it seldom will exactly) the distance BZ is carefully measured by a swing offset as described in Art. 178, p. 159. The distance BZ is equal to the distance XY which is added to AX giving the length of the long leg AY of the right triangle AYB . The distance YB is then measured, and AB and angle YAB are easily calculated.

Angle DAY has been measured from some previous course

such as AD and the addition of the angle YAB together with the known distance AB makes the traverse complete to the point B without any further fieldwork. If the transit is now moved to B with a view to carrying on the survey it will be found that, since A cannot be seen from B , there is no point on the line BA to use as a backsight. But any point such as E can be readily set on the line AB by making the offset $ME = BY \frac{AM}{AY}$. Another point can be similarly set on AB as a check on the backsight.

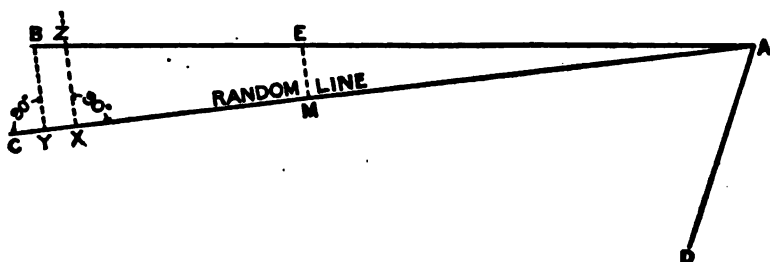

FIG. 78.

This random line method is sometimes employed when AB is a boundary which is covered with shrubs. In such cases, although the view from A to B may not be obstructed, it may be so difficult to measure the line AB that its length can be more easily obtained by the use of the random line while the angle DAB may be measured directly at A . If it is desired to mark the line AB by several intermediate points these may be established by means of perpendicular offsets calculated as described above.

192. OBSTACLES ON LINE. — When an obstacle of limited extent, such as a building or a small pond, lies on the transit line various methods are resorted to for prolonging the line through such obstructions; the most useful of these methods will be explained.

193. Offsetting Transit Line. — This method is illustrated by Fig. 74. It is desired to produce the line AB beyond the house. Point B is set on line and as near as is practicable to the house.

The instrument is then set up at B and a right angle ABF laid off with the transit. BF is made any convenient distance which will bring the auxiliary line beyond the building. Similarly point E is set opposite point A , and sometimes a second point E' opposite A' , points A and A' being exactly on the transit line. These points E and E' need not be set by means of a transit set up at A and at A' unless AE is quite long.

The instrument is then set up at F and backsighted on E , the sight is checked on E' , the telescope inverted, and points $G, H,$ and H' set on line. Leaving the telescope inverted, another backsight is taken on A , and the process repeated as described in Art. 64, p. 52. Then the transit is moved to point G , and a right angle turned off, and point C set on the right angle line, the distance GC being made equal to BF .

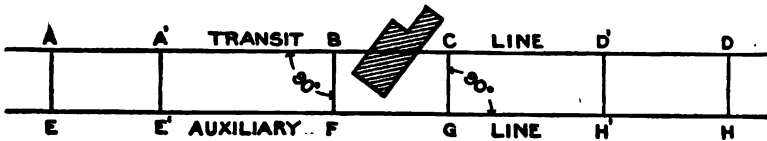

FIG. 74.

Then by setting up at C and sighting ahead on D , ($DH = GC$), and checking on point D' , ($D'H' = GC$), the transit line is again run forward in its original location. The distance FG is carefully measured which gives the distance BC , and thus it appears why it is so necessary that the lines BF and GC shall be laid off at right angles by means of the transit. The other offsets $AE, A'E', DH,$ and $D'H'$ are not in any way connected with the measurement along the line; they simply define the direction of the line so that if convenient it is often only necessary to show these distances as swing offsets for the transitman to sight on. From what has been said it will be seen that offsets $A'E'$ and $D'H'$ are not absolutely necessary, but they serve as desirable checks on the work and in first-class surveying they should not be omitted. For obvious reasons the offsets AE and DH should be taken as far back from the obstacle as is practicable.

Should the house be in a hollow so that it is possible to see over it with the instrument at A , the point D , or a foresight of some sort (Art. 64, p. 52) should be set on line beyond the house

to be used as a foresight when the transit is set up again on the original line. The distance may be obtained by an offset line around the house or by slope measurements to the ridgepole. Sometimes it is possible to place exactly on line on the ridgepole of the house a nail or a larger wooden sight which gives an excellent backsight when extending the line on the other side of the building.

If the building has a flat roof it may not be out of the question to set a point on the roof exactly on line, move the instrument to this point on the roof, and prolong the line in this way. Under these conditions the transitman will have to be extremely careful in the use of his instrument as it will be set up on an insecure foundation. If he walks around the transit he will find that it affects the level bubbles and the position of the line of sight; it is therefore well for him if possible to stand in the same tracks while he backsights and foresights. Sometimes two men, one in front and one behind the transit, can carry on the work under these conditions more accurately and conveniently. This method insures an accurate prolongation of the line, but the distance through the building must be measured by an offset method, unless it can be done by plumbing from the edge of the flat roof.

194. SHORT TRANSIT SIGHTS. — Sometimes the offset BF (Fig. 74) does not need to be more than 2 or 3 feet. The shorter this offset line can be made, and still clear the building, the better. But to lay off the short line BF will require a method somewhat different from any that has been heretofore explained. As the ordinary transit instrument cannot be focused on a point much less than about 5 ft. distant it is impossible to set point F directly. The method employed is to set a temporary point, say 10 ft. distant, on which the transit can be focused, and on a line perpendicular to the original transit line. From the transit point to this auxiliary point a piece of string may be stretched and the point F set at the required distance from B and directly under the string.

195. Bisection Method. — A method which is economical in fieldwork but not very accurate is the following. In Fig. 75 the instrument is set up at A , backsighted on the transit line, and equal angles turned off on each side of the transit line pro-

duced. Points B' and C' are carefully set on one of these lines and at convenient distances from A , and on the other line points

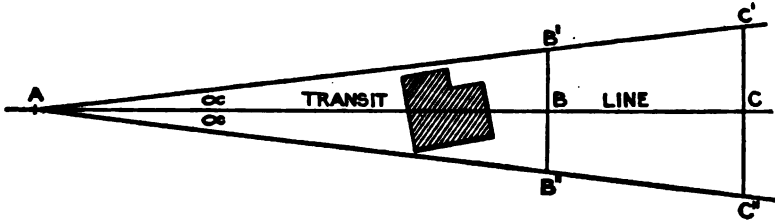

FIG. 75.

B'' and C'' are set at the same distances from A . Then point B is placed midway between B' and B'' , and similarly point C is set midway between C' and C'' . The line BC is the prolongation of the transit line. Of course the distance $B'C'$ should be made as long as practicable. The inaccuracy in this method lies entirely in laying off the two angles. (See Art. 61, p. 50.)

In this case the distance AB can be computed from the formula

$$AB' - AB = \frac{BB'^2}{2AB} \text{ (approximately). (See foot-note, p. 339.)}$$

196. Measuring Around a Small Obstacle. — In Fig. 76 the

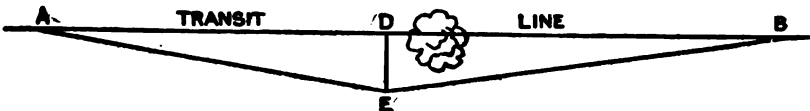

FIG. 76.

line AB runs through a tree. Point D is set with the transit at A , and DE is made equal to some convenient short distance and laid off at right angles to the transit line by eye. Then AE and EB are measured. The distance

$$AB = AE - \frac{DE^2}{2AE} + EB - \frac{DE^2}{2EB} \text{ (See foot-note, p. 339.)}$$

When DE is taken as some whole number of feet the computation of the above is extremely simple.

This method of measuring around a small obstacle might be applied much more generally than it is at present if its accuracy and its simplicity were more fully realized by surveyors.

197. Equilateral Triangle Method.— While this method requires much less fieldwork than the offset method described above it is at the same time less accurate. Point B (Fig. 77) is set on the transit line as near the building as practicable but so that a line BC at 60° with the transit line can be run out. The instrument is set up at B , backsighted on A , and an angle of 120° laid off; the line BC is made long enough so that when the instrument is set up at C and 60° is laid off from it, CD will fall outside the building. BC is measured and CD is made equal to BC . If the instrument is set up at D and angle CDE laid off equal to 120° the line DE is the continuation of the original transit line,

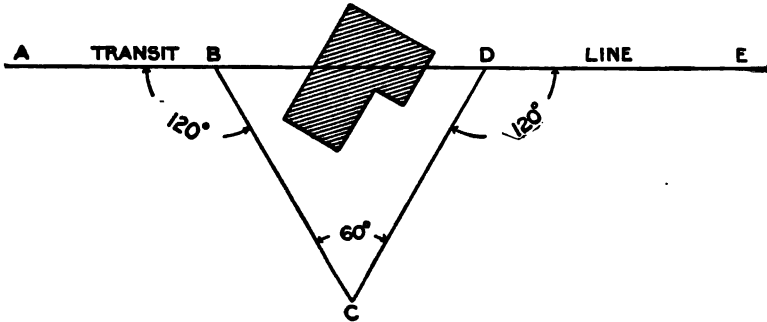

FIG. 77.

and the line $BD = BC$. This method is subject in three places to the errors incident to laying off angles and, when BC and CD are small, it has in two of its intermediate steps the disadvantages due to producing a short line.

198. INACCESSIBLE DISTANCES.— If the obstruction is a pond, points on the far side of it can be set and these should be used in producing the transit line. When the line can be produced across the obstacles the following methods may be used.

199. Inaccessible Distance by Right Triangle Method.— In Fig. 78 the line AB is made any convenient length and at any convenient angle to the transit line. The line BC is laid off at 90° to BA and is intersected with the transit line and the distance BC measured, which distance should check with its computed value. Also the angle CAB can be measured which will check the transit work.

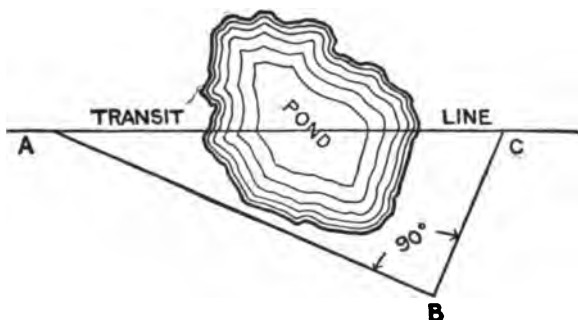

FIG. 78.

200. INTERSECTING TRANSIT LINES.— In many kinds of surveying work it is necessary to put in points at the intersection of two transit lines. It would be an easy matter to set the point if two transits could be used, one on each line, and the sight simultaneously given by each transitman. As it is seldom practicable to use more than one transit in a surveying party the following method is resorted to.

An estimate is made by eye where the lines will cross each other and temporary points not more than 10 ft. apart are set on one of the transit lines by means of the instrument, enough points being marked to make sure that the second line will cross somewhere among this set of temporary points. A string is then used to connect two of these temporary points and the transit is set up on the other transit line and the point where the second line cuts the string is the intersection point. Sometimes when the lines cross each other at nearly 90° the intersection point can be estimated so closely that only two temporary points need be placed on the first line. In other cases, where the two transit lines cross at a very small angle, it is impossible to tell by eye within several feet where the lines will intersect and a number of points must be used because in practice the stretching line is seldom applicable for distances much over 15 ft. For short distances the plumb-line can be used as a stretching line.

201. Inaccessible Distance by Swing Offset Method.— If the distance across a pond or river is not great the following method

may be used. It has the advantage of requiring the minimum amount of fieldwork. With the instrument at A (Fig. 79) point C is set on the transit line on the far side of the river. The instrument is then set up at C and the angle ACB measured between the transit line and a 100-ft. swing offset from point A .

A pencil is held vertically at the 100-ft. mark of the tape and while the zero point is held firmly at A the tape, which is constantly kept horizontal and taut, is swung slowly in an arc ab . The transitman, using the tangent screw, can follow the pencil with the vertical cross-hair of the transit, stopping the cross-hair when the pencil is in its farthest position

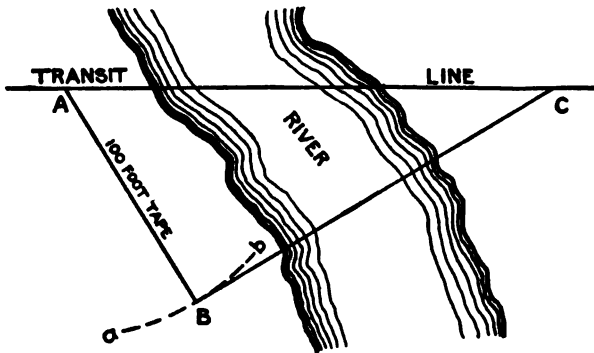

FIG. 79.

from A . Then as the tape is swung the second time he can check his setting and when this is established the angle ACB is read. The distance AC then is very easily calculated. It should be noted, however, that if AC is several times as long as AB the resulting error in AC may be so great as to prohibit the use of this method where very precise results are required. There is no reason why the swing offset could not be made at C with the instrument at A if more convenient.

202. Inaccessible Distance by Tangent Offset Method. — In the method described above the distance across the pond may be so great that 100 ft. will be too short a base to use, or point A may be situated on ground sloping upward towards B so that a swing offset

cannot be made. In such cases the line AB (Fig. 80) can be laid off at right angles to the transit line and of any convenient length.

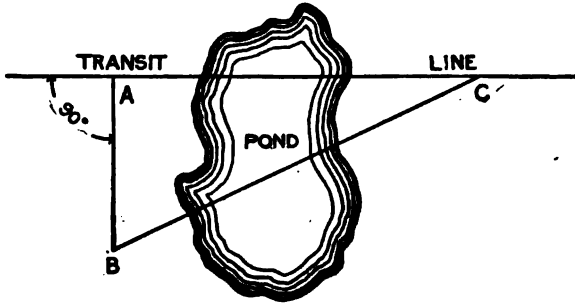

FIG. 80.

Then the angle ACB is measured and the line AC computed. By another set-up of the instrument the angle B can be measured as a check, and if the line BC does not cut across the pond its length can also be measured as a further check.

203. **Inaccessible Distance by Oblique Triangle Method.** — Often the shores of a stream are covered with trees so that none

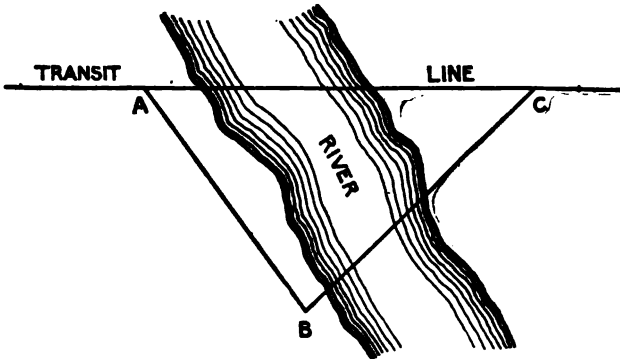

FIG. 81.

of the above methods are applicable. It may be convenient to measure a line AB (Fig. 81) in but one direction along the shore. In this case the point C is first carefully set on the opposite side, the line AB measured along the shore, and the angles at A and

at C are measured. The distance AC can then be computed. It will be well also to set up at B and measure the angle B as a check on the work. At the time when point C is set it is also good practice to set a point further ahead on the line, to use as a foresight to check the transit line when the instrument is moved across the river.

204. To Obtain the Distance Between Two Inaccessible Points by Observation from Two Accessible Points.—In Fig. 82 the points A and B are inaccessible and it is desired to obtain the distance AB and the angle that AB makes with the transit line. From the point D the distance DC and the angles BDA and ADC are measured, and similarly at C the angles ACB and BCD are measured. AB can then be calculated as follows:—in the triangle CBD compute CB ; in triangle ACD compute AC ; and in the triangle ACB calculate AB , the inaccessible distance. In the tri-

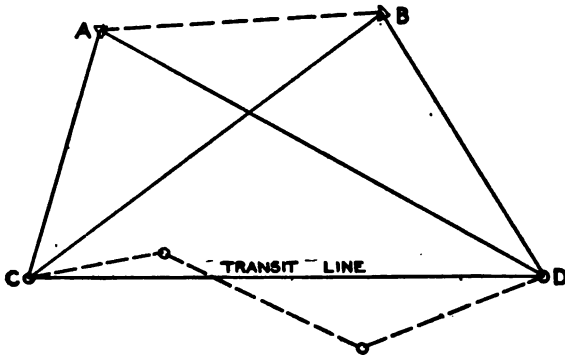

FIG. 82.

angle ACB , angle ABC can be computed, which, together with the measured angle BCD , will give the difference in direction between AB and CD . It is not at all necessary that DC should have been measured as one straight line in the traverse; the traverse might have run as indicated by the dotted lines, but in such an event the distance CD and the necessary angles could have been easily figured so that it could be reduced to the above problem.

This problem occurs when the distance between two triangulation stations, A and B , and the azimuth of AB are desired and when it is inconvenient or impossible to measure the line AB or to occupy the points with the transit.

205. To Obtain the Inaccessible Distance Between Two Accessible Points by Observations on Two Inaccessible Points of Known Distance Apart. — In this case (Fig. 82) A and B are the two accessible points and C and D are the two inaccessible points but the distance DC is known; the distance AB is required. With the transit at A , the angles CAD and DAB are measured; at B the angle CBD and ABC are measured. The length of the line CD is known. While it is simple to obtain CD in terms of AB , it is not easy to directly determine AB in terms of CD ; it will be well therefore to use an indirect method. Assume AB as unity. Then by the same process as described in the preceding problem the length of CD can be readily found. This establishes a ratio between the lengths of the lines AB and CD , and the actual length of CD being known the distance AB can be computed.

A problem of this sort would occur under the following circumstances. If the distance CD between two church spires were accurately known (from a triangulation system) and it is desired to use this line CD as a base-line for a survey, two points A and B could be assumed, and the distance between them and the azimuth of AB could be found by this method.

CHAPTER VII.

OBSERVATIONS FOR MERIDIAN AND LATITUDE.

OBSERVATIONS FOR MERIDIAN.

206. TO ESTABLISH A TRUE MERIDIAN LINE BY OBSERVATION ON POLARIS WITH THE TRANSIT. — On account of the earth's daily rotation on its axis all heavenly bodies appear to revolve once a day around the earth. Stars in the south appear to

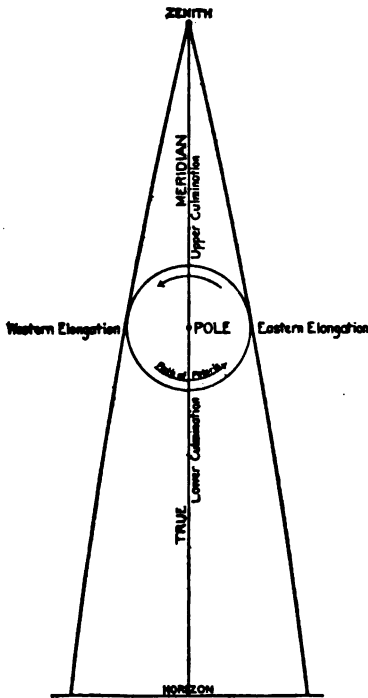

FIG. 88.

revolve in large circles parallel to the daily path of the sun. As we look farther north the apparent size of the circles grows smaller. The center of these circles is the *north pole* of the *celestial sphere*, a point in the sky in the prolongation of the earth's axis. The pole-star (*Polaris*) revolves about the pole in a small circle whose radius is less than a degree and a quarter (Fig. 83). This angular distance from the pole to a star is called its *polar distance*.

When the star is directly above the pole its bearing is the same as that of the pole itself and the star is said to be at *upper culmination*. At this instant it is **in the true meridian**. About twelve hours later it will be below the pole at *lower culmination* and will be again in the true meridian. About half-way between these two positions the star reaches its greatest east or west bearing,

and at such times is said to be at its greatest *elongation*. At either *eastern* or *western elongation* the star's bearing is not changing perceptibly because it is moving almost vertically, a

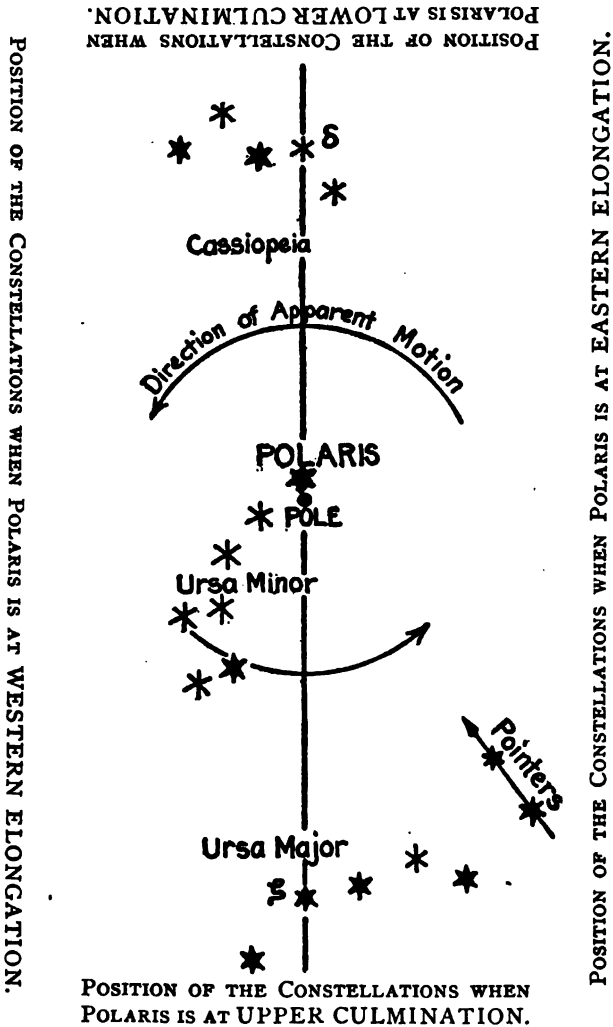

FIG. 84. RELATIVE POSITION OF THE CONSTELLATIONS NEAR THE NORTH POLE.

condition which is most favorable for an accurate observation. At culmination the star is changing its bearing at the maximum rate, and therefore this is not as good a time to make an accurate observation as at elongation. This star moves so slowly, however, that even at culmination its bearing can be obtained with sufficient accuracy for determining the declination of the needle. Polaris can be easily found by means of two conspicuous constellations near it, *Cassiopeia* and *Ursa Major*. The seven most conspicuous stars of the latter form what is commonly known as the "*Great Dipper*" (Fig. 84). The two stars forming the part of the bowl of the Dipper farthest from the handle are called the "*pointers*" because a line through them points almost directly at the pole. On the opposite side of Polaris is Cassiopeia, shaped like the letter W. A line drawn from δ^* *Cassiopeia*, the lower left-hand star of the W, to ζ *Ursæ Majoris*, the middle star of the Dipper handle, passes very close to Polaris and also to the pole itself.

207. OBSERVATION FOR MERIDIAN ON POLARIS AT ELONGATION. — When the Dipper is on the right and Cassiopeia on the left, Polaris is near its western elongation; when the dipper is on the left Polaris is near eastern elongation. When the constellations are approaching one of these positions the transit should be set over a stake and leveled, and the telescope focused upon the star.† Unless the observation occurs at about sunrise or sunset it will be necessary to use an artificial light to make the cross-hairs visible. If the transit is not provided with a special reflector for throwing light down the tube a good substitute may be made by cutting a small hole in a piece of tracing cloth or oiled paper and then fastening it over the end of the telescope tube by a rubber band. If a lantern is then held in front and a little to one side of the telescope the cross-hairs can be plainly seen. The star should be bisected by the vertical wire and followed by means of the tangent screw in its horizontal motion until it no

* The Greek Alphabet will be found on p. 516.

† It is difficult to find a star in the field of view unless the telescope is focused for a very distant object. The surveyor will find it a convenience if he marks on the telescope tube the position of the objective tube when it is focused for a distant object.

longer changes its bearing but moves vertically. (It will be seen from Fig. 83 that when the star is approaching eastern elongation it is moving **eastward** and **upward**; when approaching western elongation it is moving **westward** and **downward**.) As soon as this position is reached the telescope should be lowered and a point set in line with the vertical cross-hair at a distance of several hundred feet from the transit. Everything should be arranged beforehand so that this can be done quickly. Immediately after setting this point the instrument should be reversed and again pointed on the star. A second point is then set at one side of the first. The mean of these two points is free from the errors of adjustment of the transit. If the instrument is in adjustment, of course, the first and second points coincide. On account of the great difference in altitude between the star and the mark the elimination of instrumental errors is of unusual importance (Art. 79, p. 61). For 10 minutes of time on either side of elongation the bearing of the star does not change more than 5 seconds of arc and therefore there is sufficient time to make these two pointings accurately.

After the direction of the star at elongation has been found, the meridian may be established by laying off an angle equal to the azimuth, or true bearing of the star. Since this angle to be laid off is the **horizontal** angle between the star and the pole, it is not equal to the polar distance but may be found from the equation:—

$$\text{Sin Star's True Bearing} = \frac{\text{Sin Polar Distance of Star}}{\text{Cos Latitude}} . *$$

The mean polar distances for the years 1906 to 1920 may be

* This equation may be derived as follows; in Fig. 83, let *P* represent the pole, *Z* the zenith, and *E* the position of the star at elongation. Then by spherical trigonometry,

$$\frac{\sin PZE}{\sin ZEP} = \frac{\sin PE}{\sin ZP}$$

But *PZE* is the angle between the two vertical circles and equals the bearing. *ZEP* = 90° because *ZE* is tangent to the circle *WUEL*, which represents the path of Polaris. *PE* is the polar distance and *ZP* may be shown to be equal to 90° - latitude.

Hence,

$$\sin PZE = \frac{\sin PE}{\cos \text{lat.}}$$

TABLE 8.

MEAN POLAR DISTANCES OF POLARIS.*

Year.	Mean Polar Distance.			Year.	Mean Polar Distance.		
	°	'	"		°	'	"
1906	1	11	41.05	1914	1	09	12.07
1907	1	11	22.37	1915	1	08	53.51
1908	1	11	03.71	1916	1	08	34.97
1909	1	10	45.07	1917	1	08	16.45
1910	1	10	26.44	1918	1	07	57.94
1911	1	10	07.82	1919	1	07	39.45
1912	1	09	49.22	1920	1	07	20.98
1913	1	09	30.64

found in Table 8. The latitude may be obtained from a reliable map or by observation (Arts. 216-17, p. 196).

When the transit is set up at the south end of the line the angle thus computed must be laid off to the right if the elongation is west, to the left if the elongation is east. A convenient and accurate way of laying off the angle is by measuring the distance between the two stakes *A* and *B* (Fig. 85), and calculating the perpendicular distance *BC* which must be laid off at the north stake *B* to give a meridian *AC*.



FIG. 85.

* The above table was derived from data furnished by the Superintendent of the United States Coast and Geodetic Survey. The Mean Polar Distance is the average value of the polar distance for the entire year.

In taking the polar distance from the table for the purpose of looking up its sine the student should keep in mind the degree of precision desired in the computed azimuth. If the azimuth is to be within about one minute of the true value the polar distance need be taken only to the nearest minute, but if the azimuth is to be correct within a few seconds the polar distance should be taken to the nearest second. It should be noted however that since the values given in the table are only the average values for the year there will in general be an error of a few seconds due to neglecting the variation of the polar distance during the year. The exact value for every day in the year may be found in the "American Ephemeris and Nautical Almanac," published by the Bureau of Equipment, Navy Department.

208. OBSERVATION FOR MERIDIAN ON POLARIS AT CULMINATION. — At the instant when Polaris is above the pole the star ζ *Ursæ Majoris* will be almost exactly underneath Polaris. When Polaris is below the pole δ *Cassiopeiæ* will be almost directly below Polaris (Fig. 84). In order to know the instant when Polaris is exactly on the meridian it is necessary first to observe the instant when one of these two stars is vertically below Polaris. From this the time when Polaris will be on the meridian can be calculated by adding a certain interval of time, and the meridian line can thus be directly established. This interval of time was, for ζ *Ursæ Majoris*, about 2^m36^s in the year 1900, and it increases about 21^s per year. The intervals computed by this rule are only approximate, but are sufficiently accurate for many purposes and, as the change is very slow, the rule is good for many years. It may also be used for any latitude in the United States. When ζ *Ursæ Majoris* cannot be used, as is the case in the spring of the year, especially in northern latitudes, a similar observation can be made on δ *Cassiopeiæ*. The interval for this star was 3^m24^s for 1900, with an annual increase of about 20^s .

The observation to determine when the two stars are in the same vertical plane is at best only approximate, since the instrument must be pointed first at one star and then at the other; but since Polaris changes its azimuth only about 1 minute of angle in 2 minutes of time, there is no difficulty in getting fair results by this method. The vertical hair should first be set on Polaris, then the telescope lowered to the approximate altitude of the other star to be used. As soon as this star comes into the field the vertical hair is again set carefully on Polaris. As it will take the other star about 2 minutes to reach the center of the field there will be ample time for this pointing. Then the telescope is lowered and the instant when the star passes the vertical hair is observed by a watch. This will be the time desired, with an error of only a very few seconds. The time of culmination should then be computed as described above and the vertical hair set on Polaris when this computed time arrives. The telescope is then in the meridian which may be marked on the ground.

It will be seen that in this method the actual error of the watch has no effect on the result since it is used only for measuring the interval of a few minutes. The error in the meridian obtained by this method will seldom exceed one minute of angle.

209. To Find the Standard Time of Culmination and Elongation. — The approximate times of culmination and elongation of Polaris for the 1st and 15th of each month in the year 1907 may be found in Table 9.

TABLE 9.

APPROXIMATE TIMES OF CULMINATION AND ELONGATION OF POLARIS
COMPUTED FOR THE 90TH MERIDIAN WEST OF GREENWICH,
FOR THE YEAR 1907.

Date.	Upper Culmination.		Western Elongation.		Lower Culmination.		Eastern Elongation.	
	<i>h</i>	<i>m</i>	<i>h</i>	<i>m</i>	<i>h</i>	<i>m</i>	<i>h</i>	<i>m</i>
Jan. 1 1907	6	44	12	39	18	42	0	49
" 15	5	49	11	44	17	47	23	50
Feb. 1	4	41	10	36	16	39	22	42
" 15	3	46	9	41	15	44	21	47
Mar. 1	2	51	8	46	14	49	20	52
" 15	1	56	7	51	13	54	19	57
Apr. 1	0	49	6	44	12	47	18	50
" 15	23	50	5	40	11	52	17	55
May 1	22	47	4	46	10	49	16	52
" 15	21	52	3	51	9	54	15	57
Jun. 1	20	45	2	44	8	47	14	50
" 15	19	51	1	50	7	53	13	56
Jul. 1	18	48	0	47	6	50	12	53
" 15	17	53	23	48	5	55	11	58
Aug. 1	16	47	22	42	4	49	10	52
" 15	15	52	21	47	3	54	9	57
Sep. 1	14	45	20	40	2	47	8	50
" 15	13	50	19	45	1	52	7	55
Oct. 1	12	47	18	42	0	49	6	52
" 15	11	53	17	48	23	51	5	58
Nov. 1	10	46	16	41	22	44	4	51
" 15	9	51	15	46	21	49	3	56
Dec. 1	8	47	14	42	20	45	2	52
" 15	7	52	13	47	19	50	1	57

To find the time for any other date interpolate between the values given in the table, the daily change being about 4 minutes.

In order to find the exact time of culmination or elongation for any observation it would be necessary to take into account the latitude and longitude of the place and the exact date of the observation. The times given in Table 9 are only approximate in any case and are to be regarded merely as a guide so that the surveyor may know when to prepare for his observations.

The times are computed for mean local astronomical time at the 90th meridian west of Greenwich and for the year 1907. These numbers increase about $\frac{1}{3}$ minute each year so that this table may be used to obtain approximate results for subsequent years. Astronomical time begins at noon of the civil day of the same date and is reckoned from 0^h to 24^h, e.g., 18^h would mean 6^h A.M. The tabular numbers are nearly correct for the Standard Meridians, i.e., the 75th, 90th, 105th, and 120th west of Greenwich. All watches keeping "railroad time," or "standard time," are set to the local mean time of one of these four meridians (Art. 86, p. 68). To find the watch time of culmination or elongation for any other meridian, first find the difference in longitude in degrees between the place of observation and the standard meridian, and then convert this into minutes and seconds of time by dividing by 15, since 15° of longitude are equivalent to one hour of time. The standard, or watch, time of the observation is then obtained by **adding** this correction to the time taken from the table if the place is **west** or by **subtracting** it if the place is **east** of the standard meridian.

210. MERIDIAN OBSERVATIONS ON POLARIS WITH THE COMPASS.— In determining a meridian with the compass the observations are made as described for the transit except that the following modifications will be necessary. Suspend a long plumb-line a few feet away from the point where the instrument is to be set. Since the rear sight is the only part of the compass to be used in the observation it may be unscrewed from the compass and fastened to a piece of board. This board should be placed on a table. The compass sight may then be shifted to the right or left to bring it in line with the star and the plumb-line. The plumb-line should be illuminated by means of a lantern. The direction of the star may be marked by setting stakes in line. If the observation is made at elongation the

meridian should be laid out as described in Art. 207. In finding the declination of the needle the compass is set up over one of the meridian stakes and sighted at the other, when the declination can be read off directly. In order to obtain as nearly as possible the mean value of the declination this should be done at about 10 A.M. or 5 to 6 P.M. because at these times the needle is in its mean position for the day.

211. MERIDIAN OBSERVATION ON POLARIS AT ANY TIME WITH THE TRANSIT. — In order to make this observation, it is necessary to know the local time very closely. As in most cases the time which the surveyor carries is "standard time" it is assumed that such is the case here. The observation itself consists in either marking the direction of the star, as previously described, and noting the time by the watch when the star is sighted; or in repeating the angle between the star and some reference mark, the time of each pointing on the star being noted. In the latter case, take the average of the observed times and assume that it corresponds to the average angle. This is very nearly true if the observations extend over a few minutes of time only.

After finding the standard time of the observation, the next step is to compute the *hour angle* of the star at the time of the observation. Take from the Nautical Almanac: (1) the *right ascension* of Polaris for the date; (2) the *right ascension* of the "*mean sun*" for the date; (3) the *increase* in the *sun's right ascension* since Greenwich noon, which is found in Table III in the Appendix to the Nautical Almanac. Remember that the dates in the Almanac are in Astronomical time (Art. 209, p. 186). Reduce the standard time to local time by adding or subtracting the difference in longitude expressed in hours, minutes, and seconds, remembering that if the place is west of the standard meridian the local time is earlier than standard time and *vice versa*. To the local time add the sun's right ascension and the correction from Table III, Appendix, Nautical Almanac. The result is the *sidereal time*. From this subtract the star's right ascension, and the result is the hour angle of the star reckoned from the meridian from 0^h to 24^h in the direction of the star's apparent motion. Convert this angle into degrees, minutes, and seconds. The azimuth of the star may now be computed from the formula,

$$* \tan Z = \frac{\sin t}{\cos L \tan D - \sin L \cos t}$$

where Z = the azimuth, or true bearing; t = the hour angle; L = the latitude; D = the declination = 90° - the polar distance. If the hour angle is between 0^h and 12^h the star is west of the meridian; if between 12^h and 24^h it is east of the meridian (see Example below).

In the "Manual of Surveying Instruction" issued by the General Land Office a set of tables is given which will enable the surveyor to perform all of the above work by simple inspection and without the aid of the Nautical Almanac.

* See Hayford's Geodetic Astronomy, p. 211, Art. 193.

EXAMPLE.

Observation on Polaris for azimuth April 15, 1908. Latitude $38^{\circ} 58'$. Longitude $92^{\circ} 25'$. Angle between a mark (approximately N.W.) and Polaris is repeated 6 times. Watch $1^m 13^s$ fast. The times are

	8h	35 ^m	40 ^s
	8	37	20
	8	38	50
	8	39	59
	8	41	30
	8	43	00
Mean of 6 readings	8	39	26.2
Watch fast		1	13
True Central time	8	38	13
Longitude of Standard Meridian		6	
Greenwich time	14h	38 ^m	13 ^s

From Nautical Almanac, Right Ascension of "Mean Sun" at Greenwich Mean Noon = $1^h 32^m 57^s.82$; Right Ascension of Polaris = $1^h 25^m 01^s.47$; Declination of Polaris = $+ 88^{\circ} 48' 52''$; Correction from Table III (Nautical Almanac) for Greenwich Time = $14^h 38^m = 2^m 24^s.2$

	$92^{\circ} 25' =$	6h	09 ^m	40 ^s
∴ longitude correction =			09 ^m	40 ^s
Mean of observed times		8h	38 ^m	13 ^s
Longitude correction			9	40
Local time		8	28	33
Right Ascension "Mean Sun"		1	32	58
Correction (Table III)			2	24
Sidereal time		10	03	55
Right Ascension Polaris		1	25	01
Hour Angle Polaris		= 8h	38 ^m	54 ^s
			$t = 129^{\circ} 43' 30''$	
$\log \cos L = 9.89071$			$\log \sin L = 9.79856$	
$\log \tan D = 1.68413$			$\log \cos t = 9.80558$ (n)*	
1.57484			9.60414 (n)	
37.570			- .4019	
.402				
37.972				
		$\log \sin t = 9.88600$		
		$\log \text{denominator} = 1.57946$		
		$\log \tan Z = 8.30654$		
		$Z = 1^{\circ} 09' 37''$ W. of N.		

* The n after the logarithm indicates that the number corresponding is negative.

212. SOLAR OBSERVATIONS. — Where great accuracy is not required many surveyors prefer solar observations because they can be made without much additional work, while star observations have to be made at night and require special arrangements for illuminating the field of view and the mark. If it is sufficient for the purpose in view to obtain the azimuth within $\frac{1}{2}$ minute of angle solar observations will answer. In making these observations with the ordinary transit it is necessary to have some means of cutting down the sun's light so that it will not be too bright for the eye while making pointings. This is usually effected by placing a dark glass over the eyepiece. A dark glass in front of the objective will introduce error into the pointings unless the faces of this glass have been made plane and exactly parallel. If the instrument is not provided with a dark glass the observation may be made by holding a white card back of the eyepiece while the telescope is pointing at the sun. If the eyepiece tube is drawn out the sun's disc and the cross-hairs can both be sharply focused on the card. By this means pointings can be made almost as well as by direct observation. It is also well to cut down the amount of light entering the objective by having a cap with a hole in the center or by using a piece of tracing cloth as explained in Art. 207, p. 182.

213. OBSERVATION FOR MERIDIAN BY EQUAL ALTITUDES OF THE SUN IN THE FORENOON AND AFTERNOON. — This observation consists in measuring in the forenoon the horizontal angle between the sun and some reference mark at the instant when the sun has a certain altitude, and again measuring the angle when the sun has an equal altitude in the afternoon. If the distance of the sun from the equator were the same in the two cases the horizontal angles between the sun and the meridian would be the same in both observations, hence the mean of the two readings of the horizontal circle would be the reading for the meridian. But since the sun is changing its distance from the equator the measured angles must be corrected accordingly. The correction is computed by the equation

$$X = \frac{d}{\cos L \sin t}$$

in which X = the correction to the mean vernier reading, d = the hourly change in declination of the sun taken from Table 10 and multiplied by half the number of hours between the two observations, L = the latitude, and t = half the elapsed time converted into degrees, minutes, and seconds. Since the hourly change for any given day is nearly the same year after year an almanac is not necessary but the table given below is sufficient.

TABLE 10.

HOURLY CHANGE IN THE SUN'S DECLINATION.

	1st.	10th.	20th.	30th.
January	+12"	+22"	+32"	+41"
February	+43	+49	+54
March	+57	+59	+59	+58
April	+58	+54	+49	+46
May	+45	+39	+39	+23
June	+21	+12	+02	-09
July	-10	-19	-28	-36
August	-38	-44	-49	-54
September	-54	-57	-58	-59
October	-58	-57	-54	-49
November	-48	-42	-34	-25
December	-23	-14	-02	+10

The observation is made as follows:— * at some time in the forenoon, preferably not later than 9 o'clock, the instrument is set up at one end of the line the azimuth of which is to be found, and one vernier is set at 0° . The vertical cross-hair is then sighted at the other end of the line and the lower plate clamped. The upper clamp is loosened and the telescope turned until the sun can be seen in the field of view. The horizontal cross-hair is to be set on the **lower** edge of the sun and the vertical cross-hair on the **left** edge. Since the sun is rising and also changing its bearing it is difficult to set both of the cross-hairs at once and it will be found easier to set the horizontal hair so that it will cut across the sun's disc leaving it clamped in this position while the vertical hair is kept tangent to the left edge of the sun by means of the upper tangent screw. When the sun has risen until the lower edge is on the horizontal hair

* The nearer the sun is due East or due West, the better the result.

the instrument is in the desired position and after this position is reached the upper tangent screw should not be moved. As soon as this position is reached the time is noted. Both the vertical and the horizontal circles should now be read and the angles recorded.

In the afternoon, when the sun is found to be nearly at the same altitude as at the forenoon observation, the instrument should be set up at the same point and again sighted on the mark. The observation described above is repeated, the pointings now being made on the **lower** and **right** edges of the disc. The telescope is inclined until the vernier of the vertical circle reads the same as it did at the forenoon observation. When the sun comes into the field the vertical hair is set on the right edge and kept there until the lower edge is in contact with the horizontal hair. The time is again noted and the verniers are read. If desired, the accuracy may be increased by taking several pairs of observations. The mean of the two circle readings (supposing the graduations to be numbered from 0° to 360° in a clockwise direction) is now to be corrected for the sun's change in declination. The correction as obtained by the formula given on p. 190 is to be added to the mean vernier reading if d is minus, and subtracted if d is plus, i.e., if the sun is going south the mean vernier reading is east of the south point, and *vice versa*. When the circle reading of the south point is known the true bearing of the mark becomes known and the bearings of other points may be found (see Example below).

The disadvantage of this method is that it is necessary to be at the same place both in the forenoon and afternoon, whereas in many cases the surveyor might in the afternoon be a long distance from where he was working in the forenoon.

EXAMPLE.

Latitude $42^{\circ} 18' N$. April 19, 1906.

A.M. Observation.

Reading on Mark, $0^{\circ}00'00''$
 Pointings on Upper and Left Limbs.
 Vertical Arc, $24^{\circ}58'$
 Horizontal Circle, $357^{\circ}14'15''$
 Time $7^h19^m30^s$

P.M. Observation.

Reading on Mark, $0^{\circ}00'00''$
 Pointings on Upper and Right Limbs.
 Vertical Arc, $24^{\circ}58'$
 Horizontal Circle, $162^{\circ}28'00''$
 Time $4^h12^m15^s$

$\frac{1}{2}$ elapsed time = $4^{\text{h}}26^{\text{m}}22^{\text{s}}$ = $66^{\circ}35'30''$ log sin l 9.96270 log cos L 9.86902 9.83172 log $230'' \cdot 9$ 2.36342 2.53170 correction 340'' \cdot 2 = $5'40'' \cdot 2$	Increase in declination in $4^{\text{h}}26^{\text{m}}22^{\text{s}}$ = $52'' \times 4.44 = 230'' \cdot 9$ Mean circle reading = $79^{\circ}51'08''$ 540 $\overline{S 79^{\circ}45'28'' E}$ Azimuth of mark = $280^{\circ}14'32''$
--	---

214. OBSERVATION FOR MERIDIAN BY A SINGLE ALTITUDE OF THE SUN. — The azimuth of a line may be obtained by measuring a single altitude of the sun with the transit and computing the azimuth by spherical trigonometry. The instrument is set at 0° and pointed at a mark. The upper clamp is loosened and pointings made as follows. First, the cross-hairs are set on the **left** and **lower** limbs of the sun and both circles are read; the time is also noted. If desired several sets of observations may be made. Second, the cross-hairs are set on the **right** and **upper** limbs, and the reading of the circles and the time are again recorded. The mean of the vertical circle readings is taken, and corrected for atmospheric refraction by subtracting the correction given in Table 11. This corrected mean is called h in the formula given below.

TABLE 11.

REFRACTION CORRECTION.

Altitude.	Refraction.	Altitude.	Refraction.
10°	5' 19''	20°	2' 39''
11	4 51	25	2 04
12	4 27	30	1 41
13	4 07	35	1 23
14	3 49	40	1 09
15	3 34	45	0 58
16	3 20	50	0 49
17	3 08	60	0 34
18	2 57	70	0 21
19	2 48	80	0 10

In order to compute the azimuth it is necessary to know the latitude of the place. This may be obtained from a reliable map or from an observation as described in Art. 216, p. 196. It is also necessary to know the declination of the sun at the instant of the observation; this is found as described in Art. 86, p. 68. If Z represents the azimuth of the sun's center from the south; L , the latitude; h , the altitude; p , the distance from the north pole to the sun (or 90° -declination); and $s = \frac{1}{2}(L + h + p)$; then

$$\cot^2 \frac{1}{2} Z = \frac{\sin (s - L) \sin (s - h)}{\cos s \cos (s - p)}$$

Five place logarithms will give the value of Z within 10 seconds of angle, which is amply accurate for this observation.

When the true bearing of the sun is known the bearing of the mark from the instrument can be found.

EXAMPLE.

OBSERVATION ON SUN FOR AZIMUTH.

Latitude $42^{\circ} 21' N.$ Longitude $4^h 44^m 18^s W$
 Time, Nov. 28, 1905, A.M.

	Horizontal Circle		Vertical Circle	Watch
	Vernier <i>A B</i>			A.M.
Mark	238	14' 14'		
Right and Lower Limbs	311	48 48.5	$14^{\circ} 41'$	8h 39 ^m 42 ^s
" " " "	312	20 20	15 00	8 42 19
The inst. reversed				
Left and Upper Limbs	312	27 26.5	15 55	8 45 34
" " " "	312	52 51.5	16 08	8 47 34
Mark	238	14 14		
Mean reading on Mark =	238°	$14'.0$	Mean = $15^{\circ} 26'$	Mean = $8^h 43^m 47^s$
" " " Sun =	312	21.7		5
Mark N. of Sun =	74.	07'.7	Greenwich Time =	$13^h 43^m 47^s$
Observed Altitude	$15^{\circ} 26'.0$		Sun's apparent declination at	
			Greenwich Mean Noon =	$- 21^{\circ} 14' 54''.4$
Refraction	3.5		Difference for 1 hour =	$- 26''.81$
True Altitude	$15^{\circ} 22'.5 = h$		$- 26''.81 \times 13^h.73 =$	$- 6'08'' 1$
			Declination =	$- 21^{\circ} 21' 02''.5$
			Polar Distance =	$111^{\circ} 21' 02''.5$
			$\log \sin (s - L) =$	9.82708
			$\log \sin (s - h) =$	9.97062
			$\log \sec s =$	1.02132
			$\log \sec (s - P) =$	0.04940
				2) 0.86842
			$\cot \frac{1}{2} Z =$	0.43421
			$\frac{1}{2} Z =$	$20^{\circ} 12'.4$
			$Z =$	$40^{\circ} 24'.8$ East of South
			Mark N. of Sun	$74^{\circ} 07'.7$
				$114^{\circ} 32'.5$
			Mark N	$65^{\circ} 27'.5 E$

215. OBSERVATION FOR MERIDIAN BY MEANS OF THE SOLAR ATTACHMENT.— This observation has been described in detail in Art. 85, p. 66.

OBSERVATIONS FOR LATITUDE.

216. (1) BY THE ALTITUDE OF POLARIS AT UPPER OR LOWER CULMINATION. — When Polaris is approaching either culmination (see Art. 206, p. 180, and Fig. 83) set up the transit and point the horizontal hair on the star. Keep the cross-hair pointed on the star until the culmination is reached. Read the vertical arc and determine the index correction. The altitude is to be corrected for refraction by Table 11, p. 193. This gives the true altitude. If Polaris is at upper culmination subtract from the true altitude the polar distance of the star at the date of the observation (Table 8, p. 184). If the star is at lower culmination the polar distance is to be added. The result is the latitude of the place of observation.

217. (2). BY THE ALTITUDE OF THE SUN AT NOON.—The observation consists in finding the greatest altitude of the sun's lower limb. This will occur when the sun is on the meridian (very nearly). Begin the observation a little before *apparent* noon, remembering that this differs sometimes as much as 17^m from *mean* noon.* Furthermore it should be remembered that standard time may differ a half hour or so from *mean* time. When the maximum altitude is found the following corrections are to be made: first, the refraction correction is to be subtracted (Table 11, p. 193); second, the sun's semi-diameter (found in the Nautical Almanac) is to be added; third, the sun's declination is to be subtracted if plus or added if minus. The result, subtracted from 90° , is the latitude.

* *Apparent* noon occurs when the sun is on the meridian. *Mean* noon is the instant when the sun would be on the meridian if it moved at a uniform rate along the equator. The difference between the two is known as the *Equation of time* and may be found in the Nautical Almanac. For example, on November 1st, the sun passes the meridian $16^m\ 18s$ before *mean* noon, i.e., when it is $12^h\ 00m\ 00s$ *apparent* time it is $11^h\ 43^m\ 42s$ *mean* time.

EXAMPLE.

Observed maximum altitude of the sun's lower limb on Jan. 8, 1906. =	25° 06'	Index Correction = + 1'
Observed altitude	25° 06'.0	
Index Correction	1'.0	
	25° 07'.0	Declination of sun at Greenwich mean noon = - 22° 19' 35" (S)
Refraction	2'.0	
	25° 05'.0	+ 1 33
Sun's semi-diameter	16'.3	- 22° 18' 02" (S)
Altitude of sun's center	25° 21'.3	
Declination	- 22° 18'.0	
	47° 39'.3	
Latitude	42° 20'.7	Diff. 1h = + 19".58 + 19".58 × 4 ^h .74 = + 1' 33"

PROBLEMS.

1. (a) What was the azimuth of Polaris at its greatest western elongation at Boston when the polar distance of the star was $1^{\circ} 14' 12''$? The latitude of Boston is $42^{\circ} 21' N$.

(b) In making an observation for meridian two stakes were set 329 feet apart, marking the direction of the star at elongation. Compute the length of the perpendicular offset to be laid off at one end of the line to obtain the true meridian.

2. What is the approximate Eastern Standard Time of the eastern elongation of Polaris on August 10th at a place in longitude $72^{\circ} 56'$ West?

3. Observation on May 15, 1906, for determining the azimuth of a line from an altitude of the sun. Reading of vernier A of the horizontal circle while pointing on the azimuth mark = $0^{\circ} 00'$. At first pointing on sun, lower and right limbs, vernier A, horizontal circle read $168^{\circ} 59'$; vertical arc read $43^{\circ} 36'$; the Eastern Standard Time was 2^h 52^m 45^s P.M. At second pointing on the sun, upper and left limbs, vernier A, read $168^{\circ} 52'$; vertical arc, $42^{\circ} 33'$; time, 2^h 55^m 37^s P.M. The second pointing on the mark = $0^{\circ} 00'$, the mark being to the left of the sun. The sun's declination at Greenwich Mean Noon was $+ 18^{\circ} 42' 43''.6$ (North). The change for 1 hour was $+ 35''.94$ (sun going north). The latitude of the place was $42^{\circ} 17' N$; The longitude was $71^{\circ} 05' W$. Find the azimuth of the mark.

4. Observation for latitude. The observed altitude of Polaris at upper culmination was $43^{\circ} 27'$. The polar distance of the star was $1^{\circ} 12'$. What was the latitude of the place?

5. Observation for latitude. The observed maximum altitude of the sun's lower limb on August 10th, 1906, was $66^{\circ} 29'$. The Eastern Standard Time was approximately 11^h 50^m A.M. The semi-diameter of the sun was $15' 48''.7$. The declination of the sun at Greenwich Mean Noon was North $15^{\circ} 46' 13''.3$ (+). The difference for 1 hour was $-43''.46$ (sun going south). What was the latitude of the place?

CHAPTER VIII.

LEVELING.

218. DEFINITIONS. — Leveling consists in ascertaining differences in elevation; there are two kinds, *Direct Leveling*, and *Trigonometric Leveling*. The former alone will be considered in this book, as trigonometric leveling is used only in advanced surveying work.

Wherever extensive leveling operations are to be carried on it is necessary to have a system of reference points called *bench marks* (*B.M.s.*), the relative heights of which are accurately known. These heights are usually referred to some definite zero plane, such, for instance, as *mean sea-level* or *mean low water*, and the height of a point above this plane is called its *elevation*. This plane is called the *datum*. (See Art. 237, p. 211, and Art. 250, p. 226.) Strictly speaking it is not a plane but a level surface, i.e., it is at every point perpendicular to the direction of gravity. If mean sea-level is not known a datum can be arbitrarily assumed.

219. LEVELING TO ESTABLISH BENCH MARKS. — When it is necessary to run a line of levels to establish new bench marks the rod is first held on some bench mark the elevation of which is accurately known, and a backsight taken (Art. 116, p. 85). If this backsight is added to the known elevation of the bench mark it gives the *height of the instrument* (*H. I.*) above the datum. A *turning point* is then selected ahead on the route (to be traversed), and a foresight taken on it. (See Art. 224, p. 202.) If the foresight is subtracted from the height of the instrument the elevation of the turning point is obtained. When a target rod is used it is customary to take readings on bench marks and turning points to thousandths of a foot, and in this case often more than one rod-reading is taken on each point. If the first and second readings agree within 0.002 ft. it is unnecessary to take more readings; if they differ by a greater amount it may be necessary to take three or four or even more readings to properly determine the correct value. The object of taking

more than one reading is not so much to increase the precision as to check the former readings.

When it is desired to establish a bench mark a suitable point is selected and **used as a turning point**. The elevation of this bench mark could be obtained by simply taking a foresight upon it and not using it as a turning point, but by making the bench mark also a turning point it becomes a part of the line of levels and if the levels check, the elevation of the bench mark is also checked. Each bench mark established should be carefully recorded by a description or a sketch, or both. The elevations of the remaining turning points are as accurate as the elevations of the bench marks themselves, so that any of the turning points might be used as a bench mark. Consequently it is advisable to describe those turning points which can be readily identified so that they may be used when it is not convenient or possible to use one of the established bench marks.

In leveling up or down slopes the levelman should be able to judge quickly where to set his instrument in order to have it the desired height above the turning point. In going downhill the rod-reading of the backsight should be as small as possible in order to overcome the height with the minimum number of set-ups of the level. But while the levelman may waste much time by having large backsights necessitating additional set-ups, it is also possible for him to waste quite as much time in attempting to place his instrument so as to get very small backsights. The proper way to handle the instrument is as follows. Set up roughly (without pressing the tripod legs into the ground), turn the telescope toward the rod and then level it, approximately, in that direction. By sighting along the outside of the telescope, the approximate place where the line of sight will strike the rod can be noted and the distance the instrument should be moved up or down the slope can readily be estimated. Then move to the new position, level up carefully, and proceed to take the backsight. This general procedure should be followed whether leveling up or down a slope.

220. In this work it is very important to eliminate as far as possible errors of adjustment in the instrument. If at every set-up of the level the foresight and its corresponding backsight are

taken at points which are equally distant from the instrument such errors will be eliminated. If the level is not in perfect adjustment the resulting error in any reading is proportional to the distance. At equal distances from the instrument the errors are equal, and, since it is the difference of the rod-readings that gives the difference in elevation, the error is eliminated from the final result by this method. By making the length of foresights and backsights equal on turning points it is possible to eliminate not only the error due to non-adjustment of the bubble but also any error due to non-adjustment of the objective tube, since this will occupy the same position in the telescope in each sight. The distance to the backsight is determined by the place where the instrument is set up, and the rodman, as he passes from one turning point to the next, can by pacing make the foresight distance approximately equal to that of the backsight. The line of levels should be "closed" by continuing the leveling until the original bench mark, or some other bench mark whose elevation is well established, is reached.

221. The notes for this work may consist of five columns, as shown in Fig. 86. The height of instrument is obtained by adding the backsight to the elevation of the point on which it is taken. The elevation of any point is found by subtracting the foresight for that point from the height of the instrument. Notice that the

LEFT-HAND PAGE.					RIGHT-HAND PAGE.	
<i>B.M. Leveling for Eastern Intercepting Seme.</i>					<i>B. Jones & M. Brown Oct. 30, 1905.</i>	
<i>Point</i>	<i>B.S.</i>	<i>H.I.</i>	<i>FS</i>	<i>Elev.</i>	<i>Remarks.</i>	
<i>B.M.₁</i>	<i>4.122</i>	<i>93.139</i>		<i>89.017</i>	<i>Top S.E. cor. granite foundation S.E. cor. City Hall.</i>	
<i>T.P.₁</i>	<i>3.661</i>	<i>90.611</i>	<i>6.189</i>	<i>86.950</i>	<i>Curb.</i>	
<i>T.P.₂</i>	<i>4.029</i>	<i>89.630</i>	<i>5.010</i>	<i>85.601</i>	<i>N.E. bolt top hydrant opp. 42 Main St.</i>	
<i>B.M.₂</i>	<i>3.901</i>	<i>86.161</i>	<i>7.370</i>	<i>82.260</i>	<i>S.W. cor. S. B. on N.W. cor. Main and Broad Sts.</i>	
<i>B.M.₃</i>	<i>3.512</i>	<i>83.058</i>	<i>6.617</i>	<i>79.544</i>	<i>N.W. cor. lower stone step 82 Broad St.</i>	
<i>T.P.₃</i>	<i>6.007</i>	<i>80.348</i>	<i>8.715</i>	<i>74.341</i>	<i>Cobble stone.</i>	
<i>B.M.₄</i>			<i>9.070</i>	<i>71.278</i>	<i>Chisel cut N.W. cor. C. B. curb S.W. cor. Broad and State Sts. True elev. B.M. = 71.274 Book 27, P. 36.</i>	

FIG. 86. BENCH MARK LEVEL NOTES.

calculations may be checked by adding the foresights and the backsights. The difference of these sums should be the same as the difference in elevation between the first and last points.

222. Double Rodded Lines.— A good check on the line of levels may be secured by running a double line of turning points. Instead of taking a foresight on a single turning point, foresights may be taken on two different points near together, from the same set-up of the instrument. When the level is set up again a backsight is taken on each turning point and two independent values of the new height of instrument are obtained. In ordinary bench mark leveling these two values should not differ by more than 0.002 or 0.003 ft. from the previous difference, i.e., if the two heights of instrument differed by 0.013 at a certain set-up they should not differ by more than 0.016 nor less than 0.010 at the next set-up. If the two turning points of a pair are so chosen that their difference in elevation is more than a foot then any mistake of a foot in the computations or in reading the rod will be immediately detected.

In this way, by little additional work the accuracy of the levels may be checked as the work progresses. This method of using double turning points is particularly useful in running long lines of levels where no established bench marks are available for checking.

223. A set of notes illustrating double turning points is shown in Fig. 87. It will be noticed that the higher and lower

LEFT-HAND PAGE.					RIGHT-HAND PAGE.
B.M. Levels - Bridge #67 to Mile Post #45 A.&B. R.R.					April 17, 1906. <i>(Smith Lowe & Rich)</i>
Sta.	B.S.	H.I.	F.S.	Elev.	Description
B.M. ₆	4.691	50.265		46.274	N.E. cor. W. Bridge seat bridge #67 A.&B.R.R.
TP ₁ L.	6.040	49.721	7.284	43.681	
TP ₁ H.	4.441	49.719	5.687	45.278	
TP ₂ L.	10.641	53.621	6.741	42.980	
TP ₂ H.	7.902	53.617	4.004	45.715	
B.M. ₇ L.	4.805	54.748	3.678	49.943	S.E. cor. stone step S. side Jamaston Sts.
TP ₃ H.	2.972	54.747	1.042	51.775	
TP ₄ L.	4.959	55.027	4.680	50.068	
B.M. ₈ H.	3.489	55.029	3.207	51.540	d.h. S.W. cor. first step W. wing N. abut. bridge #70 A.&B.R.R.
B.M. ₉			2.709	52.318	
				52.320	52.318 Top Mile post #45.

FIG. 87. BENCH MARK LEVEL NOTES, DOUBLE RODDED LINES.

turning points of a pair are arranged in a systematic order. The readings in this case have been taken on the lower turning point first at each set-up. It is very important that some definite system shall be followed so that the two lines of levels will not be confused.

224. Bench Marks and Turning Points. — Both the bench marks and the turning points should be such that their elevations will not change during the time they are needed. The only difference between the two is that turning points may be of use for only a few minutes while bench marks may be needed for many years. Bench marks should be very carefully and accurately described, and their heights should be checked before being accepted as correct. They are frequently taken on such points as these:— stone bounds, tops of boulders, spikes in trees, and on sills, stone steps, or underpinning of buildings. Curb stones or tops of hydrants are also used but are not so permanent. As it is often impossible in a new country to find existing points where bench marks can be established, it is usual in such cases to set stone monuments or iron rods and to carefully determine their elevation. The U. S. Geological Survey, for example, sets an iron pipe with a cap on the top of it; or in some cases a plate with a horizontal line across it in the masonry wall of a building. Some of the bench marks of the U. S. Coast and Geodetic Survey and of the Missouri River Commission consist of stones buried 3 or 4 ft. under ground. The exact bench is the top of a spherical headed bolt set in the top of the stone. This is reached by lowering the rod through an iron pipe which extends to the surface of the ground.

Bench marks should be established at frequent intervals for convenience in dependent work. Some surveyors consider it advisable to have two bench marks in the same locality to serve as checks on each other. In choosing a bench or a turning point it is best to select a point which is slightly raised so that the rod will always rest on exactly the same point. A rounded surface is better than a sharp point, especially when it is on a rock, as the rod may chip off a small piece and alter the elevation. If a turning point is taken on a flat surface it is difficult to get the rod at exactly the same height each time. Bench

marks are, however, sometimes established on flat level surfaces such as the coping stone of a masonry structure, because permanence is of more importance than great precision. Bench marks are not only described in the notes, but are themselves frequently marked by red chalk, by chisel marks, or drill-holes.

225. LEVELING FOR PROFILE. — Profile leveling is for the purpose of determining the changes in elevation of the surface of the ground along some definite line. The line is first "stationed," i.e., marked at every hundred feet or such other interval as is desired. The level is set up and a backsight taken on a bench mark to determine the height of the instrument. Foresights are then read on as many station points on the line as can be conveniently taken from the position of the instrument. Intermediate sights are taken at any points where marked changes of slope occur, and the plus stations of these intermediate points are recorded with the rod-readings. It will be noticed that here the terms foresight and backsight do not refer to the forward and backward directions. **A backsight is a reading taken on a point of known elevation for the purpose of obtaining the height of the instrument. A foresight is a reading taken on a new point to determine its elevation.** For this reason backsights are frequently called *plus sights* (+ *S*), and foresights are called *minus sights* (– *S*). When it is necessary to move the level to a new position in order to take readings on stations ahead, a turning point is selected and its elevation determined. The level is then taken forward and its new height of instrument determined by taking a backsight on the turning point. This general process is continued until the end of the line is reached.

A line of levels should be checked by connecting with some reliable bench mark if possible. If there are any bench marks along the line of levels they should be used as turning points if convenient, or at least check readings should be taken on them in order to detect mistakes. In such a case it is evident that the reading taken on the bench mark is really a foresight since its elevation is being found anew from the height of instrument. Readings on bench marks and turning points should be taken to thousandths or to hundredths of a foot, depending upon the accuracy desired. If the elevations of the profile are de-

sired to the nearest hundredth of a foot, as in the case of a railroad track, the turning points should be taken to thousandths of a foot. Elevations on the surface of the ground will not usually be needed closer than to tenths in which case the T. Ps. are taken only to hundredths. In calculating the elevations the results should not be carried to more decimal places than the rod-readings themselves, otherwise the results will appear to be more accurate than they really are.

LEFT-HAND PAGE.					RIGHT-HAND PAGE.	
Profile of Meadow Park Road.					Sept. 16, 1904. (From Markings W Jacobs)	
Sta.	+S	H.I.	-S	Elev	B.M. & T.P. Elev.	Description
B.M. ₀	12.23	34.98			22.748	d.h. in wall near Sta. 0
0			9.8	25.2		
1			6.6	28.4		
2			3.0	32.0		
T.P. ₁	11.18	44.73	1.43		33.55	Stump
3			6.1	38.6		
+65			2.7	42.0		
4			3.7	41.0		
+20.7			5.2	39.5		
5			6.7	38.0		
6			11.2	33.5		
T.P. ₂	3.48	42.59	5.62		39.11	Nail in stump 60' W. Sta. 6+00.
7			10.2	32.4		
8			8.6	34.0		
9			7.6	35.0		
+62.4			4.0	38.6		
10			2.4	40.2		
+49			1.1	41.5		
11			2.6	40.0		
12			8.0	34.6		
T.P. ₃	0.42	31.89	11.12		31.47	Boulder
13			2.8	29.1		
14			8.7	23.2		
+23.8			11.2	20.7		
B.M. ₄	0.63	27.79	4.73		27.16	Elev. = 27.14 (Book 12, p. 25) Highest point large isolated boulder 200' E. Sta. 16.
15			6.8	21.0		
16			7.2	20.6		
17			8.1	19.7		
18			9.0	18.8		
+54			9.2	18.6		

FIG. 88. PROFILE LEVEL NOTES.

226. Profile notes are kept as shown in Fig. 88. In this case also the heights of instrument and the elevations of turning points may be checked by means of the sums of the foresights and backsights, provided only the sights on turning points and the initial and final benches are included. If it seems desirable the elevations of stations may be checked by means of

differences in foresights. The difference between the elevations of any two points, which are obtained at the same set-up of the instrument, is equal to the difference between the foresights taken on these points. For example, if the difference between the foresights on stations 4 and 5 is 3 ft. this should also be the difference between their elevations. In these notes the elevations of B. Ms. and T. Ps. are put in a different column from the surface elevations simply for the sake of clearness, but many surveyors prefer to put all the elevations in the same column. Another arrangement of columns which will be found convenient when plotting the notes is to place the station column immediately to the right of the elevation column.

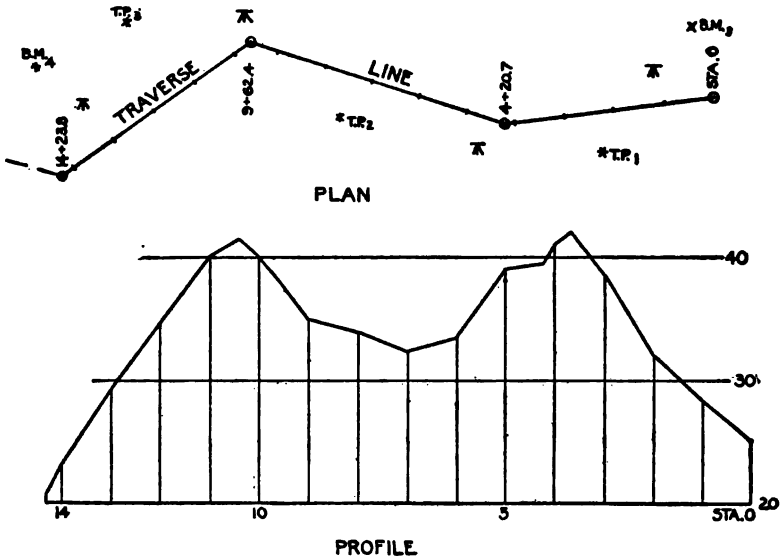

FIG. 89.

Fig. 89 represents a rough plan and profile of the line of levels shown by the notes in Fig. 88. Angle points in the transit line are shown in the plan, but they do not appear in the profile of the line. It will be noticed that the T. Ps. and B. Ms. are not on the transit line in plan, and that they consequently do not appear on the profile. It is not customary to introduce

any sketches into the profile notes except those used in describing bench marks or turning points.

227. **CROSS-SECTIONING.** — If it is desired to know the shape of the surface of a piece of ground, the area may be divided into squares and the elevation taken at each corner of these squares and at as many intermediate points as seem necessary to determine the changes of slope. These surface elevations are obtained to tenths of a foot. The squares which may be anywhere from 10 ft. to 100 ft. on a side are laid out with the transit and tape, stakes being driven at the corners. It is well to choose some long line of the traverse as the primary line from which the cross-section system is to be laid out. The points are usually designated by a system of rectangular coördinates, one set of parallel lines being marked by letters and the other by numbers, as shown in Fig. 90. For example, the

LEFT-HAND PAGE.					RIGHT-HAND PAGE.	
Cross-Sections for Grading the A.M. Cole Estate, Westfield.					March 10, 1905. <i>(Match Align & Tolls)</i>	
Sta.	+s.	H.I.	-S	Elev.		
B.M.	3.02	124.92		121.90		
A 4			1.2	123.7	<p style="text-align: center;">100 f. Squares.</p>	
A 5			1.7	123.2		
A 6			2.4	122.5		
B 6			2.9	122.0		
B 5 + 40			2.8	122.1		
B 5			2.0	122.9		
B 4			1.8	123.1		
B + 60, 4			1.8	123.1		
C 4			3.0	121.9		
B + 80, 40			0.8	124.1		
C 5			5.0	119.9		
C 6			7.2	117.7		
D 6			8.9	116.0		

FIG. 90. CROSS-SECTION LEVEL NOTES.

point *p* would be called (*C*, 7); the point *s*, (*D*, 5); the point *r*, (*B* + 80, 4 + 35); etc. The notes are kept as in profile leveling except as to designation of points.

228. **Use of the Tape Rod in Cross-Section Work.** — In this work, where there are a large number of elevations to be calculated, it will save much time to use a tape rod (Art. 106, p. 81), which is so arranged that no elaborate figuring is required. In this rod the numbers increase from the top toward the bottom, the opposite way from ordinary rods. The level is

set up at a convenient point and the rod held on a bench mark. The tape, or band, on the rod is then moved up or down as directed by the levelman until he reads the feet, tenths, and hundredths which are the same as those of the elevation of the bench mark, e.g., if the elevation of the B. M. is 195.62, the tape will be moved until it reads 5.62. If the rod is then held on a point 1.61 ft. lower than the bench, the rod-reading will be 4.01, since with this rod the readings decrease as the rod is lowered. The elevation of the point is then 194.01 ft., or sufficiently precise for topographic work, 194.0 ft. In this way the elevations are read directly on the rod to feet and decimals of feet, the tens and hundreds of feet being supplied mentally. Obviously the only notes kept are the columns of stations and elevations.

229. CROSS-SECTIONING FOR EARTHWORK. — Whenever it is desired to ascertain the quantity of earthwork in an excavation or an embankment, it is necessary to take levels to determine the vertical dimensions, and to obtain the horizontal dimensions by means of the transit and tape. The three general cases where the quantity of earthwork is to be estimated by the engineer are: (1) an excavation or embankment having a known base and side slopes as in the construction of a railroad or a highway, (2) an irregular excavation from a bank of earth called a *borrow-pit*, (3) a trench excavation such as is used for sewer construction.

230. (1) Road Cross-Sections. — Cross-sections for estimating the earthwork in highways or railroads are usually taken at full station points (sometimes oftener) and at right angles to the center line of the road.* By this method is obtained a section of the general shape shown in Figs. 91 and 92. These cross-sections are taken in the field before the construction begins so that a proper record of the surface heights can be obtained before the ground is disturbed.

From the plan of the proposed road its alignment is staked out and a profile is taken along the center line, which is subsequently plotted (Art. 225, p. 203). On this profile the *grade line* is drawn, which corresponds to the finished surface of the road. Roads are usually first finished to *sub-grade*, which is below the

* For a more complete treatment of this subject see "Railroad Curves and Earthwork," by Professor C. F. Allen, published by Spon & Chamberlain, New York.

completed surface by an amount equal to the thickness of the road covering, i.e., the pavement of a highway or the ballast in the case of a railroad. The width of the base of the road and the inclination of the side slopes are known. For ordinary gravel the slope is usually $1\frac{1}{2}$ ft. horizontal to 1 ft. vertical, called "a slope of $1\frac{1}{2}$ to 1."

For construction work the engineer sets grade stakes at every full station or oftener on the center line and at both sides where the finished slope intersects the surface of the ground, e.g., at points *A*, *B* and *C* on Figs. 91 and 92. All of these

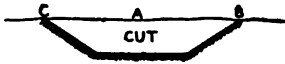

FIG. 91. EXCAVATION.

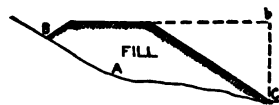

FIG. 92. EMBANKMENT.

stakes are marked, giving the amount of "cut" or "fill" to be made at these points. The cut or fill marked on the stakes at *B* and *C* is the vertical distance from the base of the road to the surface of the ground at these points, e.g., the distance *bC*.

These cuts and fills are determined in the field by the following method. The level is set up and the height of instrument obtained from some convenient bench mark. Then, the elevation of the finished grade being known (from the profile prepared in the office), the difference between the height of instrument and the elevation of the finished road will give what is called the *rod-reading for grade*, i.e., the rod-reading which would be obtained if the foot of the rod could be held on the finished surface of the road. Then the rod is held on the surface of the ground at the center stake and a reading is taken (to the nearest tenth of a foot), and the difference between the rod-reading for grade and the rod-reading on the surface will give the cut or fill at that point, and this is marked on the center grade stake thus, C5.2 or F4.7.

231. SETTING SLOPE STAKES.—The points where the side slopes intersect the surface of the ground are found by trial as follows. Hold the rod at a point where it is estimated that the side slope will cut the surface, and take a rod-reading. The difference between this rod-reading and the rod-reading for

grade will give the cut or fill at this point, from which the distance out from the center of the section to the point on the side slope having this cut can be computed. This distance out equals ($\frac{1}{2}$ base + cut \times slope). Then the distance is measured from the center to the rod, and if the measured distance equals the computed distance the rod was held at the right place and the stake should be driven and marked with the cut or fill at that point (distance bC , Fig. 92). If the measured distance does not agree with the calculated distance a second trial must be made by holding the rod at another point and repeating the operation. The difference between the measured and calculated distances is an aid in judging where the rod should be held at the second trial. After a little practice it will be possible to set the slope stake at the second or third trial.

232. EARTHWORK NOTES FOR ROAD CROSS-SECTIONS.— The notes for this work will contain the cut or fill at the center, the cut or fill at either side, and the corresponding distances out. A cut is usually written in the notes as a plus (+) height and a fill as a minus (−) height; but the stakes

LEFT-HAND PAGE.

Cross-Section for Jamestown Road. Aug. 17, 1906.						
Sta.	Surface Elev.	Grade Elev.	Cross-Sections. Base 40'-Slope 1/2 to 1.			
12	99.5	96.50	$\frac{29.0}{+6.0}$	$\frac{12.0}{+4.5}$	+3.0	$\frac{15.0}{+4.0}$ $\frac{22.4}{+1.6}$
+50	98.7	96.25	$\frac{27.2}{+4.8}$	$\frac{20.0}{+4.0}$	+2.4	$\frac{20.0}{+3.0}$ $\frac{24.8}{+3.2}$
11	97.6	96.00	$\frac{26.0}{+4.0}$		+1.6	$\frac{25.4}{+3.6}$
10	97.5	95.50	$\frac{23.0}{+2.0}$		+2.0	$\frac{23.0}{+2.0}$

FIG. 93. CROSS-SECTION NOTES FOR A ROAD.

are marked C or F rather than + or −. If the surface is irregular levels are taken at intermediate points and are recorded as shown opposite Sta. 11 + 50, and Sta. 12 in the notes, Fig. 93. Where the surface of the ground is parallel to the

base of the road, as in Sta. 10, the section is called a *Level Section*. Where the surface of the ground is not parallel to the base and where three cuts or fills only are recorded, as at Sta. 11, the section is called a *Three Level Section*. If, besides the three readings which are taken for a three level section, two more intermediate readings are taken one directly over each end of the base, as at Sta. 11 + 50, the section is called a *Five Level Section*. If intermediate readings (one or more of them) are taken anywhere except over the ends of the base, as in Sta. 12, the section is called an *Irregular Section*. For methods of computing the amount of earthwork see Chapter XII.

It will be noticed that in the column of the notes headed "Cross-Sections" the distances out appear above and the corresponding cuts below the lines. Besides this set of notes there is a simple set of level notes similar to Fig. 86, p. 200, from which the height of instrument is determined. This is conveniently kept in another part of the note-book, often at the back of the book.

233. (2) Cross-Sections for Borrow-Pits. — The ground is first staked out in squares or rectangles and the elevation at each corner and at every change in slope is determined as explained in Art. 227, p. 206. Then the work of excavating is carried on, and when it is desired to determine the amount that has been excavated, the same system of cross-sections is again run out and the new elevations at the corners and at the necessary intermediate points are determined.

The notes are kept as shown in Fig. 90, p. 206. For methods of computing the earthwork in borrow-pits see Art. 373, p. 342.

234. (3) Cross-Sections for Trench Excavation. — The surface elevations are determined by making a profile of the line. The grade of the bottom of the trench is obtained either from the plan or by direct leveling. The width of the trench is measured wherever it changes and the stations of these places noted. For methods of computing the quantity of earthwork see Chapter XII.

235. LEVELING TO ESTABLISH A GRADE LINE. — The level may be used for setting points at desired elevations as, for example, in establishing the grade line of a sewer. To set any point at a given elevation, set up the level and take a backsight

on a bench mark, thus determining the height of instrument. Subtract the given elevation from the height of instrument and the result is the rod-reading for grade. Raise or lower the rod until the horizontal cross-hair indicates this reading. The foot of the rod is then at grade. This is usually set for construction work to hundredths of a foot; for some purposes tenths of a foot will be sufficiently exact. If a target rod is used the target is set at the proper reading, and the bottom of the rod is at grade when the cross-hair bisects the target:

If the grade line comes beneath the surface of the ground and cannot be reached a point may be set a convenient whole number of feet above grade and the depth marked on a stake, or *vice versa* if the grade line comes far above the surface.

236. "Shooting in" a Grade Line. — To save time and to diminish the liability of mistakes, grades are often set by a method known as "shooting in" the grade. First set a point at the proper elevation at each end of the straight grade line. The instrument (usually a transit with a telescope bubble) is set up 6 or 8 inches to one side of the first point, and the distance from the top of the first stake to the axis of the telescope is measured with the tape or rod.* Then the rod, which is set at this reading, is carried to the last point on the straight grade line, and, while it is held vertical on this point, the instrument man raises or lowers the telescope until the horizontal cross-hair is on the target, clamping the instrument in this position. If a level is used the horizontal cross-hair is set by means of the leveling screws; but if the transit is used the cross-hair is set by means of the clamp and tangent screw of the vertical motion. The line of sight is then along an inclined line parallel to the grade line. All intermediate points on the grade line are then set by raising or lowering the rod until the target coincides with the horizontal cross-hair.

237. TO ESTABLISH A DATUM PLANE BY MEANS OF TIDAL OBSERVATIONS. — Whenever it is necessary to establish a datum from tidal observations it may be determined as follows. Set up

* Where the grade is flat some surveyors prefer to set the instrument just behind the point instead of to one side of it.

a vertical staff, graduated to feet and tenths, in such a manner that the high and low water can be read. Read the positions of high and low water for each day for as long a period as practicable. The mean value obtained from an equal number of high and low water observations will give the approximate value of mean sea-level. If the observations extend over just one lunar month the result will be fairly good, whereas in less than one month a satisfactory result cannot be obtained; to determine this accurately will require observations extending over several years.

The proper location of the gauge is an important factor in obtaining the true mean sea-level. The place chosen for setting up the gauge should be near the open sea, so that local conditions will not influence the tide. It should be somewhat sheltered against bad weather. The water should be deep so that at the lowest tide the water will stand at same height on the gauge.

At the beginning of the series the zero of the staff and some permanent bench marks should be connected by a line of levels. This should be tested occasionally to see if the staff is moved. After the reading of the rod for mean sea-level is found the elevation of the bench mark can be computed.

238. The Staff Gauge.— This is a form of gauge (Fig. 94) which can be easily constructed, and which is sufficient where only a short series of observations is to be made. If made in sections not over 3 feet long, as described below, it can easily be packed in a box for transportation. Each section consists of two strips of wood about $1\frac{1}{2}$ inches square, and 3 feet long, fastened together at the ends by strips of brass, leaving a space between them of about 1 inch. In this space is placed a glass tube of about $\frac{3}{4}$ inch diameter and held in place by brass hooks. On one side of the tube is a red strip blown into the glass. When the gauge is set up for observations the sections are screwed to

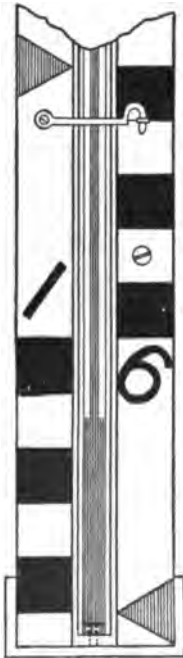

FIG. 84. STAFF GAUGE.

a long vertical piece of joist. The ends of the tube are nearly closed by corks, in which small glass tubes of approximately 1 mm. (inside) diameter have been inserted. When the water rises in the main tube, the red strip appears to be much wider than it really is on account of the refraction of light by the water. Above the water surface the strip appears its true width. By observing the position of the wide strip the height of the water surface can be read within a hundredth of a foot. The heights are read on a scale of feet painted on the wooden strips. If the size of the small glass tube is properly chosen, the fluctuations of the water surface outside will not disturb the water in the tube, so that the reading is a fair average of the water surface. A gauge of this sort may be read by means of a transit telescope or field glass at a distance of several hundred feet.

When a long series of observations is to be made a self-registering tide gauge should be used. A description of such a gauge may be found in the Reports of the U. S. Coast and Geodetic Survey.*

239. LEVELING ACROSS A RIVER. — While the effect of curvature and refraction (Art. 118, p. 87) is usually negligible in leveling operations, it may in certain special cases become of great importance to eliminate this error. For example, it is sometimes necessary to carry a line of levels across a river of considerable width, say, half a mile. In this distance the correction for curvature and refraction amounts to about 0.143 ft. under normal conditions, which in a line of bench levels is too large a quantity to neglect. If the correction as derived from formulas could be depended upon under all circumstances it would be sufficient to compute and apply it to the rod-reading. But the amount of the refraction correction is so variable that the actual value often differs considerably from the computed value.

If it is desired to obtain the difference in elevation between two distant points with great accuracy it will be necessary to use a method which will **eliminate** the effects of curvature and refraction no matter what their actual amount may be. In Fig. 95 suppose a backsight were taken on T. P.₁ with the instrument

* Report for 1897, pp. 315-320 and pp. 480-489.
Report for 1853, pp. 94-96.

at A and then a foresight taken on $T. P._2$. The elevation of $T. P._2$ as computed from $T. P._1$ will be too low by the amount ab , since the foresight on $T. P._2$ is too great by this amount. If the difference in elevation is determined by the instrument at B the backsight on $T. P._1$ is too large by the amount cd . Hence the H. I. of the instrument at B is too great, and consequently

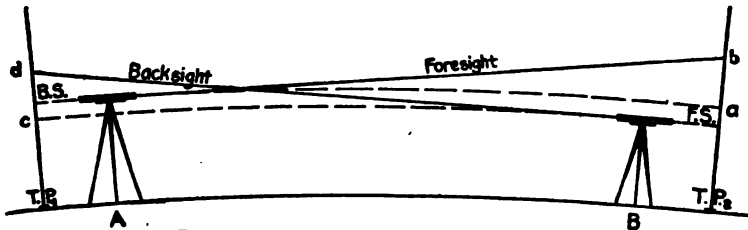

FIG. 95. LEVELING ACROSS A RIVER.

the elevation of $T. P._2$ too great by the amount cd . The mean of the two determinations would give the true elevation of $T. P._2$ if $ab = cd$, but this occurs only when the two sights are taken under the same atmospheric conditions. Therefore it will be seen that the two sights must be taken **simultaneously**. In order to eliminate the errors of adjustment* in the instrument it is necessary to use the same instrument at both ends of the line. To accomplish both of these results at once it is necessary to take simultaneous readings with two instruments and then to repeat the operation with the instruments interchanged. The magnifying powers of the two telescopes and the sensitiveness of the two spirit levels should be about equal in order to give the best results. It will be noticed that this process is similar to that of the peg adjustment (Art. 128, p. 91).

* Errors due to non-adjustment are of unusual importance because the sight is much longer than that used in adjusting the instrument.

PROBLEMS.

1. Compute the following set of level notes.

Sta.	B. S.	H. I.	F. S.	Elev.
B. M. ₁	4.702			16.427
B. M. ₂	11.846		6.727	
T. P. ₁	7.276		9.689	
B. M. ₃	8.760		4.726	
T. P. ₂	0.687		11.000	
B. M. ₄	1.607		8.496	

2. Compute the elevations in the following set of level notes.

Sta.	B. S.	H. I.	F. S.	Elev.
B. M. ₁₃	6.427		4.273	62.473
20			6.2	
21			7.4	
+42			5.2	
22			4.7	
T. P. ₂₇	4.724		9.976	
23			11.2	
+63			10.4	
B. M. ₂₂	0.409		7.482	
24			11.2	

3. Compute the elevations in the following set of level notes.

Sta.	+S.	H. I.	-S.	Elev.
B. M. ₂₄	6.214			84.238
T. P. ₁ L.	3.515		9.280	
T. P. ₁ H.	2.152		7.919	
T. P. ₂ L.	2.971		8.263	
B. M. ₂₅ H.	2.338		7.629	
T. P. ₂ L.	4.278		7.529	
T. P. ₃ H.	2.646		5.894	
B. M. ₂₆ L.	5.721		6.072	
T. P. ₄ H.	4.837		5.187	
B. M. ₂₇			5.817	

4. Make up a set of cross section notes for road construction which shall be consistent with the following data: width of road, 50 ft., slopes 1½ to 1; grade elevation of Sta. 0 = 107.20; grade, + 1 ¼. Show complete notes from Sta. 0 to Sta. 3 inclusive as follows: Sta. 0, a level section; Sta. 1, a three level section; Sta. 2, a five level section; Sta. 3, an irregular section.

CHAPTER IX.

CITY SURVEYING.

240. INSTRUMENTS USED. — Owing to the comparatively high value of land in cities and to the fact that a large proportion of city surveying is the establishing of lines and grades for construction work, the chain and compass are discarded entirely and the steel tape and transit are used.

241. Tapes and Tape Measurements. — The tape most commonly employed is the light 100-ft. steel tape, graduated to hundredths of a foot, described in Art. 7, p. 5. All ordinary measurements are taken in the usual manner, the pull and the horizontal position of the tape being judged by the men taking the measurements. But frequently it is necessary to obtain results with a greater degree of accuracy than is afforded by the ordinary method of measurement. For example, in measuring the base-line for triangulation work or in the survey of the valuable portions of large cities, there is call for an accuracy of measurements which can only be obtained by using a method which will insure a uniform pull on the tape, a careful alignment, little or no sag in the tape, and some means by which the temperature of the tape can be taken and its correction applied to the results. In such cases the pull is measured by use of a tension handle (ordinary spring balance) which can be attached by a clamp to any part of the tape, the alignment is given with the transit, and, where feasible, just enough pull is given so that the stretch in the tape equals the shortage due to sag. The correction for temperature can be computed from the difference between the temperature of the tape taken in the field and the temperature at which it is standardized (Art. 19, p. 13). The tape should be compared with the *City Standard* (Art. 243, p. 218), at a definite tension, and the temperature noted at the time. From this information all of the field measurements can

be reduced to agree with the City Standard and very accurate results may be obtained.

Where the ground is not level and there is call for frequent plumbing it is impossible to obtain accurate results unless the plumbing is carefully done by experienced tapemen. For very accurate work it may be desirable to entirely eliminate the plumbing. This is sometimes done by measuring directly on the surface (on the slope) from point to point, and by means of the level instrument and rod the relative elevations of these points are obtained and the horizontal projection of the slope distances computed. Instead of measuring the difference in elevation between the two ends of the line, the angle of inclination of the slope line is often measured on the vertical arc of a transit which is set up over one of the end points.

The government Bureau of Standards at Washington will, for a nominal charge, standardize tapes; and city and private engineers frequently avail themselves of this opportunity. This Bureau will give the exact length of the tape at a given temperature or the temperature at which the tape is of standard length, whichever is desired by the engineer. It is well to have the tape also tested at a few intermediate points, e.g., the 25 ft., 50 ft., and 75 ft. marks. One tape which has been standardized should be kept in reserve, with which tapes in service can be compared both when new and after being mended.

Besides the ordinary steel tape, steel or metallic tapes reading to tenths of a foot are used in taking measurements for making approximate estimates of construction and for measuring earthwork, paving, and the like.

242. Transits and Levels. — The transits usually employed in city work read to 30'' or to 20''; and for most city work no finer graduation is necessary. With these instruments the required precision in reading angles on triangulation work can be obtained by repeating the angles as explained in Art. 59, p. 48. In such work, however, it will be of advantage to have an instrument reading to 10''. It is well also to have one or more transits equipped with stadia hairs for use on rough surveys.

Much of the city work, such as the staking out of new streets,

paving, sewers, or curbs, requires the establishment of both lines and grades. Since this class of work does not as a rule call for very precise results, the measurements and rod-readings are usually taken to hundredths of a foot. It is not convenient, for the ordinary surveying party of three men, to carry both a transit and a level instrument in addition to the ordinary equipment of sighting-rods, level-rod, stakes, tape, etc., so the engineer's transit, with a level attached to the telescope, is extensively used in setting grades as well as in establishing lines. For this reason several of the transits in a city office should be equipped with telescope levels and some of them with vertical arcs. The degree of precision possible with an engineer's transit is entirely satisfactory for all ordinary leveling.

Where leveling work alone is to be done the ordinary wye or dumpy level instrument is used together with target or self-reading rods. (See Chapter IV.) For bench leveling it is customary, in large cities at least, to use a *precise level*, an instrument which is similar in principle to the ordinary level but which has a more delicate bubble and a telescope of higher power, and is therefore capable of yielding more accurate results.

243. CITY STANDARD.* — It is customary in all large cities to have a standard of length, usually 100 ft. long, established in some convenient place, often near the office of the City Engineer. It sometimes consists of two brass plugs set in a stone pavement, or it may be a long steel rod supported on rollers on the side of a wall or building in such a way that the rod can expand or contract freely. The end points and the 50-ft. points are so marked that they can be readily found and used by any surveyor who desires to test his tape.

A city standard is often established by carefully transferring the length of some other standard, by means of different tapes and under different weather conditions; or it can be established by means of a tape which has been standardized by the U. S. Bureau of Standards (Art. 241, p. 216). The City Standard is

* See a paper entitled "The 100-foot Standard of Length of the Boston Water Works at Chestnut Hill Reservoir," by Charles W. Sherman, published in the *Jour. Assoc. Eng. Soc.*, Vol. XVIII, No. 4, April, 1897.

generally placed where it will not be exposed to the direct rays of the sun, and with this end in view it is sometimes covered with a wooden box.

When a tape is tested it should be stretched out at full length beside the standard and left there until it acquires the same temperature as the standard before the comparison is made, to avoid the necessity of applying a temperature correction.

CITY LAYOUTS.

244. In laying out or extending a city it is the duty of the surveyor to consider the future needs of its population and to design the general plan of the city accordingly. Nearly all of our large cities show examples of lack of forethought relative to future growth, which have necessitated the outlay of millions of dollars for revision of street lines, sewer systems, water works, and the like.

Occasionally the engineer is called upon to plan a new city or to design the general layout of the suburbs of an existing city. The basis for such work should be a topographic map of the entire area, for the topographic features of a locality will influence its development to a marked degree.

245. STREETS. — In planning the arrangement of the streets for a city such features as a water front, a river or lake, the location of an existing railroad, or the probable location of some projected railroad line will determine to a large degree where the business section of the city will be located. This section should then be so divided as to yield the greatest convenience for business purposes. Other sections will be reserved for residential districts, and their design will be of a different character. Easy access should be provided from the business to the residential districts and to outlying towns or adjacent cities.

The streets must be of the proper width to accommodate the traffic they are to carry, and their alignment and grades must be carefully studied with the topographic map as a guide. Adequate drainage of the streets is, of course, one of the most

important features, for which ample provision must be made in establishing the alignments and grades.

In the business section the traffic will move in certain directions, e.g., to and from important points such as a river, railroad station, or freight yard, and this traffic must be provided for by wide streets with easy grades. In the residential portions, narrower streets and steeper grades are permissible when made necessary by the topography of the district.

246. Location of Streets.— In establishing the location of city streets in hilly districts it is probable that to obtain the essential requisites of easy grades and good drainage the topography will govern the street layout. Whereas in a practically level country, with no steep grades in any direction, the street layout can be such that the most direct communication between different parts of the city is secured.

Fig. 96 shows the location of a rectangular system of streets laid out without reference to the topographic features. The lower portion is on rolling ground where this system may be properly applied; but from a study of the contours it will be seen that in the upper portion this method introduces very steep grades on all of the streets which cross the valley and also leaves a hollow in these streets which is difficult to drain. Fig. 97 shows a layout which will obviate this difficulty to some extent, the diagonal streets being located in the valleys to take the surface drainage of surrounding property. It is obvious that the construction of a sewer through these diagonal streets will be much more economical than through the streets as laid out in Fig. 96, for a sewer must have a continual drop toward its outlet, and cannot be laid uphill and downhill like a water pipe.

With reference to directness of communication between different parts of a city the two general systems which have been used in this country are the rectangular block system and a combination of rectangular blocks with diagonal streets, running in the direction of the greatest traffic.

The rectangular system gives the maximum area for private occupation and is consistent with the general style of rectangular building construction. Where the topography admits of it, this system of streets is advisable. Many of our large cities,

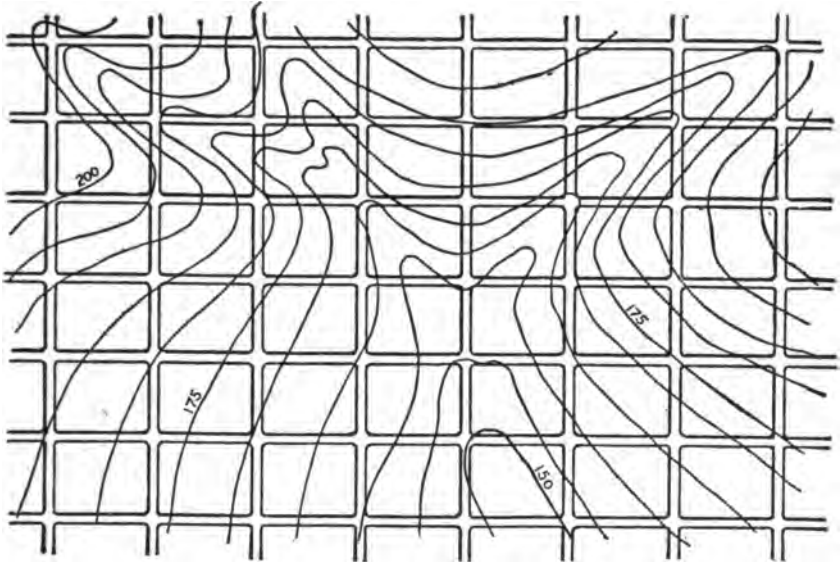

FIG. 96. LAYOUT OF STREETS WITHOUT REGARD TO TOPOGRAPHY.

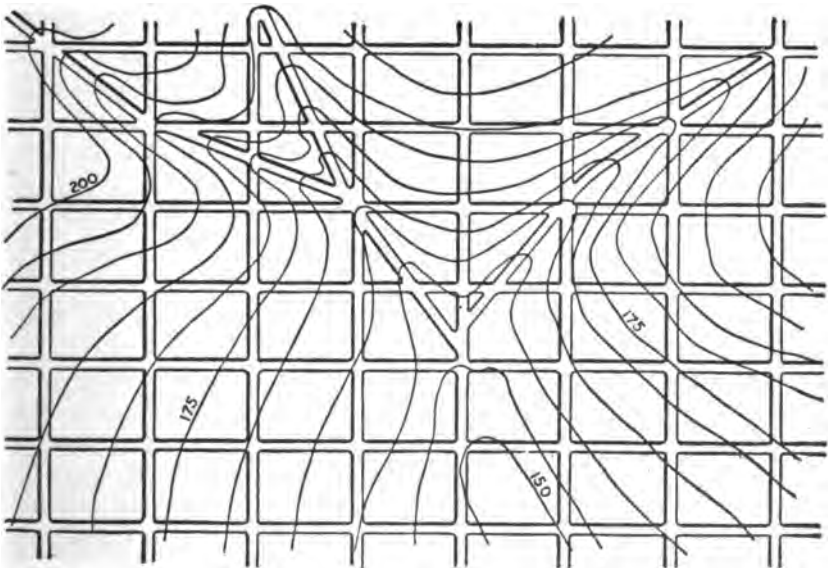

FIG. 97. LAYOUT OF STREETS WITH REGARD TO TOPOGRAPHY.

like Philadelphia, for example, have been laid out in this manner. The streets frequently run parallel and perpendicular to the shore of a lake or river. More often, however, they are laid out in north and south, and east and west directions. When diagonal streets also are introduced they should connect the points between which the traffic is the heaviest. Indianapolis is planned in this manner, having four broad diagonal avenues running from a central park; but the city of Washington (Fig. 98) is the best example of this system in the United States.

247. Size of Blocks and Lots. — No definite size of blocks and lots can be prescribed which will fit all conditions. Experience has shown that the depth of lot most convenient for both business and residential districts is from 100 to 150 feet. In business districts particularly, it is well to provide an alley from 15 to 25 ft. wide running lengthwise through the block. This makes the width of blocks from 215 to 325 feet, which is about the range in existing cities.

The length of the blocks should be in the direction of greatest travel, and this dimension will therefore depend upon the necessity for cross-streets to accommodate the traffic which moves at right angles to the principal line of traffic. In business districts then the cross-streets should be much more frequent than in residential portions of the same city. The length of blocks therefore varies considerably in different cities and in different parts of the same city; ranging all the way from 400 to 900 feet. In New York the typical blocks are 200×900 ft., and 200×400 ft.; in Boston they vary in width from 125 to 252 ft. and in length from 200 to 700 ft., depending upon the locality.

The frontage of lots is frequently 25 ft. in business and congested residential districts and 50 feet or more in suburban districts, but these dimensions are by no means universal.

248. Width of Streets. — The widest streets should in general be the ones which have the greatest traffic. Important business streets should be from 100 to 150 ft. in width, while streets of secondary importance in business districts may be from 60 to 80 ft. wide. In residential districts the main streets

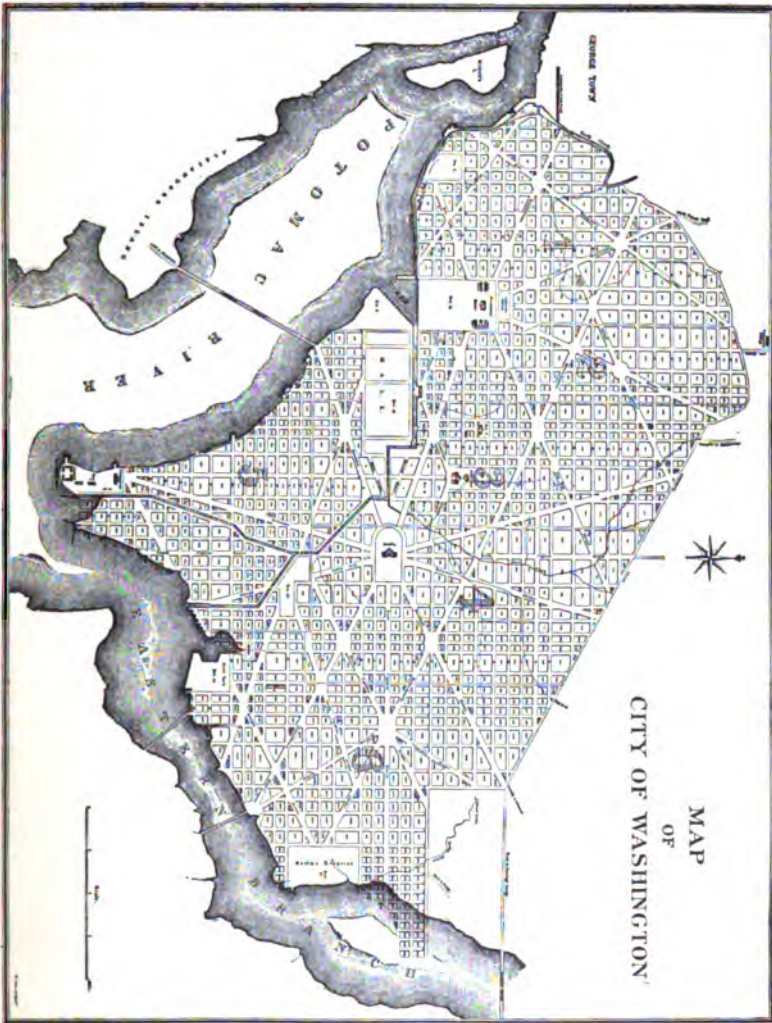

FIG. 98. MAP OF A PORTION OF THE CITY OF WASHINGTON.

should be 60 to 80 ft. wide, but those of lesser importance are often made 50 ft. These widths, however, are more liberal than have been used in many of our older cities, e.g., such cities as Boston, Baltimore, and New York which are especially afflicted with narrow streets.

The alleys which are run through the middle of city blocks should be made from 15 to 20 ft. wide. If they are made narrower than 15 ft. two teams cannot pass each other unless certain parts of the alley are widened for this purpose. Alleys furnish a convenient place for the location of water pipes and sewers.

The width of sidewalks varies greatly with the locality. In business districts, where there is usually a necessity for ample width, some cities devote two-fifths of the entire width of the street to sidewalks; while in residential districts, the sidewalks are frequently much narrower in proportion to the width of the street. In Boston the general rule is to make each sidewalk one-sixth the width of the street. Sidewalks 8 ft. wide are ample for most residential districts. In some localities walks as narrow as 4 ft. are laid out with a liberal grass-plot between the sidewalk and the roadway, which not only gives a pleasing appearance to the street, but also lessens the width of sidewalk and of roadway to be paved and maintained, thereby decreasing the burden of taxation and leaving room for an increase in width of roading if afterwards needed.

249. STREET GRADES.— In connection with the layout of a new city or suburb the grade of the streets is of quite as much importance as the street alignment. While, in the residential districts of some cities, street grades as steep as 10 and 15 per cent. are not uncommon, still it is considered advisable, if possible without excessive cost, to keep the grades down to about 5 or 6 per cent., especially those which extend for any considerable distance. In business districts, where heavy loads are to be hauled, it is desirable that the grades should not exceed 3.5 or 4 per cent. In any case where one street crosses another the grade should be flattened between curb lines to 3 or 4 per cent. if the grade of either street is greater than this amount.

On account of drainage it is well to build a street with a slight grade rather than level. A grade of 6 inches in 100 feet is a good working minimum for proper drainage, and if the street does not have this gradient the gutters must be made of varying depth so as to properly carry off the water. Other elements which govern the rate of grades are the cost of earthwork and the proper balancing of the excavation and embankment in the construction, the effect on abutting property, and the general appearance of the street.

At points where there is a decided change in grade it is customary to introduce a parabolic vertical curve. (Art. 268, p. 242.)

For the purpose of establishing the grades, profiles are made of each street. Levels taken for the purpose of making a profile should include elevations at the center of the street and along both side lines, and it is often desirable to have a cross-section plan of the entire area of the vicinity where the street is to be located. A description of the street grade is written up for acceptance by the proper municipal authorities. When this description has been formally accepted by an order of the City Government the grade is said to have been "established." Such an order may refer to the profile by title or recorded number, instead of a description of the grade. The profile of each street should contain one or more cross-sections on which is indicated to what part of the cross-section the profile refers, i.e., whether the profile grade is the grade of the center of the street, the curb, or the sidewalk at the property line.

The following is an example of a description of an established street grade:—

"Beginning at Station 146 (Maple St.) at the junction of the center lines of Maple St. and Ocean Ave., at grade * 52.00, the grade line falls 0.50 per 100 for 726 ft. to grade 48.37— thence rises 0.82 per 100 for 322 ft. to grade 51.01 — thence

* The word *grade* is frequently used to mean the *elevation* of a point. In such a case care should be taken not to confuse the meaning of *grade* with *rate of grade*. The latter is sometimes called *gradient*, a word which has some advantages but is not entirely satisfactory.

falls 0.50 per 100 for 122 ft. to grade 50.40 — thence falls by a vertical curve for 100 ft. as follows :

Sta.	Elev.
157 + 60.....	50.40
157 + 85.....	49.90
158 + 10.....	49.30
158 + 35.....	48.55
158 + 60.....	47.70

thence falls 3.60 per 100 for 239 ft. to Station 160 + 99 (Maple St.), grade 39.10.”

250. THE DATUM PLANE. — One of the first tasks of the surveyor in laying out a town site is to establish a datum plane to which all elevations may be referred. It is customary to choose a datum that bears an intimate relation to the topography of the locality. For example, if the town is located on the seashore a series of tidal observations may be taken to determine the mean sea-level or mean low water either of which is often used as a datum (Art. 237, p. 211). The mean level of lakes is used as a datum for many inland cities. Frequently the elevation of some point not far from the town site has been established by the U. S. Geological Survey, the U. S. Coast and Geodetic Survey, or by the line of levels of a railroad ; and by careful leveling the elevation of some permanent point in the town site can be established which will serve as the starting point for all the elevations in the town. Where nothing of this sort is available, the elevation of some point is found by barometer so that the recorded elevation may approximate the actual height above sea-level.

251. ESTABLISHING BENCH MARKS. — When the datum has been determined, bench marks are established by the method explained in Art. 219, p. 198. The establishment, at the start, of a reliable system of bench marks is of utmost importance, in order that the elevations of all parts of the city shall refer to the same datum. In laying out construction work it is absolutely necessary that bench marks which can be relied upon shall be available and sufficiently numerous to be of use in any section of the city without requiring several set-ups of the level to connect a bench mark with the level work that is to be done.

Another advantage in having them close together is that they may serve as ready checks on each other as well as on the work at hand. It is not uncommon for a bench mark to be disturbed, and, if the level work is not occasionally checked on some other bench mark, an error will surely enter into all of the level work which was started from that bench.

252. WATER AND SEWER SYSTEMS. — The water and sewer systems of any community are of vital importance and provision for them must be made in the layout of every town site. The location of the water supply and the storage and distributing reservoirs is a matter of such magnitude that it cannot be discussed in this short treatise.* The conditions essential to an economical water or sewer system will sometimes radically affect the alignment and grades of many of the streets. The gradients of water pipes are of little importance since the water is working under pressure, and the pipes can be laid uphill and downhill so long as there is sufficient "head" to force the water through the pipes.

In a sewer system the problem is far different; every sewer must have proper gradients, and the entire system must fall gradually from the most remote points to the main sewer outlet. The topographic map therefore is of utmost importance as a basis for a study of this problem.†

STAKING OUT CITY WORK.

253. STAKING OUT A NEW DISTRICT. — In staking out a new district the information at hand is usually a plan of the proposed layout of the streets which has been studied out in the office from a map of the district. If this layout has been approved by the municipal authorities the street lines as they appear on the plan are the "established lines."

It is the surveyor's duty to stake out these lines on the ground, connecting them properly with the street lines of the

* See *Public Water Supply*, by Tourneure and Russell, published by John Wiley & Sons, New York.

† See *Sewerage*, by Professor A. P. Folwell, published by John Wiley & Sons, New York.

older portion of the city, and in short, to produce on the ground a layout exactly like that on the plan. Sometimes the angles and distances necessary for the layout have been computed in the office, but more frequently these are not determined until the lines are laid out on the ground. In reproducing these lines on the ground the surveyor will often find that the exact dimensions given on the plan do not correspond with his fieldwork owing probably to the fact that his tape differs in length from that used by the surveyor who made the original plan. In such a case he must distribute the discrepancies (unless they are large enough to indicate that a mistake has been made) in the proper manner in his work.

Not infrequently the entire work is staked out from a plan which has been made in the office, and the exact angles and distances as determined in the field are recorded on this plan which then goes to the proper authorities to be put in the form of a city order. As soon as the plan is accepted the street lines should be marked by monuments (Art. 254), so that there may be no difficulty in retracing the lines as they were originally laid out and accepted. If considerable grading work is to be done in building the new streets it may not be practicable to set many of the corner bounds at first on account of the likelihood of their being disturbed. In such cases it is the duty of the surveyor to properly reference the points by cross transit lines or otherwise before construction work begins; for it is important that the layout, as recorded in the city order, shall be accurately and definitely defined so that when the streets are brought to the proper grade and the monuments are finally set they will mark the exact position of the original layout.

254. MONUMENTS. — It is important and at the same time customary to define street lines by setting stone bounds, often called *monuments*, at the street corners and at angles in the street lines. The bounds are set sometimes on the side lines, sometimes on the center lines, and sometimes in the sidewalks.

At street intersections, one monument at the intersection of the center lines will suffice to mark both street lines, but since this point will come in the center of the road pavement where it is likely to be disturbed by traffic or by street repairing it is sel-

dom placed there. The more practicable method is to define the street lines by marking the side lines at the angles or, in the case of rounded corners, at the beginning and end of the curves. It is not necessary that all four corners of a street intersection shall be marked, as a bound on one corner will define the side lines of the two streets and, the width of the streets being known, the other sides can easily be determined. Nor is it necessary to place a bound at one of the corners of every street intersection, provided a street is straight for several blocks, although it is good practice to do so. On account of the liability of bounds which are placed on the side lines of the street being disturbed by building operations, some surveyors prefer to place them on an offset line, say 2 ft. from the street line. All monuments should be placed with extreme care as regards both their accuracy of position and their stability. If any bounds are set with more care than others, they should be the ones which occur at angle points in the street lines rather than the intermediate bounds which are set along a straight line.

Monuments are usually roughly squared stone posts about 4 to 8 inches square and 3 to 4 feet long, the length depending upon the severity of the climate, e.g., in New England a monument less than 4 ft. long is likely to be disturbed by frost action. They are carefully squared on top and a drill-hole in this end marks the exact point. This drill-hole may be made before the stone is set in place, or after it has been placed so that its center is about in position the exact point may be defined by drilling a hole in the top of the bound. Frequently the hole is filled with lead and a copper nail set in the lead is used to mark the exact point. For nice definition of the point, a copper bolt is inserted and two lines scratched across it; the intersection marks the exact point. When the stone bound is placed at the intersection of the side lines of the streets it is sometimes located entirely in the sidewalk in such a way that its inside corner is exactly on the intersection of the street lines. In such a case the three other corners of the bound are usually chipped off so that there may be no mistake as to which corner defines the line, but the line corner frequently becomes worn off and this practice is therefore not recommended. Some surveyors

use, in the place of stone bounds, a piece of iron pipe or iron plug with a punch-hole in the top of it, driven into the ground or embedded in cement concrete. Long heavy stakes are employed to temporarily define intermediate points or points of secondary importance.

255. Setting Stone Bounds.— When the street lines are laid out the corners are marked by tacks in the top of ordinary wooden stakes. The monuments which are to take the place of the stakes should be set before the frost has entered the ground or before any other disturbance of the stakes has taken place. When the bound is ready to be set the first thing to do is to drive four temporary stakes around the corner stake about two feet from it and in such a way that a line stretched from two opposite stakes will pass over the tack in the head of the corner stake (Fig. 99). Then tacks are carefully set in the tops of

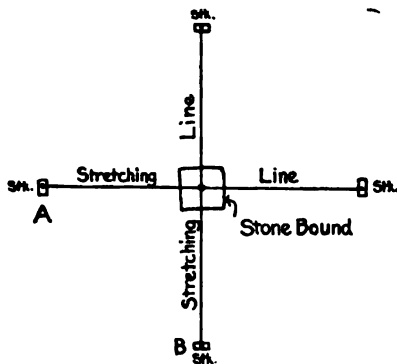

FIG. 99. SETTING A STONE BOUND.

these temporary stakes in such positions that a stretching line running from the tack on one stake to the tack on the opposite stake will pass exactly over the tack in the corner stake.

Then the corner stake is removed and the hole dug for the stone bound. Care should be taken not to dig the hole any deeper than is necessary so that the bound may be set on firm

earth. As to the position of the top of the bound with reference to the surrounding ground, surveyors disagree. Some prefer that the monument should stick out of the ground so that it can be readily found; while others claim that if it projects above the surface the bound is likely to become misplaced by traffic, and therefore that it is better to set it just flush with the ground or slightly below the natural surface. If any grading is to be done in the vicinity the bound should be set so that it will conform to the proposed grade. When the hole for the

bound has been dug to the proper depth it is well to stretch the strings across between the temporary stakes and plumb down roughly into the hole to determine where the center of the bound will come, so that when the monument is dropped into the hole it can be placed so that it will set plumb.

The bound having been set in the hole, the next operation is to fill around it. This should be done with considerable care, the material being properly rammed as the filling proceeds and the bound kept in such a position that the drill-hole in the top of it, if there is one, shall be **exactly** under the intersection of the strings. It is sometimes desirable to put in a foundation of concrete and to fill with concrete around the monument to within a foot of the surface, as shown in Fig. 100, where a very substantial bound is required, or where the ground is so soft as to furnish an insecure foundation. If the top of the bound is plain and the hole is to be drilled after the bound is in place, care should be taken to place the monument so that this hole will come practically in the center of the top in order that it may present a workman-like appearance. After the bound is set exactly in place the temporary stakes are removed.

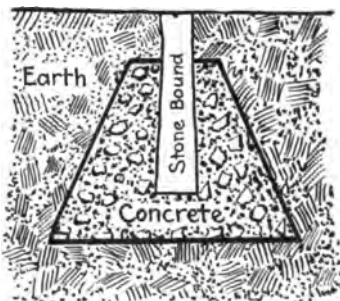

FIG. 100. STONE BOUND WITH CONCRETE FOUNDATION.

Some surveyors prefer to use only two opposite stakes and one stretching line, the position of the monument being determined by a measurement along the stretching line from one or both of the temporary stakes. Still another method of temporarily tying in the stone bound, and one which many surveyors use, is to set two stakes such as A and B in Fig. 99, and either measure the distance from them to the bound or set them at some even distance from the bound. This process of using temporary stakes and the stretching line is employed also in setting other types of bounds such as gas pipes or iron rods.

In the construction of buildings or fences, monuments are frequently disturbed and too often they are reset by the owner of the property without the services of a surveyor. In rerunning a street line, therefore, a surveyor should be on the lookout for such conditions, and he should be cautious in the use of any monument which he has any reason to suspect may have been misplaced.

256. CURVED LAYOUTS. — It is not unusual for streets to be laid out with curved lines. In the design of boulevards, parks, and residential sections a landscape architect is often called in and the plan he presents is sometimes almost devoid of any straight street lines. (See Fig. 101.) The surveyor must

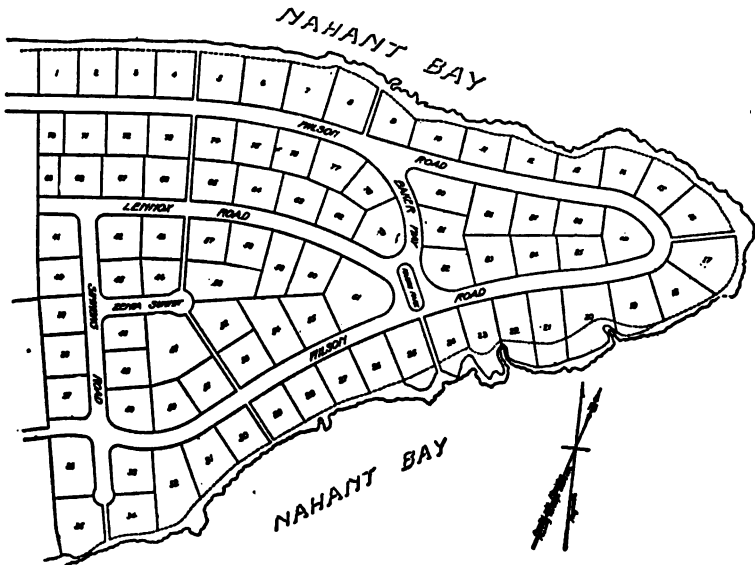

FIG. 101. CURVED LAYOUT FOR RESIDENTIAL PART OF A CITY.

take this plan and from the design there given stake out the layout and obtain the necessary dimensions to definitely locate all parts of it.

As a rule the landscape architect simply draws on the topographic map his scheme of layout with very few dimensions and leaves the rest to be worked out by the surveyor. Occasionally

the radii of the curves are noted on the plan, but the street widths are often the only dimensions given. If the radii are not given the surveyor must determine from the plan either these radii or some other distances, such as the tangent lengths, so that he can go into the field, and, beginning with some known street line, run out the new street lines in such a way that when the data he determines are plotted the lines will coincide with those on the plan prepared by the landscape architect. As a rule these curved lines can be made up of a combination of circular curves.

257. ELEMENTS OF A CIRCULAR CURVE.— Before considering how to stake out a curve it will be well first to refer to the elements of a simple circular curve. In Fig. 102 which represents a simple circular curve

- $OB =$ Radius $= R$
- $AHB =$ Length of Arc $= L_c$
- $AB =$ Long Chord $= C$
- $VA = VB =$ Tangent Distance $= T$
- $VH =$ External Distance $= E$
- $HF =$ Middle Ordinate $= M$
- $I =$ Intersection Angle, or Central Angle
- $V =$ Vertex
- $P.C. =$ Point of Curvature
- $P.T. =$ Point of Tangency

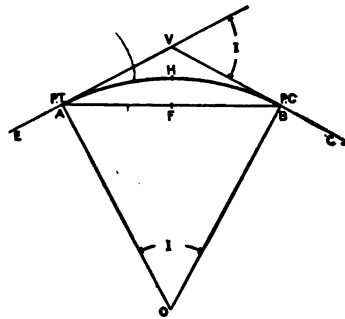

FIG. 102. CIRCULAR CURVE.

From simple geometric and trigonometric relations,

$$\begin{aligned} \tan \frac{I}{2} &= \frac{T}{R} & T &= R \tan \frac{I}{2} \\ \operatorname{Exsec} \frac{I}{2} &= \frac{E}{R} & E &= R \operatorname{exsec} \frac{I}{2} \\ \operatorname{Vers} \frac{I}{2} &= \frac{M}{R} & M &= R \operatorname{vers} \frac{I}{2} \\ \sin \frac{I}{2} &= \frac{C}{2R} & C &= 2R \sin \frac{I}{2} \\ L_c &= R \times \text{Circular measure of } I.* \end{aligned}$$

* The curves used in railroad engineering are usually very flat, so that there is little difference between the chords and their corresponding arcs. This fact

258. **STAKING OUT CIRCULAR CURVES.** — In Fig. 102 the two lines BC and EA are produced in the field and a point is set at their intersection V , as described in Art. 200, p. 175. The

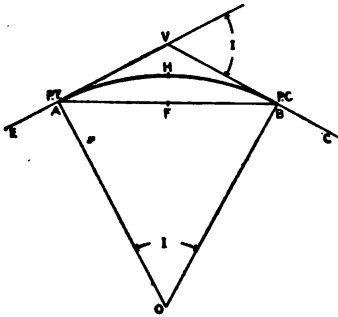

FIG. 102. CIRCULAR CURVE.

instrument is then set up at V and the central angle I carefully measured, or if point I is inaccessible other angles such as VEC and VCE may be measured from which I can be easily computed. Then the radius R which is determined from the plan being known, the tangent distance T is obtained by the formula, $T = R \tan \frac{1}{2} I$. Points $P.T.$ and $P.C.$ are then set

and the curve is usually laid out by the method of *deflection angles* as explained in the following article.

259. **DEFLECTION ANGLES.** — A deflection angle is usually referred to as an angle between a tangent and a chord, e.g., in Fig. 103 angles VAb , VAc , etc., are deflection angles. Since

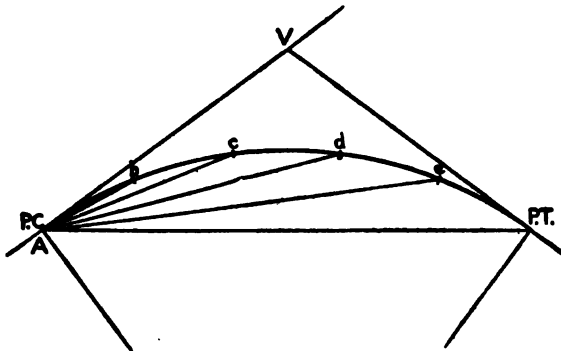

FIG. 103. DEFLECTION ANGLES.

makes it possible to compute the *length of curve* by a simple approximate method, which, however, is sufficiently exact for most railroad work.

The *Degree of Curve*, which is the angle at the center subtended by a chord of 100 ft., is an element of the circular curve which is used extensively in railroad en-

the angle between a tangent and a chord is measured by half the included arc these deflection angles must be equal to half the angle at the center subtended by the same chord or arc.

If the total length of the curve is divided into an even number of parts, n , the angle at the center under each of these arcs will be $\frac{I}{n}$, and the deflection angle for one chord will be $\frac{I}{2n}$, which in Fig. 103 is the angle VAb . Angle bAc = angle VAb , both being measured by one-half of equal arcs. It follows then that the deflection angle to point

$$c = 2 \times \frac{I}{2n} = \frac{I}{n}$$

$$d = 3 \times \frac{I}{2n} = \frac{3I}{2n}$$

$$e = 4 \times \frac{I}{2n} = \frac{2I}{n}$$

etc.

Evidently, after the first deflection VAb is found, the other deflections can be obtained by simply adding the increment $\frac{I}{2n}$ to the preceding deflection angle, and this is the method which should be used. The deflection angle from the $P. C.$ to the $P. T.$ should be equal to $\frac{I}{2}$, and this check should always be applied to the computations before they are used in laying out the curve.

The chords Ab , bc , cd , etc. are equal since their arcs are equal. With the radius and the central angle ($\frac{I}{n}$ for one chord) given, the chord length can readily be found from the formula,

gineering. The central angle divided by the degree of curve will give the number of 100-ft. chords in the length of the curve, i.e., $\frac{I}{D} = L$ (in 100-ft. stations).

Therefore L (in feet) = $\frac{100I}{D}$. For a complete discussion of railroad curves see "Railroad Curves and Earthwork," by Professor C. F. Allen, published by Spon & Chamberlain, New York.

$c = 2 \sin \frac{I}{2n}$. Since the angle at the center is usually small and the radius large the angle will have to be carried out in some instances much closer than to the nearest minute in order that the length of the chord may be obtained to hundredths of a foot (Art. 371, p. 341). An approximate value for the chord length corresponding to a given arc may be obtained by the approximate formula,

$$l_c - c = \frac{c^2}{24R^2}, \text{ or } = \frac{l_c^3}{24R^3} *$$

in which l_c is the length of the arc, c is the chord length, and R the radius.

The fieldbooks in use by most surveyors contain tables of chords and corresponding arcs for curves of different radii, which assist greatly in shortening these computations.

When the deflection angles have been computed and checked and the chord length found, the instrument is set up at A , (Fig. 103) a foresight taken on the vertex with the vernier reading 0° , and the point b set by measuring Ab and placing b on line by means of the transit on which the first deflection angle $\angle VAb$ has been laid off. Point c is set by measuring bc and placing c on line with the transit on which the second deflection angle has been laid off, and so on, until the last point ($P.T.$) has been set.

It is evident that with the transit at the $P.C.$ the curve could have been laid out just as well by taking the measurements from the $P.T.$ end, and some surveyors prefer to do it this way. Similarly the instrument might just as well have been set up at the $P.T.$ instead of the $P.C.$ and the measurements started from the $P.C.$ if it were found to be more convenient.

* The following will give some idea of the accuracy of this formula.

With $R = 100$ and $l = 25$, the formula gives $c = 25.065$, (correct value is 25.066).

With $R = 100$ and $l = 50$, the formula gives $c = 50.521$, (correct value is 50.536).

With $R = 1000$ and $l = 100$, the formula gives $c = 100.042$, (correct value is 100.042).

... This formula will be found very useful if a slide rule is employed for the computation.

It is sometimes necessary to set definite station points on the curve rather than to cut the curve up into several equal parts as suggested above. The principle is exactly the same as described above; but in figuring the deflection angles and the chord lengths to be used the computations are not quite so simple. No trouble will be experienced, however, if it is borne in mind that the total deflection angle to any point is equal to half the central angle to that point from the *P.C.*, and that the central angle for any arc bears the same relation to the entire central angle that the arc does to the entire length of curve.

260. **Keeping the Notes.**— In a curved street the notes of alignment generally refer to the center line, the two side lines being parallel to the center line. All three of these lines have to be run out by the use of chords and deflection angles; Fig. 104 is an example of a concise form of notes for this work. In

Description of curve	Station	Distance (Arc)	Chords			Deflection Angles	Remark
			Left	Center	Right		
<i>Width of Street 70 Feet.</i>							
To Right	18+52.50	30.08	35.31	30.05	24.79	25°-47'-40"	R.T.
R=200	18+22.42	50.00	58.59	49.87	41.14	21-29-10	
T=96.66	17+72.42	50.00	58.59	49.87	41.14	14-19-20	
I=31°-35'-28"	17+22.42	50.00	58.59	49.87	41.14	7-09-40	
L _c =180.08	16+72.42						P.C.

FIG. 104. NOTES OF A CIRCULAR CURVE.

the first column is a description of the curve, which refers to the center line of the street. This particular curve is marked "To Right" meaning that it deflects to the right while passing around it in the direction in which the stations run. In the third column are the distances measured on the actual arc along the center line. The next three columns headed "Chords" are the chord measurements across the curve from station to station on the left side line, the center line, and the right side line of the street, the terms left and right meaning left and right looking in the direction in which the stations run. In the column headed "Deflection Angles" are the total deflections to be laid off with the instrument set up at the *P.C.* These same deflection

angles are used in running out the side lines for the chords which have been computed for the side lines run between points which are radially opposite the corresponding points on the center line. The computation of these notes will be found in Art. 371, p. 341.

261. When the Entire Curve Cannot be Laid Out from One End. — It is often impossible to see from the *P.C.* to the *P.T.* of a curve on account of intervening obstructions. In such a case the curve is run from the *P.C.* as far as is practicable and a point is carefully set on the curve; then the transit is brought forward and set up at the point thus fixed, and the curve extended beyond. There are two different methods employed in this case.

262. FIRST METHOD. — Assume the circular curve in Fig. 105 to be laid out from *A* to *d* as described above. Point *d* is

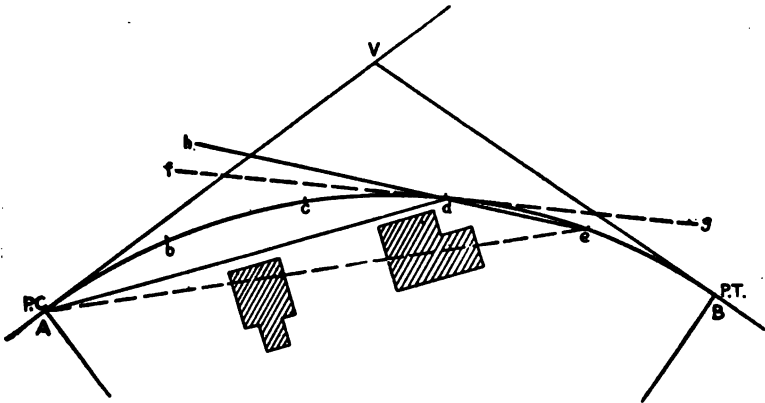

FIG. 105. INTERMEDIATE SET-UP ON CURVE.

carefully set and the instrument then taken to that point and set up. The vernier is turned back to 0° and beyond 0° by the value of the deflection angle VAd . Then by using the lower clamp and tangent screw the telescope is sighted on point *A*. The upper plate is then unclamped and, if the telescope is turned so that the arc reads 0° the instrument will be pointing along the direction of an auxiliary tangent df , for angles VAd and AJf are equal. It is well to note whether the instrument appears to point in the direction of the tangent. Then reverse the telescope, set off on the vernier the angle $gde = \frac{I}{2n}$, and lay out the

curve from d to B just as though it were an independent curve beginning at d and ending at B .

263. SECOND METHOD.—When the transit has been set up at d , the vernier is set at 0° and a backsight taken on A . Then an angle equal to the deflection angle VAd is laid off on the arc; this will cause the telescope to point in some such direction as dh . The line of sight is reversed and point e set on hd produced, making the chord de of the proper length. Then point B is set by laying off on the vernier an angle equal to VAB and measuring the chord eB . This method is correct for

$$VAe = VAd + dAe$$

$$= fdA + hdf, \text{ being measured by half of equal arcs.}$$

This second method is sometimes to be preferred since the original deflection angles figured can be used throughout the curve. The first method calls for the calculation of a few more angles; but this is so simple a process that there is probably little choice between the two methods.

264. CURVED STREET CORNERS.—It is the practice in many cities to curve the corners of the streets by introducing a circular curve of short radius. Where both street lines are straight the problem is handled as explained in Art. 258, p. 234.

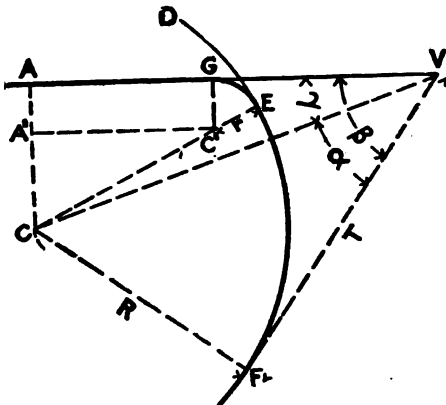

FIG. 106.

265. * One Street Line Straight, the Other Curved.—In Fig. 106 the curved street line DEF intersects the straight street line AV and at this point the circular curve whose center is C' and with a given radius r is to be introduced to round off the corner. It is required to stake out the curve GE on the ground. In

* The authors are indebted to I. T. Farnham, City Engineer of Newton, Mass., for the solution of the problems given in Arts. 265-6.

the field any tangent line, such as FV , is run off from some known point on the curve and intersected with AV , and the angle β and the distance FV are measured. In the right triangle CFV in which R and T are known, compute angle α and distance CV . In the right triangle CAV , CV and $\gamma = \beta - \alpha$ being known, compute CA and AV . $CA' = CA - r$; $CC' = R - r$. In the right triangle $CA'C'$, CA' and CC' being known, compute $A'C'$

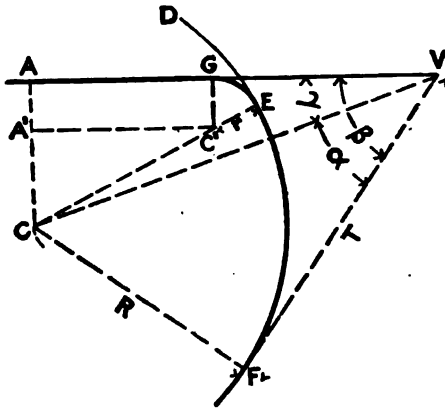

FIG. 106.

and $A'CC' = GC'E$. Angle $ACF = 180^\circ - \beta$. Angle $ECF = ACF - A'CC'$, from which the length of the arc FE can be readily computed, which locates the point E . $VG = AV - A'C'$, which locates point G of the curve GE , and any intermediate points can be located as explained in the previous articles.

As the radius CE is often quite short the center of the curve can be located from either its $P.C.$ or $P.T.$ or both, and any intermediate points on the curve can be easily swung in from its center.

266. Both Street Lines Curved.—In Fig. 107 the two curved street lines ABD and $A'B'D'$ intersect each other and the curve whose center is E and with a given radius r is introduced at the intersection of the two street lines. It is required to locate the curve $B'B$ on the ground. In the field the tangent DV is run off from some known point D on the curve ABD and intersected with a tangent $D'V$ from the curve $A'B'D'$ and angle α and distances T and T' are measured. In the right triangle CDV , R and T being known, compute angle CVD and distance CV . Similarly in the triangle $C'VD'$ compute angle $C'VD'$ and distance $C'V$. In the oblique triangle CVC' , CV , $C'V$ and angle $CVC' = 360^\circ - (\alpha + CVD + C'VD')$ being known, compute CC' and the angle $CC'V$ and $C'CV$. In the oblique tri-

angle $CC'E$, $CE = R + r$, $C'E = R' - r$, and CC' being known, compute the angle $C'CE$, $CC'E$ and $C'EC$, which is the supplement of the central angle of the curve BB . Angle $DCB = DCV + VCC' - C'CE$, from which arc DB can be com-

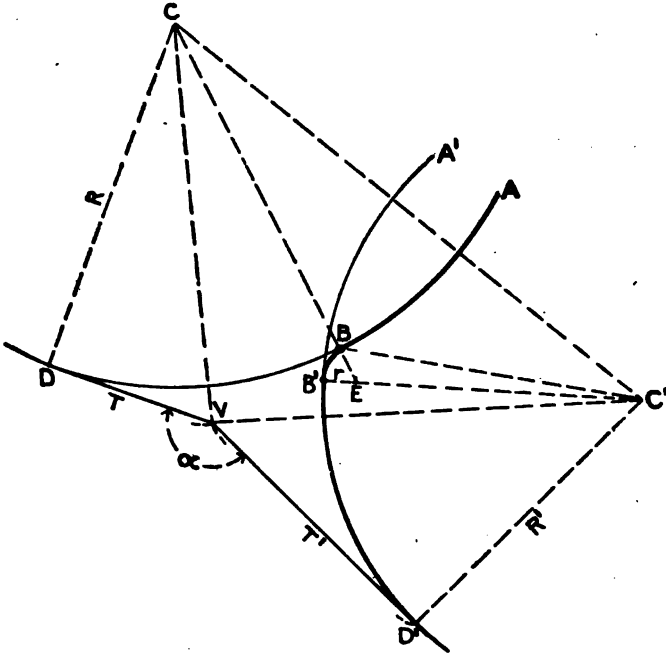

FIG. 107.

puted. Similarly angle $D'C'B' = D'C'V + VC'C - CC'E$, from which arc $D'B'$ is computed. These locate the $P.C.$ and $P.T.$ of the small curve whose center is E .

267. STAKING OUT STREET GRADES. — The fieldwork necessary in setting grade stakes is explained in Arts. 235–6, p. 210. When new streets are constructed the excavation or embankment is first brought to sub-grade, i.e., to the grade of the bottom of the road covering or pavement. The grade stakes set for this work are usually the center and the two side slope stakes, properly marked with the cut or fill, as described in Arts. 230–2, pp. 207–10.

As the work progresses the center stake is dug out or covered up and when the construction has progressed nearly to the sub-

grade it is customary to set stakes at the elevation of the sub-grade along the center line and on each side line of the street.

268. Vertical Curves.—Where the rate of grade of a street changes, in order to avoid an abrupt transition from one grade to the other, a vertical curve is introduced which is tangent to both grade lines. The simplest curve to locate for this purpose is the parabola.

In Fig. 108 LV and VM represent two grade lines intersecting at V . The parabola AHB is tangent to these lines at A and B . It is often customary to set the grade stakes on a vertical

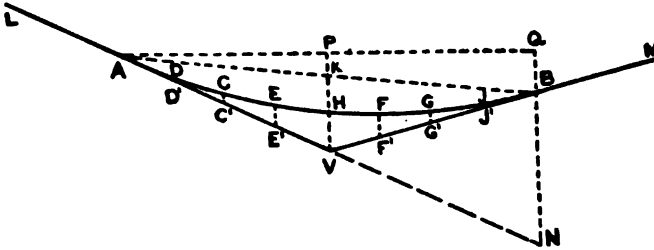

FIG. 108. VERTICAL PARABOLIC CURVE.

curve at every 25-ft. station; in such a case, then, Fig. 108 represents a vertical curve 200 ft. long on which the elevation of nine points must be determined. The equation of the parabola is

$$y^2 = 4px, \text{ or } y^2 = (\text{constant})x, \quad (1)$$

the x dimensions being parallel to VK (vertical) and the y dimensions being along AV . From the equation it is readily seen that the **offsets from the tangent vary as the squares of the distances along the tangent**, or $x_1 : x_2 = y_1^2 : y_2^2$. The lines VP and NQ are vertical and AQ is horizontal. Since the curve extends an equal distance each side of V , $AP = PQ$; and therefore $AK = KB$.

$NB = 4VH$; $VH = 4CC'$; $CC' = 4DD'$; etc. (from equation 1.)

Let g and g_1 represent the rate of grade of LV and VM , and n the number of 25-ft. stations (in this case 4) on each side of the vertex V , then

$$NB = \frac{n}{4} (g + g_1)$$

$$KV = \frac{NB}{2} \text{ (from similar triangles)}$$

but $NB = 4VH$ (from above)
 therefore $KV = 2HV$,
 or point H is midway between V and K .

The elevation of V is determined from the established grade. The number of 25-ft. stations will determine the distance VA and VB . The elevation of A and of B can be readily computed along their respective straight grade lines.

$$\text{Elev. } K = \frac{\text{Elev. } A + \text{Elev. } B}{2}$$

$$\text{Elev. } H = \frac{\text{Elev. } V + \text{Elev. } K}{2}$$

$$VH = \text{Elev. } H - \text{Elev. } V.$$

Elevations of all the other intermediate points along the curve can be computed by finding the elevation of the points D' , C' , E' , F' , G' , and J' and by adding to these elevations the ordinates $D'D$, $C'CE$, $E'E$, etc.

$$D'D = J'J = \frac{VH}{16}$$

$$C'C = G'G = \frac{VH}{4}$$

$$E'E = F'F = \frac{9VH}{16}$$

269. CROSS-SECTION OF STREET. — On account of the necessity for draining the surface of a road the center is raised or "crowned" above the grade of the gutters by an amount depending on various conditions. The shape of the road surface is sometimes two planes, running straight from the gutter to a summit or ridge in the center of the street, this ridge being rounded off by rolling; but more frequently it is a curved surface in the form of a parabola or a circle. The ordinary width and crown of streets are such that the parabola and the circle are practically coincident.

When a street is to be paved the curbstones are first set to proper line and grade, then stakes are set for the finished grade of the roadway. The center grade stake is frequently the only

grade given and a templet, or form, which can be set on the curbs and on this center stake is used to give the form of the cross-section. The form of the templet for this work is laid out by the surveyor. If no templet is used he should put in intermediate grade stakes between the center and the curb lines. In either case the surveyor must compute the necessary ordinates to give the proper shape to the surface.

Usually the mean transverse slope of the pavement is given either in the form of a ratio thus :

$$\text{Mean Transverse Slope} = \frac{\text{Crown}}{\text{Half the Width of Carriageway}} = \frac{1}{30}$$

or, Mean Transverse Slope = $\frac{1}{8}$ " per ft.

270. **Gutters at Same Elevation.** — Fig. 109 represents the

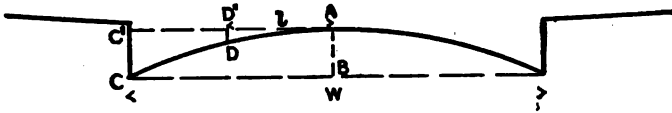

FIG. 109. CROSS-SECTION OF PAVEMENT; GUTTERS AT SAME ELEVATION

cross-section of a pavement and sidewalks. The crown AB is computed from the mean transverse slope and the width of the pavement.

The ordinate DD' at any other point on the parabola = $C'C \times \frac{l^2}{(W/2)^2}$ since in a parabola the offsets from a tangent

vary as the square of the distance out along the tangent (Art. 268, p. 242). But $C'C = AB$; hence, if D' is half-way from the center to the curb, $DD' = \frac{AB}{4}$.

271. **One Gutter Higher than the Other.** — When one gutter is higher than the other the following application of the parabola

can be used. In Fig. 110 the maximum ordinate x is at a dis-

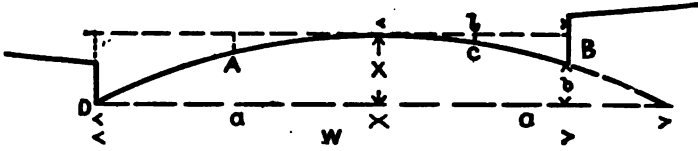

FIG. 110. CROSS-SECTION OF PAVEMENT: ONE GUTTER HIGHER THAN THE OTHER.

tance a from the lower gutter. The first step is to find this distance a and then x is readily found from the mean transverse slope since $\frac{x}{a} = \text{Mean transverse slope}$. When x is found the other offsets can be computed as explained in the previous article.

$$\begin{aligned} \text{At } A \text{ the offset} &= \frac{x}{4} \\ \text{at } B &= x - b \\ \text{at } C &= \frac{x - b}{4} \end{aligned}$$

The width of pavement, the difference in elevation of the gutters, and the mean transverse slope being given, the formula for a is derived as follows.

In Fig. 110, W = width of pavement.

R = radius of the circular curve $DACB$.

a = distance from the line of the lower gutter to the highest point of the pavement.

l = distance from the line of the higher gutter to the highest point of the pavement.

b = difference in elevation between the two gutters.

s = mean transverse slope, expressed as a ratio of crown to half the width of pavement.

x = difference in elevation between the lower gutter and the highest point on the pavement.

$$x = \frac{a^2}{2R} \quad (1) \quad (\text{See (1) in foot-note, p. 339.})$$

$$\text{and } x - b = \frac{l^2}{2R} \quad (2) \quad (\text{See (1) in foot-note, p. 339.})$$

$$\therefore x = b + \frac{l^2}{2R}$$

Combining (1) and (2), $a^2 - l^2 = 2Rb$

$$(a + l)(a - l) = 2Rb$$

$$a - l = \frac{2Rb}{a + l}$$

But

$$a + l = W$$

$$\therefore a - l = \frac{2Rb}{W}$$

$$(a + l) + (a - l) = W + \frac{2Rb}{W}$$

$$2a = W + \frac{2Rb}{W}$$

$$a = \frac{W}{2} + \frac{Rb}{W} \dots \dots \dots (3)$$

From (1),

$$2R = \frac{a^2}{x}$$

But

$$\frac{x}{a} = \text{Mean transverse slope} = s$$

$$x = as$$

$$\therefore 2R = \frac{a^2}{as} = \frac{a}{s}$$

$$R = \frac{a}{2s}$$

From (3),

$$a = \frac{W}{2} + \frac{ab}{W}$$

$$a \left(1 - \frac{b}{2Ws} \right) = \frac{W}{2}$$

$$a = \frac{\frac{W}{2}}{1 - \frac{b}{2Ws}}$$

272. If, instead of assuming the mean transverse slope of the pavement, the elevation of the center of the pavement *D* (Fig. 111) with respect to the elevation of *A* and *B* is assumed,

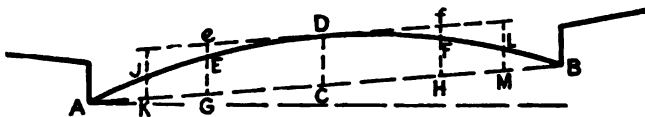

FIG. 111.

then DC is readily found and the elevation of such points as E or F , which are midway between D and the gutters, are computed from the method explained in Art. 270, eE and fF both being equal to $\frac{DC}{4}$.

Similarly, Elevation $E = \text{Elevation } G + \frac{3DC}{4}$

Elevation $F = \text{Elevation } H + \frac{3DC}{4}$

Elevation $J = \text{Elevation } K + \frac{7DC}{16}$

Elevation $L = \text{Elevation } M + \frac{7DC}{16}$ etc.

273. IRREGULAR SHAPED BLOCKS.— There is a wide variance of practice in the method of cutting up irregular shaped blocks into lots. One good general rule in such cases is to give

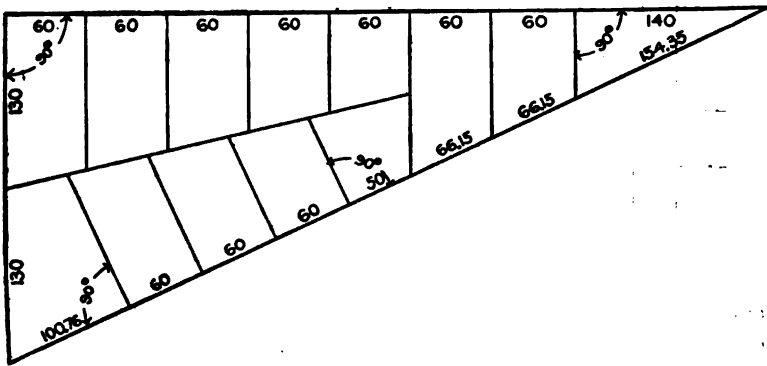

FIG. 112. ARRANGEMENT OF LOTS IN A WEDGE-SHAPED BLOCK.

each lot as much street front as is possible consistent with making the side lines of the lots at right angles to the street lines. If the side lines do not run at right angles to the street there will be portions of the lot which are not available for the customary rectangular style of building construction and which are therefore not so desirable for business purposes. This is not of

so much importance in residential districts where the rectangular system is often purposely avoided to some extent, to obtain a layout which has an attractive appearance, as illustrated by Fig. 101, p. 232.

Fig. 112 is an example of an irregular shaped block in which rectangular lots have been planned, the wedge-shaped remnants being thrown into the corner lots.

274. STAKING OUT CITY LOTS.— In staking out the lots of a rectangular block, the corners of which have been established, the most direct method is as follows. The transit is set up on the S. B. at *A*, (Fig. 113), a sight is taken on *B*, and the front

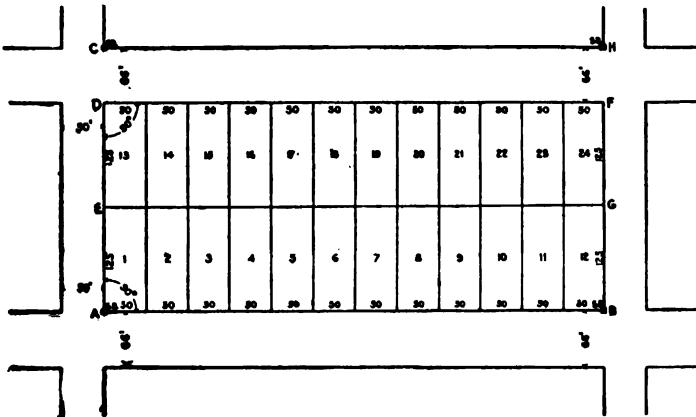

FIG. 113. RECTANGULAR CITY BLOCK.

corner stakes of lots 1, 2, 3, 4, etc., are set, with a tack, exactly on line, in the top of each stake. All such work should be done to the nearest 0.01 ft. It will be well first to measure the line *AB*, to see that it is just 600 ft. long. Since it is assumed that considerable care was used in setting the S. Bs. exactly in the correct position, if it is to be found to be a few hundredths over or under 600 ft., it is probable that this discrepancy is due to the difference between the length of the tape on the present work and that used in the original layout. In such a case the twelve lots must be laid out with equal frontages. For example,

it may be a hot day when the lots are to be staked out and the tape may give a distance from *A* to *B* of 599.88 ft. In this case each lot should measure 49.99 ft. wide.

With the instrument still at *A* and sighted on *C*, point *D* is set by measuring 66 ft. from *C*, and then point *E* is placed midway between *A* and *D*. Whatever slight discrepancy there may be in the distance between the S. B. at *A* and that at *C* is thrown into the depth of the lots rather than the width of the street.

By setting up the instrument at *B* and sighting on *H*, points *F* and *G* are set. Then by setting up at *F* and sighting on *D* the front corners of lots 13, 14, 15, etc., are determined. Another set-up of the transit at *G* with the line of sight on *E* will allow the "back bone" to be run out and the back corners of all the lots established. The check on the lines *AB*, *EG*, and *DF* is their total length. The depth of the lots can easily be checked by taking direct measurements from the front to their rear corner stakes. If a further check is desired the transit can be set up at each of the front corner stakes of the lots on one street and a right angle turned off to check the position of the rear corner stakes and the front corner stakes of the lots on the street beyond.

By the method suggested above the street lines are made straight and the slight inaccuracies which may occur in the field-work are put into the back and side lines of the lots.

Some surveyors prefer, after the front stakes on both streets are located, to set up the instrument at each front corner and locate the back corner stakes by turning a 90° angle and laying out the depth of the lot, at the same time checking the position of the front stakes on the street on the other side of the block. Then the distances along *EG* are measured to check this field-work.

275. STAKING OUT CURB* LINES AND GRADES.—If the line stakes which are set for the curbstones are placed directly on the line of the curb they will be disturbed when the trench is excavated. For this reason they are usually set in the sidewalk on an offset line, say, 3 ft. from the outside edge of the

* Called edgestones in some localities.

curb, and at intervals of about 25 ft. The grade stakes are set at about the same interval, with their tops at grade or at some even distance (6 inches or 1 foot) above or below the grade of the curb. Sometimes the grade stakes are not driven so that their tops bear any relation to the finished grade, but a horizontal chalkmark is made on the side of the stake marking the proper grade. A stake can be marked much more quickly than the top can be driven to the exact grade.

When new curbstones are being set in an old street, stakes cannot as a rule be used. The sidewalks are too hard to permit the driving of stakes, and even if they could be driven those projecting above the surface of the sidewalk would be a source of danger to pedestrians. In such cases it is customary to use heavy spikes about 6" long. These are driven into the sidewalk on the offset line and the elevation of their tops determined by leveling. The difference between the elevation of each spike and the grade of the curb opposite it is calculated. A list of the stations and the distances the spikes are above or below the curb is given to the foreman in charge of the work. These distances should always be transposed into feet and inches (to the nearest $\frac{1}{8}$ ") before being given to the foreman, as it is seldom that the men employed to lay the curbstones have any conception of the meaning of tenths and hundredths of a foot. (See Art. 7, p. 5.)

Where there are trees growing in line with the curbs, a nail can sometimes be set in the side of a tree on the line of the curb as well as at its grade. Points like these, of course, should be set in preference to offset stakes or spikes wherever possible, as there is little liability of the workmen misinterpreting such marks. They can fasten their string directly to the nail and set the curb to agree with it.

Before the curbstones are ordered the surveyor usually measures the distances between trees and locates driveways, and then makes out a list of the lengths of straight, of curved, and of chamfered stones (opposite driveways) to be used on the job. This list is used in ordering the stones, and when they are delivered they should be found to fit the conditions without the necessity of cutting any of them.

276. STAKING OUT SEWERS.— The lines and grades of sewers are sometimes run out in the same way as those described for curbstones. The stakes or spikes (in hard paving) are set on an offset line and the grades figured as described in Art. 275.

Another method which is extensively used is to spike out the center line of the sewer and, from the profile of the street, determine the depth of digging. When the excavation is completed the surveyor again runs out the center line and places batterboards at the proper grade and line. This eliminates the errors which are likely to creep in during the leveling over from the offset spikes as is done in the previous method.

277. STAKING OUT STREET RAILWAY TRACKS.— The lines and grades for street railway tracks are given usually by the use of an offset line of spikes. The spikes are frequently placed on an offset line 5 ft. from the center, or on a line 3 ft. from the gauge of the nearer rail, and at every 50-ft. station or oftener. The differences between the desired elevation of the track and the spikes is calculated, and this information is given to the foreman in charge, usually in the form of printed "grade sheets."

278. RERUNNING STREET LINES AND GRADES.— There is a constant call for lines and grades of streets. All kinds of work, such as the construction of fences, buildings, and street improvements, call for rerunning the street lines and grades.

The work of running out the line is simple enough if the original S. Bs. are in place. It is not uncommon, however, to find that in excavating a cellar on a corner lot the corner bound has been disturbed or that it has been removed entirely; and before the line can be properly staked out it may be necessary to begin at some reliable S. B. farther down the street or even on some other nearby street line.

When the line has finally been rerun it is customary to take and record swing offsets from the corners of the underpinning of several of the buildings located along the street and near to the line. By this record of offsets, then, this street line can very easily and quickly be run out at any future time, and any disturbance of the S. Bs. at the corners can readily be detected. **Several offsets to substantial buildings are often of more permanent value than stone bounds.** In some offices these offsets to

buildings are recorded directly on the street plans. Whenever a street line or grade is rerun full note should be made showing all measurements taken for determining the lines or grades.

Sometimes the original street lines have been so completely obliterated that it is necessary to resurvey them and make a new record plan and description of them and have these new lines "established" by a city ordinance. Such work, for example, has been done by the City of Providence since 1857 when a state law was passed requiring that accurate street lines be marked where the adjacent land was about to be built upon. To properly carry out this law the resurvey of a number of the principal streets was required and the policy then originated has been continued.

When a new building is to be constructed the owner generally requests the City Engineer to define the street grade in front of his property. The surveyor who has charge of this work goes to the place and levels from the nearest B. M. to the site of the new building. He has in his possession the established grade of the street and its cross-section. From these he can compute the elevation of the sidewalk grade at those points along the street line where the grades are desired. On the fence or on stakes set on the side line of the street he marks the grade of the sidewalk at the property line, usually to a hundredth of a foot.

279. REVISING STREET LINES.—In older cities much is being done toward straightening some of the crooked streets, and widening the narrow streets. A survey of existing structures is made and plotted, and the new street lines are then studied with reference to existing conditions. Several proposed lines are sometimes considered and run out on the ground. The line finally selected is carefully run out and offsets to existing structures determined so that it may be definitely located, and the areas of all property taken from each abutter are then surveyed, computed, and described. This layout is then accepted by city ordinance and the necessary construction is made in accordance with the revision.

280. REVISING STREET GRADES.—Sometimes the established grades of city streets have been laid down in the early days of the city, and it is subsequently found that these grades

need revision. In such a case the surveyor will make a profile of the center line of the street, of each curb (if there are any) and sometimes along the side lines of the street. He will also take all necessary elevations on the steps of buildings which lie near the street lines, and a few levels in the front yards of abutting property. From a study of these grades together with a plan of the street the new grade line is laid out so as to affect existing property as little as possible. When this grade line has been accepted it is run out in the usual manner and the street regraded. Stakes for final grading are set to hundredths of a foot.

281. SETTING BATTER-BOARDS FOR A BUILDING. — One of the most common tasks of the surveyor is to set the batter-boards for the excavation and construction of the cellar of a new building. The dimensions of the building and the elevation at which to set it are usually obtained from the architect, although sometimes the elevation of the ground floor of the building is recorded on the plan itself. In a brick or stone building the lines to be defined are the outside neat lines of the building, and the elevation desired is usually the top of the first floor. In the case of a wooden building the line usually given is the outside line of the brick or stone underpinning and the elevation given is the top of this underpinning on which the sill of the house is to rest. Sometimes the outside line of the sill is desired instead of the outside line of the underpinning. There should be a definite understanding in regard to these points before the work of staking out is begun.

Generally there is no elevation marked on the plan and the surveyor is simply told to set the top of underpinning a certain distance above the sidewalk or above the surface of some portion of the lot. If there is an elevation referred to City Datum marked on the plan, he should level from the nearest B. M. and set the batter-boards at the grade given.

The location of the building on the lot is given either by plan or by orders from the architect or owner. Not infrequently the surveyor receives the directions to place the building so that its front line is on line with the other buildings on the street and so that it will stand a certain number of feet from one of the side lines of the lot.

His first work is to stake out the location of the building by accurately setting temporary stakes at all of the corners of the building, e.g., in Fig. 114, at *A, B, C, D, E, and F*. A stake should be set at *G* also

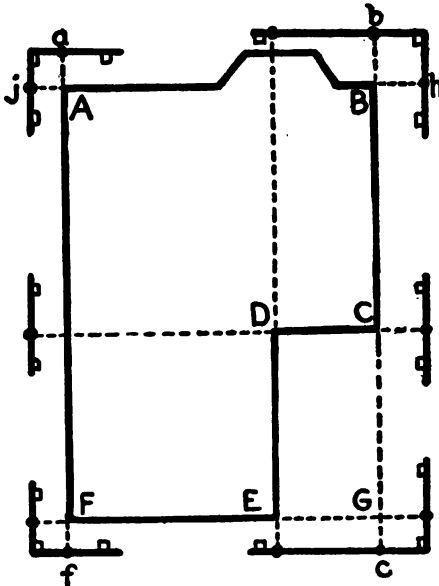

FIG. 114. SETTING BATTER-BOARDS FOR A BUILDING.

so that the entire work can be checked by measuring the diagonals *AG* and *FB*, and *GD* and *IC*. These checks should always be applied where possible. Then the posts for the batter-boards are driven into the ground 3 or 4 ft. outside the line of the cellar so that they will not be disturbed when the walls are being constructed. On these posts, which are usually of 2" x 4" scantling, 1" boards are nailed. These boards are set by the surveyor so that their top edges are level with the grade of the top of the

underpinning or for whatever other part of the building he is giving grades. After the batter-boards are all in place they should be checked roughly by sighting across them; they should all appear at the same level. Sometimes, however, on account of the slope of the ground some of them have to be set a definite number of feet above or below grade.

Then the lines are to be marked by nails driven in the top of these batter-boards. The transit is set up on one of the corner stakes of the house at *A* (Fig. 114), for example, and a sight is taken on *F*. This line is then marked on the batter-board beyond (at *f*) and on the one near the transit (at *a*). If the batter-board is so near the transit that the telescope cannot be focused on it, then point *a* can be set within a hundredth

of a foot by eye if the surveyor will stand outside of the batter-board and sight point a in a line determined by point f and the plumb-line on the instrument. Then a sight is taken along AB and this line is produced both ways and nails set on the batter-boards at h and j . In a similar manner all of the lines are marked on the batters. These points should be marked with nails driven in the top edges of the batter-boards and there should be some lettering on the boards to make clear which lines have been given. It is well for the surveyor also to show these marks to the builder or inspector and have it clearly understood just what parts of the structure these lines and grades govern.

It is customary to set batters for the jogs in the building as well as for the main corners; but small bay windows of dwellings are not usually staked out, but are constructed from wooden patterns made and set by the builder.

As soon as the excavation is begun the corner stakes are dug out and the building lines are then obtained by stretching lines between the nails in the opposite batter-boards. These batter-boards are preserved until the sills or first floor are in place, when they may be removed.

282. CITY PLANS AND RECORDS.—Every city has a large number of valuable plans and records in its possession. Too frequently these are not kept with anything like the care consistent with the amount of money that has been expended to obtain them. For suggestions regarding the filing and indexing of plans and records see Arts. 483-7, pp. 431-3.

RECTANGULAR COÖRDINATE SYSTEM OF SURVEYING CITIES.

283. GENERAL DESCRIPTION.—It is customary to disregard the effect of curvature of the earth in the survey of a city on account of its limited extent, and to use a system of rectangular coördinates based upon plane surveying. In a coördinate system two arbitrary lines are chosen for coördinate axes, one usually coinciding with some meridian and the other at right angles to it. All points in the city are located by distances from these two axes, these distances being known as X 's and Y 's, or sometimes

as latitudes and longitudes. The axes are sometimes chosen entirely outside the area to be surveyed, and where they meet (their *origin*) is designated as (0, 0.). Sometimes they are taken through some conspicuous point, such as the tower of the city hall, and are considered as being certain distances from the zero lines as (10 000, 10 000). By either of these arrangements negative values for coördinates are avoided. The coördinates are usually considered positive toward the north and the east, in accordance with the custom of analytic geometry, as is the case in ordinary land surveying. The convergence of the meridians is neglected and all points having the same X coördinate therefore lie on a straight line parallel to the initial meridian and are not all on the same true meridian line.

In the survey of the city of Baltimore (Fig. 115) the origin of coördinates was taken through the Washington Monument in the central part of the city, and the map divided into squares 1000 feet on a side. Each square mile is shown on a separate page of the atlas of the city and these squares are designated by their number north or south, and east or west of the origin, as 1S2W, 3N4E, etc. Any point is designated by the distance in feet north or south, and east or west, as (1000 E, 2000 N).

One of the chief advantages of any coördinate system is that if any point is lost it can be exactly replaced by means of the known coördinates. This would be especially true in case a large section of the city were destroyed by fire.

284. TRIANGULATION SCHEME.—The principal points of the survey are usually located by a system of *triangulation*. Prominent points are selected in such positions that the lines joining them form well shaped triangles, i.e., preferably triangles which are not far from equilateral. These points may be signals on tops of hills, church spires, and the like. If the cupola of the city hall, or some such point is chosen as the origin of coördinates it should also be one of the triangulation points. Points which can be occupied by an instrument are in general to be preferred. Such points as steeples or flag poles are definite enough, but where no definite object exists on which to sight the instrument signals are erected for this purpose. Such a signal usually consists of a pole placed carefully over the exact



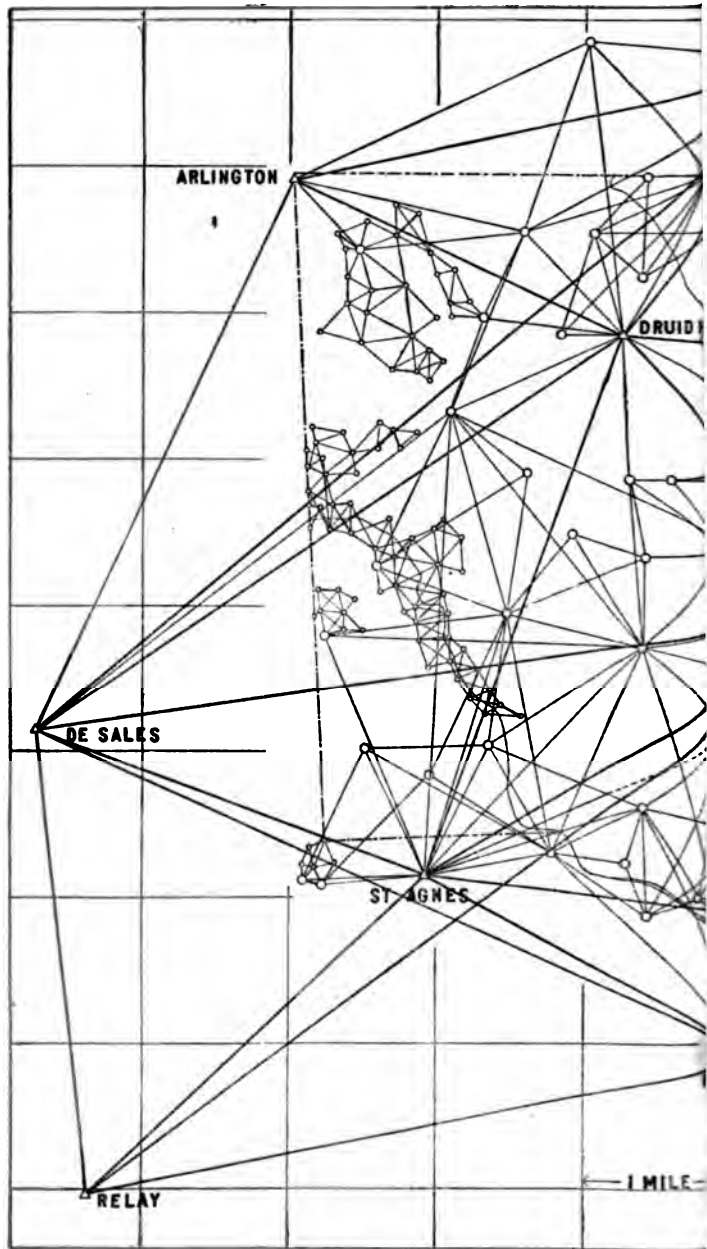
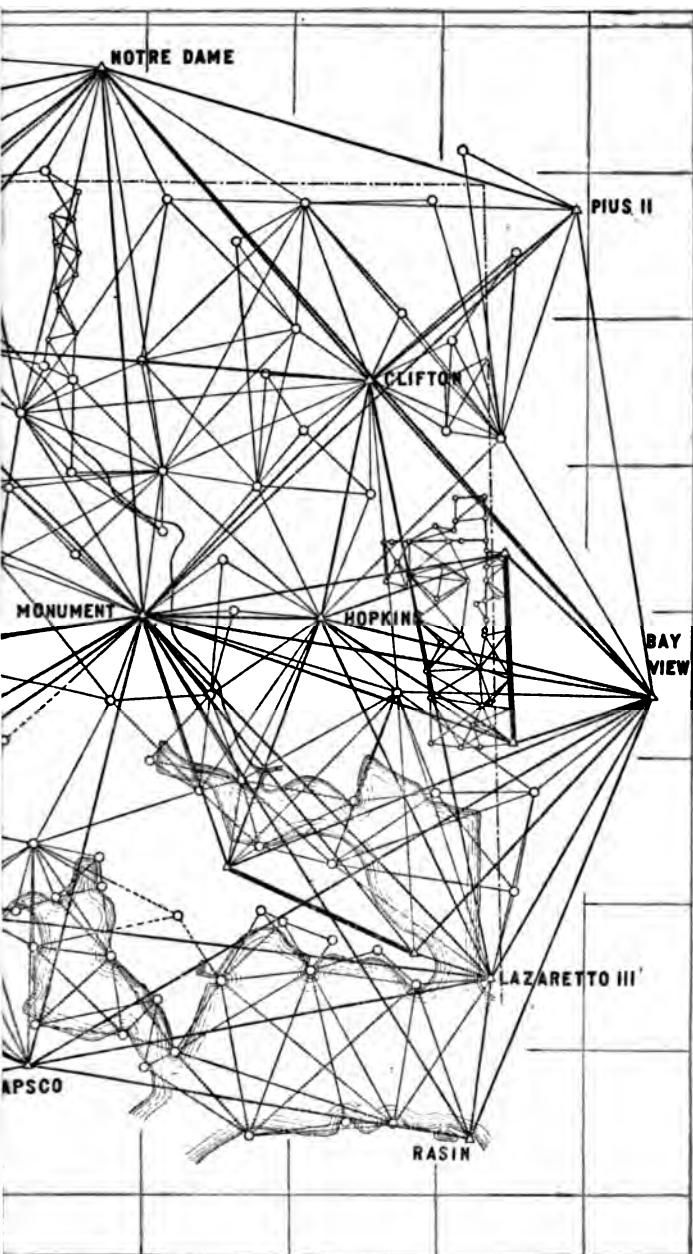

FIG. 116. TRIANGULATION SCHEME #

(Printed by permission of Major Joseph W. Shirley, Chief Eng



SURVEY OF THE CITY OF BALTIMORE.
 of the Topographical Survey Commission, Baltimore, Md.)

point and braced in a vertical position by other poles forming a tripod.

The system of triangles should cover the entire area but should not contain more lines than are necessary to establish a sufficient number of points to control the subsequent work of the survey.

285. MEASUREMENT OF BASE-LINE.— At least one line in the system must be chosen where its length can be very accurately measured; this is called the *base-line*. The lengths of all the other lines are to be computed from this line by means of the measured angles, hence it will be seen how important it is that this line should be measured with great accuracy, and that it should also form a well shaped triangle with the connecting triangulation stations.

It should be chosen if possible in some level spot where there are no serious obstacles to the measurement. It is sometimes an advantage to have the ends of the base-line slightly elevated above the general level. The base should be measured with a steel-tape the exact length of which is known. The tension should be kept constant by means of a spring balance, and the temperature carefully taken. If the work is done on a cloudy or rainy day the thermometer readings will represent the temperature of the tape much more nearly than when taken in sunshine. The points should be lined in with a transit and the tape held horizontal, or, if the measurements are taken directly from stake to stake, the slope should be determined, by means of a leveling instrument. There should be at least two independent measurements of the line.

286. MEASUREMENT OF ANGLES.— If possible all of the angles of each triangle should be measured by repetition. An "inverting" instrument reading to 20'' or to 10'' is to be preferred for this work. The angles are repeated at least six times with the telescope direct and the same number of times with the telescope inverted. Several of these sets of readings are made beginning each time with a different initial setting on the circle. For example, if the first setting was at 0° and four sets are to be taken the second would begin with a setting of 90°, and so on. In each case both verniers should be read and the mean

of the two taken. Sometimes the direction of the measurement is changed during the set, the first six repetitions being taken from left to right, and the second six from right to left. In this work it is important that the instrument should be carefully centered over the point, and that the signals are also carefully centered. It is also important to keep the instrument carefully leveled, especially if there is great difference in the angular elevation of the points sighted.

287. Adjustment of the Angles. — The test of the accuracy of the angle measurements is in the "closure" of the triangles. In good work the sum of the angles of a triangle should not differ from 180° by more than about 5 seconds, under fair conditions. After the angles have been measured the errors in the closure of the triangles should be distributed equally among the angles, thus making the sum of the angles in each triangle exactly equal to 180° . If the best results are desired all of the discrepancies due to errors of measurement can be removed by adjusting the system in accordance with the "Method of Least Squares." In ordinary work, however, where the errors have been kept small, the expense of such a computation is not warranted. After all of the angles have been corrected the sides of the triangles may be computed.

288. AZIMUTH. — If the coördinate lines are to run N and S and E and W it is necessary to know the astronomical azimuth of at least one line of the triangulation system before the coördinates can be computed. This may be determined by observation on Polaris as described in Chapter VII, or, in case there are other triangulation points already established in the vicinity, the new system can be connected with them and the azimuths computed from one of these lines. Azimuths are reckoned in this work from lines parallel to the initial meridian, from the south point right-handed, i.e., in the direction S-W-N-E, and from 0° to 360° . When the azimuth of one line is known all of the others may be computed. With the azimuth and length of each line known the difference of the latitudes and departures, i.e., the difference of the X s and Y s of the ends can be found, and with the coördinates of some one

point given, or assumed, the coördinates of all of the other points can be computed as explained in Art. 410, p. 373.

289. SECONDARY AND TERTIARY TRIANGULATION.—After the principal triangles have been completed, forming a system of control, smaller triangles are selected, locating a system of points of lesser importance so far as the survey is concerned. This is called the *secondary system*. Sometimes a third (*or tertiary*) system is introduced, the triangles being still smaller. The tertiary triangles are the ones that would be used for locating the city boundaries, street corners, and important monuments.

It frequently happens that, owing to the large number of angle measurements and the consequent accumulated error, the lengths of the sides of the small triangles become much less accurate than they would be if measured directly; and since many of these lines naturally lie in places where the distance can easily be measured, this measurement should be made as a check, in which case this line becomes a *secondary base-line*. It is a good plan to introduce these measurements frequently, where it can be conveniently done without great expense, in order to prevent the errors of the survey from accumulating unnecessarily.

290. TRAVERSES.—After all of the triangulation is completed the system is extended by running traverses with the transit and tape, from one known point to another. The triangulation points are regarded as fixed and the errors of closure of the traverses are assumed to be entirely in the traverse surveys, the traverses being made to fit in exactly between the triangulation points.

All street lines, or parallel offset lines, are connected with the coördinate system so that the azimuth of every street line in the city may be known, and the coördinates of all important points, such as street corners and lot corners, are computed.

291. METHOD OF LOCATING PROPERTY LINES AND BUILDINGS.—Since the coördinates of the property corners are to be computed it is advisable to locate them by angle and distance from the transit points, for with these data the calculation of the coördinates is simple. The buildings are located from the transit line by methods explained in Chapter VI.

CHAPTER X.

TOPOGRAPHICAL SURVEYING.

292. In making a survey for a topographical map the methods used will depend upon the purpose for which the map is made and the degree of accuracy which is required. But whatever the purpose of the map may be it is not necessary to locate points in the field more accurately than they can be represented on paper, whereas in surveying for an area measurements are made with far greater precision than would be necessary for the purpose of plotting.

While most of the details of topographical surveying can be filled in more economically by the use of the *transit* and *stadia* or by the *plane table* it is thought best to describe here only the more elementary methods, and to reserve the complete treatment of the *stadia* and *plane table* for an advanced work.

293. **TRIANGULATION FOR CONTROL.**— In all cases where the area is large it will be advisable to use a system of triangulation to control the survey, as this is the cheapest method of accurately determining the relative position of a few points which are a considerable distance apart. The details of this triangulation work have already been described under the head of "Rectangular Coordinate System of Surveying Cities," Chapter IX. One line of the survey, the base-line, must be carefully measured. The precision with which the angles of all the triangles must be measured depends upon the use to be made of the map. After the principal triangulation points have been established their positions are plotted on the map. This may be done conveniently by the method of rectangular coördinates described in Art. 283, p. 255. The extension of the system to smaller systems of triangles, called *secondary* and *tertiary*, may be made if necessary. After the triangulation system has been extended far

enough to furnish a sufficient number of points for controlling the accuracy of the map, traverses may be run wherever convenient or necessary for locating topographic details. In all cases the traverses should be connected with the triangulation points at frequent intervals in order that the relative positions of all points may be kept as nearly correct as possible. Where a high degree of accuracy is necessary these traverses should be run with a transit and tape; if, however, errors of a foot or two would not be appreciable on the map it will be sufficiently accurate to use the stadia method of measuring the distances and thus save time.

294. LOCATION OF POINTS FROM THE TRANSIT LINE.—

Where a tape is used for measuring the distances, such objects as fences, walls, and buildings may be located as described in Chapter VI, but it will not be necessary to make the measurements with as great precision. Fig. 116 is a sample page of notes of a topographical survey where the transit and tape were used. On city plans, which are frequently drawn to a scale of 40 feet to an inch, a fraction of a foot can easily be shown. On a topographic map the scale is often such that an error of a fraction of a foot becomes insignificant in the side measurements from the transit line, where such errors cannot accumulate. In some cases it may be sufficient to obtain the distances by pacing, and the angles or directions by means of a pocket compass. Locations may frequently be checked by noting where range lines intersect the transit line. In making a series of measurements it is well to take each measurement with a little more precision than is actually needed for plotting, in order to be sure that the accumulated errors do not become too large.

In taking measurements the surveyor should constantly keep in mind how the notes can be plotted; this will often prevent the omission of necessary measurements. No matter whether an accurate or only a rough survey is desired **check measurements** should be taken on all important lines.

295. CONTOUR LINES.—

There are two general systems of representing on paper the form of the surface of the ground.

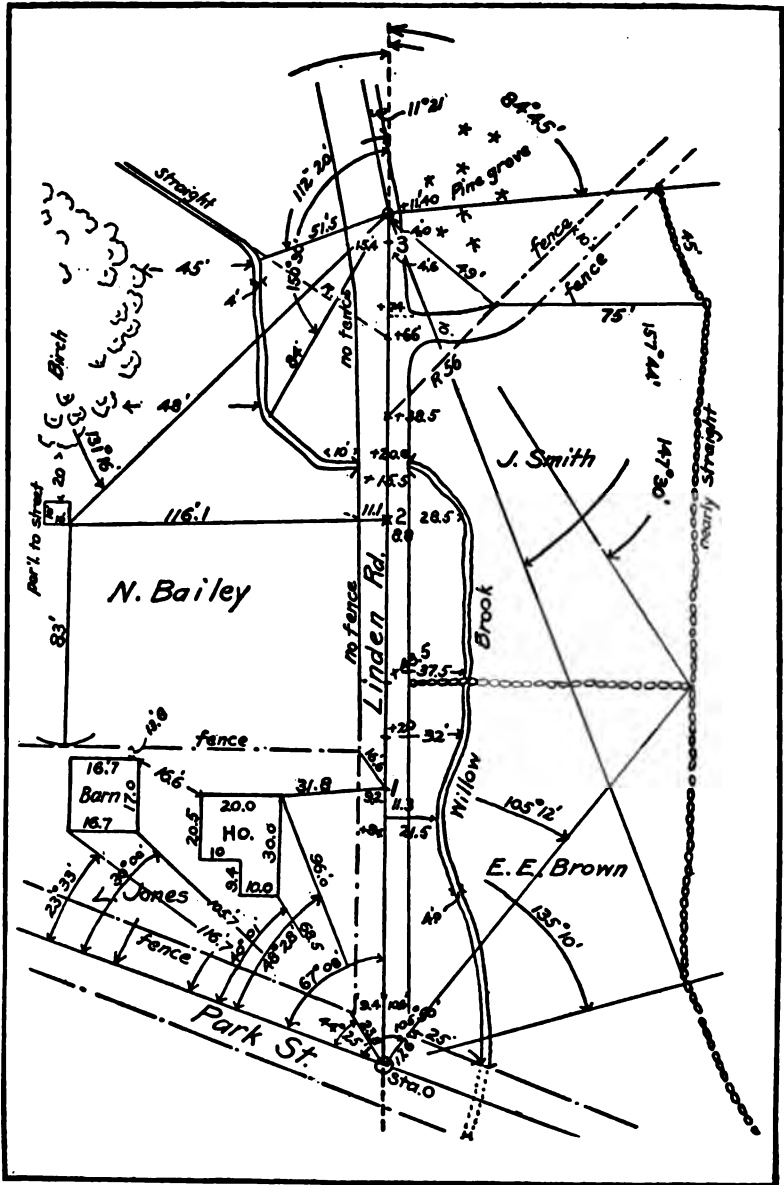

FIG. 116. FIELD NOTES OF A PORTION OF TOPOGRAPHICAL SURVEY WITH TRANSIT AND TAPE.

In one of these systems (Fig. 117) slopes are represented by *hachure lines*, i.e., lines which always run in the direction of the steepest slope of the ground. In the other system (Fig. 118) *contour lines*, lines joining points of equal elevation, are used. In the latter system elevations may be read directly from the map, and for this reason it is much more used by surveyors.

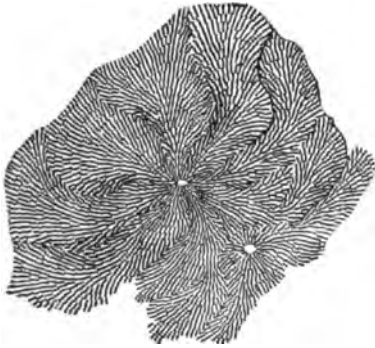

FIG. 117. HACHURE LINES.



FIG. 118. CONTOUR LINES.

A contour line is the intersection of a level surface with the surface of the ground. A clearer conception of a contour line may be obtained from the following. Imagine a valley, or depression in the surface of the ground, partly filled with water. The shore line of this body of water will then be a contour line, since it is the intersection of a level surface with the surface of the ground. If the water stands at an elevation of 50 feet the shore line is the 50-ft. contour. If the surface of the water were raised 5 feet the new shore line would then be the 55-ft. contour. Contour lines if extended far enough will therefore be closed curves, and all of the points on any one contour will have the same elevation above the datum. It is customary to take contours a whole number of feet above the datum, spacing them in regard to height, so as to make the *contour intervals* equal, e.g., a contour may be taken at every 5 feet or every 10 feet of elevation. Since the contours are equidistant in a vertical direction their distance apart in a horizontal direction shows the steepness of the slope.

Fig. 119 illustrates contour maps of simple solids.

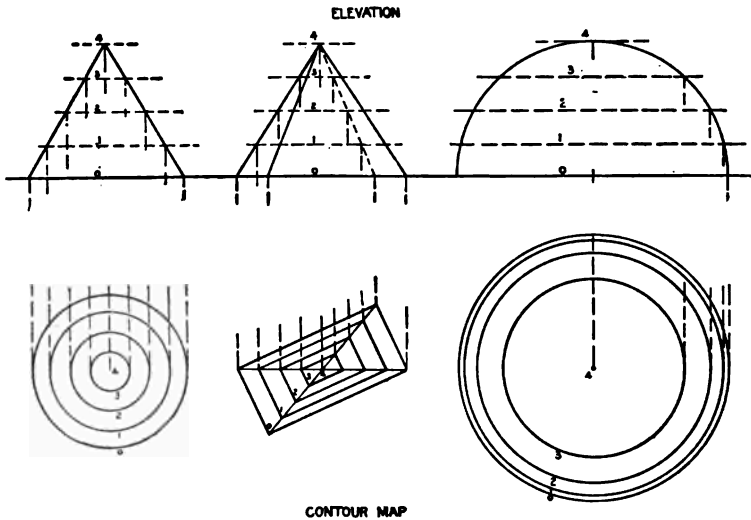

FIG. 119. CONTOUR MAPS OF SIMPLE SOLIDS.

296. Characteristics of Contours. — The chief characteristics of contours are illustrated in Fig. 121, and may be summed up as follows.

1. All points on any one contour have the same elevation, as at *A*.
2. Every contour closes on itself, either within or beyond the limits of the map. In the latter case the contour line will not end within the limits of the map but will run to the edge of the map, as at *B*.
3. A contour which closes within the limits of the map indicates either a summit or a depression. In depressions there will usually be found a pond or a lake; but where there is no water the contours are usually marked in some way to indicate a depression, as at *C*.
4. Contours can never cross each other except where there is an overhanging cliff, in which case there must be two intersections, as at *D*. Such cases as this seldom occur.

5. On a uniform slope contours are spaced equally, as at *E*.
6. On a plane surface they are straight and parallel to each other, as at *F*.
7. In crossing a valley the contours run up the valley on one side and, turning at the stream, run back on the other side, as at *G*. Since the contours are always at right angles to the lines of steepest slope they are at right angles to the thread of the stream at the point of crossing.
8. Contours cross the ridge lines (watersheds) at right angles, as at *H*.

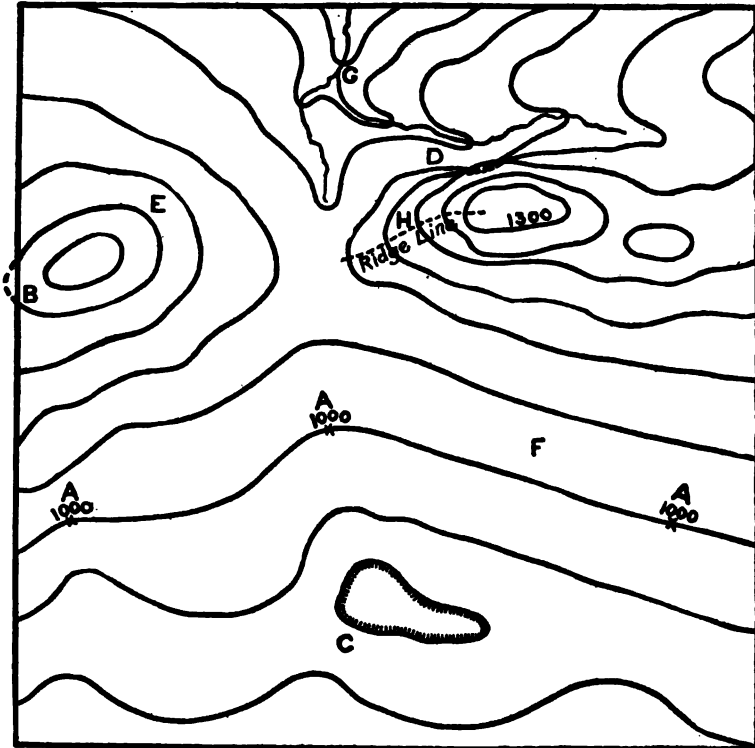

FIG. 121. ILLUSTRATING CHARACTERISTICS OF CONTOURS.

Fig. 120 shows a contour across an ordinary city street with sidewalks and curbstones, the street being located on a steep grade. In order to trace out the position of a contour it is necessary to keep in mind that it is a line all points on which are at the same elevation. It will be noticed that the contour from *A* to *B* crosses the sidewalk in a straight line but not perpendicular to the street line because the sidewalk is sloped toward the gutter. Turning at *B* it runs straight along the face of the curbstone until it strikes the gutter at *D*, and returns on the other side of the gutter along the surface of the road, the point *E* being where it swings around and travels back toward the other gutter. The other half of the street is similar. If the center of the road is at the same elevation as the top of the curb opposite, then *E* will be opposite *B*. This illustrates how contours run around valleys (gutters) and ridges (crown of street).

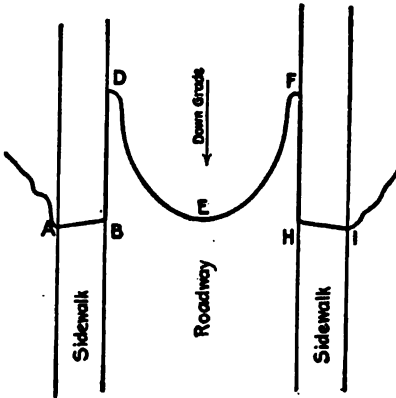

FIG. 120. CONTOUR CROSSING A STREET.

If the side of the street to the right (*HF*) were at a lower elevation than the left side then the contour at the point where it crosses the gutter, *F*, would be farther up the road from *E*, i.e., the contour would be unsymmetrical, *EF* being longer than *DE*.

297. RELATION BETWEEN CONTOUR MAP AND PROFILE. —

If a line is drawn across a contour map the profile of the surface along that line may be constructed, since the points where the contours are cut by the line are points of known elevation and the horizontal distances between these points can be scaled or projected from the map. The profile shown in Fig. 122 is constructed by first drawing, as a basis for the profile, equidistant lines, corresponding to the contour interval, and parallel to *AB*. From the points where *AB* cuts the contours lines are projected

to the corresponding line on the profile. Conversely, if the profiles of a sufficient number of lines on the map are given it is possible to plot these lines on the map, mark the elevations, and from these points to sketch the contours as described in Art. 301, p. 276.

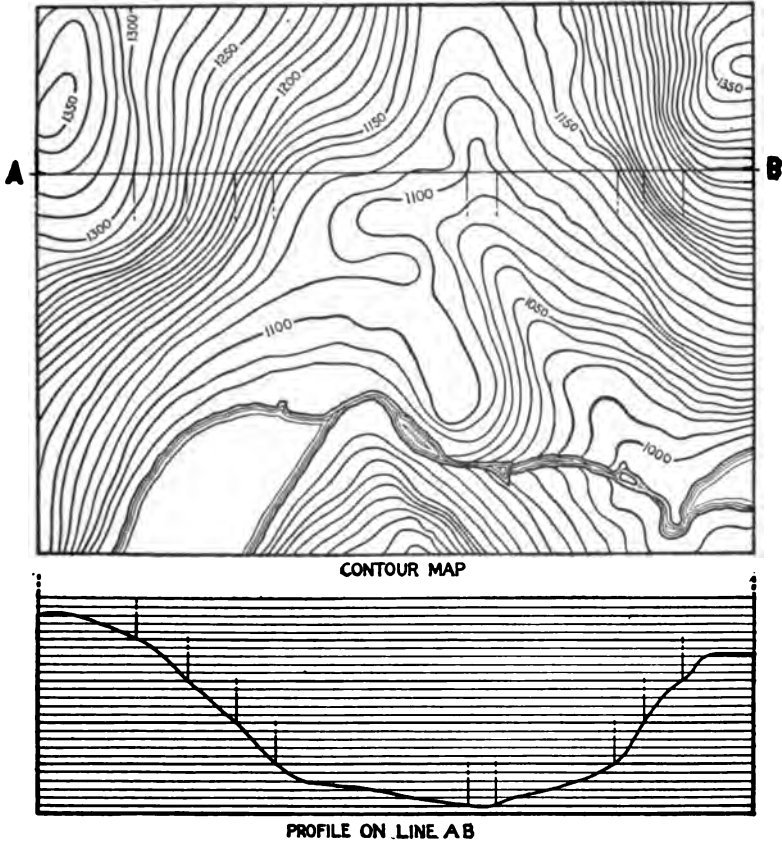

FIG. 122. PROFILE CONSTRUCTED FROM A CONTOUR MAP.

298. RELATION BETWEEN CONTOUR MAP AND SIDE ELEVATION OR PROJECTION. — A photograph of a landscape represents approximately a side elevation of the country. To

construct such a projection from a contour map (Fig. 123), lines

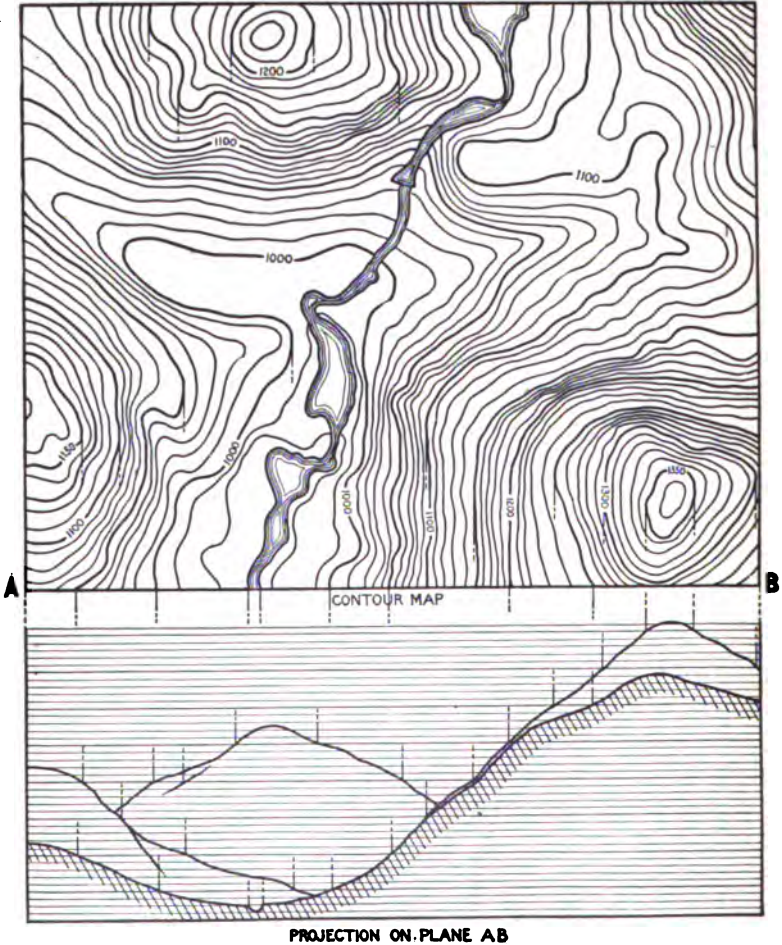

FIG. 123. SIDE ELEVATION CONSTRUCTED FROM A CONTOUR MAP.

are drawn perpendicular to AB , the plane of projection, and tangent to the contours. These tangent points show the limits between the visible and invisible portions of the landscape, the observer being assumed to stand on the line AB and to look in a direction perpendicular to AB .

299. DRAINAGE AREAS. — The drainage area that supplies a stream or pond is limited by the *divide line* which is a line drawn on the ridges surrounding a depression as indicated by the dotted line on Fig. 124. Since the perpendicular to the contour at any point is the direction of steepest slope the direction in which water will flow at any point can be determined at once by examining the contours. On the ridge there is a line (its summit) on one side of which water will flow down one of the slopes and on the other side of which it will flow down the other slope. This line is the divide line or *watershed line*.

If a dam were built as shown in Fig. 124, its elevation being 960 ft., the area actually flooded by the water at full height of dam is the area included within the 960 ft. contour, which is indicated by the shaded section. The drainage area for the portion of the stream above the dam is the area included within the heavy dotted line, which follows the line of the divide.

300. SKETCHING CONTOURS FROM STREAMS AND SUMMITS. — The present topography of some parts of the country is due almost entirely to erosion by streams. Consequently the position and fall of the streams give more information regarding the position of the contours than any other topographic features. If a definite position of the contours is desired it will be necessary to obtain the elevation of a few governing points on the ridges as well as the location and elevation of the streams, as shown in Fig. 126.

In sketching in contours from these data it should be borne in mind that the contours cross the stream at right angles to its thread and that they curve around from the hill on either side so as to represent the valley of the stream. The contours are farther apart at the top and bottom of the slope of an eroded hill than near the middle, because in these portions the slope is somewhat flatter. A stream is usually steeper near its source than in the lower portion and therefore the contours are closer together near the source. This is true of most cases but the shape of the contours in any particular case will depend upon the geological formation. Fig. 127 represents the same country as Fig. 126 but with the contours sketched on it, following out the general suggestions which have just been mentioned.

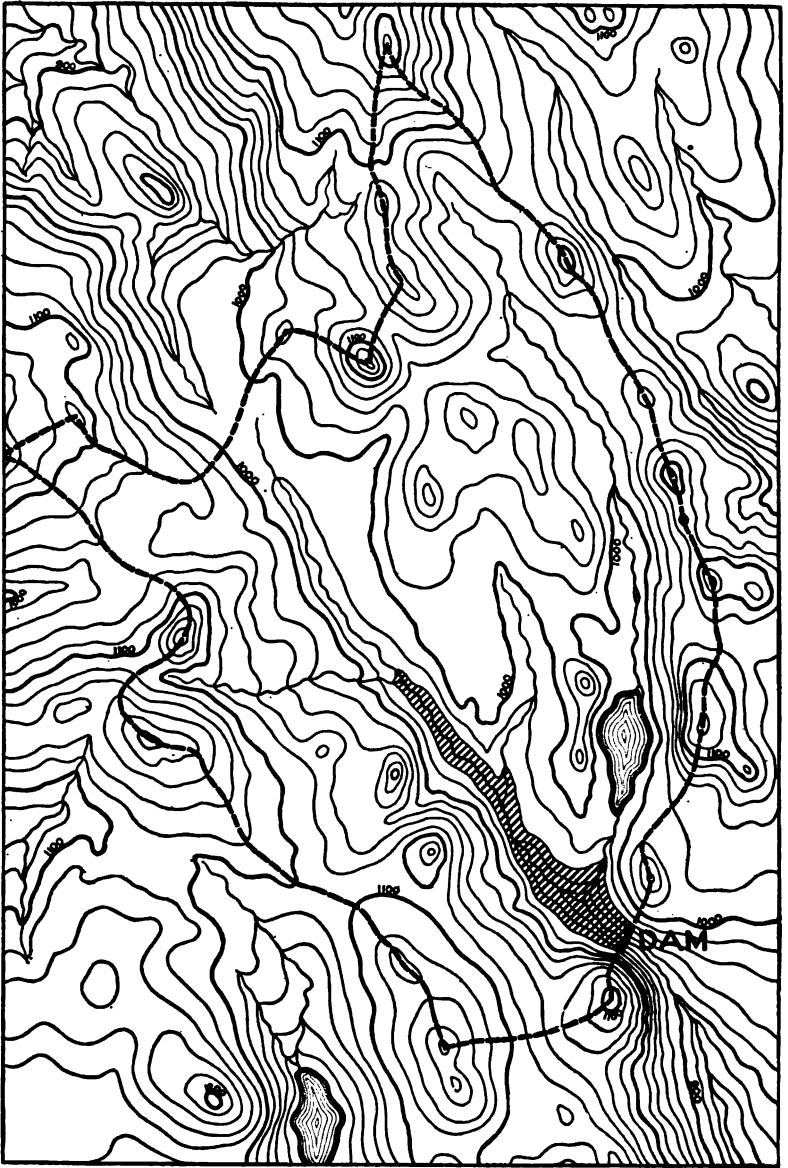

FIG. 124. ILLUSTRATING FLOODED AREA AND DRAINAGE AREA.

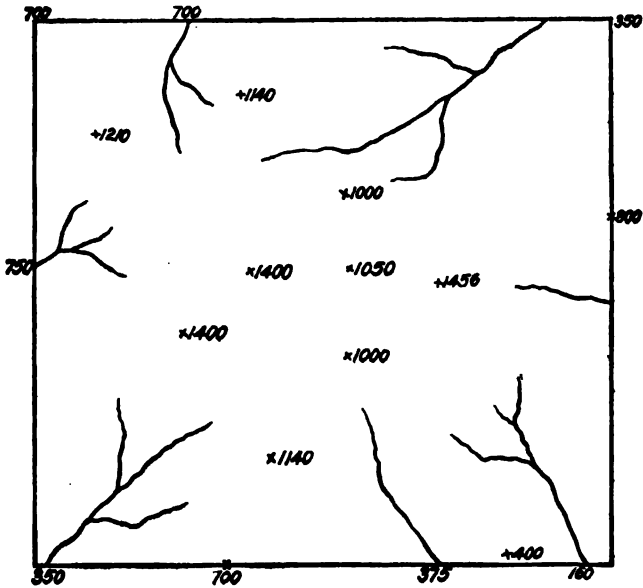

FIG. 126. MAP SHOWING THE LOCATION AND ELEVATION OF STREAMS AND SUMMITS.

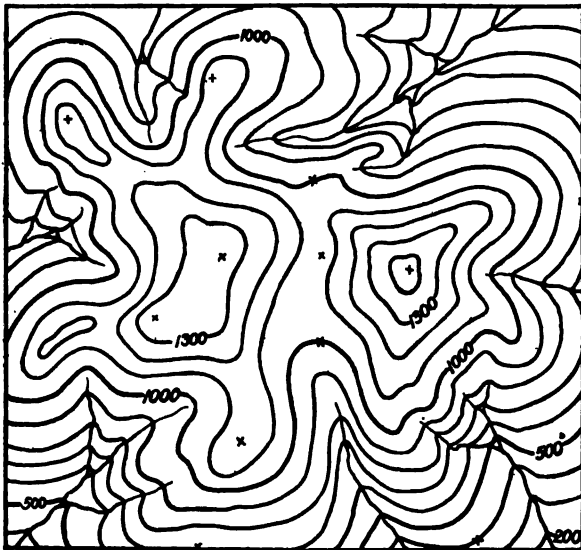

FIG. 127. CONTOURS SKETCHED FROM THE DATA GIVEN IN THE MAP ABOVE.

301. SKETCHING CONTOURS FROM KNOWN ELEVATIONS.

— A portion of the country can be cross-sectioned as described in Art. 227, p. 206, or profiles can be run on any desired lines as explained in Art. 225, p. 203. From these known elevations contours can be sketched by interpolation. This is usually done by estimation and the principle involved is the same whether the elevations were obtained by cross-sectioning or by profiles.

Fig. 125 illustrates how contours can be sketched from cross-

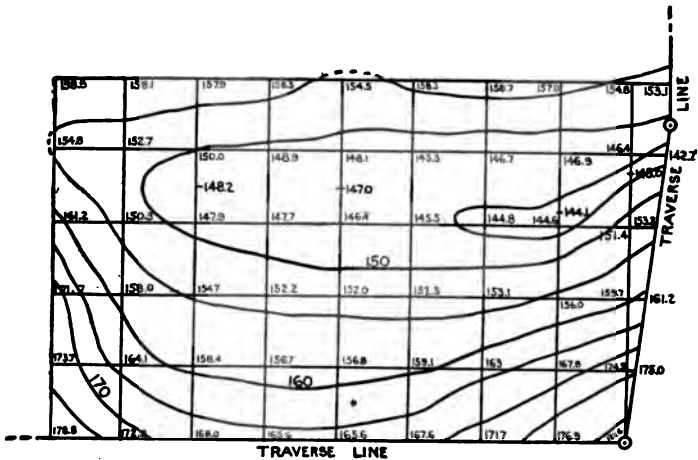

FIG. 125. CONTOUR SKETCHED FOR CROSS-SECTION NOTES.

section notes. The points at which elevations are taken in the field should be so chosen that the slope of the ground is practically uniform between any two adjacent points. Then by simple interpolation the contours may be accurately sketched. This interpolation may be done by geometric construction, but for most topographic work it is accurate enough to interpolate by eye.

302. MISTAKES IN SKETCHING CONTOURS. — Fig. 128 shows several examples of impossible and incorrectly sketched contours; the streams are assumed to be correctly located. The numbers on the figure refer to the tabulation made in Art. 296, p. 268, and will assist in detecting the type of error present.

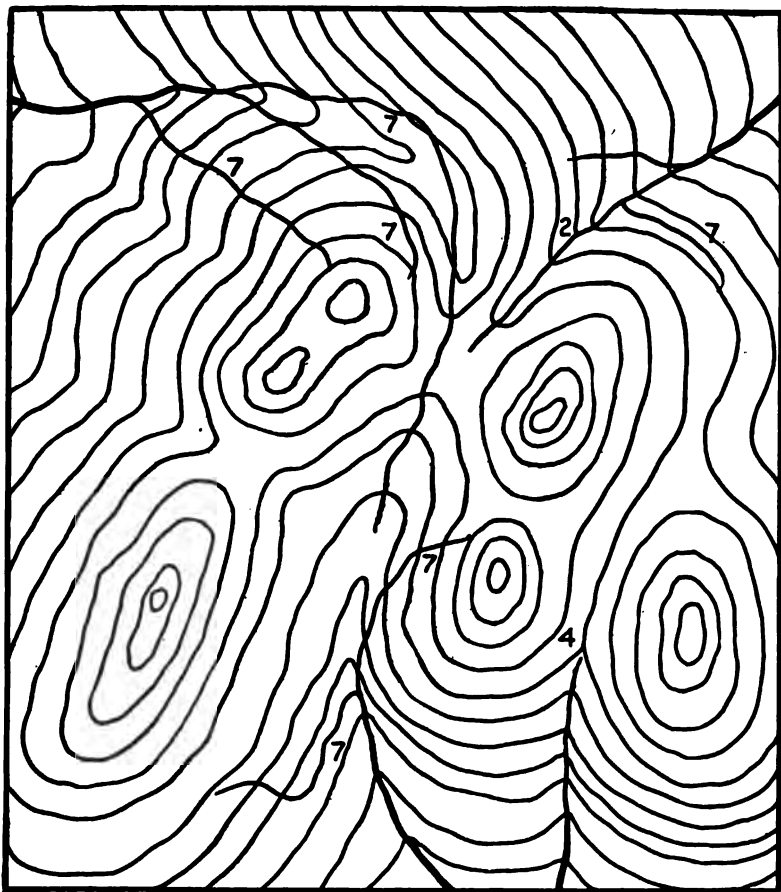

FIG. 128. CONTOURS INCORRECTLY SKETCHED.

303. LOCATING CONTOURS. — Contours are often most economically located by means of the *transit and stadia* or by an instrument called the *plane table*.* In this chapter, however, only those methods will be considered which call for the use of the transit and tape.

* A discussion of the Stadia and the Plane Table does not come within the province of this book.

304. Locating Contours by Cross-Sections. — A very common as well as expensive method of locating contours is that of taking cross-sections. Elevations on the surface of the ground are usually taken to tenths of a foot. From these elevations the contours may be sketched by interpolating between these known elevations as explained in Art. 301. The accuracy may be increased by taking a larger number of intermediate points. The size of the squares used should depend upon the roughness of the surface.

305. Locating Contours by Profiles. — In some cases where the ground is fairly smooth it is sufficient to take a few profiles on known lines, not necessarily at right angles to each other. These lines are stationered and elevations are taken at every full station and at the points of marked change in slope. From these data the contours are sketched on the map by interpolation as described in Art. 301.

306. Locating Points on the Contours. — Where the contour interval is small, say one or two feet, and the topography is to be determined with considerable accuracy, it is advisable to find, in the field, points actually on the contours and thus avoid the errors of interpolation. The rodman moves up or down the slope until the rod-reading indicates that the foot of the rod is on a contour. The position of the rod may then be located by an angle and a distance from some known line, the distance being taken with a tape.

307. Locating Contours by the Hand Level. — A more rapid but less accurate way of putting in contours is by means of the hand level. The work is done by making profiles of lines whose positions on the map are known. A point on some contour is found in the following manner.

The first step to take is to measure to the nearest tenth of a foot the distance from the ground to the eye of the leveler, which may be, say, 5.4 ft. If the B. M. is at elevation 143.43 and it is desired to locate a point on the 140-ft. contour, the rodman holds the rod (or a tape) on the B. M. while the leveler attempts to place himself on the 140-ft. contour. When he is on the 140-ft. contour the elevation of his eye (H.I.) is 145.4

and the rod-reading at the B. M. must be $145.4 - 143.43 = 1.97$, or 2.0 to the nearest tenth of a foot. The leveler therefore travels along the line on which the point is to be located until he reads 1.97 on the rod. His feet are then on the 140-ft. contour, the position of which is located from some known point on the line. Sometimes this is done by measurement and sometimes by pacing. A point on the 145-ft. contour could have been located first by applying the same principle, but if the 140-ft. contour is established it is very easy to locate a point on the 145-ft. contour as follows. The distance from the leveler's feet to his eye being 5.4 ft., if he stands on the 140-ft. contour and reads 0.4 ft. on the rod, the bottom of the rod must be on the 145-ft. contour. By trial then the point is found where the rod reads 0.4 ft.* Then the leveler walks up the hill and, standing on the point just found, places the rodman on the next higher contour by the same process.

In working down the hill to locate the 135-ft. contour, if the leveler is standing on the 140-ft. contour, the rod will be on the 135-ft. contour when it reads 10.4 ft. Or, when the 140-ft. contour has been found by the leveler the rodman comes forward and holds the rod on this spot and the leveler backs down the hill until he reads 0.4 ft. on the rod; he is then standing on the 135-ft. contour. Some surveyors prefer to cut a stick just 5 ft. long and hold the hand level on the top of it in taking sights.

The points thus found at regular contour elevations are then plotted on the corresponding lines and the contours sketched by joining points of equal elevation. Where the lines which are profiled are far apart or where the country is very rough it is frequently necessary to obtain the correct position of the contours, to locate extra points on them between these profiled lines. The extra points are located by right-angle offsets from the lines. Most of this work is plotted in the field upon paper ruled in small squares to facilitate sketching. Where practicable it is always well to sketch the contours in the field rather than in the office.

* For very rough work sometimes the rod is not used, the leveler simply estimating where the rod-reading will come on the rodman's body and placing him so that his feet will be on the proper contour.

308. LOCATION OF STREAMS AND SHORE LINES. — Streams or shore lines of ponds may be very rapidly located by stadia measurements. If the shore lines are to be located by tape measurements, however, a convenient way is to run a transit line approximately parallel to the general direction of the shore line, and to take perpendicular offsets at regular intervals and at all points where there is a marked change in the direction of the shore line, as was done in the notes in Fig. 53, p. 104.

309. CONTOUR PROBLEMS. — There are many surveying problems involving earthwork which can be worked out approximately by use of a contour map. As a rule the smaller the contour interval, the more accurate will be the result of such work. Contour studies occur in a variety of problems, so numerous that it would be useless to attempt to cover the subject fully. Three typical problems, however, are illustrated and explained; and these contain the essential principles applicable to practically all contour studies.

310. EXAMPLE 1. — (Fig. 129). Given a contour map, the surface being represented by contours shown by full lines, a plane (extended indefinitely) is passed through the straight lines AB and CD , which are level and parallel, AB being at elevation 12.5 and CD being at elevation 40. It is required to find where this plane intersects the surface, and to shade the portion which is above the plane.

Since the proposed surface is a plane, contours on it will be parallel to AB and CD . The elevations of AB and CD being known, other contours, such as ef and gh , can be interpolated between AB and CD . Their interval is made 5 ft. the same as the contour interval for the original surface. Evidently the point where any of these parallel lines crosses an original contour of the same elevation, as j , k , l , m , or n , is a point on the intersection of the plane with the surface. Joining these points gives the line of intersection of the plane with the original surface, which is indicated by the heavy full line on the figure. Such points as q , s , or t are determined by interpolation. Intermediate contours are drawn at one-foot intervals between the original surface contours; corresponding lines are interpolated between the straight contours which show the plane; additional

intersections obtained, and in this way the point p is determined. Again it will be seen that point t , with reference to the parallel straight contours, is at about 18.5; with reference to the original

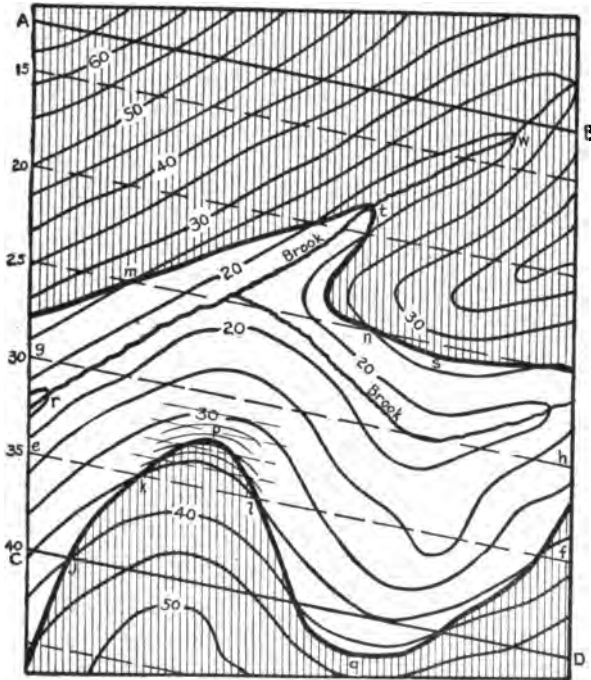

FIG. 129.

contours, it will be seen that wt is about three-tenths of wr , the distance between contours, and this makes the elevation of point t equal to 18.5.

311. EXAMPLE 2.— (Fig. 130.) Given a contour map which includes a road, and on which the original contours are represented by full lines. It is desired that all of the road between A and B shall be visible from the ground at point C . Sketch on the map and shade the portions which will have to be cut down to fulfill this requirement.

The general method of solving this problem is to sketch a new set of contours on the map, which will represent a uniform

slope from *C* to the nearer edge of the road. Everything that is above the surface represented by these new contours must be cut away.

First draw lines, such as *Ca*, *Cb*, and *Cc*, the points *a*, *b*, and *c* being points on the upper side of the road between which it may be assumed that the slope is uniform (Art. 301, p. 276). Along these lines interpolate points which will lie on the uniform slope from *C* to the road and also on the regular 5 ft. intervals which correspond to the contours. For example along the line *Ca*

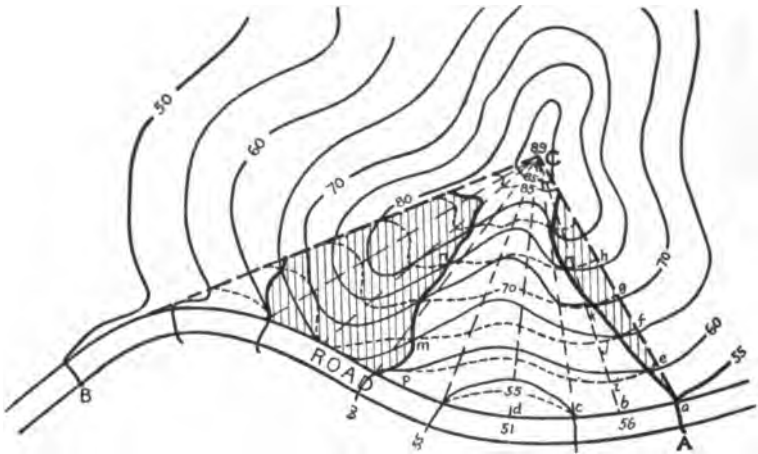

FIG. 130.

from the summit which is at elevation 89 to the road at *a* which is at elevation 55, there is a drop of 34 ft., or a little less than 7 contour intervals. Points *e*, *f*, *g*, *h*, etc. are therefore plotted so as to divide *Ca* into 9 equal parts. Similarly points *i*, *j*, *k*, etc. are plotted along the line *Cb*, but the point *b*, being at elevation 56, is plotted so that the distance *ib* is four-fifths of the other distances *ij*, *jk*, etc. When these points have been plotted on all of the necessary diagonal lines, the contours representing a uniform slope from *C* to the road are sketched on the map as shown by the dotted lines on the figure. The points, such as *m*, *n*, or *r*, where the new contours cut the old contours of equal elevation, are points of "no cut and no fill." A line connecting these

points encloses portions of either cut or fill. The shaded portions of the figure, where the new contours are nearer *C* than the corresponding old ones, represent the portions where it will be necessary to excavate to the surface represented by the dotted contours. In the central portion of the figure, from point *c* to *p*, the road can already be seen.

312. EXAMPLE 3.— (Fig. 131.) Given a contour map on which are shown the two side lines of a road, the contours being represented by full lines. The road is to be built on a 4% down grade starting at *A* at elevation 55. Scale 1 inch = 150

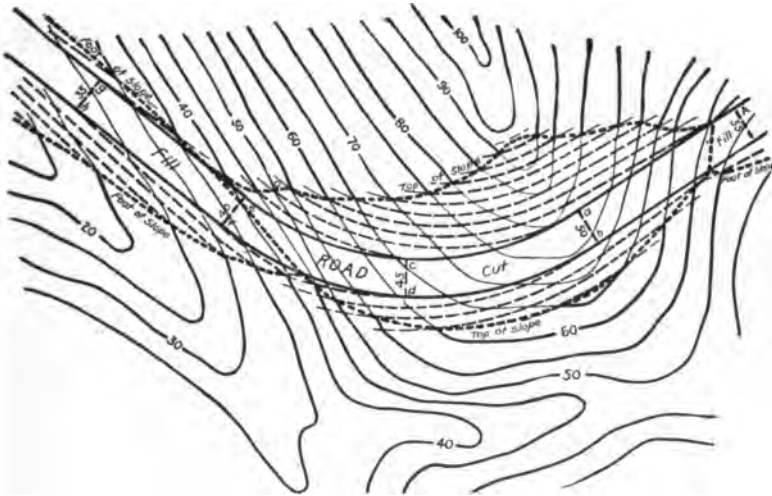

FIG. 131.

feet. Side slopes of road to be $1\frac{1}{2}$ horizontal to 1 vertical. It is desired to sketch the new contours on the slopes of the road, to sketch on the map the top and foot of slopes, and to designate the portion in embankment and the portion in excavation.

First, the new contours which are to cross the road are plotted at *ab, cd, ef, gh*. These will be 125 ft. apart, as a 4% grade falls 5 ft. in a distance of 125 ft. If the road is assumed to be level on top, then these lines will cross the road at right angles to its general direction as shown in the figure. From points *a* and *b*, on either edge of the road, the new contour

lines will follow along the slope, e.g., the line ao represents the new 50 ft. contour. Where this contour ao passes point c it is just 5 ft. above the road. Since the slope of the cut is $1\frac{1}{2}$ to 1, then the distance cut from c must be $1\frac{1}{2} \times 5 = 7.5$ ft.; opposite e it is 10 ft. below the road and similarly the distance out from e must be 15 ft. Where this new 50 ft. contour meets the old

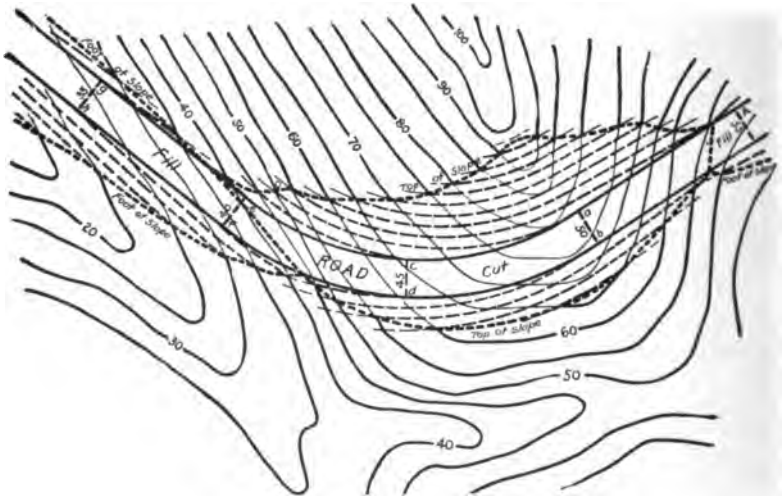

FIG. 131.

50 ft. contour at o , is a point at the top of the slope. Similarly all of the new contour lines, which are represented on the figure by dash lines are plotted and their intersections with the corresponding contours of the original surface give points of "no cut" or "no fill," or top of slope (in excavated portions) and foot of slope (in embankment portions). These lines are shown in the figure by heavy dotted lines. Where this heavy dotted line crosses the road it marks a "no cut" and "no fill" line, i.e., the road bed cuts the surface of the ground.

CHAPTER XI.

MINING SURVEYING.*

313. GENERAL REMARKS. — In this chapter the limitations and difficulties met with in surveying a mine will be pointed out and some of the instruments and methods generally used will be described. As rocky and precipitous mountain regions are more the home of metal mining than of any other industry, the special difficulties of surface surveying in such localities will also be considered. Lastly, the methods of establishing the boundaries of mining claims in United States territory will be briefly described.

Two of the principal objects to be accomplished in accurate mine surveying are the locating of the ownership boundaries underground and the laying out of passageways so as to connect with one another, thereby facilitating the working of the mine. Such passages are usually highly inclined and while under construction are called *connections*.

314. DEFINITIONS OF MINING TERMS. — The following terms are in common use in mining surveying.

Adit. A horizontal underground passageway running from the surface and used only for drainage and ventilation.

Ape. The trace of the intersection of the vein with the surface of the undisturbed rock formation.

Compartment. One of the smaller passageways of a large shaft, divided by timber partitions.

Connections. Passageways which are being driven from one accessible part of a mine to another.

Cross-cut. A horizontal passageway at right angles to or across the direction of the deposit.

* This chapter was written by Blamey Stevens, M. Sc., Mining Engineer, Ellamar, Alaska.

- Dip.* The inclination of the plane of the deposit to the horizon.
- Drift.* A horizontal passageway along, or parallel to, the trend of the deposit.
- Heading.* Any preliminary passageway driven to explore the mine or to facilitate future operations.
- Levels.* Horizontal passageways run at regular intervals (vertically) along the deposit for working the mine.
- Manhole.* A small passage from one level into the next level above or below, or into stopes.
- Mill-hole.* A passage between a stope and a level through which the ore is conveyed.
- Outcrop.* The portion of the vein where it intersects the surface of the ground.
- Pitch.* The direction of an ore body (called a chimney or chute) in an ore bearing body, sometimes expressed as an azimuth.
- Raise.* A passage leading upwards from any portion of the mine.
- Shaft.* A vertical or steeply inclined passage used in working the mine.
- Stopes.* Rooms excavated, within the walls of the deposit and above or below the levels, for exploiting the mines.
- Strike.* The direction (bearing) of a horizontal line in the plane of the deposit. The strike is always at right angles to the dip.
- Stull.* Timber running crosswise between the side walls of a passageway.
- Tunnel.* A horizontal passageway from the surface to the mine.
- Wall.* The boundary between a highly inclined vein and the rock each side of it. The upper wall is called the "hanging wall" and the lower one the "foot wall."
- Winze.* A subsidiary shaft not starting from the surface.

MINING INSTRUMENTS.

Owing to the confined nature and steep inclination of many of the passages through which survey lines have to be carried, specially constructed instruments are necessary.

315. MINING TRANSITS. — In modern mining, all the accurate angle measurements are taken with a transit, the details being filled in with a *miner's dial* or other light compass instrument. Several forms of transit are designed for mining and mountain work. The essentials are lightness and capability of measuring accurate azimuths of nearly vertical or of very short sights.

With an ordinary transit one cannot take a downward sight more steeply inclined than 55° or 60° to the horizon. For taking highly inclined sights various devices have been used by which telescopic sights may be taken over the edge of the horizontal circle of the instrument. This is commonly done by attaching an auxiliary telescope, usually smaller than the main telescope, to the side or to the top of the ordinary engineer's transit so that the instrument will afford all the advantages of the ordinary transit and also allow vertical sights to be taken.

316. SIDE TELESCOPE. — Fig. 132 shows a mining transit in which the auxiliary telescope is attached to an end extension of the horizontal axis. When this instrument is used the azimuths which are measured by means of the side telescope have to be corrected for the eccentricity of this telescope. A *striding level* is used to adjust the horizontal axis. This is a sensitive spirit level having two V-shaped bearings so that it can be set on top of the horizontal axis; it can be lifted and turned end for end.

317. TOP TELESCOPE. — In this type of mining transit the auxiliary telescope is mounted on top of the main telescope. Since this telescope is directly over the main telescope, azimuths measured with the auxiliary telescope will be the same as though they were measured by the use of the main telescope. But if vertical angles are measured by means of the top telescope it will be necessary to allow for the distance between the two telescopes.

318. Adjustments of Side Telescope. — It is assumed that all ordinary adjustments of the transit have been made; in

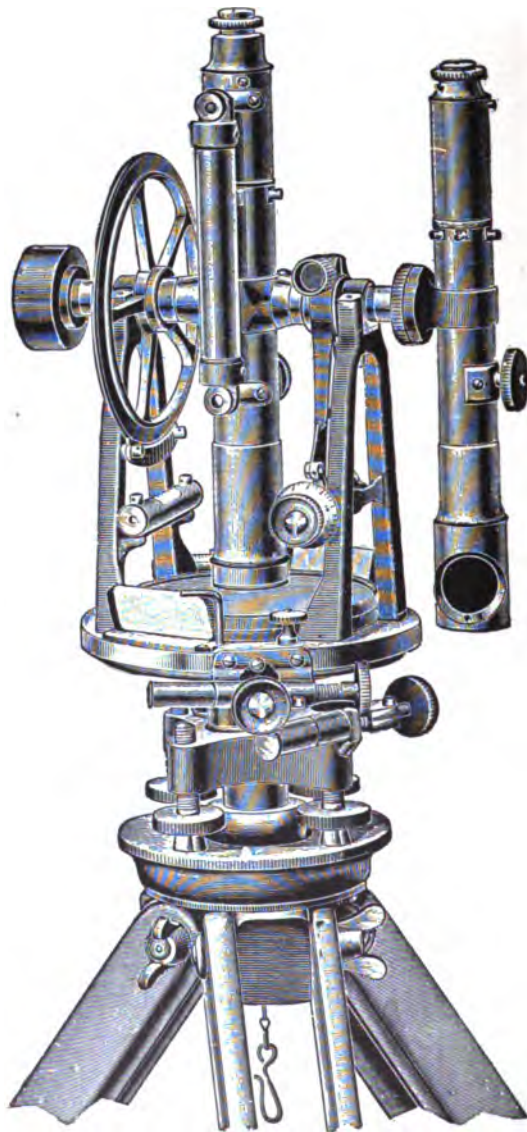

FIG. 132. MINING TRANSIT WITH SIDE TELESCOPE.

(From the catalogue of C. L. Berger & Sons, by permission.)

mining work the adjustment of the objective slide (Art. 77, p. 60) is of unusual importance. The side telescope is generally adjusted by first making the line of sight parallel to the axis of the telescope tube. This is done by the cross-hair adjustment and the aid of a pair of fixed wyes in which the tube is rotated; it is the same adjustment as for the level, Art. 121, p. 89. It is assumed that the instrument maker has made the optical axis parallel to the axis of the tube.

Secondly, the line of sight is made parallel to that of the main telescope. It is first brought into a vertical plane parallel to the vertical plane of the main telescope by means of the adjusting screws on the vertical trivet plate of the side telescope, the sight of each telescope being taken to the same very distant object. If it is not convenient to sight on a distant object, a piece of paper with two vertical marks connected by a horizontal line may be used, the distance between the marks being equal to the distance between the telescopes. This piece of paper should be set at right angles to the line of sight and not too near the instrument. The vertical cross-hair of the main telescope is sighted at one point by means of the clamp and tangent screw of the plates and then the vertical cross-hair of the side telescope is sighted at the other point by means of the trivet plate adjustment on the side telescope.

The side telescope and main telescope are then brought into the same plane at right angles to the vertical plane as follows: — the horizontal cross-hair of the main telescope is sighted at some point, preferably a distant one; then the horizontal cross-hair of the side telescope is sighted at the same point by means of the tangent screws on the side telescope.

With this form of attachment a correction for eccentricity of the side telescope is necessary in both azimuth and altitude readings. The necessity for correction in azimuth may be eliminated by using the instrument in both the direct and reversed positions; reversing brings the side telescope to the other side of the main telescope, thereby eliminating the errors of the line of sight. The striding level should be used in both of its positions, i.e., with the main telescope direct the striding level is used in both positions and two azimuths are read, and with the telescope

inverted the striding level is again used in both positions and two more azimuths are read. The mean of the two readings of each pair gives two mean lines of sight which are symmetrically related to the vertical plane passing through the two station points and the correct azimuth reading is therefore the mean of these two azimuths. There is a small correction to be applied to the mean of the altitude readings but this is not usually of any importance.

319. Adjustment of Top Telescope. — The top telescope is adjusted in much the same manner as the side telescope. No corrections have to be applied for single azimuths readings, if the instrument is in adjustment; but the altitude readings require a correction on account of eccentricity of the telescope. This form of instrument will not reverse so that errors cannot be eliminated in that way, and it is not so well adapted to the use of the striding level.

320. INTERCHANGEABLE SIDE AND TOP TELESCOPE. — Some instruments are made with an interchangeable telescope which can be attached at either the top or the side of the main telescope, according to whether horizontal or vertical angles are being measured. In such an instrument no correction for eccentricity of the auxiliary telescope is necessary, and it is arranged so as not to require readjustment when changed from side to top or *vice versa*.

321. ECCENTRIC BEARING TELESCOPE. — Another form of instrument (Fig. 133) known as the "eccentric bearing" transit, is regarded by many as the most accurate type. This instrument has an extra pair of supports for the horizontal axis of the telescope, which are so arranged that the axis can be displaced horizontally by a fixed amount along the course sighted. When the telescope is set in the eccentric supports vertical sights can be taken. A striding level is used to adjust the horizontal axis. With this instrument the foresight and backsight should both be taken with the horizontal axis in the same pair of bearings, as these two pairs of bearings are not so adjusted that the horizontal axis is exactly parallel in the two positions. All errors of adjustment may be eliminated by taking four readings, two with the horizontal axis in one position and two with it turned end for end in the eccentric supports, leveling up with the

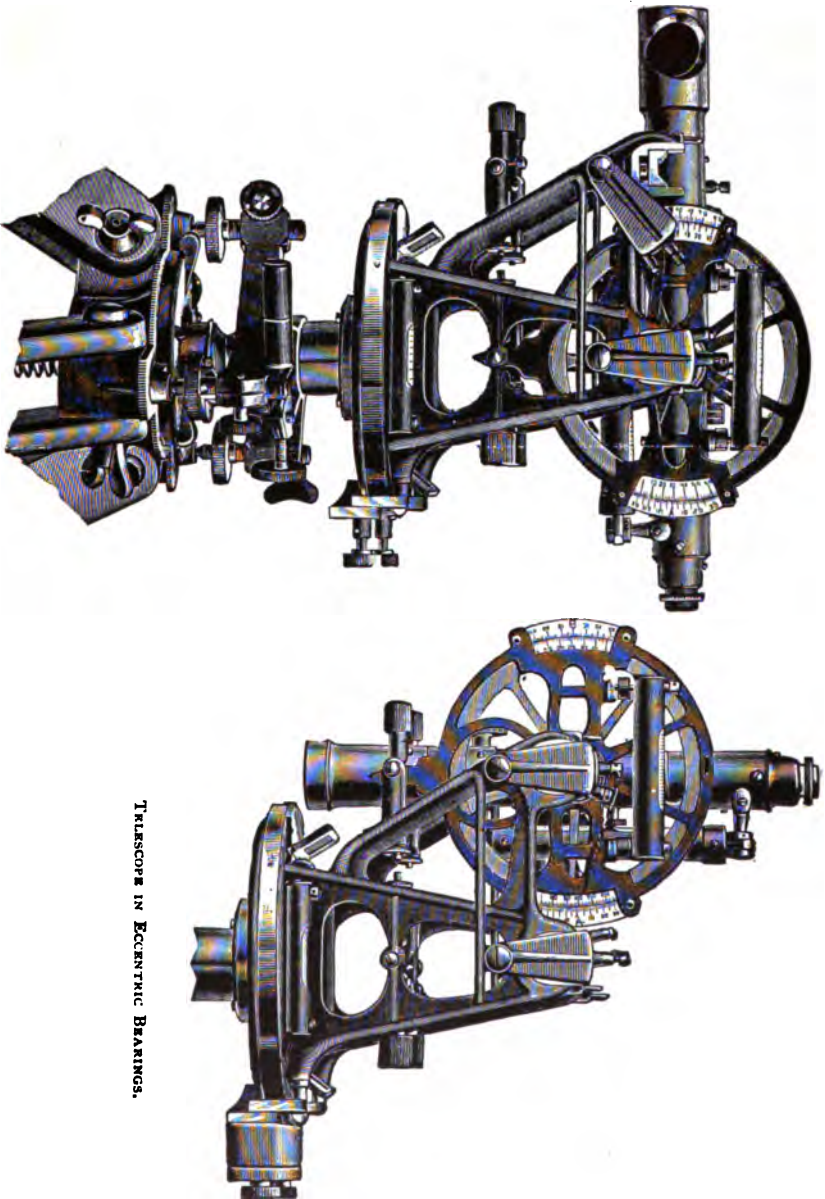

TELESCOPE IN ECCENTRIC BEARINGS.

FIG. 188. MINING TRANSIT WITH ECCENTRIC BEARING TELESCOPE.
(From the catalogue of C. I. Berger & Sons, by permission.)

striding level each time the sight is taken, the striding level being used in both its positions in each of the two positions of the horizontal axis.

322. COMBINED SOLAR ATTACHMENT AND TOP TELESCOPE.

— A special top telescope is sometimes made to do the duty of a solar attachment; but it is now generally admitted that better meridian determinations can be made by direct, single observations with the main telescope, and the surveyor is advised not to get any such complex attachment for mining work.

323. In comparing the relative merits of the various forms of attachment it must be remembered that the object to be accomplished is to transfer the meridian accurately from one station to another, these stations being close together in plan and distant in elevation. All other virtues of any attachment are of minor importance. Therefore, in addition to the ordinary adjustments of the transit, special care must be taken to get the horizontal axis of the telescope truly horizontal and the line of sight exactly perpendicular to it. A high power telescope is more necessary than for ordinary surveying, as a small variation of the line of sight means a large error in the azimuth.

324. USE OF THE ORDINARY TRANSIT IN MINING SURVEYING. — Where a special attachment is not to be obtained, or when the auxiliary telescope is too small for accurate work, the ordinary transit can be used in such a manner as to accomplish the same result as the eccentric bearing instrument (Art. 321). The instrument, firmly screwed on to the tripod, is inclined over the shaft at an angle just sufficient for the line of sight to clear the horizontal plate. It is then braced in position by such rigid supports as the circumstances afford, and the head of the instrument is rotated so that the horizontal axis of the telescope becomes truly horizontal, as determined by a striding level, while the telescope is sighting in the desired azimuth. One or more station points are then set out down the mine and one each way on the surface, all in the same azimuth, and these are respectively connected with the mine and surface surveys. All errors of adjustment may be eliminated by repeating sights with the telescope in the direct and the reversed positions and by re-

versing the striding level each time and taking the mean position of the four points so set.

An attachment which is very necessary in performing some of the work required of mining transits is the *reflecting* or *prismatic eyepiece*. This makes it possible to take any sight whatever above the horizon, and being a handy instrument to use and not requiring any adjustment, it should be carried by every mine surveyor.

325. COMPASSES USED IN MINES. — The transit has taken, to a great extent, the place of the old miner's dial in which the compass was the main feature. This is partly because, in modern mines, so much heavy machinery is used that the compass needle cannot be depended upon, even to its ordinary degree of accuracy.

Compasses, however, serve a useful purpose in general mining work. They are made in many sizes and of different design. A compass with a plain needle is to be preferred to one with a swinging card, since the former can be brought to a central position more quickly and is more accurate by reason of the lesser amount of weight on the center bearing. Compasses may be used for reconnaissance surveys and also for filling in the details of a mine from the main stations. A mining compass should be capable of sighting fairly high altitudes above or below the horizon, and a sighting clinometer* attachment for measuring vertical angles is very convenient as it obviates the use of any other instrument. A small modern mining dial mounted on a light tripod fulfills all these conditions. The *hanging compass and clinometer* is made so as to be hung from a wire stretched between two station points thus rendering sighting unnecessary, but it is not much used.

A mounted compass is more accurate than one simply held in the hand, but any hand compass may always be mounted when

* The Abney hand level and clinometer consists of a modification of the hand level described in Art. 100, p. 77. On top of the instrument is a level tube pivoted at the center of a graduated arc, and seen by reflection in a mirror placed inside the telescope tube. The instrument is pointed along the line whose inclination is desired and the level turned until the bubble is in its mid position, when the angle of inclination may be read on the graduated arc.

the conditions permit. Perhaps the best form of hand compass is one in which the observer looks down on the instrument and the line of sight is reflected upward towards him by a hinged mirror so that the object and the compass box are seen simultaneously.

Ore of a magnetic nature has often been discovered by local variations of the compass needle and by the dipping needle, a special self-plumbing form of which is made for the use of miners.

A combination compass, or clinometer of special form, is also useful in taking local strikes and dips of formation. One of the straight edges of the instrument is put against the ledge of rock and turned in contact with it until the level line is reached as shown by an attached spirit level. The instrument is then folded up or down about this edge as a hinge until the compass needle is horizontal and the strike is read. The dip is always at right angles to the strike, but it is not of great importance to set out this right angle accurately.

UNDERGROUND SURVEYING.

326. TRANSFERRING A MERIDIAN INTO A MINE BY USE OF THE TRANSIT. — Only a moment's thought will convince the student that some difficulty must be experienced in accurately transferring the meridian to the bottom of a narrow shaft several hundred feet in depth. The ordinary method of transferring a meridian into a mine is to set up the transit at a station fixed at the mouth of the shaft and, after taking a backsight on the previous station on the surface, to take a foresight down the shaft, the line of sight being made as much inclined to the vertical as possible. Having ascertained the intervening distance, the transit is set up at the bottom station, a backsight taken on the top station, and the survey then carried into the galleries of the mine. The top and bottom stations are not always the surface and bottom of the shaft, although for simplicity, they may be referred to as such in this chapter.

In sighting from both ends of the same highly inclined line it will be found that errors due to the line of sight not being per-

pendicular to the horizontal axis are eliminated if the readings are made with the telescope in the same position at both sights, whereas errors due to inclination of the horizontal axis are eliminated if the readings are made with the telescope direct when at the top and reversed when at the bottom of the shaft, or *vice versa*.

When it is impossible to sight up a shaft on account of its being too wet, two or more points can be set in line at the bottom of the shaft by means of the instrument when at the top, and these will determine a line of known azimuth at the bottom of the shaft.

In some cases a wire is stretched horizontally across the bottom of the shaft and as far back into the workings as possible, the wire being carefully aligned by the instrument at the top. This method may admit of even more accuracy than that of taking a backsight to the surface from a station established on the bottom of the mine. Errors due to a slight inclination of the horizontal axis are not important when this method is used and for that reason it is also useful in cases where a sensitive striding level is not to be had. The effect of a slight inclination of the horizontal axis is simply to shift the line slightly to one side but parallel to the true position.

When no extra telescope or eccentric bearings are to be had, an ordinary transit with a prismatic eyepiece attached may be used to drop the meridian down a vertical or highly inclined shaft, provided it is not so wet as to prevent sighting upward from below. To accomplish this a thin wire is stretched horizontally across the top of the shaft at a known azimuth; the wire should be prolonged one or both ways in order to give a good base-line. Two points may be fixed at the top of the shaft if preferred. The transit is then set up on the bottom and it is brought by trial into the same vertical plane as the wire. The striding level is used in both positions and the transit is used in both the direct and reversed positions to eliminate errors.

It is to be noted that in mining and mountain work slight errors occur in sighting up steep inclines owing to the refraction of the atmosphere, but this is so slight that it does not affect the transfer of the meridian and is never taken account of.

327. PLUMBING THE MERIDIAN DOWN A SHAFT. — To the mine surveyor the plumb-line is an instrument of precision, excelling even the transit, and under most conditions, the work of transferring the meridian down a mine can be accomplished more accurately by means of the plumb-line than by any other method accessible to the surveyor.

The method usually followed is to suspend two bobs from the staging above the mine so that a horizontal line in their plane can be sighted both from above and from below. The transit is set up both above and below on this line and thus an azimuth connection is established between the surface and the workings. Sometimes a much longer base-line than can be directly sighted can be obtained by plumbing down at the corners of a shaft as shown in Fig. 134. Points *A* and *B* have been plumbed down

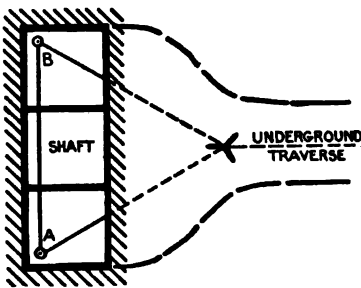

FIG. 134. TRIANGULATING AT THE BOTTOM OF SHAFT.

and, by the triangulation method there indicated, a connection with the underground traverse can be established. In this triangle the angles should be chosen so as to give good intersections.

All kinds of drafts in the shaft should be avoided during the alignment at the bottom. No cages or skips should be run and the passages leading to the shaft may have to be damped with sheets of canvas. No lateral streams of water should impinge on the plumb-lines; in fact it is desirable that no water at all should drop in their vicinity.

The best plumb-line for this work is one made of wire. Annealed copper wire is most flexible, but soft steel or piano wire being thinner will be less affected by drafts and will also stretch less. The plumb-bob should not weigh less than five pounds and should be heavier for a deep shaft. A good working weight is one-third of the load at which the wire will break.

The plumb-bob is hung in a bucket or a barrel of viscous liquid so as to bring it to a standstill in the shortest possible time. The shape of the plumb-bob is of importance in this respect

and the form shown in Fig. 135 is a good one, since it prevents rotary as well as lateral oscillations. It should hang near the top of the vessel as the wire will be in a high state of tension and will stretch considerably. A mark should also be made on the wire showing how far the bob is above the bottom of the vessel.

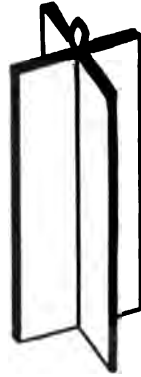

FIG. 135. TYPE OF PLUMB-BOB USED IN PLUMBING MERIDIAN DOWN A SHAFT.

The liquid must be a true one (not a mud or slime) and it must be neither too limpid nor too viscous; for in the former case it will not stop the oscillations within a reasonable period, and in the latter the bob may not reach the central position quickly enough. The amplitude of the vibrations of the plumb-bob decreases in a fixed ratio with equal increments of time, and the viscosity of the fluid should be such as to make each oscillation, say, about one-quarter of the preceding. The ratio of decrease during equal increments of time is independent of the length of the plumb-line and of the amplitude of the oscillations if the resistance is purely viscous. This law makes it possible to select the fluid above ground, with the aid of a short length of wire attached to the bob; it applies only when the bob swings through a very small arc so that the resistance is wholly viscous. It may be noted that the period of oscillation varies approximately as the square root of the length of the plumb-line, the same as for a pendulum swinging in air.

If the shaft is wet the vessel should be covered with a sloping lid having a hole in it of an inch or so in diameter so that the wire can swing freely. In order to obtain as long a base-line as possible the wire should be hung as near to the casing of the shaft as is consistent with the precaution that it shall be perfectly plumb. It should be carefully examined along all its length to make sure that there are no obstacles to interfere with it. In some cases it may be sufficient to pass a lighted candle around the wire at the bottom and observe any obstacles by sighting from the top. The distance between the wires at the bottom and top of the shaft should always be measured and compared,

as this gives the best test of the accuracy of the plumbing operation. If four lines one in each corner of the shaft are hung instead of two an accurate check or measure of the errors is possible.

When once the plumb-lines are hung the meridian may be transferred to all the levels of the mine once and for all time, so that a little extra precaution and time given to this operation are worth while. The surveyor should always keep in mind the fact that in plumbing the meridian down the mine the direction of the meridian is of much more importance than the actual position of the points themselves, because an error due to an incorrect direction of the meridian may be multiplied many hundreds of times in carrying the traverse through the mine (Art. 348, p. 316).

328. TRANSFERRING A MERIDIAN INTO A MINE WHEN THERE ARE TWO SHAFTS. — The above methods presuppose that the mine has so far been opened only by one shaft. If there is a second shaft or an adit, it is, of course, only necessary to plumb or otherwise transfer the position down each shaft; the computed distance between these points then becomes a base-line of substantial length. In Fig. 136 the traverse $A B C D$ is run

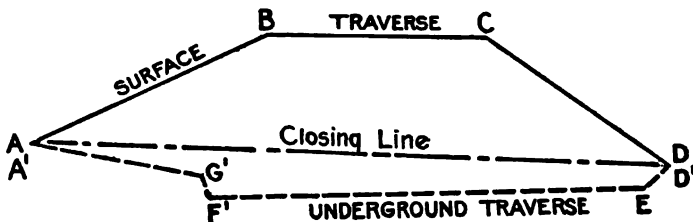

PLAN

FIG. 136.

out on the surface to connect the two shafts at A and D . The points A and D are plumbed down the shafts and the corresponding points A' and D' established at the bottom. An underground traverse $A'G'F'E'D'$ is then run out. In the surface traverse the length and azimuth of AD and in the underground traverse the length and azimuth of $A'D'$ are missing. The horizontal

length and azimuth of each of these lines can be determined from their respective traverses as explained in Art. 397, p. 366. The surface traverse is referred to the true meridian, and, since nothing is yet known in regard to the direction of the meridian in the mine, the underground traverse is referred to an assumed meridian. The true azimuth of $A'D'$ is the same as the azimuth of AD , provided the plumbing down the shaft has been accurately done. The difference between the true and assumed azimuths of $A'D'$ is a correction to be applied to the azimuths of all of the lines of this underground traverse.

329. UNDERGROUND TRAVERSES. — Surveying in a mine is necessarily a process of traversing, for only the working passages are available for lines of survey. The line of traverse is not always in the center of the passage but is often varied from it in order that the longest possible sight may be taken. In the tortuous passages of a mine it is frequently necessary to take very short sights on the main traverse and since the azimuth is transferred to distant connections through these short lines great care should be exercised. The positions of the walls of the passages are noted as the work proceeds and are sketched in approximately on the plot. After the main traverses have been run, the surface boundaries, if touched, may be accurately established and the stopes and working places surveyed by more convenient and less accurate methods, from the stations already established.

It is often very convenient in underground work to take the azimuth from an estimated general direction (or strike) of the vein; for the direction of the meridian is of no importance in the actual working of a mine, while the direction of most of the passages will usually vary only a few degrees from the strike, and thus all traverse calculations are simplified.

A speedy and convenient manner of running an underground traverse is to use three tripods having leveling heads and centering plates like those of the transit. The transit fits on to any of these heads and while it is attached to one of them the other two are surmounted by *lamp targets* in which the sighting center has exactly the same position as the sighting center of the transit would have if set on the same tripod. These tripods are placed vertically over or under the stations and the transit is attached to

the middle one. When the transit head is moved from the middle to the foremost tripod a target takes its former place and the hindmost tripod is brought ahead of the transit and set up on the new forward station. The lamp behind the plumb-target or plumb-line should give a diffused illumination of considerable area so that it may be easily found with the telescope and so that it may render the cross-hairs of the telescope plainly visible. In cases where the illumination of the object is such that the hairs cannot be distinguished, a light is thrown obliquely into the telescope tube in front of the hairs, preferably by a tube reflector (Fig. 133) in front of the object glass.

Sometimes a brass lamp with a small central flame, called a *plummet-lamp*, is suspended in place of a plumb-line and the flame is sighted at, but this is too small a target for quick work and the surveyor may also mistake other lights, such as miner's lamps or candles, for it when sighting through the telescope.

330. Establishing Station Points. — The station point is established either on the floor or the roof, according to the character and condition of the mine: the chief object sought is permanence of position rather than convenience in getting at the point for future use, which is of secondary importance. In a vein mine a timber in the roof, especially a stull, is often more permanent than the floor or rock roof, but any timber is likely to be moved by the miners. The hanging wall is a good place for the station, but if the inclination is small, as in a coal vein, the foot wall or floor is best.

To establish a station, get a miner to make a drill hole about six inches deep, more or less, according to the hardness of the rock. Cut a wooden plug to fit this hole tightly when hammered in dry, and do not let any more of the plug project than is necessary. Small screw eyes make good roof station points from which to suspend the plumb-line, but where the lines are short a finishing nail bent to a sharp angle is better as the plumb-line will then always hang in exactly the same position. For measuring between stations a hundred-foot steel ribbon tape, divided to hundredths of a foot is used; but for long straight tunnels and shaft work, a longer steel wire tape is more convenient.

SURVEY OF BEAR CREEK MINE, WEST BOULDER, MONTANA.

Sta.	Bearing.	Distance.	Vert. Angle.	Back-sight on	May 17, 1906. Party: Keene, Chase, Holbrook.
o	N 88°10' E	650.8	- 1°17'	Sun	To top of air shaft extending to 1st level; C. of S. edge of air shaft, 4' x 4'. Sta. 2.
o	N 2°10' W	117.4	-80°10'	Sun	To Sta. 101 at 1st level. Line runs 3' from S. side and 4.5' from W. side of shaft; shaft 8' x 8'.
101	N 87°45' E	230.8	+ 0°45'	o	To Sta. 102 in 1st level.
101	N 2°10' W	112.6	- 80°10'	o	To Sta. 201 in 2nd level.
102	N 89°10' E	75.0	+ 0°53'	101	To top of center of raise extending to 2nd level, raise 4' x 4'. Sta. 107.
102	N 89°10' E	153.5	+ 0°53'	101	To Sta. 103 in 1st level.
103	S 89°15' E	105.7	+ 0°39'	102	To Sta. 104 in 1st level.
104	S 88°12' E	162.1	+ 0°48'	103	To Sta. 105 at foot of S. side of air shaft extending to surface.
105	S 9°55' W	92.3	+88°25'	104	To top of air shaft, Sta. 2.
105	S 88°12' E	15.9	level	Compass	To Sta. 106 at breast of 1st level.
201	N 2°10' W	115.8	- 80°10'	101	To Sta. 301 in 3rd level.
201	N 85°52' E	167.4	+ 0°50'	101	To Sta. 202 in 2nd level.
201	S 85°46' W	196.0	+ 0°47'	101	To Sta. 205 in 2nd level.
202	N 88°20' E	138.0	+ 0°44'	201	To C. of raise extending to 1st and 3rd levels, 4' x 4' Sta. 208.
202	N 88°20' E	106.3	+ 0°44'	201	To Sta. 203 in 2nd level.
203	S 89°05' E	176.9	+ 0°42'	202	To Sta. 204 at breast of 2nd level.
208	S 3°14' E	113.7	+77°19'	202	To Sta. 107.
205	S 86°10' W	216.8	+ 0°48'	201	To Sta. 206 in 2nd level.

SURVEY OF BEAR CREEK MINE, WEST BOULDER, MONTANA. (Cont'd.)

Sta.	Bearing.	Distance.	Vert. Angle.	Back-sight on	
206	S 87°14' W	118.0	+ 0°41'	205	To top center of winze extending to 3rd level, 4' × 4'. Sta. 209.
206	S 87°14' W	152.0	+ 0°41'	205	To Sta. 207 at breast of 2nd level.
301	N 86°20' E	304.0	+ 0°46'	201	To Sta. 302 at C. of raise extending to 2nd and 4th levels, 4' × 4'.
301	N 86°20' E	316.0	+ 0°46'	201	To Sta. 303 in 3rd level.
301	S 86°40' W	195.0	+ 0°50'	201	To Sta. 305 in 3rd level.
301	N 2°10' W	116.8	- 80°10'	201	To Sta. 401 at 4th level.
302	S 5°35' E	116.5	+ 78°29'	301	To Sta. 208.
303	S 89°07' E	289.0	+ 0°39'	301	To Sta. 304 at breast of 3rd level.
305	S 88°52' W	186.2	+ 0°46'	301	To Sta. 306 in 3rd level.
306	S 89°48' W	150.0	+ 0°43'	305	To Sta. 307 at C. of bottom of winze extending to 2nd level, 4' × 4'.
307	S 2°41' E	120.5	+ 71°11'	306	To Sta. 209.
307	S 89°48' W	10.9	level	Compass	To Sta. 308 at breast of 3rd level.
401	N 85°48' E	219.7	+ 0°48'	301	To Sta. 402 in 4th level.
401	S 88°10' W	116.4	+ 0°52'	301	To Sta. 406 at breast of 4th level.
401	N 2°10' W	49.7	- 88°10'	301	To bottom of shaft, 3' from S. side and 4' from E. side. Shaft 8' × 8'.
402	N 89°56' E	85.0	+ 0°45'	401	To Sta. 403 to C. of raise extending to 3rd level, 4' × 4'.
402	N 89°56' E	92.6	+ 0°45'	401	To Sta. 404 in 4th level.
403	S 0°06' E	116.2	+ 81°46'	402	To Sta. 302.
404	S 87°20' E	217.6	+ 0°43'	402	To Sta. 405 at breast of 4th level.

MAP OF
BEAR CREEK MINE
WEST BOWLDER, MONT.

Scale, 1 in. = 50 ft.
Scale of Reduced Plate,
1 in. = 150 ft.

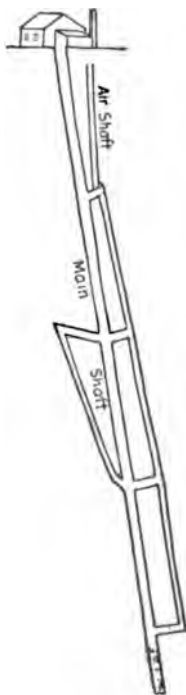

TRANSVERSE SECTION
LOOKING WEST

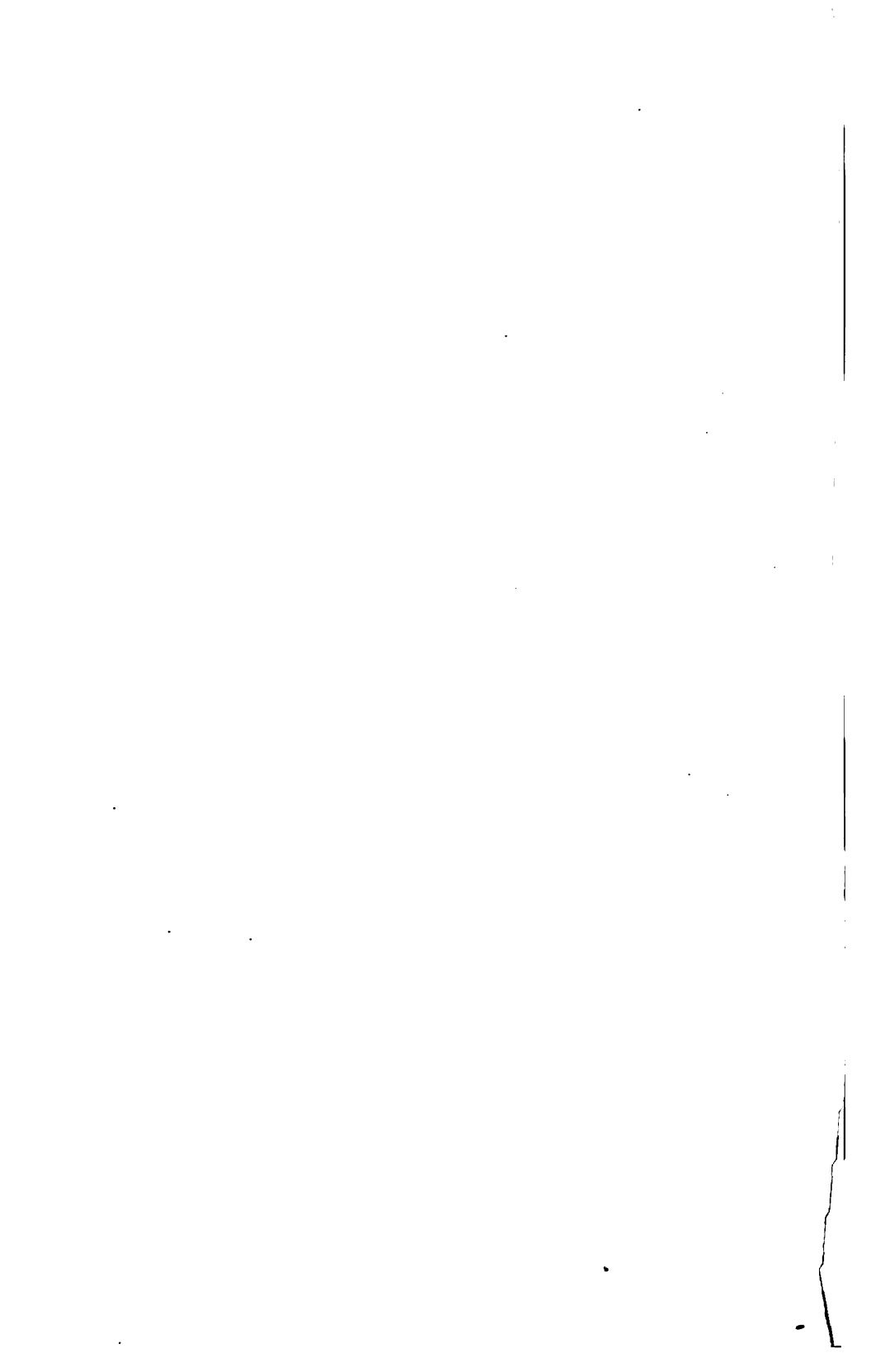

331. Notes of a Mine Traverse. — As a rule the notes of mine surveys are kept in the form of sketches, especially the details, such as the location and extent of the stopes. These details are plotted on to the skeleton survey which is simply a traverse, the notes for which may be kept in the following form.

The different station points of this survey are numbered for identification only, their numbers bearing no relation to the distances between them. For convenience the stations on the first level are numbered 101, 102, etc.; on the second level 201, 202, and so on. In larger and more complex mines the system of numbering and lettering stations is carried out still farther.

332. Plotting a Mine Traverse. — This survey can be plotted by computing three sets of coördinates which give all the data needed for showing the mine in plan, longitudinal section, and transverse section. If the three coördinate planes are the meridian plane, the east and west plane, and the horizontal plane, then the vertical and horizontal distances from each slope measurement are first obtained by multiplying the measured distance by the sine and the cosine respectively of their vertical angles. The vertical distance is the difference in elevation between the two points. From the horizontal projection and the azimuth, or bearing, the latitude and departure of the course can be computed as usual (Art. 384, p. 352). A plot of these notes will be seen in Fig. 137.

It is assumed in plotting these notes that all the transit lines in the galleries run 2 ft. below the roof and in the center of the galleries, which are 6 ft. high and 4 ft. wide; conditions which are more uniform than would occur in actual practice. The measurements which locate the walls of the galleries have been purposely omitted from the foregoing notes for the sake of simplicity.

If it is desired to substitute for the meridian plane a vertical plane through the strike and for the east and west plane one which is at right angles to the strike, then all of the true bearings or azimuths must be corrected by an amount equal to the strike. After these bearings have been corrected the three coördinates are calculated in the same way as described above. The ad-

vantage of this latter method is that the levels are shown in their full length in the longitudinal section and the shaft is shown in its true length in the transverse section.

333. UNDERGROUND LEVELING. — The drainage of a mine is usually toward the shaft (Fig. 137), and the grade of the levels is such as will make the tractive force of a full car going towards the shaft equal to the pull required to move an empty car in the opposite direction. When connections, other than vertical ones, have to be made the grades must be taken into consideration. In this work an ordinary surveyor's level is generally used in conjunction with a short leveling rod about five or six feet high.

334. MINE MAPS AND CHARTS. — The galleries of a mine are often so nearly over one another that confusion is liable to arise in charting, unless some special means of identifying them is employed. As these galleries or working passages appertain to definite levels or strata, a different color may be assigned to each level or strata and adhered to throughout. The lines of survey are in a colored ink and the passages or workings are of a fainter tint of the same color. These colors can also be adhered to on the elevations, of which there are usually two, one along the strike and the other at right angles to it. (See Fig. 137.)

Some surveyors use large scale plots and simply mark the position of the stations on them so that when a course has to be set out its distance and direction can be scaled directly from the map.

Another method is to use a small scale map and mark on it, in figures, the exact coördinates of every station point. The origin, or point of reference, is usually the plumb-line of the shaft, and the two vertical planes of reference may conveniently be taken through the estimated general strike and dip of the vein. The true course of the survey lines may also be marked and all the exact data can be clearly kept in a minimum space.

The progress of work in the stopes or rooms of the mine is generally represented on different plans from those used to show the main headings. These working plots may be either vertical, horizontal, or parallel to the vein or seam. In any case, the thickness of the deposit is recorded at frequent intervals together

with other particulars, such as thickness of waste or value of ore. These thicknesses are all measured at right angles to the plane of the working plan, so that when multiplied by the area on the plot, the cubic capacity of any section is obtained. Where the ore occurs in irregular masses, not conforming particularly to any one plane, the above system does not apply and some other method must be devised by the surveyor.

The best way of estimating amounts not mined is to sketch their probable extent on such a chart from the data available and to make use of the area and thickness method as suggested in the preceding paragraph. Ground explored by bore-holes but not opened by headings may be best shown by plotting in plan the positions of both of the walls, where struck in the bore-holes, marking the elevations in figures on the plan. Contours may then be sketched in colors, and a very good idea of the shape and trend of the ore body obtained, and the quantities of ore may also be calculated therefrom. (See Computation of Volume, Chapter XII.)

335. LAYING OUT MINING WORK. — Drifts or cross-cuts are laid out by putting in two nails or hooks in the roof, not too near together, from which the miner can hang two plumb-lines and sight the center of the heading he is to run.

Vertical shafts are carefully plumbed on the inside of the frames, and frame by frame, as these are put in. It is best to hang the plumb-line from several frames above the bottom one, as these upper ones are more likely to have ceased to move. Hang the line an even fraction of an inch each way from the true position of the corners and note any accidental variation in the last frame set, so that in future work, if it is desired to hang the plumb-line from this frame, its error of position can be allowed for. The dimensions of a shaft or drift are given either "in the clear," meaning net measurements inside all timbers, or "over all" meaning gross measurement outside all timber and lagging.

336. UNDERGROUND SURVEYING PROBLEMS. — In the practice of mine surveying, problems are constantly arising which tax the ability and ingenuity of the surveyor, although the actual

solution of most of them is quite simple. A few of the common problems met with in such work are given below.

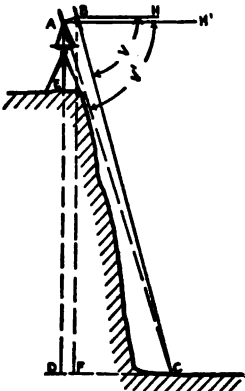

FIG. 138.

then $V' = V - ACB$.

$$\text{But } \sin ACB = \frac{AB}{AC} = \frac{\text{Distance between telescopes}}{\text{Distance measured}}$$

$$AD = AC \sin V',$$

$$\text{and } DC = AC \cos V'.$$

The height of instrument above the datum being known the elevation of C can be readily calculated.

Had the distance BC been measured instead of AC then $DC = CF + FD = BC \cos V + AB \sin V$.

Similarly $AD = BC \sin V - AB \cos V$.

338. Vertical Angle Correction for Eccentric Bearing Telescope. — In Fig. 139, A is the central bearing for the telescope and B is the eccentric bearing in which the telescope rested when the vertical angle V and the distance BC were measured.

$$DC = FC + AB = BC \cos V + AB$$

$$AD = BF = BC \sin V.$$

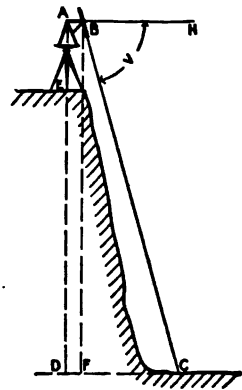
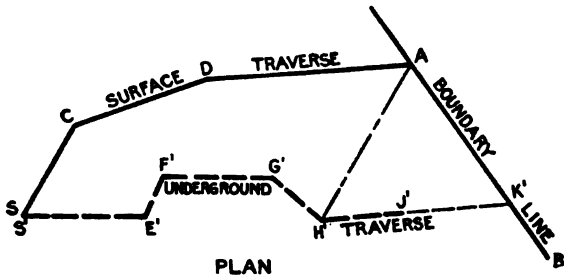

FIG. 139.

339. To Establish a Boundary Line of the Claim Underground. — In Fig. 140 points *A* and *B* are on the boundary of the claim.



PLAN

FIG. 140.

The shaft is located at *S*, and it is desired to prolong the underground working in the drift *H'J'* to a point *K'* vertically under the boundary line. The surface traverse *BADCS* is run out, point *S* is plumbed down to *S'*, and the meridian transferred into the mine. Then the underground traverse *S'E'F'G'H'J'* is run out. The horizontal projections of all the measured lines on both traverses are computed (or measured), and the length of the level line *AH'* and its bearing can be calculated as described in Art. 398, p. 367. In the horizontal triangle *AH'K'*, *AH'* and all the angles being known, the line *H'K'* can readily be computed. If the drift *H'J* is not level the distance from *H'* along the drift to the boundary plane will be equal to the horizontal distance *H'K'* divided by the cosine of the vertical angle.

340. To Lay Out a Connection in a Mine. — Here the problem is to determine the bearing (or azimuth) and the vertical angle and the distance to run from point *A* in a mine to point *B* in another portion of the mine. A traverse can be run from *A* to *B* through the passages already cut in the mine, and all the distances reduced to horizontal distances which, together with the azimuths, form a traverse in which the length of the closing line *AB* (horizontal projection) and its azimuth are missing. These can easily be computed by the method explained in Art. 398, p. 367. The difference in elevation between the actual points

A and *B* together with the length of the horizontal projection of *AB* will give the vertical angle; from these data the direct distance between the points *A* and *B* can be computed.

341. HYDRAULIC SURVEYING FOR MINES. — The miner's unit for measuring water is the *miner's inch*. By an inch of water was originally meant such continuous flow as will go through a one inch square hole, the head of water behind it being usually six to nine inches. This very loose definition has been done away with but the name still applies, being defined more exactly as ninety cubic feet of water per hour ($1\frac{1}{2}$ cubic feet per minute). In spite of all criticism, the miner's inch has become by custom the standard unit for the flow of water in most mining districts. It no doubt retains its hold on the practical mind because no good definite time or capacity units are in general use, seconds, minutes, hours, and days, or gallons and cubic feet with their clumsy relations to one another, being used according to the whim of the individual. To get an idea of the magnitude of a standard miner's inch, it may be remembered that it is equivalent to a stream one inch square running at a uniform rate of 3.6 feet per second. This is about a medium speed for small mountain streams; and, with a little practice, the flow of such a stream in miner's inches may be calculated mentally, after rough measurements have been made of the cross-section of the stream and the speed of flow of the water at the surface. The accuracy of this process is within the ordinary limits of fluctuation of the stream from day to day. If the flow has to be recorded over a long period it is well to put in a *weir*.

For estimating the flow of larger and more important mountain streams, a portion of the stream where the width and flow are comparatively uniform may be chosen and the length of this portion measured and marked by flags. A cross-section of the bottom of the stream is obtained at each flag and at intermediate points if necessary by measuring the depth at equal intervals across the stream; from these a mean cross-section is obtained. Floats are started at intervals across the stream opposite the up-stream flag, and timed with a stop watch while running to the down-stream flag; the speed of each float represents the velocity of the stream in its respective longitudinal strip. Each velocity

is multiplied by the area of the corresponding portion of the cross-section of the stream, and from the total flow so computed a certain percentage is deducted for the excess of surface over mean flow; this, for ordinary mountain streams, is approximately twice the percentage of the grade of the channel.

The surveying and staking out of mining ditches, flumes, and pipe lines follow the general practice for this work in other fields of engineering.

342. Testing for Ore by Electric Currents. — Methods of testing the earth for ores by means of electrical currents and waves are being experimented upon, and the working out, recording, and plotting of the results are likely to become a part of the mine surveyor's work.

SURFACE SURVEYING.

343. SURFACE SURVEYING IN RUGGED MOUNTAIN REGIONS.

— In accurate work, such as the surveying of mining claims for patent,* the ordinary mining transit may be used. Measurements are made with a steel wire tape, 300 to 500 feet long and marked every 10 feet (or 20 feet) so as to be used with a short auxiliary steel ribbon tape which is divided to hundredths of a foot. The measurements are taken from the center of the instrument to the object at which it is pointed, care being taken not to overstretch the tape nor to kink it. The most accurate work is done by stretching the tape with a tension handle (a spring balance) which can be attached by a clamp to any part of the tape. Where it is feasible, just enough tension is given so that the stretch of the tape compensates for the shortage due to sag. In many cases assistants will have to hold the middle point or the points at one-third and two-thirds the length of the tape up to the line of sight, giving at the same time enough pull to make the sag equal in the different sections of the tape.

There are several systems of traversing. The most common is to measure the height of the center of the instrument above the

* By patent proceedings is meant the proceedings necessary to obtain from the government a fee simple deed to the mining claim.

station point, and then to sight an equal height on a graduated staff held on the back and forward stations, recording the azimuth, vertical angle, and distance. Another method is to sight and measure to targets set at a fixed height above the stations, recording the vertical angle only at alternate stations. If the vertical angles are read at every station there will be two sets of vertical angle and distance measurements. The three tripod method may also be used as described for underground work; and lastly two transits and instrument men may be employed, each sighting to the other's telescope and measuring the distances between them. Each of these methods has its advantages and disadvantages, and the best one to use depends upon the conditions of the work to be done. In some cases there will be twice as many altitudes and in some cases twice as many distance readings as are actually needed, but these extra readings may be used as a check available in the field.

In making general maps of a mining district, only monuments and important locations need be accurately shown. This accurate work which is the first to be done forms a skeleton on which to make a general map. The topography can be filled in by a transit fitted with fixed stadia wires and a compass.

The best topographical data in mountainous country are obtained by running traverses along the ridges and valleys; these are also usually the best places to travel. Much sketching is necessary and the work should be plotted by the surveyor himself each day as the work proceeds. In this work a rough determination of the topography is sufficient, since the plans are usually plotted to the scale of $\frac{1}{10000}$ or smaller, and therefore such instruments as the hand compass, clinometer, and aneroid barometer can be used. With such instruments one man can do the entire work. The plane table cannot be used to advantage in mountain or mine surveying, but photographic surveying may often prove useful in filling in details of topography.

344. MINE BOUNDARIES.—APPROPRIATIONS UNDER UNITED STATES LAWS.*—In most countries mineral rights are defined

* For further information with regard to this subject see the Manual of Instructions for the Survey of the Mineral Land of the United States, issued in 1895 by the Commissioner of the General Land Office, Washington, D. C.

by vertical planes through lines marked out on the surface. Title to metalliferous lands, however, as granted by the United States, conveys the right to all minerals included in the downward prolongation of the portions of veins cut off by the vertical end bounding planes, i.e., a vein can be worked in the dip indefinitely, but in the direction of the strike it is limited by the end bounding planes of the claim. This law has given rise to much litigation and there are still many unsettled points involved.

The Federal law allows a claim to cover 1500 feet located along the direction of a vein and 300 feet of surface ground on each side of it. These dimensions which constitute the maximum can be reduced by local laws. The ordinary method of locating a claim is shown in Fig. 141. The discovery being

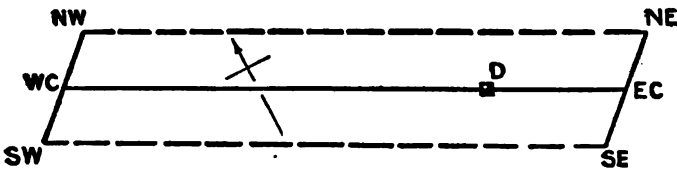

FIG. 141. PLAN OF LODGE CLAIM.

made at *D* the center line *WC-D-EC* is run and then the end lines *SE-NE* and *SW-NW* are put in, being made parallel with each other and straight. The side lines must not be over 300 feet apart, measured at right angles from the center line.

A monument with explanations is placed at each of the seven points marked. If in a timbered country, the lines run should be blazed, and squared trees may be used as monuments. At *D* (Fig. 141) a location notice is posted, defining the boundaries of the claim and containing such explanation as would identify the claims in case of dispute. The miner usually makes the location survey himself, using approximate courses and distances. There is legally no objection to this work being done roughly, but when a patent survey comes to be made, neither the dimensions specified in the location notice nor the limits of the claim as marked off on the ground can be exceeded. So when the location survey is roughly made certain "fractions" of ground

are not included, and these may cause much trouble, especially when "groups" of claims are located.

In such preliminary surveying, traverses may be run along courses where the sights can be conveniently taken and the azimuth taken from the direction of the vein; this may save much time and considerably simplify the work, (specially in thickly timbered regions (Art. 329, p. 299). In the description it is sufficient to state the approximate compass bearings of the boundaries. The center line and side lines need not be straight or parallel, but are assumed to be so unless marked with additional monuments. If, on account of the crookedness of the vein, it is advisable to make the center line of the claim a series of straight lines (like a traverse), this can be done, but the above conditions must be fulfilled with regard to the length and breadth of the claim and the two end lines must be parallel. In order to guard against troublesome litigation, an effort is sometimes made to surround a valuable claim with others, thus forming a "group." The more valuable claim is then protected as regards all "extralateral rights."

Flat deposits, such as coal and placer, are subject only to vertical bounding planes, and, provided the boundaries are marked plainly on the ground and the legal dimensions are not exceeded, no difficulty need be encountered. The Federal law allows 20 acres to be taken for a placer claim but fixes no limits in regard to breadth or length. Local laws can regulate the size, provided the 20 acre limit per claim is not exceeded. The coal lands law is made subject to the general system of public land surveys for agricultural lands.

345. SURVEYING FOR PATENT. — The surveying of claims for patent from the United States Government can only be obtained by those who have received appointment of United States Deputy Mineral Surveyor and they must have an order from the Surveyor General of the state or territory in which the claims are located before making any such survey.

In surveying for patent, much more accurate work has to be done than when merely locating a claim. After the shape of the claim as originally staked has been determined, the positions of the new corners and other boundary marks are computed and

laid out on the ground. The original claim cannot anywhere be exceeded and usually has to be cut down so as to make the end lines parallel and bring the dimensions of the claim within statutory limits. All this must be done accurately, the limit of error allowed being one in two thousand. Besides the marking of the boundaries on the ground, the position of at least one of the corners of each claim must be determined with reference to permanent monuments recognized by the government. The true meridian must also be determined by observations of the sun and all courses must be referred to it. The position of all buildings and surface improvement must be found and shown on the plot, and also the position of all corners of other claims for which a patent has already been applied. The surveyor must also make an estimate of the value of and describe all improvements, such as tunnels, shafts, open-cuts and other mining work done on the ground, and these should amount to not less than \$500.00 worth per claim. The Manual of Instructions describes in detail the character of the corners required to be established, and a great many other details which must be known to the Deputy Mineral Surveyor before his survey will be accepted, and defines the penalties attached to poor or dishonest work. Patented claims may overlap, and in fact do, in all mining districts, but in making application for patents to claims which lap on ground previously patented, the exact rights desired on the area of intersection must be defined.

Placer claims may be taken in twenty acre tracts, the bounding lines of which must conform with the general system of survey lines established by the Government, but if such survey has not been extended to the district, they must be bounded by true meridian and east and west lines. The survey of coal land is subject to somewhat similar rules.

346. THE SURVEYING OF BOREHOLES. — Boreholes, whether made by a rotary or a percussion drill, are never perfectly straight and unless the ground is remarkably homogeneous, are not amenable to any mathematical law. Means have been devised, however, of measuring the strike and dip of a hole at any particular distance from its mouth. The trend of the borehole can thus be plotted with some degree of approxi-

mation and the position of any particular body or strata struck in the borehole determined. One method depends in principle upon the conversion from liquid into jelly, by cooling, of a solution of gelatin, contained in a small vessel together with a compass needle and a plumb-bob and of such a shape as to align itself with any part of the hole in which it may be placed.

Another instrument takes a photographic record of the position of the compass needle and plumb-bob, after the lapse of such an interval of time as is necessary to place the instrument in proper position and allow the needle and plumb-bob to come to rest. The position of points in any plane stratum, as found by three boreholes, determines it. If, however, the angle at which a borehole cuts this stratum is known, only two boreholes are necessary and if the strike and dip of the stratum is known, one borehole is sufficient to determine it.

347. STAKING OUT THE PROBABLE APEX OF A VEIN. —

It is often required to prolong the course of an inclined vein on the rugged surface, either for exploration purposes or to locate a claim. This may be accomplished by setting up on the vein a transit fitted with a solar attachment, the main telescope being inclined at the angle of dip of the vein in altitude and pointed at right angles to the strike. The solar attachment, when set for the zero declination, will sight points only in the plane of the vein.

As veins are usually somewhat irregular, the survey need not necessarily be made with a transit. Instead, such instruments as the compass, clinometer, or a small improvised plane table may be used.

348. ECONOMIC PRINCIPLES. — The surveying of mine workings is strictly an economic problem and the surveyor must study it as such. The accuracy attained must be such that the cost in obtaining it and the saving of expense in mining operations through it together effect the maximum of economy. The surveyor bearing this in mind will be neither too careless nor too exact. He will not, for example, close down the mine in order to carry a meridian into it when no important connections are needed, and there are no boundary disputes. On the other hand, in some cases accuracy of a survey is of such prime impor-

tance that a temporary interference with the working of the mine may be warranted.

In any given case the surveyor must make a scientific measure of the accuracy required. There is no better method of obtaining accurate results than to go over the lines several times with varying conditions, but this is not always good economy, especially in such work as plumbing a shaft which necessitates a temporary stoppage of all hoisting operations. Often the controlling error will be the error in plumbing of the meridian. In Fig. 142, D is the horizontal distance in a straight line from the shaft to the connection, d is the distance between the plumb-lines, and e its error as ascertained by measuring or other means.

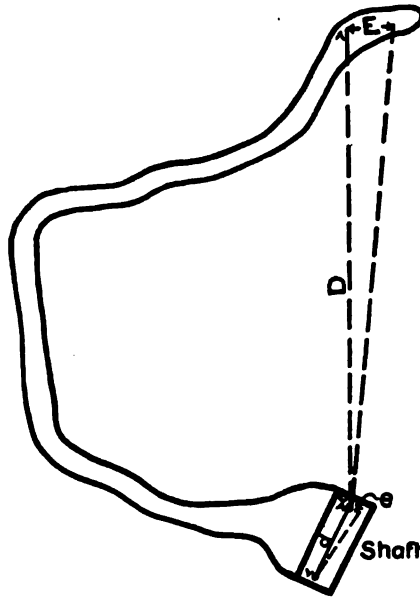

FIG. 142.

The controlling error at the connection is $E = e \frac{D}{d}$ and is in a direction perpendicular to that in which D was measured on the chart. This is obvious, for the surveys of the galleries are considered accurate, the error being one of relative rotation around the shaft as an axis. Where there are many angular errors of the same degree of magnitude, such as occur when a number of short sights are included in the traverse, the distances may be measured from these short lines to the connection and their respective errors E_1, E_2, E_3 , etc. found at these localities. These are then resolved according to their respective latitudes and departures into S_1, S_2, S_3 , etc., and W_1, W_2, W_3 , etc. The greatest

possible error is then $S_1 + S_2 + S_3 + \text{etc.}$ to the north or south and $W_1 + W_2 + W_3 + \text{etc.}$, to the east or west, these summations being made without regard to any sign.

Likewise the mean probable error (by method of least squares), is $\sqrt{S_1^2 + S_2^2 + S_3^2 + \text{etc.}}$ to the north or south and $\sqrt{W_1^2 + W_2^2 + W_3^2 + \text{etc.}}$ to the east or west. Errors due to the measurement of distances, which are not likely to be great, may be divided into latitudes and departures directly and compounded with those due to angular error.

Besides being of immediate service to the surveyor, the practice of computing possible and probable errors gets him in the habit of thinking along the most business-like lines instead of drifting into a rut or losing interest in his work.

The surveyor should keep his plans up to date and see that the men in charge of the mining operations fully understand their instructions; for many mining "bosses" of considerable experience get entirely wrong notions of the shape of their workings and are often too proud to ask for information. The surveyor, without assuming a "know-it-all" attitude, can, from the specialized nature of his work, often make useful suggestions in regard to the exploration of a mine. By working always in harmony with the other officials of the mine, he can further the interests of all concerned, both employers and employees.

PROBLEMS.

1. From a monument at the mouth of a tunnel a line is run in the tunnel, azimuth $37^\circ 24'$, slope distance 424 ft., vertical angle $+ 2^\circ 10'$; thence azimuth $62^\circ 42'$, slope distance 278.5 ft., vertical angle $+ 2^\circ 18'$ to breast. From the same monument a line is run on the surface, azimuth $98^\circ 33'$, slope distance 318.5 ft., vertical angle $- 3^\circ 22'$; thence azimuth $38^\circ 02'$, slope distance 647 ft., vertical angle $+ 14^\circ 13'$ to the center of a vertical shaft. How deep must the shaft be to meet a connecting drift run on a grade of $+ 2.4\%$ from the breast of tunnel, and what is the slope length and azimuth of this drift?

2. The strike of a certain vein at point of outcrop is $N 43^\circ E$ and the dip is $71^\circ 50'$, pitch S.E. From this point of outcrop a surface line is run, $N 83^\circ 15' E$, slope distance 248 ft., vertical angle $- 12^\circ 34'$; thence $S 2^\circ 54' E$, slope distance 208.5, vertical angle $- 14^\circ 34'$ to a point from which the tunnel is to be driven in the direction $N 71^\circ W$ and with a grade of $+ 3.8\%$ until it intersects the vein.

(a) What would be the slope length of such a tunnel?

(b) What would be the slope length and bearing of the shortest possible tunnel run on a + 1.3% grade to intersect the vein?

3. A vein has a pitch of S 67° W and its dip is 55°. What is the azimuth of an incline on the vein having a slope of 44°?

4. From the bottom of vertical shaft No. 1 a horizontal traverse was run in the mine to the bottom of vertical shaft No. 2 as follows: Assumed azimuth 0°, distance 243 ft.; thence azimuth 340°, distance 121 ft.; thence southeasterly a distance of 473 ft. along a vein which shows a pitch of 60° (azimuth) and a dip of 35°; thence azimuth 42°, distance 25 ft. to the center of shaft No. 2. From a point vertically above the last point a line is run on the surface with true azimuth 116° 20', distance 411 ft. (horizontal) to a point *A* from which the center of shaft No. 1 is sighted at azimuth 71° 30'.

(a) How much deeper will shaft No. 2 have to be sunk to reach the vein?

(b) What is the true strike of the vein?

5. A vertical winze has been sunk below the level of a tunnel. It is desired to sink a vertical shaft from the surface to connect with the winze. The monument *X* is established at the mouth of the tunnel and the monument *Y* is near the site of the proposed shaft. *Y* bears S 88° 58' 56" W, 896.796 ft. from *X*. The following are the notes of the survey connecting *X* and the winze corners *A*, *B*, *C*, and *D*:—

Station.	Mean Deflection.	Horizontal Distance.	Station.
<i>X</i>	0° 00'	896.796	<i>Y</i>
<i>Y</i>	45° 05' 34" R	403.080	1
1	74° 05' 06" L	587.208	2
2	32° 23' 43" L	67.000	3
3	54° 43' 47" R	44.803	4
4	39° 51' 57" R	41.075	5
5	31° 10' 10" R	19.573	Cor. <i>A</i>
	31° 10' 10" R	27.240	Cor. <i>B</i>
	31° 43' 40" R	21.477	Cor. <i>C</i>
	24° 02' 40" R	25.773	Cor. <i>D</i>

Required the location of the shaft corners on the surface.

6. From a monument *M* at the mouth of a tunnel a traverse is run in the tunnel, azimuth 20° 35', distance 352 ft., vertical angle + 1° to point *A*; thence azimuth 61°, distance 528 ft., vertical angle + 1° 40' to point *B* at the breast of the tunnel. From *M* a surface traverse is run, azimuth 11° 10', distance 578 ft., vertical angle + 4° 25' to point *C*; thence azimuth 11°, distance 407 ft., vertical angle + 14° 20' to point *D*, which is the center of a vertical shaft 120 ft. deep. Find the length and grade of a connecting incline from the bottom of the shaft to the breast of the tunnel.

7. The course of Tunnel *A* is N 34° 45' 10" W., the grade 0.42%, and the elevation of the mouth 2570 ft. The course of Tunnel *B* is N 0° 45' 00" W, the grade 0.33%, and the elevation of the mouth 2608 ft. The following traverse con-

nects the mouths of the two tunnels: — from mouth of Tunnel *B*, $N\ 0^{\circ}\ 45'\ 10''\ W$, 100 ft.; thence $N\ 19^{\circ}\ 17'\ 30''\ E$, 381.60 ft.; thence $S\ 10^{\circ}\ 21'\ 20''\ E$, 130.60 ft.; thence $N\ 74^{\circ}\ 14'\ 30''\ E$, 3662.01 ft.; thence $N\ 85^{\circ}\ 45'\ 30''\ E$, 1547.21 ft.; thence $N\ 73^{\circ}\ 48'\ 00''\ E$, 1455.00 ft.; thence $S\ 12^{\circ}\ 00'\ 00''\ E$, 205.40 ft.; thence $S\ 70^{\circ}\ 00'\ 10''\ E$, 205.00 ft. to the mouth of Tunnel *A*. Where and how far must one upraise vertically in order to connect the tunnels? Do not consider the dimensions of the tunnels.

8. Assuming the transit to be in perfect adjustment what is the error in horizontal angle in sighting down a 500-ft. shaft, 5 ft. in breadth, when the telescope cannot be sighted closer than 3 seconds along the inclined line?

PART III.
COMPUTATIONS.

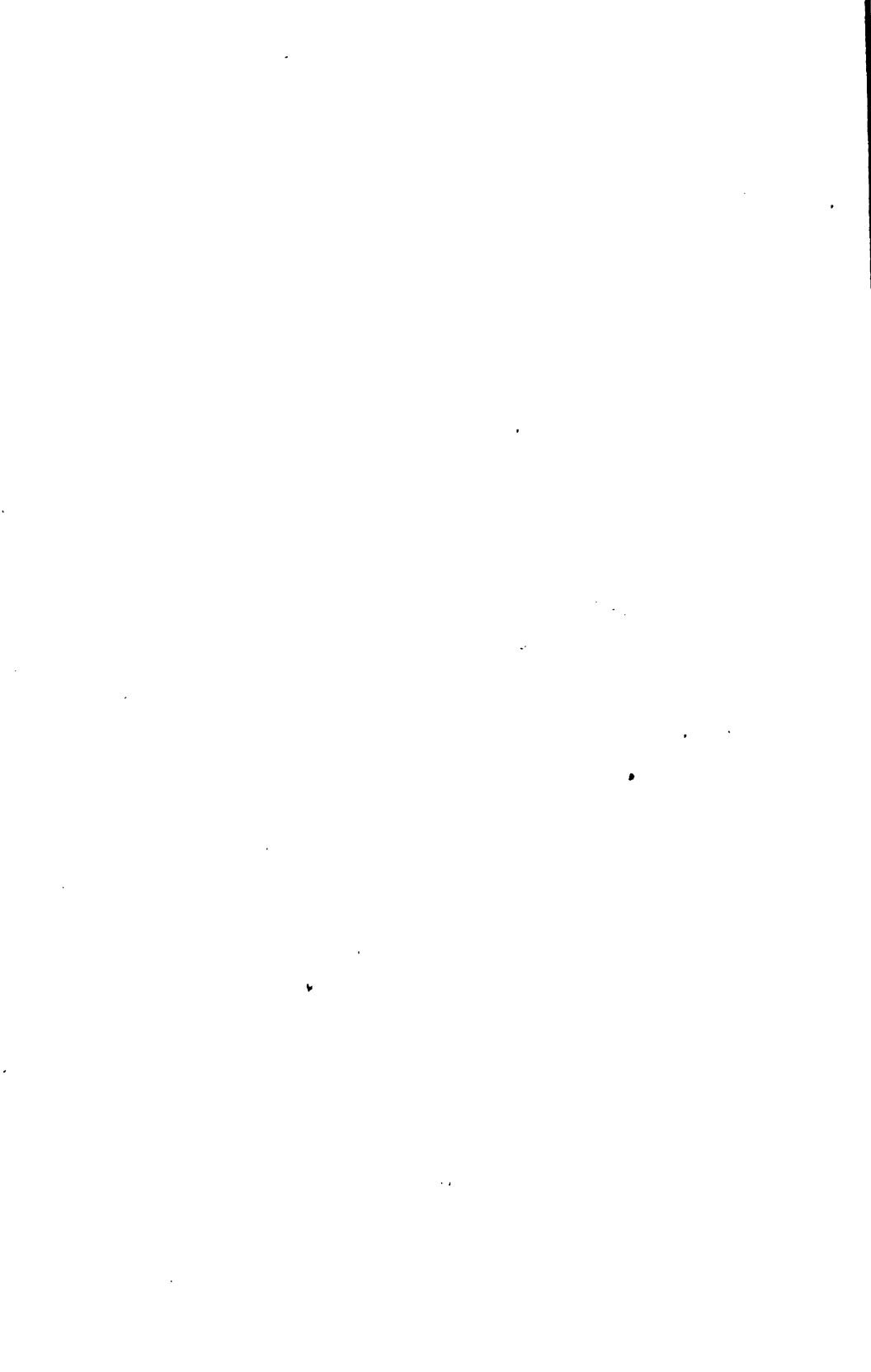

PART III.
COMPUTATIONS.
CHAPTER, XII.

**GENERAL PRINCIPLES.—MISCELLANEOUS PROBLEMS.—
EARTHWORK COMPUTATIONS.**

349. **GENERAL REMARKS.**—The ultimate purpose of many surveys is to obtain certain numerical results to represent quantities such as areas or volumes. In the section on Surveying Methods it has been pointed out that in all surveys there should be a proper relation between the precision of measurement of the angles and distances. To secure final results to any given degree of precision, the measurements in the field must be taken with sufficient precision to yield such results. In computing from a given set of field notes the surveyor should first determine how many places of figures he should use in the computations, the aim being to obtain all the accuracy which the field measurements will yield without wasting time by using more significant figures than are necessary. Professor Silas W. Holman* in the preface to his "Computation Rules and Logarithms" says:—"It would probably be within safe limits to assert that one-half of the time expended in computations is wasted through the use of an excessive number of places of figures, and through failure to employ logarithms."

Final results should be carried to as many significant figures as the data will warrant and no more. In order to insure the desired precision in the last figure of the result it will usually be necessary to carry the intermediate work one place further than is required for the final result.

350. The number of significant figures in the result of an observation is the number of digits which are known. For instance, if a distance is recorded as 24,000 ft. when its value was

* See "Computation Rules and Logarithms," by Professor Silas W. Holman, published by Macmillan & Co., New York.

obtained to the nearest thousand feet only, it contains but two significant figures. The zeros are simply put in to show the place of the decimal point. If, however, the distance has been measured to the nearest foot and found to be 24,000 ft. there are five significant figures, for the zeros are here as significant as the 2 or 4. Similarly a measurement such as 0.00047 contains but two significant figures, the zeros simply designating the position of the decimal point, for, had this same value been recorded in a unit $\frac{1}{100,000}$ as large the result would have been 47.

Again, if a series of rod-readings are taken on different points to thousandths of a foot and three of the readings are 4.876, 5.106, and 4.000 it is evident that each of these readings contains four significant figures; if each of them is multiplied by 1.246 the respective results are 6.075, 6.362, and 4.984. But had the results been measured to the nearest tenth of a foot and found to be 4.9, 5.1, and 4.0 these values when multiplied by 1.246 should appear as 6.1, 6.4, and 5.0. This illustration indicates the proper use of significant figures. Since the rod-readings 4.9, 5.1, and 4.0 are reliable only to about 1.5 to 2 per cent. the multiple 1.246 should be used in this computation as 1.25. Similarly in the use of such a constant as $\pi = 3.1415927$ it is a waste of time to use any more significant figures in the constant than exist in numbers with which the constant is to be combined in the computation.

351. In deciding how many places of decimals to use in the trigonometric functions the student should examine the tabular differences and determine what percentage error is introduced by any error in an angle. For example, suppose an angle of a triangle to have been measured in the field to the nearest minute. There may be an error of 30 seconds in this angle, and it will be seen from the table of natural sines that the tabular difference for one minute in the fourth decimal place varies from 3 for a small angle to less than 1 for a large angle, and that the variation is about the same for cosines, and for tangents and cotangents of angles under 45° . Then for half a minute the difference will be, on an average, about 1 in the fourth place. Therefore, in general, four places will be sufficient when the angles have been measured to the nearest minute only. But if there are several steps in the computations it may be advisable to use

five-place tables. Similarly it can be seen that five-place tables of functions will, in general, give angles to the nearest 10 seconds, and six-place tables to the nearest second. These are only average results and are intended to give the student a suggestion as to how to decide for himself whether to use four, five, or six-place tables. It is obviously a great saving of time to use four-place tables where four places are needed rather than to use six or seven-place tables and drop off the last two or three digits. The amount of labor increases about as the square of the number of places in the tables, i.e., work with 6-place tables: work with 4-place table = 36:16.

352. The following simple examples illustrate the uselessness of measuring the distances with a precision which is inconsistent with that of the angles, when the angles are to be used in the computation of other distances. Given the measurements shown on Fig. 143. If the angle B was measured to the nearest minute only there may be an error of 30 seconds in this angle and the tabular difference for 30 seconds for the sine and cosine of this angle in four-place tables is 0.0001; therefore use four-place tables. In this case it is evident that the 0.02 on the hypotenuse distance is of no value whatever in determining the length of the other two sides a and b , that the 0.6 being the fourth significant figure should be retained, and that the resulting length of a or b will not be reliable to more than four significant figures.

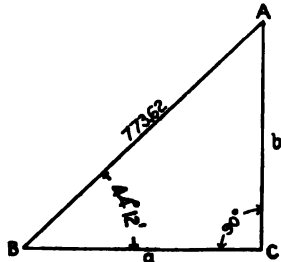

FIG. 143.

$$\begin{array}{rcl}
 \log 773.6 = 2.8885 & \log 773.6 = 2.8885 \\
 \log \cos 44^{\circ} 12' = \underline{9.8555} & \log \sin 44^{\circ} 12' = \underline{9.8433} \\
 \log a = 2.7440 & \log b = 2.7318 \\
 a = 554.6 & b = 539.3
 \end{array}$$

If it is assumed, however, that the angle B is measured by repetition and found to be $44^{\circ} 12' 25''$ the error in the original angle then was about $25''$. By using the same value for the hypo-

tenuse (773.6) and six-place tables to secure greater precision the value of a is 554.5 and of b 539.4. Comparing these results with those obtained above will give a good idea of the error in length of these lines due to reading the angle to the nearest minute only and also a proper conception of the fallacy of computing with tables of more than four places when the angles are read to the nearest minute only. The difference between the values of a and b obtained by use of the angle $44^\circ 12'$ and similar results by use of $44^\circ 12' 25''$ is due entirely to the $25''$ and not to the fact that four-place tables were used in the former case and six-place tables in the latter, for in both cases the result has been obtained to four significant figures only.

It is also evident that when the angle B was measured to the nearest minute it was inconsistent to measure the hypotenuse closer than to the nearest tenth of a foot. But if angle B was measured to the nearest 10 seconds the line AB should have been measured to the nearest hundredth. It should not, however, be assumed that in all cases where angles are only measured to the nearest minute the sides should be recorded to tenths of a foot. It is the **percentage** error in the measurement of the sides which must be the same as the **percentage** error in the angles. If the sides are very short, they should be measured to hundredths of a foot to be consistent with angles to the nearest minute. In general, when the angles are read to nearest minute only, the sides should be measured to four significant figures; with angle to nearest 10 seconds they should be measured to five significant figures; and with angles measured to 1 second the sides should be measured to six significant figures. All the sides of a triangle of considerable size might be measured to hundredths of a foot, the angles being recorded to the nearest minute only, and the distances used for the computations, the angles serving merely as checks; this, of course, is practicable at times.

353. In Fig. 144 the angle is measured to the nearest minute,

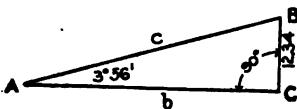

FIG. 144.

but the distance is measured to hundredths of a foot. In this case we are to determine the length of a long line from a short one and the error in the short line is therefore multi-

plied several times. The same degree of precision should be secured in the measured line BC as is desired in the computed lines AC or AB , which, it is assumed in this case, is required to four significant figures. In order that the measurements of line BC and angle A may be consistent with the precision of the required result, BC should be taken to the nearest hundredth of a foot and angle A to the nearest minute. In this computation four-place tables should be used and the value obtained for AC or AB should be recorded only to four significant figures.

$$\begin{aligned}\log 12.34 &= 1.0913 \\ \log \tan 3^{\circ}56' &= \underline{8.8373} \\ \log AC &= 2.2540 \\ AC &= 179.5\end{aligned}$$

If AC is desired to the nearest hundredth of a foot the angle A might be determined closely by repetition, but this will not give the length AC to the nearest hundredth unless BC has been measured closer than to the nearest hundredth; for, suppose there is an error of 0.005 ft. in the measurement of BC , then the line AC being about 15 times as long as BC will have an error of 0.075 ft. no matter how exact the angle at A may be measured. In other words, if AC is desired correct to five significant figures BC should contain five significant figures. Evidently the practical way of obtaining an exact value for the inaccessible distance AC is to measure AB to the nearest hundredth, and to compute AC from AB and BC , using the angle at A as a check on the measured distances. In both of the above examples it is assumed that the 90° is exact.

354. LOGARITHMIC OR NATURAL FUNCTIONS. — The question as to whether logarithmic or natural functions shall be used will depend upon the computation in hand. Many surveyors have become so accustomed to using naturals that they will often use them when logarithms would require less work and offer fewer opportunities for mistakes. Each method has its proper place, and the computer must decide which will be the better in any given case. The use of logarithms saves considerable time spent in actual computation because the process is

simpler, but, on the other hand, looking up the logarithms consumes time. The result is in many cases, however, a saving of time over that required to do the arithmetical work of multiplying or dividing. While the multiplication of two numbers of three or four digits each can possibly be done directly more quickly than by logarithms, still it takes more mental effort and there is more opportunity for making mistakes; but in case several such multiplications are to be made logarithms are almost always preferable. Furthermore when there are several multiplications of the same number logarithms will save time since the logarithm of this common number has to be taken from the table but once. Frequently, however, the computation is so simple that the use of logarithms would be almost absurd, e.g., the multiplication of any number by a simple number like 20, 25, 150, or 500. If a function of an angle is to be multiplied or divided by

any such number the natural function should of course be used.

355. SHORT CUTS.—The solution of a right triangle, when one of the angles is small, involving the use of the cosine of this small angle, can often be more easily obtained by the use of the versed sine or external secant of the angle. In Fig. 145

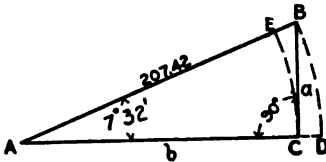

$$\text{Vers } A = \frac{CD}{AB}$$

$$\text{Exsec } A = \frac{EB}{AC}$$

FIG. 145.

$$AB = 207.42$$

$$A = 7^\circ 32'$$

$$AC = 207.42 \cos 7^\circ 32' \quad (1)$$

$$\text{But } AC = AB - CD$$

$$= 207.42 - 207.42 \text{ vers } 7^\circ 32' \quad (2)$$

$$= 207.42 - 207.42 \times 0.00863$$

$$(207.42 \times 0.00863 = 1.79; \text{ by slide rule.})$$

$$= 207.42 - 1.79$$

$$= 205.63$$

Obviously, when the angle is quite small, the result of the multiplication indicated in (2) can be taken from the table to the nearest hundredth of a foot with much less effort than is required for the computation called for in (1). In fact, the computation in (2) can often be done more quickly by the use of natural numbers than by logarithms, and in most cases the slide rule will give results sufficiently exact (Art. 359, p. 330).

Had AC been given (205.63) and the angle A , ($7^\circ 32'$) then

$$\begin{aligned}
 AB &= \frac{205.63}{\cos 7^\circ 32'} \\
 \text{But } AB &= AE + EB \\
 &= 205.63 + 205.63 \operatorname{exsec} 7^\circ 32' \\
 &= 205.63 + 205.63 \times 0.00871 \\
 (205.63 \times 0.00871 &= 1.79, \text{ by slide rule.}) \\
 &= 205.63 + 1.79 \\
 &= 207.42
 \end{aligned}$$

356. There are many "short cuts" in arithmetical work which are of great value to the computer, and the student should endeavor to learn the most common and simple ones. The following are a few illustrations.

$$\begin{aligned}
 247 \times 25 &= \frac{247 \times 100}{4} = \frac{24700}{4} \\
 682 \times 50 &= \frac{68200}{2} \\
 694 \times 150 &= 69400 + 34700 \\
 927 \times 62.5 &= 92700 \times \frac{5}{8} \\
 672 \times 1002.3 &= 672000 + 1344 + 201.6 \\
 547 \times .9968 &= 547 (1 - .0032) = 547 - 5.47 \times .32 \\
 \frac{43}{60} &= \frac{4.3}{6} \text{ (reducing minutes to decimals of a degree)} \\
 \frac{843}{12.5} &= 8.43 \times 8
 \end{aligned}$$

The student should cultivate the habit of performing mentally as much of the work as can be done without fatigue, delay, or danger of mistakes. No hard and fast rule can be laid down in this matter, as some persons have more aptitude than others for work of this kind. Such subtractions as $180^{\circ} - 36^{\circ} 47' 18''$ should always be performed mentally. Also in taking the cologarithm of a number from a table of logarithms the result should be written down directly.

357. ARRANGEMENT OF COMPUTATIONS. — All surveying computations should be kept in a special computation book. At the head of the page should appear the title of the work, the number and page of the field note-book from which the data are copied, the names of the computer and checker, and the date. The work should be arranged neatly and systematically so that every part of the computations can be traced by any one who is familiar with such work. Where possible the work should be so arranged that numbers will have to be written but once. Each important value, each column, etc. should be labeled so that it can be readily found.

358. CHECKS. — It is very important that all calculations should be checked, not merely at the end of the computation but also at as many intermediate steps as possible. In this way a great waste of time may be prevented and serious mistakes avoided. One good method of checking is to perform the operations when possible by two independent methods, for example, by the use of logarithms and by natural functions. Very often two men do the computing, one man's work acting as a check on that of the other. The two may each work by the same or by different methods, and the results may be compared at intervals. **Every part of the work should be done independently, from the copying of data out of the note-book to the final results.** It is not uncommon to find two men computing the same area where only one of them looks up the logarithms. In case a mistake is made in looking up the logarithms the results may check but both are wrong. The computer should also check his work roughly by estimating approximately what the result should be.

359. SLIDE RULE. — A valuable aid in checking calculations is an instrument known as the *slide rule*, which enables the computer

to multiply and divide numbers by logarithms by a purely mechanical process. It is really the equivalent of a table of logarithms. It consists of a wooden rule, usually about 10 inches long, having a groove in one side in which runs a small wooden strip called the slide. On one face of the rule are placed two scales, *A* and *D*, Fig. 146, one above and one below the slide which is indicated by

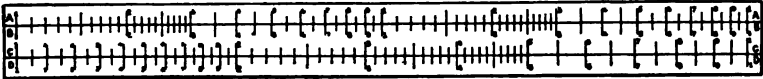

FIG. 146.

B and *C*. These are constructed by plotting logarithms of numbers by subdividing a unit of some convenient length, say 10 inches. For example, the log of 1 is 0, so this is taken as the left end of the scale and the number 1 placed at this point. The log of 2, to three significant figures, is 0.301, and a line is placed therefore at a distance equal to $\frac{301}{1000}$ of the 10 inches, or 3.01 inches, and marked with the number 2. Similarly at 4.77 ($\log 3 = 0.477$) a line is marked 3. In this way the logarithms of other numbers are plotted. The space between 1 and 2 is subdivided by plotting $\log 1.1$, $\log 1.2$, etc. The subdivision is continued until the spaces are as small as will admit of rapid and accurate reading of the scale.

It is customary to make the spacing on the upper scale just half that on the lower, i.e., if 10 inches is chosen as the unit for the lower scale, then the unit for the upper scale will be 5 inches. Since the length of this upper scale is only half the length of the rule there are usually two scales exactly alike marked on the upper part of the rule, the right end of one coinciding with the left end of the other.

On the slide are two scales, *B* and *C*, exact duplicates of those on the rule and so placed that when the end line of the scale *B* on the slide is placed opposite the end line of the scale *A* on the rule, every line on the slide is exactly opposite its corresponding line on the rule. A *runner* is usually attached to the rule for convenience in setting and reading the scales. This runner is a small metal slide which fits over the face of the rule in such

a way that it can be slid along the rule and set at any reading of the scale. It is usually provided with a fine line running cross-wise of the rule which is used in marking the exact setting.

Multiplication or division of numbers is performed by adding or subtracting the scale distances corresponding to these numbers. The scale distance is the logarithm of the number. Adding two scale distances is, in effect, adding two logarithms, and the resulting scale distance is the logarithm of the number marked opposite on the scale. For example, if the left end of scale *C*, Fig. 147, is set opposite the number 2 of the scale *D*, then opposite the number 3 on scale *C*, is found the product, 6, on scale *D*. The distances which have been added are those corresponding to $\log 2$ and $\log 3$ respectively. The sum of these distances is the distance corresponding to $\log 6$. Division is performed by placing the divisor on scale *C* over the dividend on scale *D* and reading the result, opposite the end of the scale *C* on the scale *D*.

Fig. 147 shows the position of the scales for dividing 6 by 3.



FIG. 147.

The scales *A* and *B* may be used in a like manner. It is evident that, by setting the runner on the result of one operation and then moving the slide so that one of its ends coincides with the runner setting, continued multiplication and division can be performed without the necessity of reading intermediate results.

Scale *D* may be used in connection with scale *A* for obtaining squares or extracting square roots. Since the spaces on scale *A* are one-half those on scale *D* the number 4 on scale *A* is opposite number 2 on scale *D*, 9 is opposite 3, and so on, every number on scale *A* being the square of the corresponding number on scale *D*. Other scales, generally log sines and log tangents, are placed on the reverse side of the slide, so that trigonometric calculations can also be performed with this instrument. Results

obtained with the ordinary 10 inch slide rule are usually correct to 3 significant figures, so that this slide rule is the equivalent of three-place logarithm tables.

360. Thacher Slide Rule.— The Thacher slide rule consists of a cylinder about four inches in diameter and eighteen inches long working within a framework of triangular bars. On these bars is fastened a scale corresponding to the scale on an ordinary slide rule, and on the cylinder is marked another scale like that on the bars. The cylinder is the *slide* and the triangular bars form the *rule*. This rule is operated in a manner similar to the one explained above. Results can be obtained with it which are correct to four and usually to five significant figures.

361. REDUCING THE FIELD NOTES FOR COMPUTATIONS.— Before any of the computations are made the measurements taken in the field frequently have to be corrected on account of erroneous length of tape. This correction can usually be made mentally when the distances are transcribed into the computation book. The errors in the angles are balanced by altering the value of those angles which were taken from short sights since the angular errors are most likely to occur in these. In some cases, where it has been found desirable to take measurements on a slope, these distances are reduced to horizontal distances by multiplying them by the versed sine of the vertical angle and subtracting the result from the *corrected* slope distance; the correction for error in the tape being made *before* this is done. Sometimes instead of a vertical angle the slope distance and the difference in elevation between the points are the data contained in the field notes. In this case the formula given in Art. 20, p. 13, should ordinarily be used.

362. CURVED BOUNDARY BY OFFSETS.— The offsets to the brook (Fig. 53, p. 104) were taken at regular intervals in one portion of the survey and in another portion offsets were taken at the points where the direction of the brook changes. The offsets which were taken at regular intervals give a series of trapezoids with equal altitudes the area of which can be obtained by one computation. Although there are several approximate rules for this computation the two most common are what are known as the *Trapezoidal Rule* and *Simpson's One-Third Rule*.

363. Trapezoidal Rule. — If the figure is considered as made up of a series of trapezoids their area can be found by the following rule: —

$$\text{Area} = d \left(\frac{h_e}{2} + \Sigma h + \frac{h'_e}{2} \right)$$

where d = common distance between offsets,
 h_e and h'_e = end offsets of the series of trapezoids,
 and Σh = sum of the intermediate offsets.

364. Simpson's One-Third Rule. — In the development of this formula the curved line is assumed to be a parabolic curve. It is claimed by some that this affords results more nearly correct than the Trapezoidal Rule, although for most problems of this kind, where the offsets at best can give but an approximate location of the boundary, frequently a brook or crooked wall the center of which must be estimated, it is quite probable that the Trapezoidal Rule is sufficiently exact. Simpson's One-Third Rule is as follows: —

$$\text{Area} = \frac{d}{3} (h_e + 2\Sigma h_{\text{odd}} + 4\Sigma h_{\text{even}} + h'_e)$$

where d = common distance between offsets,
 h_e and h'_e = end offsets of the series,
 $2 \Sigma h_{\text{odd}}$ = twice the sum of all the odd offsets
 (the 3d, 5th, 7th, etc., from the end)
 $4 \Sigma h_{\text{even}}$ = twice the sum of all the even offsets
 (the 2d, 4th, 6th, etc., from the end).

For this rule to apply there must be an **even** number of trapezoids; if there is an odd number, an even number of them may be computed by this rule and the extra trapezoid must be computed separately. Or, if there is a triangle or trapezoid at the end of this series, which has a base greater or less than d , it must also be computed separately.

Fig. 148 shows the computation of a series by both methods and also the computation of several trapezoids and triangles at the ends of the series. The data are taken from the field notes in Fig. 53, p. 104.

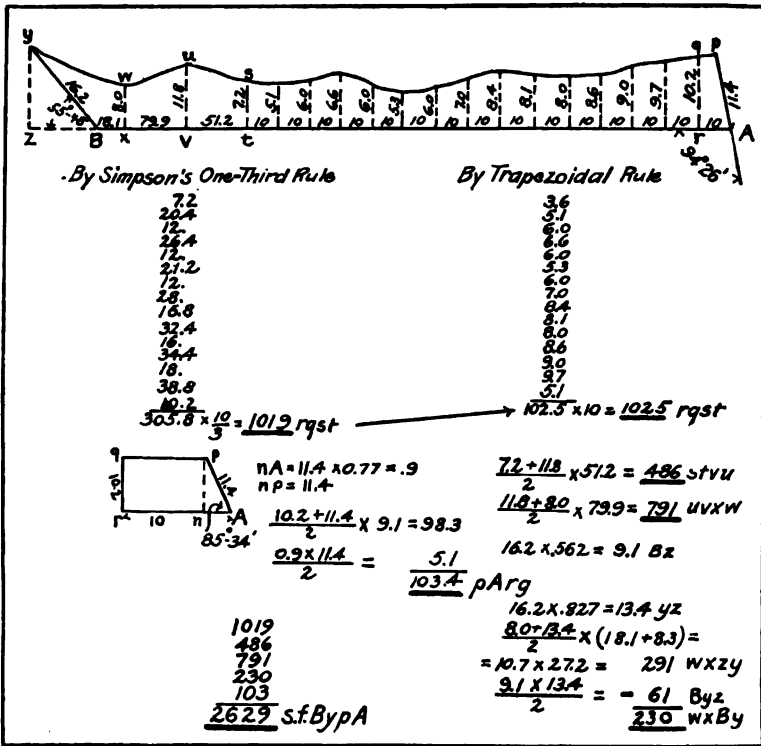

FIG. 148.

365. **STRAIGHTENING CROOKED BOUNDARY LINES.** — In Fig. 149, *A EFGH* represents a curved boundary between two

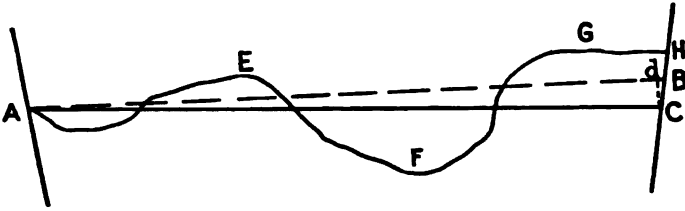

FIG. 149. STRAIGHTENING A CROOKED BOUNDARY.

tracts of land, and it is desired to run a line from *A* so as to make the boundary a straight line and to leave each tract of the same area as before.

The trial line *AB* is first run, and the distance *AB*, the angles at *A* and *B*, and the necessary offsets to the curved boundary are measured in the field. Then the areas of the property between this trial line and the curved line are computed as explained in the previous articles. The sum of the fractional areas on one side of the trial line and the sum of the areas on the other side of it should be equal. If not made so by the trial line, the difference between these sums is the area of a correction triangle *ABC* which must be taken from one tract and added to the other. The area and the base *AB* being known the altitude *dC* can be computed. Then in the triangle *ABC*, the lines *BC* and *AC* and the angle at *A* are calculated; and the line *AC* is staked out, its calculated length being checked by measuring the line *AC* in the field and the angle at *A* being checked by the measured distance *BC*.

366. **AREA BY TRIANGLES.** — If the field has been surveyed by setting the transit in the middle of the field and taking angles between the corners (Art. 138, p. 105), the areas of the triangles may be found by the trigonometric formula:

$$\text{Area} = \frac{1}{2} a b \sin C,$$

where *C* is the angle included between the sides *a* and *b*.

If all three sides of any of the triangles have been measured

or if the field has been surveyed with the tape alone (Art. 139, p. 106), the area of the triangles can be found by the trigonometric formula: —

$$\text{Area} = \sqrt{s(s-a)(s-b)(s-c)}$$

where a , b , and c are the sides and $s = \frac{a+b+c}{2}$.

367. AREA OF A QUADRILATERAL BY TRIANGLES. —

Most city lots have four sides, and while the Double Meridian Distance Method (Art. 384, p. 352) is often employed in computing their areas, it is not at all uncommon in computing such quadrilateral lots to divide them into triangles, checking the fieldwork and computations, and computing the areas by triangles.

In Fig. 150, $ABCD$ represents an ordinary city lot in which all the sides and angles have been measured. It is evident that the diagonal BC can be computed either from BD , CD , and the angle D , or from AB , AC , and the angle A . These two determinations of BC should check each other. Similarly two independent determinations of AD can be found. These evidently check all the fieldwork and calculations as far as they have gone. In computing these triangles the best way is to resolve all the work into right triangle calculations, as suggested by the dotted lines on the figure.

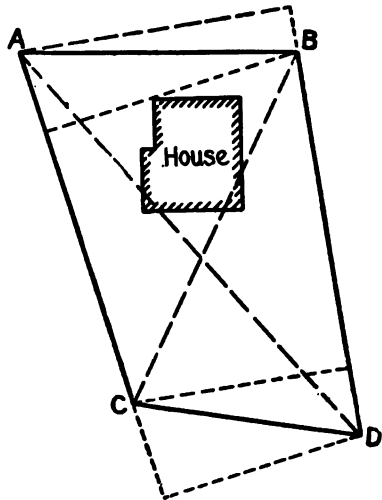

FIG. 150.

Not only is this method more simple than to use the oblique triangle formulas, but it gives at the same time altitude distances which are useful in computing the area of the lot. The area can be obtained by calculating the area of one pair of triangles and readily checked by calculating the other pair.

These formulas are fairly accurate when M is very small as compared with C . They are most useful, however, as a check on computations made by the preceding method.

369. ROUGH CHECKS ON AREAS.— If the traverse has been plotted to scale, it can be easily divided into simple figures such as rectangles or triangles, their dimensions scaled from the plan, and their areas computed, thereby giving an independent rough check on the area.

A piece of tracing cloth divided into small squares can be placed over the plan of the traverse and the number of squares counted and the fractional parts estimated, generally to tenths of a square, by inspection. Then the area of one square being known an approximate area of the traverse may be obtained.

370. Planimeter.— One of the commonest ways of checking the area of a traverse is to obtain its area by means of an instru-

$DB =$ Tangent Offset for chord CB .
 OE is drawn perpendicular to CB .
 In the two similar triangles OEB and CBD ,
 $DB : CB = BE : OB$
 $DB : CB = \frac{CB}{2} : OB$
 $DB = \frac{CB^2}{2 OB}$

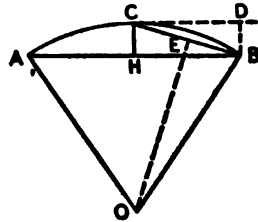

FIG. 152.

Offset from Tangent = $\frac{(\text{Chord})^2}{2 \times \text{Radius}}$
 But $DB = CH$, and $AB = 2 \times CB$ (approximately) (1)

$$\therefore CH = \frac{\left(\frac{AB}{2}\right)^2}{2 OB} = \frac{AB^2}{8 OB} \quad (\text{approximately})$$

Middle Ordinate = $\frac{(\text{Chord})^2}{8 \times \text{Radius}}$ (approximately) (2)

The following will give some idea of the accuracy of this formula:

- When radius = 20 ft. and chord = 10 ft., $M = 0.625$, (correct value is 0.635).
- When radius = 100 ft. and chord = 25 ft., $M = 0.781$, (correct value is 0.784).
- When radius = 100 ft. and chord = 100 ft., $M = 12.500$, (correct value is 13.397).
- When radius = 1000 ft. and chord = 100 ft., $M = 1.250$, (correct value is 1.251).

It is evident from the above that this formula will not give accurate results when the chord is large in comparison with the radius.

ment called the *planimeter*, which is in principle a mechanical integrator. It is a small instrument consisting of an arm, carrying a tracing point, which is fastened to the frame of the instrument; the arm can be adjusted to any desired length. The frame touches the paper at only two points; one, the anchor point, and the other, the circumference of a small wheel which is free to revolve. On the rim of this wheel is a scale which is read by means of a small vernier. The length of the arm can be regulated by setting it at the proper reading on a scale which is marked on the arm, so that a unit on the wheel scale will represent any desired unit area such as a square inch or a square centimeter.

In using the instrument the anchor point is set at some convenient position on the drawing *outside* of the area to be measured and then the tracing point is run around the perimeter of the area to be determined. The reading on the wheel is recorded when the tracer is at the starting point. The tracer, in passing around the perimeter, should be kept as *closely as possible* on the boundary line and should return *exactly* to the starting point. Then the scale is again read, and the difference between the two readings is the area which has been traced out, expressed in some unit depending on the length of the arm. The result can be easily transposed into the unit of the scale of the map.

Usually the settings for the scale on the arm are furnished by the maker for various units of area. It is safer to test this setting by running the instrument around a known area, such as 4 square inches and determining the interval passed over by the wheel by making several tests and by setting the anchor point at different positions. This interval divided by 4 will be the value of one square inch of plan area and this is equivalent to a certain number of square feet of surface, depending upon the scale of the map. It is important that the sides of the trial square should be laid off so that they agree with the present scale of the map which, owing to swelling or shrinking of the paper, is frequently not quite the same as when it was first drawn (Art. 479, p. 428).*

* When areas are desired from U. S. Geological Survey maps on which are shown parallels of latitude and longitude it is best to refer all planimetered areas to the areas of a quadrilateral, say, 1° on a side. The area of such quadrilateral

371. DEFLECTION ANGLES AND CHORDS FOR A CIRCULAR CURVE.— The computations shown in Fig. 153 refer to the notes in Fig. 104, p. 237. In the discussion of the simple curve as

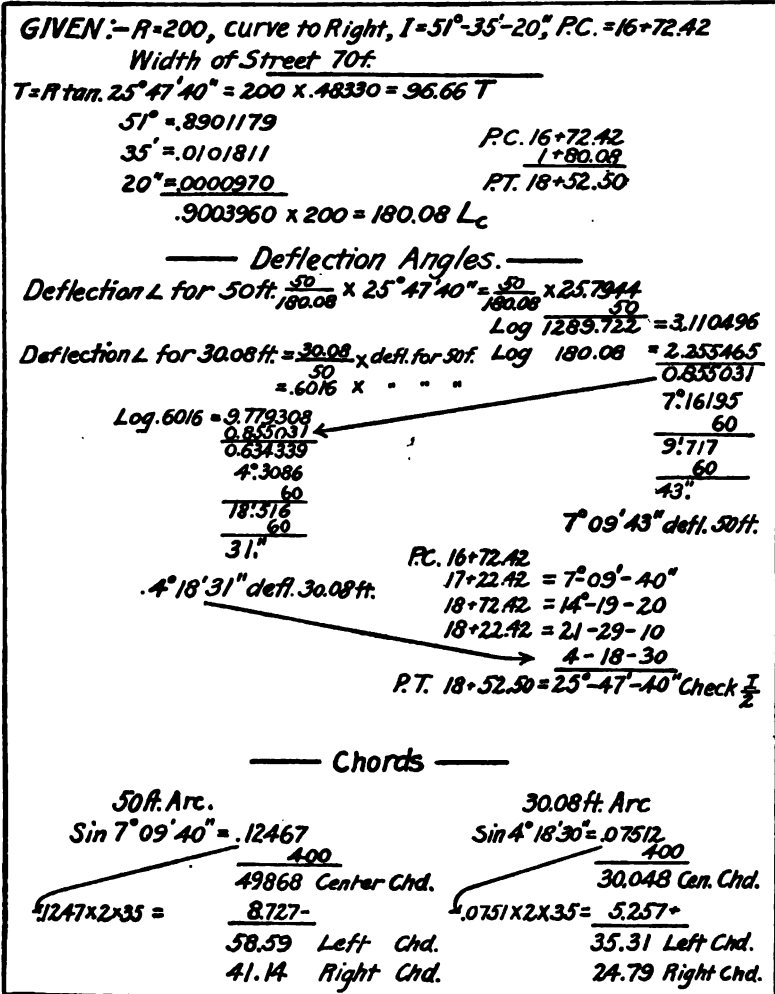

FIG. 153.

can be taken from a publication entitled Geological Tables and Formulas, by S. S. Gannett, Bulletin No. 232, U. S. Geological Survey, and by simple proportion the desired area found.

applied to city surveying (Art. 259, p. 234) will be found the formulas which have been used in the computations in Fig. 153. The length of the curve L_c is found by taking from Table VI, ("Lengths of Circular Arcs: Radius = 1"), the length of an arc for 51° , for $35'$, and for $20''$ successively and adding them, which gives the arc of a curve whose radius is 1 and whose central angle is $51^\circ 35' 20''$. This is then multiplied by the radius (200) which gives the value of L_c , which is added to the station of the P.C. to obtain the station of the P.T.

372. COMPUTATION OF OBSERVATIONS. — The computations relating to observations for meridian and latitude will be found in Chapter VII.

COMPUTATION OF VOLUME.

373. BORROW-PITS.* — Fig. 154 is a plan of a portion of a borrow-pit, at the corners of which the depth of excavation is marked in feet and tenths. Each of the regular sections of earthwork is a truncated rectangular prism whose volume is equal to the average of the four corner heights multiplied by the area of the cross-section, or expressed as a formula,

$$\text{Volume Truncated Rectangular Prism} = A \times \frac{h_1 + h_2 + h_3 + h_4}{4}$$

where A is the area of the cross-section and h_1 , h_2 , h_3 , and h_4 are the corner heights.

For a truncated triangular prism such as abc , using the same notation,

$$\text{Volume Truncated Triangular Prism} = A \times \frac{h_1 + h_2 + h_3}{3}$$

In computing a trapezoidal prism, such as $fdhg$, the trapezoid is subdivided into a rectangle $fehg$ and a triangle fde ; or for $jhds$, into two triangles by diagonal lines, as jhs and hds and their volumes may be computed by the above formula.

When there are several prisms with the same cross-section, as shown in Fig. 154, these rectangular prisms can be computed as one solid by assembling them as follows: — multiply each corner

* For a complete discussion of the computation of Borrow-Pits see *Railroad Curves and Earthwork* by Professor C. F. Allen, published by Spon & Chamberlain, New York.

height by the number of rectangular prisms in which it occurs and then add these results and divide by 4. This is then multiplied by the area of the cross-section of one prism. For example, in Fig. 154, the quantity bounded by *amnrjsa* can be found by

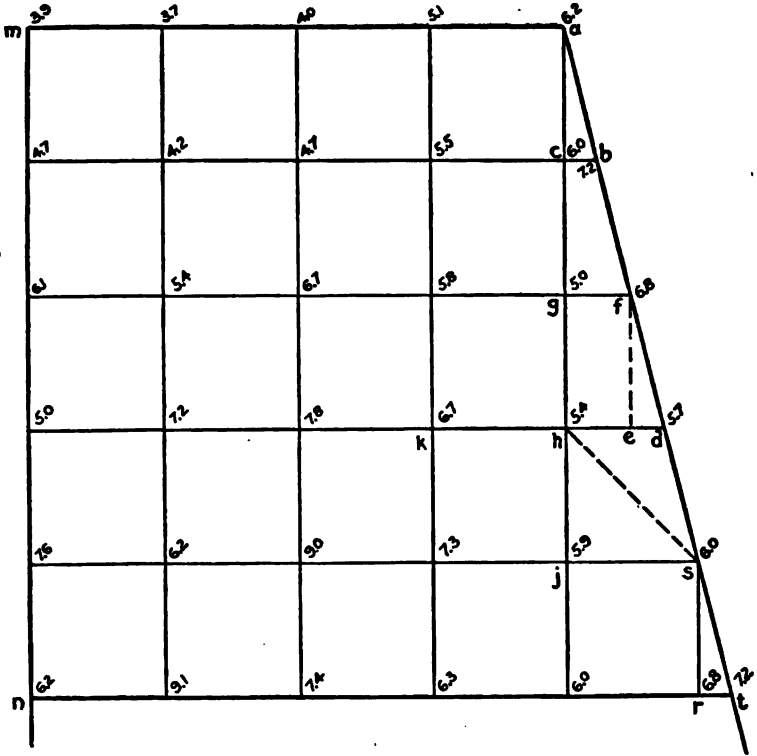

FIG. 154. PLAN OF PORTION OF A BORROW-PIT.

one computation because it is composed of a series of prisms having the same cross-section. In the summation of the heights, those at *a*, *m*, *n*, *r*, and *s* are taken but once, those at such points as *c*, *g*, *h*, etc. are multiplied by 2, at *j* the height is multiplied by 3, and at such points as *k* it is multiplied by 4.

Where the excavation is completed to a certain level, as in a cellar, it is a special case of above. The area of the cellar can be

divided into rectangles, their corner heights taken, and from these the volume can be computed.

374. VOLUME OF PRISMOID. — The data obtained from field notes are usually in the form of cross-sections which are taken at right angles to some general line of the construction, thereby dividing the earthwork into prismoidal solids with their bases parallel and their sides either plane or warped surfaces. The bases of the solids are the cross-sections which are obtained by taking sections of trench excavation or of road construction (Figs. 91 and 92, p. 2c8).

375. End Area Formula. — The simplest method of computing the volume of a prismoidal solid is to average the areas of the two bases and multiply by the distance between them, which, expressed as a formula, is

$$V = \frac{A_1 + A_2}{2} \times l \quad (\text{End Area Formula})$$

in which A_1 and A_2 are the areas of the two end bases and l is the distance between them. This method is used to a very great extent throughout the country, although it does not give sufficiently accurate results for certain classes of work.

376. Prismoidal Formula. — The correct volume of a prismoid is expressed by the *Prismoidal Formula*:

$$\text{Volume of Prismoid} = \frac{l}{6} (A_1 + 4A_m + A_2)$$

in which l is the distance between the two bases, A_1 and A_2 ; and A_m is the "middle area," i.e., the area half-way between the two bases, which is obtained by averaging the corresponding dimensions of the two end areas, A_1 and A_2 ; it should not be taken as the mean of A_1 and A_2 .

377. The end areas can easily be computed by dividing them into triangles as shown in Fig. 155, the area of which can be found readily from the dimensions given in the field notes.

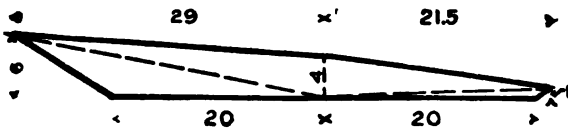

FIG. 155.

$$\text{Notes of section: } \frac{29.0}{+6.0} + 4.0 \frac{21.5}{+1.0}$$

$$\begin{aligned} \text{Area} &= \frac{4 \times (21.5 + 29)}{2} + \frac{20 \times (1 + 6)}{2} \\ &= 2 \times 50.5 + 10 \times 7 = 171. \end{aligned}$$

It is also the custom with some surveyors to plot each section carefully to scale and to obtain its area by use of the planimeter (Art. 370, p. 339). This is probably the most practical method when the sections are very irregular since the field work does not warrant the use of very accurate methods.

There are several other methods employed in computing earthwork but the above are by far the most common.

Several sets of Earthwork Tables and Diagrams have been published which reduce the work of computation very materially.

378. ESTIMATES FOR GRADING.—Estimates for grading may be conveniently made by means of a topographic map. On this map will appear the contours of the original surface. The contours representing the finished surface are also sketched upon the map, and the smaller the interval between the contours the more accurate will be the result. In Fig. 156 the full lines represent the contours of the original surface which is to be altered so that when the necessary cutting and filling has been done the new surface will have the appearance indicated by the dash contours. At contour 20 and at contour 25 no grading is to be done. On the plan, first sketch the lines *ABCDEF* and *AGHIJB* which are lines of "no cut" and "no fill," i.e., lines which enclose areas that are either to be excavated or filled. The amount of excavation and embankment must be computed separately. In sketching such lines the lines *AB*, *ED*, and *HI*, as will be seen, follow the intersection of the original contours with the new ones, since at these points there is no cut or fill. There are no direct data on the plan which define where the earthwork ends at *C* but the assumption is here made that the fill will run out to meet the original surface at about the next contour at *C*. In this example the fill must run out somewhere between the 24-ft. contour and the 25-ft. contour, for if it ran beyond the 25-ft.

contour there would be another new 25-ft. contour shown on the plan. Therefore the line *BCD* has been sketched to represent the limits of the fill in that vicinity; similarly *EFA*, *AGH*, and *IJB* have been sketched.

There are three general methods of computing the earthwork from the data given on the plan; (1) by computing directly the amount of cut or fill between successive contours, (2) by

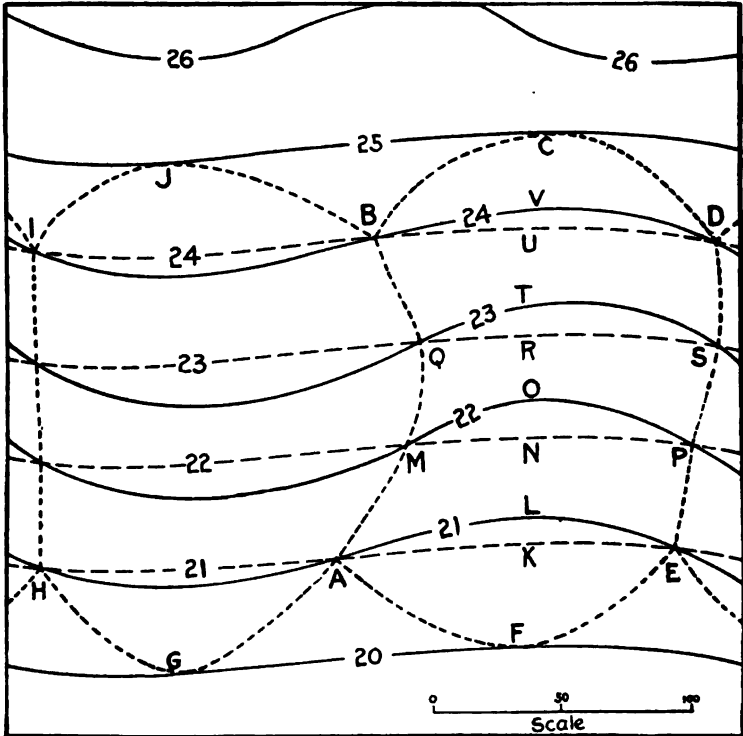

FIG. 156.

assuming a horizontal plane below the lowest part of the earthwork and computing the volume of the earth between this plane and the original surface, then computing the volume between the same plane and the finished surface; the difference between these two volumes will be the amount of earthwork, or (3) by drawing on the plan a line of no cut or fill, a line representing,

say, 5 ft. cut or fill, a line representing 10 ft. cut or fill and so on. Then compute the volume between these successive 5-ft. layers.

379. (1) Referring to Fig. 154 and applying the first method, the volume of the solid *AMPE* is that of a solid having two parallel end planes *AKEL* (a plane at elevation 21) being the lower, and *MNPO* (a plane at elevation 22) being the upper plane. The altitude between these two end planes will be the difference in elevation between 21 and 22, or will be 1 ft.

The areas of the horizontal planes *AKEL*, *MNPO*, *QRST*, and *BUDV* may be obtained by planimeter (Art. 370, p. 339) or otherwise, and the volume of the solid *AKEL-MNPO* may be obtained by the End Area Method (Art. 375, p. 344), its altitude being 1 ft. If it is desired to obtain the volume by the use of the Prismoidal Formula the volume of the solid *AKEL-QRST* may be found by using *AKEL* as one base, *QRST* as the other, and *MNOP* as the middle area, the altitude, or length, of the solid being the difference between 21 and 23, or 2 ft. The solid *AKEL-F* may be considered to be a pyramid with a base *AKEL* and an altitude equal to the vertical distance between the contour 21 and the point *F* which is in this case on contour 20, or a vertical distance here of 1 ft.

EXAMPLE.

In Fig. 154 the amount of fill on the area *ABCDEF* is computed below.

Area <i>AELF</i> = 900 sq. ft.	$900 \times \frac{1}{3} = 300$ cu. ft. (Pyramid)
" <i>MNPO</i> = 1000	$\frac{900 + 1000}{2} \times 1 = 950$.
" <i>QRST</i> = 1020	$\frac{1000 + 1020}{2} \times 1 = 1010$.
" <i>BUDV</i> = 680	$\frac{1020 + 680}{2} \times 1 = 850$.
	$680 \times \frac{1}{3} = 230$. (Pyramid)
	<u>3)3340.</u> cu. ft.
	<u>9)1113</u>
	124. cu. yds. Total Fill.

380. (2) Referring again to Fig. 156 and applying the second method, the area of *ABCDEF* is found (by planimeter); this is the area of a plane at, say, elevation 20, since none of the fill

extends below contour 20. Then the area of $ABCDEL$ is found, which is the area of the plane cutting the original ground at elevation 21. Similarly the areas of $MBCDPO$, $QBCDST$, and $BCDV$ are found. The volume of the solids between these planes may be computed by the End Area Method or by use of the Prismoidal Formula, in which case every other contour plane is used as a middle area as explained in the preceding paragraph. The volume of solid whose base is $BCDV$ is a pyramid whose altitude is the vertical distance between the 24-ft. contour and point C , which in this case is 1 ft.

By the same general method the areas of $ABCDEK$, $MBCDPN$, etc., which refer to the new surface of the ground, may be obtained, and the volume of the solids between successive contour planes computed. The difference between this quantity and the quantity between a plane at elevation 20 and the original surface will give the amount of fill.

While in this particular problem the first method is the shorter, still there are cases where the second method will be somewhat simpler. It is particularly useful when the actual amount of cut or fill is not desired but when it is required to know if the proposed alterations will require more or less earth than can be easily obtained on the premises and, if so, about how much the excess will be. In this case the portions of cut and fill will not have to be computed separately. A line is drawn around the limits of the entire area where the grading is to be done, the volume between an assumed plane and the original surface is found, and then the volume between the same plane and the proposed surface. The difference between the two values will give the amount of excess of earthwork.

381. (3) Fig. 157 illustrates a third method of computing earthwork from the data given on a topographic map. The original contours are shown in full lines and the contours of the proposed surface in dash lines. Through the intersection of the new contours with the original ones is drawn the line of "no cut" (zero line), the line where the cut is just 5 ft. (marked 5), the line of 10 ft. cut (marked 10), etc. These dotted curves enclose areas which are the horizontal projections of irregular surfaces which are parallel to the final surface and at 5 ft., 10 ft.,

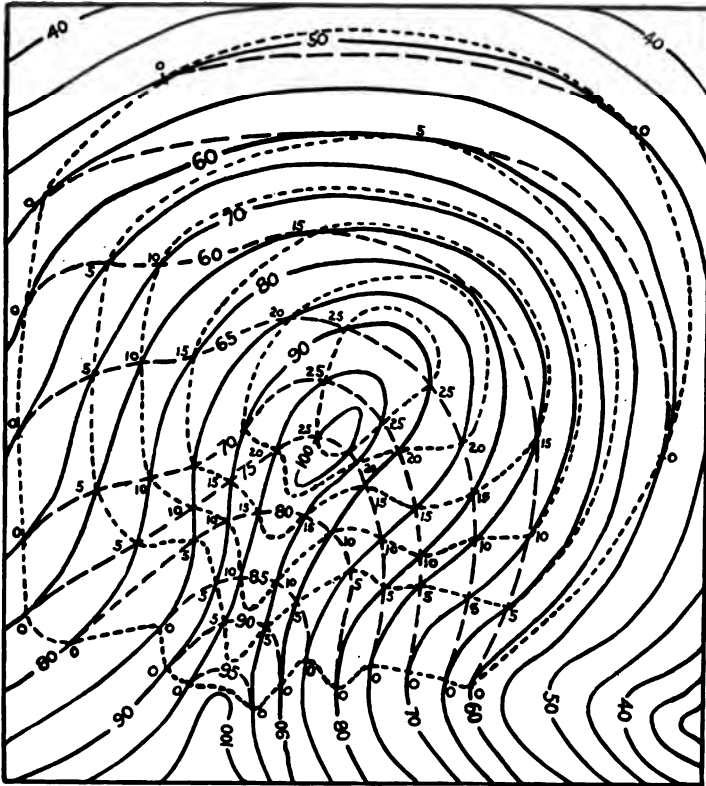

FIG. 167.

15 ft., etc., above the final surface. The solids included between these 5 ft. irregular surfaces are layers of earth each 5 ft. thick, and their volumes may be computed by either the End Area Method or by the Prismoidal Formula as explained in the preceding methods. The areas of these horizontal projections are obtained from the map and the vertical dimensions of the solids are the contour intervals.

382. ROUGH ESTIMATES. — Rough estimates of the quantity of earthwork are often required for preliminary estimates of the cost of construction or for monthly estimates of the amount of work done. For preliminary estimates of road construction, very

frequently the notes of alignment and the profile of the center line are the only information at hand. From this profile the center cuts or fills can be obtained, and the cross-sections can be assumed to be level sections (Art. 232, p. 209) and computed by the End Area Method. The slight errors resulting will be corrected in the final estimate.

In obtaining the required data from which to make an approximate estimate of the quantity of earthwork, the engineer has an opportunity to exercise his judgment to an unusual degree. Rough estimates do not, as a rule, call for a large amount of field-work. It is important that as few measurements as possible should be taken and that these should also be at the proper places to give complete data and to allow simple computations. Too often engineers, as soon as they arrive on the work and before making a study of their problems, begin to take measurements, consequently they return to the office after hours of hard work with a mass of figures from which it will take several more hours to compute the quantities. Whereas, a few moments' thought given to the choosing of the proper measurements to be taken in the field would give data which could be computed in a few moments by use of the slide rule, affording results sufficiently accurate for rough estimates.

PROBLEMS.

1. A series of perpendicular offsets are taken from a straight line to a curved boundary line. The offsets are 15 ft. apart and were taken in the following order: 6.8, 7.2, 4.6, 5.7, 7.1, 6.3, and 6.8.

(a) Find the area between the straight and curved lines by the Trapezoidal Rule.

(b) Find the same area by Simpson's One-Third Rule.

2. It is desired to substitute for a curved boundary line a straight line which shall part off the same areas as the curved line. A trial straight line AB has been run; its bearing is $S 10^{\circ} 15' W$, its length is 418.5 ft., and point B is on a boundary line CD which has a bearing $S 80^{\circ} W$. The sum of the areas between the trial line and the crooked boundary on the easterly side is 2657. ft.; on the westerly side it is 7891. ft. It is required to determine the distance BX along CD such that AX shall be the straight boundary line desired. Also find the length of the line AX .

3. In the quadrilateral $ACBD$ the distances and angles which were taken in the field are as follows:

$$\begin{array}{ll} AB = 50.63 & \angle B = 105^\circ 39' 00'' \\ BC = 163.78 & \angle A = 89^\circ 37' 30'' \\ CD = 93.80 & \\ DA = 160.24 & \\ DB = 167.73 & \end{array}$$

Check the fieldwork by computations, and figure the area of the quadrilateral by using right triangles entirely.

4. Two street lines intersect at an angle (deflection angle) of $48^\circ 17' 30''$. The corner lot is rounded off by a circular curve of 40-ft. radius.

(a) Find the length of this curve to the nearest $\frac{1}{16}$ ft.

(b) Find the area of the land included between the curve and the two tangents to the curve (the two street lines produced).

5. Find the quantity in cubic yards, in the borrow-pit shown in Fig. 154; the squares are 25 ft. on a side, and the line ast is straight.

6. At station 6 a rectangular trench was measured and found to be 3 ft. wide and 4 ft. deep. At station 6+70 it was found to be 3.2 ft. wide and 8.6 ft. deep.

(a) Find by use of the Prismoidal Formula the quantity of earthwork between stations 6 and 6+70. Result in cubic yards.

(b) Find the volume of the same by End Area Method.

7. The following is a set of notes of the earthwork of a road embankment.

$$\begin{array}{r} 12 \quad \frac{27.0}{+ 8.0} \quad + 4.2 \quad \frac{23.4}{+ 5.6} \\ 11 + 60 \quad \frac{30.0}{+ 10.0} \quad \frac{15.0}{+ 4.5} \quad + 4.0 \quad \frac{15.0}{+ 7.5} \quad \frac{24.0}{+ 6.0} \\ \text{Sta. 11} \quad \frac{21.0}{+ 4.0} \quad + 6.0 \quad \frac{25.8}{+ 7.2} \end{array}$$

The base of the road is 30 ft. and the slopes are $1\frac{1}{2}$ to 1. Find by the End Area Method the quantity of earthwork from Sta. 11 to 12. Result in cubic yards.

CHAPTER XIII.

AREA BY DOUBLE MERIDIAN DISTANCES.—COÖRDINATES.

383. COMPUTATION OF AREA. — The computation of the area of any piece of property which has been surveyed as a traverse will in general consist of (1) the computation of the area enclosed by the traverse and (2), where the traverse does not follow the property line, the computation of fractional areas to be added to or subtracted from the area of the traverse as the case may be.

384. COMPUTATION OF AREA BY DOUBLE MERIDIAN DISTANCE METHOD. — In the field notes the length and the bearing of each line of the traverse are recorded. To obtain the area enclosed the points of the survey are referred to a system of rectangular coördinates. In Fig. 158 the coördinate axes chosen are the magnetic meridian through the most westerly point F , and a line through F at right angles to the meridian. In compass surveys it is convenient to use the magnetic meridian for one of the axes; in transit surveys the true meridian is often used when its direction is known, but any arbitrary line may be used as an axis and some convenience results from choosing one of the lines of the survey as one of the axes.

In computing the area, first find the length of the projection of each line on each of the coördinate axes, or in other words, find the *northing* or *southing* and the *easting* or *westing* of each line, or *course*, of the traverse. The projection of any line on the meridian is called its *difference of latitude* or simply its *latitude*. The projection of a line on the other axis is called its *difference of departure*, or simply its *departure*.* In Fig. 158 the latitude of FA is Fq ; the departure of FA is qA . The latitude and departure of each course are computed by solving the right triangle formed by drawing lines through the extremities of this course

* Some authors use the terms *latitude difference* and *longitude difference*.

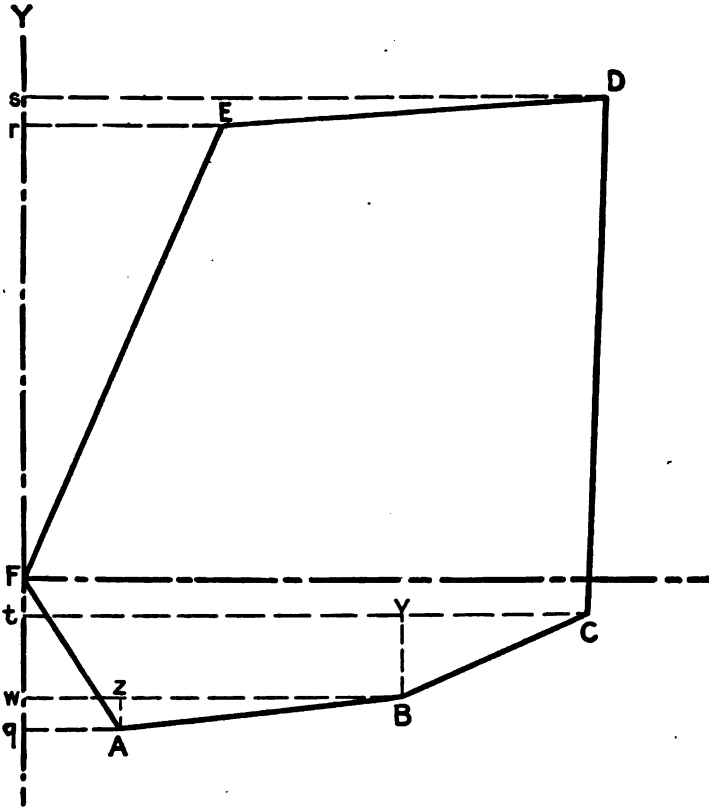

FIG. 158.

and parallel to the coordinate axes. It is evident from the figure that

$$\text{Latitude} = \text{Distance} \times \cos \text{Bearing.}$$

and

$$\text{Departure} = \text{Distance} \times \sin \text{Bearing.}$$

Latitudes are called *North* or *South* and departures *East* or *West*, depending upon the direction of the course as shown by its letters, e.g., if the bearing is N 30° E this course has a North latitude and an East departure. North latitudes and East departures are considered as *positive* (+), South latitudes and West departures

as *negative* (—). In the figure the courses are assumed to run from *F* to *A*, from *A* to *B*, etc.

385. After all of the latitudes and departures have been computed (supposing for the present that the traverse is a closed

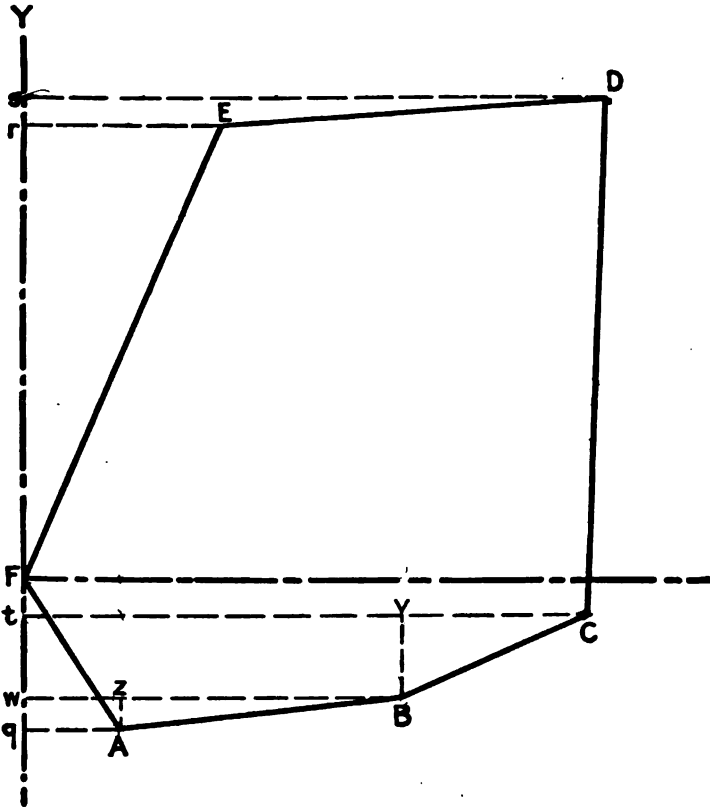

FIG. 158

figure) proceed to find the areas of all the trapezoids or triangles, such as *DErs*, *EFr*, etc., formed by (1) the courses, (2) their projections on the meridian, and (3) the perpendiculars

from the extremities of the courses to the meridian. It is evident in the figure shown that the area of the field is equal to

$$(AB\ wq + BC\ tw + CD\ st) - (DE\ rs + EF\ r + FA\ q),$$

that is, in this figure the sum of all the areas determined by lines running northward minus the sum of all the areas determined by lines running southward. These are known as *north areas* and *south areas*.* In computing the areas of these trapezoids it is convenient as well as customary to find the *double areas* and divide the final result by 2 instead of dividing by 2 in figuring each trapezoid. The area of any trapezoid equals the average distance of the extremities of the course from the meridian, multiplied by the length of the projection of the course on the meridian. This average distance of the ends of the line from the meridian is known as the *meridian distance* of the course, i.e., the meridian distance of the middle point of the course. In computing the double areas, twice this distance, or the *double meridian distance* (D.M.D.), is used, which is equal to the sum of the distances of the ends of the course from the meridian. In arranging the data for computing the double meridian distances, the courses must be tabulated in consecutive order around the traverse, whether they were so taken in the field or not. The D.M.D. of the course FA is qA which is the departure of the course FA . The D.M.D. of AB is $qA + wB = qA + qA + zB$, i.e., the D.M.D. of course FA + the dep. of FA + the dep. of AB . The D.M.D. of $BC = tC + wB = tw + vC + qA + zB = qA + wB + zB + vC = \text{D.M.D. of } AB + \text{dep. of } AB + \text{dep. of } BC$.

Hence the D.M.D. of all of the courses may be computed by the following rules:—

(1) The D.M.D. of the first course (starting from the primary meridian†) equals the departure of the course itself.

* If the traverse had been run around the field in the opposite direction these *north areas* would become *south areas*. The result would be the same, however, in either case since it is the algebraic sum of the areas which is obtained.

† Any meridian could have been chosen as the primary meridian, but negative signs are avoided if the most westerly point is chosen as the starting point.

(2) The D.M.D. of any other course equals the D.M.D. of the preceding course plus the departure of the preceding course plus the departure of the course itself.

(3) The D.M.D. of the last course should be numerically equal to its departure, but with opposite sign.

The double areas of all the trapezoids may now be found by simply multiplying the D.M.D. of each course by the latitude of the same course, North latitudes being regarded as *plus* and South latitudes as *minus*. The sum of all the north double areas minus the sum of all the south double areas equals twice the area of the field. Be careful to *divide by 2* after completing the other details of the computation.

386. COMPUTATION FOR AREA OF COMPASS SURVEY BY D.M.D. METHOD. — The details of the above are illustrated in Fig. 159, which is the computation of the area of the traverse given in the compass notes in Fig. 50, p. 100. It will be seen from a study of the notes that there was local attraction of $\frac{1}{2}^\circ$ at station *B*, and that in the following computations the corrected bearings are used (Art. 41, p. 30).

In Fig. 159 the bearings, distances, latitudes, departures, and D.M.D.'s, which are recorded on a line with station *F* are those corresponding to the course *FA*; those recorded on a line with station *A* refer to the course *AB*; etc. After the bearings and distances are entered in the table the places which are to be blank in the remaining columns are cancelled as shown; this is a check against putting the results of the computations in the wrong spaces. In computing the latitudes and departures the *log distance* is first entered; the *log sin bearing* is written below this and the *log cos bearing* is recorded above. To obtain the *log latitude* add the upper two logarithms; to obtain the *log departure* add the lower two logarithms. When the latitude and departure of a course have been obtained see if the results appear to be consistent with the given bearing and distance; when the bearing of a course, for example, is less than 45° its latitude is greater than its departure and *vice versa*.

387. Balancing a Chain and Compass Traverse. — Before the D.M.D. method can be properly applied the errors of measurement of the traverse should be so distributed that the figure becomes a closed polygon. If the field is a closed polygon the sum of the north latitudes will equal the sum of the south latitudes, and the sum of the east departures will equal the sum of the west departures. As soon as the latitudes and departures are computed this test is applied. If the sums differ, the error is distributed in such a way as to make the sums exactly equal, and at the same time to give to each latitude and departure its most probable value. In the case of a compass survey the errors are fully as likely to be in the bearings, which have been read to the nearest quarter of a degree, as in the distances; hence if nothing definite is known in regard to the errors they are assumed to be proportional to the lengths of the lines and the survey is balanced by the following rule which alters not only the length of the lines but also their directions.

388. *The correction to be applied to the $\left\{ \begin{array}{l} \text{latitude} \\ \text{departure} \end{array} \right\}$ of any course is to the total error in $\left\{ \begin{array}{l} \text{latitude} \\ \text{departure} \end{array} \right\}$ as the length of the course is to the perimeter of the field.*

This rule is based upon purely mathematical considerations and should be applied **only** when nothing is known as to where the errors probably occurred. Usually the surveyor knows where the error is probably greatest and consequently in balancing the survey he will place the largest corrections where, in his judgment, they belong. In measuring with the chain, the recorded distances tend always to be too **long**, because the sag, poor alignment, and poor plumbing, all serve to shorten the chain; consequently the probability is that the recorded measurements are too long, therefore in balancing it is more logical to subtract from the latitudes and departures in the columns whose sums are greater rather than to add anything to the latitudes and departures in the smaller columns. The corrections should of course be applied in such a way as to decrease the difference

between the two columns. In the example (Fig. 159) the total error in latitude is 0.08 and the total error in departure is 0.07. The perimeter of the traverse is 129.77. Hence the correction per chain-length is 0.062 links for latitudes, and 0.054 for departures. The corrected values of the latitudes and departures are given in the columns headed *balanced latitudes* and *balanced departures*.

389. From the balanced departures we then compute the D.M.D. of each course as shown in the next column. Observe that the last D.M.D. (point *F*), as computed from the preceding one, is exactly equal to the departure of the last course. This checks the computation of the D.M.D.'s. The D.M.D.'s are now multiplied by their corresponding latitudes and the products placed in the *double a ea* columns, those having N latitudes being placed in the column of north (+) double areas and those having S latitudes in the column of south (-) double areas. The sums of these columns differ by 2245.8. One-half of this, or, 1123, is the area of the field in square chains, which equals 112.3 acres.

By proceeding around the field in the reverse direction the letters of all of the bearings would be changed, in which case the column of south double areas would be the larger.

390. **Double Parallel Distance.** — There is no particular reason for using the trapezoids formed by projecting the courses on to the meridian rather than those formed by projecting them on to the other axis. In the latter case the *Double Parallel Distance* (*D.P.D.*) should be computed, and the result multiplied by the departure for each course.

In the D.M.D. method the computations have been checked at every step with the exception of the multiplication of the D.M.D.'s by the latitudes. A check on this part of the work can be obtained by figuring the area by use of the *D.P.D.*'s. This furnishes an example of a very desirable method of checking, as a different set of figures is used in computing the double areas, and the opportunity for repeating the same error is thus avoided. Fig. 160 shows the computation by the *D.P.D.* method of the area of the same survey as is calculated by the *D.M.D.* method in Fig. 159.

Sta.	Bearing	Dist. (chains)	Balanced		DPD.	Double Areas	
			Lat	Dep		+	—
A	East	17.79	+0.01	+17.78	+0.01	0.2	—
B	N58½E	13.58	+7.16	+11.54	+7.18	82.9	—
C	N1½E	32.42	+32.43	+0.83	+46.77	38.8	—
D	S85½W	23.80	-1.75	-23.74	+77.45	—	1838.7
E	S23½W	31.00	-28.41	-12.38	+47.29	—	585.5
F	S32½E	11.18	-9.44	+5.97	+9.44	56.4	—

<p>DPD's</p> <p>0.01</p> <p>0.01</p> <p><u>7.16</u></p> <p>7.18 B</p> <p><u>7.16</u></p> <p>32.43</p> <p><u>46.77 C</u></p> <p>32.43</p> <p><u>79.20</u></p> <p>1.75</p> <p><u>77.45 D</u></p> <p>30.16</p> <p><u>47.29</u></p> <p>37.85</p> <p><u>9.44 F Check</u></p>	<p>Areas</p> <p>A</p> <p>17.78</p> <p><u>0.01</u></p> <p>.2</p> <p>B</p> <p>11.54</p> <p><u>7.18</u></p> <p>92.32</p> <p><u>11.54</u></p> <p>8078</p> <p><u>82.9</u></p> <p>D</p> <p>77.45</p> <p><u>23.74</u></p> <p>50960</p> <p><u>542.15</u></p> <p>23235</p> <p><u>15490</u></p> <p>1838.7</p>	<p>C</p> <p>46.77</p> <p><u>0.83</u></p> <p>14031</p> <p><u>374.16</u></p> <p>38.8</p> <p>E</p> <p>47.29</p> <p><u>12.38</u></p> <p>37832</p> <p><u>14187</u></p> <p>9458</p> <p><u>4729</u></p> <p>585.5</p>	<p>178.3</p> <p>2424.2</p> <p><u>178.3</u></p> <p>2245.9</p> <p>1123.54 ch.</p> <p>112.3 Acres</p> <p>F</p> <p>5.97</p> <p><u>9.44</u></p> <p>2388</p> <p><u>2388</u></p> <p>5373</p> <p><u>56.4</u></p>
---	---	--	---

FIG. 160. AREA OF COMPASS SURVEY BY DOUBLE PARALLEL DISTANCES.

391. **Error of Closure.** — An indication of the accuracy of the survey is found in the *error of closure*. If a complete traverse of the field has been made the final point, as computed, should coincide with the first. The amount by which they fail to coincide is the total error of the survey and may be found by the formula

$$E = \sqrt{l^2 + d^2}$$

where *l* is the error in latitude and *d* is the error in departure. If this distance *E* is divided by the perimeter of the field the resulting fraction is called the *error of closure*, which in this survey is approximately $\frac{1}{1300}$ (see Art. 132, p. 99).

392. **COMPUTATION OF AREA OF A TRANSIT AND TAPE SURVEY.** — The field notes show the lengths of the sides of the traverse, all of the angles and perhaps the magnetic bear-

ings of some or all of the courses. If an observation has been made for determining the direction of the meridian, this affords the means of computing the true bearings of all of the traverse lines.

393. The first step in reducing the notes (provided it has not already been done in the field) is to see if the difference between the sum of the right and left deflection angles equals 360° . If interior angles have been measured, their sum should equal the number of sides of the field times two right angles, minus four right angles. If there is a small error in the sum of the angles this is usually adjusted by placing the error in the angles where it probably occurred. If nothing is known as to where it probably occurred the corrections should be made in the angles adjacent to the **short** lines, as any error in sighting or setting up the transit causes a greater angular error in a short line than in a long one.

The transit survey is referred to a system of rectangular coördinates, as in case of the compass survey. If the direction of the true meridian is known (either from a special observation or by connection with some other survey referred to the meridian), it is advisable to use this meridian as one of the coördinate axes. If the direction of the true meridian is not known the magnetic meridian may be used. This of course is convenient in some respects because the bearings taken in the field already refer to this meridian. If not even the magnetic meridian is known it will then be advisable to choose some line of the survey (preferably a long one) as the axis, for using one of the traverse lines as an axis saves computing the latitude and departure of one course.

Whatever line is chosen as an axis, the bearings used for computing the latitudes and departures are to be obtained from the **measured angles** (after correction), and **not** from the observed bearings. For instance, if some line is selected and its magnetic bearing used, then the bearings of all of the other lines should be computed from this one by means of the (corrected) transit angles. In this way the bearings are relatively as accurate as the transit angles, even though the whole survey may be referred to an erroneous meridian due to the error of the magnetic

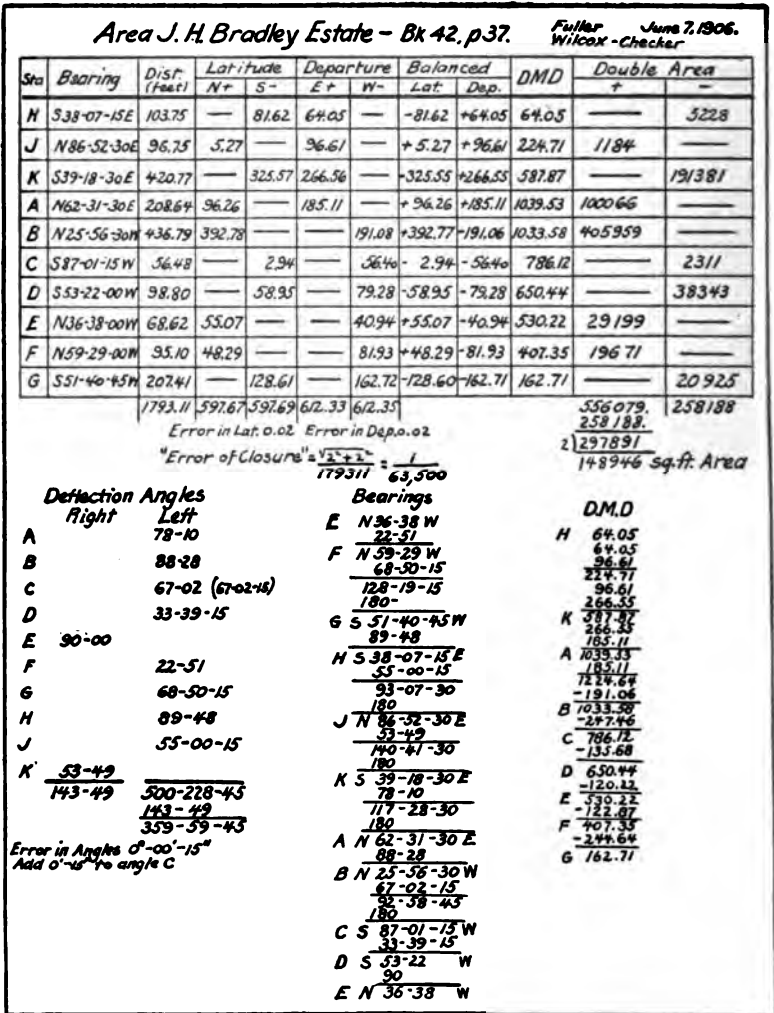

FIG. 161. AREA OF A TRANSIT AND TAPE SURVEY BY DOUBLE MERIDIAN DISTANCE METHOD.

(The remainder of the computations is in Fig. 161 A.)

Latitudes and Departures					
	M	J	K	A	B
Lat.	31.62	5.27	32.557	96.26	392.78
Log Lat.	<u>1.911803</u>	<u>0.72216</u>	<u>2.512645</u>	<u>1.983439</u>	<u>2.594197</u>
Log Cos. Bear.	9.895813	8.73651	9.888600	9.664041	9.953876
Log Dist.	2.105988	1.98565	2.624046	2.319398	2.640273
Log Sin. Bear.	<u>9.790512</u>	<u>9.99935</u>	<u>9.801742</u>	<u>9.998027</u>	<u>9.640934</u>
Log Dep.	1.806500	1.98500	2.425787	2.267425	2.281207
Dep	64.05	96.61	266.56	185.11	191.08
	C	D	E	F	G
Lat.	2.94	58.95	55.07	48.29	128.61
Log Lat.	<u>0.46767</u>	<u>1.77051</u>	<u>1.74088</u>	<u>1.68386</u>	<u>2.109267</u>
Log Cos. Bear.	8.71578	9.77575	9.90443	9.70568	9.792437
Log Dist.	1.75189	1.99476	1.83645	1.97818	2.316830
Log Sin. Bear.	<u>9.99941</u>	<u>9.90443</u>	<u>9.77575</u>	<u>9.93525</u>	<u>9.899621</u>
Log Dep.	1.75130	1.89919	1.61220	1.91343	2.211451
Dep	56.40	79.28	40.44	81.93	162.72
Double Areas					
	H	J	K	A	B
Log DMD	1.80650	2.35162	2.769281	3.016837	3.014344
Log Lat.	<u>1.91180</u>	<u>0.72181</u>	<u>2.512618</u>	<u>1.983446</u>	<u>2.594158</u>
Log Area	3.71830	<u>3.07343</u>	5.281899	5.000283	5.608482
Area	5228	1187	191381	100066	405959
	C	D	E	F	G
Log DMD	2.89549	2.813207	2.724456	2.609968	2.211414
Log Lat.	<u>0.46835</u>	<u>1.770484</u>	<u>1.740915</u>	<u>1.683857</u>	<u>2.109246</u>
Log Area	3.36384	<u>4.583691</u>	<u>4.465371</u>	<u>4.293825</u>	<u>4.320660</u>
Area	2311	38343	29199	19671	20925

161 A.

(These computations go with Fig. 161.)

bearing of the first line. In calculating these bearings the work should be checked by computing the bearing of each line from that preceding, the bearing of the last line being followed by the calculation of a new bearing of the first line of the traverse which must agree with the magnetic bearing assumed for it, provided the deflection angles have been adjusted so that their algebraic sum is 360°. The observed magnetic bearings of the different courses will serve as a check against large mistakes in this calculation.

394. When all of the bearings have been figured the latitudes and departures are to be computed. In good transit surveys five places in the trigonometric functions will usually be necessary. If the angles are measured, by repetition, to a small fraction of a minute, seven-place logarithmic tables may profitably be em-

ployed; as much interpolation is avoided by their use, but the logarithm; need not be taken out to more than five or six places. Seven places, of course, are more than are necessary so far as precision is concerned (Art. 351, p. 324).

The computation of the latitudes and departures may be conveniently arranged as shown in Fig. 161 which is the computation of the survey in Fig. 52, p. 103. After the latitudes and departures have been calculated they are arranged in tabular form. The columns of latitudes and the columns of departures are added and compared just as in a compass survey.

395. Balancing a Transit and Tape Traverse. — In adjusting (balancing) a transit traverse a different rule is used from the one given in Art. 388. In the case of a transit survey the error is chiefly in the measurement of distances, as it is much easier to secure accurate results in the angular work than in the tape measurements. Hence the following rule for balancing the survey is applicable: —

The correction to be applied to the $\left\{ \begin{array}{l} \text{latitude} \\ \text{departure} \end{array} \right\}$ of any course is to the total error in $\left\{ \begin{array}{l} \text{latitude} \\ \text{departure} \end{array} \right\}$ as the $\left\{ \begin{array}{l} \text{latitude} \\ \text{departure} \end{array} \right\}$ of that course is to the sum of all of the latitudes (without regard to algebraic sign).

As in the case of a compass survey, the surveyor's knowledge of the circumstances should always take precedence over the rule, and it is probably more nearly correct to shorten the latitudes or departures in the larger columns than to lengthen them in the smaller columns. This is because distances are usually recorded longer than they actually are; the only cases where the distance is probably too short is when an excessive pull has been given to the tape or a mistake made in measurement. It will be observed in the original notes (Fig. 52, p. 103) that the distances *BC*, *GH*, and *KA* were all questioned, i.e., they were measured under such conditions that it is probable that there may be one or two hundredths error in them. In balancing the latitudes and departures then, this information is used. In Fig. 161 it will be seen that in balancing the survey the latitudes and departures

of these questioned measurements have been changed in such a way as to reduce the length of *BC*, *GH*, and *KA* each one hundredth of a foot.

In balancing the angles, in which there was an error of 15 seconds, it will be noticed that the correction for this error, being small, was put into one angle, that at *C*, one of whose sides is the shortest line in the traverse. The area is computed as explained in Art. 385, p. 354.

396. Fractional Areas. — Fig. 162 is the computation of the

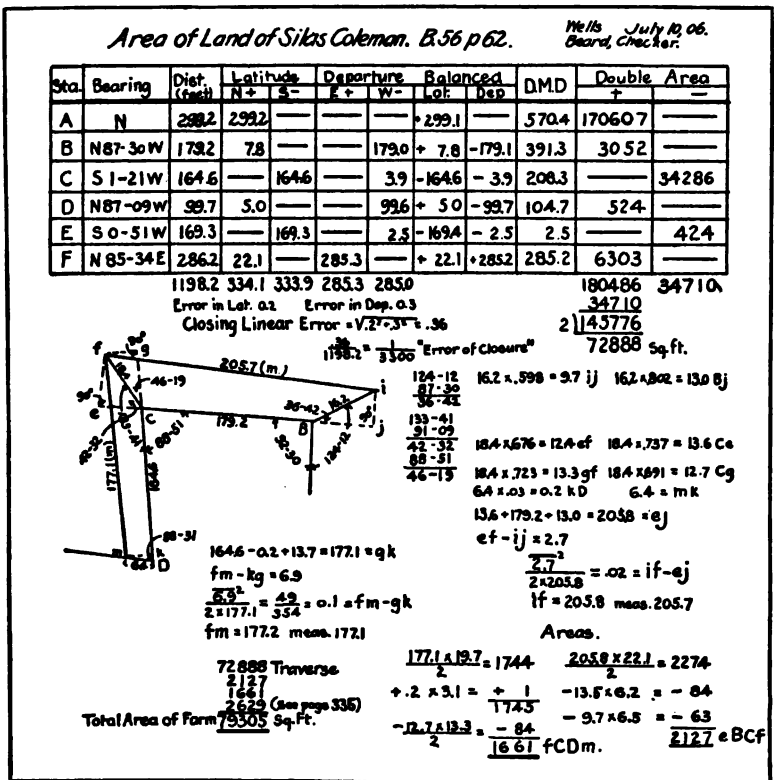

FIG. 162. COMPUTATION OF TRANSIT AND TAPE SURVEY, INCLUDING FRACTIONAL AREA.

survey shown in Fig. 53, p. 104. The traverse was run with a transit and tape, the angles being measured to the nearest minute

and the sides to tenths of a foot. Nothing appears in the field notes to indicate that any of the lines were difficult to measure, so it is assumed that any errors in measurement are as likely to occur in one line as another. Therefore, in balancing the latitudes and departures of this survey, the rule given in Art. 395 is applied. In balancing the angles, in which there was an error of 1 minute, the entire error was placed in the angle at D where the side DE is short in comparison with the other sides.

It will be noticed that the distances which appear on the sketches in the computation are slightly different from those which appear in the field notes (Fig. 53); this is due to the fact that the distances have been corrected for erroneous length of tape before undertaking to calculate the area. The intermediate steps in the computation of this traverse do not appear in Fig. 162, but they are the same as in the last traverse. The D.M.D.'s were computed from F , the most westerly point. The computation of the fractional areas is also given.

397. SUPPLYING MISSING DATA. — If any two of the bearings or distances are omitted in the traverse of a field the missing data can be supplied and the area obtained by computations based on the measurements taken. As has been shown in Art. 387, p. 358, the algebraic sum of all the latitudes in a closed survey must equal zero, and the algebraic sum of all the departures must equal zero; or, put it in the form of an equation,

$$\begin{aligned} Z_1 \cos A + Z_2 \cos B + Z_3 \cos C + \text{etc.} &= 0 \\ Z_1 \sin A + Z_2 \sin B + Z_3 \sin C + \text{etc.} &= 0 \end{aligned}$$

where $Z_1, Z_2, Z_3, \text{etc.}$, are the lengths of the corresponding courses. Therefore from these two equations any two unknown values in them can be computed.

The missing data could be any of the following combinations: —

- (1) The bearing and length of a line.
- (2) The length of a line and the bearing of another line.
- (3) The length of two lines.
- (4) The bearings of two lines.

398. Case (1) where the bearing and length of a line are missing is by far the most common. Its solution is also more direct than that of the other cases.

If the latitudes and departures of all of the measured sides are calculated, the sum of N and S latitudes will be found to differ, and the amount by which they differ is the latitude of the omitted side **plus** or **minus** the errors of latitudes. Similarly the amount by which the E and W departures differ is the departure of the course omitted **plus** or **minus** the errors of departures. From the latitude and departure of a course its length and bearing may be readily found.

A practical application of this case is found in the problems of subdividing a field by a line running from one known point to another, the direction and length of the dividing line not having been measured. The area of the portion cut off by this line can readily be computed by the above method. In case the angles were taken with the transit, the bearing of one line would be assumed to be correct and all other bearings computed to correspond.

It is evident from the above that in supplying missing data the observed measurements must be assumed to be correct, as there is no way of proving this from the computations. For this reason it is never advisable, when it can possibly be avoided, to supply missing data derived from computations on which a field check has not been obtained.

399. The solutions of the other three cases of missing data are not so simple, as they involve the use of simultaneous equations; they will not be discussed here.

400. Besides the four cases mentioned above there are some special cases which are capable of solution. In Fig. 163 the

lines and angles measured are shown by full lines. The bearing of AB is given. Here one side and two angles are missing. The solution is as follows. In the triangle EAB find EB , EBA , and AEB . In the triangle EDC find EC , DCE , and DEC . Then in the triangle EBC , in which EC ,

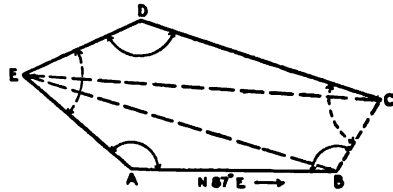

FIG. 163.

EB , and EBC are known, find ECB , CEB , and BC . All the angles and sides are then known. Other special cases may be solved in a similar manner.

401. DETECTING MISTAKES. — Mistakes in fieldwork may often be detected by means of the calculations. One of the easiest mistakes to make in surveying is to omit a whole tape-length in counting. If such a mistake were made and the latitudes and departures were computed, the linear error of closure of the survey would prove to be about a tape-length. In order to find in which line this mistake probably occurred compute the bearing of this linear error of closure and examine the traverse to find a line having a bearing the same or nearly the same. The error in departure divided by the error in latitude equals the **tangent of the bearing of the line** which represents the error of closure of the traverse. The errors of the survey, of course, will prevent these bearings from agreeing exactly. If two mistakes have been made it may be difficult and sometimes impossible to determine where they occurred. When an error of this sort is indicated by the computation the line should be re-measured. It is bad practice to change an observed measurement because it is found by calculation to disagree with other measured distances.

It may, and frequently does, happen that there is more than one line in the traverse which has about the same bearing. In such a case it is impossible to tell in which of these lines the mistake occurred. But if a cut-off line is measured as was suggested in Art. 145, p. 109, and one portion of the survey balances, the other part will contain the mistake. By proceeding in this way the number of lines in which the mistake could occur is reduced so that its location can be determined and checked by field measurement.

402. THE SUBDIVISION OF LAND. — There are a great many different problems which may arise in the subdivision of land and which may be solved simply by the application of the principles of trigonometry. A few of these problems are so common and so frequently involved in the working out of more complicated cases that their solution will be given.

403. To Cut Off from a Traverse a Given Area by a Straight Line starting from a Known Point on the Traverse. — In Fig. 164, $ABCDE$ represents the traverse which has been plotted and whose area has been computed.

It is desired to cut off a cert. in area by a line running from F which is at a known distance from A or E . The line FG' is drawn on the plan so as to make the area $FG'DE$ approximately equal to the desired area. The line DG' is scaled off and the scaled distance used as a trial length. Then the side FG' and its bearing can be found by the method explained in Art. 398, p. 367, and the area $FEDG'$ computed in the usual manner. The difference between the required area and the area of $FEDG'$ is the amount to be added to or subtracted from $FEDG'$.

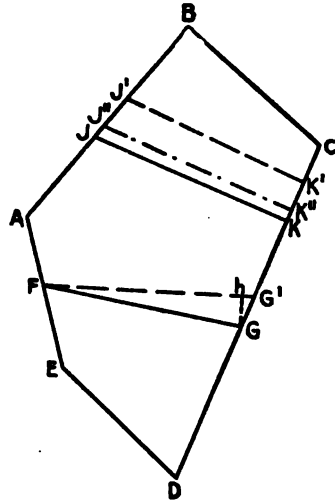

FIG. 164.

If this correction area is a minus area then the triangle $FG'G$ will represent it. In this triangle the base FG' and its area being known the altitude hG and the distances GG' and FG can be readily computed. In the traverse $FGDE$, which is the required area, the length of the missing side FG and its bearing can be supplied.

Instead of using the trial line FG' the line FD might have been first assumed and the correction triangle would then be FDG . This method has the advantage of containing one less side in the first trial area, but the correction triangle is large, whereas in the method explained above the correction triangle is small which may be of advantage in that part of the computation.

404. To Cut Off from a Traverse a Given Area by a Line running in a Given Direction. — In Fig. 164, $ABCDE$ represents a closed traverse from which is to be cut off a given area by a line running at a given angle (BJK) with AB . On the plot of the

traverse draw the line $J'K'$ in the given direction cutting off $J'BCK'$ which is, as nearly as can be judged, the required area. Scale the distance BJ' and use this trial distance in the computations. Then compute the distance $J'K'$ and the area of $J'BCK'$ either by the method of Art. 398, p. 367, or by dividing $J'BCK'$ into two oblique triangles. The difference between

this area and the required area is then found, which is a correction trapezoid to be added to or subtracted from $J'BCK'$. In this case it will be assumed that it is to be added to $J'BCK'$.

In this correction trapezoid the area and one base $J'K'$ are known; also the base angles, J' and K' . From these data an approximate value for the altitude of the trapezoid can be obtained and the length of the other base $K''J''$ of the trapezoid computed from this altitude and the length of $J'K'$. Then the area of this trapezoid $J'K'K''J''$ can be accurately determined;

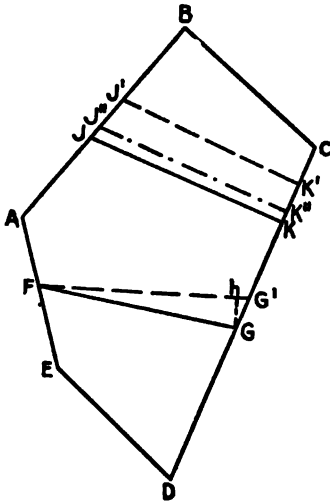

FIG. 164.

the difference between this and the required correction will be small and the dimensions of the second correction trapezoid $J''K''K'J'$ can probably be readily computed from its area and the length of $J''K''$ which are known. By successive trials, probably not more than two, the correct line JK can be found. If lines AB and CD are approximately parallel the trapezoid is nearly a parallelogram and its correct altitude can then be quickly determined.

405. To Find the Area Cut Off from a Traverse by a Line running in a Given Direction from a Given Point in the Traverse.
 — This problem may be readily solved by drawing a line from the given point in the traverse to the corner which lies nearest the other extremity of the cut-off line. The area of the traverse thus formed is then computed, and this area corrected by means of a correction triangle.

In Fig. 165, $ABCDEF$ represents a plot of a field. It is desired to run the line from E in a given direction EH and to compute the area $HEFGAB$ cut off by this line. The latitude and departure of points B and E being known the bearing and length of BE and the area of $ABEFG$ can be computed. Then the area and the remaining sides of the triangle BEH can be obtained from BE and the angles at B and E .

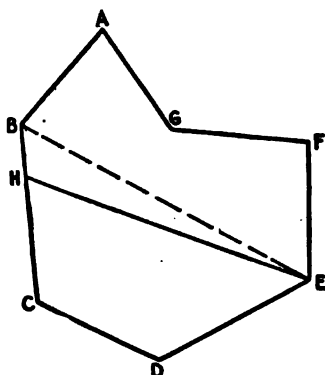

FIG. 165.

It is obvious that the solution of such problems as these is greatly facilitated by plotting the traverse before attempting the computations.

CALCULATIONS RELATING TO TRAVERSES WHICH DO NOT CLOSE.

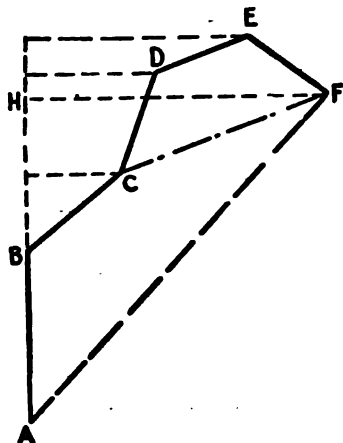

FIG. 166.

406. TO CALCULATE THE TOTAL DISTANCE BETWEEN END POINTS. — Fig. 166 represents the traverse $ABCDEF$ in which the distance AF and the angle BAF are desired. AB can be assumed as one of a pair of rectangular coordinate axes and the coordinates of point F (AH and HF) computed by the method explained in Art. 41c, p. 373. AF and the angle BAF can then be easily found. This method is of service in checking traverse plots of this type.

407. CUT-OFF LINES. — The calculation of cut-off lines, like the line CF in Fig. 166, is the same problem as was explained in Art. 398, p. 367. The angles DCF and EFC have been measured in the field and the traverse $CDEF$ is thus complete except that the length of the line CF is unknown. The length of CF and the angle it makes with AB can be readily computed since the coordinates of C and F can be found.

408. COMPUTATION OF AZIMUTHS WHEN CHECKING ANGLES TO A DISTANT OBJECT. — In this kind of problem the coördinates of all the points along the traverse can be computed with reference to some coördinate axes. At *A* and *B* (Fig. 167) angles have been taken to *S*, and from these angles the coördinates of point *S*, referred to *AB* and a line perpendicular to *AB* as axes, can be computed (Art. 410, p. 373). Co-

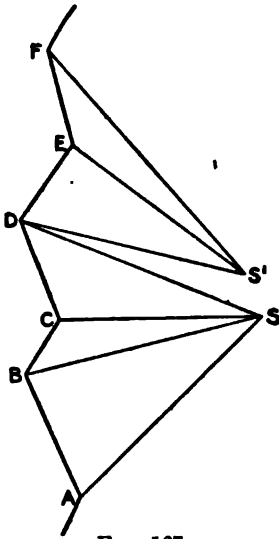

FIG. 167.

ordinates of *S* referred to the same axes should have the same value when figured from *BC* as a base as when calculated from the base *CD* and so on. If, however, when computed by means of angles at *D* and *E*, the point falls at *S'*, and angles *E* and *F* give its location also at *S'* there is evidence of a mistake in the traverse at *D*. If the two locations of *S* and *S'* are such that a line between them is parallel to either *CD* or *DE*, the mistake was probably made in the measurement of the line parallel to *SS'* and the distance *SS'* should be approximately equal to the amount of the mistake in measurement. If, however, *SS'* is not parallel to either *CD* or *DE* the mistake probably lies in the angle at *D*.

409. CALCULATION OF TRIANGULATION. — In a triangulation system the base-line is the only line whose length is known at the start. The sides of any triangle are found from the law of sines, i. e.,

$$\frac{\sin A}{\sin B} = \frac{a}{b}$$

$$\frac{\sin A}{\sin C} = \frac{a}{c}$$

$$\frac{a \sin B}{\sin A} = b$$

$$\frac{a \sin C}{\sin A} = c$$

Assuming a to be the base and the angles A , B , and C to have been measured the calculations are arranged as follows:

$$\begin{array}{rcl}
 (1) \log a \text{ (1400.74)} & = & 3.1463575 \\
 (2) \text{Colog Sin } A \text{ (57}^\circ 42' 16'') & = & 0.0729874 \\
 (3) \log \text{Sin } B \text{ (61}^\circ 17' 53'') & = & 9.9430639 \\
 (4) \log \text{Sin } C \text{ (60}^\circ 59' 51'') & = & 9.9418088 \\
 \hline
 \text{Sum of (1) (2) (3) } \log b & = & 3.1624088 \\
 \text{Sum of (1) (2) (4) } \log c & = & 3.1611537
 \end{array}$$

410. COÖRDINATES. — In many cities the coördinate system of surveying is used (see Chapter IX). In this system the position of each corner of the different lots is fixed by rectangular coördinates measured from two lines at right angles to each other.

Often the origin of coördinates O (Fig. 168) is so chosen that the whole city is in the first quadrant YOX . Distances measured parallel to XX' are usually called abscissas and those parallel to YY' ordinates.

The advantage of this system of surveying lies in the fact that since all surveys refer to the same reference lines, they are therefore tied to each other; and also in the fact that a lot can be relocated from the coördinates of

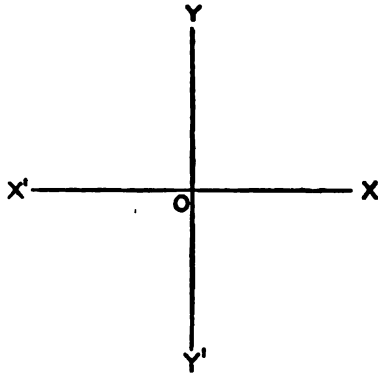

FIG. 168.

its corners even if all of the corner bounds have been destroyed.

Generally the coördinate lines run N and S, and E and W, but when city streets have been laid out at right angles to each other and not on N and S, and E and W lines, it may be more convenient to have the system of coördinates parallel to the street lines.

The coördinates of any unknown point are usually computed from the coördinates of some other point to which the unknown

point is tied by an angle and distance. The difference in coördinates between the known and unknown points will be obtained as follows:—

Difference in X = distance \times sin azimuth angle.

Difference in Y = distance \times cos azimuth angle.

Sometimes the unknown point is located by angles from two other known points, in which case the distance between the two points whose coördinates are known can be computed and then the distance from one of the known points to the unknown point. The problem is then in the form described in the previous paragraph.

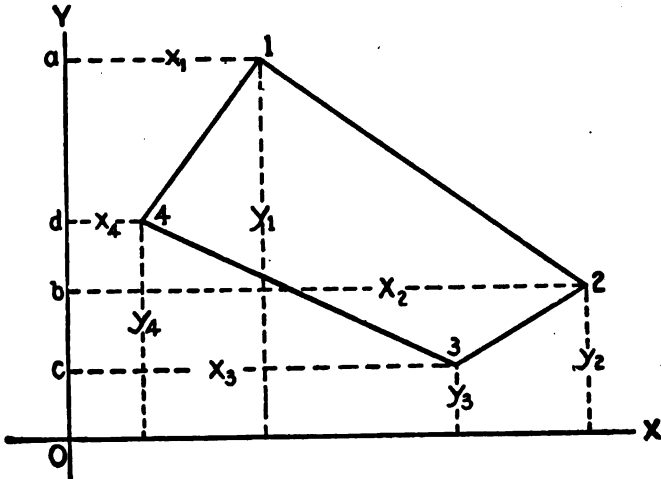

FIG. 169.

411. TO DETERMINE THE AREA OF A FIELD BY RECTANGULAR COÖRDINATES.— The area of the field 1, 2, 3, 4 (Fig. 169) is equal to the trapezoids

$$(a, 1, 2, b) + (b, 2, 3, c) - (a, 1, 4, d) - (d, 4, 3, c).$$

Expressed as an equation in terms of the coördinates the area is

$$1, 2, 3, 4 = (y_1 - y_2) \frac{x_1 + x_2}{2} + (y_2 - y_3) \frac{x_2 + x_3}{2} - (y_4 - y_3) \frac{x_4 + x_3}{2} - (y_1 - y_4) \frac{x_1 + x_4}{2} \quad (1)$$

$$= \frac{1}{2} \{ y_1 (x_2 - x_4) + y_2 (x_3 - x_1) + y_3 (x_4 - x_2) + y_4 (x_1 - x_3) \} \quad (2)$$

From this equation is derived the following rule for obtaining the area of a closed field from the coördinates of its corners:—

- (1) Number the corners consecutively around the field.
- (2) Multiply each $\left\{ \begin{matrix} \text{abscissa} \\ \text{ordinate} \end{matrix} \right\}$ by the difference between the

following and the preceding $\left\{ \begin{matrix} \text{ordinates} \\ \text{abscissas} \end{matrix} \right\}$, always subtracting the preceding from the following, and take one-half of the sum of the products.

412. Fig. 170 is the computation, by coördinates, of an area

Sta.	Bearing	Dist. (Chains)	Latitude		Departure		Balanced		X	Y	Diff bet Adjacent Ys	Double Area	
			N+	S-	E+	W-	Lat.	Dep.				+	-
0	N57°W	1.60	0.87	—	1.34	+0.87	-1.34	20.56	21.36	-5.36	—	110.2	—
1	S37°W	15.32	—	12.24	—	9.23	-12.23	-9.22	19.22	22.23	-11.36	218.3	—
2	S46½°E	4.53	—	3.11	3.28	—	-3.11	+3.28	10.00	10.00	+15.34	153.4	—
3	N43½°E	13.75	9.97	—	9.46	—	+9.98	+9.47	13.28	6.89	-6.87	—	91.2
4	N26°W	5.00	4.49	—	—	2.19	+4.49	-2.19	22.75	16.87	-4.47	—	329.2
											371.7	530.6	
												371.7	
											2	138.9	
												79.5	Sq. Ch.
												7.95	Acres.

FIG. 170. COMPUTATION OF COMPASS SURVEY BY COÖRDINATES.

from the field notes. The origin of coördinates is 10 chains W and 10 chains S of station 2.

413. Equation (1) may be developed into the following form:

$$1, 2, 3, 4 = \frac{1}{2} (x_2 y_1 - x_1 y_2 + x_3 y_2 - x_2 y_3 + x_4 y_3 - x_3 y_4 + x_1 y_4 - x_4 y_1) \quad (3)$$

When this formula is to be used the coördinates may be arranged in the following simple manner:

$$1, 2, 3, 4 = \frac{1}{2} \left(\frac{x_1}{y_1} \times \frac{x_2}{y_2} \times \frac{x_3}{y_3} \times \frac{x_4}{y_4} \dots \times \frac{x_1}{y_1} \right) \quad (4)$$

From equation (3) it will be seen that the area is equal to the sum of the products of the ordinates joined by full lines in (4) minus the sum of the products of the ordinates joined by broken lines. This formula involves the multiplications of larger numbers than in (2), but does not require any intermediate subtractions.

PROBLEMS.

1. The latitude of a line of a traverse is + 106.42 ft.; its departure is - 273.62. What is its bearing?

2. From the following notes of a compass survey, compute by the double meridian distance method the area in acres.

Station.	Bearing.	Distance (Chains).
<i>A</i>	N 46°½ W	20.76
<i>B</i>	N 51°¾ E	13.80
<i>C</i>	East	21.35
<i>D</i>	S 56° E	27.60
<i>E</i>	S 33°¼ W	18.80
<i>F</i>	N 74°½ W	30.8

3. In the following notes of a compass survey the length and bearing of one of the courses were omitted. Substitute the correct values and compute the area (in acres) by the double meridian distance method.

Station.	Bearing.	Distance (Chains).
1	S 40° W	17.50
2	N 45° W	22.25
3	N 36°¼ E	31.25
4	North	13.50
5	(omitted)	(omitted)
6	S 8°½ W	34.25
7	West	32.50

4. From the notes given in Fig. 52, p. 103, and Fig. 161, p. 362, compute by the double meridian distance method the area of the traverse *ABCDEK*.

5. In the following traverse there are two mistakes. Find where they occur and determine their amounts.

Station.	Observed Bearing.	Deflection Angle.	Distance (Feet).	Calculated Bearings.	Remarks.
<i>A</i>	N 34° E	164° 14' R	240.2	N 34° 00' E	<i>CE</i> = 188.1 <i>BCE</i> = 34° 14' <i>DEC</i> = 81° 25'
<i>B</i>	S 73° ½ E	62° 16' R	163.7		
<i>C</i>	S 10° ¼ W	84° 22' R	207.6		
<i>D</i>	N 26° ½ W	142° 49' R	273.1		
<i>E</i>	S 52° W	103° 41' L	147.4		

6. The following is a set of notes of an irregular boundary of a lot of land. It is desired to straighten this crooked boundary line by substituting a straight line running from *B* to the line *EF*. Find the bearing of the new boundary line and its length; also the distance along *EF* from point *E* to the point where the new line cuts *EF*.

Station.	Bearing.	Distance (Feet).
<i>A</i>	S 89° 14' E	373.62
<i>B</i>	N 13° 10' E	100.27
<i>C</i>	N 0° 17' W	91.26
<i>D</i>	N 27° 39' E	112.48
<i>E</i>	N 72° 12' W	346.07
<i>F</i>	S 5° 07' W etc.	272.42 etc.

7. (a) In the lot of land, *ABCD*, the lines *AB* and *DC* both have a bearing of N 23° E; the bearing of *AD* is due East; *AD* is 600 ft., *AB* is 272.7 ft., and *DC* is 484.6 ft. Find the length of a line *EF* parallel to *AB* which will cut off an area *ABFE* equal to half an acre. Also find the length of the lines *AE*, and *BF*. (b) What is the area of *EFCD*?

8. Given the notes of a traverse, which does not close, as follows:—

Station.	Deflection Angle.	
0		Find the length of a straight line from 0 to 20+64 and the angle it makes with the line from 0 to 6+40.
6 + 40	6° 17' L	
9 + 20	18° 43' L	
14 + 55	12° 47' R	
17 + 18	45° 24' L	
20 + 64	68° 06' R	

9. Compute the area of the following traverse by coordinates.

Station.	Deflection Angle.	Bearing.	Distance (Feet).
<i>A</i>	78° 10' 00" L		208.64
<i>B</i>	88° 28' 00" L		436.79
<i>C</i>	67° 02' 15" L		56.48
<i>D</i>	33° 39' 15" L		98.80
<i>E</i>	90° 00' 00" R		68.62
<i>F</i>	22° 51' 00" L		95.10
<i>G</i>	68° 50' 15" L	N 36° 14' 00" W	207.41
<i>H</i>	89° 48' 00" L		103.75
<i>I</i>	55° 00' 15" L		96.75
<i>J</i>	53° 49' 00" R		420.77

PART IV.

PLOTTING.

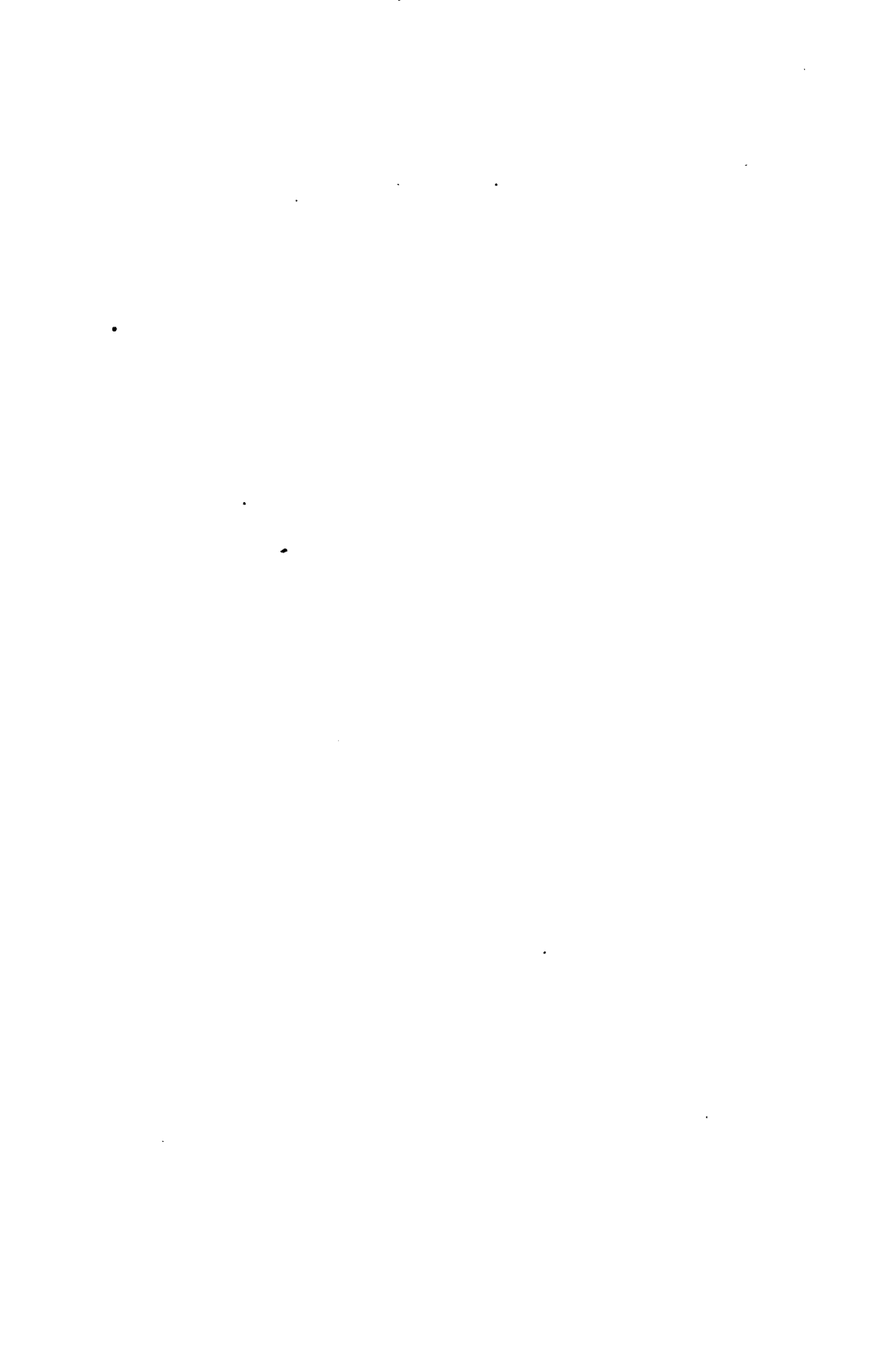

PART IV.

PLOTTING.

CHAPTER XIV.

DRAFTING INSTRUMENTS AND MATERIALS.

It is assumed in this section that the student is familiar with the ordinary drawing instruments such as the T-square, triangles, dividers, compasses, and scales, as well as with their use.

ENGINEERING DRAFTING INSTRUMENTS.

414. There are several drafting instruments which are used by engineers and surveyors but which are not so generally employed in other kinds of drafting work. The most common of these are briefly described in the following articles.

415. **STRAIGHT-EDGE.** — Engineering drawings are made with greater accuracy than much of the drafting work of other professions. In fact many engineering drawings are limited in precision only by the eyesight of the draftsman. It is evident, then, that to use a T-square which is run up and down the more or less uneven edge of a drawing board will not produce drawings of sufficient accuracy. For this reason in many classes of engineering work the edge of the drawing board is not relied upon. Furthermore, in most plots of surveying work the lines are not parallel or perpendicular to each other except by chance, but run at any angle which the notes require; and there is therefore not so much call for the use of a T-square as there is in architectural, machine, or structural drawings. All drawings are usually laid out starting from some straight line drawn on the paper by means of a straight-edge, which is simply a flat piece of steel or wood like the blade of a T-square. Steel straight-edges are more accurate and are more commonly used by engineering draftsmen than the wooden ones, the edges of which are likely to nick or warp and become untrue. They can be ob-

tained of almost any length and of any desired weight, the common length being about 3 feet.

416. ENGINEER'S SCALE. — Practically all engineering plans are made on a scale of 10, 20, 30, etc. feet to an inch. In the engineer's scale, therefore, the inch is divided into 10, 20, 30, etc. parts, instead of into eighths and sixteenths as in the architect's scale. Engineer's scales are made 3, 6, 12, 18, and 24 inches long. One form is the flat wooden rule with both edges beveled and a scale marked on each bevel. Some flat rules are beveled on both faces and on both edges of each face, thereby giving four scales on one rule. Still another very common form is the triangular scale, made of wood or metal, and having six different scales, one on each edge of the three faces. In such rules the scales are usually 20, 30, 40, 50, 60, and 80 ft. or 10, 20, 30, 40, 50, and 60 ft. to an inch. Scales are, however, often made having the inch divided into 100 parts, but in plotting a map which is on a scale of 100 ft. to an inch the work is probably more easily done by using a scale of 10, 20, or 50 divisions to an inch and estimating the fractional part of a division than by trying to plot with a 100-ft. scale which is so finely graduated as to be very hard to read without the aid of a magnifying glass. A 20-ft. or 50-ft. scale is more satisfactory for precision than a 10-ft. scale when it is desired to plot on a scale of 100 ft. to the inch. A plan on a 200-ft. scale is always plotted by using a 20-ft. scale, a 300-ft. plan by using a 30-ft. scale, etc.

A map covering considerable area, like the map of a state, for example, must be plotted to a very small scale, and this is usually given in the form of a ratio such as 1 to 500, 1 to 2500, etc., meaning that one unit on the map is $\frac{1}{500}$, $\frac{1}{2500}$, etc. of the corresponding distance on the ground; this is sometimes called the *natural* scale. For plotting such maps specially constructed scales with decimal subdivisions are used.

417. PROTRACTOR. — A *protractor* is a graduated arc made of metal, paper, celluloid, or horn, and is used in plotting angles. There are many varieties of protractor, most of them being either circular or semicircular.

418. Semicircular Protractor. — Probably the most common is the semicircular protractor which is usually divided into de-

degrees, half-degrees, and sometimes into quarter-degrees. Fig. 171 represents a semicircular protractor divided into degrees.

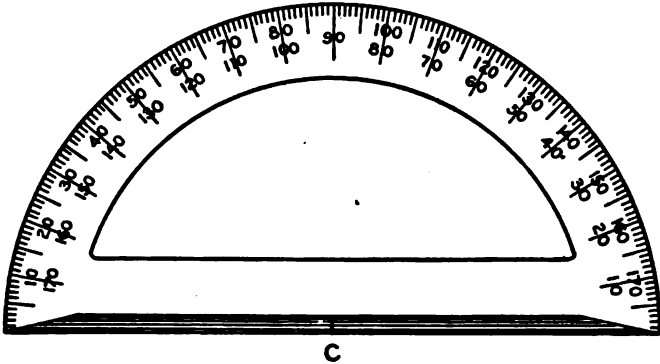

FIG. 171. SEMICIRCULAR PROTRACTOR.

In plotting an angle with this protractor the bottom line of the instrument is made to coincide with the line from which the angle is to be laid off, and the center of the protractor, point *C*, is made to coincide with the point on the line. On the outside of the arc a mark is made on the drawing at the desired reading. The protractor is then removed from the drawing and the line drawn on the plan.

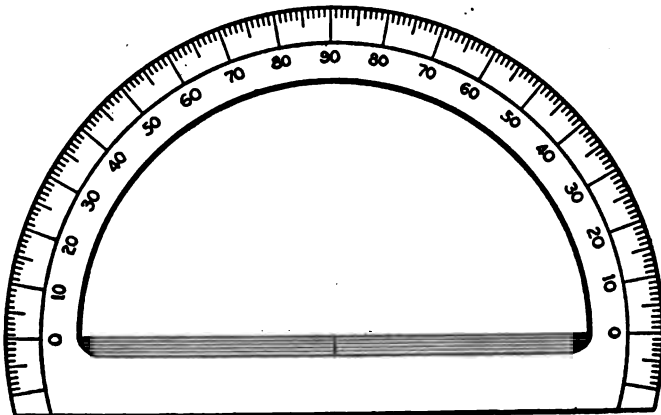

FIG. 172. SEMICIRCULAR PROTRACTOR.

Instead of having the 0° and 180° of the protractor on its lower edge some instruments are made as shown in Fig. 172.

This form is claimed by some draftsmen to be more convenient, because in handling the protractor by placing the fingers on the base neither the graduations nor the line on the plan are covered by the hand.

419. Full-Circle Protractor. — The full-circle protractor is of use particularly in stadia work or in plotting any notes where azimuth angles of over 180° have been taken. For such work as stadia plotting an ordinary paper protractor 8 to 12 inches in diameter is sufficiently accurate, and, in fact, paper protractors of this size will yield more accurate results than the smaller metal ones.

420. Some of the metal protractors are provided with an arm and vernier attachment. These, while giving more precise results, require more time for manipulation, and a plain metal protractor with a diameter of, say, 8 inches will give sufficiently close results for all ordinary work. As a matter of fact a protractor with a vernier reading to minutes can be set much closer than the line can be drawn, and it is therefore a waste of time to attempt to lay off the angles on a drawing with any such accuracy. There is, however, a protractor of this type with a vernier reading to about 5 minutes which may be of use in precise plotting.

421. Three-Armed Protractor. — The three-armed protractor is used for plotting two angles which have been taken with an instrument (usually a sextant) between three known points, for the purpose of locating the position of the observer (the vertex of the two angles). The protractor has three arms, the beveled edges of which are radial lines. The middle arm is fixed at the 0° mark and the other two arms, which are movable, can be laid off at any desired angle from the fixed arm by means of the graduations on the circle, which number each way from the fixed arm. The two movable arms having been set at the desired angles and clamped, the protractor is laid on the plan and shifted about until each of the three known points, (which have already been plotted on the plan), lies on a beveled edge of one of the three arms of the protractor. When the protractor is in this position its center locates the point desired which is then marked by a needle point. Only one location of this center point can be obtained except in the case where the three known

points lie in the circumference of a circle which passes through the center.

422. There are several other types of protractor made, but the principle and use of all of them are much the same as those of the simple types which have been explained. It is well in purchasing a protractor to test it to see that the center point lies on a straight line between the 0° and 180° marks, that the edge of the protractor is the arc of a true circle, and that the graduations are uniform.

423. **PANTOGRAPH.** — This instrument is composed of several flat pieces of metal or wood joined in such a way as to form a parallelogram. One of the three points *A*, *B*, and *C*, (Fig. 173) is fixed and the other two movable. The remaining bear-

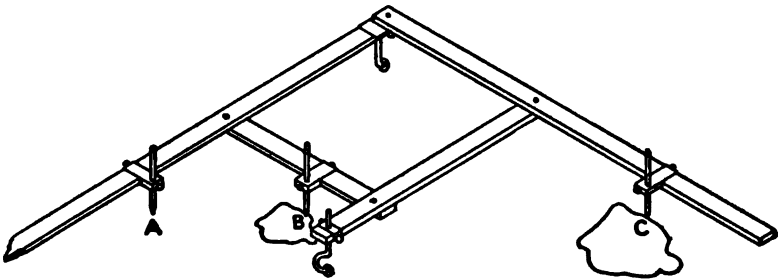

FIG. 173. THE PANTOGRAPH.

ing points are not essential except to support and steady the instrument. The two movable points are so attached to the instrument that they will trace out exactly similar figures. The instrument is used for copying a plan either to the same or to a different scale. There are several different forms of pantograph varying considerably in appearance, but they are all based on the same principle. The essential condition in their design is that all three points *A*, *B*, and *C*, must lie in a straight line and each point must be on one of three different sides (or sides produced) of a jointed parallelogram. Any one of the three points can be the fixed point. It is evident then that by changing the relative positions of these points, by moving them up or down the arms of the parallelogram, but always keeping the points on a

straight line, the scale of the copy can be made to bear any desired relation to the scale of the original drawing. These instruments are usually provided with scales marked on the arms indicating the proper settings for various reductions or enlargements. With a pantograph very accurate results cannot as a rule be obtained because there is lost motion in the several joints of the instrument. Some of the expensive metal pantographs, however, will give fairly good results.

424. PARALLEL RULER. — This is a beveled rule made of metal and mounted on two rollers of exactly the same diameter. It is used for drawing parallel lines. This instrument can be made to do accurate work, but it must be handled with a great deal of care to prevent the rollers from slipping. It is especially useful in drafting diagrams of graphical statics in connection with structural design, in drawing the parallel sides of buildings, section lining, blocking out for titles, and in drafting large titles which require mechanical lettering.

425. BEAM COMPASS. — This is an instrument used for drawing the arcs of circles whose radii are longer than can be set out with the ordinary compass drafting instrument. It is composed of a strip of wood or metal with two metal attachments which can be fastened to it. One of these attachments carries a needle point and the other, which is usually provided with a slow-motion screw for exact settings, carries a pencil or a pen. This instrument is particularly useful in laying out large rectangles such as are called for when surveys are plotted by coordinates (Art. 449, p. 401).

426. CONTOUR PEN. — This pen is constructed very much like an ordinary right-line ruling pen except that it has a metal shaft, running through the entire length of the holder, to which the pen is attached. The shaft revolves inside of the holder, and the pen is so shaped that it drags behind taking a position in the direction in which it is being moved. It is used for drawing irregular curved lines such as contours or shore lines. Not a little practice is required before one can use a pen of this type accurately. When skill in its use is once acquired, however, a plan can be easily made on which the contours all have a uniform weight of line giving a very satisfactory appearance. The

purpose of a contour line is to show the facts as to the surface, and this pen should not be used unless it is found by trial that it does the work in hand properly. Accuracy is more important than appearance.

427. PROPORTIONAL DIVIDERS. — Proportional dividers are substantially an ordinary pair of dividers with both legs prolonged through the pivot-point thereby forming another pair of legs above the pivot. The pivot is movable so that it can be pushed up and down in a slot in the legs and clamped in any desired position, thereby altering the relative lengths of the two pairs of legs. The sliding is accomplished in some dividers by a rack-and-pinion motion. When the pivot is in the middle position the legs are equal, and the space between the two points of one pair of legs is equal to the space between the other pair. There are marks on the legs showing the proper settings for the pivot so that the space between one pair of points will bear any desired ratio to the space between the other pair. The marks on the legs should not be accepted as correct, but should be tested by actual trial. One end of the proportional dividers is used to space off the distances from the original map and the other end used to plot that distance on the new map. Thus by means of this instrument a drawing can be enlarged or reduced to a definite scale without the use of the engineer's scale.

A drawing which is to be made two-thirds the size of the original can be readily reduced by scaling the distances from the original with a 20-ft. scale and plotting them on the new drawing by use of a 30-ft. scale. But when the reduction is some odd ratio which cannot be readily accomplished by means of the engineer's scale proportional dividers are very useful.

428. RAILROAD CURVES, FRENCH CURVES, FLEXIBLE CURVE, AND SPLINE. — For drawing arcs of curves of long radii, such as occur on railroad plans and on plans of curved streets, in city work, curves made of wood, hard rubber, celluloid, or metal are used; these come in sets of about one hundred, with radii varying from about 2 inches to 300 inches. The metal curves are the most common and are made with the inside and outside edges of the same radii both edges being beveled. When a pencil line is drawn the beveled edges may be used against the

paper, and when ink lines are drawn the curve can be turned over so that the beveled edges are up, thus preventing the ink from running in under the curve on the paper. Some curves for railroad work are made with a short straight edge tangent to the curve at one end and with the point where the curve begins marked by a line across it.

429. Irregular curves, called *French Curves*, are of a variety of shapes. They are made of wood, hard rubber, and celluloid, and are used to guide the pencil or pen in tracing out irregular curved lines on the map.

430. A *Flexible Curve* consists of a strip of rubber fastened to a flexible metal back. This curve can be twisted to conform to any irregular curved line on the map and can then be used as a guide against which the pencil or pen is held in tracing out the curve.

431. A *Spline* is a long thin flexible piece of wood, hard rubber, celluloid, or metal which can be bent so as to conform to a curve. It is usually held in position by specially designed weights with light metal arms which fit into a thin groove in the top edge of the spline. This instrument is used by naval architects for drawing long flat irregular curves such as occur in ship designs. In engineering drafting it is used in drawing the lines of arches, which frequently are not circular.

DRAWING PAPERS.

432. The drawing papers used by surveyors may be divided into four general classes; (1) those used for plotting plans, (2) tracing paper or tracing cloth which is used for copying drawings, (3) cross-section and profile papers, and (4) process papers.

433. **DRAWING PAPER FOR PLANS.**—There are numerous grades of drawing paper ranging from very cheap "detail" to heavy paper mounted on cloth, called "mounted paper." For rough plots which are to be copied later or which are for temporary use only, a manilla detail paper is frequently used; but where the drawing is to be of a more permanent character a heavy white or manilla paper is used. Still more permanent

plans, such as the plan of a survey of a city, should be plotted on heavy mounted paper. There is generally a right and a wrong side to all papers, which can be distinguished by the "water-mark"; this will read direct when the right side of the paper is toward the observer. A paper to be satisfactory for use should have a surface not too porous to take ink nicely, and of a fiber such that after scratching with a knife or rubbing with an ink eraser, the surface will still take ink effectively. No paper, however, after scratching can be expected to take bottle red ink, which permeates the fiber with extraordinary ease.

434. TRACING PAPER AND TRACING CLOTH. — In making copies of drawings, a thin transparent paper called *tracing paper* is often used. It is not tough enough to withstand rough handling and is used only for drawings of a temporary character. There are, however, certain kinds of transparent bond paper in use which will withstand considerable hard usage.

435. For more permanent drawings a *tracing cloth* is used, made of a very uniform quality of linen coated with a preparation to render it transparent. Most tracing cloth as it comes from the manufacturer will not readily take the ink, and it is necessary to rub powdered chalk or talc powder over the entire surface of the cloth before inking the drawing. After the surface chalk is brushed off, the tracing cloth is ready for use. Tracing linen generally has one side glazed and the other dull. Pencil lines can be drawn on the rough side, but the smooth side will not take even a very soft pencil; either side may be used for ink drawings. Some draftsmen prefer to use the glazed side but the dull side is more commonly used. A tracing inked on the glazed side may be tinted on the dull side either by crayons or by a wash; the latter will cockle the cloth unless it is put on quite "dry." It is easier to erase from the glazed than from the dull side, but the dull side will stand more erasing,* and gives more uniform lines.

* Erasure of ink lines from a tracing, as well as from any drawing paper, is a delicate undertaking. Success will result if the following suggestions are carefully observed: — with a smooth sharp knife pick off the ink from the paper; this can be done almost without touching the paper. When practically all of the ink is off, rub the line with a pencil eraser. This will take off the rest of the line except

In making a tracing of another tracing it will be found that the lines can be more readily seen if a white paper is put under the lower tracing. It frequently happens that it is necessary to make a tracing of a blue-print. The white lines of the blue-print are not easily seen through the tracing linen. An arrangement which will assist greatly in such work is to have a piece of plate glass set into the top at one end of a drawing table in such a way that it forms part of the top of the table. The blue-print is placed over this glass and the light shining through from the under side of this glass and through the blue-print will make the white lines easily visible for copying.

It is common practice, after a survey is made and before or during the computation of it, to plot the field notes accurately on detail paper and later to copy the plot on tracing cloth, which is the final drawing of the survey.

From these tracing drawings any number of process prints can be made (Art. 43^S), the tracing taking the place of the negative used in photographic printing.

436. CROSS-SECTION, AND PROFILE PAPERS.— Paper divided into square inches which, in turn, are divided into small subdivisions is used to plot cross-sections of earthwork and the like. The inch squares are usually divided into $\frac{1}{8}$ " , $\frac{1}{16}$ " , $\frac{1}{32}$ " , or $\frac{1}{64}$ " . Cross-section paper can also be obtained divided according to the metric system, or with logarithmic divisions. Cross-section paper usually comes in sheets.

437. Profile Paper which, as the name implies, is used for plotting profiles comes in rolls of 10 yds. or more. The vertical divisions are usually much smaller than the horizontal divisions, which makes it easier to plot the elevations accurately. The horizontal distances to be plotted occur mostly at full sta-

perhaps a few specks of ink which can readily be removed by a sharp knife. This method of erasing takes more time than the ordinary method of rubbing with an ink eraser until the line has disappeared, but it leaves the paper in much better condition to take another line. It is impossible to obtain good results by this method unless the knife has an edge which is both smooth and sharp. Where the surface of the tracing cloth has been damaged the application of a thin coating of collodion on the damaged portion will produce a surface which will take the ink.

tion points, which are represented on the profile by the vertical rulings on the paper.

Both the cross-section and the profile papers come in colors, (usually red, green, blue, orange, or burnt sienna) so that a black or a red ink line (the two most commonly used) will show up distinctly on the paper. These papers can be obtained also of very thin transparent material or in tracing cloth form, suitable for use in making process prints. Profile papers usually come in long rolls 20 inches wide.

438. PROCESS PAPERS. — Blue-Prints. — The most common process paper used in drafting offices is blue-print paper. It is a white paper coated on one side with a solution which is sensitive to light. After the solution is applied, the paper is dried and then rolled and sealed up for the market in light-proof rolls of 10 yds. or more. Fresh blue-print paper has a greenish-yellow color. The process of coating the paper and the general handling of the blue-print business is so well advanced and the price of the prepared paper is so low that surveyors now-a-days seldom coat their own paper. The process is a very simple one, however, and in emergencies, when commercial blue-print paper cannot be obtained, it may be very useful to know how to prepare it. A good formula for the solution is given below.

Make the following two solutions separately (in the light if desirable) and mix, **in subdued light or in a dark room**, equal parts of each of them.

Solution (1)

Citrate of Iron and Ammonia,	1 part (by weight)
Water,	5 parts (" ")

Solution (2)

Red Prussiate of Potash (re-	
crystallized),	1 part (by weight)
Water,	5 parts (" ")

The mixed solution is applied to the paper by means of a camel's hair brush or a sponge; this is done in a dark room or in subdued light. The paper is coated by passing the sponge lightly over the surface three or four times, first lengthwise of the paper and then crosswise, giving the paper as dry a coating

as possible consistent with having an even coating; it is then hung up to dry. The above coating will require about 5 minutes exposure in bright sunlight; for quick printing paper, use a larger proportion of citrate of iron and ammonia.

The blue-print of a plan is generally made in a printing frame, which is merely a rectangular frame holding a piece of heavy glass, with a back to the frame which can be lifted from the glass. This back is padded so as to fit tight against the glass when the back is clamped into position. The process of taking a print is, briefly, to expose the tracing, with the blue-print paper under it, to the sunlight a proper length of time and then remove the blue-print paper and wash it in water.

439. In detail, the process is as follows. First, turn the printing-frame over so that the glass is on the bottom, and remove the back of the frame. Then, after the tracing cloth has been rolled, if necessary, so that it will lie flat, place it **with its face against the glass**. Place the blue-print paper, which has been cut to the proper size, on top of the tracing with the **sensitized side of the paper next to the tracing**. The back of the frame is then clamped into position and the frame turned over so that the glass is up. It should then be examined to see that the tracing has been put into the frame with its ink lines against the glass, that the blue-print paper is under the entire tracing, and that there are no wrinkles in the tracing. All of the process to this stage should be done in subdued light, usually in a room with the shades drawn to keep out most of the sunlight.

The frame is then moved out into the direct sunlight, placed as nearly as may be at right angles to the rays of sunlight, and left there a proper length of time, which will depend upon the sensitiveness of the coating of the paper and the intensity of the light. Some blue-print papers will print in 20 seconds, others require 5 or 6 minutes in direct sunlight. In purchasing, then, it is necessary to ascertain from the dealer the "speed" of the paper and govern the exposure accordingly. Blue-prints can be made in cloudy weather as well as when the sun is visible, the only difference being that it requires a much longer time for the exposure. In all cases where the time of exposure is doubtful the following simple test may be applied. Instead of taking a

print of the entire tracing the first time, use only a small piece of the blue-print paper and put it in the frame as explained above and expose it a given time. Take it out and wash it, and from this test judge the length of exposure necessary to give the print of the entire drawing. An under-exposed print, after it has been washed, will be light blue in color with white lines; an over-exposed print will be dark blue with bluish-white lines. The result desired is a **dark or medium blue background with white lines**. It should be borne in mind, in judging the results, that all prints become a little darker when they are dry.

In washing the print it should be entirely immersed in clear water at first; care should be taken that no part of the print is left dry. It should be washed by moving it back and forth in the water or by pouring water over it until the greenish solution is entirely washed off its face. The print should be left in the water for 10 to 20 minutes, then it is hung up to dry. It will dry more quickly if hung so that one corner is lower than the others. It should not be hung where the sun will shine on it as the sunlight will fade it.

In taking prints great care must be exercised **not to get the tracing wet**. When the prints are being washed the tracing should always be put in a safe place where the water will not spatter on it and it should never be handled with moist hands. It is practically impossible to eradicate the effect of a drop of water or even the marks made by damp fingers on tracing cloth; it is sure to show in every subsequent print which is taken from the tracing.

440. *Blue-print cloth* is prepared in the same manner as the blue-print paper. Its advantage over the paper lies solely in the fact that it does not shrink as badly and is much more durable. Prints which are to be used on construction work where they are sure to get rough usage are sometimes made on cloth.

441. *Vandyke Solar Paper*. — There has always been a call for a sensitive paper which will give positive prints, — a black, a brown, or a blue line on a white background. Such effect was secured by the old so-called "black print process," but its operation was not altogether simple and good results were not reason-

ably sure. The Vandyke paper has apparently solved this difficulty, and in addition affords other advantages which the old "black process" paper did not possess.

Vandyke paper is a sensitized paper which is printed in the same way as a blue-print, except that the tracing is put into the frame so that the ink lines will be **against** the Vandyke paper. The exposure is about 5 minutes in direct sunlight or, more definitely, until the portion of the Vandyke paper which protrudes beyond the tracing is a rich dark tan color. Fresh Vandyke paper is light yellow in color. The print is washed for about 5 minutes in clear water (where it grows lighter in color) and then it is put into a solution consisting of about one-half ounce of fixing salt (hyposulphite of soda) to one quart of water, where it turns dark brown. It is left in the fixing bath about 5 minutes, after which the print is again washed in water for 20 to 30 minutes and then hung up to dry. The fixing solution may be applied with a sponge or brush if only a few Vandykes are being made, but it is better to immerse them in a tank containing the solution.

After the Vandyke print is washed the body is dark brown in color while the lines are white. This is not the final print to be sent out; it is simply the *negative*.

This Vandyke print is then put into the printing-frame in place of the tracing, the **face** of the Vandyke being **next** to the sensitive side of the process paper, and from it as many prints as are desired are made on blue-print paper or on any kind of sensitized paper desired. These blue-prints made from Vandykes have a white background while the lines of the drawing appear in deep blue lines, for in this case the rays of the sun act only through the white parts of the Vandyke (the lines), whereas in making an ordinary blue-print from a tracing the sun's rays act on the paper through all parts of the tracing cloth **except** where the lines appear. Where brown lines on a white background are desired, the print is made by using a sensitized sheet of Vandyke paper, in place of the blue-print paper.

One of the advantages of this process is that, as soon as a Vandyke has been made from the tracing, the tracing can be filed away and kept in excellent condition, the Vandyke being used in making all prints.

Another advantage in the use of the blue-prints which have been made by this process is that any additions made in pencil or ink show clearly on the white background of the print which is not true of the ordinary blue-print, on which corrections must be made with a bleaching fluid or water-color.

442. Electrical Printing Frames. — The uncertainty of the sunlight for making prints has brought forward a printing frame in which an artificial light is used.

One form of electrical printing frame is an apparatus consisting of a hollow glass cylinder, formed of two sections of glass, and resting on a circular base which is rotated by clock work. An electric light is suspended in the center line of the cylinder where it travels up and down by means of a clock work attachment.

The tracing and paper are wrapped around the outer surface of the glass where they are tightly held against the glass by a canvas which is wound around the cylinder by means of a vertical roller operated by a handwheel. The cylinder can be rotated at any desired speed and the light which travels up and down the axis of the cylinder can be moved through any desired distance or at any desired speed. These motions are all made automatically when the apparatus is once adjusted.

In another type of electrical machine several horizontal rollers are provided, with the light so arranged that as the tracing and blue-print paper passes from one roller to another the exposure is made. The speed of the machine is controllable and the length of the tracing that can be printed is limited only by the length of the roll of blue-print paper. With this machine, then, long plans or profiles can be printed without the necessity of frequent splicing which is required with other types of printing frame; furthermore the color of the print is also uniform throughout. The machine is driven by an electric motor. There are several machines of this general type on the market; some of them are provided with an apparatus for washing the prints as fast as they come from the machine.

443. INKS AND WATER-COLORS. — Bottled ink, which is prepared in various colors, is used extensively on engineering drawings. The so-called "waterproof" inks differ from other

inks in that a water-color wash can be put over the lines without causing them to "run." Bottled inks are satisfactory for most drawings, but when very sharp and fine hair-lines are required it is well to use the stick india ink. This is made by grinding the ink together with a little water in a saucer made for this purpose, until the ink is thick and black enough to be used. If the ink becomes dry it can be restored to as good condition as when first ground by adding water, a drop or two at a time, and rubbing it with a piece of cork or a pestle; if the water is added too rapidly the ink will flake.

While the bottled black inks are fairly well prepared, the red inks are very unsatisfactory. They will sometimes run on paper where only very slight erasures have been made; in fact, on some of the cheaper papers red ink will always run. For tracing purposes red ink is wholly unsatisfactory, as it is impossible to obtain a good reproduction of a red ink line by any of the process prints. Where red lines are needed the use of *scarlet vermilion water-color* will be found to give not only a brilliant red line on the tracing, but also "body" enough in the color so that the lines will print fully as well as the black ink lines. Scarlet vermilion water-color will give much better lines on any paper than the bottled red inks. Only enough water should be used to make the water-color flow well in the pen. Other water-colors are used in the place of the bottled colored inks, such as *P. ussian blue* instead of bottled blue ink, or *burnt sienna* instead of brown ink, and these give much better results.

It is frequently necessary on blue-prints to represent additions in white, red, or yellow. A white line can easily be put on by using *Chinese white* water-color; but sometimes a bleaching fluid is used which bleaches out the blue leaving the white paper visible. The best color for a red line on blue-prints is scarlet vermilion water-color; and for a yellow line none of the ordinary yellow water-colors gives as brilliant lines as Schoenfeld & Co.'s *light chrome yellow*.

For tinting drawings water-colors and dilute inks are used. Effective tinting may be done on tracings by using colored pencils on the rough side of the linen.

CHAPTER XV.

METHODS OF PLOTTING.

444. LAYING OUT A PLAN. — Laying out a plan requires careful work. If a good-looking plan is to be obtained this part of the work must be done with not a little judgment. Besides the plan of the survey or property the drawing must have a title, and sometimes notes and a needle to show the direction of the meridian. These must all be arranged so that the entire drawing when completed will have a symmetrical appearance. Often the plot is of such awkward shape that it is very difficult to lay out the drawing so that it will look well, and the draftsman's artistic instincts are taxed to the utmost to produce a satisfactory result.

445. Scale. — In many cases the scale of the plan as well as the general arrangement of its parts must be chosen by the engineer. Surveys of considerable extent which do not contain a great many details, such, for example, as the preliminary survey for a railroad, may be drawn to a scale of 400 ft. to an inch. A plan of a large piece of woodland or a topographical map of a section of a town may be represented on a scale of from 100 ft. to 400 ft. to an inch. A plan of a city lot for a deed is represented on a 20-ft. to 80-ft. scale; and city streets, such as sewer plans and the like, are frequently drawn to a scale of 20 ft. to 40 ft. to an inch. Sometimes on plans of construction work drawings of different scale are made on the same sheet. The drawing for a conduit, for example, may be represented by a general plan on a scale of 80 ft. to an inch, while on the same sheet the conduit may be shown in section on a scale of 4 ft. to an inch.

The field maps of the U. S. Coast and Geodetic Survey are usually plotted on a scale of 10000, but some special maps are made on scales as large as 25000. The field maps of the U. S. Geological Survey are mostly plotted to a scale of 30000 and reduced on the lithograph sheets to 25000 or 125000.

These remarks in regard to scales are not to be considered in any sense as hard and fast rules to govern all conditions. They are suggested simply to give some idea of the existing practice in this matter.

METHODS OF PLOTTING TRAVERSES.

446. PLOTTING BY PROTRACTOR AND SCALE. — The most common method of plotting angles is by use of the protractor (Art. 417, p. 382), and of plotting distances, by use of the engineer's scale. Every traverse consists of a series of straight lines and angles, which can be plotted by a protractor in the following manner. First, the survey to be mapped should be sketched out roughly to scale, in order to ascertain its extent and shape so as to decide the size of paper necessary for any given scale of drawing and to determine its general position on the sheet, which will fix the direction of the first line of the traverse, to be used as a starting line for the entire drawing. This having been done, the first line is drawn in the proper place on the paper, its length is scaled off by using the proper scale, and its two extremities accurately marked by pencil dots or by means of a needle point, and surrounded by a light penciled circle. The line should be drawn so that it will extend beyond the next angle point a distance greater than the radius of the protractor, this extension of line being of use in the manipulation of the protractor.

The protractor is placed so that its center is exactly on the second angle point and so that both the 0° and 180° marks of the protractor exactly coincide with the line. The traverse angle taken from the field notes is plotted, the protractor removed, the line drawn, and the length of the second course carefully scaled. Then the protractor is placed along this new line and opposite the third point, the angle at that point is laid off, the next line drawn, and the distance scaled. By this process the entire traverse is plotted.

447. Checks. — On all plotting work, just as on all field-work and computations, frequent checks should be applied to insure accuracy.

If the traverse is a closed traverse the plot, of course, should close on the paper.* If it does not and the error of closure is in a direction parallel to any one of the lines, there is probably a mistake in plotting the length of that line. If there is no indication of this sort the mistake may be either in scaling, in laying off the angles, or in both. In such a case the entire plot should be checked unless there is some reason to think that a certain line may have been laid off at the wrong angle, in which event that questionable angle should be replotted. The bearings of all the lines of the traverse can be computed with reference to the magnetic or to any assumed meridian; any line can be produced to meet the meridian line, and this angle measured and checked. Similarly, the bearing of the last line of a traverse which does not close can be computed and the angle the last line makes with the meridian measured. If it checks the computed angle it is evident that no error has been made in the angles unless mistakes were made that exactly balance each other, which is not probable. In this way, by "cutting into" the drawing here and there, the angular error, if there is one, can be quickly "run down," without laying out all of the angles again and so possibly repeating the mistake that was originally made. The angles measured in applying this check have different values from the ones first laid out, and the chance of repeating the original mistake is thereby eliminated. If no error is found to exist in the angles, the distances should next be checked. This can be done in two ways, and in some drawings both of these checks should be applied.

First, scale each line separately setting down the results independently upon a sheet of paper. After these are all recorded (and not before), compare the lengths with the lengths of lines as taken from the field notes. No error should be allowed to pass if it is large enough to be readily plotted by the use of the scale.

* Instead of plotting every line of the traverse from its preceding line and returning, in the case of a closed traverse, to the other end of the starting line, it may be well to plot half the traverse from one end of the starting line and the other half from the other end; the check will then come at a point about half-way around the traverse. The advantage of this method lies in the fact that accumulative errors are to some extent avoided since they are carried through only half as many courses.

Second, take a long straight piece of paper, lay this on the drawing, and mark off the length of the first line on the edge of the paper; then mark off the length of the second line starting from the mark which denotes the end of the first line, and proceed in a similar way to the end of the traverse. Apply the scale to the strip of paper and read the station of each mark; record each of these independently and afterwards compare them with the field notes. The entire length of line should check within a reasonable amount depending upon the scale; the allowable error can easily be determined by the principle explained in Art. 23, p. 14.

By checking angles and distances by the above methods errors of any consequence can be avoided; in any case a draftsman should not allow a drawing to leave his hands which has not been properly checked and known to be correct.

When the traverse is not closed, such checks as have been described above must **always** be applied; otherwise there is no assurance whatever that the plan is correct. It is especially necessary to check the bearings of lines frequently, so that the accumulation of small errors may not become appreciable.

448. Protractor and T-Square. — While the ordinary T-square is not much used in plotting engineering plans, there are some occasions where it is convenient to use it. Where a traverse has been run by bearings or by deflection angles the T-square with a shifting head can be conveniently used in connection with a protractor for plotting the angles by bearings.

The paper is fastened to a drawing board having a metal edge, which insures one straight edge to the board. A meridian line is drawn on the paper, and the shifting head of the T-square is fastened so that the blade coincides with the meridian line. Then as the T-square is slid up and down the edge of the drawing board its blade always takes a direction parallel to the meridian. By means of the protractor shown in Fig. 172 the bearing of each line can be readily laid off or checked as illustrated by Fig. 174 and the distances laid off with the scale. In order to secure a satisfactory check, the deflection angles should be laid off directly from the previous line, and the bearings checked by means of the T-square and protractor.

It is evident that the bearings of the lines may be computed just as well from any assumed meridian as from the magnetic or true meridian ; and that the drawing can be fastened to the board

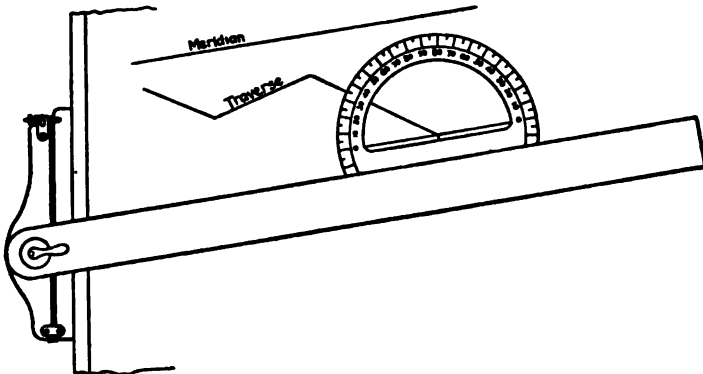

FIG. 174. LAYING OFF BEARINGS BY USE OF T-SQUARE AND PROTRACTOR.

in such a way that the T-square can be conveniently used. This method is especially applicable to compass surveys as it obviates the necessity of drawing a new meridian line through each angle point.

This method can be easily applied also as a means of checking any of the angles of a traverse which have been plotted by any of the ordinary methods.

449. PLOTTING BY RECTANGULAR COÖRDINATES.— In plotting by this system all points in the traverse are referred to a pair of coördinate axes. For convenience these axes are often the same as those used in calculating the area enclosed by the traverse. The advantages of this method are, (1) that all measurements are made by means of the scale only and (2) that the plotting may be readily checked.

To plot a survey of a field by rectangular coördinates, first calculate the *total latitude* and the *total departure*, that is, the ordinate and the abscissa, of each point in the survey. If the meridian through the most westerly point and the perpendicular through the most southerly point are chosen as the axes negative

signs in the coördinates will be avoided. The coördinates of the transit points are computed by beginning with the most westerly point, whose total departure is zero, and adding successively the departure of each of the courses around the traverse. *East* departures are called *positive* and *West* departures *negative*. The total departure of the starting point as computed from that of the preceding point will be zero if no mistake is made in the computations. The total latitudes may be computed in a similar manner beginning, preferably, with the most southerly point as zero.

450. For plotting the points on the plan, a convenient method of procedure is to construct a rectangle whose height equals the difference in latitude of the most northerly and the most southerly points and whose width equals the difference in departure of the most westerly and the most easterly points. If the most westerly and the most southerly points are taken as zero then the greatest ordinate and the greatest abscissa give the dimensions of the rectangle. The right angles should be laid off either by the use of a reliable straight-edge and a triangle or by the beam compass.

451. The better method, however, is to construct the perpendiculars by means of a straight-edge and a triangle. It is

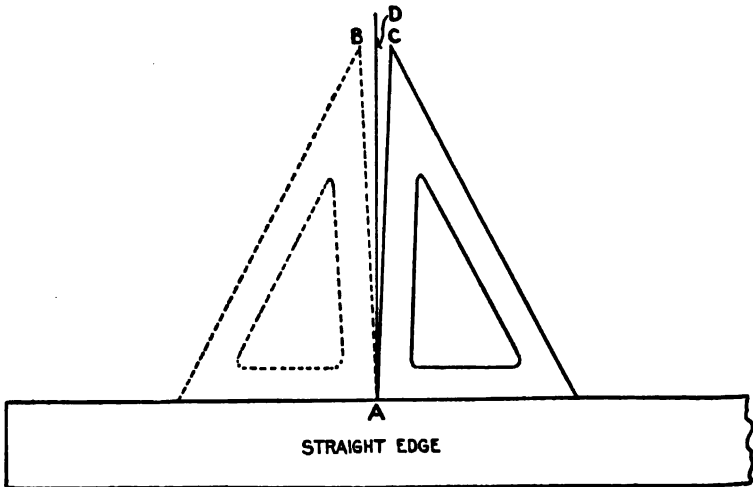

FIG. 175. ERECTING A PERPENDICULAR WITH A STRAIGHT-EDGE AND AN INACCURATE TRIANGLE.

not at all necessary, although it is always desirable, that the triangle shall be accurate. It should be used in the following manner. It is first placed against the straight-edge, as shown by the full lines in Fig. 175, and a point *A*, marked on the paper. Point *C* is also marked opposite a certain definite part of the triangle. Then the triangle is reversed to the dotted position and brought so that its edge coincides with point *A*, and then point *B* is marked opposite point *C*, as nearly as can be judged. A point *D* is plotted midway between *B* and *C* and the line *AD* is then drawn which is perpendicular to the straight-edge. If the triangle is accurate point *B* will fall on point *C*, so that this is a method of testing the accuracy of the right angle of any triangle. If it is found to be inaccurate it should be sent to an instrument maker and be "trued up." A few cents spent in keeping drafting instruments in shape will save hours of time trying to locate small errors, which are often due to the inaccuracy of the instruments used.

If the compass is used the right angle may be laid off by geometric construction. On account of the difficulty of judging the points of intersection of the arcs, very careful work is required to obtain good results with the compass.

Since the accuracy of all of the subsequent work of a coördinate plot depends upon the accuracy with which the rectangle is constructed, great care should be taken to check this part of the work. The opposite sides of the rectangle should be equal and the two diagonals should be equal, and these conditions should be tested by scaling or with a beam compass before continuing with the plot.

452. After the rectangle has been constructed, all points in the survey can be plotted by use of the scale and straight-edge. To plot any point, lay off its total latitude on both the easterly and the westerly of the two meridian lines of the rectangle, beginning at the southerly line of the rectangle. Draw a line through both of these points by means of a straight-edge.*

* Accurate work, of course, cannot be obtained with a straight-edge that is not true. A straight-edge can easily be tested by drawing a fine pencil line on the paper along one edge of the straight-edge; then turn the straight-edge over on its other side, fit the same edge to the two ends of the pencil line, and see if the edge coincides with the line.

Then lay off along this line the total departure, beginning at the westerly side of the rectangle, thus obtaining the desired position of the point.

The computations of the total latitudes and departures and the method of plotting a traverse by the coördinate method are shown in Fig. 176. This is the survey which is shown in the

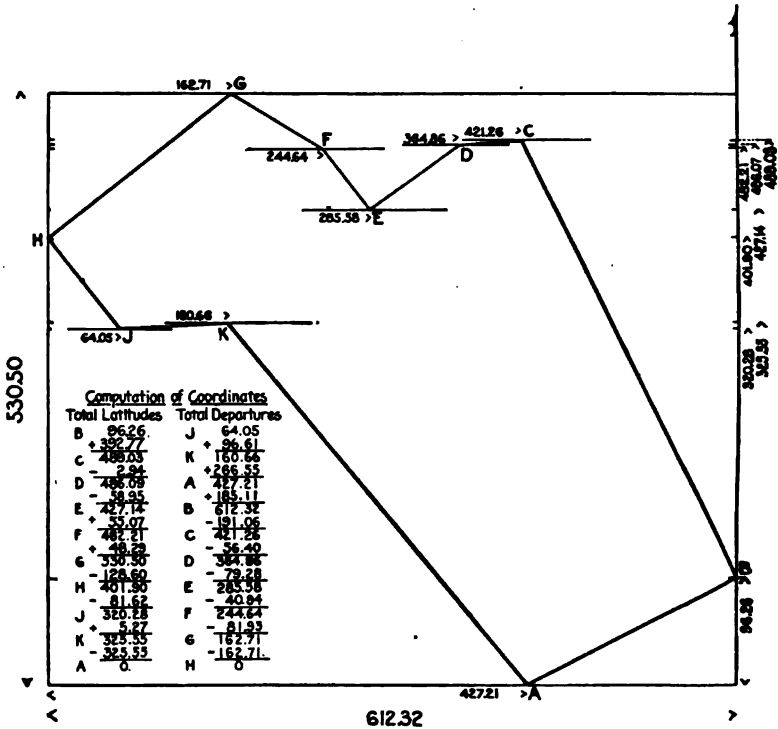

FIG. 176. COMPUTATIONS AND PLOTTING BY RECTANGULAR COÖRDINATES.

calculations in Fig. 161, p. 362, and in the form of notes in Fig. 52, p. 103.

453. Plotting by rectangular coördinates is the most accurate of all the methods usually employed. It is not very often applied, however, to traverses which do not close, as there is seldom any other use for the coördinates of such a traverse, and the

labor of computing them for this purpose alone is hardly warranted. For such traverses, therefore, either the protractor and scale, the Tangent Method, or the Chord Method (which are explained in the following articles) may be employed. But for plans of a closed traverse, where the latitudes and departures have been computed in connection with calculating its area, this coördinate system of plotting is frequently used.

454. Checks. — When the transit points have been plotted, the scale distance between consecutive points should equal the distance measured in the field. It sometimes happens that some of the transit lines run so nearly parallel to one of the axes that the distances will scale the right amount even though a mistake has been made in laying off one of the coördinates. In such a case any appreciable error can be detected by testing the bearings of the lines by means of a protractor. These two tests, together with the scaled distances of any cut-off lines which may have been measured in the field, (Art. 145, p. 109), form a good check on the accuracy of the plotting. Since all of the points are plotted independently errors cannot accumulate. If it is found that any scaled distance fails to check with the measured distance it is probable that one of the two adjacent lines will also fail to check and that the point common to the two erroneous lines is in the wrong position.

It should be remembered that everything depends upon the accuracy of the rectangle and that nothing should be plotted until it is certain that the right-angles have been accurately laid off.

455. PLOTTING BY TANGENTS. — The traverse should first be plotted approximately on some convenient small scale by use of the protractor and scale, to ascertain its extent and shape. The importance of this little plot is often overlooked, with the result that when the plan is completed it is found to be too close to one edge of the paper or otherwise awkwardly located on the sheet. It takes only a few moments to draw such a sketch, and unless the draftsman is sure of the shape and extent of the plot he should always determine it in some such manner before the plan is started.

The directions of all the lines are referred to some meridian

and the bearings determined with an accuracy consistent with the measured angles. From the auxiliary plot it can be decided where to start the first course of the traverse on the paper and in what direction to draw the meridian, so that the lines of the completed traverse will be well balanced with the edges of the sheet, and so that the needle will be pointing, in a general way, toward the top of the drawing rather than toward the bottom.

The bearing of the first line is plotted as follows (Fig. 177).

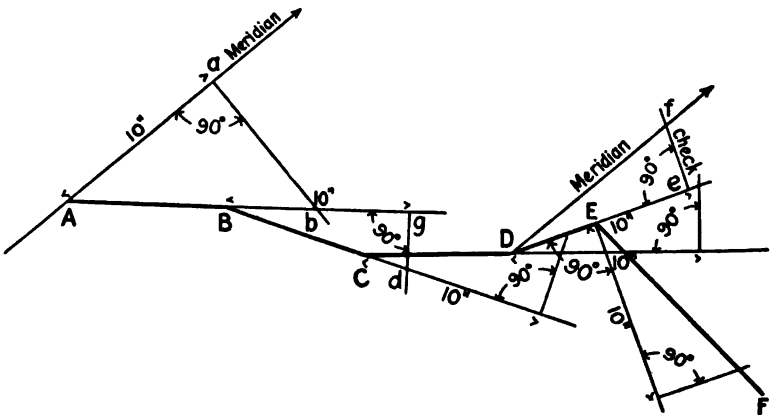

FIG. 177. PLOTTING BY TANGENT OFFSETS.

Lay off on the meridian line a length Aa of at least 10 inches and erect a perpendicular at a on the right-hand side of the meridian if the bearing of the first course is east, and on the left-hand side if it is west. Look up in the table of natural functions the tangent of the bearing of the first course and scale off this distance ab on the perpendicular.* Draw Ab which is

* These distances and also the 10-inch base-lines are all laid off by use of the engineer's scale. By using the 10-ft. or 100-ft. scale the tangents can be laid off without any computation, whereas with the other scales the tangent must be multiplied by some number, e.g., by 2 if the 20-ft. scale is used, by 3 if the 30-ft. scale is used, etc., taking care in the pointing off.

If it is deemed unnecessary to use a base as long as 10 inches, one can be laid off at the "10" mark on any engineer's scale and the tangent distances laid off by using the same scale, e.g., if a 20-ft. scale is used the "10" mark will give a base-line 5 inches long.

the direction of the first course. On this line scale off AB , the length of the first course. On this line produced lay off Bg equal to 10 inches and erect a perpendicular, scaling off on the perpendicular the length gd equal to the tangent of the **deflection angle** at B . This determines the direction of BC from the first course. The remaining lines of the traverse are plotted in the same manner, using each time the deflection angle.

456. Checks. — Unless the survey is a closed traverse checks must be occasionally applied. Every third or fourth course should be checked by finding the angle between it and the meridian line. This angle should be found by the same method (tangent offset method) and by using a base of 10 inches as in plotting the angles. In checking the course De , for example, a meridian is drawn through D parallel to Aa , De is scaled off 10 inches, and a perpendicular ef erected. The distance ef is scaled and from the table of tangents the angle fDe is obtained. If the angle that the course makes with the meridian line disagrees with the calculated bearing of that course by any considerable amount, say, 10 minutes of angle or more, the previous courses should be replotted. If the error is less than 10 minutes the course which is being checked should be drawn in the correct direction so that even the slight error discovered may not be carried further along in the plot. Then after the plotting has proceeded for three or four more courses the check is again applied.

The bearings of the lines can be checked by use of the protractor and this will detect errors of any considerable size, but this method will not disclose any small errors; moreover, if it is desired to have the plot when completed as accurate as could be expected from the precise method employed, it is entirely inconsistent to check by use of a method which is far less accurate than the one used in making the plot. For this reason the checks on the direction of the lines are applied with the same care and by the same method as was used in the original layout of the angles.

Occasionally it is more convenient to plot the complement of an angle rather than the angle itself, as was done in plotting the line EF . In this case the right angle erected at E must be laid

off with great care, preferably by the method explained in Art. 451, p. 402.

It is evident that the direction of each course could have been plotted by drawing a meridian line through the transit points and by laying off the **bearings** by the tangent method. But if such a method were used there would be no single check applied that would check all the previous courses, which is an important feature of the method explained above.

If the traverse is not closed the lengths of the lines of the traverse should **always** be checked by the methods explained in Art. 447, p. 398.

457. PLOTTING BY CHORDS. — This method, which is employed by many draftsmen in plotting traverse lines, is fairly good although probably not so accurate as the Coördinate or as convenient as the Tangent Methods.

Fig. 178 represents the traverse *ABCDEF* which has been

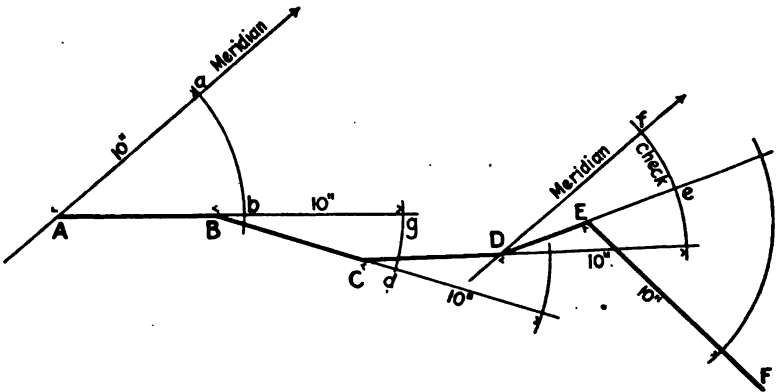

FIG. 178. PLOTTING BY CHORDS.

plotted by chords. It is the same traverse that is shown in Fig. 177.

On the meridian line the distance *Aa* is scaled off equal to 10 inches and the arc *ab* swung from *A* as a center by use of the ordinary pencil compass. Then from a table of chords * the

* Tables of chords can be found in Trautwine's "Civil Engineer's Pocket Book," published by John Wiley & Sons, New York.

length of the chord ab is found for the angle aAb . The point b is sometimes located by setting the dividers at the distance ab and with a as a center intersecting the arc ab at b ; but the more accurate method is to scale from point a the chord distance and mark the point b on the arc. Then the line Ab is drawn and AB scaled off on it. With B as a center the arc gd is drawn and the chord gd , corresponding to the deflection angle at B , is scaled off. Bd is then drawn and BC scaled off on it. In the same way the entire traverse is plotted.

458. Use of the Sine. — It is evident that the chord

$$ab = 2 \times 10 \times \sin \frac{A}{2};$$

hence, if a table of chords is not available, a table of sines (always easily obtainable) can be used. The sine of half the angle can be taken from the tables and multiplied by 20 mentally. Some draftsmen use the table of sines and a radius of 5 inches to avoid the multiplication. This is not recommended because a base of 5 inches is not long enough to insure a very accurate drawing. The necessity of multiplying by 2 can very easily be done away with by laying off the radius with a 20-ft. scale and scaling off the sine of the angle with a 10-ft. scale.

With dividers of the ordinary size it is impossible to lay out an arc with a 10-inch radius. In such a case either beam compasses must be used or the radius employed must be shorter, so short, in fact, that it will frequently be better to resort to the Tangent Method.

459. Checks. — Since this method is usually applied to traverses which do not close it is desirable to check every fourth or fifth course so that a mistake will not be carried too far before it is discovered and thereby cause a waste of time. In Fig. 178 it is desired to check the calculated bearing of De . The meridian Df is drawn through D parallel to Aa , the arc fe is swung with D as a center and with a radius of 10 inches, and the chord ef is scaled. From the table of chords (or sines) the angle fDe (the bearing) can be found. It should agree reasonably well with the calculated bearing. The degree of precision to be expected when plotting by chords is a little less than

that suggested for the Tangent Method in Art. 455, unless the beam compass is used. The Tangent Method, especially if the right angles are laid off by reversing the triangle, gives more accurate results than the Chord Method, for the use of the ordinary compass in the Chord Method is a fruitful source of error unless it is handled with the utmost care.

METHOD OF PLOTTING DETAILS.

460. BUILDINGS, FENCES, STREAMS, ETC. — The previous articles have dealt with the plotting of the traverse lines only, and these in many cases form merely the skeleton of the final plan. In the field the details of the survey are located from the transit line; and, in a similar manner, the details are located on the plan from the traverse line which has already been plotted.

Buildings, fences, shore-lines, streams, etc. are all plotted by means of the scale for distances and the protractor for the angles. Often a smaller protractor is used for this sort of work than for the traverse lines. This is permissible, for the lines which locate the details are usually short in comparison with the traverse lines and the resulting error is small in any case; furthermore any slight error in the location of a detail will not as a rule affect the rest of the drawing, whereas an error in a transit line will, of course, have an effect on all of the rest of the drawing. The plotting of buildings has been taken up in connection with their location. (See Chapter VI.)

In plotting a set of notes where several angles have been taken at one point, such as in stadia surveying, it is well to plot all of the angles first, marking them by number or by their value, and then to plot the distances with the scale.

461. CONTOURS. — Where contours are located by the cross-section method (Art. 304, p. 278), this cross-section system is laid out in soft penciled lines on the drawing. The elevations which were taken are written at their respective points on the plan and then the contours desired are sketched. The ground is assumed to slope uniformly between adjacent elevations, and, by interpolation between these points, the location of the contours on the plan can be made. When the contours have been

located, the cross-section lines and elevations are erased unless the plan is intended to be used as a working drawing. As a rule all useful data, such as construction lines and dimensions, are left on a working drawing.

When the contours are located by any other means the principle is the same. The points whose elevations have been determined are plotted by scale and protractor, and the contours are interpolated between the elevations and sketched on the plan.

462. CROSS-SECTIONS. — In plotting on cross-section paper, the rulings of the paper are used as the scale, and all the dimensions of the cross-section, which are to be plotted, are laid off by counting the number of squares on the cross-section paper.

In highway, railroad, and dam construction it is often necessary to keep a record of the progress made on the earthwork by plotting the cross-section at each station, and, as the work goes on, to mark on each section in colored ink the progress of the work for each month. In this way monthly estimates can be readily made, and the cross-section sheets will also give a record of the progress of the work, each month being represented by a different colored line or by a different style of line.

Where a series of cross-sections like this are to be plotted the station number and the elevation of the finished grade are recorded just under or over the section. To avoid mistakes in numbering the sections this should be done at the time of plotting the section.

As these cross-section sheets rarely go outside the office they are usually considered in the same class with working drawings, and dimensions, such as the areas of sections or the quantities of earthwork, are usually recorded on them, together with any other data which may be of use in calculating the volumes.

463. PROFILES. — Profiles are almost always plotted on profile paper, although occasionally they are plotted on the same sheet with the plan so that the two can be readily compared.

The profile is intended to show (graphically) relative elevations. In most surveys the differences in elevation are so small in comparison with the horizontal distances that it is necessary to exaggerate the vertical scale of the profile so that the eleva-

tions can be read from the profile with a reasonable degree of accuracy. The horizontal scale of the profile should be the same as the scale of the plan, but the vertical scale should be exaggerated, say, 5 to 20 times the horizontal scale, depending upon how close it is desired to read the elevations from the drawing. If the horizontal scale of the profile is 80 ft. to an inch its vertical scale should probably be 20, 10, or 8 ft. to an inch.

464. In plotting any profile the first step is to lay it out properly on the paper, i.e., to decide, from an examination of the range of the elevations, where to start it on the paper so that it will look well when completed, and so that any additions or studies which may subsequently be drawn on it will come within the limits of the paper. Station 0 of the profile should come on one of the heavy vertical lines, and the heavy horizontal lines should represent some even elevation such as 100, 125, 150, etc.

The profile is plotted by using the rulings of the profile paper as a scale; it is drawn in pencil first and afterward inked in. It will be found, if these profile papers are carefully measured with a scale, that they are not as a rule very accurate. The rulings may be uniform, but owing to the shrinkage of the paper the divisions frequently do not scale as long as they should. In plotting a profile or section on such paper no attempt is made to use a scale; the scale of the paper is assumed to be correct and the intermediate points are plotted by estimation, which can almost always be accurately done since the rulings of the paper are quite close together.

The data for a profile of the ground generally consist of levels taken in the field at such points that the ground may be assumed to run straight between adjacent elevations. For this reason, in drawing the profile, the points where the slope of the ground changes should not be rounded off. On the other hand, however, the ground probably does not come to an actual angle at that point. The profile should be plotted therefore as a series of free-hand straight lines drawn so that the angles are not emphasized. When a profile is made from a contour map, the line should be a smooth, rather than an angular line.

465. Profiles of the surface of the ground are generally made for the purpose of studying some proposed construction

which is represented on the profile by a grade line, consisting usually of a series of straight lines. The points where the gradient changes are plotted and connected by straight ruled lines unless the proposed grade should happen to be a vertical curve (Art. 268, p. 242). Vertical lines are also drawn from the bottom of the profile to the grade line at these points.

466. When the elevations are such that the profile, if continued, will run off the top or bottom of the paper the entire surface line is lowered or raised some even number of feet, such as 20 or 50 ft., and the plotting continued: the number of feet represented between two heavy horizontal rulings of the profile paper should determine the drop or rise of the grade line. This change should be made, when convenient, on one of the heavy vertical rulings of the paper or on one of the vertical lines where the gradient changes.

467. **Checks.**— After plotting the surface and grade elevations in pencil, read off from the profile the station and elevation of each point as plotted and record both the station and elevation on a piece of paper. Compare these readings with the data given and make the necessary corrections. Time can be saved if one man reads off the station and elevation from the profile while a second man compares the readings with the note-book. A quick method of **plotting** profiles is to have one man read the notes while the other man plots them, but when the profile is being **checked** this method should not be used; the man, preferably the one who did not do the plotting, should **read from the profile as plotted** and these readings should be compared with the note-book.

PROBLEMS.

1. Plot the surveys given in Fig. 50, p. 100, and in Fig. 53, p. 104, by Protractor and Scale, Rectangular Coördinates, Tangents, or Chords.
2. Plot by use of Scale and Protractor the notes given in Fig. 72, p. 163, and in Fig. 116, p. 266.

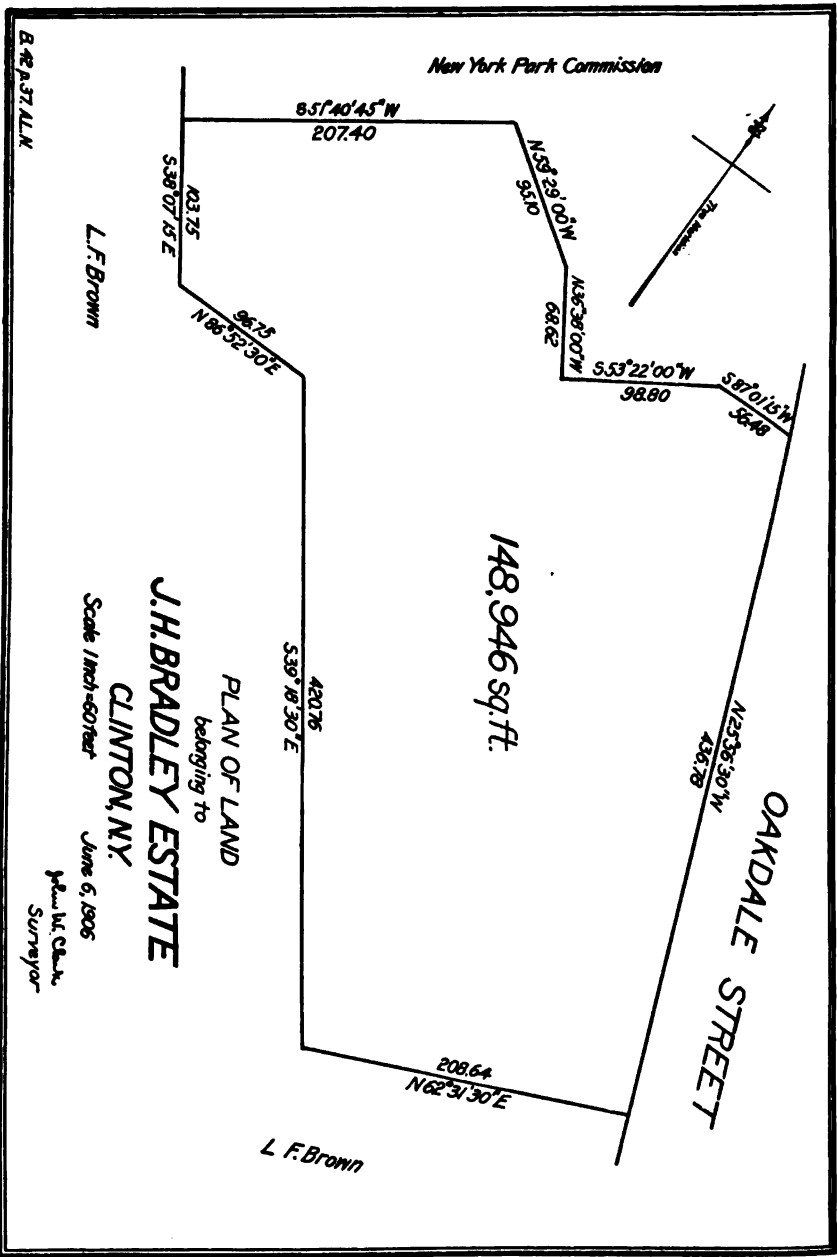

FIG. 179. COMPLETED LAND PLAN.
 (Scale of Reduced Drawing 1 inch = 120 feet.)

CHAPTER XVI.

FINISHING AND FILING DRAWINGS.

468. WHAT SHOULD APPEAR ON A DRAWING. — Drawings are made for a great variety of purposes, so that the data which a plan should contain depend entirely upon the use to which it is to be put. There are, however, several important things which should appear on every engineering drawing. In the first place, it should have a complete title which should be a brief description of the drawing. The title should state whether the drawing is a plan, cross-section, profile, etc. ; what it represents, — a lot of land, a sewer, a railroad, etc. ; the name of the owner ; the place ; the date ; the scale ; and the name of the surveyor. Besides the title, some plans, such as land plans, always require the names of owners of abutting property, and a meridian. Notes are frequently added giving such information as is necessary to interpret the plan. All essential dimensions are lettered in their proper places.

Besides these it is well to insert in some inconspicuous place (preferably near the border) the number of the note-book and the page from which the notes were plotted, and also the initials of the draftsman who made the drawing and of the man who checked it.

Fig. 179 represents a land plan which contains all of the essentials ; it is a plot of the land shown in the form of notes in Fig. 52, p. 103 ; its computations are on p. 362 ; and its working plot is illustrated by Fig. 176, p. 404.

469. TRAVERSE LINES. — The convenient use of a plan sometimes requires the traverse line to be shown on the completed drawing. In such a case it is usually shown as a full colored line, each of the angle points being represented by a very small circle of the same color, the center of which marks the angle point. Sometimes the lines of the traverse are drawn to the angle points

which are marked by very short lines bisecting the angles. Fig. 180 illustrates these two methods of marking transit points.

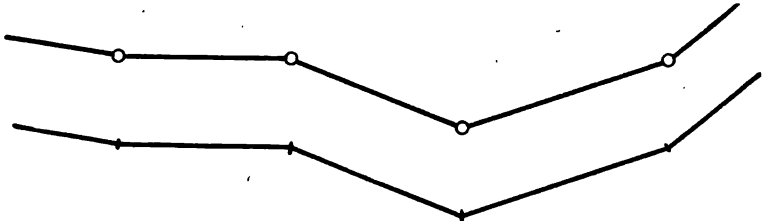

FIG. 180. METHODS OF MARKING ANGLE POINTS ON TRAVERSE LINES.

Triangulation stations are represented by a small equilateral triangle drawn around the station point. Fig. 115, p. 258, contains several examples of this.

470. PHYSICAL FEATURES. — The boundaries of property and the physical features which are represented on a plan, such as streets, buildings, etc., are usually drawn in black ink. Any additions or proposed changes are frequently drawn in colored ink, usually in red, although water-color is much better for the reasons stated in Art. 443, p. 395.

Shore lines and brooks are represented either in black or in Prussian blue. As a rule the shore line should be one of the heaviest, if not the heaviest line, on the drawing. Water-lining, shown in the topographical signs in Fig. 181, adds materially to the prominence and appearance of a shore line.

471. TOPOGRAPHIC CONVENTIONAL SIGNS. — On topographic maps certain physical features are shown by conventional signs which have come to be used so generally that they are practically standard throughout the country. A few of the more common of these symbols are shown in Fig. 181. The one representing "cultivated land" and the horizontal lines of the "salt marsh" and "fresh marsh" symbols are ruled; the rest are executed with an ordinary pen, Gillott's No. 303 being a good one for such work.

It will be noticed that in the symbol for "grass" the individual lines of a group all radiate from a center below the group, and also that they end on a horizontal line at the bottom. This

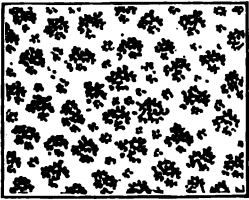

DECIDUOUS TREES (OAK).

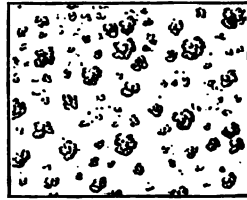

DECIDUOUS TREES (ROUND LEAF).

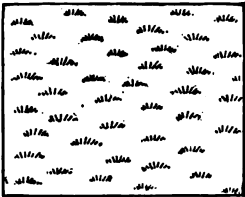

GRASS.

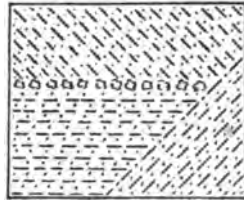

CULTIVATED LAND.

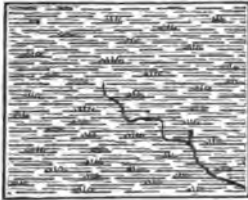

FRESH MARSH.

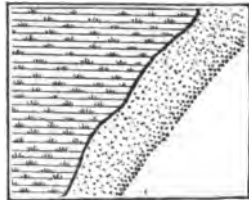

SALT MARSH — SAND.



WATERLINING.

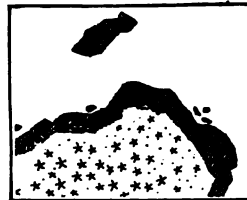

LEDGES — EVERGREEN TREES.

FIG. 181. TOPOGRAPHIC CONVENTIONAL SIGNS.

horizontal line, in the case of "grass" or "marsh" symbols, should always be parallel to the bottom of the map.

In executing "water-lining" the first line outside the shore line should be a light full line drawn just as close to the shore line as possible, and should follow very carefully every irregularity of the shore line. The next water-line should be drawn parallel to the first but with a little more space between them than was left between the shore line and the first water-line. Then the third water-line should be spaced a little farther out, and so on; five to ten lines are sufficient to represent this symbol properly. As the succession lines are added farther and farther from the shore line, the little irregularities of the shore gradually disappear until the outer water-line shows only a few irregularities opposite the most prominent ones of the shore.

Water-lining, as well as fresh marsh and salt marsh symbols, is often represented in Prussian blue. In fact, on some topographic maps most of the signs are represented by colors,—the trees by green, the grass by a light green tint, water by a light blue tint, cultivated land by yellow ochre, and so on.

Contour lines (shown in several of the cuts in Chapter X.) are almost always drawn in burnt sienna water-color. Every fifth or tenth contour is usually represented by a line slightly heavier and also a little darker in color. Gillott's No. 303 pen will be found to give good results for this work; but a contour pen, if it can be handled well, will give very uniform lines especially where the contours have no sharp turns. In numbering the contours some prefer to break the lines and place the numbers in the spaces, while others prefer to place the numbers just above or below the contours. Frequently a number is placed on every contour, but for most plans this is entirely unnecessary. If the contours are somewhat regular it is only necessary to number, say, every fifth contour. A good general rule to follow is to number only those lines which are necessary in order that the elevation of any contour may be found without appreciable mental effort. The numbers on the contours should be small plain figures in burnt sienna.

The shape of the surface of the ground is sometimes represented by hachure lines, which are illustrated in Fig. 182. The

contour lines are first sketched in pencil as a guide to the draftsman in drawing the hachure lines, which should be drawn normal to the contours. The short lines are drawn from the summit downward in rows, each row just touching the next preceding row. The steepness of the slope is represented by the weight and length of the lines,—the steeper the slope the heavier and shorter the lines. The individual lines are **equally** spaced, but on the flat slopes where the lines are lighter they have the appearance of being spaced farther apart.

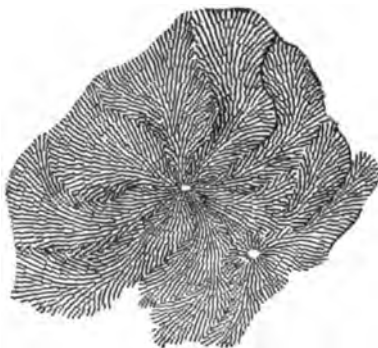

FIG. 182. HACHURE LINES.

472. Such physical features as railroads, highways, buildings,













	Building. (On large scale maps.)
	Barn or Shed. (On large scale maps.)
	Buildings. (On small scale maps.)
	Fence.
	City or Town Boundary.
	Stone wall.
	Stone Retaining wall.
	Single Track Railroad.
	Double Track Railroad.
	Roads.
	Trail.
	Trail.
	Bridge.
	Triangulation Station.
	Stadia Station.
	Transit Point. Intersection Point
B.M. x1232	Bench Mark. (in Triangulation.)

FIG. 183.

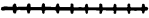
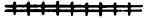
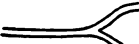
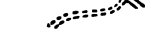
ROMAN

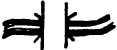
A B C D E F G H I J K L M N O P Q R S T U

V W X Y Z &

a b c d e f g h i j k l m n o p q r s t u v w x y z

GOTHIC

A B C D E F G H I J K L M N O P Q R S T U

V W X Y Z &

a b c d e f g h i j k l m n o p q r s t u v w x y z

*Swamp Writing**A B C D E F G H I J K L M N O P Q R S T U V W X Y Z**a b c d e f g h i j k l m n o p q r s t u v w x y z*1 2 3 4 5 6 7 8 9 0 $\frac{1}{2}$ $\frac{3}{4}$ $\frac{1}{4}$ $\frac{3}{8}$ 1 2 3 4 5 6 7 8 9 0 $\frac{1}{2}$ $\frac{3}{4}$

FIG. 184.

(Printed by permission of Professor A. E. Burton.)

A B C D E F G H I J K L M N O P Q R S T U V W X Y Z
abcdefghijklmnopqrstuvwxyz

1234567890 $\frac{1}{2}$ $\frac{3}{4}$

Reinhardt's Style

A B C D E F G H I J K L M N O P Q
R S T U V W X Y Z &

abcdefghijklmnopqrstuvwxyz

1234567890 $\frac{1}{2}$ $\frac{3}{4}$ $2\frac{3}{16}$ $5\frac{1}{8}$ 1234567890 $\frac{1}{8}$ $9\frac{7}{8}$ $\frac{3}{8}$

A B C D E F G H I J K L M N O P Q R S
T U V W X Y Z &

abcdefghijklmnopqrstuvwxyz

FIG. 186.
(Drawn by W. L. Vennard and E. D. Sewell.)

and boundaries are usually represented in black ink by the symbols shown in Fig. 183.

473. LETTERING.*— The lettering on a drawing probably has more to do with its appearance than any other feature. To be able to do good lettering at first is a gift which but few men possess. It is an art that can be acquired by the most awkward draftsman, however, if he will study it carefully and devote a little time to systematic practice.

Several different styles of lettering are shown in Figs. 184 and 185. The general style to use in any given case depends on the type of drawing and on the use to which it is to be put. On plans which are to be sent from the office as completed drawings such letters as the Roman or Gothic may be appropriate. Stump writing is a style of lettering which is difficult to execute but whose appearance, when well done, is very artistic. The ornate lettering in vogue a few years ago has been superseded by simpler styles which require much less time to produce. For construction drawings, like a plan of a bridge or a conduit, for example, the Reinhardt letters are used

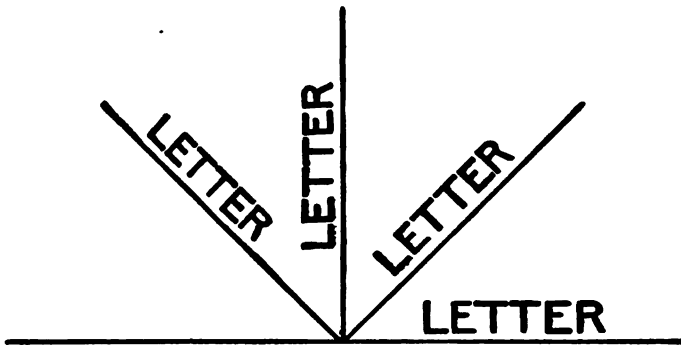

FIG. 186. LETTERING ON SLOPES.

* For a complete discussion and illustrations of lettering see any of the following publications: "Plain Lettering," by Professor Henry S. Jacoby, published by the Engineering News Publishing Company; "Technic of Mechanical Drafting," by Charles W. Reinhardt, published by the Engineering News Publishing Company; "Letter Plates," by Professor Charles L. Adams, Mass. Inst. of Technology, published by Professor Adams.

to a considerable extent. The title of such a plan looks well lettered in either erect or inclined Gothic.

All plans should be lettered so as to read from the bottom. Unless a draftsman exercises considerable care he will find, when the plan is completed, that some of the lettering is upside down. Fig. 186 illustrates the proper lettering of lines of various slopes.

474. Titles. — The design of the title of a plan gives the draftsman an opportunity to exercise good taste. It should be so arranged and the size of the letters so chosen that the most important part of the title strikes the eye first. In general, each line of lettering should be centered, and the spacing between the lines should be so arranged that no part will either appear crowded or seem to be floating away from the rest of the title. The general outline of the title should be pleasing to the eye. In some of the larger offices, in order to save the time of the draftsman, titles are set up in type and printed on the map.

Fig. 187 shows a set of titles which are well balanced and complete. Fig. 188 shows the style of lettering appropriate for a profile, a cross-section, or construction details.

*Preliminary Survey for a Railroad
from
Crescent Beach to Woodlawn Cemetery.*

October, 1892.

Scale 400 feet to 1 inch.

COMMONWEALTH OF MASSACHUSETTS.

METROPOLITAN WATER WORKS.

WACHUSETT DAM

UPPER GATE-CHAMBER.

JULY 9, 1900.

UNITED STATES
COAST AND GEODETIC SURVEY

SKETCH OF GENERAL PROGRESS

JUNE 30 1897

Eastern Sheet

FIG. 187. TITLES OF PLANS.

TRACK ELEVATION.
C. & W. I. R. R.
 Cross-Section of Bridge Showing
 Floor Construction.
 Scale $\frac{1}{2}$ in. = 1 ft.

HORIZONTAL SECTIONS

THROUGH UPPER
 SLUICE-GATE

THROUGH LOWER
 SLUICE-GATE

THROUGH LOWER
 VALVE WELL

0 1 2 3 4 5 6 FT.

Preliminary Profile
for a Railroad from
Redford Junction to North Liberty
Sta. 0 to Sta. 498+68.7
May 1906

FIG. 188. TITLES OF PROFILES.

475. Notes.—Most drawings require notes of some sort. These are usually executed with a plain letter like the Reinhardt alphabet. In Fig. 189 are a few samples the general style of which is consistent with modern practice.

*Note:—This reinforcement is 8'-0" long,
and comes directly under each track.
Leave ample room for bridge-seat.*

Note:—The datum plane used for contours and soundings on this map is "Boston City Base."

Boston City Base is 0.64 ft. below base known as "Mean Low Water at Navy Yard" which is the datum used by the U. S. Coast Survey, the U. S. Engineer's Office, and the Mass. Harbor and Land Commission.

Soundings and Contours confirmed and extended by data from map (L-476) on file with Massachusetts Harbor and Land Commission.

FIG. 189. SAMPLES OF NOTES.

476. Border Lines.— The border line of a drawing should consist of a heavy single line or double lines closely spaced. It should neither be so heavy nor of such fancy design as to be conspicuous. Plain clear drawings are the practice of to-day, and the border line should be in keeping with the rest of the drawing. For drawings 2 ft. long, the border should be about $\frac{3}{4}$ " from the edge of the sheet: for drawings 4 ft. long, 1" to $1\frac{1}{4}$ " looks well. On some, particularly office drawings, the border is unnecessary and may be undesirable. Fig. 190 gives a few examples of simple practical border lines.

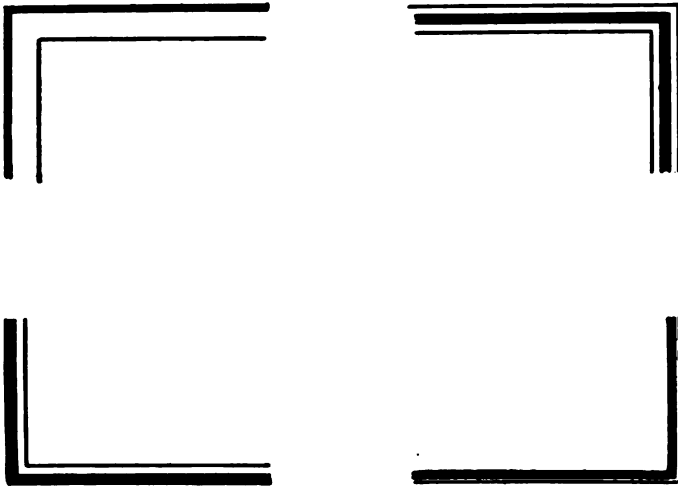

FIG. 190. BORDER LINES.

477. Meridians.— On all land plans it is customary to draw either the true or the magnetic meridian; often both of them are represented. To be in keeping with the rest of the drawing this should be simple in design. Too frequently, however, the draftsman attempts to "lay himself out" on the needle with the result that it is so large and ornate that it is the first thing in the drawing that strikes the eye. The simple meridians shown in Fig. 191 are suggested as suitable for ordinary land plans.

The plan should always be drawn, if possible, so that the

meridian will point, in general, toward the top of the drawing rather than toward the bottom. Sometimes it is drawn with its upper part above and its tail below the drawing. In such a case

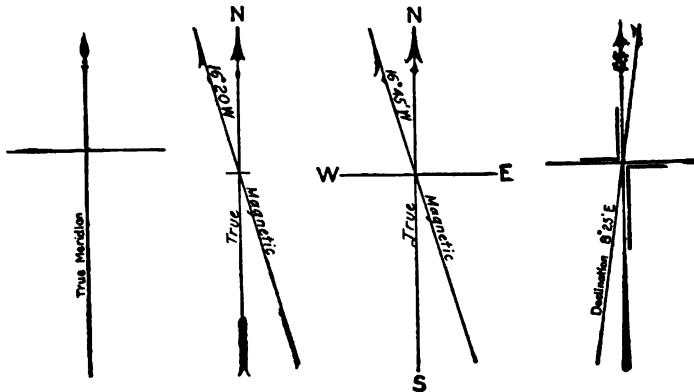

FIG. 191. MERIDIANS.

the line of the meridian must never cut any of the lines of the drawings: it should be interrupted far enough from the drawing so that it cannot be mistaken for one of the property lines.

478. Scales. — On account of the shrinkage of drawing paper the scale is sometimes drawn on the plan itself at the time that the drawing is plotted. It is well to have it sufficiently long, say, 3 to 10 inches (depending upon the size of the drawing), so that it will be of use in detecting the amount of shrinkage. This, of course, will determine the shrinkage only in the direction of the scale. These scales are usually placed directly under the title or in one of the lower corners. Fig. 192 gives two examples of scales.

In plotting a coördinate survey, the intersections of the north and south with the east and west lines should be marked on the finished drawing, as these are of great assistance in plotting additions. Moreover the distances between these points give a reliable measure of the change in scale of the map due to shrinkage.

479. SHRINKAGE OF DRAWING PAPERS. — All of the papers in use will shrink and swell more or less with variations of

weather conditions. The heavy mounted papers are affected the least, but large drawings even on such paper will be found on examination to change in size perceptibly. The fact that they do not always shrink the same amount in different directions

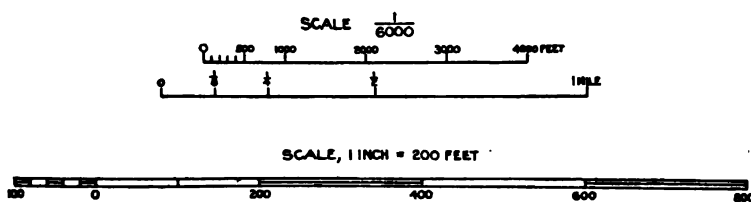

FIG. 192. SCALES.

makes it difficult to estimate the amount of the change and to allow for it. This effect can be estimated quite closely, however, by testing the drawing by measuring accurately a few lines running in different directions when it is plotted and scaling the same lines at any other time and making allowance for the change. Scaled distances on tracing cloth are quite unreliable if it is not kept in a dry place, and blue-prints generally shrink in washing so that scale measurements taken from them usually contain considerable error.

480. MAPS OF LARGE EXTENT. — Some maps, like the location map of a railroad or the map of a city, are so large that they must be made in sections. In such cases two slightly different methods are employed. One method is to plot the several sheets so that the drawing on one will extend to but not include any of the drawing on the adjacent sheet, the limits of the drawings being defined by straight lines. The other method is to have the drawing on each sheet lap over the drawings on the adjacent sheets a little. In this case marks are made on all drawings which make it possible to fit them to the corresponding marks on the adjacent drawings when they are being used jointly.

In attempting to arrange the sheets of adjacent drawings after they have been in use for any considerable time, it is often found that they do not fit well on account of the unequal shrinking and

swelling of the paper. Moreover in plotting lines on separate sheets so that they will fit exactly, there are mechanical difficulties which can only be appreciated by the draftsman who has had experience with them. These objections, together with the fact that a comprehensive view of the whole situation cannot be taken in at one time, have led some engineers to prefer large and unwieldy drawings to a system of separate sheets, but the latter are much more convenient when the plans are to be used in the field.

481. INKING IN A PROFILE. — The surface line is usually shown as a full firm black line and the grade line as a full red line (Art. 443, p. 395). A horizontal base-line is sometimes drawn in red a short distance above the bottom of the paper and vertical red lines are drawn from this line to the grade line at every change of gradient and at both ends of the profile. On these vertical lines are recorded the grade elevations at these points and the "plus" if the place where the gradient changes is not at a full station. On the base-line between these red vertical lines is recorded the gradient of the grade line above. Under the base-line is the stationing, which is marked at every heavy vertical ruling of the profile paper, together with any other notes of alignment which may be desired.

Information such as the names of streets, brooks, etc., is lettered vertically above the profile and at the proper station. A title and the scale are sometimes placed on the face of the profile; sometimes these are put on the back of the profile at one end of it (or both in the case of a long profile), so that the title can be read when it is rolled up.

482. CLEANING DRAWINGS. — Every drawing, during its construction, collects more or less dirt. Often construction lines are drawn which must be erased when the plan is completed. In cleaning a drawing an ordinary soft pencil eraser is used for the pencil lines while a sponge eraser or stale bread crumbs will remove the dirt satisfactorily without affecting the ink lines.

To take off the pencil lines and dirt from tracing cloth, wash the drawing with a cloth saturated with gasolene or benzine. This will remove pencil lines entirely and will clean

the tracing perfectly without any injurious effect on the tracing cloth.

483. FILING DRAWINGS. — While the particular method of filing plans varies considerably in different offices, there are a few general ideas carried out by all drafting offices in regard to the preservation as well as the systematic filing of drawings. There is no doubt that the best method of filing plans is to keep them flat, but this is not practicable with large plans which must usually be filed in rolls. In all systems of plan filing there appears to be a proper use of both flat and rolled plans.

In large offices plans are, as a rule, made in several standard sizes prescribed by the rules of the office, and are filed flat in shallow drawers which are built to fit the different sizes of drawings. In some offices the adherence to standard sizes is very rigid, and considerable time is often spent to bring drawings within the limits of one of these sizes. When these sizes are exceeded the plans are either made in sections of standard size, as explained in Art. 480, or they are made as large plans which are rolled and filed away in pasteboard tubes. Sometimes very large plans are filed flat by hanging them from an overhead frame.

Plans filed flat are marked each with its proper index number in one corner, preferably the lower right-hand corner, so that as the drawer is opened the numbers can be readily examined. In some offices it is required that in returning a drawing it shall be placed in its proper order in the drawer as well as in the proper drawer, while in other offices the plan drawers are made very shallow, so as to contain only about 15 or 20 drawings, and when a plan is returned no attempt is made to put it in any particular place in the drawer, there being, at the most, only a very few drawings to handle to obtain the one desired.

Rolled drawings are marked on the side of the rolls at each end so as to be easily read by one standing in front of the shelf on which the plans are stored. Another style of roll is closed at one end with a white label on the outside of the closed end. When the plan has been put into the tube it is so placed on the

shelf that the label on which the plan number is marked is at the front edge of the shelf where it can be conveniently read. When the plan is in use the empty tube is left on the shelf with its open end outward so that its number is in the back part of the shelf where it cannot be read.

Large plans which are made in sections are often filed in large folios or books in such a way that they can be readily taken out and used separately.

484. INDEXING DRAWINGS. — There are so many systems of indexing plans that no attempt will be made to explain them other than to suggest a few of the essentials of any good system. Every system of numbering the plans should be such that one can tell from its number whether the drawing is a sketch, a working drawing, a finished drawing, a tracing, or a process print. The numbering also should suggest the type of drawing, as a land plan, a construction plan, etc.

For offices where few plans are on file an index book may suffice for recording the plans, but in large drafting offices the card catalogue system is used extensively. By a judicious use of "markers" a card catalogue system can be so devised that it will be necessary to examine only a very few cards to find the one corresponding to any plan. Frequently it is necessary to index a plan by two or three different cards under different general headings.

485. FILING NOTE-BOOKS. — Note-books should always be filed in vaults where they will be protected against fire. Too frequently through lack of forethought note-books containing information which it has cost thousands of dollars to collect are carelessly filed on a shelf in the drafting office. In some offices the rules require that every note-book and valuable plan shall be placed in the vault at the end of the day's work, and this appears to be the proper practice.

Some offices go so far as to require that all notes shall be copied in ink and the original notes kept permanently filed in the vault to guard against their loss. Whether a copy is made or not, the **original** should be preserved as it has a value, in a lawsuit for instance, which any **copy** does not possess. When copies are made of the original notes they are sometimes made

in a loose-leaf book so that if any notes are taken from the office it is not necessary to take more than a very few leaves of the copy; the original notes never go from the office except in rare cases.

486. Indexing Notes. — The notes contained in the field notebooks are often indexed either in a book for this purpose or by means of a card catalogue. The method of indexing is similar to that used for plans.

487. Other Records. — Other records, such as borings, soundings, estimates, computations, etc., are carefully filed and indexed so that it will be easy to refer to them.

TABLES.



TABLE I.—LOGARITHMS OF NUMBERS.

N	0	1	2	3	4	5	6	7	8	9
100	00000	00043	00087	00130	00173	00217	00260	00303	00346	00389
1	0432	0475	0518	0561	0604	0647	0689	0732	0775	0817
2	0860	0903	0945	0988	1030	1072	1115	1157	1199	1242
3	1284	1326	1368	1410	1452	1494	1536	1578	1620	1662
4	1703	1745	1787	1828	1870	1912	1953	1995	2036	2078
5	2119	2160	2202	2243	2284	2325	2366	2407	2449	2490
6	2531	2572	2612	2653	2694	2735	2776	2816	2857	2898
7	2938	2979	3019	3060	3100	3141	3181	3222	3262	3302
8	3342	3383	3423	3463	3503	3543	3583	3623	3663	3703
9	3743	3782	3822	3862	3902	3941	3981	4021	4060	4100
110	04139	04179	04218	04258	04297	04336	04376	04415	04454	04493
1	4532	4571	4610	4650	4689	4727	4766	4805	4844	4883
2	4922	4961	4999	5038	5077	5115	5154	5192	5231	5269
3	5308	5346	5385	5423	5461	5500	5538	5576	5614	5652
4	5690	5729	5767	5805	5843	5881	5918	5956	5994	6032
5	6070	6108	6145	6183	6221	6258	6296	6333	6371	6408
6	6446	6483	6521	6558	6595	6633	6670	6707	6744	6781
7	6819	6856	6893	6930	6967	7004	7041	7078	7115	7151
8	7188	7225	7262	7298	7335	7372	7408	7445	7482	7518
9	7555	7591	7628	7664	7700	7737	7773	7809	7846	7882
120	07918	07954	07990	08027	08063	08099	08135	08171	08207	08243
1	8279	8314	8350	8386	8422	8458	8493	8529	8565	8600
2	8636	8672	8707	8743	8778	8814	8849	8884	8920	8955
3	8991	9026	9061	9096	9132	9167	9202	9237	9272	9307
4	9342	9377	9412	9447	9482	9517	9552	9587	9621	9656
5	9691	9726	9760	9795	9830	9864	9899	9934	9968	10003
6	10037	10072	10106	10140	10175	10209	10243	10278	10312	10346
7	10380	10415	10449	10483	10517	10551	10585	10619	10653	10687
8	10721	10755	10789	10823	10857	10890	10924	10958	10992	11025
9	11059	11093	11126	11160	11193	11227	11261	11294	11327	11361
130	11394	11428	11461	11494	11528	11561	11594	11628	11661	11694
1	1727	1760	1793	1826	1860	1893	1926	1959	1992	2024
2	2057	2090	2123	2156	2189	2222	2254	2287	2320	2352
3	2385	2418	2450	2483	2516	2548	2581	2613	2646	2678
4	2710	2743	2775	2808	2840	2872	2905	2937	2969	3001
5	3033	3066	3098	3130	3162	3194	3226	3258	3290	3322
6	3354	3386	3418	3450	3481	3513	3545	3577	3609	3640
7	3672	3704	3735	3767	3799	3830	3862	3893	3925	3956
8	3988	4019	4051	4082	4114	4145	4176	4208	4239	4270
9	4301	4333	4364	4395	4426	4457	4489	4520	4551	4582
140	14613	14644	14675	14706	14737	14768	14799	14829	14860	14891
1	4922	4953	4983	5014	5045	5076	5106	5137	5168	5198
2	5229	5259	5290	5320	5351	5381	5412	5442	5473	5503
3	5534	5564	5594	5625	5655	5685	5715	5746	5776	5806
4	5836	5866	5897	5927	5957	5987	6017	6047	6077	6107
5	6137	6167	6197	6227	6256	6286	6316	6346	6376	6406
6	6436	6465	6495	6524	6554	6584	6613	6643	6673	6702
7	6732	6761	6791	6820	6850	6879	6909	6938	6967	6997
8	7026	7056	7085	7114	7143	7173	7202	7231	7260	7289
9	7319	7348	7377	7406	7435	7464	7493	7522	7551	7580
150	17609	17638	17667	17696	17725	17754	17782	17811	17840	17869

TABLE I.—LOGARITHMS OF NUMBERS.

N	0	1	2	3	4	5	6	7	8	9
150	17609	17638	17667	17696	17725	17754	17782	17811	17840	17869
1	7898	7926	7955	7984	8013	8041	8070	8099	8127	8156
2	8184	8213	8241	8270	8298	8327	8355	8384	8412	8441
3	8469	8498	8526	8554	8583	8611	8639	8667	8696	8724
4	8752	8780	8808	8837	8865	8893	8921	8949	8977	9005
5	9033	9061	9089	9117	9145	9173	9201	9229	9257	9285
6	9312	9340	9368	9396	9424	9451	9479	9507	9535	9562
7	9590	9618	9645	9673	9700	9728	9756	9783	9811	9838
8	9866	9893	9921	9948	9976	20003	20030	20058	20085	20112
9	20140	20167	20194	20222	20249	0276	0303	0330	0358	0385
160	20412	20439	20466	20493	20520	20548	20575	20602	20629	20656
1	0683	0710	0737	0763	0790	0817	0844	0871	0898	0925
2	0952	0978	1005	1032	1059	1085	1112	1139	1165	1192
3	1219	1245	1272	1299	1325	1352	1378	1405	1431	1458
4	1484	1511	1537	1564	1590	1617	1643	1669	1696	1722
5	1748	1775	1801	1827	1854	1880	1906	1932	1958	1985
6	2011	2037	2063	2089	2115	2141	2167	2192	2219	2246
7	2272	2298	2324	2350	2376	2401	2427	2453	2479	2505
8	2531	2557	2583	2608	2634	2660	2686	2712	2737	2763
9	2789	2814	2840	2866	2891	2917	2943	2968	2994	3019
170	23045	23070	23096	23121	23147	23172	23198	23223	23249	23274
1	3300	3325	3350	3376	3401	3426	3452	3477	3502	3528
2	3553	3578	3603	3629	3654	3679	3704	3729	3754	3779
3	3805	3830	3855	3880	3905	3930	3955	3980	4005	4030
4	4055	4080	4105	4130	4155	4180	4204	4229	4254	4279
5	4304	4329	4353	4378	4403	4428	4452	4477	4502	4527
6	4551	4576	4601	4625	4650	4674	4699	4724	4748	4773
7	4797	4822	4846	4871	4895	4920	4944	4969	4993	5018
8	5042	5066	5091	5115	5139	5164	5188	5212	5237	5261
9	5285	5310	5334	5358	5382	5406	5431	5455	5479	5503
180	25527	25551	25575	25600	25624	25648	25672	25696	25720	25744
1	5788	5792	5816	5840	5864	5888	5912	5935	5959	5983
2	6007	6031	6055	6079	6102	6126	6150	6174	6198	6221
3	6245	6269	6293	6316	6340	6364	6387	6411	6435	6458
4	6482	6505	6529	6553	6576	6600	6623	6647	6670	6694
5	6717	6741	6764	6788	6811	6834	6858	6881	6905	6928
6	6951	6975	6998	7021	7045	7068	7091	7114	7138	7161
7	7184	7207	7231	7254	7277	7300	7323	7346	7370	7393
8	7416	7439	7462	7485	7508	7531	7554	7577	7600	7623
9	7646	7669	7692	7715	7738	7761	7784	7807	7830	7852
190	27875	27898	27921	27944	27967	27989	28012	28035	28058	28081
1	8103	8126	8149	8171	8194	8217	8240	8262	8285	8307
2	8330	8353	8375	8398	8421	8443	8466	8488	8511	8533
3	8556	8578	8601	8623	8646	8668	8691	8713	8735	8758
4	8780	8803	8825	8847	8870	8892	8914	8937	8959	8981
5	9003	9026	9048	9070	9092	9115	9137	9159	9181	9203
6	9226	9248	9270	9292	9314	9336	9358	9380	9403	9425
7	9447	9469	9491	9513	9535	9557	9579	9601	9623	9645
8	9667	9688	9710	9732	9754	9776	9798	9820	9842	9863
9	9885	9907	9929	9951	9973	9994	30016	30038	30060	30081
200	30103	30125	30146	30168	30190	30211	30233	30255	30276	30298

TABLE I.—LOGARITHMS OF NUMBERS.

N	0	1	2	3	4	5	6	7	8	9
200	30103	30125	30146	30168	30190	30211	30233	30255	30276	30298
1	0320	0341	0363	0384	0406	0428	0449	0471	0492	0514
2	0535	0557	0578	0600	0621	0643	0664	0685	0707	0728
3	0750	0771	0792	0814	0835	0856	0878	0899	0920	0942
4	0963	0984	1006	1027	1048	1069	1091	1112	1133	1154
5	1175	1197	1218	1239	1260	1281	1302	1323	1345	1366
6	1387	1408	1429	1450	1471	1492	1513	1534	1555	1576
7	1597	1618	1639	1660	1681	1702	1723	1744	1765	1785
8	1806	1827	1848	1869	1890	1911	1931	1952	1973	1994
9	2015	2035	2056	2077	2098	2118	2139	2160	2181	2201
210	32222	32243	32263	32284	32305	32325	32346	32366	32387	32408
1	2428	2449	2469	2490	2510	2531	2552	2572	2593	2613
2	2634	2654	2675	2695	2715	2736	2756	2777	2797	2818
3	2838	2858	2879	2899	2919	2940	2960	2980	3001	3021
4	3041	3062	3082	3102	3122	3143	3163	3183	3203	3224
5	3244	3264	3284	3304	3325	3345	3365	3385	3405	3425
6	3445	3465	3486	3506	3526	3546	3566	3586	3606	3626
7	3646	3666	3686	3706	3726	3746	3766	3786	3806	3826
8	3846	3866	3885	3905	3925	3945	3965	3985	4005	4025
9	4044	4064	4084	4104	4124	4143	4163	4183	4203	4223
220	34242	34262	34282	34301	34321	34341	34361	34380	34400	34420
1	4439	4459	4479	4498	4518	4537	4557	4577	4596	4616
2	4635	4655	4674	4694	4713	4733	4753	4772	4792	4811
3	4830	4850	4869	4889	4908	4928	4947	4967	4986	5005
4	5025	5044	5064	5083	5102	5122	5141	5160	5180	5199
5	5218	5238	5257	5276	5295	5315	5334	5353	5372	5392
6	5411	5430	5449	5468	5488	5507	5526	5545	5564	5583
7	5603	5622	5641	5660	5679	5698	5717	5736	5755	5774
8	5793	5813	5832	5851	5870	5889	5908	5927	5946	5965
9	5984	6003	6021	6040	6059	6078	6097	6116	6135	6154
230	36173	36192	36211	36229	36248	36267	36286	36305	36324	36342
1	6361	6380	6399	6418	6436	6455	6474	6493	6511	6530
2	6549	6568	6586	6605	6624	6642	6661	6680	6698	6717
3	6736	6754	6773	6791	6810	6829	6847	6866	6884	6903
4	6922	6940	6959	6977	6996	7014	7033	7051	7070	7088
5	7107	7125	7144	7162	7181	7199	7218	7236	7254	7273
6	7291	7310	7328	7346	7365	7383	7401	7420	7438	7457
7	7475	7493	7511	7530	7548	7566	7585	7603	7621	7639
8	7658	7676	7694	7712	7731	7749	7767	7785	7803	7822
9	7840	7858	7876	7894	7912	7931	7949	7967	7985	8003
240	38021	38039	38057	38075	38093	38112	38130	38148	38166	38184
1	8202	8220	8238	8256	8274	8292	8310	8328	8346	8364
2	8382	8399	8417	8435	8453	8471	8489	8507	8525	8543
3	8561	8578	8596	8614	8632	8650	8668	8686	8703	8721
4	8739	8757	8775	8792	8810	8828	8846	8863	8881	8899
5	8917	8934	8952	8970	8987	9005	9023	9041	9058	9076
6	9094	9111	9129	9146	9164	9182	9199	9217	9235	9252
7	9270	9287	9305	9322	9340	9358	9375	9393	9410	9428
8	9445	9463	9480	9498	9515	9533	9550	9568	9585	9602
9	9620	9637	9655	9672	9690	9707	9724	9742	9759	9777
250	39794	39811	39829	39846	39863	39881	39898	39915	39933	39950

TABLE I.—LOGARITHMS OF NUMBERS.

N	0	1	2	3	4	5	6	7	8	9
250	39794	39811	39829	39846	39863	39881	39898	39915	39933	39950
1	9967	9985	40002	40019	40037	40054	40071	40088	40106	40123
2	40140	40157	0175	0192	0209	0226	0243	0261	0278	0295
3	0312	0329	0346	0364	0381	0398	0415	0432	0449	0466
4	0483	0500	0518	0535	0552	0569	0586	0603	0620	0637
5	0654	0671	0688	0705	0722	0739	0756	0773	0790	0807
6	0824	0841	0858	0875	0892	0909	0926	0943	0960	0976
7	0993	1010	1027	1044	1061	1078	1095	1111	1128	1145
8	1162	1179	1196	1212	1229	1246	1263	1280	1296	1313
9	1330	1347	1363	1380	1397	1414	1430	1447	1464	1481
260	41497	41514	41531	41547	41564	41581	41597	41614	41631	41647
1	1684	1681	1697	1714	1731	1747	1764	1780	1797	1814
2	1830	1847	1863	1880	1896	1913	1929	1946	1963	1979
3	1996	2012	2029	2045	2062	2078	2095	2111	2127	2144
4	2160	2177	2193	2210	2226	2243	2259	2275	2292	2308
5	2325	2341	2357	2374	2390	2406	2423	2439	2455	2472
6	2488	2504	2521	2537	2553	2570	2586	2602	2619	2635
7	2651	2667	2684	2700	2716	2732	2749	2765	2781	2797
8	2813	2830	2846	2862	2878	2894	2911	2927	2943	2959
9	2975	2991	3008	3024	3040	3056	3072	3088	3104	3120
270	43136	43152	43169	43185	43201	43217	43233	43249	43265	43281
1	3297	3313	3329	3345	3361	3377	3393	3409	3425	3441
2	3457	3473	3489	3505	3521	3537	3553	3569	3584	3600
3	3616	3632	3648	3664	3680	3696	3712	3727	3743	3759
4	3775	3791	3807	3823	3838	3854	3870	3886	3902	3917
5	3933	3949	3965	3981	3996	4012	4028	4044	4059	4075
6	4091	4107	4122	4138	4154	4170	4186	4201	4217	4232
7	4248	4264	4279	4295	4311	4326	4342	4358	4373	4389
8	4404	4420	4436	4451	4467	4483	4498	4514	4529	4545
9	4560	4576	4592	4607	4623	4638	4654	4669	4685	4700
280	44716	44731	44747	44762	44778	44793	44809	44824	44840	44855
1	4871	4886	4902	4917	4932	4948	4963	4979	4994	5010
2	5025	5040	5056	5071	5086	5102	5117	5133	5148	5163
3	5179	5194	5209	5225	5240	5255	5271	5286	5301	5317
4	5332	5347	5362	5378	5393	5408	5423	5439	5454	5469
5	5484	5500	5515	5530	5545	5561	5576	5591	5606	5621
6	5637	5652	5667	5682	5697	5712	5728	5743	5758	5773
7	5788	5803	5818	5834	5849	5864	5879	5894	5909	5924
8	5939	5954	5969	5984	6000	6015	6030	6045	6060	6075
9	6090	6105	6120	6135	6150	6165	6180	6195	6210	6225
290	46240	46255	46270	46285	46300	46315	46330	46345	46359	46374
1	6389	6404	6419	6434	6449	6464	6479	6494	6509	6523
2	6538	6553	6568	6583	6598	6613	6627	6642	6657	6672
3	6687	6702	6716	6731	6746	6761	6776	6790	6805	6820
4	6835	6850	6864	6879	6894	6909	6923	6938	6953	6967
5	6982	6997	7012	7026	7041	7056	7070	7085	7100	7114
6	7129	7144	7159	7173	7188	7202	7217	7232	7246	7261
7	7276	7290	7305	7319	7334	7349	7363	7378	7392	7407
8	7422	7436	7451	7465	7480	7494	7509	7524	7538	7553
9	7567	7582	7596	7611	7625	7640	7654	7669	7683	7698
300	47712	47727	47741	47756	47770	47784	47799	47813	47828	47842

TABLE I.—LOGARITHMS OF NUMBERS.

N	0	1	2	3	4	5	6	7	8	9
800	47712	47727	47741	47756	47770	47784	47799	47813	47828	47842
1	7867	7871	7885	7900	7914	7929	7943	7958	7972	7986
2	8001	8015	8029	8044	8058	8073	8087	8101	8116	8130
3	8144	8159	8173	8187	8202	8216	8230	8244	8259	8273
4	8287	8302	8316	8330	8344	8359	8373	8387	8401	8416
5	8430	8444	8458	8473	8487	8501	8515	8530	8544	8558
6	8572	8586	8601	8615	8629	8643	8657	8671	8686	8700
7	8714	8728	8742	8756	8770	8785	8799	8813	8827	8841
8	8855	8869	8883	8897	8911	8926	8940	8954	8968	8982
9	8996	9010	9024	9038	9052	9066	9080	9094	9108	9122
810	49136	49150	49164	49178	49192	49206	49220	49234	49248	49262
1	9276	9290	9304	9318	9332	9346	9360	9374	9388	9402
2	9415	9429	9443	9457	9471	9485	9499	9513	9527	9541
3	9554	9568	9582	9596	9610	9624	9638	9651	9665	9679
4	9693	9707	9721	9734	9748	9762	9776	9790	9803	9817
5	9831	9845	9859	9872	9886	9900	9914	9927	9941	9955
6	9969	9982	9996	50010	50024	50037	50051	50065	50079	50092
7	50106	50120	50133	0147	0161	0174	0188	0202	0215	0229
8	0243	0256	0270	0284	0297	0311	0325	0338	0352	0365
9	0379	0393	0406	0420	0433	0447	0461	0474	0488	0501
820	50515	50529	50542	50556	50569	50583	50596	50610	50623	50637
1	0661	0664	0678	0691	0705	0718	0732	0745	0759	0772
2	0786	0799	0813	0826	0840	0853	0866	0880	0893	0907
3	0920	0934	0947	0961	0974	0987	1001	1014	1028	1041
4	1055	1068	1081	1095	1108	1121	1135	1148	1162	1175
5	1188	1202	1215	1228	1242	1255	1268	1282	1295	1308
6	1322	1335	1348	1362	1375	1388	1402	1415	1428	1441
7	1455	1468	1481	1495	1508	1521	1534	1548	1561	1574
8	1587	1601	1614	1627	1640	1654	1667	1680	1693	1706
9	1720	1733	1746	1759	1772	1786	1799	1812	1825	1838
830	51851	51865	51878	51891	51904	51917	51930	51943	51957	51970
1	1983	1996	2009	2022	2035	2048	2061	2075	2088	2101
2	2114	2127	2140	2153	2166	2179	2192	2205	2218	2231
3	2244	2257	2270	2284	2297	2310	2323	2336	2349	2362
4	2375	2388	2401	2414	2427	2440	2453	2466	2479	2492
5	2504	2517	2530	2543	2556	2569	2582	2595	2608	2621
6	2634	2647	2660	2673	2686	2699	2711	2724	2737	2750
7	2763	2776	2789	2802	2815	2827	2840	2853	2866	2879
8	2892	2905	2917	2930	2943	2956	2969	2982	2994	3007
9	3020	3033	3046	3058	3071	3084	3097	3110	3122	3135
840	53148	53161	53173	53186	53199	53212	53224	53237	53250	53263
1	3275	3288	3301	3314	3326	3339	3352	3364	3377	3390
2	3403	3415	3428	3441	3453	3466	3479	3491	3504	3517
3	3529	3542	3555	3567	3580	3593	3605	3618	3631	3643
4	3656	3668	3681	3694	3706	3719	3732	3744	3757	3769
5	3782	3794	3807	3820	3832	3845	3857	3870	3882	3895
6	3908	3920	3933	3945	3958	3970	3983	3995	4008	4020
7	4033	4045	4058	4070	4083	4095	4108	4120	4133	4145
8	4158	4170	4183	4195	4208	4220	4233	4245	4258	4270
9	4283	4295	4307	4320	4332	4345	4357	4370	4382	4394
350	54407	54419	54432	54444	54456	54469	54481	54494	54506	54518

TABLE I.—LOGARITHMS OF NUMBERS.

N	0	1	2	3	4	5	6	7	8	9
850	54407	54419	54432	54444	54456	54469	54481	54494	54506	54518
1	4531	4543	4555	4568	4580	4593	4605	4617	4630	4642
2	4654	4667	4679	4691	4704	4716	4728	4741	4753	4765
3	4777	4790	4802	4814	4827	4839	4851	4864	4876	4888
4	4900	4913	4925	4937	4949	4962	4974	4986	4998	5011
5	5023	5035	5047	5060	5072	5084	5096	5108	5121	5133
6	5145	5157	5169	5182	5194	5206	5218	5230	5242	5255
7	5267	5279	5291	5303	5315	5328	5340	5352	5364	5376
8	5388	5400	5413	5425	5437	5449	5461	5473	5485	5497
9	5509	5522	5534	5546	5558	5570	5582	5594	5606	5618
860	55630	55642	55654	55666	55678	55691	55703	55715	55727	55739
1	5761	5763	5775	5787	5799	5811	5823	5835	5847	5859
2	5871	5883	5895	5907	5919	5931	5943	5955	5967	5979
3	5991	6003	6015	6027	6038	6050	6062	6074	6086	6098
4	6110	6122	6134	6146	6158	6170	6182	6194	6205	6217
5	6229	6241	6253	6265	6277	6289	6301	6312	6324	6336
6	6348	6360	6372	6384	6396	6407	6419	6431	6443	6455
7	6467	6478	6490	6502	6514	6526	6538	6549	6561	6573
8	6585	6597	6608	6620	6632	6644	6656	6667	6679	6691
9	6703	6714	6726	6738	6750	6761	6773	6785	6797	6808
870	56820	56832	56844	56855	56867	56879	56891	56902	56914	56926
1	6937	6949	6961	6972	6984	6996	7008	7019	7031	7043
2	7054	7066	7078	7089	7101	7113	7124	7136	7148	7159
3	7171	7183	7194	7206	7217	7229	7241	7252	7264	7276
4	7287	7299	7310	7322	7334	7345	7357	7368	7380	7392
5	7403	7415	7426	7438	7449	7461	7473	7484	7496	7507
6	7519	7530	7542	7553	7565	7576	7588	7600	7611	7623
7	7634	7646	7657	7669	7680	7692	7703	7715	7726	7738
8	7749	7761	7772	7784	7795	7807	7818	7830	7841	7852
9	7864	7875	7887	7898	7910	7921	7933	7944	7955	7967
880	57978	57990	58001	58013	58024	58035	58047	58058	58070	58081
1	8092	8104	8115	8127	8138	8149	8161	8172	8184	8195
2	8206	8218	8229	8240	8252	8263	8274	8286	8297	8309
3	8320	8331	8343	8354	8365	8377	8388	8399	8410	8422
4	8433	8444	8456	8467	8478	8490	8501	8512	8524	8535
5	8546	8557	8569	8580	8591	8602	8614	8625	8636	8647
6	8659	8670	8681	8692	8704	8715	8726	8737	8749	8760
7	8771	8782	8794	8805	8816	8827	8838	8850	8861	8872
8	8883	8894	8906	8917	8928	8939	8950	8961	8973	8984
9	8995	9006	9017	9028	9040	9051	9062	9073	9084	9095
890	59106	59118	59129	59140	59151	59162	59173	59184	59195	59207
1	9218	9229	9240	9251	9262	9273	9284	9295	9306	9318
2	9329	9340	9351	9362	9373	9384	9395	9406	9417	9428
3	9439	9450	9461	9472	9483	9494	9506	9517	9528	9539
4	9550	9561	9572	9583	9594	9605	9616	9627	9638	9649
5	9660	9671	9682	9693	9704	9715	9726	9737	9748	9759
6	9770	9780	9791	9802	9813	9824	9835	9846	9857	9868
7	9879	9890	9901	9912	9923	9934	9945	9956	9968	9977
8	9988	9999	60010	60021	60032	60043	60054	60065	60076	60086
9	60097	60108	0119	0130	0141	0152	0163	0173	0184	0195
400	60206	60217	60228	60239	60249	60260	60271	60282	60293	60304

TABLE I.—LOGARITHMS OF NUMBERS.

N	0	1	2	3	4	5	6	7	8	9
400	60206	60217	60228	60239	60249	60260	60271	60282	60293	60304
1	0314	0325	0336	0347	0358	0369	0379	0390	0401	0412
2	0423	0433	0444	0455	0466	0477	0487	0498	0509	0520
3	0531	0541	0552	0563	0574	0584	0595	0606	0617	0627
4	0638	0649	0660	0670	0681	0692	0703	0713	0724	0735
5	0746	0756	0767	0778	0788	0799	0810	0821	0831	0842
6	0853	0863	0874	0885	0895	0906	0917	0927	0938	0949
7	0959	0970	0981	0991	1002	1013	1023	1034	1045	1055
8	1066	1077	1087	1098	1109	1119	1130	1140	1151	1162
9	1172	1183	1194	1204	1215	1225	1236	1247	1257	1268
410	61278	61289	61300	61310	61321	61331	61342	61352	61363	61374
1	1384	1395	1405	1416	1426	1437	1448	1458	1469	1479
2	1490	1500	1511	1521	1532	1542	1553	1563	1574	1584
3	1595	1606	1616	1627	1637	1648	1658	1669	1679	1690
4	1700	1711	1721	1731	1742	1752	1763	1773	1784	1794
5	1805	1815	1826	1836	1847	1857	1868	1878	1888	1899
6	1909	1920	1930	1941	1951	1962	1972	1982	1993	2003
7	2014	2024	2034	2045	2055	2066	2076	2086	2097	2107
8	2118	2128	2138	2149	2159	2170	2180	2190	2201	2211
9	2221	2232	2242	2252	2263	2273	2284	2294	2304	2315
420	62325	62335	62346	62356	62366	62377	62387	62397	62408	62418
1	2428	2439	2449	2459	2469	2480	2490	2500	2511	2521
2	2531	2542	2552	2562	2572	2583	2593	2603	2613	2624
3	2634	2644	2655	2665	2675	2685	2696	2706	2716	2726
4	2737	2747	2757	2767	2778	2788	2798	2808	2818	2829
5	2839	2849	2859	2870	2880	2890	2900	2910	2921	2931
6	2941	2951	2961	2972	2982	2992	3002	3012	3022	3033
7	3043	3053	3063	3073	3083	3094	3104	3114	3124	3134
8	3144	3155	3165	3175	3185	3195	3205	3215	3225	3236
9	3246	3256	3266	3276	3286	3296	3306	3317	3327	3337
430	63347	63357	63367	63377	63387	63397	63407	63417	63428	63438
1	3448	3458	3468	3478	3488	3498	3508	3518	3528	3538
2	3548	3558	3568	3579	3589	3599	3609	3619	3629	3639
3	3649	3659	3669	3679	3689	3699	3709	3719	3729	3739
4	3749	3759	3769	3779	3789	3799	3809	3819	3829	3839
5	3849	3859	3869	3879	3889	3899	3909	3919	3929	3939
6	3949	3959	3969	3979	3988	3998	4008	4018	4028	4038
7	4048	4058	4068	4078	4088	4098	4108	4118	4128	4137
8	4147	4157	4167	4177	4187	4197	4207	4217	4227	4237
9	4246	4256	4266	4276	4286	4296	4306	4316	4326	4336
440	64345	64355	64365	64375	64385	64395	64404	64414	64424	64434
1	4444	4454	4464	4473	4483	4493	4503	4513	4523	4532
2	4542	4552	4562	4572	4582	4591	4601	4611	4621	4631
3	4640	4650	4660	4670	4680	4689	4699	4709	4719	4729
4	4738	4748	4758	4768	4777	4787	4797	4807	4816	4826
5	4836	4846	4856	4865	4875	4885	4895	4904	4914	4924
6	4933	4943	4953	4963	4972	4982	4992	5002	5011	5021
7	5031	5040	5050	5060	5070	5079	5089	5099	5108	5118
8	5128	5137	5147	5157	5167	5176	5186	5196	5205	5215
9	5225	5234	5244	5254	5263	5273	5283	5292	5302	5312
450	65321	65331	65341	65350	65360	65369	65379	65389	65398	65408

TABLE I.—LOGARITHMS OF NUMBERS.

N	0	1	2	3	4	5	6	7	8	9
450	65321	65331	65341	65350	65360	65369	65379	65389	65398	65408
1	5418	5427	5437	5447	5456	5466	5475	5485	5495	5504
2	5514	5523	5533	5543	5552	5562	5571	5581	5591	5600
3	5610	5619	5629	5639	5648	5658	5667	5677	5686	5696
4	5706	5715	5725	5734	5744	5753	5763	5772	5782	5792
5	5801	5811	5820	5830	5839	5849	5858	5868	5877	5887
6	5896	5906	5916	5925	5935	5944	5954	5963	5973	5982
7	5992	6001	6011	6020	6030	6039	6049	6058	6068	6077
8	6087	6096	6106	6115	6124	6134	6143	6153	6162	6172
9	6181	6191	6200	6210	6219	6229	6238	6247	6257	6266
460	66276	66285	66295	66304	66314	66323	66332	66342	66351	66361
1	6370	6380	6389	6398	6408	6417	6427	6436	6445	6455
2	6464	6474	6483	6492	6502	6511	6521	6530	6539	6549
3	6558	6567	6577	6586	6596	6605	6614	6624	6633	6642
4	6652	6661	6671	6680	6689	6699	6708	6717	6727	6736
5	6745	6755	6764	6773	6783	6792	6801	6811	6820	6829
6	6839	6848	6857	6867	6876	6885	6894	6904	6913	6922
7	6932	6941	6950	6960	6969	6978	6987	6997	7006	7015
8	7025	7034	7043	7052	7062	7071	7080	7089	7099	7108
9	7117	7127	7136	7145	7154	7164	7173	7182	7191	7201
470	67210	67219	67228	67237	67247	67256	67265	67274	67284	67293
1	7302	7311	7321	7330	7339	7348	7357	7367	7376	7385
2	7394	7403	7413	7422	7431	7440	7449	7459	7468	7477
3	7486	7495	7504	7514	7523	7532	7541	7550	7560	7569
4	7578	7587	7596	7605	7614	7624	7633	7642	7651	7660
5	7669	7679	7688	7697	7706	7715	7724	7733	7742	7752
6	7761	7770	7779	7788	7797	7806	7815	7825	7834	7843
7	7852	7861	7870	7879	7888	7897	7906	7916	7925	7934
8	7943	7952	7961	7970	7979	7988	7997	8006	8015	8024
9	8034	8043	8052	8061	8070	8079	8088	8097	8106	8115
480	68124	68133	68142	68151	68160	68169	68178	68187	68196	68205
1	8215	8224	8233	8242	8251	8260	8269	8278	8287	8296
2	8305	8314	8323	8332	8341	8350	8359	8368	8377	8386
3	8395	8404	8413	8422	8431	8440	8449	8458	8467	8476
4	8485	8494	8502	8511	8520	8529	8538	8547	8556	8565
5	8574	8583	8592	8601	8610	8619	8628	8637	8646	8655
6	8664	8673	8681	8690	8699	8708	8717	8726	8735	8744
7	8753	8762	8771	8780	8789	8797	8806	8815	8824	8833
8	8842	8851	8860	8869	8878	8886	8895	8904	8913	8922
9	8931	8940	8949	8958	8966	8975	8984	8993	9002	9011
490	69020	69028	69037	69046	69055	69064	69073	69082	69090	69099
1	9108	9117	9126	9135	9144	9152	9161	9170	9179	9188
2	9197	9205	9214	9223	9232	9241	9249	9258	9267	9276
3	9285	9294	9302	9311	9320	9329	9338	9346	9355	9364
4	9373	9381	9390	9399	9408	9417	9425	9434	9443	9452
5	9461	9469	9478	9487	9496	9504	9513	9522	9531	9539
6	9548	9557	9566	9574	9583	9592	9601	9609	9618	9627
7	9636	9644	9653	9662	9671	9679	9688	9697	9705	9714
8	9723	9732	9740	9749	9758	9767	9775	9784	9793	9801
9	9810	9819	9827	9836	9845	9854	9862	9871	9880	9888
500	69897	69906	69914	69923	69932	69940	69949	69958	69966	69975

TABLE I.—LOGARITHMS OF NUMBERS.

N	0	1	2	3	4	5	6	7	8	9
500	69897	69906	69914	69923	69932	69940	69949	69958	69966	69975
1	9984	9992	70001	70010	70018	70027	70036	70044	70053	70062
2	70070	70079	0088	0096	0105	0114	0122	0131	0140	0148
3	0157	0165	0174	0183	0191	0200	0209	0217	0226	0234
4	0243	0252	0260	0269	0278	0286	0295	0303	0312	0321
5	0329	0338	0346	0355	0364	0372	0381	0389	0398	0406
6	0415	0424	0432	0441	0449	0458	0467	0475	0484	0492
7	0501	0509	0518	0526	0535	0544	0552	0561	0569	0578
8	0586	0595	0603	0612	0621	0629	0638	0646	0655	0663
9	0672	0680	0689	0697	0706	0714	0723	0731	0740	0749
510	70757	70766	70774	70783	70791	70800	70808	70817	70825	70834
1	0842	0851	0859	0868	0876	0885	0893	0902	0910	0919
2	0927	0935	0944	0952	0961	0969	0978	0986	0995	1003
3	1012	1020	1029	1037	1046	1054	1063	1071	1079	1088
4	1096	1105	1113	1122	1130	1139	1147	1155	1164	1172
5	1181	1189	1198	1206	1214	1223	1231	1240	1248	1257
6	1265	1273	1282	1290	1299	1307	1315	1324	1332	1341
7	1349	1357	1366	1374	1383	1391	1399	1408	1416	1425
8	1433	1441	1450	1458	1466	1475	1483	1492	1500	1508
9	1517	1525	1533	1542	1550	1559	1567	1575	1584	1592
520	71600	71609	71617	71625	71634	71642	71650	71659	71667	71675
1	1684	1692	1700	1709	1717	1725	1734	1742	1750	1759
2	1767	1775	1784	1792	1800	1809	1817	1825	1834	1842
3	1850	1858	1867	1875	1883	1892	1900	1908	1917	1925
4	1933	1941	1950	1958	1966	1975	1983	1991	1999	2008
5	2016	2024	2032	2041	2049	2057	2066	2074	2082	2090
6	2099	2107	2115	2123	2132	2140	2148	2156	2165	2173
7	2181	2189	2198	2206	2214	2222	2230	2239	2247	2255
8	2263	2272	2280	2288	2296	2304	2313	2321	2329	2337
9	2346	2354	2362	2370	2378	2387	2395	2403	2411	2419
530	72428	72436	72444	72452	72460	72469	72477	72485	72493	72501
1	2509	2518	2526	2534	2542	2550	2558	2567	2575	2583
2	2591	2599	2607	2616	2624	2632	2640	2648	2656	2665
3	2673	2681	2689	2697	2705	2713	2722	2730	2738	2746
4	2754	2762	2770	2779	2787	2795	2803	2811	2819	2827
5	2835	2843	2852	2860	2868	2876	2884	2892	2900	2908
6	2916	2925	2933	2941	2949	2957	2965	2973	2981	2989
7	2997	3006	3014	3022	3030	3038	3046	3054	3062	3070
8	3078	3086	3094	3102	3111	3119	3127	3135	3143	3151
9	3159	3167	3175	3183	3191	3199	3207	3215	3223	3231
540	73239	73247	73255	73263	73272	73280	73288	73296	73304	73312
1	3320	3328	3336	3344	3352	3360	3368	3376	3384	3392
2	3400	3408	3416	3424	3432	3440	3448	3456	3464	3472
3	3480	3488	3496	3504	3512	3520	3528	3536	3544	3552
4	3560	3568	3576	3584	3592	3600	3608	3616	3624	3632
5	3640	3648	3656	3664	3672	3679	3687	3695	3703	3711
6	3719	3727	3735	3743	3751	3759	3767	3775	3783	3791
7	3799	3807	3815	3823	3830	3838	3846	3854	3862	3870
8	3878	3886	3894	3902	3910	3918	3926	3933	3941	3949
9	3957	3965	3973	3981	3989	3997	4005	4013	4020	4028
550	74036	74044	74052	74060	74068	74076	74084	74092	74099	74107

TABLE I.—LOGARITHMS OF NUMBERS.

N	0	1	2	3	4	5	6	7	8	9
550	74086	74044	74052	74060	74068	74076	74084	74092	74099	74107
1	4115	4123	4131	4139	4147	4155	4162	4170	4178	4186
2	4104	4202	4210	4218	4225	4233	4241	4249	4257	4265
3	4273	4280	4288	4296	4304	4312	4320	4327	4335	4343
4	4351	4359	4367	4374	4382	4390	4398	4406	4414	4421
5	4429	4437	4445	4453	4461	4468	4476	4484	4492	4500
6	4507	4515	4523	4531	4539	4547	4554	4562	4570	4578
7	4586	4593	4601	4609	4617	4624	4632	4640	4648	4656
8	4663	4671	4679	4687	4695	4702	4710	4718	4726	4733
9	4741	4749	4757	4764	4772	4780	4788	4796	4803	4811
560	74819	74827	74834	74842	74850	74858	74865	74873	74881	74889
1	4896	4904	4912	4920	4927	4935	4943	4950	4958	4966
2	4974	4981	4989	4997	5005	5012	5020	5028	5035	5043
3	5051	5059	5066	5074	5082	5089	5097	5105	5113	5120
4	5128	5136	5143	5151	5159	5166	5174	5182	5189	5197
5	5205	5213	5220	5228	5236	5243	5251	5259	5266	5274
6	5282	5290	5297	5305	5312	5320	5328	5335	5343	5351
7	5358	5366	5374	5381	5389	5397	5404	5412	5420	5427
8	5435	5442	5450	5458	5465	5473	5481	5488	5496	5504
9	5511	5519	5526	5534	5542	5549	5557	5565	5572	5580
570	75587	75595	75603	75610	75618	75626	75633	75641	75648	75656
1	5604	5671	5679	5686	5694	5702	5709	5717	5724	5732
2	5740	5747	5755	5762	5770	5778	5785	5793	5800	5808
3	5815	5823	5831	5838	5846	5853	5861	5868	5876	5884
4	5891	5899	5906	5914	5921	5929	5937	5944	5952	5959
5	5967	5974	5982	5989	5997	6005	6012	6020	6027	6035
6	6042	6050	6057	6065	6072	6080	6087	6095	6103	6110
7	6118	6125	6133	6140	6148	6155	6163	6170	6178	6185
8	6193	6200	6208	6215	6223	6230	6238	6245	6253	6260
9	6268	6275	6283	6290	6298	6305	6313	6320	6328	6335
580	76343	76350	76358	76365	76373	76380	76388	76395	76403	76410
1	6418	6425	6433	6440	6448	6455	6462	6470	6477	6485
2	6492	6500	6507	6515	6522	6530	6537	6545	6552	6559
3	6567	6574	6582	6589	6597	6604	6612	6619	6626	6634
4	6641	6649	6656	6664	6671	6678	6686	6693	6701	6708
5	6716	6723	6730	6738	6745	6753	6760	6768	6775	6782
6	6790	6797	6805	6812	6819	6827	6834	6842	6849	6856
7	6864	6871	6879	6886	6893	6901	6908	6916	6923	6930
8	6938	6945	6953	6960	6967	6975	6982	6989	6997	7004
9	7012	7019	7026	7034	7041	7048	7056	7063	7070	7078
590	77085	77093	77100	77107	77115	77122	77129	77137	77144	77151
1	7159	7166	7173	7181	7188	7195	7203	7210	7217	7225
2	7232	7240	7247	7254	7262	7269	7276	7283	7291	7298
3	7305	7313	7320	7327	7335	7342	7349	7357	7364	7371
4	7379	7386	7393	7401	7408	7415	7422	7430	7437	7444
5	7452	7459	7466	7474	7481	7488	7495	7503	7510	7517
6	7525	7532	7539	7546	7554	7561	7568	7576	7583	7590
7	7597	7605	7612	7619	7627	7634	7641	7648	7656	7663
8	7670	7677	7685	7692	7699	7706	7714	7721	7728	7735
9	7743	7750	7757	7764	7772	7779	7786	7793	7801	7808
600	77815	77822	77830	77837	77844	77851	77859	77866	77873	77880

TABLE I.—LOGARITHMS OF NUMBERS.

N	0	1	2	3	4	5	6	7	8	9
600	77815	77822	77830	77837	77844	77851	77859	77866	77873	77880
1	7887	7895	7902	7909	7916	7924	7931	7938	7945	7952
2	7960	7967	7974	7981	7988	7996	8003	8010	8017	8025
3	8032	8039	8046	8053	8061	8068	8075	8082	8089	8097
4	8104	8111	8118	8125	8132	8140	8147	8154	8161	8168
5	8176	8183	8190	8197	8204	8211	8219	8226	8233	8240
6	8247	8254	8262	8269	8276	8283	8290	8297	8305	8312
7	8319	8326	8333	8340	8347	8355	8362	8369	8376	8383
8	8390	8398	8405	8412	8419	8426	8433	8440	8447	8455
9	8462	8469	8476	8483	8490	8497	8504	8512	8519	8526
610	78533	78540	78547	78554	78561	78569	78576	78583	78590	78597
1	8604	8611	8618	8625	8633	8640	8647	8654	8661	8668
2	8675	8682	8689	8696	8704	8711	8718	8725	8732	8739
3	8746	8753	8760	8767	8774	8781	8789	8796	8803	8810
4	8817	8824	8831	8838	8845	8852	8859	8866	8873	8880
5	8888	8895	8902	8909	8916	8923	8930	8937	8944	8951
6	8958	8965	8972	8979	8986	8993	9000	9007	9014	9021
7	9029	9036	9043	9050	9057	9064	9071	9078	9085	9092
8	9099	9106	9113	9120	9127	9134	9141	9148	9155	9162
9	9169	9176	9183	9190	9197	9204	9211	9218	9225	9232
620	79239	79246	79253	79260	79267	79274	79281	79288	79295	79302
1	9309	9316	9323	9330	9337	9344	9351	9358	9365	9372
2	9379	9386	9393	9400	9407	9414	9421	9428	9435	9442
3	9449	9456	9463	9470	9477	9484	9491	9498	9505	9511
4	9518	9525	9532	9539	9546	9553	9560	9567	9574	9581
5	9588	9595	9602	9609	9616	9623	9630	9637	9644	9650
6	9657	9664	9671	9678	9685	9692	9699	9706	9713	9720
7	9727	9734	9741	9748	9754	9761	9768	9775	9782	9789
8	9796	9803	9810	9817	9824	9831	9837	9844	9851	9858
9	9865	9872	9879	9886	9893	9900	9906	9913	9920	9927
630	79934	79941	79948	79955	79962	79969	79975	79982	79989	79996
1	80003	80010	80017	80024	80030	80037	80044	80051	80058	80065
2	0072	0079	0085	0092	0099	0106	0113	0120	0127	0134
3	0140	0147	0154	0161	0168	0175	0182	0188	0195	0202
4	0209	0216	0223	0229	0236	0243	0250	0257	0264	0271
5	0277	0284	0291	0298	0305	0312	0318	0325	0332	0339
6	0346	0353	0359	0366	0373	0380	0387	0393	0400	0407
7	0414	0421	0428	0434	0441	0448	0455	0462	0468	0475
8	0482	0489	0496	0502	0509	0516	0523	0530	0536	0543
9	0550	0557	0564	0570	0577	0584	0591	0598	0604	0611
640	80618	80625	80632	80639	80645	80652	80659	80665	80672	80679
1	0686	0693	0699	0706	0713	0720	0726	0733	0740	0747
2	0754	0760	0767	0774	0781	0787	0794	0801	0808	0814
3	0821	0828	0835	0841	0848	0855	0862	0868	0875	0882
4	0889	0895	0902	0909	0916	0922	0929	0936	0943	0949
5	0956	0963	0969	0976	0983	0990	0996	1003	1010	1017
6	1023	1030	1037	1043	1050	1057	1064	1070	1077	1084
7	1090	1097	1104	1111	1117	1124	1131	1137	1144	1151
8	1158	1164	1171	1178	1184	1191	1198	1204	1211	1218
9	1224	1231	1238	1245	1251	1258	1265	1271	1278	1285
650	81291	81298	81305	81311	81318	81325	81331	81338	81345	81351

TABLE I.—LOGARITHMS OF NUMBERS.

N	0	1	2	3	4	5	6	7	8	9
650	81291	81298	81305	81311	81318	81325	81331	81338	81345	81351
1	1358	1365	1371	1378	1385	1391	1398	1405	1411	1418
2	1425	1431	1438	1445	1451	1458	1465	1471	1478	1485
3	1491	1498	1505	1511	1518	1525	1531	1538	1544	1551
4	1558	1564	1571	1578	1584	1591	1598	1604	1611	1617
5	1624	1631	1637	1644	1651	1657	1664	1671	1677	1684
6	1690	1697	1704	1710	1717	1723	1730	1737	1743	1750
7	1757	1763	1770	1776	1783	1790	1796	1803	1809	1816
8	1823	1829	1836	1842	1849	1856	1862	1869	1875	1882
9	1889	1895	1902	1908	1915	1921	1928	1935	1941	1948
660	81954	81961	81968	81974	81981	81987	81994	82000	82007	82014
1	2020	2027	2033	2040	2046	2053	2060	2066	2073	2079
2	2086	2092	2099	2105	2112	2119	2125	2132	2138	2145
3	2151	2158	2164	2171	2178	2184	2191	2197	2204	2210
4	2217	2223	2230	2236	2243	2249	2256	2263	2269	2276
5	2282	2289	2295	2302	2308	2315	2321	2328	2334	2341
6	2347	2354	2360	2367	2373	2380	2387	2393	2400	2406
7	2413	2419	2426	2432	2439	2445	2452	2458	2465	2471
8	2478	2484	2491	2497	2504	2510	2517	2523	2530	2536
9	2543	2549	2556	2562	2569	2575	2582	2588	2595	2601
670	82607	82614	82620	82627	82633	82640	82646	82653	82659	82666
1	2672	2679	2685	2692	2698	2705	2711	2718	2724	2730
2	2737	2743	2750	2756	2763	2769	2776	2782	2789	2795
3	2802	2808	2814	2821	2827	2834	2840	2847	2853	2860
4	2866	2872	2879	2885	2892	2898	2905	2911	2918	2924
5	2930	2937	2943	2950	2956	2963	2969	2975	2982	2988
6	2995	3001	3008	3014	3020	3027	3033	3040	3046	3052
7	3059	3065	3072	3078	3085	3091	3097	3104	3110	3117
8	3123	3129	3136	3142	3149	3155	3161	3168	3174	3181
9	3187	3193	3200	3206	3213	3219	3225	3232	3238	3245
680	83251	83257	83264	83270	83276	83283	83289	83296	83302	83308
1	3315	3321	3327	3334	3340	3347	3353	3359	3366	3372
2	3378	3385	3391	3398	3404	3410	3417	3423	3429	3436
3	3442	3448	3455	3461	3467	3474	3480	3487	3493	3499
4	3506	3512	3518	3525	3531	3537	3544	3550	3556	3563
5	3569	3575	3582	3588	3594	3601	3607	3613	3620	3626
6	3632	3639	3645	3651	3658	3664	3670	3677	3683	3689
7	3696	3702	3708	3715	3721	3727	3734	3740	3746	3753
8	3759	3765	3771	3778	3784	3790	3797	3803	3809	3816
9	3822	3828	3835	3841	3847	3853	3860	3866	3872	3879
690	83885	83891	83897	83904	83910	83916	83923	83929	83935	83942
1	3948	3954	3960	3967	3973	3979	3985	3992	3998	4004
2	4011	4017	4023	4029	4036	4042	4048	4055	4061	4067
3	4073	4080	4086	4092	4098	4105	4111	4117	4123	4130
4	4136	4142	4148	4155	4161	4167	4173	4180	4186	4192
5	4198	4205	4211	4217	4223	4230	4236	4242	4248	4255
6	4261	4267	4273	4280	4286	4292	4298	4305	4311	4317
7	4323	4330	4336	4342	4348	4354	4361	4367	4373	4379
8	4386	4392	4398	4404	4410	4417	4423	4429	4435	4442
9	4448	4454	4460	4466	4473	4479	4485	4491	4497	4504
700	84510	84516	84522	84528	84535	84541	84547	84553	84559	84566

TABLE I.—LOGARITHMS OF NUMBERS.

N	0	1	2	3	4	5	6	7	8	9
700	84510	84516	84522	84528	84535	84541	84547	84553	84559	84566
1	4572	4578	4584	4590	4597	4603	4609	4615	4621	4628
2	4634	4640	4646	4652	4658	4665	4671	4677	4683	4689
3	4696	4702	4708	4714	4720	4726	4733	4739	4745	4751
4	4757	4763	4770	4776	4782	4788	4794	4800	4807	4813
5	4819	4825	4831	4837	4844	4850	4856	4862	4868	4874
6	4880	4887	4893	4899	4905	4911	4917	4924	4930	4936
7	4942	4948	4954	4960	4967	4973	4979	4985	4991	4997
8	5003	5009	5016	5022	5028	5034	5040	5046	5052	5058
9	5065	5071	5077	5083	5089	5095	5101	5107	5114	5120
710	85126	85132	85138	85144	85150	85156	85163	85169	85175	85181
1	5187	5193	5199	5205	5211	5217	5224	5230	5236	5242
2	5248	5254	5260	5266	5272	5278	5285	5291	5297	5303
3	5309	5315	5321	5327	5333	5339	5345	5352	5358	5364
4	5370	5376	5382	5388	5394	5400	5406	5412	5418	5425
5	5431	5437	5443	5449	5455	5461	5467	5473	5479	5485
6	5491	5497	5503	5509	5516	5522	5528	5534	5540	5546
7	5552	5558	5564	5570	5576	5582	5588	5594	5600	5606
8	5612	5618	5625	5631	5637	5643	5649	5655	5661	5667
9	5673	5679	5685	5691	5697	5703	5709	5715	5721	5727
720	85733	85739	85745	85751	85757	85763	85769	85775	85781	85788
1	5794	5800	5806	5812	5818	5824	5830	5836	5842	5848
2	5854	5860	5866	5872	5878	5884	5890	5896	5902	5908
3	5914	5920	5926	5932	5938	5944	5950	5956	5962	5968
4	5974	5980	5986	5992	5998	6004	6010	6016	6022	6028
5	6034	6040	6046	6052	6058	6064	6070	6076	6082	6088
6	6094	6100	6106	6112	6118	6124	6130	6136	6142	6147
7	6153	6159	6165	6171	6177	6183	6189	6195	6201	6207
8	6213	6219	6225	6231	6237	6243	6249	6255	6261	6267
9	6273	6279	6285	6291	6297	6303	6308	6314	6320	6326
730	86332	86338	86344	86350	86356	86362	86368	86374	86380	86386
1	6392	6398	6404	6410	6415	6421	6427	6433	6439	6445
2	6451	6457	6463	6469	6475	6481	6487	6493	6499	6504
3	6510	6516	6522	6528	6534	6540	6546	6552	6558	6564
4	6570	6576	6581	6587	6593	6599	6605	6611	6617	6623
5	6629	6635	6641	6646	6652	6658	6664	6670	6676	6682
6	6688	6694	6700	6705	6711	6717	6723	6729	6735	6741
7	6747	6753	6759	6764	6770	6776	6782	6788	6794	6800
8	6806	6812	6817	6823	6829	6835	6841	6847	6853	6859
9	6864	6870	6876	6882	6888	6894	6900	6906	6911	6917
740	86923	86929	86935	86941	86947	86953	86958	86964	86970	86976
1	6982	6988	6994	6999	7005	7011	7017	7023	7029	7035
2	7040	7046	7052	7058	7064	7070	7075	7081	7087	7093
3	7099	7105	7111	7116	7122	7128	7134	7140	7146	7151
4	7157	7163	7169	7175	7181	7186	7192	7198	7204	7210
5	7216	7221	7227	7233	7239	7245	7251	7256	7262	7268
6	7274	7280	7286	7291	7297	7303	7309	7315	7320	7326
7	7332	7338	7344	7349	7355	7361	7367	7373	7379	7384
8	7390	7396	7402	7408	7413	7419	7425	7431	7437	7442
9	7448	7454	7460	7466	7471	7477	7483	7489	7495	7500
750	87506	87512	87518	87523	87529	87535	87541	87547	87552	87558

TABLE I.—LOGARITHMS OF NUMBERS.

N	0	1	2	3	4	5	6	7	8	9
750	87506	87512	87518	87523	87529	87535	87541	87547	87552	87558
1	7564	7570	7576	7581	7587	7593	7599	7604	7610	7616
2	7622	7628	7633	7639	7645	7651	7656	7662	7668	7674
3	7679	7685	7691	7697	7703	7708	7714	7720	7726	7731
4	7737	7743	7749	7754	7760	7766	7772	7777	7783	7789
5	7795	7800	7806	7812	7818	7823	7829	7835	7841	7846
6	7852	7858	7864	7869	7875	7881	7887	7892	7898	7904
7	7910	7915	7921	7927	7933	7938	7944	7950	7955	7961
8	7967	7973	7978	7984	7990	7996	8001	8007	8013	8018
9	8024	8030	8036	8041	8047	8053	8058	8064	8070	8076
760	88081	88087	88093	88098	88104	88110	88116	88121	88127	88133
1	8138	8144	8150	8156	8161	8167	8173	8178	8184	8190
2	8195	8201	8207	8213	8218	8224	8230	8235	8241	8247
3	8252	8258	8264	8270	8275	8281	8287	8292	8298	8304
4	8309	8315	8321	8326	8332	8338	8343	8349	8355	8360
5	8366	8372	8377	8383	8389	8395	8400	8406	8412	8417
6	8423	8429	8434	8440	8446	8451	8457	8463	8468	8474
7	8480	8485	8491	8497	8502	8508	8513	8519	8525	8530
8	8538	8542	8547	8553	8559	8564	8570	8576	8581	8587
9	8593	8598	8604	8610	8616	8621	8627	8632	8638	8643
770	88649	88655	88660	88666	88672	88677	88683	88689	88694	88700
1	8705	8711	8717	8722	8728	8734	8739	8745	8750	8756
2	8762	8767	8773	8779	8784	8790	8795	8801	8807	8812
3	8818	8824	8829	8835	8840	8846	8852	8857	8863	8868
4	8874	8880	8885	8891	8897	8902	8908	8913	8919	8925
5	8930	8936	8941	8947	8953	8958	8964	8969	8975	8981
6	8986	8992	8997	9003	9009	9014	9020	9025	9031	9037
7	9042	9048	9053	9059	9064	9070	9076	9081	9087	9092
8	9098	9104	9109	9115	9120	9126	9131	9137	9143	9148
9	9154	9159	9165	9170	9176	9182	9187	9193	9198	9204
780	89209	89215	89221	89226	89232	89237	89243	89248	89254	89260
1	9265	9271	9276	9282	9287	9293	9298	9304	9310	9315
2	9321	9326	9332	9337	9343	9348	9354	9360	9365	9371
3	9376	9382	9387	9393	9398	9404	9409	9415	9421	9426
4	9432	9437	9443	9448	9454	9459	9465	9470	9476	9481
5	9487	9492	9498	9504	9509	9515	9520	9526	9531	9537
6	9542	9548	9553	9559	9564	9570	9575	9581	9586	9592
7	9597	9603	9609	9614	9620	9625	9631	9636	9642	9647
8	9653	9658	9664	9669	9675	9680	9686	9691	9697	9702
9	9708	9713	9719	9724	9730	9735	9741	9746	9752	9757
790	89763	89768	89774	89779	89785	89790	89796	89801	89807	89812
1	9818	9823	9829	9834	9840	9845	9851	9856	9862	9867
2	9873	9878	9883	9889	9894	9900	9905	9911	9916	9922
3	9927	9933	9938	9944	9949	9955	9960	9966	9971	9977
4	9982	9988	9993	9998	10004	10009	10015	10020	10026	10031
5	10037	10042	10048	10053	10059	10064	10069	10075	10080	10086
6	10091	10097	10102	10108	10113	10119	10124	10129	10135	10140
7	10146	10151	10157	10162	10168	10173	10179	10184	10189	10195
8	10200	10206	10211	10217	10222	10227	10233	10238	10244	10249
9	10255	10260	10266	10271	10276	10282	10287	10293	10298	10304
800	90309	90314	90320	90325	90331	90336	90342	90347	90352	90358

TABLE I.—LOGARITHMS OF NUMBERS.

N	0	1	2	3	4	5	6	7	8	9
800	90309	90314	90320	90325	90331	90338	90342	90347	90352	90358
1	0363	0369	0374	0380	0385	0390	0396	0401	0407	0412
2	0417	0423	0428	0434	0439	0445	0450	0455	0461	0466
3	0472	0477	0482	0488	0493	0499	0504	0509	0515	0520
4	0526	0531	0536	0542	0547	0553	0558	0563	0569	0574
5	0580	0585	0590	0596	0601	0607	0612	0617	0623	0628
6	0634	0639	0644	0650	0655	0660	0666	0671	0677	0682
7	0687	0693	0698	0703	0709	0714	0720	0725	0730	0736
8	0741	0747	0752	0757	0763	0768	0773	0779	0784	0789
9	0795	0800	0806	0811	0816	0822	0827	0832	0838	0843
810	90849	90854	90859	90865	90870	90875	90881	90886	90891	90897
1	0902	0907	0913	0918	0924	0929	0934	0940	0945	0950
2	0956	0961	0966	0972	0977	0982	0988	0993	0998	1004
3	1009	1014	1020	1025	1030	1036	1041	1046	1052	1057
4	1062	1068	1073	1078	1084	1089	1094	1100	1105	1110
5	1116	1121	1126	1132	1137	1142	1148	1153	1158	1164
6	1169	1174	1180	1185	1190	1196	1201	1206	1212	1217
7	1222	1228	1233	1238	1243	1249	1254	1259	1265	1270
8	1275	1281	1286	1291	1297	1302	1307	1312	1318	1323
9	1328	1334	1339	1344	1350	1355	1360	1365	1371	1376
820	91381	91387	91392	91397	91403	91408	91413	91418	91424	91429
1	1434	1440	1445	1450	1455	1461	1466	1471	1477	1482
2	1487	1492	1498	1503	1508	1514	1519	1524	1529	1535
3	1540	1545	1551	1556	1561	1566	1572	1577	1582	1587
4	1593	1598	1603	1609	1614	1619	1624	1630	1635	1640
5	1645	1651	1656	1661	1666	1672	1677	1682	1687	1693
6	1698	1703	1709	1714	1719	1724	1730	1735	1740	1745
7	1751	1756	1761	1766	1772	1777	1782	1787	1793	1798
8	1803	1808	1814	1819	1824	1829	1834	1840	1845	1850
9	1855	1861	1866	1871	1876	1882	1887	1892	1897	1903
830	91908	91913	91918	91924	91929	91934	91939	91944	91950	91955
1	1960	1965	1971	1976	1981	1986	1991	1997	2002	2007
2	2012	2018	2023	2028	2033	2038	2044	2049	2054	2059
3	2065	2070	2075	2080	2085	2091	2096	2101	2106	2111
4	2117	2122	2127	2132	2137	2143	2148	2153	2158	2163
5	2169	2174	2179	2184	2189	2195	2200	2205	2210	2215
6	2221	2226	2231	2236	2241	2247	2252	2257	2262	2267
7	2273	2278	2283	2288	2293	2298	2304	2309	2314	2319
8	2324	2330	2335	2340	2345	2350	2355	2361	2366	2371
9	2376	2381	2387	2392	2397	2402	2407	2412	2418	2423
840	92428	92433	92438	92443	92449	92454	92459	92464	92469	92474
1	2480	2485	2490	2495	2500	2505	2511	2516	2521	2526
2	2531	2536	2542	2547	2552	2557	2562	2567	2572	2578
3	2583	2588	2593	2598	2603	2609	2614	2619	2624	2629
4	2634	2639	2645	2650	2655	2660	2665	2670	2675	2681
5	2686	2691	2696	2701	2706	2711	2716	2722	2727	2732
6	2737	2742	2747	2752	2758	2763	2768	2773	2778	2783
7	2788	2793	2799	2804	2809	2814	2819	2824	2829	2834
8	2840	2845	2850	2855	2860	2865	2870	2875	2881	2886
9	2891	2896	2901	2906	2911	2916	2921	2927	2932	2937
850	92942	92947	92952	92957	92962	92967	92973	92978	92983	92988

TABLE I.—LOGARITHMS OF NUMBERS.

N	0	1	2	3	4	5	6	7	8	9
850	92942	92947	92952	92957	92962	92967	92973	92978	92983	92988
1	2993	2998	3003	3008	3013	3018	3024	3029	3034	3039
2	3044	3049	3054	3059	3064	3069	3075	3080	3085	3090
3	3095	3100	3105	3110	3115	3120	3125	3131	3136	3141
4	3146	3151	3156	3161	3166	3171	3176	3181	3186	3192
5	3197	3202	3207	3212	3217	3222	3227	3232	3237	3242
6	3247	3252	3258	3263	3268	3273	3278	3283	3288	3293
7	3298	3303	3308	3313	3318	3323	3328	3334	3339	3344
8	3349	3354	3359	3364	3369	3374	3379	3384	3389	3394
9	3399	3404	3409	3414	3420	3425	3430	3435	3440	3445
860	93450	93455	93460	93465	93470	93475	93480	93485	93490	93495
1	3500	3505	3510	3515	3520	3526	3531	3536	3541	3546
2	3551	3556	3561	3566	3571	3576	3581	3586	3591	3596
3	3601	3606	3611	3616	3621	3626	3631	3636	3641	3646
4	3651	3656	3661	3666	3671	3676	3682	3687	3692	3697
5	3702	3707	3712	3717	3722	3727	3732	3737	3742	3747
6	3752	3757	3762	3767	3772	3777	3782	3787	3792	3797
7	3802	3807	3812	3817	3822	3827	3832	3837	3842	3847
8	3852	3857	3862	3867	3872	3877	3882	3887	3892	3897
9	3902	3907	3912	3917	3922	3927	3932	3937	3942	3947
870	93952	93957	93962	93967	93972	93977	93982	93987	93992	93997
1	4002	4007	4012	4017	4022	4027	4032	4037	4042	4047
2	4052	4057	4062	4067	4072	4077	4082	4086	4091	4096
3	4101	4106	4111	4116	4121	4126	4131	4136	4141	4146
4	4151	4156	4161	4166	4171	4176	4181	4186	4191	4196
5	4201	4206	4211	4216	4221	4226	4231	4236	4240	4245
6	4250	4255	4260	4265	4270	4275	4280	4285	4290	4295
7	4300	4305	4310	4315	4320	4325	4330	4335	4340	4345
8	4349	4354	4359	4364	4369	4374	4379	4384	4389	4394
9	4399	4404	4409	4414	4419	4424	4429	4433	4438	4443
880	94448	94453	94458	94463	94468	94473	94478	94483	94488	94493
1	4498	4503	4507	4512	4517	4522	4527	4532	4537	4542
2	4547	4552	4557	4562	4567	4571	4576	4581	4586	4591
3	4596	4601	4606	4611	4616	4621	4626	4630	4635	4640
4	4645	4650	4655	4660	4665	4670	4675	4680	4685	4690
5	4694	4699	4704	4709	4714	4719	4724	4729	4734	4738
6	4743	4748	4753	4758	4763	4768	4773	4778	4783	4787
7	4792	4797	4802	4807	4812	4817	4822	4827	4832	4836
8	4841	4846	4851	4856	4861	4866	4871	4876	4880	4885
9	4890	4895	4900	4905	4910	4915	4919	4924	4929	4934
890	94939	94944	94949	94954	94959	94963	94968	94973	94978	94983
1	4988	4993	4998	5002	5007	5012	5017	5022	5027	5032
2	5036	5041	5046	5051	5056	5061	5066	5071	5075	5080
3	5085	5090	5095	5100	5105	5109	5114	5119	5124	5129
4	5134	5139	5143	5148	5153	5158	5163	5168	5173	5177
5	5182	5187	5192	5197	5202	5207	5211	5216	5221	5226
6	5231	5236	5240	5245	5250	5255	5260	5265	5270	5274
7	5279	5284	5289	5294	5299	5303	5308	5313	5318	5323
8	5328	5332	5337	5342	5347	5352	5357	5361	5366	5371
9	5376	5381	5386	5390	5395	5400	5405	5410	5415	5419
900	95424	95429	95434	95439	95444	95448	95453	95458	95463	95468

TABLE I.—LOGARITHMS OF NUMBERS.

N	0	1	2	3	4	5	6	7	8	9
900	95424	95429	95434	95439	95444	95448	95453	95458	95463	95468
1	5472	5477	5482	5487	5492	5497	5501	5506	5511	5516
2	5521	5525	5530	5535	5540	5545	5550	5554	5559	5564
3	5569	5574	5578	5583	5588	5593	5598	5602	5607	5612
4	5617	5622	5626	5631	5636	5641	5646	5650	5655	5660
5	5665	5670	5674	5679	5684	5689	5694	5698	5703	5708
6	5713	5718	5722	5727	5732	5737	5742	5746	5751	5756
7	5761	5766	5770	5775	5780	5785	5789	5794	5799	5804
8	5809	5813	5818	5823	5828	5832	5837	5842	5847	5852
9	5856	5861	5866	5871	5875	5880	5885	5890	5895	5899
910	95904	95909	95914	95918	95923	95928	95933	95938	95942	95947
1	5952	5957	5961	5966	5971	5976	5980	5985	5990	5995
2	5999	6004	6009	6014	6019	6023	6028	6033	6038	6042
3	6047	6052	6057	6061	6066	6071	6076	6080	6085	6090
4	6095	6099	6104	6109	6114	6118	6123	6128	6133	6137
5	6142	6147	6152	6156	6161	6166	6171	6175	6180	6185
6	6190	6194	6199	6204	6209	6213	6218	6223	6227	6232
7	6237	6242	6246	6251	6256	6261	6265	6270	6275	6280
8	6284	6289	6294	6298	6303	6308	6313	6317	6322	6327
9	6332	6336	6341	6346	6350	6355	6360	6365	6369	6374
920	96379	96384	96388	96393	96398	96402	96407	96412	96417	96421
1	6426	6431	6435	6440	6445	6450	6454	6459	6464	6468
2	6473	6478	6483	6487	6492	6497	6501	6506	6511	6515
3	6520	6525	6530	6534	6539	6544	6548	6553	6558	6562
4	6567	6572	6577	6581	6586	6591	6595	6600	6605	6609
5	6614	6619	6624	6628	6633	6638	6642	6647	6652	6656
6	6661	6666	6670	6675	6680	6685	6689	6694	6699	6703
7	6708	6713	6717	6722	6727	6731	6736	6741	6745	6750
8	6755	6759	6764	6769	6774	6778	6783	6788	6792	6797
9	6802	6806	6811	6816	6820	6825	6830	6834	6839	6844
930	96848	96853	96858	96862	96867	96872	96876	96881	96886	96890
1	6895	6900	6904	6909	6914	6918	6923	6928	6932	6937
2	6942	6946	6951	6956	6960	6965	6970	6974	6979	6984
3	6988	6993	6997	7002	7007	7011	7016	7021	7025	7030
4	7035	7039	7044	7049	7053	7058	7063	7067	7072	7077
5	7081	7086	7090	7095	7100	7104	7109	7114	7118	7123
6	7128	7132	7137	7142	7146	7151	7155	7160	7165	7169
7	7174	7179	7183	7188	7192	7197	7202	7206	7211	7216
8	7220	7225	7230	7234	7239	7243	7248	7253	7257	7262
9	7267	7271	7276	7280	7285	7290	7294	7299	7304	7308
940	97313	97317	97322	97327	97331	97336	97340	97345	97350	97354
1	7359	7364	7368	7373	7377	7382	7387	7391	7396	7400
2	7405	7410	7414	7419	7424	7428	7433	7437	7442	7447
3	7451	7456	7460	7465	7470	7474	7479	7483	7488	7493
4	7497	7502	7506	7511	7516	7520	7525	7529	7534	7539
5	7543	7548	7552	7557	7562	7566	7571	7575	7580	7585
6	7589	7594	7598	7603	7607	7612	7617	7621	7626	7630
7	7635	7640	7644	7649	7653	7658	7663	7667	7672	7676
8	7681	7685	7690	7695	7699	7704	7708	7713	7717	7722
9	7727	7731	7736	7740	7745	7749	7754	7759	7763	7768
950	97772	97777	97782	97786	97791	97795	97800	97804	97809	97813

TABLE I.—LOGARITHMS OF NUMBERS.

N	0	1	2	3	4	5	6	7	8	9
950	97772	97777	97782	97786	97791	97795	97800	97804	97809	97813
1	7818	7823	7827	7832	7836	7841	7845	7850	7855	7859
2	7864	7868	7873	7877	7882	7886	7891	7896	7900	7905
3	7909	7914	7918	7923	7928	7932	7937	7941	7946	7950
4	7955	7959	7964	7968	7973	7978	7982	7987	7991	7996
5	8000	8005	8009	8014	8019	8023	8028	8032	8037	8041
6	8046	8050	8055	8059	8064	8068	8073	8078	8082	8087
7	8091	8096	8100	8105	8109	8114	8118	8123	8127	8132
8	8137	8141	8146	8150	8155	8159	8164	8168	8173	8177
9	8182	8186	8191	8195	8200	8204	8209	8214	8218	8223
960	98227	98232	98236	98241	98245	98250	98254	98259	98263	98268
1	8272	8277	8281	8286	8290	8295	8299	8304	8308	8313
2	8318	8322	8327	8331	8336	8340	8345	8349	8354	8358
3	8363	8367	8372	8376	8381	8385	8390	8394	8399	8403
4	8408	8412	8417	8421	8426	8430	8435	8439	8444	8448
5	8453	8457	8462	8466	8471	8475	8480	8484	8489	8493
6	8498	8502	8507	8511	8516	8520	8525	8529	8534	8538
7	8543	8547	8552	8556	8561	8565	8570	8574	8579	8583
8	8588	8592	8597	8601	8605	8610	8614	8619	8623	8628
9	8632	8637	8641	8646	8650	8655	8659	8664	8668	8673
970	98677	98682	98686	98691	98695	98700	98704	98709	98713	98717
1	8722	8726	8731	8735	8740	8744	8749	8753	8758	8762
2	8767	8771	8776	8780	8784	8789	8793	8798	8802	8807
3	8811	8816	8820	8825	8829	8834	8838	8843	8847	8851
4	8856	8860	8865	8869	8874	8878	8883	8887	8892	8896
5	8900	8905	8909	8914	8918	8923	8927	8932	8936	8941
6	8945	8949	8954	8958	8963	8967	8972	8976	8981	8985
7	8989	8994	8998	9003	9007	9012	9016	9021	9025	9029
8	9034	9038	9043	9047	9052	9056	9061	9065	9069	9074
9	9078	9083	9087	9092	9096	9100	9105	9109	9114	9118
980	99123	99127	99131	99136	99140	99145	99149	99154	99158	99162
1	9167	9171	9176	9180	9185	9189	9193	9198	9202	9207
2	9211	9216	9220	9224	9229	9233	9238	9242	9247	9251
3	9255	9260	9264	9269	9273	9277	9282	9286	9291	9295
4	9300	9304	9308	9313	9317	9322	9326	9330	9335	9339
5	9344	9348	9352	9357	9361	9366	9370	9374	9379	9383
6	9388	9392	9396	9401	9405	9410	9414	9419	9423	9427
7	9432	9436	9441	9445	9449	9454	9458	9463	9467	9471
8	9476	9480	9484	9489	9493	9498	9502	9506	9511	9515
9	9520	9524	9528	9533	9537	9542	9546	9550	9555	9559
990	99584	99588	99572	99577	99581	99585	99590	99594	99599	99603
1	9607	9612	9616	9621	9625	9629	9634	9638	9642	9647
2	9651	9656	9660	9664	9669	9673	9677	9682	9686	9691
3	9695	9699	9704	9708	9712	9717	9721	9726	9730	9734
4	9739	9743	9747	9752	9756	9760	9765	9769	9774	9778
5	9782	9787	9791	9795	9800	9804	9808	9813	9817	9822
6	9826	9830	9835	9839	9843	9848	9852	9856	9861	9865
7	9870	9874	9878	9883	9887	9891	9896	9900	9904	9909
8	9913	9917	9922	9926	9930	9935	9939	9944	9948	9952
9	9957	9961	9965	9970	9974	9978	9983	9987	9991	9996
1000	00000	00004	00009	00013	00017	00022	00026	00030	00035	00039

TABLE II.—LOGARITHMIC SINES AND COSINES.

	0°		1°		2°		
	Sine	Cosine	Sine	Cosine	Sine	Cosine	
0	—∞	10.00000	8.94186	9.99998	8.54288	9.99974	60
1	6.46378	00000	94908	99998	54643	99973	59
2	76476	00000	25609	99998	54999	99973	58
3	94086	00000	36304	99998	55354	99973	57
4	7.00279	00000	26988	99992	55705	99973	56
5	10270	00000	27661	99992	56054	99971	55
6	24186	00000	28324	99992	56400	99971	54
7	30682	00000	28977	99992	56743	99970	53
8	36682	00000	29621	99992	57084	99970	52
9	41797	00000	30255	99991	57421	99969	51
10	7.46378	10.00000	8.30879	9.99991	8.57757	9.99969	50
11	50512	00000	31495	99991	58069	99968	49
12	54891	00000	32108	99990	58419	99968	48
13	57787	00000	32702	99990	58747	99967	47
14	60295	00000	33282	99990	59073	99967	46
15	62592	00000	33875	99990	59395	99967	45
16	64784	00000	34450	99989	59715	99966	44
17	66917	9.99992	35018	99989	60032	99966	43
18	71900	99992	35578	99989	60349	99965	42
19	74248	99992	36131	99989	60663	99964	41
20	7.76475	9.99992	8.36678	9.99988	8.60973	9.99964	40
21	78694	99992	37217	99988	61282	99963	39
22	80615	99992	37750	99988	61689	99963	38
23	82245	99992	38276	99987	62094	99962	37
24	84592	99992	38796	99987	62496	99962	36
25	86186	99992	39310	99987	62897	99961	35
26	87870	99992	39818	99986	63295	99961	34
27	89509	99992	40320	99986	63691	99960	33
28	91088	99992	40815	99986	64085	99960	32
29	92612	99992	41307	99985	64478	99959	31
30	7.94064	9.99992	8.41792	9.99985	8.63968	9.99959	30
31	95508	99992	42272	99985	64856	99958	29
32	96987	99992	42746	99984	64443	99958	28
33	98223	99992	43216	99984	64827	99957	27
34	99220	99992	43680	99984	65110	99956	26
35	8.00779	99992	44139	99983	65391	99956	25
36	02002	99992	44594	99983	65670	99955	24
37	08192	99997	45044	99983	65947	99955	23
38	04350	99997	45489	99982	66222	99954	22
39	05478	99997	45930	99982	66497	99954	21
40	8.06378	9.99997	8.46366	9.99982	8.66769	9.99953	20
41	07650	99997	46799	99981	67089	99953	19
42	08696	99997	47226	99981	67308	99952	18
43	09718	99997	47650	99981	67525	99951	17
44	10717	99996	48069	99980	67841	99951	16
45	11692	99996	48485	99980	68104	99950	15
46	12647	99996	48896	99979	68367	99949	14
47	13581	99996	49304	99979	68627	99949	13
48	14495	99996	49708	99979	68886	99948	12
49	15391	99996	50108	99978	69144	99948	11
50	8.16298	9.99995	8.50504	9.99978	8.69400	9.99947	10
51	17123	99995	50897	99977	69654	99946	9
52	17971	99995	51287	99977	69907	99946	8
53	18798	99995	51673	99977	70159	99945	7
54	19610	99995	52055	99976	70409	99944	6
55	20407	99994	52434	99976	70658	99944	5
56	21189	99994	52810	99975	70905	99943	4
57	21958	99994	53188	99975	71151	99942	3
58	22718	99994	53552	99974	71395	99942	2
59	23456	99994	53919	99974	71638	99941	1
60	24186	99993	54282	99974	71880	99940	0
	Cosine	Sine	Cosine	Sine	Cosine	Sine	
		89°		88°		87°	

TABLE II.—LOGARITHMIC SINES AND COSINES.

	3°		4°		5°		
	Sine	Cosine	Sine	Cosine	Sine	Cosine	
0	8.71890	9.99940	8.84858	9.99894	8.94080	9.99884	60
1	72120	99940	84589	99898	94174	99883	59
2	72359	99939	84718	99892	94817	99882	58
3	72597	99938	84897	99891	94461	99881	57
4	72834	99938	85075	99891	94608	99880	56
5	73069	99937	85252	99890	94746	99879	55
6	73308	99936	85429	99889	94887	99878	54
7	73535	99936	85606	99888	95029	99877	53
8	73767	99935	85780	99887	95170	99876	52
9	73997	99934	85955	99886	95310	99874	51
10	8.74226	9.99884	8.86128	9.99835	8.95450	9.99823	50
11	74454	99933	86301	99884	95589	99822	49
12	74680	99932	86474	99883	95728	99821	48
13	74906	99932	86646	99882	95867	99820	47
14	75130	99931	86818	99881	96005	99819	46
15	75353	99930	86987	99880	96143	99817	45
16	75575	99929	87156	99879	96280	99816	44
17	75795	99929	87325	99879	96417	99815	43
18	76015	99928	87494	99878	96553	99814	42
19	76234	99927	87661	99877	96689	99813	41
20	8.76451	9.99826	8.87329	9.99876	8.96925	9.99812	40
21	76667	99926	87995	99875	96960	99810	39
22	76888	99925	88161	99874	97095	99809	38
23	77097	99924	88326	99873	97229	99808	37
24	77310	99923	88490	99872	97363	99807	36
25	77522	99923	88654	99871	97496	99806	35
26	77733	99922	88817	99870	97629	99804	34
27	77943	99921	88980	99869	97762	99803	33
28	78152	99920	89142	99868	97894	99802	32
29	78360	99920	89304	99867	98026	99801	31
30	8.78586	9.99819	8.89464	9.99866	8.98157	9.99800	30
31	78774	99918	89625	99865	98288	99798	29
32	78979	99917	89784	99864	98419	99797	28
33	79193	99917	89943	99863	98549	99796	27
34	79386	99916	90102	99862	98679	99795	26
35	79588	99915	90260	99861	98808	99793	25
36	79789	99914	90417	99860	98937	99792	24
37	79990	99913	90574	99859	99066	99791	23
38	80189	99913	90730	99858	99194	99790	22
39	80388	99912	90885	99857	99323	99788	21
40	8.80585	9.99811	8.91040	9.99856	8.99450	9.99787	20
41	80782	99910	91195	99855	99577	99786	19
42	80978	99909	91349	99854	99704	99785	18
43	81173	99909	91502	99853	99830	99783	17
44	81367	99908	91655	99852	99956	99782	16
45	81560	99907	91807	99851	9.00082	99781	15
46	81753	99906	91959	99850	00207	99780	14
47	81944	99905	92110	99848	00332	99778	13
48	82134	99904	92261	99847	00456	99777	12
49	82324	99904	92411	99846	00581	99776	11
50	8.82513	9.99803	8.92561	9.99845	9.00704	9.99775	10
51	82701	99902	92710	99844	00828	99773	9
52	82888	99901	92859	99843	00951	99772	8
53	83075	99900	93007	99842	01074	99771	7
54	83261	99899	93154	99841	01196	99769	6
55	83446	99898	93301	99840	01318	99768	5
56	83630	99898	93448	99839	01440	99767	4
57	83813	99897	93594	99838	01561	99765	3
58	83996	99896	93740	99837	01682	99764	2
59	84177	99895	93885	99836	01803	99763	1
60	84358	99894	94030	99834	01923	99761	0
	Cosine	Sine	Cosine	Sine	Cosine	Sine	
	86°		85°		84°		

TABLE II.—LOGARITHMIC SINES AND COSINES.

	6°		7°		8°		
	Sine	Cosine	Sine	Cosine	Sine	Cosine	
0	9.01928	9.99761	9.08589	9.99675	9.14856	9.99575	60
1	02048	99760	08692	99674	14445	99574	59
2	02168	99759	08795	99673	14535	99573	58
3	02288	99757	08897	99670	14624	99570	57
4	02408	99756	08999	99669	14714	99568	56
5	02520	99755	09101	99667	14803	99566	55
6	02632	99753	09203	99666	14891	99565	54
7	02757	99752	09304	99664	14980	99563	53
8	02874	99751	09405	99663	15069	99561	52
9	02993	99749	09506	99661	15157	99559	51
10	9.03109	9.99748	9.09606	9.99659	9.15945	9.99557	50
11	03226	99747	09707	99658	15233	99556	49
12	03342	99745	09807	99656	15321	99554	48
13	03458	99744	09907	99655	15408	99552	47
14	03574	99743	10006	99653	15496	99550	46
15	03690	99741	10105	99651	15583	99548	45
16	03805	99740	10203	99650	15670	99546	44
17	03920	99738	10304	99648	15757	99545	43
18	04034	99737	10403	99647	15844	99543	42
19	04149	99736	10501	99645	15930	99541	41
20	9.04262	9.99734	9.10599	9.99643	9.16116	9.99539	40
21	04378	99733	10697	99642	16203	99537	39
22	04490	99731	10795	99640	16289	99535	38
23	04603	99730	10893	99638	16374	99533	37
24	04715	99728	10990	99637	16460	99532	36
25	04828	99727	11087	99635	16545	99530	35
26	04940	99726	11184	99633	16631	99528	34
27	05052	99724	11281	99632	16716	99526	33
28	05164	99723	11377	99630	16801	99524	32
29	05276	99721	11474	99629	16886	99522	31
30	9.05386	9.99720	9.11570	9.99627	9.16970	9.99520	30
31	05497	99718	11566	99625	17055	99518	29
32	05607	99717	11661	99624	17139	99517	28
33	05717	99716	11757	99622	17223	99515	27
34	05827	99714	11852	99620	17307	99513	26
35	05937	99713	11947	99619	17391	99511	25
36	06046	99711	12042	99617	17474	99509	24
37	06155	99710	12136	99615	17558	99507	23
38	06264	99708	12231	99613	17641	99505	22
39	06372	99707	12325	99612	17724	99503	21
40	9.06481	9.99705	9.12519	9.99610	9.17807	9.99501	20
41	06589	99704	12413	99608	17890	99499	19
42	06696	99702	12507	99607	17973	99497	18
43	06804	99701	12599	99605	18055	99496	17
44	06911	99699	12693	99603	18137	99494	16
45	07018	99698	12785	99601	18220	99492	15
46	07124	99696	12878	99600	18302	99490	14
47	07231	99695	12971	99598	18383	99488	13
48	07337	99693	13063	99596	18465	99486	12
49	07443	99692	13155	99595	18547	99484	11
50	9.07548	9.99690	9.13447	9.99593	9.18628	9.99482	10
51	07653	99689	13249	99591	18709	99480	9
52	07758	99687	13340	99589	18790	99478	8
53	07863	99686	13432	99588	18871	99476	7
54	07968	99684	13523	99586	18952	99474	6
55	08072	99683	13614	99584	19033	99472	5
56	08176	99681	13704	99582	19113	99470	4
57	08280	99680	13795	99581	19193	99468	3
58	08383	99678	13885	99579	19273	99466	2
59	08486	99677	13976	99577	19353	99464	1
60	08589	99675	14066	99575	19433	99462	0
	Cosine	Sine	Cosine	Sine	Cosine	Sine	
	82°		82°		81°		

TABLE II.—LOGARITHMIC SINES AND COSINES.

	9°		10°		11°		
	Sine	Cosine	Sine	Cosine	Sine	Cosine	
0	9.19433	9.99432	9.22967	9.98835	9.28060	9.99195	60
1	19513	99480	24089	98833	28135	99192	59
2	19592	99458	24110	98831	28190	99190	58
3	19673	99456	24181	98828	28254	99187	57
4	19751	99454	24253	98826	28319	99185	56
5	19830	99452	24324	98824	28384	99183	55
6	19909	99450	24395	98822	28448	99180	54
7	19988	99448	24466	98819	28512	99177	53
8	20067	99446	24536	98817	28577	99175	52
9	20145	99444	24607	98815	28641	99173	51
10	9.20223	9.99442	9.24677	9.98813	9.28705	9.99170	50
11	20302	99440	24748	98810	28769	99167	49
12	20380	99438	24818	98808	28833	99165	48
13	20458	99436	24888	98806	28896	99162	47
14	20535	99434	24958	98804	28960	99160	46
15	20613	99432	25028	98801	29024	99157	45
16	20691	99429	25098	98799	29087	99155	44
17	20768	99427	25168	98797	29150	99153	43
18	20845	99425	25237	98794	29214	99150	42
19	20922	99423	25307	98792	29277	99147	41
20	9.21000	9.99421	9.25376	9.98790	9.29340	9.99145	40
21	21076	99419	25445	98788	29403	99143	39
22	21153	99417	25514	98785	29466	99140	38
23	21230	99415	25583	98783	29529	99137	37
24	21306	99413	25652	98781	29591	99135	36
25	21382	99411	25721	98778	29654	99132	35
26	21458	99409	25790	98776	29716	99130	34
27	21534	99407	25858	98774	29779	99127	33
28	21610	99404	25927	98771	29841	99124	32
29	21685	99402	25995	98769	29903	99122	31
30	9.21761	9.99400	9.26063	9.98767	9.29966	9.99119	30
31	21836	99398	26131	98764	29928	99117	29
32	21912	99396	26199	98762	29990	99114	28
33	21987	99394	26267	98760	30051	99112	27
34	22062	99392	26335	98757	30112	99109	26
35	22137	99390	26403	98755	30173	99106	25
36	22211	99388	26470	98753	30234	99104	24
37	22286	99385	26538	98750	30295	99101	23
38	22361	99383	26605	98748	30355	99099	22
39	22435	99381	26672	98745	30415	99096	21
40	9.22609	9.99379	9.26759	9.98743	9.30582	9.99098	20
41	22533	99377	26826	98741	30643	99091	19
42	22607	99375	26893	98738	30704	99088	18
43	22681	99373	26960	98736	30765	99086	17
44	22755	99370	27027	98733	30826	99083	16
45	22828	99368	27093	98731	30887	99080	15
46	22902	99366	27160	98729	30947	99078	14
47	22975	99364	27226	98726	31008	99075	13
48	23048	99362	27292	98724	31068	99072	12
49	23121	99359	27359	98721	31129	99070	11
50	9.23344	9.99357	9.27405	9.98719	9.31189	9.99067	10
51	23217	99355	27471	98717	31250	99064	9
52	23290	99353	27537	98714	31310	99062	8
53	23362	99351	27602	98712	31370	99059	7
54	23435	99348	27668	98709	31430	99056	6
55	23507	99346	27734	98707	31490	99054	5
56	23579	99344	27799	98704	31549	99051	4
57	23652	99342	27864	98702	31609	99048	3
58	23723	99340	27929	98700	31668	99046	2
59	23795	99337	27995	98697	31728	99043	1
60	23867	99335	28060	98695	31788	99040	0
	Cosine	Sine	Cosine	Sine	Cosine	Sine	
	80°		79°		78°		

TABLE II.—LOGARITHMIC SINES AND COSINES.

	12°		13°		14°		
	Sine	Cosine	Sine	Cosine	Sine	Cosine	
0	9.31788	9.99040	9.35209	9.98872	9.38868	9.98690	60
1	31847	99038	35263	98869	38418	98687	59
2	31907	99035	35318	98867	38469	98684	58
3	31966	99032	35373	98864	38519	98681	57
4	32025	99029	35427	98861	38570	98678	56
5	32084	99027	35481	98858	38620	98675	55
6	32143	99024	35536	98855	38670	98671	54
7	32202	99022	35590	98852	38721	98668	53
8	32261	99019	35644	98849	38771	98665	52
9	32319	99016	35698	98846	38821	98662	51
10	9.32378	9.99013	9.35752	9.98843	9.38871	9.98659	50
11	32437	99011	35806	98840	38871	98656	49
12	32495	99008	35860	98837	38921	98652	48
13	32553	99005	35914	98834	38971	98649	47
14	32612	99002	35968	98831	39021	98646	46
15	32670	99000	36022	98828	39071	98643	45
16	32728	98997	36075	98825	39120	98640	44
17	32786	98994	36129	98822	39170	98636	43
18	32844	98991	36182	98819	39220	98633	42
19	32902	98989	36236	98816	39270	98630	41
20	9.32960	9.98986	9.36289	9.98813	9.38969	9.98627	40
21	33018	98983	36343	98810	39318	98623	39
22	33075	98980	36396	98807	39367	98620	38
23	33133	98978	36449	98804	39417	98617	37
24	33190	98975	36502	98801	39466	98614	36
25	33248	98972	36555	98798	39515	98610	35
26	33305	98969	36608	98795	39564	98607	34
27	33362	98967	36660	98792	39613	98604	33
28	33420	98964	36713	98789	39662	98601	32
29	33477	98961	36766	98786	39711	98597	31
30	9.33534	9.98958	9.36819	9.98783	9.38960	9.98594	30
31	33591	98955	36871	98780	39760	98591	29
32	33647	98953	36924	98777	39808	98588	28
33	33704	98950	36976	98774	40006	98584	27
34	33761	98947	37028	98771	40055	98581	26
35	33818	98944	37081	98768	40103	98578	25
36	33874	98941	37133	98765	40152	98574	24
37	33931	98938	37185	98762	40200	98571	23
38	33987	98936	37237	98759	40249	98568	22
39	34043	98933	37289	98756	40297	98565	21
40	9.34100	9.98900	9.37341	9.98753	9.40346	9.98561	20
41	34156	98927	37393	98750	40394	98558	19
42	34212	98924	37445	98746	40442	98555	18
43	34268	98921	37497	98743	40490	98551	17
44	34324	98919	37549	98740	40538	98548	16
45	34380	98916	37600	98737	40586	98545	15
46	34436	98913	37652	98734	40634	98541	14
47	34491	98910	37703	98731	40682	98538	13
48	34547	98907	37755	98728	40730	98535	12
49	34602	98904	37806	98725	40778	98531	11
50	9.34658	9.98901	9.37858	9.98722	9.40825	9.98528	10
51	34713	98898	37859	98719	40873	98525	9
52	34769	98896	37960	98715	40921	98521	8
53	34824	98893	38011	98712	40968	98518	7
54	34879	98890	38062	98709	41016	98515	6
55	34934	98887	38113	98706	41063	98511	5
56	34989	98884	38164	98703	41111	98508	4
57	35044	98881	38215	98700	41158	98505	3
58	35099	98878	38266	98697	41205	98501	2
59	35154	98875	38317	98694	41252	98498	1
60	35209	98872	38368	98690	41300	98494	0
	Cosine	Sine	Cosine	Sine	Cosine	Sine	
	77°		76°		75°		

TABLE II.—LOGARITHMIC SINES AND COSINES.

	15°		16°		17°		
	Sine	Cosine	Sine	Cosine	Sine	Cosine	
0	9.41800	9.98494	9.44084	9.98294	9.46594	9.98060	60
1	41847	98491	44078	98281	46685	98066	59
2	41894	98489	44123	98277	46776	98063	58
3	41441	98484	44166	98273	46717	98048	57
4	41498	98481	44210	98270	46758	98044	56
5	41535	98477	44253	98266	46800	98040	55
6	41582	98474	44297	98262	46841	98036	54
7	41628	98471	44341	98259	46882	98032	53
8	41675	98467	44385	98255	46923	98029	52
9	41722	98464	44428	98251	46964	98025	51
10	9.41768	9.98460	9.44472	9.98248	9.47005	9.98021	50
11	41815	98457	44516	98244	47045	98017	49
12	41861	98453	44559	98240	47086	98013	48
13	41908	98450	44602	98237	47127	98009	47
14	41954	98447	44646	98233	47168	98005	46
15	42001	98443	44689	98229	47209	98001	45
16	42047	98440	44733	98226	47249	97997	44
17	42093	98436	44776	98222	47290	97993	43
18	42140	98433	44819	98218	47330	97989	42
19	42186	98429	44862	98215	47371	97986	41
20	9.42232	9.98426	9.44906	9.98211	9.47411	9.97982	40
21	42278	98422	44948	98207	47452	97978	39
22	42324	98419	44992	98204	47492	97974	38
23	42370	98415	45035	98200	47533	97970	37
24	42416	98412	45077	98196	47573	97966	36
25	42461	98409	45120	98192	47613	97962	35
26	42507	98405	45163	98189	47654	97958	34
27	42553	98402	45206	98185	47694	97954	33
28	42599	98398	45249	98181	47734	97950	32
29	42644	98395	45292	98177	47774	97946	31
30	9.42690	9.98391	9.45324	9.98174	9.47814	9.97942	30
31	42735	98388	45377	98170	47854	97938	29
32	42781	98384	45419	98166	47894	97934	28
33	42826	98381	45462	98162	47934	97930	27
34	42872	98377	45504	98159	47974	97926	26
35	42917	98373	45547	98155	48014	97922	25
36	42963	98370	45589	98151	48054	97918	24
37	43008	98366	45632	98147	48094	97914	23
38	43053	98363	45674	98144	48133	97910	22
39	43098	98359	45716	98140	48173	97906	21
40	9.43143	9.98356	9.45758	9.98136	9.48213	9.97902	20
41	43188	98352	45801	98132	48252	97898	19
42	43233	98349	45843	98129	48292	97894	18
43	43278	98345	45885	98125	48332	97890	17
44	43322	98342	45927	98121	48371	97886	16
45	43367	98338	45969	98117	48411	97882	15
46	43412	98334	46011	98113	48450	97878	14
47	43457	98331	46053	98110	48490	97874	13
48	43502	98327	46095	98106	48529	97870	12
49	43546	98324	46136	98102	48568	97866	11
50	9.43591	9.98320	9.46178	9.98098	9.48607	9.97861	10
51	43635	98317	46220	98094	48647	97857	9
52	43680	98313	46262	98090	48686	97853	8
53	43724	98309	46303	98087	48725	97849	7
54	43769	98306	46345	98083	48764	97845	6
55	43813	98302	46386	98079	48803	97841	5
56	43857	98299	46428	98075	48842	97837	4
57	43901	98295	46469	98071	48881	97833	3
58	43946	98291	46511	98067	48920	97829	2
59	43990	98288	46552	98063	48959	97825	1
60	44034	98284	46594	98060	48998	97821	0
	Cosine	Sine	Cosine	Sine	Cosine	Sine	
		74°		78°		72°	

TABLE II.—LOGARITHMIC SINES AND COSINES.

	18°		19°		20°		
	Sine	Cosine	Sine	Cosine	Sine	Cosine	
0	9.48098	9.97891	9.51264	9.97567	9.53405	9.97299	60
1	49037	07817	51301	97563	53440	97294	59
2	49076	97812	51339	97558	53476	97289	58
3	49115	97806	51374	97554	53509	97285	57
4	49153	97804	51411	97550	53544	97280	56
5	49192	97800	51447	97545	53578	97276	55
6	49231	97796	51484	97541	53612	97271	54
7	49269	97792	51520	97536	53647	97266	53
8	49308	97788	51557	97532	53682	97262	52
9	49347	97784	51593	97528	53716	97257	51
10	9.49385	9.97779	9.51639	9.97523	9.53751	9.97252	50
11	49424	97775	51666	97519	53785	97248	49
12	49462	97771	51702	97515	53819	97243	48
13	49500	97767	51738	97510	53854	97238	47
14	49539	97763	51774	97506	53888	97234	46
15	49577	97759	51811	97501	53922	97229	45
16	49615	97754	51847	97497	53957	97224	44
17	49654	97750	51883	97492	53991	97220	43
18	49692	97746	51919	97488	54025	97215	42
19	49730	97742	51955	97484	F 059	97210	41
20	9.49768	9.97738	9.51991	9.97479	9.54068	9.97205	40
21	49806	97734	52027	97475	54127	97201	39
22	49844	97729	52063	97470	54161	97196	38
23	49882	97725	52099	97466	54195	97192	37
24	49920	97721	52135	97461	54229	97187	36
25	49958	97717	52171	97457	54263	97183	35
26	49996	97713	52207	97453	54297	97178	34
27	50034	97708	52243	97448	54331	97173	33
28	50072	97704	52278	97444	54365	97168	32
29	50110	97700	52314	97439	54399	97163	31
30	9.50148	9.97696	9.52350	9.97435	9.54433	9.97159	30
31	50185	97691	52385	97430	54466	97154	29
32	50223	97687	52421	97426	54500	97149	28
33	50261	97683	52456	97421	54534	97145	27
34	50298	97679	52492	97417	54567	97140	26
35	50336	97674	52527	97412	54601	97135	25
36	50374	97670	52563	97408	54635	97130	24
37	50411	97666	52598	97403	54668	97126	23
38	50449	97662	52634	97399	54702	97121	22
39	50486	97657	52669	97394	54735	97116	21
40	9.50523	9.97653	9.52705	9.97390	9.54769	9.97111	20
41	50561	97649	52740	97385	54802	97107	19
42	50599	97645	52775	97381	54836	97102	18
43	50635	97640	52811	97376	54869	97097	17
44	50673	97636	52846	97372	54903	97092	16
45	50710	97632	52881	97367	54936	97087	15
46	50747	97628	52916	97363	54969	97083	14
47	50784	97623	52951	97358	55002	97078	13
48	50821	97619	52986	97353	55036	97073	12
49	50858	97615	53021	97349	55069	97068	11
50	9.50896	9.97610	9.53056	9.97344	9.55102	9.97063	10
51	50933	97606	53092	97340	55136	97059	9
52	50970	97602	53126	97335	55169	97054	8
53	51007	97597	53161	97331	55202	97049	7
54	51043	97593	53196	97326	55235	97044	6
55	51080	97589	53231	97322	55268	97039	5
56	51117	97584	53266	97317	55301	97035	4
57	51154	97580	53301	97312	55334	97030	3
58	51191	97576	53336	97308	55367	97025	2
59	51227	97571	53370	97303	55400	97020	1
60	51264	97567	53405	97299	55433	97015	0
	Cosine	Sine	Cosine	Sine	Cosine	Sine	
	71°		70°		69°		

TABLE II.—LOGARITHMIC SINES AND COSINES.

°	21°		22°		23°		°
	Sine	Cosine	Sine	Cosine	Sine	Cosine	
0	9.55438	9.97015	9.57358	9.96717	9.59188	9.96408	60
1	55466	97010	57389	96711	59218	96397	59
2	55499	97005	57430	96706	59247	96392	58
3	55532	97001	57451	96701	59277	96387	57
4	55564	96996	57482	96696	59307	96381	56
5	55597	96991	57514	96691	59336	96375	55
6	55630	96986	57545	96686	59366	96370	54
7	55663	96981	57576	96681	59396	96365	53
8	55695	96976	57607	96676	59425	96360	52
9	55728	96971	57638	96670	59455	96354	51
10	9.55761	9.96966	9.57669	9.96665	9.59484	9.96349	50
11	55793	96962	57700	96660	59514	96343	49
12	55826	96957	57731	96655	59543	96338	48
13	55858	96952	57762	96650	59573	96333	47
14	55891	96947	57793	96645	59602	96327	46
15	55923	96942	57824	96640	59632	96322	45
16	55956	96937	57855	96634	59661	96316	44
17	55988	96932	57885	96629	59690	96311	43
18	56021	96927	57916	96624	59720	96305	42
19	56053	96922	57947	96619	59749	96300	41
20	9.56085	9.96917	9.57978	9.96614	9.59778	9.96294	40
21	56118	96912	58008	96608	59808	96289	39
22	56150	96907	58039	96603	59837	96284	38
23	56183	96902	58070	96598	59866	96278	37
24	56215	96896	58101	96593	59895	96273	36
25	56247	96891	58131	96588	59924	96267	35
26	56279	96886	58162	96583	59954	96262	34
27	56311	96881	58192	96577	59983	96256	33
28	56343	96876	58223	96572	60012	96251	32
29	56375	96871	58253	96567	60041	96245	31
30	9.56408	9.96868	9.58264	9.96562	9.60070	9.96240	30
31	56440	96863	58284	96556	60099	96234	29
32	56472	96858	58315	96551	60128	96229	28
33	56504	96853	58345	96546	60157	96223	27
34	56536	96848	58376	96541	60186	96218	26
35	56568	96843	58406	96535	60215	96212	25
36	56599	96838	58437	96530	60244	96207	24
37	56631	96833	58467	96525	60273	96201	23
38	56663	96828	58497	96520	60302	96196	22
39	56695	96823	58527	96514	60331	96190	21
40	9.56727	9.96818	9.58588	9.96509	9.60359	9.96185	20
41	56759	96813	58558	96504	60368	96179	19
42	56790	96808	58588	96498	60397	96174	18
43	56822	96803	58618	96493	60426	96168	17
44	56854	96798	58649	96488	60454	96162	16
45	56886	96793	58679	96483	60483	96157	15
46	56917	96788	58709	96477	60512	96151	14
47	56949	96783	58739	96472	60541	96146	13
48	56980	96778	58769	96467	60569	96140	12
49	57012	96773	58799	96461	60598	96135	11
50	9.57044	9.96767	9.58889	9.96456	9.60646	9.96129	10
51	57075	96762	58819	96451	60675	96123	9
52	57107	96757	58849	96445	60704	96118	8
53	57138	96752	58879	96440	60733	96112	7
54	57169	96747	58909	96435	60761	96107	6
55	57201	96742	58939	96429	60789	96101	5
56	57232	96737	58969	96424	60818	96095	4
57	57264	96732	58998	96419	60846	96090	3
58	57295	96727	59028	96413	60875	96084	2
59	57326	96722	59058	96408	60903	96079	1
60	57358	96717	59088	96403	60931	96073	0
	Cosine	Sine	Cosine	Sine	Cosine	Sine	
	68°		67°		66°		

TALBE II.—LOGARITHMIC SINES AND COSINES.

/	24°		25°		26°		/
	Sine	Cosine	Sine	Cosine	Sine	Cosine	
0	9.60981	9.96073	9.62295	9.95723	9.64184	9.95896	60
1	60960	96067	62222	95722	64210	95860	59
2	60988	96068	62249	95716	64236	95824	58
3	61016	96058	62276	95710	64262	95788	57
4	61045	96050	62303	95704	64288	95751	56
5	61073	96045	62330	95698	64313	95715	55
6	61101	96039	62357	95692	64339	95679	54
7	61129	96034	62384	95686	64365	95643	53
8	61158	96028	62411	95680	64391	95607	52
9	61186	96022	62438	95674	64417	95571	51
10	9.61214	9.96017	9.62465	9.95668	9.64442	9.95504	50
11	61242	96011	62492	95663	64468	95568	49
12	61270	96005	62518	95657	64494	95532	48
13	61298	96000	62545	95651	64519	95496	47
14	61326	95994	62572	95645	64545	95460	46
15	61354	95988	62599	95639	64571	95424	45
16	61382	95982	62626	95633	64596	95388	44
17	61411	95977	62652	95627	64622	95352	43
18	61438	95971	62679	95621	64647	95316	42
19	61466	95965	62706	95615	64673	95280	41
20	9.61494	9.95960	9.62733	9.95609	9.64698	9.95244	40
21	61522	95954	62760	95603	64724	95208	39
22	61550	95948	62786	95597	64749	95172	38
23	61578	95942	62813	95591	64775	95136	37
24	61606	95937	62839	95585	64800	95100	36
25	61634	95931	62866	95579	64826	95064	35
26	61662	95925	62892	95573	64851	95028	34
27	61690	95920	62919	95567	64877	94992	33
28	61717	95914	62945	95561	64902	94956	32
29	61745	95908	62972	95555	64927	94920	31
30	9.61773	9.95902	9.62998	9.95549	9.64953	9.94919	30
31	61800	95907	63025	95543	64978	94883	29
32	61828	95901	63051	95537	65003	94847	28
33	61856	95895	63077	95531	65029	94811	27
34	61883	95889	63104	95525	65054	94775	26
35	61911	95883	63131	95519	65079	94739	25
36	61939	95878	63157	95513	65104	94703	24
37	61966	95872	63183	95507	65129	94667	23
38	61994	95866	63210	95501	65154	94631	22
39	62021	95860	63236	95494	65179	94595	21
40	9.62049	9.95844	9.63262	9.95488	9.65205	9.94516	20
41	62076	95839	63289	95482	65230	94480	19
42	62104	95833	63315	95476	65255	94444	18
43	62131	95827	63341	95470	65281	94408	17
44	62159	95821	63367	95464	65306	94372	16
45	62186	95815	63394	95458	65331	94336	15
46	62214	95810	63420	95452	65356	94300	14
47	62241	95804	63446	95446	65381	94264	13
48	62268	95798	63472	95440	65406	94228	12
49	62296	95792	63498	95434	65431	94192	11
50	9.62323	9.95786	9.63524	9.95427	9.65456	9.94156	10
51	62350	95780	63550	95421	65481	94120	9
52	62377	95775	63576	95415	65506	94084	8
53	62405	95769	63602	95409	65531	94048	7
54	62432	95763	63628	95403	65556	94012	6
55	62459	95757	63654	95397	65580	93976	5
56	62486	95751	63680	95391	65605	93940	4
57	62513	95745	63706	95385	65630	93904	3
58	62541	95739	63732	95379	65654	93868	2
59	62568	95733	63758	95373	65679	93832	1
60	62595	95727	63784	95367	65703	93796	0
/	Cosine	Sine	Cosine	Sine	Cosine	Sine	/
	65°		64°		63°		

TABLE II.—LOGARITHMIC SINES AND COSINES.

°	27°		28°		29°		°
	Sine	Cosine	Sine	Cosine	Sine	Cosine	
0	9.65705	9.94988	9.67161	9.94598	9.68557	9.94182	60
1	65729	94982	67185	94667	68580	94175	59
2	65754	94975	67208	94580	68608	94168	58
3	65779	94969	67232	94573	68625	94161	57
4	65804	94962	67255	94567	68648	94154	56
5	65828	94955	67280	94560	68671	94147	55
6	65853	94949	67303	94553	68694	94140	54
7	65878	94942	67327	94546	68716	94133	53
8	65902	94936	67350	94540	68739	94126	52
9	65927	94930	67374	94533	68762	94119	51
10	9.65953	9.94923	9.67398	9.94526	9.68784	9.94112	50
11	65976	94917	67421	94519	68807	94105	49
12	66001	94911	67445	94513	68829	94098	48
13	66025	94904	67468	94506	68852	94090	47
14	66050	94898	67492	94499	68875	94083	46
15	66075	94891	67515	94492	68897	94076	45
16	66099	94885	67539	94485	68920	94069	44
17	66124	94878	67562	94478	68942	94062	43
18	66148	94871	67586	94472	68965	94055	42
19	66173	94865	67609	94465	68987	94048	41
20	9.66197	9.94858	9.67633	9.94458	9.69010	9.94041	40
21	66221	94852	67656	94451	69032	94034	39
22	66246	94845	67680	94445	69055	94027	38
23	66270	94839	67703	94438	69077	94020	37
24	66295	94832	67726	94431	69100	94012	36
25	66319	94826	67750	94424	69122	94005	35
26	66343	94819	67773	94417	69144	93998	34
27	66368	94813	67796	94410	69167	93991	33
28	66392	94806	67820	94404	69189	93984	32
29	66416	94799	67843	94397	69212	93977	31
30	9.66441	9.94793	9.67866	9.94390	9.69234	9.93970	30
31	66465	94786	67890	94383	69256	93963	29
32	66489	94780	67913	94376	69279	93955	28
33	66513	94773	67936	94369	69301	93948	27
34	66537	94767	67959	94362	69323	93941	26
35	66562	94760	67982	94355	69345	93934	25
36	66586	94753	68006	94349	69368	93927	24
37	66610	94747	68029	94342	69390	93920	23
38	66634	94740	68052	94335	69412	93912	22
39	66658	94734	68075	94328	69434	93905	21
40	9.66682	9.94727	9.68098	9.94321	9.69456	9.93898	20
41	66706	94720	68121	94314	69477	93891	19
42	66731	94714	68144	94307	69501	93884	18
43	66755	94707	68167	94300	69523	93876	17
44	66779	94700	68190	94293	69545	93869	16
45	66803	94694	68213	94286	69567	93862	15
46	66827	94687	68237	94279	69589	93855	14
47	66851	94680	68260	94272	69611	93847	13
48	66875	94674	68283	94265	69633	93840	12
49	66899	94667	68306	94259	69655	93833	11
50	9.66922	9.94660	9.68328	9.94253	9.69677	9.93826	10
51	66945	94654	68351	94245	69699	93819	9
52	66970	94647	68374	94238	69721	93811	8
53	66994	94640	68397	94231	69743	93804	7
54	67018	94634	68420	94224	69765	93797	6
55	67042	94627	68443	94217	69787	93789	5
56	67066	94620	68466	94210	69809	93782	4
57	67090	94614	68489	94203	69831	93775	3
58	67113	94607	68512	94196	69853	93768	2
59	67137	94600	68534	94189	69875	93760	1
60	67161	94593	68557	94182	69897	93753	0
	Cosine	Sine	Cosine	Sine	Cosine	Sine	
	60°		61°		60°		

TABLE II.—LOGARITHMIC SINES AND COSINES.

	80°		81°		82°		
	Sine	Cosine	Sine	Cosine	Sine	Cosine	
0	9.69897	9.98753	9.71184	9.98807	9.72421	9.98842	60
1	69919	93746	71205	98399	72441	92884	59
2	69941	93739	71226	98391	72461	92886	58
3	69963	93731	71247	98384	72482	92818	57
4	69984	93724	71268	98376	72502	92810	56
5	70006	93717	71289	98369	72523	92803	55
6	70028	93709	71310	98361	72542	92795	54
7	70050	93702	71331	98353	72563	92787	53
8	70072	93696	71352	98346	72582	92779	52
9	70093	93687	71373	98338	72602	92771	51
10	9.70115	9.93680	9.71398	9.98330	9.72622	9.92763	50
11	70137	93673	71414	98322	72648	92755	49
12	70159	93665	71435	98315	72663	92747	48
13	70180	93658	71456	98307	72683	92739	47
14	70202	93650	71477	98300	72708	92731	46
15	70224	93643	71498	98292	72723	92723	45
16	70245	93636	71519	98284	72743	92715	44
17	70267	93628	71539	98277	72763	92707	43
18	70288	93621	71560	98269	72783	92699	42
19	70310	93614	71581	98261	72808	92691	41
20	9.70332	9.93606	9.71602	9.98154	9.72822	9.92683	40
21	70353	93599	71622	98146	72843	92675	39
22	70375	93591	71643	98138	72863	92667	38
23	70396	93584	71664	98131	72883	92659	37
24	70418	93577	71685	98123	72902	92651	36
25	70439	93569	71705	98115	72922	92643	35
26	70461	93562	71726	98106	72942	92635	34
27	70482	93554	71747	98100	72962	92627	33
28	70504	93547	71767	98092	72982	92619	32
29	70525	93539	71788	98084	73002	92611	31
30	9.70547	9.93533	9.71809	9.98077	9.72832	9.92603	30
31	70568	93525	71829	98069	73041	92595	29
32	70590	93517	71850	98061	73061	92587	28
33	70611	93510	71870	98053	73081	92579	27
34	70632	93502	71891	98046	73101	92571	26
35	70654	93495	71911	98038	73121	92563	25
36	70675	93487	71932	98030	73140	92555	24
37	70697	93480	71952	98022	73160	92546	23
38	70718	93472	71973	98014	73180	92538	22
39	70739	93465	71994	98007	73200	92530	21
40	9.70761	9.93457	9.72014	9.98009	9.72819	9.92522	20
41	70782	93450	72034	97991	73229	92514	19
42	70803	93443	72055	97983	73249	92506	18
43	70824	93435	72075	97976	73278	92498	17
44	70845	93427	72096	97968	73298	92490	16
45	70867	93420	72116	97960	73318	92482	15
46	70888	93412	72137	97952	73337	92473	14
47	70909	93405	72157	97944	73357	92465	13
48	70931	93397	72177	97936	73377	92457	12
49	70952	93390	72198	97929	73396	92449	11
50	9.70975	9.93383	9.72218	9.98021	9.72816	9.92441	10
51	70994	93375	72228	97913	73415	92433	9
52	71015	93367	72249	97905	73455	92425	8
53	71036	93360	72270	97897	73474	92416	7
54	71058	93352	72290	97889	73494	92408	6
55	71079	93344	72320	97881	73513	92400	5
56	71100	93337	72340	97874	73532	92392	4
57	71121	93329	72360	97866	73552	92384	3
58	71142	93322	72381	97858	73572	92376	2
59	71163	93314	72401	97850	73591	92367	1
60	71184	93307	72421	97842	73611	92359	0
	Cosine	Sine	Cosine	Sine	Cosine	Sine	
	59°		58°		57°		

TABLE II.—LOGARITHMIC SINES AND COSINES.

	33°		34°		35°		
	Sine	Cosine	Sine	Cosine	Sine	Cosine	
0	9.73611	9.92359	9.74756	9.91857	9.75859	9.91336	60
1	73630	92351	74775	91849	75877	91328	59
2	73650	92343	74794	91840	75895	91319	58
3	73669	92335	74813	91832	75913	91310	57
4	73689	92326	74831	91823	75931	91301	56
5	73708	92318	74850	91815	75949	91292	55
6	73727	92310	74868	91806	75967	91283	54
7	73747	92302	74887	91798	75985	91274	53
8	73766	92293	74906	91789	76003	91265	52
9	73785	92285	74924	91781	76021	91257	51
10	9.73805	9.92277	9.74943	9.91772	9.76039	9.91248	50
11	73824	92269	74961	91763	76057	91239	49
12	73843	92260	74980	91755	76075	91230	48
13	73862	92252	74999	91746	76093	91221	47
14	73881	92244	75017	91738	76111	91212	46
15	73901	92235	75036	91729	76129	91203	45
16	73921	92227	75054	91720	76146	91194	44
17	73940	92219	75073	91712	76164	91185	43
18	73959	92211	75091	91703	76182	91176	42
19	73978	92202	75110	91695	76200	91167	41
20	9.73997	9.92194	9.75128	9.91686	9.76218	9.91158	40
21	74017	92186	75147	91677	76236	91149	39
22	74036	92177	75165	91669	76253	91141	38
23	74055	92169	75184	91660	76271	91132	37
24	74074	92161	75202	91651	76289	91123	36
25	74093	92152	75221	91643	76307	91114	35
26	74113	92144	75239	91634	76324	91105	34
27	74132	92135	75258	91625	76342	91096	33
28	74151	92127	75276	91617	76360	91087	32
29	74170	92119	75294	91608	76378	91078	31
30	9.74189	9.92111	9.75313	9.91599	9.76395	9.91069	30
31	74208	92102	75331	91591	76413	91059	29
32	74227	92094	75350	91582	76431	91051	28
33	74246	92086	75368	91573	76448	91042	27
34	74265	92077	75386	91565	76466	91033	26
35	74284	92069	75405	91556	76484	91023	25
36	74303	92060	75423	91547	76501	91014	24
37	74322	92052	75441	91538	76519	91005	23
38	74341	92044	75459	91530	76537	90996	22
39	74360	92035	75478	91521	76554	90987	21
40	9.74379	9.92027	9.75496	9.91512	9.76572	9.90978	20
41	74398	92018	75514	91504	76590	90969	19
42	74417	92010	75533	91495	76607	90960	18
43	74436	92002	75551	91486	76625	90951	17
44	74455	91993	75569	91477	76642	90942	16
45	74474	91985	75587	91469	76660	90933	15
46	74493	91976	75605	91460	76677	90924	14
47	74512	91968	75624	91451	76695	90915	13
48	74531	91959	75642	91443	76712	90906	12
49	74549	91951	75660	91433	76730	90896	11
50	9.74568	9.91943	9.75678	9.91425	9.76747	9.90887	10
51	74587	91934	75696	91416	76765	90878	9
52	74606	91925	75714	91407	76783	90869	8
53	74625	91917	75733	91398	76800	90860	7
54	74644	91908	75751	91389	76817	90851	6
55	74663	91900	75769	91381	76835	90842	5
56	74681	91891	75787	91372	76853	90833	4
57	74700	91883	75805	91363	76870	90823	3
58	74719	91874	75823	91354	76887	90814	2
59	74737	91866	75841	91345	76904	90805	1
60	74756	91857	75859	91336	76922	90796	0
	Cosine	Sine	Cosine	Sine	Cosine	Sine	
	33°		34°		35°		

TABLE II.—LOGARITHMIC SINES AND COSINES.

°	86°		87°		88°		°
	Sine	Cosine	Sine	Cosine	Sine	Cosine	
0	9.76923	9.90796	9.77946	9.90235	9.78934	9.89658	60
1	76929	90787	77963	90225	78950	89643	59
2	76937	90777	77960	90216	78967	89638	58
3	76944	90768	77957	90206	78983	89634	57
4	76951	90759	77953	90197	78999	89614	56
5	77009	90750	78000	90187	79015	89604	55
6	77026	90741	78047	90178	79031	89594	54
7	77043	90731	78093	90168	79047	89584	53
8	77061	90722	78090	90159	79063	89574	52
9	77078	90713	78007	90149	79079	89564	51
10	9.77095	9.90704	9.78118	9.90139	9.79095	9.89554	50
11	77112	90694	78180	90130	79111	89544	49
12	77130	90685	78147	90120	79128	89534	48
13	77147	90676	78163	90111	79144	89524	47
14	77164	90667	78180	90101	79160	89514	46
15	77181	90657	78197	90091	79176	89504	45
16	77199	90648	78218	90082	79192	89495	44
17	77216	90639	78230	90072	79208	89485	43
18	77233	90630	78246	90063	79224	89475	42
19	77250	90620	78263	90053	79240	89465	41
20	9.77266	9.90611	9.78280	9.90043	9.79256	9.89455	40
21	77285	90602	78296	90034	79272	89445	39
22	77302	90592	78313	90024	79288	89435	38
23	77319	90583	78329	90014	79304	89425	37
24	77336	90574	78345	90005	79319	89415	36
25	77353	90565	78362	89995	79335	89405	35
26	77370	90555	78379	89985	79351	89395	34
27	77387	90546	78395	89976	79367	89385	33
28	77405	90537	78412	89966	79383	89375	32
29	77422	90527	78428	89956	79399	89364	31
30	9.77439	9.90518	9.78445	9.89947	9.79415	9.89354	30
31	77456	90509	78461	89937	79431	89344	29
32	77473	90499	78478	89927	79447	89334	28
33	77490	90490	78494	89918	79463	89324	27
34	77507	90480	78510	89908	79478	89314	26
35	77524	90471	78527	89898	79494	89304	25
36	77541	90462	78543	89888	79510	89294	24
37	77558	90452	78560	89879	79526	89284	23
38	77575	90443	78576	89869	79542	89274	22
39	77592	90434	78592	89859	79558	89264	21
40	9.77609	9.90424	9.78609	9.89849	9.79573	9.89254	20
41	77626	90415	78625	89840	79589	89244	19
42	77643	90405	78642	89830	79605	89235	18
43	77660	90396	78658	89820	79621	89225	17
44	77677	90386	78674	89810	79637	89215	16
45	77694	90377	78691	89801	79652	89205	15
46	77711	90368	78707	89791	79668	89195	14
47	77728	90359	78723	89781	79684	89185	13
48	77744	90349	78739	89771	79699	89173	12
49	77761	90339	78756	89761	79715	89162	11
50	9.77778	9.90330	9.78732	9.89752	9.79731	9.89152	10
51	77795	90320	78768	89742	79746	89142	9
52	77812	90311	78805	89732	79762	89132	8
53	77829	90301	78821	89722	79778	89122	7
54	77846	90292	78837	89712	79793	89112	6
55	77862	90282	78853	89702	79809	89101	5
56	77879	90273	78869	89692	79825	89091	4
57	77896	90263	78886	89682	79840	89081	3
58	77913	90254	78902	89673	79856	89071	2
59	77930	90244	78918	89663	79872	89060	1
60	77946	90235	78934	89653	79887	89050	0
	Cosine	Sine	Cosine	Sine	Cosine	Sine	
	53°		52°		51°		

TABLE II.—LOGARITHMIC SINES AND COSINES.

	39°		40°		41°		
	Sine	Cosine	Sine	Cosine	Sine	Cosine	
0	9.79887	9.80050	9.80807	9.88425	9.81694	9.87778	60
1	79903	80040	80622	88415	81709	87767	59
2	79918	80030	80637	88404	81723	87756	58
3	79934	80020	80652	88394	81738	87745	57
4	79950	80009	80667	88385	81752	87734	56
5	79965	89999	80682	88373	81767	87722	55
6	79981	89989	80697	88363	81781	87711	54
7	79996	89978	80712	88351	81796	87701	53
8	80012	89968	80727	88340	81810	87690	52
9	80027	89958	80742	88330	81825	87679	51
10	9.80043	9.89948	9.80957	9.88319	9.81839	9.87668	50
11	80058	89937	80972	88306	81854	87657	49
12	80074	89927	80987	88296	81868	87646	48
13	80089	89917	81002	88287	81882	87635	47
14	80105	89906	81017	88276	81897	87624	46
15	80120	89896	81032	88266	81911	87613	45
16	80136	89886	81047	88255	81926	87601	44
17	80151	89875	81061	88244	81940	87590	43
18	80166	89865	81076	88234	81955	87579	42
19	80182	89855	81091	88223	81969	87568	41
20	9.80197	9.89844	9.81106	9.88212	9.81983	9.87557	40
21	80213	89834	81121	88201	81998	87546	39
22	80228	89824	81136	88191	82012	87535	38
23	80244	89813	81151	88180	82026	87524	37
24	80259	89803	81166	88169	82041	87513	36
25	80274	89793	81180	88158	82055	87501	35
26	80290	89782	81195	88148	82069	87490	34
27	80306	89772	81210	88137	82084	87479	33
28	80320	89761	81225	88126	82098	87468	32
29	80336	89751	81240	88115	82112	87457	31
30	9.80351	9.89741	9.81254	9.88105	9.82126	9.87446	30
31	80366	89730	81269	88094	82141	87434	29
32	80382	89720	81284	88083	82155	87423	28
33	80397	89709	81299	88072	82169	87412	27
34	80412	89699	81314	88061	82184	87401	26
35	80428	89688	81328	88051	82198	87390	25
36	80443	89678	81343	88040	82212	87378	24
37	80458	89668	81358	88029	82226	87367	23
38	80473	89657	81372	88018	82240	87356	22
39	80489	89647	81387	88007	82255	87345	21
40	9.80504	9.89636	9.81402	9.87996	9.82269	9.87334	20
41	80519	89626	81417	87985	82283	87323	19
42	80534	89615	81431	87975	82297	87311	18
43	80550	89605	81446	87964	82311	87300	17
44	80565	89594	81461	87953	82325	87288	16
45	80580	89584	81475	87942	82340	87277	15
46	80595	89573	81490	87931	82354	87266	14
47	80610	89563	81505	87920	82368	87255	13
48	80625	89552	81519	87909	82382	87244	12
49	80641	89542	81534	87898	82396	87232	11
50	9.80656	9.89531	9.81549	9.87887	9.82410	9.87221	10
51	80671	89521	81563	87877	82424	87209	9
52	80686	89510	81578	87866	82439	87198	8
53	80701	89499	81592	87855	82453	87187	7
54	80716	89489	81607	87844	82467	87175	6
55	80731	89478	81622	87832	82481	87164	5
56	80746	89468	81636	87822	82495	87153	4
57	80762	89457	81651	87811	82509	87141	3
58	80777	89447	81665	87800	82523	87130	2
59	80792	89436	81680	87789	82537	87119	1
60	80807	89425	81694	87778	82551	87107	0
	Cosine	Sine	Cosine	Sine	Cosine	Sine	
	50°		49°		48°		

TABLE II.—LOGARITHMIC SINES AND COSINES.

	42°		43°		44°		
	Sine	Cosine	Sine	Cosine	Sine	Cosine	
0	9.82551	9.87107	9.88378	9.86418	9.84177	9.85693	60
1	82555	87096	88392	86401	84190	85681	59
2	82579	87085	88405	86389	84208	85669	58
3	82598	87073	88419	86377	84216	85657	57
4	82607	87062	88432	86366	84229	85645	56
5	82621	87050	88446	86354	84232	85632	55
6	82635	87039	88459	86342	84235	85620	54
7	82649	87028	88473	86330	84239	85608	53
8	82663	87016	88486	86318	84242	85596	52
9	82677	87005	88500	86306	84245	85583	51
10	9.82691	9.86993	9.88513	9.86295	9.84208	9.85571	50
11	82705	86982	88527	86283	84221	85569	49
12	82719	86970	88540	86271	84224	85557	48
13	82738	86959	88554	86259	84227	85544	47
14	82747	86947	88567	86247	84230	85532	46
15	82761	86936	88581	86235	84233	85519	45
16	82775	86924	88594	86223	84236	85507	44
17	82789	86913	88608	86211	84239	85495	43
18	82802	86902	88621	86200	84241	85483	42
19	82816	86890	88634	86188	84244	85470	41
20	9.82830	9.86879	9.88648	9.86176	9.84247	9.85448	40
21	82844	86867	88661	86164	84250	85436	39
22	82858	86855	88674	86152	84253	85423	38
23	82872	86844	88688	86140	84256	85411	37
24	82885	86832	88701	86128	84259	85399	36
25	82899	86821	88715	86116	84262	85386	35
26	82913	86809	88728	86104	84265	85374	34
27	82927	86798	88741	86092	84268	85361	33
28	82941	86786	88755	86080	84270	85349	32
29	82955	86775	88768	86068	84273	85337	31
30	9.82968	9.86763	9.88781	9.86056	9.84266	9.85324	30
31	82982	86752	88795	86044	84270	85312	29
32	82996	86740	88808	86032	84273	85299	28
33	83010	86728	88821	86020	84276	85287	27
34	83023	86717	88834	86008	84279	85274	26
35	83037	86705	88848	85996	84282	85262	25
36	83051	86694	88861	85984	84285	85250	24
37	83065	86682	88874	85972	84288	85237	23
38	83078	86670	88887	85960	84291	85225	22
39	83092	86659	88901	85948	84294	85212	21
40	9.83106	9.86647	9.88914	9.85936	9.84287	9.85200	20
41	83120	86635	88927	85924	84290	85187	19
42	83133	86624	88940	85912	84293	85175	18
43	83147	86612	88954	85900	84296	85162	17
44	83161	86600	88967	85888	84299	85150	16
45	83174	86589	88980	85876	84302	85137	15
46	83188	86577	88993	85864	84305	85125	14
47	83202	86565	89006	85851	84308	85112	13
48	83215	86554	89020	85839	84311	85100	12
49	83229	86542	89033	85827	84314	85087	11
50	9.83242	9.86530	9.89046	9.85815	9.84317	9.85074	10
51	83256	86518	89059	85803	84320	85062	9
52	83270	86507	89072	85791	84323	85049	8
53	83283	86495	89085	85779	84326	85037	7
54	83297	86483	89098	85766	84329	85024	6
55	83310	86472	89112	85754	84332	85012	5
56	83324	86460	89125	85742	84335	84999	4
57	83338	86448	89138	85730	84338	84986	3
58	83351	86436	89151	85718	84341	84974	2
59	83365	86425	89164	85706	84344	84961	1
60	83378	86413	89177	85693	84347	84949	0
	Cosine	Sine	Cosine	Sine	Cosine	Sine	
	42°		43°		44°		

TABLE III.—LOG. TANGENTS AND COTANGENTS.

	0°		1°		2°		
	Tan	Cotan	Tan	Cotan	Tan	Cotan	
0	—∞	∞	8.24192	11.75808	8.54906	11.45092	60
1	6.46373	13.53627	24910	75090	54609	45391	59
2	78476	22524	25416	74584	55027	44973	58
3	94085	05015	26312	73688	55392	44618	57
4	7.06379	19.93421	26996	73004	55794	44266	56
5	16270	83730	27669	72331	56063	43917	55
6	24198	75812	28332	71668	56429	43571	54
7	30889	69118	28996	71014	56773	43227	53
8	36892	63318	29629	70371	57114	42896	52
9	41797	58208	30263	69737	57452	42548	51
10	7.46373	13.53627	8.30688	11.69112	8.67768	11.32232	50
11	50512	49488	31505	68495	58121	41879	49
12	54291	45709	32112	67896	58451	41549	48
13	57767	42283	32711	67299	58779	41221	47
14	60966	39014	33302	66698	59105	40895	46
15	63992	36018	33886	66114	59429	40572	45
16	66735	33215	34461	65539	59749	40251	44
17	69418	30692	35029	64971	60068	39933	43
18	71900	28100	35590	64410	60384	39616	42
19	74248	25752	36143	63857	60698	39309	41
20	7.76476	12.23594	8.36689	11.63311	8.61009	11.38991	40
21	78595	21405	37229	62771	61319	38981	39
22	80615	19385	37762	62288	61626	38674	38
23	82546	17454	38299	61711	61931	38399	37
24	84394	15606	38809	61191	62234	38166	36
25	86167	13833	39323	60677	62535	37965	35
26	87871	12129	39832	60168	62834	37766	34
27	89510	10490	40334	59666	63131	37599	33
28	91099	89311	40830	59170	63426	37374	32
29	92618	77387	41321	58679	63718	37229	31
30	7.94066	12.06914	8.41807	11.58198	8.64009	11.35991	30
31	95510	04490	42297	57713	64298	36708	29
32	96899	03111	42762	57298	64585	36415	28
33	98225	01775	43232	56798	64870	36130	27
34	99522	00478	43696	56304	65154	34846	26
35	8.00781	11.99219	44156	55844	65435	34585	25
36	02004	97996	44611	55389	65715	34325	24
37	03194	96806	45061	54939	65993	34077	23
38	04363	95647	45507	54493	66269	33781	22
39	05481	94519	45948	54052	66543	33467	21
40	8.06891	11.93419	8.46885	11.53615	8.66816	11.33184	20
41	07653	92347	46317	53188	67067	32913	19
42	08700	91300	46745	52755	67356	32644	18
43	09722	90278	47169	52331	67624	32376	17
44	10720	89280	47589	51911	67890	32110	16
45	11696	88304	48005	51495	68154	31846	15
46	12651	87349	48417	51083	68417	31583	14
47	13585	86415	48825	50675	68678	31322	13
48	14500	85500	49229	50271	68938	31062	12
49	15395	84605	50180	49870	69196	30804	11
50	8.16273	11.83727	8.50627	11.49473	8.69458	11.30547	10
51	17138	82667	50920	49080	69708	30592	9
52	17976	82024	51310	48690	69962	30398	8
53	18804	81196	51696	48304	70214	29796	7
54	19616	80384	52079	47921	70465	29585	6
55	20413	79587	52459	47541	70714	29396	5
56	21195	78805	52835	47165	70962	29208	4
57	21964	78036	53208	46792	71208	29022	3
58	22720	77280	53578	46422	71453	28847	2
59	23462	76538	53945	46055	71697	28683	1
60	24192	75808	54308	45692	71940	28560	0
	Cotan	Tan	Cotan	Tan	Cotan	Tan	
	89°		88°		87°		

TABLE III.—LOG. TANGENTS AND COTANGENTS.

	3°		4°		5°		
	Tan	Cotan	Tan	Cotan	Tan	Cotan	
0	8.71940	11.28060	8.84464	11.15536	8.94195	11.05805	60
1	78181	27819	84646	15854	94340	05660	59
2	72480	27580	84826	15174	94485	05515	58
3	72659	27341	85006	14994	94680	05370	57
4	72896	27104	85185	14815	94778	05227	56
5	73193	26865	85363	14637	94917	05083	55
6	73366	26634	85540	14460	95060	04940	54
7	73600	26400	85717	14283	95202	04798	53
8	73832	26168	85893	14107	95344	04656	52
9	74063	25937	86069	13931	95486	04514	51
10	8.74292	11.25708	8.86943	11.13757	8.95637	11.04373	50
11	74521	25479	86417	13683	95767	04233	49
12	74748	25253	86591	13409	95906	04092	48
13	74974	25026	86763	13237	96047	03953	47
14	75199	24801	86935	13065	96187	03813	46
15	75423	24577	87106	12894	96325	03675	45
16	75645	24355	87277	12723	96464	03536	44
17	75867	24133	87447	12553	96602	03396	43
18	76087	23913	87616	12384	96739	03261	42
19	76306	23694	87785	12215	96877	03123	41
20	8.76525	11.23475	8.87053	11.12047	8.97013	11.02967	40
21	76743	23258	88120	11880	97150	02826	39
22	76966	23042	88287	11713	97285	02715	38
23	77178	22827	88453	11547	97421	02579	37
24	77387	22613	88618	11382	97556	02444	36
25	77600	22400	88783	11217	97691	02309	35
26	77811	22189	88948	11052	97825	02175	34
27	78023	21978	89111	10889	97959	02041	33
28	78232	21768	89274	10726	98092	01908	32
29	78441	21559	89437	10563	98225	01775	31
30	8.78649	11.21351	8.89598	11.10402	8.98358	11.01642	30
31	78855	21145	89760	10240	98490	01510	29
32	79061	20930	89920	10080	98622	01378	28
33	79266	20714	90080	9920	98753	01247	27
34	79470	20500	90240	9760	98884	01116	26
35	79673	20287	90399	9601	99015	00985	25
36	79875	20075	90557	9443	99145	00855	24
37	80076	19864	90715	9285	99275	00725	23
38	80277	19652	90872	9128	99405	00595	22
39	80476	19441	91029	8971	99534	00466	21
40	8.80674	11.19326	8.91185	11.08815	8.99662	11.00388	20
41	80673	19128	91340	8860	99791	00309	19
42	81068	18932	91495	8850	99919	00281	18
43	81264	18736	91650	8840	9.00046	10.99954	17
44	81459	18541	91803	88197	00174	99826	16
45	81653	18347	91957	88043	00301	99699	15
46	81846	18154	92110	87890	00427	99573	14
47	82038	17962	92262	87738	00553	99447	13
48	82230	17770	92414	87586	00679	99321	12
49	82420	17580	92565	87435	00805	99195	11
50	8.82610	11.17390	8.92716	11.07284	9.00920	10.99070	10
51	82799	17201	92866	87134	01055	99045	9
52	82987	17013	93016	86984	01179	98921	8
53	83175	16825	93165	86835	01308	98797	7
54	83361	16639	93313	86687	01427	98673	6
55	83547	16453	93462	86538	01550	98549	5
56	83732	16268	93609	86391	01673	98427	4
57	83916	16084	93756	86244	01796	98304	3
58	84100	15900	93903	86097	01919	98182	2
59	84282	15718	94049	85951	02040	97960	1
60	84464	15536	94195	85805	02162	97738	0
	Cotan	Tan	Cotan	Tan	Cotan	Tan	
	86°		85°		84°		

TABLE III.—LOG. TANGENTS AND COTANGENTS.

	6°		7°		8°		
	Tan	Cotan	Tan	Cotan	Tan	Cotan	
0	0.02162	10.97888	9.08914	10.91086	9.14780	10.85220	60
1	02283	97717	09019	90981	14872	85128	59
2	02404	97596	09123	90877	14983	85037	58
3	02525	97475	09227	90773	15094	84946	57
4	02645	97353	09330	90670	15145	84855	56
5	02766	97234	09434	90566	15236	84764	55
6	02885	97115	09537	90463	15327	84673	54
7	03005	96995	09640	90360	15417	84582	53
8	03124	96876	09742	90258	15508	84492	52
9	03242	96758	09845	90155	15598	84402	51
10	9.03361	10.96639	9.09947	10.90053	9.15688	10.84312	50
11	08479	96521	10049	89951	15777	84222	49
12	08597	96403	10150	89850	15867	84133	48
13	03714	96286	10252	89748	15956	84044	47
14	08822	96168	10353	89647	16046	83954	46
15	08948	96052	10454	89546	16135	83865	45
16	04065	95935	10555	89445	16224	83776	44
17	04181	95819	10656	89344	16312	83688	43
18	04297	95703	10756	89244	16401	83599	42
19	04413	95587	10856	89144	16489	83511	41
20	9.04528	10.95472	9.10856	10.89044	9.16577	10.83423	40
21	04648	95357	11056	89044	16565	83333	39
22	04758	95242	11155	88948	16653	83247	38
23	04873	95127	11254	88848	16741	83159	37
24	04987	95011	11353	88747	16828	83072	36
25	05101	94898	11452	88648	17016	82984	35
26	05214	94786	11551	88549	17108	82897	34
27	05328	94672	11649	88451	17199	82810	33
28	05441	94559	11747	88353	17277	82723	32
29	05553	94447	11845	88255	17363	82637	31
30	9.05666	10.94294	9.11943	10.88057	9.17450	10.82550	30
31	05778	94222	12040	87960	17536	82464	29
32	05890	94110	12138	87862	17623	82378	28
33	06002	93998	12235	87765	17708	82292	27
34	06113	93887	12332	87668	17794	82206	26
35	06224	93776	12428	87572	17880	82120	25
36	06335	93665	12525	87475	17965	82035	24
37	06445	93555	12621	87379	18051	81949	23
38	06556	93444	12717	87283	18136	81864	22
39	06666	93334	12813	87187	18221	81779	21
40	9.06775	10.93225	9.12909	10.87091	9.18306	10.81694	20
41	06885	93115	13004	86996	18391	81609	19
42	06994	93006	13099	86901	18475	81525	18
43	07103	92897	13194	86806	18560	81440	17
44	07211	92789	13289	86711	18644	81356	16
45	07320	92680	13384	86616	18728	81272	15
46	07428	92572	13478	86522	18812	81188	14
47	07536	92464	13573	86427	18896	81104	13
48	07643	92357	13667	86332	18979	81021	12
49	07751	92249	13761	86239	19063	80937	11
50	9.07858	10.92142	9.13854	10.86146	9.19146	10.80854	10
51	07964	92036	13848	86052	19229	80771	9
52	08071	91929	14041	85959	19313	80688	8
53	08177	91823	14134	85866	19396	80605	7
54	08282	91717	14227	85773	19478	80522	6
55	08389	91611	14320	85680	19561	80439	5
56	08495	91505	14412	85588	19643	80357	4
57	08600	91400	14504	85496	19725	80275	3
58	08705	91295	14597	85403	19807	80193	2
59	08810	91190	14688	85312	19889	80111	1
60	08914	91086	14780	85220	19971	80029	0
	Cotan	Tan	Cotan	Tan	Cotan	Tan	
	85°		82°		81°		

TABLE III.—LOG. TANGENTS AND COTANGENTS.

	9°		10°		11°		
	Tan	Cotan	Tan	Cotan	Tan	Cotan	
0	9.19971	10.80029	9.24682	10.75318	9.29865	10.71135	60
1	20053	79947	24706	75294	29988	71067	59
2	20134	79866	24779	75221	30000	71000	58
3	20216	79784	24852	75147	30067	70933	57
4	20297	79703	24926	75074	30134	70866	56
5	20378	79622	25000	75000	30201	70799	55
6	20459	79541	25073	74927	30268	70732	54
7	20540	79460	25146	74854	30335	70665	53
8	20621	79379	25219	74781	30402	70598	52
9	20701	79299	25292	74708	30468	70532	51
10	9.20799	10.79218	9.25865	10.74635	9.29585	10.70465	50
11	20862	79188	25367	74663	29601	70899	49
12	20942	79058	25510	74490	30668	70832	48
13	21022	78978	25582	74418	29734	70766	47
14	21102	78898	25655	74345	30800	70700	46
15	21182	78818	25727	74273	29866	70134	45
16	21261	78739	25799	74201	30932	70068	44
17	21341	78659	25871	74129	29998	70002	43
18	21420	78580	25943	74057	30064	69936	42
19	21499	78501	26015	73985	30130	69870	41
20	9.21578	10.78422	9.26066	10.73914	9.30195	10.69905	40
21	21657	78343	26158	73843	30261	69739	39
22	21736	78264	26229	73771	30326	69674	38
23	21814	78186	26301	73699	30391	69609	37
24	21893	78107	26373	73628	30457	69543	36
25	21971	78029	26445	73557	30522	69478	35
26	22049	77951	26514	73486	30587	69413	34
27	22127	77873	26585	73415	30652	69348	33
28	22205	77795	26655	73345	30717	69283	32
29	22283	77717	26726	73274	30782	69218	31
30	9.22261	10.77629	9.26797	10.73208	9.30846	10.69154	30
31	22348	77634	26797	73193	30911	69089	29
32	22416	77484	26867	73063	30975	69025	28
33	22484	77407	27008	72992	31040	68960	27
34	22570	77330	27078	72922	31104	68906	26
35	22647	77253	27148	72852	31168	68852	25
36	22724	77176	27218	72782	31232	68797	24
37	22801	77099	27288	72712	31297	68703	23
38	22877	77022	27357	72642	31361	68659	22
39	22954	76946	27427	72573	31425	68575	21
40	9.23130	10.76870	9.27496	10.72604	9.31489	10.68511	20
41	23006	76794	27566	72484	31552	68446	19
42	23083	76717	27635	72365	31616	68384	18
43	23160	76641	27704	72296	31679	68321	17
44	23235	76565	27773	72227	31743	68257	16
45	23310	76490	27842	72158	31806	68194	15
46	23386	76414	27911	72089	31870	68130	14
47	23461	76339	27980	72020	31933	68067	13
48	23537	76263	28049	71951	31996	68004	12
49	23612	76188	28117	71883	32059	67941	11
50	9.23687	10.76113	9.28186	10.71814	9.32122	10.67878	10
51	23693	76088	28254	71746	32185	67815	9
52	23767	75963	28323	71677	32248	67752	8
53	23841	75888	28391	71609	32311	67689	7
54	23915	75814	28459	71541	32373	67627	6
55	23989	75739	28527	71473	32436	67564	5
56	24063	75665	28595	71405	32498	67502	4
57	24137	75590	28663	71338	32561	67439	3
58	24211	75516	28730	71270	32623	67377	2
59	24285	75442	28798	71203	32685	67315	1
60	24359	75368	28865	71135	32747	67253	0
	Cotan	Tan	Cotan	Tan	Cotan	Tan	
	80°		79°		78°		

TABLE III.—LOG. TANGENTS AND COTANGENTS.

	12°		13°		14°		
	Tan	Cotan	Tan	Cotan	Tan	Cotan	
0	9.32747	10.67253	9.36336	10.63664	9.39677	10.60323	60
1	32810	67190	36394	63606	39781	60269	59
2	32872	67128	36453	63543	39785	60215	58
3	32933	67067	36509	63481	39789	60162	57
4	32995	67005	36566	63418	39792	60108	56
5	33057	66943	36624	63356	39795	60055	55
6	33119	66881	36681	63293	39799	60001	54
7	33180	66820	36738	63231	40052	59948	53
8	33242	66758	36795	63168	40106	59894	52
9	33303	66697	36852	63106	40159	59841	51
10	9.33885	10.66035	9.36909	10.63091	9.40212	10.59789	50
11	33426	66574	36966	63034	40266	59734	49
12	33487	66513	37023	62977	40319	59681	48
13	33548	66452	37080	62920	40372	59628	47
14	33609	66391	37137	62863	40425	59575	46
15	33670	66330	37193	62807	40478	59522	45
16	33731	66269	37250	62750	40531	59469	44
17	33792	66208	37306	62694	40584	59416	43
18	33853	66147	37363	62637	40636	59364	42
19	33913	66087	37419	62581	40689	59311	41
20	9.33974	10.66028	9.37476	10.62524	9.40742	10.59258	40
21	34034	65966	37532	62468	40795	59205	39
22	34095	65905	37589	62412	40847	59153	38
23	34155	65845	37644	62356	40900	59100	37
24	34216	65785	37700	62300	40952	59048	36
25	34276	65724	37756	62244	41005	58996	35
26	34336	65664	37812	62188	41057	58943	34
27	34396	65604	37868	62132	41109	58891	33
28	34456	65544	37924	62076	41161	58839	32
29	34516	65484	37980	62020	41214	58786	31
30	9.34576	10.65424	9.38035	10.61965	9.41265	10.58734	30
31	34635	65365	38091	61909	41318	58682	29
32	34695	65305	38147	61853	41370	58630	28
33	34755	65245	38202	61798	41422	58578	27
34	34814	65186	38257	61743	41474	58526	26
35	34874	65126	38313	61687	41526	58474	25
36	34933	65067	38368	61632	41578	58422	24
37	34992	65008	38423	61577	41629	58371	23
38	35051	64949	38479	61521	41681	58319	22
39	35111	64889	38534	61466	41733	58267	21
40	9.35170	10.64830	9.38589	10.61411	9.41784	10.58216	20
41	35229	64771	38644	61356	41836	58164	19
42	35288	64712	38699	61301	41887	58112	18
43	35347	64653	38754	61246	41939	58061	17
44	35406	64596	38808	61192	41990	58010	16
45	35464	64536	38863	61137	42041	57959	15
46	35523	64477	38918	61082	42092	57907	14
47	35581	64419	38972	61028	42144	57856	13
48	35640	64360	39027	60973	42195	57805	12
49	35698	64302	39082	60918	42246	57754	11
50	9.35757	10.64248	9.39136	10.60864	9.42297	10.57708	10
51	35815	64185	39190	60810	42348	57652	9
52	35873	64127	39245	60755	42399	57601	8
53	35931	64069	39299	60701	42450	57550	7
54	35989	64011	39353	60647	42501	57499	6
55	36047	63953	39407	60593	42552	57448	5
56	36105	63895	39461	60539	42603	57397	4
57	36163	63837	39515	60485	42653	57347	3
58	36221	63779	39569	60431	42704	57296	2
59	36279	63721	39623	60377	42755	57245	1
60	36336	63664	39677	60323	42805	57195	0
	Cotan	Tan	Cotan	Tan	Cotan	Tan	
	77°		76°		75°		

TABLE III.—LOG. TANGENTS AND COTANGENTS.

	15°		16°		17°		
	Tan	Cotan	Tan	Cotan	Tan	Cotan	
0	9.49905	10.57195	9.49760	10.54950	9.49584	10.51466	60
1	49856	57144	45797	54208	48579	51421	59
2	49906	57094	45845	54155	48624	51376	58
3	49957	57043	45892	54106	48669	51331	57
4	49907	56993	45940	54060	48714	51286	56
5	49957	56943	45987	54013	48759	51241	55
6	49908	56892	46035	53965	48804	51196	54
7	49958	56842	46082	53918	48849	51151	53
8	49908	56792	46130	53870	48894	51106	52
9	49958	56742	46177	53823	48939	51061	51
10	9.49906	10.56692	9.46294	10.53776	9.48984	10.51016	50
11	49858	56642	46271	53729	49029	50971	49
12	49408	56592	46319	53681	49073	50927	48
13	49458	56542	46366	53634	49118	50882	47
14	49508	56492	46413	53587	49168	50837	46
15	49558	56442	46460	53540	49207	50793	45
16	49607	56392	46507	53493	49252	50748	44
17	49657	56342	46554	53446	49296	50704	43
18	49707	56292	46601	53399	49341	50659	42
19	49756	56242	46648	53352	49385	50615	41
20	9.49906	10.56104	9.46694	10.53306	9.49480	10.50570	40
21	49855	56145	46741	53259	49474	50525	39
22	49905	56095	46788	53212	49519	50481	38
23	49954	56046	46835	53165	49563	50437	37
24	44004	55996	46881	53119	49607	50393	36
25	44053	55947	46928	53072	49652	50348	35
26	44102	55898	46975	53025	49696	50304	34
27	44151	55849	47021	52979	49740	50260	33
28	44201	55799	47068	52932	49784	50216	32
29	44250	55750	47114	52886	49828	50172	31
30	9.44999	10.55701	9.47160	10.52840	9.49872	10.50128	30
31	44848	55652	47207	52793	49916	50084	29
32	44397	55603	47253	52747	49960	50040	28
33	44446	55554	47299	52701	50004	49996	27
34	44495	55505	47346	52654	50048	49952	26
35	44544	55456	47392	52608	50092	49908	25
36	44593	55408	47438	52562	50136	49864	24
37	44641	55359	47484	52516	50180	49820	23
38	44690	55310	47530	52470	50224	49777	22
39	44738	55262	47576	52424	50267	49733	21
40	9.44797	10.55213	9.47622	10.52378	9.50311	10.49689	20
41	44836	55164	47668	52332	50355	49645	19
42	44884	55116	47714	52286	50398	49602	18
43	44933	55067	47760	52240	50442	49558	17
44	44981	55019	47806	52194	50485	49515	16
45	45029	54971	47852	52148	50529	49471	15
46	45078	54922	47897	52102	50572	49428	14
47	45126	54874	47943	52057	50616	49384	13
48	45174	54826	47989	52011	50659	49341	12
49	45222	54778	48035	51965	50703	49297	11
50	9.45271	10.54729	9.48080	10.51920	9.50746	10.49254	10
51	45319	54681	48126	51874	50789	49211	9
52	45367	54633	48171	51829	50833	49167	8
53	45415	54585	48217	51783	50876	49124	7
54	45463	54537	48262	51738	50919	49081	6
55	45511	54489	48307	51692	50962	49038	5
56	45559	54441	48352	51647	51005	48995	4
57	45606	54394	48398	51602	51048	48952	3
58	45654	54346	48443	51557	51092	48908	2
59	45702	54298	48489	51511	51135	48865	1
60	45750	54250	48534	51466	51178	48822	0
	Cotan	Tan	Cotan	Tan	Cotan	Tan	
	74°		78°		72°		

TABLE III.—LOG. TANGENTS AND COTANGENTS.

	18°		19°		20°		
	Tan	Cotan	Tan	Cotan	Tan	Cotan	
0	9.51178	10.48822	9.53697	10.46303	9.56107	10.43893	60
1	51221	48779	53738	46262	56146	43854	59
2	51264	48736	53779	46221	56186	43815	58
3	51306	48694	53820	46180	56224	43776	57
4	51349	48651	53861	46139	56264	43736	56
5	51392	48608	53902	46098	56303	43697	55
6	51435	48565	53943	46057	56342	43658	54
7	51478	48522	53984	46016	56381	43619	53
8	51520	48480	54025	45975	56420	43580	52
9	51563	48437	54065	45935	56459	43541	51
10	9.51606	10.48394	9.54106	10.45894	9.56498	10.43502	50
11	51648	48352	54147	45853	56537	43463	49
12	51691	48309	54187	45813	56576	43424	48
13	51734	48266	54228	45772	56615	43385	47
14	51776	48224	54269	45731	56654	43346	46
15	51819	48181	54309	45691	56693	43307	45
16	51861	48139	54350	45650	56732	43268	44
17	51903	48097	54390	45610	56771	43229	43
18	51946	48054	54431	45569	56810	43190	42
19	51988	48012	54471	45529	56849	43151	41
20	9.52081	10.47969	9.54512	10.45488	9.56887	10.43118	40
21	52073	47927	54552	45448	56926	43074	39
22	52115	47885	54593	45407	56965	43035	38
23	52157	47843	54633	45367	57004	42996	37
24	52200	47800	54673	45327	57043	42958	36
25	52242	47758	54714	45286	57081	42919	35
26	52284	47716	54754	45246	57120	42880	34
27	52326	47674	54794	45206	57158	42842	33
28	52368	47632	54835	45165	57197	42803	32
29	52410	47590	54875	45125	57235	42765	31
30	9.52452	10.47548	9.54915	10.45085	9.57274	10.42726	30
31	52494	47506	54955	45045	57312	42688	29
32	52536	47464	54995	45006	57351	42649	28
33	52578	47422	55036	44965	57389	42611	27
34	52620	47380	55076	44925	57428	42572	26
35	52661	47339	55115	44885	57466	42534	25
36	52703	47297	55155	44845	57504	42496	24
37	52745	47255	55195	44805	57543	42457	23
38	52787	47213	55235	44765	57581	42419	22
39	52829	47171	55275	44725	57619	42381	21
40	9.52870	10.47130	9.55115	10.44685	9.57658	10.42284	20
41	52912	47088	55355	44645	57696	42304	19
42	52953	47047	55395	44605	57734	42268	18
43	52995	47006	55434	44566	57772	42231	17
44	53037	46963	55474	44526	57810	42190	16
45	53078	46922	55514	44486	57849	42151	15
46	53120	46880	55554	44446	57887	42113	14
47	53161	46839	55593	44407	57925	42075	13
48	53202	46798	55633	44367	57963	42037	12
49	53244	46756	55673	44327	58001	41999	11
50	9.53285	10.46715	9.55712	10.44288	9.58039	10.41961	10
51	53327	46673	55752	44248	58077	41923	9
52	53368	46632	55791	44209	58115	41885	8
53	53409	46591	55831	44169	58153	41847	7
54	53450	46550	55870	44130	58191	41809	6
55	53492	46508	55910	44090	58229	41771	5
56	53533	46467	55949	44051	58267	41733	4
57	53574	46426	55989	44011	58304	41696	3
58	53615	46385	56028	43972	58342	41658	2
59	53656	46344	56067	43933	58380	41620	1
60	53697	46303	56107	43893	58418	41582	0
	Cotan	Tan	Cotan	Tan	Cotan	Tan	
	71°		70°		69°		

TABLE III.—LOG. TANGENTS AND COTANGENTS.

	21°		22°		23°		
	Tan	Cotan	Tan	Cotan	Tan	Cotan	
0	9.58418	10.41582	9.60641	10.39359	9.62785	10.37215	60
1	58455	41545	60677	39323	62820	37180	59
2	58498	41507	60714	39286	62855	37145	58
3	58531	41469	60750	39250	62890	37110	57
4	58569	41431	60786	39214	62928	37074	56
5	58606	41394	60823	39177	62961	37039	55
6	58644	41356	60859	39141	62996	37004	54
7	58681	41319	60895	39105	63031	36969	53
8	58719	41281	60931	39069	63066	36934	52
9	58757	41243	60967	39033	63101	36899	51
10	9.58794	10.41206	9.61004	10.38996	9.63135	10.36865	50
11	58832	41168	61040	38960	63170	36830	49
12	58869	41131	61076	38924	63205	36795	48
13	58907	41093	61112	38888	63240	36760	47
14	58944	41056	61148	38852	63275	36725	46
15	58981	41019	61184	38816	63310	36690	45
16	59019	40981	61220	38780	63345	36655	44
17	59056	40944	61256	38744	63379	36621	43
18	59094	40906	61292	38708	63414	36586	42
19	59131	40869	61328	38672	63449	36551	41
20	9.59168	10.40832	9.61304	10.38636	9.63484	10.36516	40
21	59205	40795	61400	38600	63519	36481	39
22	59243	40757	61436	38564	63553	36447	38
23	59280	40720	61472	38528	63588	36412	37
24	59317	40683	61508	38492	63623	36377	36
25	59354	40646	61544	38456	63657	36343	35
26	59391	40609	61579	38421	63692	36308	34
27	59429	40571	61615	38385	63726	36274	33
28	59466	40534	61651	38349	63761	36239	32
29	59503	40497	61687	38313	63796	36204	31
30	9.59640	10.40460	9.61722	10.38278	9.63830	10.36170	30
31	59577	40423	61758	38242	63865	36135	29
32	59614	40386	61794	38206	63899	36101	28
33	59651	40349	61830	38170	63934	36066	27
34	59688	40312	61865	38135	63968	36032	26
35	59725	40275	61901	38099	64003	35997	25
36	59762	40238	61936	38064	64037	35963	24
37	59799	40201	61972	38028	64072	35928	23
38	59835	40165	62008	37992	64106	35894	22
39	59872	40128	62043	37957	64140	35860	21
40	9.59909	10.40091	9.62079	10.37921	9.64175	10.35823	20
41	59946	40054	62114	37886	64209	35791	19
42	59983	40017	62150	37850	64243	35757	18
43	60019	39981	62185	37815	64278	35722	17
44	60056	39944	62221	37779	64312	35688	16
45	60093	39907	62256	37744	64346	35654	15
46	60130	39870	62292	37708	64381	35619	14
47	60166	39834	62327	37673	64415	35585	13
48	60203	39797	62362	37638	64449	35551	12
49	60240	39760	62398	37602	64483	35517	11
50	9.60276	10.39724	9.62438	10.37567	9.64517	10.35483	10
51	60312	39687	62483	37532	64552	35448	9
52	60349	39651	62504	37496	64586	35414	8
53	60386	39614	62539	37461	64620	35380	7
54	60422	39578	62574	37426	64654	35346	6
55	60459	39541	62609	37391	64688	35312	5
56	60495	39505	62645	37355	64722	35278	4
57	60532	39468	62680	37320	64756	35244	3
58	60568	39432	62715	37285	64790	35210	2
59	60605	39395	62750	37250	64824	35176	1
60	60641	39359	62785	37215	64858	35142	0
	Cotan	Tan	Cotan	Tan	Cotan	Tan	
	68°		67°		66°		

TABLE III.—LOG. TANGENTS AND COTANGENTS.

	24°		25°		26°		
	Tan	Cotan	Tan	Cotan	Tan	Cotan	
0	9.64858	10.35142	9.66867	10.33133	9.68818	10.31182	60
1	64892	35108	66900	33100	68850	31150	59
2	64926	35074	66933	33067	68882	31118	58
3	64960	35040	66966	33034	68914	31086	57
4	64994	35006	66999	33001	68946	31054	56
5	65028	34972	67032	32968	68978	31022	55
6	65062	34938	67065	32935	69010	30990	54
7	65096	34904	67098	32902	69042	30958	53
8	65130	34870	67131	32869	69074	30926	52
9	65164	34836	67163	32837	69106	30894	51
10	9.65197	10.34803	9.67196	10.32804	9.69188	10.30863	60
11	65231	34769	67229	32771	69170	30830	49
12	65265	34735	67262	32738	69202	30798	48
13	65299	34701	67295	32705	69234	30766	47
14	65333	34667	67327	32673	69266	30734	46
15	65366	34634	67360	32640	69298	30702	45
16	65400	34600	67393	32607	69329	30671	44
17	65434	34566	67426	32574	69361	30639	43
18	65467	34533	67458	32542	69393	30607	42
19	65501	34499	67491	32509	69425	30575	41
20	9.65535	10.34465	9.67524	10.32476	9.69457	10.30643	40
21	65568	34432	67556	32444	69488	30612	39
22	65602	34398	67589	32411	69520	30580	38
23	65636	34364	67622	32378	69552	30548	37
24	65669	34331	67654	32346	69584	30516	36
25	65703	34297	67687	32313	69615	30485	35
26	65736	34264	67719	32281	69647	30453	34
27	65770	34230	67752	32248	69679	30421	33
28	65803	34197	67785	32215	69710	30389	32
29	65837	34163	67817	32183	69742	30358	31
30	9.65870	10.34120	9.67850	10.32150	9.69774	10.30226	30
31	65904	34096	67882	32118	69805	30195	29
32	65937	34063	67915	32085	69837	30163	28
33	65971	34029	67947	32053	69868	30132	27
34	66004	33996	67980	32020	69900	30100	26
35	66038	33962	68012	31988	69932	30068	25
36	66071	33929	68044	31956	69963	30037	24
37	66104	33896	68077	31923	69995	30005	23
38	66138	33862	68109	31891	70026	29974	22
39	66171	33829	68142	31858	70058	29942	21
40	9.66204	10.33796	9.68174	10.31826	9.70089	10.29911	20
41	66238	33763	68206	31794	70121	29879	19
42	66271	33729	68239	31761	70152	29848	18
43	66304	33696	68271	31729	70184	29816	17
44	66337	33663	68303	31697	70215	29785	16
45	66371	33629	68336	31664	70247	29753	15
46	66404	33596	68368	31632	70278	29722	14
47	66437	33563	68400	31600	70309	29691	13
48	66470	33530	68432	31568	70341	29659	12
49	66503	33497	68465	31535	70372	29628	11
50	9.66537	10.33463	9.68497	10.31503	9.70404	10.29596	10
51	66570	33430	68529	31471	70435	29565	9
52	66603	33397	68561	31439	70466	29534	8
53	66636	33364	68593	31407	70498	29502	7
54	66669	33331	68626	31374	70529	29471	6
55	66702	33298	68658	31342	70560	29440	5
56	66735	33265	68690	31310	70592	29408	4
57	66768	33232	68722	31278	70623	29377	3
58	66801	33199	68754	31246	70654	29346	2
59	66834	33166	68786	31214	70685	29315	1
60	66867	33133	68818	31182	70717	29283	0
	Cotan	Tan	Cotan	Tan	Cotan	Tan	
	65°		64°		63°		

TABLE III.—LOG. TANGENTS AND COTANGENTS.

	27°		28°		29°		
	Tan	Cotan	Tan	Cotan	Tan	Cotan	
0	9.70717	10.89283	9.72567	10.27433	9.74375	10.25625	60
1	70748	39252	72598	27402	74405	25595	59
2	70779	29221	72628	27372	74435	25565	58
3	70810	19190	72659	27341	74465	25535	57
4	70841	9159	72689	27311	74494	25505	56
5	70872	29127	72720	27280	74524	25475	55
6	70904	19096	72750	27250	74554	25445	54
7	70935	8965	72780	27220	74585	25415	53
8	70966	29034	72811	27189	74615	25385	52
9	70997	19003	72841	27159	74645	25355	51
10	9.71028	10.28972	9.72872	10.27128	9.74673	10.25327	50
11	71059	28941	72902	27098	74702	25298	49
12	71090	18910	72932	27068	74732	25268	48
13	71121	8879	72963	27037	74762	25238	47
14	71152	28847	72993	27007	74791	25209	46
15	71183	18816	73023	26977	74821	25179	45
16	71214	8785	73054	26946	74851	25149	44
17	71245	28754	73084	26916	74880	25120	43
18	71277	18723	73114	26886	74910	25090	42
19	71308	8692	73144	26856	74939	25061	41
20	9.71339	10.28661	9.73175	10.26825	9.74969	10.25081	40
21	71370	28680	73205	26825	74998	25052	39
22	71401	18649	73235	26795	75028	25022	38
23	71432	8618	73265	26765	75058	24992	37
24	71463	28588	73295	26735	75087	24962	36
25	71494	18557	73325	26704	75117	24932	35
26	71524	8526	73355	26674	75146	24902	34
27	71555	28445	73385	26644	75176	24872	33
28	71586	18414	73415	26614	75205	24842	32
29	71617	8383	73445	26584	75235	24812	31
30	9.71648	10.28352	9.73476	10.26524	9.75264	10.24786	30
31	71679	28321	73507	26493	75294	24756	29
32	71709	18291	73537	26463	75322	24726	28
33	71740	8260	73567	26433	75352	24697	27
34	71771	28229	73597	26402	75382	24667	26
35	71802	18198	73627	26372	75411	24637	25
36	71833	8167	73657	26342	75441	24607	24
37	71863	28137	73687	26312	75470	24577	23
38	71894	18106	73717	26282	75500	24547	22
39	71925	8075	73747	26252	75529	24517	21
40	9.71955	10.28045	9.73777	10.26223	9.75558	10.24442	20
41	71986	28014	73807	26193	75588	24412	19
42	72017	17983	73837	26163	75617	24382	18
43	72048	8952	73867	26133	75647	24352	17
44	72078	28922	73897	26103	75676	24322	16
45	72109	18891	73927	26073	75706	24292	15
46	72140	8860	73957	26043	75735	24262	14
47	72170	28830	73987	26013	75764	24232	13
48	72201	18799	74017	25983	75793	24202	12
49	72231	8769	74047	25953	75822	24172	11
50	9.72262	10.27738	9.74077	10.25923	9.75852	10.24148	10
51	72292	27707	74107	25923	75881	24119	9
52	72323	17676	74137	25893	75910	24089	8
53	72354	8645	74166	25863	75939	24061	7
54	72384	27616	74196	25834	75969	24031	6
55	72415	17585	74225	25804	75998	24002	5
56	72445	8555	74255	25774	76027	23973	4
57	72476	27524	74285	25744	76056	23944	3
58	72506	17494	74315	25714	76086	23914	2
59	72537	8463	74345	25685	76115	23885	1
60	72567	27433	74375	25655	76144	23856	0
	Cotan	Tan	Cotan	Tan	Cotan	Tan	
	62°		61°		60°		

TABLE III.—LOG. TANGENTS AND COTANGENTS.

	30°		31°		32°		
	Tan	Cotan	Tan	Cotan	Tan	Cotan	
0	9.76144	10.22856	9.77877	10.22123	9.79579	10.20421	60
1	76173	22827	77906	22094	79507	20538	59
2	76202	22798	77935	22065	79536	20567	58
3	76231	22769	77964	22037	79565	20597	57
4	76261	22740	77993	22008	79594	20626	56
5	76290	22710	78022	21980	79623	20655	55
6	76319	22681	78051	21951	79652	20684	54
7	76348	22652	78077	21923	79681	20713	53
8	76377	22623	78106	21894	79710	20742	52
9	76406	22594	78135	21865	79739	20771	51
10	9.76435	10.22565	9.78168	10.21837	9.79860	10.20140	50
11	76404	22536	78192	21808	79889	20112	49
12	76433	22507	78220	21780	79918	20084	48
13	76462	22478	78249	21751	79947	20056	47
14	76491	22449	78277	21723	79976	20028	46
15	76520	22420	78306	21694	80005	20000	45
16	76549	22391	78334	21666	80034	19972	44
17	76578	22362	78363	21637	80063	19944	43
18	76607	22333	78391	21609	80092	19916	42
19	76636	22304	78419	21581	80121	19888	41
20	9.76725	10.22275	9.78448	10.21552	9.80140	10.19860	40
21	76754	22246	78478	21524	80169	19832	39
22	76783	22217	78506	21495	80198	19804	38
23	76812	22188	78535	21467	80227	19777	37
24	76841	22159	78562	21438	80256	19749	36
25	76870	22130	78590	21410	80285	19721	35
26	76899	22101	78618	21382	80314	19693	34
27	76928	22072	78647	21353	80343	19665	33
28	76957	22043	78675	21325	80372	19637	32
29	76986	22014	78704	21296	80401	19609	31
30	9.77015	10.22085	9.78732	10.21268	9.80419	10.19531	30
31	77044	22056	78760	21240	80447	19553	29
32	77073	22027	78789	21211	80476	19525	28
33	77101	22000	78817	21183	80505	19497	27
34	77130	22070	78845	21155	80534	19470	26
35	77159	22041	78874	21126	80563	19442	25
36	77188	22012	78902	21098	80592	19414	24
37	77217	22083	78930	21070	80621	19386	23
38	77246	22054	78959	21041	80650	19358	22
39	77274	22026	78987	21013	80679	19331	21
40	9.77303	10.22097	9.79015	10.20985	9.80697	10.19308	20
41	77332	22068	79043	20957	80725	19279	19
42	77361	22039	79072	20928	80754	19251	18
43	77390	22010	79100	20900	80783	19223	17
44	77419	22082	79128	20872	80812	19195	16
45	77447	22053	79156	20844	80841	19167	15
46	77476	22024	79185	20815	80870	19139	14
47	77505	22095	79213	20787	80899	19111	13
48	77533	22067	79241	20759	80928	19083	12
49	77562	22038	79269	20731	80957	19055	11
50	9.77591	10.22409	9.79297	10.20703	9.80975	10.19025	10
51	77619	22381	79295	20674	81003	18997	9
52	77648	22352	79324	20646	81032	18970	8
53	77677	22323	79352	20618	81061	18942	7
54	77706	22294	79380	20590	81090	18914	6
55	77734	22266	79408	20562	81119	18887	5
56	77763	22237	79436	20534	81148	18859	4
57	77791	22209	79465	20506	81177	18831	3
58	77820	22180	79493	20477	81206	18804	2
59	77849	22151	79521	20449	81235	18776	1
60	77877	22123	79549	20421	81264	18748	0
	Cotan	Tan	Cotan	Tan	Cotan	Tan	
	50°		51°		52°		

TABLE III.—LOG. TANGENTS AND COTANGENTS.

	33°		34°		35°		
	Tan	Cotan	Tan	Cotan	Tan	Cotan	
0	9.81252	10.18748	9.89899	10.17101	9.84523	10.15477	60
1	81279	18731	89906	17074	84550	15450	59
2	81307	18698	89958	17047	84576	15424	58
3	81335	18665	89990	17020	84603	15397	57
4	81363	18638	89906	16992	84630	15370	56
5	81390	18610	89935	16965	84657	15343	55
6	81418	18582	89962	16938	84684	15316	54
7	81445	18555	89989	16911	84711	15289	53
8	81473	18527	89917	16883	84738	15262	52
9	81500	18500	89944	16856	84764	15236	51
10	9.81528	10.18472	9.83171	10.16829	9.84791	10.15209	50
11	81556	18444	83198	16802	84818	15182	49
12	81583	18417	83225	16775	84845	15155	48
13	81611	18389	83252	16748	84872	15128	47
14	81638	18362	83279	16720	84899	15101	46
15	81666	18334	83307	16693	84925	15075	45
16	81693	18307	83334	16666	84952	15048	44
17	81721	18279	83361	16639	84979	15021	43
18	81748	18252	83388	16612	85006	14994	42
19	81776	18224	83415	16585	85033	14967	41
20	9.81802	10.18197	9.83142	10.16558	9.85059	10.14941	40
21	81831	18169	83440	16530	85086	14914	39
22	81858	18142	83467	16503	85113	14887	38
23	81886	18114	83494	16476	85140	14860	37
24	81913	18087	83521	16449	85166	14833	36
25	81941	18059	83548	16422	85193	14807	35
26	81968	18032	83575	16395	85220	14780	34
27	81996	18004	83602	16368	85247	14753	33
28	82023	17977	83629	16341	85273	14727	32
29	82051	17949	83656	16314	85300	14700	31
30	9.82077	10.17922	9.83713	10.16287	9.85327	10.14673	30
31	82106	17924	83740	16260	85354	14646	29
32	82133	17897	83768	16232	85380	14620	28
33	82161	17869	83795	16205	85407	14593	27
34	82188	17842	83822	16178	85434	14566	26
35	82215	17815	83849	16151	85460	14540	25
36	82243	17787	83876	16124	85487	14513	24
37	82270	17760	83903	16097	85514	14486	23
38	82298	17732	83930	16070	85540	14460	22
39	82325	17705	83957	16043	85567	14433	21
40	9.82352	10.17648	9.83964	10.16016	9.85594	10.14406	20
41	82380	17620	84011	15989	85620	14380	19
42	82407	17593	84038	15962	85647	14353	18
43	82435	17565	84065	15935	85674	14326	17
44	82462	17538	84092	15908	85700	14300	16
45	82489	17511	84119	15881	85727	14273	15
46	82517	17483	84146	15854	85754	14246	14
47	82544	17456	84173	15827	85780	14220	13
48	82571	17429	84200	15800	85807	14193	12
49	82599	17401	84227	15773	85834	14166	11
50	9.82626	10.17374	9.84254	10.15746	9.85860	10.14140	10
51	82653	17347	84280	15720	85887	14113	9
52	82681	17319	84307	15693	85913	14087	8
53	82708	17292	84334	15666	85940	14060	7
54	82735	17265	84361	15639	85967	14033	6
55	82762	17238	84388	15612	85993	14007	5
56	82790	17210	84415	15585	86020	13980	4
57	82817	17183	84442	15558	86046	13954	3
58	82844	17156	84469	15531	86073	13927	2
59	82871	17129	84496	15504	86100	13900	1
60	82899	17101	84523	15477	86126	13874	0
	Cotan	Tan	Cotan	Tan	Cotan	Tan	
	53°		54°		54°		

TABLE III.—LOG. TANGENTS AND COTANGENTS.

	36°		37°		38°		
	Tan	Cotan	Tan	Cotan	Tan	Cotan	
0	9.86186	10.13874	9.87711	10.12289	9.89281	10.10719	60
1	86183	13847	87738	12262	89307	10693	59
2	86179	13821	87764	12236	89333	10667	58
3	86206	13794	87790	12210	89359	10641	57
4	86232	13768	87817	12183	89385	10615	56
5	86259	13741	87843	12157	89411	10589	55
6	86285	13715	87869	12131	89437	10563	54
7	86311	13688	87895	12105	89463	10537	53
8	86338	13662	87921	12078	89489	10511	52
9	86365	13635	87948	12052	89515	10485	51
10	9.86392	10.13605	9.87974	10.12026	9.89541	10.10459	50
11	86418	13589	88000	12000	89567	10433	49
12	86445	13565	88027	11973	89593	10407	48
13	86471	13539	88053	11947	89619	10381	47
14	86498	13502	88079	11921	89645	10355	46
15	86524	13476	88105	11895	89671	10329	45
16	86551	13449	88131	11869	89697	10303	44
17	86577	13423	88158	11843	89723	10277	43
18	86603	13397	88184	11816	89749	10251	42
19	86630	13370	88210	11790	89775	10225	41
20	9.86656	10.13344	9.88236	10.11764	9.89801	10.10199	40
21	86683	13317	88262	11738	89827	10173	39
22	86709	13291	88289	11711	89853	10147	38
23	86736	13264	88315	11685	89879	10121	37
24	86762	13238	88341	11659	89905	10095	36
25	86789	13211	88367	11633	89931	10069	35
26	86815	13185	88393	11607	89957	10043	34
27	86842	13158	88420	11580	89983	10017	33
28	86868	13132	88446	11554	90009	9991	32
29	86894	13106	88472	11528	90035	9965	31
30	9.86921	10.13079	9.88498	10.11502	9.90061	10.09939	30
31	86947	13083	88524	11476	90086	99914	29
32	86974	13056	88550	11450	90112	99888	28
33	87000	13000	88577	11423	90138	99862	27
34	87027	12973	88603	11397	90164	99836	26
35	87053	12947	88629	11371	90190	99810	25
36	87079	12921	88655	11345	90216	99784	24
37	87106	12894	88681	11319	90242	99758	23
38	87132	12868	88707	11293	90268	99732	22
39	87158	12842	88733	11267	90294	99706	21
40	9.87185	10.12815	9.88759	10.11241	9.90320	10.09680	20
41	87211	12789	88786	11214	90346	99654	19
42	87238	12762	88812	11188	90371	99629	18
43	87264	12736	88838	11162	90397	99603	17
44	87290	12710	88864	11136	90423	99577	16
45	87317	12683	88890	11110	90449	99551	15
46	87343	12657	88916	11084	90475	99525	14
47	87369	12631	88942	11058	90501	99499	13
48	87396	12604	88968	11032	90527	99473	12
49	87422	12578	88994	11006	90553	99447	11
50	9.87448	10.12552	9.89020	10.10980	9.90578	10.09422	10
51	87475	12525	89045	10954	90604	99396	9
52	87501	12499	89073	10927	90630	99370	8
53	87527	12473	89099	10901	90656	99344	7
54	87554	12446	89125	10875	90682	99318	6
55	87580	12420	89151	10849	90708	99292	5
56	87606	12394	89177	10823	90734	99266	4
57	87633	12367	89203	10797	90759	99241	3
58	87659	12341	89229	10771	90785	99215	2
59	87685	12315	89255	10745	90811	99189	1
60	87711	12289	89281	10719	90837	99163	0
	Cotan	Tan	Cotan	Tan	Cotan	Tan	
	53°		52°		51°		

TABLE III.—LOG. TANGENTS AND COTANGENTS.

	39°		40°		41°		
	Tan	Cotan	Tan	Cotan	Tan	Cotan	
0	9.90887	10.09163	9.92381	10.07619	9.93916	10.06084	60
1	90868	09137	92407	07593	93942	06058	59
2	90889	09111	92438	07567	93967	06038	58
3	90914	09086	92458	07542	93988	06007	57
4	90940	09060	92484	07516	94018	05982	56
5	90966	09034	92510	07490	94044	05956	55
6	90992	09008	92535	07465	94069	05931	54
7	91018	08982	92561	07439	94095	05905	53
8	91043	08957	92587	07413	94120	05880	52
9	91069	08931	92612	07388	94146	05854	51
10	9.91095	10.08905	9.92638	10.07362	9.94171	10.05829	50
11	91121	08879	92663	07357	94197	05803	49
12	91147	08853	92689	07331	94222	05778	48
13	91172	08828	92715	07305	94248	05752	47
14	91198	08802	92740	07280	94273	05727	46
15	91224	08776	92766	07254	94299	05701	45
16	91250	08750	92792	07228	94324	05676	44
17	91276	08724	92817	07203	94350	05650	43
18	91301	08699	92843	07177	94375	05625	42
19	91327	08673	92868	07152	94401	05599	41
20	9.91353	10.08647	9.92894	10.07106	9.94426	10.05574	40
21	91379	08621	92920	07080	94452	05548	39
22	91404	08596	92945	07055	94477	05523	38
23	91430	08570	92971	07029	94503	05497	37
24	91456	08544	92996	07004	94528	05472	36
25	91482	08518	93022	06978	94554	05446	35
26	91507	08493	93048	06952	94579	05421	34
27	91533	08467	93073	06927	94604	05396	33
28	91559	08441	93099	06901	94630	05370	32
29	91585	08415	93124	06876	94655	05345	31
30	9.91610	10.08390	9.93150	10.06850	9.94681	10.05319	30
31	91636	08364	93175	06825	94706	05294	29
32	91662	08338	93201	06799	94732	05268	28
33	91688	08312	93227	06773	94757	05243	27
34	91713	08287	93252	06748	94783	05217	26
35	91739	08261	93278	06722	94808	05192	25
36	91765	08235	93303	06697	94834	05166	24
37	91791	08209	93329	06671	94859	05141	23
38	91816	08184	93354	06646	94884	05116	22
39	91842	08158	93380	06620	94910	05090	21
40	9.91868	10.08132	9.93406	10.06594	9.94935	10.05065	20
41	91893	08107	93431	06569	94961	05039	19
42	91919	08081	93457	06543	94986	05014	18
43	91945	08055	93482	06518	95012	04988	17
44	91971	08029	93508	06492	95037	04963	16
45	91996	08004	93533	06467	95062	04938	15
46	92022	07978	93559	06441	95088	04912	14
47	92048	07952	93584	06416	95113	04887	13
48	92073	07927	93610	06390	95139	04861	12
49	92099	07901	93636	06364	95164	04836	11
50	9.92125	10.07875	9.93661	10.06339	9.95190	10.04810	10
51	92150	07850	93687	06313	95215	04785	9
52	92176	07824	93712	06288	95240	04760	8
53	92202	07798	93738	06262	95266	04734	7
54	92227	07773	93763	06237	95291	04709	6
55	92253	07747	93789	06211	95317	04683	5
56	92279	07721	93814	06186	95342	04658	4
57	92304	07696	93840	06160	95368	04632	3
58	92330	07670	93865	06135	95393	04607	2
59	92356	07644	93891	06109	95418	04582	1
60	92381	07619	93916	06084	95444	04556	0
	Cotan	Tan	Cotan	Tan	Cotan	Tan	
	59°		49°		49°		

TABLE III.—LOG. TANGENTS AND COTANGENTS.

	42°		43°		44°		
	Tan	Cotan	Tan	Cotan	Tan	Cotan	
0	9.95444	10.04556	9.96966	10.03034	9.98484	10.01516	60
1	95469	04531	96991	03009	98509	01491	59
2	95495	04505	97016	02984	98534	01466	58
3	95520	04480	97042	02958	98560	01440	57
4	95545	04455	97067	02933	98585	01415	56
5	95571	04429	97092	02908	98610	01390	55
6	95596	04404	97118	02882	98635	01365	54
7	95622	04378	97143	02857	98661	01339	53
8	95647	04353	97168	02832	98686	01314	52
9	95673	04328	97193	02807	98711	01289	51
10	9.95698	10.04302	9.97219	10.02781	9.98737	10.01263	50
11	95728	04277	97244	02756	98762	01238	49
12	95748	04252	97269	02731	98787	01213	48
13	95774	04226	97295	02705	98812	01188	47
14	95799	04201	97320	02680	98838	01162	46
15	95825	04175	97345	02655	98863	01137	45
16	95850	04150	97371	02629	98888	01112	44
17	95875	04125	97396	02604	98913	01087	43
18	95901	04099	97421	02579	98939	01061	42
19	95926	04074	97447	02553	98964	01036	41
20	9.95952	10.04048	9.97472	10.02528	9.98989	10.01011	40
21	95977	04023	97497	02503	99015	00985	39
22	96002	03998	97522	02477	99040	00960	38
23	96028	03972	97548	02452	99065	00935	27
24	96053	03947	97573	02427	99090	00910	26
25	96078	03922	97598	02402	99116	00884	25
26	96104	03896	97624	02376	99141	00859	24
27	96129	03871	97649	02351	99166	00834	23
28	96155	03845	97674	02326	99191	00809	22
29	96180	03820	97700	02300	99217	00783	21
30	9.96205	10.03795	9.97725	10.02275	9.99242	10.00758	30
31	96231	03769	97750	02250	99267	00732	29
32	96256	03744	97776	02224	99292	00707	28
33	96281	03719	97801	02199	99318	00682	27
34	96307	03693	97826	02174	99343	00657	26
35	96332	03668	97851	02149	99368	00632	25
36	96357	03643	97877	02123	99394	00606	24
37	96383	03617	97902	02098	99419	00581	23
38	96408	03592	97927	02073	99444	00556	22
39	96433	03567	97953	02047	99469	00531	21
40	9.96459	10.03541	9.97978	10.02022	9.99495	10.00505	20
41	96484	03516	98003	01997	99520	00480	19
42	96510	03490	98029	01971	99545	00455	18
43	96535	03465	98054	01946	99570	00430	17
44	96560	03440	98079	01921	99596	00404	16
45	96586	03414	98104	01896	99621	00379	15
46	96611	03389	98130	01870	99646	00354	14
47	96636	03364	98155	01845	99672	00328	13
48	96662	03338	98180	01820	99697	00303	12
49	96687	03313	98206	01794	99722	00278	11
50	9.96712	10.03288	9.98231	10.01769	9.99747	10.00253	10
51	96738	03262	98256	01744	99773	00227	9
52	96763	03237	98281	01719	99798	00202	8
53	96788	03212	98307	01693	99823	00177	7
54	96814	03186	98332	01668	99848	00152	6
55	96839	03161	98357	01643	99874	00126	5
56	96864	03136	98383	01617	99899	00101	4
57	96890	03110	98408	01592	99924	00076	3
58	96915	03085	98433	01567	99949	00051	2
59	96940	03060	98458	01542	99975	00025	1
60	96966	03034	98484	01516	10.00000	00000	0
	Cotan Tan		Cotan Tan		Cotan Tan		
	42°		43°		44°		

TABLE IV.—NATURAL SINES AND COSINES.

°	0°		1°		2°		3°		4°		°
	Sine	Cosin	Sine	Cosin	Sine	Cosin	Sine	Cosin	Sine	Cosin	
0	.00000	One.	.01745	.99985	.03490	.99939	.05234	.99863	.06978	.99756	60
1	.00029	One.	.01774	.99984	.03519	.99938	.05263	.99861	.07006	.99754	59
2	.00058	One.	.01803	.99984	.03548	.99937	.05292	.99859	.07034	.99752	58
3	.00087	One.	.01832	.99983	.03577	.99936	.05321	.99858	.07063	.99750	57
4	.00116	One.	.01862	.99983	.03606	.99935	.05350	.99857	.07092	.99748	56
5	.00145	One.	.01891	.99982	.03635	.99934	.05379	.99855	.07121	.99746	55
6	.00175	One.	.01920	.99982	.03664	.99933	.05408	.99854	.07150	.99744	54
7	.00204	One.	.01949	.99981	.03693	.99932	.05437	.99852	.07179	.99742	53
8	.00233	One.	.01978	.99980	.03722	.99931	.05466	.99851	.07208	.99740	52
9	.00262	One.	.02007	.99980	.03751	.99930	.05495	.99849	.07237	.99738	51
10	.00291	One.	.02036	.99979	.03781	.99929	.05524	.99847	.07266	.99736	50
11	.00320	.99999	.02065	.99979	.03810	.99927	.05553	.99846	.07295	.99734	49
12	.00349	.99999	.02094	.99978	.03839	.99926	.05582	.99844	.07324	.99731	48
13	.00378	.99999	.02123	.99977	.03868	.99925	.05611	.99842	.07353	.99727	47
14	.00407	.99999	.02152	.99977	.03897	.99924	.05640	.99841	.07382	.99724	46
15	.00436	.99999	.02181	.99976	.03926	.99923	.05669	.99839	.07411	.99720	45
16	.00465	.99999	.02211	.99976	.03955	.99922	.05698	.99838	.07440	.99718	44
17	.00495	.99999	.02240	.99975	.03984	.99921	.05727	.99836	.07469	.99714	43
18	.00524	.99999	.02269	.99974	.04013	.99919	.05756	.99834	.07498	.99711	42
19	.00553	.99998	.02298	.99974	.04042	.99918	.05785	.99833	.07527	.99707	41
20	.00582	.99998	.02327	.99973	.04071	.99917	.05814	.99831	.07556	.99704	40
21	.00611	.99998	.02356	.99973	.04100	.99916	.05843	.99829	.07585	.99702	39
22	.00640	.99998	.02385	.99972	.04129	.99915	.05872	.99827	.07614	.99700	38
23	.00669	.99998	.02414	.99971	.04158	.99913	.05901	.99826	.07643	.99698	37
24	.00698	.99998	.02443	.99970	.04188	.99912	.05931	.99824	.07672	.99696	36
25	.00727	.99997	.02472	.99969	.04217	.99911	.05960	.99822	.07701	.99693	35
26	.00756	.99997	.02501	.99969	.04246	.99910	.05989	.99821	.07730	.99691	34
27	.00785	.99997	.02530	.99968	.04275	.99909	.06018	.99819	.07759	.99689	33
28	.00814	.99997	.02559	.99967	.04304	.99907	.06047	.99817	.07788	.99686	32
29	.00843	.99996	.02588	.99966	.04333	.99906	.06076	.99815	.07817	.99684	31
30	.00873	.99996	.02618	.99966	.04362	.99905	.06105	.99813	.07846	.99682	30
31	.00902	.99996	.02647	.99965	.04391	.99904	.06134	.99812	.07875	.99680	29
32	.00931	.99996	.02676	.99964	.04420	.99902	.06163	.99810	.07904	.99678	28
33	.00960	.99995	.02705	.99965	.04449	.99901	.06192	.99808	.07933	.99675	27
34	.00989	.99995	.02734	.99963	.04478	.99900	.06221	.99806	.07962	.99673	26
35	.01018	.99995	.02763	.99962	.04507	.99898	.06250	.99804	.07991	.99670	25
36	.01047	.99995	.02792	.99961	.04536	.99897	.06279	.99803	.08020	.99668	24
37	.01076	.99994	.02821	.99960	.04565	.99896	.06308	.99801	.08049	.99666	23
38	.01105	.99994	.02850	.99959	.04594	.99894	.06337	.99799	.08078	.99663	22
39	.01134	.99994	.02879	.99959	.04623	.99893	.06366	.99797	.08107	.99661	21
40	.01164	.99993	.02908	.99958	.04652	.99892	.06395	.99795	.08136	.99658	20
41	.01193	.99993	.02938	.99957	.04681	.99890	.06424	.99793	.08165	.99656	19
42	.01222	.99993	.02967	.99956	.04711	.99889	.06453	.99792	.08194	.99654	18
43	.01251	.99992	.02996	.99955	.04740	.99888	.06482	.99790	.08223	.99651	17
44	.01280	.99992	.03025	.99954	.04769	.99886	.06511	.99788	.08252	.99649	16
45	.01309	.99991	.03054	.99953	.04798	.99885	.06540	.99786	.08281	.99647	15
46	.01338	.99991	.03083	.99952	.04827	.99883	.06569	.99784	.08310	.99644	14
47	.01367	.99991	.03112	.99952	.04856	.99882	.06598	.99782	.08339	.99642	13
48	.01396	.99990	.03141	.99951	.04885	.99881	.06627	.99780	.08368	.99640	12
49	.01425	.99990	.03170	.99950	.04914	.99879	.06656	.99778	.08397	.99637	11
50	.01454	.99989	.03199	.99949	.04943	.99878	.06685	.99776	.08426	.99634	10
51	.01483	.99989	.03228	.99948	.04972	.99876	.06714	.99774	.08455	.99632	9
52	.01513	.99989	.03257	.99947	.05001	.99875	.06743	.99772	.08484	.99630	8
53	.01542	.99988	.03286	.99946	.05030	.99873	.06773	.99770	.08513	.99627	7
54	.01571	.99988	.03315	.99945	.05059	.99872	.06802	.99768	.08542	.99625	6
55	.01600	.99987	.03344	.99944	.05088	.99870	.06831	.99766	.08571	.99623	5
56	.01629	.99987	.03373	.99943	.05117	.99869	.06860	.99764	.08600	.99620	4
57	.01658	.99986	.03402	.99942	.05146	.99867	.06889	.99762	.08629	.99617	3
58	.01687	.99986	.03432	.99941	.05175	.99866	.06918	.99760	.08658	.99615	2
59	.01716	.99985	.03461	.99940	.05204	.99864	.06947	.99758	.08687	.99612	1
60	.01745	.99985	.03490	.99939	.05234	.99863	.06976	.99756	.08716	.99610	0
	Cosin	Sine	Cosin	Sine	Cosin	Sine	Cosin	Sine	Cosin	Sine	
	89°		88°		87°		86°		85°		

TABLE IV.—NATURAL SINES AND COSINES.

°	5°		6°		7°		8°		9°		°
	Sine	Cosin	Sine	Cosin	Sine	Cosin	Sine	Cosin	Sine	Cosin	
0	.08716	.99619	.10453	.99452	.12197	.99255	.13917	.99027	.15643	.98769	60
1	.08745	.99617	.10482	.99449	.12216	.99251	.13946	.99023	.15672	.98764	59
2	.08774	.99614	.10511	.99446	.12245	.99248	.13975	.99019	.15701	.98760	58
3	.08803	.99612	.10540	.99443	.12274	.99244	.14004	.99015	.15730	.98755	57
4	.08831	.99609	.10569	.99440	.12302	.99240	.14033	.99011	.15758	.98751	56
5	.08860	.99607	.10597	.99437	.12331	.99237	.14061	.99006	.15787	.98746	55
6	.08889	.99604	.10626	.99434	.12360	.99233	.14090	.99002	.15816	.98741	54
7	.08918	.99602	.10655	.99431	.12389	.99230	.14119	.98998	.15845	.98737	53
8	.08947	.99599	.10684	.99428	.12418	.99226	.14148	.98994	.15873	.98732	52
9	.08976	.99596	.10713	.99424	.12447	.99222	.14177	.98990	.15902	.98728	51
10	.09005	.99594	.10742	.99421	.12476	.99219	.14205	.98986	.15931	.98723	50
11	.09034	.99591	.10771	.99418	.12504	.99215	.14234	.98982	.15960	.98718	49
12	.09063	.99588	.10800	.99415	.12533	.99211	.14263	.98978	.15989	.98714	48
13	.09092	.99586	.10829	.99412	.12562	.99208	.14292	.98973	.16017	.98709	47
14	.09121	.99583	.10858	.99409	.12591	.99204	.14320	.98969	.16046	.98704	46
15	.09150	.99580	.10887	.99406	.12620	.99200	.14349	.98965	.16074	.98700	45
16	.09179	.99578	.10916	.99402	.12649	.99197	.14378	.98961	.16103	.98695	44
17	.09208	.99575	.10945	.99399	.12678	.99193	.14407	.98957	.16132	.98690	43
18	.09237	.99572	.10973	.99396	.12707	.99189	.14436	.98953	.16160	.98686	42
19	.09266	.99570	.11002	.99393	.12735	.99186	.14464	.98949	.16189	.98681	41
20	.09295	.99567	.11031	.99390	.12764	.99182	.14493	.98944	.16218	.98676	40
21	.09324	.99564	.11060	.99386	.12793	.99178	.14522	.98940	.16246	.98671	39
22	.09353	.99562	.11089	.99383	.12822	.99175	.14551	.98936	.16275	.98667	38
23	.09382	.99559	.11118	.99380	.12851	.99171	.14580	.98931	.16304	.98662	37
24	.09411	.99556	.11147	.99377	.12880	.99167	.14608	.98927	.16333	.98657	36
25	.09440	.99553	.11176	.99374	.12909	.99163	.14637	.98923	.16362	.98652	35
26	.09469	.99551	.11205	.99370	.12937	.99160	.14666	.98919	.16390	.98648	34
27	.09498	.99548	.11234	.99367	.12966	.99156	.14695	.98914	.16419	.98643	33
28	.09527	.99545	.11263	.99364	.12995	.99152	.14723	.98910	.16447	.98638	32
29	.09556	.99542	.11291	.99360	.13024	.99148	.14752	.98906	.16476	.98633	31
30	.09585	.99540	.11320	.99357	.13053	.99144	.14781	.98902	.16505	.98629	30
31	.09614	.99537	.11349	.99354	.13081	.99141	.14810	.98897	.16533	.98624	29
32	.09642	.99534	.11378	.99351	.13110	.99137	.14838	.98893	.16562	.98619	28
33	.09671	.99531	.11407	.99347	.13139	.99133	.14867	.98889	.16591	.98614	27
34	.09700	.99528	.11436	.99344	.13168	.99129	.14896	.98884	.16620	.98609	26
35	.09729	.99526	.11465	.99341	.13197	.99125	.14925	.98880	.16648	.98604	25
36	.09758	.99523	.11494	.99337	.13226	.99122	.14954	.98876	.16677	.98600	24
37	.09787	.99520	.11523	.99334	.13254	.99118	.14982	.98871	.16706	.98595	23
38	.09816	.99517	.11552	.99331	.13283	.99114	.15011	.98867	.16734	.98590	22
39	.09845	.99514	.11580	.99327	.13312	.99110	.15040	.98863	.16763	.98585	21
40	.09874	.99511	.11609	.99324	.13341	.99106	.15069	.98858	.16792	.98580	20
41	.09903	.99508	.11638	.99320	.13370	.99102	.15097	.98854	.16820	.98575	19
42	.09932	.99506	.11667	.99317	.13399	.99098	.15126	.98849	.16849	.98570	18
43	.09961	.99503	.11696	.99314	.13427	.99094	.15155	.98845	.16878	.98565	17
44	.09990	.99500	.11725	.99310	.13456	.99090	.15184	.98841	.16906	.98561	16
45	.10019	.99497	.11754	.99307	.13485	.99087	.15212	.98836	.16935	.98556	15
46	.10048	.99494	.11783	.99303	.13514	.99083	.15241	.98832	.16964	.98551	14
47	.10077	.99491	.11812	.99300	.13543	.99079	.15270	.98827	.16992	.98546	13
48	.10106	.99488	.11840	.99297	.13572	.99075	.15299	.98823	.17021	.98541	12
49	.10135	.99485	.11869	.99293	.13600	.99071	.15327	.98818	.17050	.98536	11
50	.10164	.99482	.11898	.99290	.13629	.99067	.15356	.98814	.17078	.98531	10
51	.10192	.99479	.11927	.99286	.13658	.99063	.15385	.98809	.17107	.98526	9
52	.10221	.99476	.11956	.99283	.13687	.99059	.15414	.98805	.17136	.98521	8
53	.10250	.99473	.11985	.99279	.13716	.99055	.15442	.98800	.17164	.98516	7
54	.10279	.99470	.12014	.99276	.13744	.99051	.15471	.98796	.17193	.98511	6
55	.10308	.99467	.12043	.99272	.13773	.99047	.15500	.98791	.17222	.98506	5
56	.10337	.99464	.12071	.99269	.13802	.99043	.15529	.98787	.17250	.98501	4
57	.10366	.99461	.12100	.99265	.13831	.99039	.15557	.98782	.17279	.98496	3
58	.10395	.99458	.12129	.99262	.13860	.99035	.15586	.98778	.17308	.98491	2
59	.10424	.99455	.12158	.99258	.13889	.99031	.15615	.98773	.17336	.98486	1
60	.10453	.99452	.12187	.99255	.13917	.99027	.15643	.98769	.17365	.98481	0
	Cosin	Sine	Cosin	Sine	Cosin	Sine	Cosin	Sine	Cosin	Sine	
	84°		83°		82°		81°		80°		

TABLE IV.—NATURAL SINES AND COSINES.

	10°		11°		12°		13°		14°	
	Sine	Cosin	Sine	Cosin	Sine	Cosin	Sine	Cosin	Sine	Cosin
0	17365	98481	19061	98165	20791	97815	22495	97437	24198	97030
1	17393	98476	19109	98157	20820	97809	22523	97430	24230	97023
2	17422	98471	19158	98152	20848	97803	22552	97424	24264	97015
3	17451	98466	19167	98146	20877	97797	22580	97417	24277	97008
4	17479	98461	19195	98140	20905	97791	22608	97411	24305	97001
5	17508	98455	19224	98135	20933	97784	22637	97404	24333	96994
6	17537	98450	19252	98129	20962	97778	22665	97398	24362	96987
7	17565	98445	19281	98124	20990	97772	22693	97391	24390	96980
8	17594	98440	19309	98118	21019	97766	22722	97384	24418	96973
9	17623	98435	19338	98112	21047	97760	22750	97378	24446	96966
10	17651	98430	19366	98107	21076	97754	22778	97371	24474	96959
11	17680	98425	19395	98101	21104	97748	22807	97365	24503	96952
12	17708	98420	19423	98096	21133	97742	22835	97358	24531	96945
13	17737	98414	19452	98090	21161	97735	22863	97351	24559	96937
14	17766	98409	19481	98084	21189	97729	22892	97345	24587	96930
15	17794	98404	19509	98079	21218	97722	22920	97338	24615	96923
16	17823	98399	19538	98073	21246	97717	22948	97331	24644	96916
17	17852	98394	19566	98067	21275	97711	22977	97325	24672	96909
18	17880	98389	19595	98061	21303	97705	23005	97318	24700	96902
19	17909	98383	19623	98056	21331	97699	23033	97311	24728	96894
20	17937	98378	19652	98050	21360	97692	23062	97304	24756	96887
21	17966	98373	19680	98044	21388	97686	23090	97298	24784	96880
22	17995	98368	19709	98039	21417	97680	23118	97291	24811	96873
23	18023	98362	19737	98033	21445	97673	23146	97284	24841	96866
24	18052	98357	19766	98027	21474	97667	23175	97278	24869	96858
25	18081	98352	19794	98021	21502	97661	23203	97271	24897	96851
26	18109	98347	19823	98016	21530	97655	23231	97264	24925	96844
27	18138	98341	19851	98010	21559	97648	23260	97257	24954	96837
28	18166	98336	19880	98004	21587	97642	23288	97251	24982	96829
29	18195	98331	19908	97998	21616	97636	23316	97244	25010	96822
30	18224	98325	19937	97992	21644	97630	23345	97237	25038	96815
31	18253	98320	19965	97987	21673	97623	23373	97230	25066	96807
32	18281	98315	19994	97981	21701	97617	23401	97223	25094	96800
33	18309	98310	20022	97975	21729	97611	23429	97217	25122	96792
34	18338	98304	20051	97969	21758	97604	23458	97210	25151	96786
35	18367	98299	20079	97963	21786	97598	23486	97203	25179	96778
36	18395	98294	20108	97958	21814	97592	23514	97196	25207	96771
37	18424	98288	20136	97952	21843	97585	23542	97189	25235	96764
38	18452	98283	20165	97946	21871	97579	23571	97182	25263	96756
39	18481	98277	20193	97940	21899	97573	23599	97176	25291	96749
40	18509	98272	20222	97934	21928	97566	23627	97169	25320	96742
41	18538	98267	20250	97928	21956	97560	23655	97162	25348	96734
42	18567	98261	20279	97922	21985	97553	23684	97155	25376	96727
43	18595	98256	20307	97916	22013	97547	23712	97148	25404	96719
44	18624	98250	20336	97910	22041	97541	23740	97141	25432	96712
45	18652	98245	20364	97905	22070	97534	23769	97134	25460	96705
46	18681	98240	20393	97899	22098	97528	23797	97127	25488	96697
47	18710	98234	20421	97893	22126	97521	23825	97120	25516	96690
48	18738	98229	20450	97887	22155	97515	23853	97113	25545	96682
49	18767	98223	20478	97881	22183	97508	23882	97106	25573	96675
50	18795	98218	20507	97875	22212	97502	23910	97100	25601	96667
51	18824	98212	20535	97869	22240	97496	23938	97093	25629	96660
52	18852	98207	20563	97863	22268	97489	23966	97086	25657	96652
53	18881	98201	20592	97857	22297	97483	23995	97079	25685	96645
54	18910	98196	20620	97851	22325	97476	24023	97072	25713	96638
55	18938	98190	20649	97845	22353	97470	24051	97065	25741	96630
56	18967	98185	20677	97839	22382	97463	24079	97058	25769	96623
57	18995	98179	20706	97833	22410	97457	24108	97051	25798	96615
58	19024	98174	20734	97827	22438	97450	24136	97044	25826	96608
59	19052	98168	20763	97821	22467	97444	24164	97037	25854	96601
60	19081	98163	20791	97815	22495	97437	24192	97030	25882	96593
	Cosin	Sine	Cosin	Sine	Cosin	Sine	Cosin	Sine	Cosin	Sine
	79°		78°		77°		76°		75°	

TABLE IV.—NATURAL SINES AND COSINES.

	15°		16°		17°		18°		19°		
	Sine	Cosin	Sine	Cosin	Sine	Cosin	Sine	Cosin	Sine	Cosin	
0	.25982	.96598	.27564	.96198	.29237	.95630	.30902	.95106	.32557	.94559	60
1	.25910	.96585	.27592	.96118	.29265	.95622	.30929	.95097	.32584	.94549	59
2	.25838	.96578	.27620	.96110	.29293	.95613	.30957	.95088	.32612	.94538	58
3	.25766	.96570	.27648	.96102	.29321	.95605	.30985	.95079	.32639	.94528	57
4	.25694	.96563	.27676	.96094	.29348	.95596	.31012	.95070	.32667	.94514	56
5	.25622	.96555	.27704	.96086	.29376	.95588	.31040	.95061	.32694	.94504	55
6	.25550	.96547	.27731	.96078	.29404	.95579	.31068	.95052	.32722	.94495	54
7	.25478	.96540	.27759	.96070	.29432	.95571	.31096	.95043	.32749	.94485	53
8	.25407	.96532	.27787	.96062	.29460	.95562	.31124	.95034	.32777	.94476	52
9	.25335	.96524	.27815	.96054	.29487	.95554	.31151	.95024	.32804	.94466	51
10	.25263	.96517	.27843	.96046	.29515	.95545	.31179	.95015	.32832	.94457	50
11	.25191	.96509	.27871	.96037	.29543	.95536	.31206	.95006	.32859	.94447	49
12	.25119	.96502	.27899	.96029	.29571	.95528	.31233	.94997	.32887	.94438	48
13	.25047	.96494	.27927	.96021	.29599	.95519	.31261	.94988	.32914	.94428	47
14	.24975	.96486	.27955	.96013	.29626	.95511	.31289	.94979	.32942	.94418	46
15	.24903	.96479	.27983	.96005	.29654	.95502	.31316	.94970	.32969	.94409	45
16	.24831	.96471	.28011	.95997	.29682	.95493	.31344	.94961	.32997	.94399	44
17	.24759	.96463	.28039	.95989	.29710	.95485	.31372	.94952	.33024	.94390	43
18	.24687	.96456	.28067	.95981	.29737	.95476	.31399	.94943	.33051	.94380	42
19	.24615	.96448	.28095	.95972	.29765	.95467	.31427	.94934	.33079	.94371	41
20	.24543	.96440	.28123	.95964	.29793	.95459	.31454	.94924	.33106	.94360	40
21	.24471	.96433	.28150	.95956	.29821	.95450	.31482	.94915	.33134	.94351	39
22	.24400	.96425	.28178	.95948	.29849	.95441	.31510	.94906	.33161	.94342	38
23	.24328	.96417	.28206	.95940	.29876	.95433	.31537	.94897	.33189	.94332	37
24	.24256	.96410	.28234	.95931	.29904	.95424	.31565	.94888	.33216	.94322	36
25	.24184	.96402	.28262	.95923	.29932	.95415	.31593	.94879	.33244	.94313	35
26	.24112	.96394	.28290	.95915	.29960	.95407	.31620	.94870	.33271	.94303	34
27	.24040	.96386	.28318	.95907	.29987	.95398	.31648	.94860	.33299	.94293	33
28	.23968	.96379	.28346	.95898	.30015	.95389	.31675	.94851	.33326	.94284	32
29	.23896	.96371	.28374	.95890	.30043	.95380	.31703	.94842	.33353	.94274	31
30	.23824	.96363	.28402	.95882	.30071	.95372	.31730	.94833	.33381	.94264	30
31	.23752	.96355	.28429	.95874	.30098	.95363	.31758	.94823	.33408	.94254	29
32	.23680	.96347	.28457	.95865	.30126	.95354	.31786	.94814	.33436	.94245	28
33	.23608	.96340	.28485	.95857	.30154	.95345	.31813	.94805	.33463	.94235	27
34	.23536	.96332	.28513	.95849	.30182	.95337	.31841	.94795	.33490	.94225	26
35	.23464	.96324	.28541	.95841	.30209	.95328	.31868	.94786	.33518	.94215	25
36	.23392	.96316	.28569	.95832	.30237	.95319	.31896	.94777	.33545	.94205	24
37	.23320	.96308	.28597	.95824	.30265	.95310	.31923	.94768	.33573	.94196	23
38	.23248	.96301	.28625	.95816	.30292	.95301	.31951	.94758	.33600	.94186	22
39	.23176	.96293	.28652	.95807	.30320	.95293	.31979	.94749	.33627	.94176	21
40	.23104	.96285	.28680	.95799	.30348	.95284	.32006	.94740	.33655	.94167	20
41	.23032	.96277	.28708	.95791	.30376	.95275	.32034	.94730	.33682	.94157	19
42	.22960	.96269	.28736	.95782	.30403	.95266	.32061	.94721	.33710	.94147	18
43	.22888	.96261	.28764	.95774	.30431	.95257	.32089	.94712	.33737	.94137	17
44	.22816	.96253	.28792	.95766	.30459	.95248	.32116	.94702	.33764	.94127	16
45	.22744	.96246	.28820	.95757	.30486	.95240	.32144	.94693	.33792	.94118	15
46	.22672	.96238	.28847	.95749	.30514	.95231	.32171	.94684	.33819	.94108	14
47	.22600	.96230	.28875	.95740	.30542	.95222	.32199	.94674	.33846	.94098	13
48	.22528	.96222	.28903	.95732	.30570	.95213	.32227	.94665	.33874	.94088	12
49	.22456	.96214	.28931	.95724	.30597	.95204	.32254	.94656	.33901	.94078	11
50	.22384	.96206	.28959	.95715	.30625	.95195	.32282	.94646	.33929	.94068	10
51	.22312	.96198	.28987	.95707	.30653	.95186	.32309	.94637	.33956	.94058	9
52	.22240	.96190	.29015	.95698	.30680	.95177	.32337	.94627	.33983	.94049	8
53	.22168	.96182	.29042	.95690	.30708	.95168	.32364	.94618	.34011	.94039	7
54	.22096	.96174	.29070	.95681	.30736	.95159	.32392	.94609	.34038	.94029	6
55	.22024	.96166	.29098	.95673	.30763	.95150	.32419	.94599	.34065	.94019	5
56	.21952	.96158	.29126	.95664	.30791	.95141	.32447	.94590	.34093	.94009	4
57	.21880	.96150	.29154	.95656	.30819	.95133	.32474	.94580	.34120	.93999	3
58	.21808	.96142	.29182	.95647	.30846	.95124	.32502	.94571	.34147	.93989	2
59	.21736	.96134	.29209	.95639	.30874	.95115	.32529	.94561	.34175	.93979	1
60	.21664	.96126	.29237	.95630	.30902	.95106	.32557	.94552	.34202	.93969	0
	Cosin	Sine	Cosin	Sine	Cosin	Sine	Cosin	Sine	Cosin	Sine	
	74°		73°		72°		71°		70°		

TABLE IV.—NATURAL SINES AND COSINES.

	20°		21°		22°		23°		24°	
	Sine	Cosin	Sine	Cosin	Sine	Cosin	Sine	Cosin	Sine	Cosin
0	34202	98969	35837	98358	37461	92718	39073	92050	40674	91355
1	34229	98969	35864	98348	37488	92707	39100	92039	40700	91343
2	34257	98949	35891	98337	37515	92697	39127	92028	40727	91331
3	34284	98930	35918	98327	37542	92686	39153	92018	40753	91319
4	34311	98922	35945	98316	37569	92675	39180	92005	40780	91307
5	34339	98919	35973	98306	37595	92664	39207	91994	40806	91295
6	34366	98909	36000	98295	37622	92653	39234	91982	40833	91283
7	34393	98899	36027	98285	37649	92642	39260	91971	40860	91272
8	34421	98889	36054	98274	37676	92631	39287	91959	40886	91260
9	34448	98879	36081	98264	37703	92620	39314	91948	40913	91248
10	34475	98869	36106	98253	37730	92609	39341	91936	40939	91236
11	34503	98859	36135	98243	37757	92598	39367	91925	40966	91224
12	34530	98849	36162	98232	37784	92587	39394	91914	40992	91212
13	34557	98839	36190	98222	37811	92576	39421	91902	41019	91200
14	34584	98829	36217	98211	37838	92565	39448	91891	41045	91188
15	34612	98819	36244	98201	37865	92554	39474	91879	41072	91176
16	34639	98809	36271	98190	37892	92543	39501	91868	41098	91164
17	34666	98799	36298	98180	37919	92532	39528	91856	41125	91152
18	34694	98789	36325	98169	37946	92521	39555	91845	41151	91140
19	34721	98779	36352	98159	37973	92510	39581	91833	41178	91128
20	34748	98769	36379	98148	37999	92499	39608	91822	41204	91116
21	34775	98759	36406	98137	38026	92488	39635	91810	41231	91104
22	34803	98748	36434	98127	38053	92477	39661	91799	41257	91092
23	34830	98738	36461	98116	38080	92466	39688	91787	41284	91080
24	34857	98728	36488	98106	38107	92455	39715	91775	41310	91068
25	34884	98718	36515	98095	38134	92444	39741	91764	41337	91056
26	34912	98708	36542	98084	38161	92432	39768	91752	41363	91044
27	34939	98698	36569	98074	38188	92421	39795	91741	41389	91032
28	34966	98688	36596	98063	38215	92410	39822	91729	41415	91020
29	34993	98677	36623	98052	38241	92399	39848	91718	41443	91008
30	35021	98667	36650	98042	38268	92388	39875	91706	41469	90996
31	35049	98657	36677	98031	38295	92377	39902	91694	41496	90984
32	35077	98647	36704	98020	38322	92366	39928	91683	41522	90972
33	35105	98637	36731	98010	38349	92355	39955	91671	41549	90960
34	35133	98626	36758	97999	38376	92344	39982	91660	41575	90948
35	35161	98616	36785	97988	38403	92332	40008	91648	41602	90936
36	35188	98606	36812	97978	38430	92321	40035	91636	41628	90924
37	35216	98596	36839	97967	38456	92310	40062	91625	41655	90911
38	35243	98585	36867	97956	38483	92299	40088	91613	41681	90899
39	35271	98575	36894	97945	38510	92287	40115	91601	41707	90887
40	35298	98565	36921	97935	38537	92276	40141	91590	41734	90875
41	35326	98555	36948	97924	38564	92265	40168	91578	41760	90863
42	35354	98544	36975	97913	38591	92254	40195	91566	41787	90851
43	35382	98534	37002	97902	38617	92243	40221	91555	41813	90839
44	35409	98524	37029	97892	38644	92231	40248	91543	41840	90826
45	35437	98514	37056	97881	38671	92220	40275	91531	41866	90814
46	35465	98503	37083	97870	38698	92209	40301	91519	41892	90802
47	35493	98493	37110	97859	38725	92198	40328	91508	41919	90790
48	35521	98483	37137	97849	38752	92186	40355	91496	41945	90778
49	35548	98472	37164	97838	38778	92175	40381	91484	41972	90766
50	35576	98462	37191	97827	38805	92164	40408	91472	41998	90753
51	35599	98452	37218	97816	38832	92153	40434	91461	42024	90741
52	35619	98441	37245	97805	38859	92141	40461	91449	42051	90729
53	35647	98431	37272	97794	38886	92130	40488	91437	42077	90717
54	35674	98420	37299	97784	38912	92119	40514	91425	42104	90704
55	35701	98410	37326	97773	38939	92107	40541	91414	42130	90692
56	35728	98400	37353	97762	38966	92096	40567	91402	42156	90680
57	35755	98389	37380	97751	38993	92085	40594	91390	42183	90668
58	35782	98379	37407	97740	39020	92073	40621	91378	42209	90655
59	35810	98368	37434	97729	39046	92062	40647	91366	42235	90643
60	35837	98358	37461	97718	39073	92050	40674	91355	42262	90631
	Cosin	Sine	Cosin	Sine	Cosin	Sine	Cosin	Sine	Cosin	Sine
	69°		68°		67°		66°		65°	

TABLE IV.—NATURAL SINES AND COSINES.

	30°		31°		32°		33°		34°		
	Sine	Cosin	Sine	Cosin	Sine	Cosin	Sine	Cosin	Sine	Cosin	
0	50000	86608	51504	85717	52992	84805	54484	83867	55919	83204	60
1	50025	86588	51529	85702	53017	84789	54488	83861	55943	83287	59
2	50050	86578	51554	85687	53041	84774	54513	83835	55968	83271	58
3	50076	86559	51579	85672	53066	84759	54537	83819	55992	83255	57
4	50101	86544	51604	85657	53091	84743	54561	83804	56016	83239	56
5	50126	86530	51628	85642	53115	84728	54586	83788	56040	83222	55
6	50151	86515	51653	85627	53140	84712	54610	83772	56064	83206	54
7	50176	86501	51678	85612	53164	84697	54635	83756	56088	83190	53
8	50201	86486	51703	85597	53189	84681	54659	83740	56112	83173	52
9	50227	86471	51728	85582	53214	84666	54683	83724	56136	83157	51
10	50252	86457	51753	85567	53238	84650	54708	83708	56160	83141	50
11	50277	86442	51778	85551	53263	84635	54732	83692	56184	83124	49
12	50302	86427	51803	85536	53288	84619	54756	83676	56208	83108	48
13	50327	86413	51828	85521	53312	84604	54781	83660	56232	83092	47
14	50352	86398	51852	85506	53337	84588	54805	83645	56256	83075	46
15	50377	86384	51877	85491	53361	84573	54829	83629	56280	83059	45
16	50403	86369	51902	85476	53386	84557	54854	83613	56304	83043	44
17	50428	86354	51927	85461	53411	84542	54878	83597	56328	83026	43
18	50453	86340	51952	85446	53435	84526	54902	83581	56352	83010	42
19	50478	86325	51977	85431	53460	84511	54927	83565	56377	82993	41
20	50503	86310	52002	85416	53484	84495	54951	83549	56401	82977	40
21	50528	86295	52026	85401	53509	84480	54975	83533	56425	82961	39
22	50553	86281	52051	85385	53534	84464	54999	83517	56449	82945	38
23	50578	86266	52076	85370	53558	84448	55024	83501	56473	82929	37
24	50603	86251	52101	85355	53583	84433	55048	83485	56497	82913	36
25	50628	86237	52126	85340	53607	84417	55072	83469	56521	82897	35
26	50654	86222	52151	85325	53632	84402	55097	83453	56545	82881	34
27	50679	86207	52175	85310	53656	84386	55121	83437	56569	82865	33
28	50704	86192	52200	85294	53681	84370	55145	83421	56593	82849	32
29	50729	86178	52225	85279	53705	84355	55169	83405	56617	82833	31
30	50754	86163	52250	85264	53730	84339	55194	83389	56641	82817	30
31	50779	86148	52275	85249	53754	84324	55218	83373	56665	82801	29
32	50804	86133	52299	85234	53779	84308	55242	83356	56689	82785	28
33	50829	86119	52324	85218	53804	84292	55266	83340	56713	82769	27
34	50854	86104	52349	85203	53828	84277	55291	83324	56737	82753	26
35	50879	86089	52374	85188	53853	84261	55315	83308	56761	82737	25
36	50904	86074	52399	85173	53877	84245	55339	83292	56785	82721	24
37	50929	86059	52423	85157	53902	84230	55363	83276	56809	82705	23
38	50954	86045	52448	85142	53926	84214	55388	83260	56833	82689	22
39	50979	86030	52473	85127	53951	84198	55412	83244	56857	82673	21
40	51004	86015	52498	85112	53975	84182	55436	83228	56881	82657	20
41	51029	86000	52522	85096	54000	84167	55460	83212	56905	82641	19
42	51054	85985	52547	85081	54024	84151	55484	83195	56929	82625	18
43	51079	85970	52572	85066	54049	84135	55508	83179	56953	82609	17
44	51104	85955	52597	85051	54073	84120	55532	83163	56977	82593	16
45	51129	85941	52621	85035	54097	84104	55557	83147	57001	82577	15
46	51154	85926	52646	85020	54122	84088	55581	83131	57025	82561	14
47	51179	85911	52671	85005	54146	84072	55605	83115	57049	82545	13
48	51204	85896	52696	84989	54171	84057	55630	83099	57073	82529	12
49	51229	85881	52720	84974	54195	84041	55654	83083	57097	82513	11
50	51254	85866	52745	84959	54220	84025	55678	83066	57121	82497	10
51	51279	85851	52770	84943	54244	84009	55702	83050	57145	82481	9
52	51304	85836	52794	84928	54269	83994	55726	83034	57169	82465	8
53	51329	85821	52819	84913	54293	83978	55750	83017	57193	82449	7
54	51354	85806	52844	84897	54317	83962	55774	83001	57217	82433	6
55	51379	85792	52869	84882	54342	83946	55798	82985	57241	82417	5
56	51404	85777	52893	84866	54366	83930	55822	82969	57265	82401	4
57	51429	85762	52918	84851	54391	83915	55847	82953	57289	82385	3
58	51454	85747	52943	84836	54415	83899	55871	82936	57313	82369	2
59	51479	85732	52967	84820	54440	83883	55895	82920	57337	82353	1
60	51504	85717	52992	84805	54464	83867	55919	82904	57361	82337	0
	Cosin	Sine	Cosin	Sine	Cosin	Sine	Cosin	Sine	Cosin	Sine	
	59°		58°		57°		56°		55°		

TABLE IV.—NATURAL SINES AND COSINES.

°	35°		36°		37°		38°		39°		°
	Sine	Cosin	Sine	Cosin	Sine	Cosin	Sine	Cosin	Sine	Cosin	
0	.57358	.81915	.58779	.80902	.60182	.79864	.61566	.78801	.62962	.77715	60
1	.57381	.81899	.58802	.80885	.60205	.79846	.61589	.78783	.62985	.77696	59
2	.57405	.81882	.58826	.80867	.60228	.79829	.61612	.78765	.63007	.77678	58
3	.57429	.81865	.58849	.80850	.60251	.79811	.61635	.78747	.63030	.77660	57
4	.57453	.81848	.58873	.80833	.60274	.79793	.61658	.78729	.63052	.77641	56
5	.57477	.81832	.58896	.80816	.60297	.79776	.61681	.78711	.63075	.77623	55
6	.57501	.81815	.58920	.80799	.60321	.79758	.61704	.78694	.63098	.77605	54
7	.57524	.81798	.58943	.80782	.60344	.79741	.61728	.78676	.63120	.77586	53
8	.57548	.81782	.58967	.80765	.60367	.79723	.61749	.78658	.63143	.77568	52
9	.57572	.81765	.58990	.80748	.60390	.79706	.61772	.78640	.63165	.77550	51
10	.57596	.81748	.59014	.80730	.60414	.79688	.61795	.78622	.63188	.77531	50
11	.57619	.81731	.59037	.80713	.60437	.79671	.61818	.78604	.63210	.77513	49
12	.57643	.81714	.59061	.80696	.60460	.79653	.61841	.78586	.63232	.77494	48
13	.57667	.81698	.59084	.80679	.60483	.79635	.61864	.78568	.63255	.77476	47
14	.57691	.81681	.59108	.80662	.60506	.79618	.61887	.78550	.63277	.77458	46
15	.57715	.81664	.59131	.80644	.60529	.79600	.61909	.78532	.63301	.77439	45
16	.57738	.81647	.59154	.80627	.60553	.79583	.61932	.78514	.63323	.77421	44
17	.57762	.81631	.59178	.80610	.60576	.79565	.61955	.78496	.63346	.77403	43
18	.57786	.81614	.59201	.80593	.60599	.79547	.61978	.78478	.63368	.77384	42
19	.57810	.81597	.59225	.80576	.60622	.79530	.62001	.78460	.63391	.77366	41
20	.57833	.81580	.59248	.80558	.60645	.79512	.62024	.78442	.63413	.77347	40
21	.57857	.81563	.59272	.80541	.60668	.79494	.62046	.78424	.63435	.77329	39
22	.57881	.81546	.59295	.80524	.60691	.79477	.62069	.78406	.63457	.77310	38
23	.57904	.81530	.59318	.80507	.60714	.79459	.62092	.78387	.63479	.77292	37
24	.57928	.81513	.59342	.80489	.60738	.79441	.62115	.78369	.63501	.77273	36
25	.57952	.81496	.59365	.80472	.60761	.79424	.62138	.78351	.63523	.77255	35
26	.57976	.81479	.59389	.80455	.60784	.79406	.62160	.78333	.63545	.77236	34
27	.57999	.81462	.59412	.80438	.60807	.79388	.62183	.78315	.63567	.77218	33
28	.58023	.81445	.59435	.80420	.60830	.79371	.62206	.78297	.63589	.77199	32
29	.58047	.81428	.59459	.80403	.60853	.79353	.62229	.78279	.63611	.77181	31
30	.58070	.81412	.59482	.80386	.60876	.79335	.62251	.78261	.63633	.77162	30
31	.58094	.81395	.59506	.80368	.60899	.79318	.62274	.78243	.63655	.77144	29
32	.58118	.81378	.59529	.80351	.60922	.79300	.62297	.78225	.63677	.77125	28
33	.58141	.81361	.59552	.80334	.60945	.79283	.62320	.78206	.63699	.77107	27
34	.58165	.81344	.59575	.80316	.60968	.79265	.62342	.78188	.63721	.77088	26
35	.58189	.81327	.59599	.80299	.60991	.79247	.62365	.78170	.63743	.77070	25
36	.58212	.81310	.59622	.80282	.61015	.79229	.62388	.78152	.63765	.77051	24
37	.58236	.81293	.59646	.80264	.61038	.79211	.62411	.78134	.63787	.77033	23
38	.58260	.81276	.59669	.80247	.61061	.79193	.62433	.78116	.63809	.77014	22
39	.58283	.81259	.59693	.80230	.61084	.79175	.62456	.78098	.63831	.76996	21
40	.58307	.81242	.59716	.80212	.61107	.79158	.62479	.78079	.63853	.76977	20
41	.58330	.81225	.59739	.80195	.61130	.79140	.62502	.78061	.63875	.76959	19
42	.58354	.81208	.59763	.80178	.61153	.79122	.62524	.78043	.63897	.76940	18
43	.58378	.81191	.59786	.80160	.61176	.79105	.62547	.78025	.63919	.76921	17
44	.58401	.81174	.59809	.80143	.61199	.79087	.62570	.78007	.63941	.76902	16
45	.58425	.81157	.59832	.80125	.61222	.79069	.62592	.77988	.63963	.76884	15
46	.58448	.81140	.59855	.80108	.61245	.79051	.62615	.77970	.63985	.76865	14
47	.58472	.81123	.59879	.80091	.61268	.79033	.62638	.77952	.64007	.76847	13
48	.58496	.81106	.59902	.80073	.61291	.79015	.62660	.77934	.64029	.76828	12
49	.58519	.81089	.59926	.80056	.61314	.78998	.62683	.77916	.64051	.76810	11
50	.58543	.81072	.59949	.80038	.61337	.78980	.62706	.77897	.64073	.76791	10
51	.58567	.81055	.59973	.80021	.61360	.78963	.62728	.77879	.64095	.76773	9
52	.58590	.81038	.59996	.80003	.61383	.78944	.62751	.77861	.64117	.76754	8
53	.58614	.81021	.60019	.79986	.61406	.78926	.62774	.77843	.64139	.76735	7
54	.58637	.81004	.60042	.79968	.61429	.78908	.62797	.77824	.64161	.76717	6
55	.58661	.80987	.60065	.79951	.61451	.78891	.62819	.77806	.64183	.76698	5
56	.58684	.80970	.60089	.79934	.61474	.78873	.62842	.77788	.64205	.76679	4
57	.58708	.80953	.60112	.79916	.61497	.78855	.62864	.77769	.64227	.76661	3
58	.58731	.80936	.60135	.79899	.61520	.78837	.62887	.77751	.64249	.76643	2
59	.58755	.80919	.60158	.79881	.61543	.78819	.62909	.77733	.64271	.76625	1
60	.58779	.80902	.60182	.79864	.61566	.78801	.62932	.77715	.64293	.76607	0

54°

53°

52°

51°

50°

TABLE IV.—NATURAL SINES AND COSINES.

	40°		41°		42°		43°		44°		
	Sine	Cosin	Sine	Cosin	Sine	Cosin	Sine	Cosin	Sine	Cosin	
0	.64279	.76604	.65606	.75471	.66918	.74314	.68200	.73135	.69466	.71934	60
1	.64301	.76580	.65582	.75452	.66895	.74295	.68221	.73116	.69487	.71914	59
2	.64323	.76557	.65558	.75433	.66872	.74276	.68242	.73096	.69508	.71894	58
3	.64346	.76534	.65534	.75414	.66849	.74256	.68264	.73076	.69529	.71873	57
4	.64368	.76510	.65510	.75395	.66826	.74237	.68285	.73056	.69549	.71853	56
5	.64390	.76487	.65487	.75375	.66802	.74217	.68306	.73036	.69570	.71833	55
6	.64412	.76462	.65462	.75356	.66779	.74198	.68327	.73016	.69591	.71813	54
7	.64435	.76437	.65437	.75337	.66756	.74178	.68349	.72996	.69612	.71792	53
8	.64457	.76413	.65413	.75318	.66732	.74159	.68370	.72976	.69633	.71772	52
9	.64479	.76388	.65388	.75299	.66709	.74139	.68391	.72957	.69654	.71752	51
10	.64501	.76364	.65364	.75280	.66686	.74120	.68412	.72937	.69675	.71732	50
11	.64524	.76339	.65339	.75261	.66662	.74100	.68434	.72917	.69696	.71711	49
12	.64546	.76314	.65314	.75241	.66639	.74080	.68455	.72897	.69717	.71691	48
13	.64568	.76289	.65289	.75222	.66615	.74061	.68476	.72877	.69737	.71671	47
14	.64590	.76264	.65264	.75203	.66592	.74041	.68497	.72857	.69758	.71650	46
15	.64612	.76239	.65239	.75184	.66568	.74022	.68518	.72837	.69779	.71630	45
16	.64635	.76214	.65214	.75165	.66545	.74002	.68539	.72817	.69800	.71610	44
17	.64657	.76189	.65189	.75146	.66521	.73983	.68561	.72797	.69821	.71590	43
18	.64679	.76164	.65164	.75126	.66498	.73963	.68582	.72777	.69842	.71569	42
19	.64701	.76139	.65139	.75107	.66474	.73944	.68603	.72757	.69862	.71549	41
20	.64723	.76114	.65114	.75088	.66451	.73924	.68624	.72737	.69883	.71529	40
21	.64746	.76089	.65089	.75069	.66427	.73904	.68645	.72717	.69904	.71508	39
22	.64768	.76064	.65064	.75050	.66403	.73885	.68666	.72697	.69925	.71488	38
23	.64790	.76039	.65039	.75030	.66380	.73865	.68688	.72677	.69946	.71468	37
24	.64812	.76014	.65014	.75011	.66356	.73846	.68709	.72657	.69966	.71447	36
25	.64834	.75989	.64989	.74992	.66332	.73826	.68730	.72637	.69987	.71427	35
26	.64856	.75964	.64964	.74973	.66308	.73806	.68751	.72617	.70008	.71407	34
27	.64879	.75939	.64939	.74953	.66284	.73787	.68772	.72597	.70029	.71386	33
28	.64901	.75914	.64914	.74934	.66260	.73767	.68793	.72577	.70049	.71366	32
29	.64923	.75889	.64889	.74915	.66236	.73747	.68814	.72557	.70070	.71345	31
30	.64945	.75864	.64864	.74896	.66212	.73728	.68835	.72537	.70091	.71325	30
31	.64967	.75839	.64839	.74876	.66188	.73708	.68857	.72517	.70112	.71305	29
32	.64989	.75814	.64814	.74857	.66164	.73688	.68878	.72497	.70132	.71284	28
33	.65011	.75789	.64789	.74838	.66140	.73669	.68899	.72477	.70153	.71264	27
34	.65033	.75764	.64764	.74818	.66116	.73649	.68920	.72457	.70174	.71243	26
35	.65055	.75739	.64739	.74799	.66092	.73629	.68941	.72437	.70195	.71223	25
36	.65077	.75714	.64714	.74779	.66068	.73610	.68962	.72417	.70215	.71203	24
37	.65100	.75689	.64689	.74760	.66044	.73590	.68983	.72397	.70236	.71182	23
38	.65122	.75664	.64664	.74741	.66020	.73570	.69004	.72377	.70257	.71162	22
39	.65144	.75639	.64639	.74722	.65996	.73551	.69025	.72357	.70277	.71141	21
40	.65166	.75614	.64614	.74703	.65972	.73531	.69046	.72337	.70298	.71121	20
41	.65188	.75589	.64589	.74683	.65948	.73511	.69067	.72317	.70319	.71100	19
42	.65210	.75564	.64564	.74664	.65924	.73491	.69088	.72297	.70340	.71080	18
43	.65232	.75539	.64539	.74644	.65900	.73472	.69109	.72277	.70360	.71059	17
44	.65254	.75514	.64514	.74625	.65876	.73452	.69130	.72257	.70381	.71039	16
45	.65276	.75489	.64489	.74605	.65852	.73432	.69151	.72236	.70401	.71019	15
46	.65298	.75464	.64464	.74586	.65828	.73413	.69172	.72216	.70422	.70998	14
47	.65320	.75439	.64439	.74567	.65804	.73393	.69193	.72196	.70443	.70978	13
48	.65342	.75414	.64414	.74548	.65780	.73373	.69214	.72176	.70464	.70957	12
49	.65364	.75389	.64389	.74528	.65756	.73353	.69235	.72156	.70484	.70937	11
50	.65386	.75364	.64364	.74509	.65732	.73333	.69256	.72136	.70505	.70916	10
51	.65408	.75339	.64339	.74489	.65708	.73314	.69277	.72116	.70525	.70896	9
52	.65430	.75314	.64314	.74470	.65684	.73294	.69298	.72095	.70546	.70875	8
53	.65452	.75289	.64289	.74451	.65660	.73274	.69319	.72075	.70567	.70855	7
54	.65474	.75264	.64264	.74431	.65636	.73254	.69340	.72055	.70587	.70834	6
55	.65496	.75239	.64239	.74412	.65612	.73234	.69361	.72035	.70608	.70813	5
56	.65518	.75214	.64214	.74392	.65588	.73214	.69382	.72015	.70628	.70793	4
57	.65540	.75189	.64189	.74373	.65564	.73194	.69403	.71995	.70649	.70772	3
58	.65562	.75164	.64164	.74353	.65540	.73174	.69424	.71974	.70670	.70752	2
59	.65584	.75139	.64139	.74334	.65516	.73154	.69445	.71954	.70690	.70731	1
60	.65606	.75114	.64114	.74314	.65492	.73134	.69466	.71934	.70711	.70711	0
	Cosin	Sine	Cosin	Sine	Cosin	Sine	Cosin	Sine	Cosin	Sine	
	49°	48°	47°	46°	45°						

TABLE V.—NATURAL TANGENTS AND COTANGENTS.

°	0°		1°		2°		3°		°
	Tang	Cotang	Tang	Cotang	Tang	Cotang	Tang	Cotang	
0	.0000	Infinita.	.01746	57.2900	.03492	28.6363	.05241	19.0611	60
1	.00029	3487.75	.01775	56.3506	.03521	28.3994	.05270	18.9755	59
2	.00058	1718.87	.01804	55.4415	.03550	28.1684	.05299	18.8711	58
3	.00087	1145.92	.01833	54.5613	.03579	27.9372	.05328	18.7678	57
4	.00116	859.486	.01862	53.7086	.03609	27.7117	.05357	18.6656	56
5	.00145	687.549	.01891	52.8821	.03638	27.4899	.05387	18.5645	55
6	.00175	572.957	.01920	52.0807	.03667	27.2715	.05416	18.4645	54
7	.00204	491.106	.01949	51.3032	.03696	27.0566	.05445	18.3655	53
8	.00233	429.718	.01978	50.5485	.03725	26.8450	.05474	18.2677	52
9	.00262	381.971	.02007	49.8157	.03754	26.6367	.05503	18.1706	51
10	.00291	343.774	.02036	49.1039	.03783	26.4316	.05532	18.0750	50
11	.00320	312.521	.02066	48.4121	.03812	26.2296	.05562	17.9802	49
12	.00349	286.473	.02095	47.7395	.03842	26.0307	.05591	17.8863	48
13	.00378	264.441	.02124	47.0853	.03871	25.8348	.05620	17.7934	47
14	.00407	245.552	.02153	46.4489	.03900	25.6418	.05649	17.7015	46
15	.00436	229.182	.02182	45.8294	.03929	25.4517	.05678	17.6106	45
16	.00465	214.858	.02211	45.2261	.03958	25.2644	.05707	17.5205	44
17	.00494	202.219	.02240	44.6386	.03987	25.0798	.05737	17.4314	43
18	.00523	190.984	.02269	44.0661	.04016	24.8978	.05766	17.3432	42
19	.00553	180.932	.02298	43.5081	.04046	24.7185	.05795	17.2558	41
20	.00582	171.885	.02328	42.9641	.04075	24.5418	.05824	17.1698	40
21	.00611	163.700	.02357	42.4335	.04104	24.3673	.05853	17.0857	39
22	.00640	156.229	.02386	41.9158	.04133	24.1957	.05883	16.9990	38
23	.00669	149.483	.02415	41.4106	.04163	24.0268	.05912	16.9150	37
24	.00698	143.287	.02444	40.9174	.04191	23.8598	.05941	16.8319	36
25	.00727	137.507	.02473	40.4358	.04220	23.6945	.05970	16.7496	35
26	.00756	132.219	.02502	39.9655	.04250	23.5321	.05999	16.6681	34
27	.00785	127.321	.02531	39.5069	.04279	23.3718	.06029	16.5873	33
28	.00815	122.774	.02560	39.0598	.04308	23.2137	.06058	16.5075	32
29	.00844	118.540	.02589	38.6177	.04337	23.0577	.06087	16.4283	31
30	.00873	114.589	.02619	38.1883	.04366	22.9038	.06116	16.3499	30
31	.00902	110.892	.02648	37.7686	.04395	22.7519	.06145	16.2722	29
32	.00931	107.426	.02677	37.3579	.04424	22.6020	.06175	16.1953	28
33	.00960	104.171	.02706	36.9560	.04453	22.4541	.06204	16.1190	27
34	.00989	101.107	.02735	36.5627	.04483	22.3081	.06233	16.0435	26
35	.01018	98.2179	.02764	36.1776	.04512	22.1640	.06262	15.9687	25
36	.01047	95.4895	.02793	35.8006	.04541	22.0217	.06291	15.8945	24
37	.01076	92.9085	.02822	35.4313	.04570	21.8813	.06321	15.8211	23
38	.01105	90.4683	.02851	35.0695	.04599	21.7426	.06350	15.7483	22
39	.01134	88.1496	.02881	34.7151	.04628	21.6056	.06379	15.6762	21
40	.01164	85.9393	.02910	34.3678	.04658	21.4704	.06408	15.6048	20
41	.01193	83.8435	.02939	34.0273	.04687	21.3369	.06437	15.5340	19
42	.01222	81.8470	.02968	33.6935	.04716	21.2049	.06467	15.4638	18
43	.01251	79.9434	.02997	33.3662	.04745	21.0747	.06496	15.3943	17
44	.01280	78.1263	.03026	33.0452	.04774	20.9460	.06525	15.3254	16
45	.01309	76.3900	.03055	32.7303	.04803	20.8188	.06554	15.2571	15
46	.01338	74.7292	.03084	32.4213	.04832	20.6933	.06584	15.1893	14
47	.01367	73.1390	.03114	32.1181	.04862	20.5691	.06613	15.1222	13
48	.01396	71.6151	.03143	31.8205	.04891	20.4465	.06642	15.0557	12
49	.01425	70.1533	.03172	31.5284	.04920	20.3253	.06671	14.9898	11
50	.01455	68.7501	.03201	31.2416	.04949	20.2066	.06700	14.9244	10
51	.01484	67.4019	.03230	30.9599	.04978	20.0872	.06730	14.8596	9
52	.01513	66.1055	.03259	30.6833	.05007	19.9702	.06759	14.7954	8
53	.01542	64.8580	.03288	30.4116	.05037	19.8546	.06788	14.7317	7
54	.01571	63.6567	.03317	30.1448	.05066	19.7403	.06817	14.6685	6
55	.01600	62.4992	.03346	29.8823	.05095	19.6273	.06847	14.6059	5
56	.01629	61.3829	.03376	29.6245	.05124	19.5156	.06876	14.5438	4
57	.01658	60.3058	.03405	29.3711	.05153	19.4051	.06905	14.4823	3
58	.01687	59.2659	.03434	29.1220	.05182	19.2959	.06934	14.4212	2
59	.01716	58.2612	.03463	28.8771	.05212	19.1879	.06963	14.3607	1
60	.01746	57.2900	.03492	28.6363	.05241	19.0811	.06993	14.3007	0
	Cotang	Tang	Cotang	Tang	Cotang	Tang	Cotang	Tang	
	89°		88°		87°		86°		

TABLE V.--NATURAL TANGENTS AND COTANGENTS.

4°		5°		6°		7°			
Tang	Cotang	Tang	Cotang	Tang	Cotang	Tang	Cotang		
0	.06918	14.3007	.06749	11.4901	.10510	9.51436	.12278	8.14485	60
1	.07022	14.2411	.06778	11.3919	.10540	9.48781	.12306	8.12481	59
2	.07051	14.1821	.06807	11.3540	.10569	9.46141	.12338	8.10580	58
3	.07080	14.1235	.06837	11.3163	.10599	9.43515	.12367	8.08680	57
4	.07110	14.0655	.06866	11.2789	.10628	9.40904	.12397	8.06774	56
5	.07139	14.0079	.06895	11.2417	.10657	9.38307	.12426	8.04756	55
6	.07168	13.9507	.06925	11.2048	.10687	9.35724	.12456	8.02848	54
7	.07197	13.8940	.06954	11.1681	.10716	9.33155	.12485	8.00948	53
8	.07227	13.8378	.06983	11.1316	.10746	9.30599	.12515	7.99058	52
9	.07256	13.7821	.09013	11.0954	.10775	9.28058	.12544	7.97176	51
10	.07285	13.7267	.09042	11.0594	.10805	9.25530	.12574	7.95302	50
11	.07314	13.6719	.09071	11.0237	.10834	9.23016	.12603	7.93438	49
12	.07344	13.6174	.09101	10.9882	.10863	9.20516	.12633	7.91582	48
13	.07373	13.5634	.09130	10.9529	.10893	9.18028	.12662	7.89734	47
14	.07402	13.5096	.09159	10.9178	.10922	9.15554	.12692	7.87886	46
15	.07431	13.4561	.09189	10.8829	.10952	9.13093	.12722	7.86064	45
16	.07461	13.4029	.09218	10.8483	.10981	9.10646	.12751	7.84244	44
17	.07490	13.3515	.09247	10.8139	.11011	9.08211	.12781	7.82438	43
18	.07519	13.2996	.09277	10.7797	.11040	9.05789	.12810	7.80632	42
19	.07548	13.2480	.09306	10.7457	.11070	9.03379	.12840	7.78825	41
20	.07578	13.1969	.09335	10.7119	.11099	9.00983	.12869	7.77025	40
21	.07607	13.1461	.09365	10.6783	.11128	8.98598	.12899	7.75254	39
22	.07636	13.0958	.09394	10.6450	.11158	8.96227	.12929	7.73480	38
23	.07665	13.0458	.09423	10.6118	.11187	8.93867	.12958	7.71715	37
24	.07695	12.9962	.09453	10.5789	.11217	8.91520	.12988	7.69967	36
25	.07724	12.9469	.09482	10.5462	.11246	8.89185	.13017	7.68208	35
26	.07753	12.8981	.09511	10.5136	.11275	8.86862	.13047	7.66466	34
27	.07782	12.8496	.09541	10.4813	.11305	8.84551	.13076	7.64732	33
28	.07812	12.8014	.09570	10.4491	.11335	8.82252	.13106	7.63005	32
29	.07841	12.7536	.09600	10.4172	.11364	8.79964	.13136	7.61287	31
30	.07870	12.7062	.09629	10.3854	.11394	8.77689	.13165	7.59575	30
31	.07899	12.6591	.09658	10.3538	.11423	8.75425	.13195	7.57872	29
32	.07929	12.6124	.09688	10.3224	.11452	8.73172	.13224	7.56176	28
33	.07958	12.5660	.09717	10.2913	.11482	8.70931	.13254	7.54487	27
34	.07987	12.5199	.09746	10.2602	.11511	8.68701	.13284	7.52806	26
35	.08017	12.4742	.09776	10.2294	.11541	8.66482	.13313	7.51132	25
36	.08046	12.4288	.09805	10.1988	.11570	8.64275	.13343	7.49465	24
37	.08075	12.3838	.09834	10.1683	.11600	8.62078	.13372	7.47806	23
38	.08104	12.3390	.09864	10.1381	.11629	8.59893	.13402	7.46154	22
39	.08134	12.2946	.09893	10.1080	.11659	8.57718	.13432	7.44509	21
40	.08163	12.2505	.09923	10.0780	.11688	8.55555	.13461	7.42871	20
41	.08192	12.2067	.09952	10.0483	.11718	8.53402	.13491	7.41240	19
42	.08221	12.1632	.09981	10.0187	.11747	8.51259	.13521	7.39610	18
43	.08251	12.1201	.10011	9.98931	.11777	8.49128	.13550	7.37999	17
44	.08280	12.0772	.10040	9.96007	.11806	8.47007	.13580	7.36388	16
45	.08309	12.0346	.10069	9.93101	.11836	8.44896	.13609	7.34786	15
46	.08339	11.9923	.10099	9.90211	.11865	8.42795	.13639	7.33190	14
47	.08368	11.9504	.10128	9.87338	.11895	8.40705	.13669	7.31600	13
48	.08397	11.9087	.10158	9.84482	.11924	8.38625	.13698	7.30018	12
49	.08427	11.8673	.10187	9.81641	.11954	8.36555	.13728	7.28442	11
50	.08456	11.8262	.10216	9.78817	.11983	8.34496	.13758	7.26873	10
51	.08485	11.7853	.10246	9.76009	.12013	8.32446	.13787	7.25310	9
52	.08514	11.7448	.10275	9.73217	.12043	8.30406	.13817	7.23754	8
53	.08544	11.7045	.10305	9.70441	.12072	8.28376	.13846	7.22204	7
54	.08573	11.6645	.10334	9.67680	.12101	8.26355	.13876	7.20661	6
55	.08602	11.6248	.10363	9.64935	.12131	8.24345	.13905	7.19125	5
56	.08632	11.5853	.10393	9.62205	.12160	8.22344	.13935	7.17594	4
57	.08661	11.5461	.10422	9.59490	.12190	8.20352	.13965	7.16071	3
58	.08690	11.5072	.10452	9.56791	.12219	8.18370	.13995	7.14553	2
59	.08720	11.4685	.10481	9.54106	.12249	8.16398	.14024	7.13042	1
60	.08749	11.4301	.10510	9.51436	.12278	8.14435	.14054	7.11537	0
	Cotang	Tang	Cotang	Tang	Cotang	Tang	Cotang	Tang	
	85°		84°		83°		82°		

TABLE V.—NATURAL TANGENTS AND COTANGENTS.

	8°		9°		10°		11°		
	Tang	Cotang	Tang	Cotang	Tang	Cotang	Tang	Cotang	
0	.14064	7.11587	.16898	6.31875	.17682	5.97128	.19436	5.14455	80
1	.14064	7.10088	.15868	6.30189	.17693	5.96185	.19468	5.13656	79
2	.14113	7.08546	.15898	6.29007	.17698	5.95205	.19498	5.12869	78
3	.14148	7.07059	.15928	6.27829	.17728	5.94248	.19529	5.12097	77
4	.14178	7.05579	.15958	6.26655	.17758	5.93296	.19559	5.11379	76
5	.14202	7.04105	.15988	6.25496	.17788	5.92344	.19589	5.10690	75
6	.14232	7.02637	.16017	6.24321	.17813	5.91397	.19619	5.09704	74
7	.14269	7.01174	.16047	6.23160	.17843	5.90452	.19649	5.08921	73
8	.14291	6.99718	.16077	6.22008	.17873	5.89511	.19680	5.08139	72
9	.14321	6.98268	.16107	6.20851	.17903	5.88573	.19710	5.07380	71
10	.14351	6.96823	.16137	6.19703	.17933	5.87638	.19740	5.06584	70
11	.14381	6.95385	.16167	6.18559	.17963	5.86706	.19770	5.05809	69
12	.14410	6.93952	.16196	6.17419	.17993	5.85777	.19801	5.05037	48
13	.14440	6.92525	.16226	6.16288	.18023	5.84851	.19831	5.04267	47
14	.14470	6.91104	.16256	6.15151	.18053	5.83927	.19861	5.03499	46
15	.14499	6.89688	.16286	6.14023	.18083	5.83007	.19891	5.02734	45
16	.14529	6.88278	.16316	6.12899	.18113	5.82090	.19921	5.01971	44
17	.14559	6.86874	.16346	6.11779	.18143	5.81176	.19951	5.01210	43
18	.14588	6.85475	.16376	6.10664	.18173	5.80264	.19981	5.00451	42
19	.14618	6.84082	.16405	6.09552	.18203	5.79356	.20012	4.99695	41
20	.14648	6.82694	.16435	6.08444	.18233	5.78451	.20042	4.98940	40
21	.14678	6.81312	.16465	6.07340	.18263	5.77548	.20073	4.98189	39
22	.14707	6.79936	.16495	6.06240	.18293	5.76648	.20103	4.97438	38
23	.14737	6.78566	.16525	6.05143	.18323	5.75751	.20133	4.96690	37
24	.14767	6.77199	.16555	6.04051	.18353	5.74857	.20164	4.95945	36
25	.14796	6.75838	.16585	6.02962	.18384	5.73966	.20194	4.95201	35
26	.14826	6.74483	.16615	6.01878	.18414	5.73077	.20224	4.94460	34
27	.14856	6.73133	.16645	6.00797	.18444	5.72189	.20254	4.93721	33
28	.14886	6.71789	.16674	5.99720	.18474	5.71303	.20285	4.92984	32
29	.14915	6.70450	.16704	5.98646	.18504	5.70420	.20315	4.92249	31
30	.14945	6.69116	.16734	5.97576	.18534	5.69552	.20345	4.91516	30
31	.14975	6.67787	.16764	5.96510	.18564	5.68677	.20376	4.90785	29
32	.15005	6.66463	.16794	5.95448	.18594	5.67805	.20406	4.90056	28
33	.15034	6.65144	.16824	5.94389	.18624	5.66936	.20436	4.89330	27
34	.15064	6.63831	.16854	5.93333	.18654	5.66070	.20466	4.88605	26
35	.15094	6.62523	.16884	5.92280	.18684	5.65206	.20497	4.87882	25
36	.15124	6.61219	.16914	5.91229	.18714	5.64345	.20527	4.87162	24
37	.15153	6.59921	.16944	5.90181	.18745	5.63487	.20557	4.86444	23
38	.15183	6.58627	.16974	5.89151	.18775	5.62631	.20588	4.85727	22
39	.15213	6.57339	.17004	5.88114	.18805	5.61778	.20618	4.85013	21
40	.15243	6.56055	.17033	5.87080	.18835	5.60928	.20648	4.84300	20
41	.15272	6.54777	.17063	5.86051	.18865	5.60080	.20679	4.83590	19
42	.15302	6.53503	.17093	5.85024	.18895	5.59235	.20709	4.82882	18
43	.15332	6.52234	.17123	5.84001	.18925	5.58393	.20739	4.82175	17
44	.15362	6.50970	.17153	5.82982	.18955	5.57553	.20770	4.81471	16
45	.15391	6.49710	.17183	5.81966	.18986	5.56715	.20800	4.80769	15
46	.15421	6.48456	.17213	5.80953	.19016	5.55880	.20830	4.80068	14
47	.15451	6.47206	.17243	5.79944	.19046	5.55048	.20861	4.79370	13
48	.15481	6.45961	.17273	5.78938	.19076	5.54218	.20891	4.78673	12
49	.15511	6.44720	.17303	5.77936	.19106	5.53391	.20921	4.77978	11
50	.15540	6.43484	.17333	5.76937	.19136	5.52566	.20952	4.77285	10
51	.15570	6.42253	.17363	5.75941	.19166	5.51744	.20982	4.76595	9
52	.15600	6.41026	.17393	5.74949	.19197	5.50925	.21013	4.75905	8
53	.15630	6.39804	.17423	5.73960	.19227	5.50107	.21043	4.75219	7
54	.15660	6.38587	.17453	5.72974	.19257	5.49293	.21073	4.74534	6
55	.15690	6.37374	.17483	5.71992	.19287	5.48480	.21104	4.73851	5
56	.15719	6.36165	.17513	5.71013	.19317	5.47671	.21134	4.73170	4
57	.15749	6.34961	.17543	5.70037	.19347	5.46863	.21164	4.72490	3
58	.15779	6.33761	.17573	5.69064	.19377	5.46058	.21195	4.71813	2
59	.15809	6.32566	.17603	5.68094	.19408	5.45256	.21225	4.71137	1
60	.15838	6.31375	.17633	5.67126	.19438	5.44455	.21256	4.70463	0
	Cotang	Tang	Cotang	Tang	Cotang	Tang	Cotang	Tang	
	81°		80°		79°		78°		

TABLE V.—NATURAL TANGENTS AND COTANGENTS.

	12°		13°		14°		15°		
	Tang	Cotang	Tang	Cotang	Tang	Cotang	Tang	Cotang	
0	.21356	4.70468	.23067	4.33148	.24933	4.01078	.26795	3.72805	60
1	.21398	4.69791	.23117	4.32573	.24984	4.00589	.26836	3.72771	59
2	.21316	4.69121	.23148	4.32001	.24995	4.00096	.26857	3.72828	58
3	.21347	4.68452	.23179	4.31430	.25026	3.99592	.26888	3.71907	57
4	.21377	4.67786	.23209	4.30860	.25056	3.99099	.26920	3.71476	56
5	.21408	4.67121	.23240	4.30291	.25087	3.98607	.26951	3.71046	55
6	.21438	4.66458	.23271	4.29724	.25118	3.98117	.26982	3.70616	54
7	.21469	4.65797	.23301	4.29159	.25149	3.97627	.27013	3.70186	53
8	.21499	4.65138	.23332	4.28595	.25180	3.97139	.27044	3.69751	52
9	.21529	4.64480	.23363	4.28032	.25211	3.96651	.27075	3.69325	51
10	.21560	4.63825	.23393	4.27471	.25242	3.96165	.27107	3.68909	50
11	.21590	4.63171	.23424	4.26911	.25273	3.95680	.27138	3.68485	49
12	.21621	4.62518	.23455	4.26352	.25304	3.95196	.27169	3.68061	48
13	.21651	4.61868	.23486	4.25795	.25335	3.94713	.27201	3.67638	47
14	.21682	4.61219	.23516	4.25239	.25366	3.94231	.27232	3.67217	46
15	.21713	4.60572	.23547	4.24685	.25397	3.93751	.27263	3.66798	45
16	.21743	4.59927	.23578	4.24132	.25428	3.93271	.27294	3.66378	44
17	.21773	4.59283	.23608	4.23580	.25459	3.92798	.27325	3.65957	43
18	.21804	4.58641	.23639	4.23029	.25490	3.92316	.27357	3.65538	42
19	.21834	4.58001	.23670	4.22481	.25521	3.91839	.27388	3.65121	41
20	.21864	4.57363	.23700	4.21933	.25552	3.91364	.27419	3.64705	40
21	.21895	4.56726	.23731	4.21387	.25583	3.90890	.27451	3.64289	39
22	.21925	4.56091	.23762	4.20843	.25614	3.90417	.27482	3.63874	38
23	.21956	4.55458	.23793	4.20299	.25645	3.89945	.27513	3.63461	37
24	.21986	4.54826	.23823	4.19756	.25676	3.89474	.27545	3.63049	36
25	.22017	4.54196	.23854	4.19215	.25707	3.89004	.27576	3.62636	35
26	.22047	4.53568	.23885	4.18675	.25738	3.88536	.27607	3.62224	34
27	.22078	4.52941	.23916	4.18137	.25769	3.88068	.27638	3.61814	33
28	.22108	4.52316	.23946	4.17600	.25800	3.87601	.27670	3.61405	32
29	.22139	4.51693	.23977	4.17064	.25831	3.87136	.27701	3.61000	31
30	.22169	4.51071	.24008	4.16530	.25862	3.86671	.27732	3.60588	30
31	.22200	4.50451	.24039	4.15997	.25893	3.86206	.27764	3.60181	29
32	.22231	4.49832	.24069	4.15465	.25924	3.85745	.27795	3.59775	28
33	.22261	4.49215	.24100	4.14934	.25955	3.85284	.27826	3.59370	27
34	.22292	4.48600	.24131	4.14404	.25986	3.84824	.27858	3.58966	26
35	.22322	4.47986	.24162	4.13877	.26017	3.84364	.27889	3.58562	25
36	.22353	4.47374	.24193	4.13350	.26048	3.83906	.27921	3.58160	24
37	.22383	4.46764	.24223	4.12825	.26079	3.83449	.27952	3.57758	23
38	.22414	4.46155	.24254	4.12301	.26110	3.82992	.27983	3.57357	22
39	.22444	4.45548	.24285	4.11778	.26141	3.82537	.28015	3.56957	21
40	.22475	4.44943	.24316	4.11256	.26172	3.82083	.28046	3.56557	20
41	.22505	4.44338	.24347	4.10736	.26203	3.81630	.28077	3.56159	19
42	.22536	4.43735	.24377	4.10218	.26235	3.81177	.28109	3.55761	18
43	.22567	4.43134	.24408	4.09699	.26266	3.80726	.28140	3.55364	17
44	.22597	4.42534	.24439	4.09182	.26297	3.80276	.28172	3.54968	16
45	.22628	4.41936	.24470	4.08666	.26328	3.79827	.28203	3.54573	15
46	.22658	4.41340	.24501	4.08152	.26359	3.79378	.28234	3.54179	14
47	.22689	4.40745	.24532	4.07639	.26390	3.78931	.28266	3.53785	13
48	.22719	4.40152	.24562	4.07127	.26421	3.78485	.28297	3.53392	12
49	.22750	4.39560	.24593	4.06616	.26452	3.78040	.28329	3.53001	11
50	.22781	4.38969	.24624	4.06107	.26483	3.77595	.28360	3.52609	10
51	.22811	4.38381	.24655	4.05599	.26515	3.77152	.28391	3.52219	9
52	.22842	4.37798	.24686	4.05092	.26546	3.76709	.28422	3.51829	8
53	.22873	4.37207	.24717	4.04586	.26577	3.76268	.28454	3.51441	7
54	.22904	4.36623	.24747	4.04081	.26608	3.75828	.28486	3.51053	6
55	.22934	4.36040	.24778	4.03578	.26639	3.75388	.28517	3.50666	5
56	.22964	4.35459	.24809	4.03076	.26670	3.74950	.28549	3.50279	4
57	.22995	4.34879	.24840	4.02574	.26701	3.74513	.28580	3.49894	3
58	.23026	4.34300	.24871	4.02074	.26732	3.74075	.28612	3.49509	2
59	.23056	4.33723	.24902	4.01576	.26763	3.73640	.28643	3.49125	1
60	.23087	4.33148	.24933	4.01078	.26795	3.73205	.28675	3.48741	0
	Cotang	Tang	Cotang	Tang	Cotang	Tang	Cotang	Tang	
	77°		76°		75°		74°		

TABLE V.—NATURAL TANGENTS AND COTANGENTS.

	16°		17°		18°		19°		
	Tang	Cotang	Tang	Cotang	Tang	Cotang	Tang	Cotang	
0	.28675	3.48741	.30573	3.27085	.32492	3.07768	.34433	2.90421	60
1	.28706	3.48859	.30605	3.26745	.32524	3.07484	.34465	2.90147	59
2	.28738	3.47977	.30637	3.26406	.32556	3.07160	.34498	2.89873	58
3	.28769	3.47596	.30669	3.26067	.32588	3.06857	.34530	2.89600	57
4	.28800	3.47216	.30700	3.25729	.32621	3.06554	.34563	2.89327	56
5	.28832	3.46837	.30732	3.25392	.32653	3.06252	.34596	2.89055	55
6	.28864	3.46458	.30764	3.25055	.32685	3.05950	.34628	2.88783	54
7	.28895	3.46080	.30796	3.24719	.32717	3.05649	.34661	2.88511	53
8	.28927	3.45703	.30828	3.24383	.32749	3.05349	.34693	2.88240	52
9	.28958	3.45327	.30860	3.24049	.32782	3.05049	.34726	2.87970	51
10	.28990	3.44951	.30891	3.23714	.32814	3.04749	.34758	2.87700	50
11	.29021	3.44576	.30923	3.23381	.32846	3.04450	.34791	2.87430	49
12	.29053	3.44202	.30955	3.23048	.32878	3.04152	.34824	2.87161	48
13	.29084	3.43829	.30987	3.22715	.32911	3.03854	.34856	2.86892	47
14	.29116	3.43456	.31019	3.22384	.32943	3.03556	.34889	2.86624	46
15	.29147	3.43084	.31051	3.22053	.32975	3.03259	.34922	2.86356	45
16	.29179	3.42713	.31083	3.21722	.33007	3.02963	.34954	2.86089	44
17	.29210	3.42343	.31115	3.21392	.33040	3.02667	.34987	2.85822	43
18	.29242	3.41973	.31147	3.21063	.33072	3.02372	.35020	2.85555	42
19	.29274	3.41604	.31178	3.20734	.33104	3.02077	.35052	2.85289	41
20	.29305	3.41236	.31210	3.20406	.33136	3.01783	.35085	2.85023	40
21	.29337	3.40869	.31242	3.20079	.33169	3.01489	.35118	2.84758	39
22	.29368	3.40502	.31274	3.19752	.33201	3.01196	.35150	2.84494	38
23	.29400	3.40136	.31306	3.19426	.33233	3.00903	.35183	2.84229	37
24	.29432	3.39771	.31338	3.19100	.33265	3.00611	.35216	2.83965	36
25	.29463	3.39406	.31370	3.18775	.33298	3.00319	.35248	2.83702	35
26	.29495	3.39042	.31402	3.18451	.33330	3.00028	.35281	2.83439	34
27	.29526	3.38679	.31434	3.18127	.33363	2.99738	.35314	2.83176	33
28	.29558	3.38317	.31466	3.17804	.33395	2.99447	.35346	2.82914	32
29	.29590	3.37955	.31498	3.17481	.33427	2.99158	.35379	2.82653	31
30	.29622	3.37594	.31530	3.17159	.33460	2.98868	.35411	2.82391	30
31	.29653	3.37234	.31562	3.16838	.33492	2.98580	.35445	2.82130	29
32	.29685	3.36875	.31594	3.16517	.33524	2.98292	.35477	2.81870	28
33	.29716	3.36516	.31626	3.16197	.33557	2.98004	.35510	2.81610	27
34	.29748	3.36158	.31658	3.15877	.33589	2.97717	.35543	2.81350	26
35	.29780	3.35800	.31690	3.15558	.33621	2.97430	.35576	2.81091	25
36	.29811	3.35443	.31722	3.15240	.33654	2.97144	.35608	2.80833	24
37	.29843	3.35087	.31754	3.14922	.33686	2.96858	.35641	2.80574	23
38	.29875	3.34732	.31786	3.14605	.33718	2.96573	.35674	2.80316	22
39	.29906	3.34377	.31818	3.14288	.33751	2.96288	.35707	2.80059	21
40	.29938	3.34023	.31850	3.13972	.33783	2.96004	.35740	2.79802	20
41	.29970	3.33670	.31882	3.13656	.33816	2.95721	.35772	2.79545	19
42	.30001	3.33317	.31914	3.13341	.33848	2.95437	.35805	2.79289	18
43	.30033	3.32965	.31946	3.13027	.33881	2.95155	.35838	2.79033	17
44	.30065	3.32614	.31978	3.12713	.33913	2.94872	.35871	2.78778	16
45	.30097	3.32264	.32010	3.12400	.33945	2.94591	.35904	2.78523	15
46	.30128	3.31914	.32042	3.12087	.33978	2.94309	.35937	2.78269	14
47	.30160	3.31565	.32074	3.11775	.34010	2.94028	.35969	2.78014	13
48	.30192	3.31216	.32106	3.11464	.34043	2.93748	.36002	2.77761	12
49	.30224	3.30868	.32139	3.11153	.34075	2.93468	.36035	2.77507	11
50	.30255	3.30521	.32171	3.10842	.34108	2.93189	.36068	2.77254	10
51	.30287	3.30174	.32203	3.10532	.34140	2.92910	.36101	2.77002	9
52	.30319	3.29829	.32235	3.10223	.34173	2.92632	.36134	2.76750	8
53	.30351	3.29483	.32267	3.09914	.34205	2.92354	.36167	2.76498	7
54	.30382	3.29139	.32299	3.09606	.34238	2.92076	.36199	2.76247	6
55	.30414	3.28795	.32331	3.09298	.34270	2.91799	.36232	2.75996	5
56	.30446	3.28452	.32363	3.08991	.34303	2.91523	.36265	2.75744	4
57	.30478	3.28109	.32395	3.08685	.34335	2.91246	.36298	2.75493	3
58	.30509	3.27767	.32428	3.08379	.34368	2.90971	.36331	2.75242	2
59	.30541	3.27426	.32460	3.08073	.34400	2.90696	.36364	2.74991	1
60	.30573	3.27085	.32492	3.07768	.34433	2.90421	.36397	2.74740	0
	Cotang	Tang	Cotang	Tang	Cotang	Tang	Cotang	Tang	
	73°		72°		71°		70°		

TABLE V.—NATURAL TANGENTS AND COTANGENTS.

	20°		21°		22°		23°		
	Tang	Cotang	Tang	Cotang	Tang	Cotang	Tang	Cotang	
0	.36397	2.74748	.38386	2.60509	.40403	2.47509	.42447	2.35585	60
1	.36430	2.74499	.38430	2.60288	.40436	2.47302	.42482	2.35395	59
2	.36463	2.74251	.38453	2.60057	.40470	2.47095	.42516	2.35205	58
3	.36496	2.74004	.38487	2.59831	.40504	2.46888	.42551	2.35015	57
4	.36529	2.73756	.38530	2.59606	.40538	2.46682	.42585	2.34825	56
5	.36563	2.73509	.38553	2.59381	.40573	2.46475	.42619	2.34635	55
6	.36595	2.73263	.38587	2.59155	.40606	2.46270	.42654	2.34445	54
7	.36628	2.73017	.38630	2.58928	.40640	2.46065	.42688	2.34255	53
8	.36661	2.72771	.38654	2.58703	.40674	2.45860	.42722	2.34065	52
9	.36694	2.72526	.38687	2.58478	.40707	2.45655	.42757	2.33875	51
10	.36727	2.72281	.38731	2.58251	.40741	2.45451	.42791	2.33685	50
11	.36760	2.72036	.38754	2.58028	.40775	2.45246	.42826	2.33495	49
12	.36793	2.71792	.38787	2.57815	.40809	2.45043	.42860	2.33311	48
13	.36826	2.71548	.38821	2.57602	.40843	2.44842	.42894	2.33126	47
14	.36859	2.71305	.38854	2.57389	.40877	2.44642	.42929	2.32941	46
15	.36892	2.71062	.38898	2.57176	.40911	2.44443	.42963	2.32756	45
16	.36925	2.70819	.38921	2.56962	.40945	2.44245	.42998	2.32570	44
17	.36958	2.70577	.38955	2.56749	.40979	2.44047	.43032	2.32385	43
18	.36991	2.70335	.38988	2.56537	.41013	2.43850	.43067	2.32201	42
19	.37024	2.70094	.39022	2.56324	.41047	2.43658	.43101	2.32019	41
20	.37057	2.69853	.39055	2.56112	.41081	2.43467	.43136	2.31838	40
21	.37090	2.69612	.39089	2.55897	.41115	2.43276	.43170	2.31657	39
22	.37123	2.69371	.39122	2.55682	.41149	2.43085	.43205	2.31476	38
23	.37157	2.69131	.39156	2.55467	.41183	2.42894	.43239	2.31295	37
24	.37190	2.68892	.39190	2.55251	.41217	2.42703	.43274	2.31114	36
25	.37223	2.68653	.39222	2.55036	.41251	2.42512	.43308	2.30933	35
26	.37256	2.68414	.39257	2.54821	.41285	2.42321	.43343	2.30752	34
27	.37289	2.68175	.39290	2.54606	.41319	2.42130	.43377	2.30571	33
28	.37322	2.67937	.39324	2.54390	.41353	2.41939	.43412	2.30390	32
29	.37355	2.67700	.39357	2.54175	.41387	2.41748	.43447	2.30209	31
30	.37388	2.67462	.39391	2.53960	.41421	2.41557	.43481	2.30028	30
31	.37422	2.67225	.39425	2.53745	.41455	2.41366	.43516	2.29847	29
32	.37455	2.66988	.39458	2.53530	.41490	2.41175	.43550	2.29666	28
33	.37488	2.66752	.39492	2.53315	.41524	2.40984	.43585	2.29485	27
34	.37521	2.66516	.39526	2.53100	.41558	2.40793	.43620	2.29304	26
35	.37554	2.66281	.39559	2.52885	.41592	2.40602	.43654	2.29123	25
36	.37587	2.66046	.39593	2.52670	.41626	2.40411	.43689	2.28942	24
37	.37621	2.65811	.39626	2.52455	.41660	2.40220	.43724	2.28761	23
38	.37654	2.65576	.39660	2.52240	.41694	2.39929	.43758	2.28580	22
39	.37687	2.65342	.39694	2.52025	.41728	2.39738	.43793	2.28399	21
40	.37720	2.65109	.39727	2.51810	.41763	2.39547	.43828	2.28218	20
41	.37754	2.64875	.39761	2.51595	.41797	2.39356	.43862	2.28037	19
42	.37787	2.64642	.39795	2.51380	.41831	2.39165	.43897	2.27856	18
43	.37820	2.64410	.39829	2.51165	.41865	2.38974	.43932	2.27675	17
44	.37853	2.64177	.39862	2.50950	.41899	2.38783	.43966	2.27494	16
45	.37887	2.63945	.39896	2.50735	.41933	2.38592	.44001	2.27313	15
46	.37920	2.63713	.39930	2.50520	.41967	2.38401	.44036	2.27132	14
47	.37953	2.63481	.39963	2.50305	.42001	2.38210	.44071	2.26951	13
48	.37986	2.63250	.39997	2.50090	.42035	2.38019	.44106	2.26770	12
49	.38020	2.63019	.40031	2.49875	.42070	2.37828	.44141	2.26589	11
50	.38053	2.62788	.40065	2.49660	.42105	2.37637	.44176	2.26408	10
51	.38086	2.62557	.40098	2.49445	.42139	2.37446	.44211	2.26227	9
52	.38120	2.62326	.40132	2.49230	.42173	2.37255	.44246	2.26046	8
53	.38153	2.62095	.40166	2.49015	.42207	2.37064	.44281	2.25865	7
54	.38186	2.61864	.40200	2.48800	.42241	2.36873	.44316	2.25684	6
55	.38220	2.61633	.40234	2.48585	.42275	2.36682	.44351	2.25503	5
56	.38253	2.61402	.40267	2.48370	.42310	2.36491	.44386	2.25322	4
57	.38286	2.61171	.40301	2.48155	.42344	2.36300	.44421	2.25141	3
58	.38320	2.60940	.40335	2.47940	.42378	2.36109	.44456	2.24960	2
59	.38353	2.60709	.40369	2.47725	.42412	2.35918	.44491	2.24779	1
60	.38386	2.60478	.40403	2.47510	.42447	2.35727	.44526	2.24598	0
	Cotang	Tang	Cotang	Tang	Cotang	Tang	Cotang	Tang	
	69°		68°		67°		66°		

TABLE V.—NATURAL TANGENTS AND COTANGENTS.

	24°		25°		26°		27°		
	Tang	Cotang	Tang	Cotang	Tang	Cotang	Tang	Cotang	
0	.44523	2.24604	.46631	2.14451	.48773	2.06800	.50883	1.96861	60
1	.44558	2.24428	.46666	2.14288	.48809	2.04879	.50939	1.96120	59
2	.44593	2.24252	.46702	2.14125	.48845	2.04728	.51026	1.95379	58
3	.44627	2.24077	.46737	2.13963	.48881	2.04577	.51063	1.94638	57
4	.44662	2.23902	.46772	2.13801	.48917	2.04426	.51099	1.93896	56
5	.44697	2.23727	.46806	2.13639	.48953	2.04276	.51136	1.93155	55
6	.44732	2.23552	.46843	2.13477	.48989	2.04125	.51173	1.92413	54
7	.44767	2.23377	.46879	2.13316	.49026	2.03975	.51209	1.91672	53
8	.44802	2.23202	.46914	2.13154	.49063	2.03824	.51246	1.90931	52
9	.44837	2.23028	.46950	2.12993	.49098	2.03673	.51283	1.90190	51
10	.44872	2.22853	.46985	2.12832	.49134	2.03522	.51319	1.89448	50
11	.44907	2.22678	.47021	2.12671	.49170	2.03371	.51356	1.94718	49
12	.44942	2.22503	.47056	2.12511	.49206	2.03220	.51393	1.94579	48
13	.44977	2.22328	.47092	2.12350	.49242	2.03069	.51430	1.94440	47
14	.45012	2.22153	.47128	2.12190	.49278	2.02918	.51467	1.94301	46
15	.45047	2.21978	.47163	2.12030	.49315	2.02767	.51504	1.94162	45
16	.45082	2.21803	.47199	2.11871	.49351	2.02616	.51540	1.94023	44
17	.45117	2.21628	.47234	2.11711	.49387	2.02465	.51577	1.93884	43
18	.45152	2.21453	.47270	2.11552	.49423	2.02314	.51614	1.93745	42
19	.45187	2.21278	.47305	2.11392	.49459	2.02163	.51651	1.93606	41
20	.45222	2.21103	.47341	2.11233	.49495	2.02012	.51688	1.93467	40
21	.45257	2.20928	.47377	2.11073	.49531	2.01861	.51724	1.93328	39
22	.45292	2.20753	.47412	2.10914	.49567	2.01710	.51761	1.93189	38
23	.45327	2.20578	.47448	2.10755	.49603	2.01559	.51798	1.93050	37
24	.45362	2.20403	.47483	2.10596	.49639	2.01408	.51835	1.92911	36
25	.45397	2.20228	.47519	2.10437	.49675	2.01257	.51872	1.92772	35
26	.45432	2.20053	.47555	2.10278	.49711	2.01106	.51909	1.92633	34
27	.45467	2.19878	.47590	2.10119	.49747	2.01006	.51946	1.92494	33
28	.45502	2.19703	.47626	2.09960	.49783	2.00855	.51983	1.92355	32
29	.45537	2.19528	.47662	2.09801	.49819	2.00704	.52020	1.92216	31
30	.45572	2.19353	.47698	2.09642	.49855	2.00553	.52057	1.92077	30
31	.45606	2.19178	.47733	2.09483	.49891	2.00402	.52094	1.91938	29
32	.45641	2.19003	.47769	2.09324	.49927	2.00251	.52131	1.91799	28
33	.45676	2.18828	.47805	2.09165	.49963	2.00100	.52168	1.91660	27
34	.45711	2.18653	.47840	2.09006	.50000	1.99949	.52205	1.91521	26
35	.45746	2.18478	.47876	2.08847	.50036	1.99798	.52242	1.91382	25
36	.45781	2.18303	.47912	2.08688	.50072	1.99647	.52279	1.91243	24
37	.45816	2.18128	.47948	2.08529	.50108	1.99496	.52316	1.91104	23
38	.45851	2.17953	.47984	2.08370	.50144	1.99345	.52353	1.91012	22
39	.45886	2.17778	.48019	2.08211	.50180	1.99194	.52390	1.90873	21
40	.45921	2.17603	.48055	2.08052	.50216	1.99043	.52427	1.90734	20
41	.45956	2.17428	.48091	2.07893	.50252	1.98892	.52464	1.90595	19
42	.45991	2.17253	.48127	2.07734	.50288	1.98741	.52501	1.90456	18
43	.46026	2.17078	.48163	2.07575	.50324	1.98590	.52538	1.90317	17
44	.46061	2.16903	.48198	2.07416	.50360	1.98439	.52575	1.90178	16
45	.46096	2.16728	.48234	2.07257	.50396	1.98288	.52612	1.90039	15
46	.46131	2.16553	.48270	2.07098	.50432	1.98137	.52649	1.89900	14
47	.46166	2.16378	.48306	2.06939	.50468	1.97986	.52686	1.89761	13
48	.46201	2.16203	.48342	2.06780	.50504	1.97835	.52723	1.89622	12
49	.46236	2.16028	.48378	2.06621	.50540	1.97684	.52760	1.89483	11
50	.46271	2.15853	.48414	2.06462	.50576	1.97533	.52797	1.89344	10
51	.46311	2.15678	.48450	2.06303	.50612	1.97382	.52834	1.89205	9
52	.46346	2.15503	.48486	2.06144	.50648	1.97231	.52871	1.89138	8
53	.46381	2.15328	.48521	2.05985	.50684	1.97080	.52908	1.89000	7
54	.46416	2.15153	.48557	2.05826	.50720	1.97111	.52945	1.88861	6
55	.46451	2.14978	.48593	2.05667	.50756	1.96960	.52982	1.88722	5
56	.46486	2.14803	.48629	2.05508	.50792	1.96809	.53019	1.88583	4
57	.46521	2.14628	.48665	2.05349	.50828	1.96658	.53056	1.88444	3
58	.46556	2.14453	.48701	2.05190	.50864	1.96507	.53093	1.88305	2
59	.46591	2.14278	.48737	2.05031	.50900	1.96356	.53130	1.88166	1
60	.46626	2.14103	.48773	2.04872	.50936	1.96205	.53167	1.88027	0
	Cotang	Tang	Cotang	Tang	Cotang	Tang	Cotang	Tang	
	65°		64°		63°		62°		

TABLE V.—NATURAL TANGENTS AND COTANGENTS.

°	28°		29°		30°		31°		°
	Tang	Cotang	Tang	Cotang	Tang	Cotang	Tang	Cotang	
0	.53171	1.88073	.55481	1.80405	.57735	1.72805	.60086	1.66428	60
1	.53208	1.87941	.55469	1.80281	.57774	1.73059	.60126	1.66318	59
2	.53246	1.87809	.55457	1.80158	.57813	1.73313	.60165	1.66209	58
3	.53283	1.87677	.55445	1.80034	.57851	1.73567	.60205	1.66100	57
4	.53320	1.87546	.55433	1.79911	.57890	1.73821	.60245	1.65990	56
5	.53358	1.87415	.55421	1.79788	.57929	1.74075	.60284	1.65881	55
6	.53395	1.87283	.55409	1.79665	.57968	1.74329	.60324	1.65772	54
7	.53432	1.87152	.55397	1.79542	.58007	1.74583	.60364	1.65663	53
8	.53470	1.87021	.55385	1.79419	.58046	1.74837	.60403	1.65554	52
9	.53507	1.86890	.55373	1.79296	.58085	1.75091	.60443	1.65445	51
10	.53545	1.86760	.55361	1.79174	.58124	1.75345	.60483	1.65337	50
11	.53582	1.86630	.55349	1.79051	.58162	1.75599	.60523	1.65228	49
12	.53620	1.86499	.55337	1.78929	.58201	1.75853	.60562	1.65120	48
13	.53657	1.86369	.55325	1.78807	.58240	1.76107	.60602	1.65011	47
14	.53694	1.86239	.55313	1.78685	.58279	1.76361	.60642	1.64902	46
15	.53732	1.86109	.55301	1.78563	.58318	1.76615	.60681	1.64793	45
16	.53770	1.85979	.55289	1.78441	.58357	1.76869	.60721	1.64684	44
17	.53807	1.85849	.55277	1.78319	.58396	1.77123	.60761	1.64575	43
18	.53844	1.85720	.55265	1.78197	.58435	1.77377	.60801	1.64466	42
19	.53882	1.85591	.55253	1.78075	.58474	1.77631	.60841	1.64357	41
20	.53920	1.85463	.55241	1.77953	.58513	1.77885	.60881	1.64248	40
21	.53957	1.85333	.55229	1.77831	.58552	1.78139	.60921	1.64139	39
22	.53995	1.85204	.55217	1.77709	.58591	1.78393	.60960	1.64030	38
23	.54032	1.85075	.55205	1.77587	.58630	1.78647	.61000	1.63921	37
24	.54070	1.84946	.55193	1.77465	.58669	1.78901	.61040	1.63812	36
25	.54107	1.84818	.55181	1.77343	.58708	1.79155	.61080	1.63703	35
26	.54145	1.84689	.55169	1.77221	.58747	1.79409	.61120	1.63594	34
27	.54182	1.84561	.55157	1.77099	.58786	1.79663	.61160	1.63485	33
28	.54220	1.84433	.55145	1.76977	.58825	1.79917	.61200	1.63376	32
29	.54258	1.84305	.55133	1.76855	.58864	1.80171	.61240	1.63267	31
30	.54296	1.84177	.55121	1.76733	.58903	1.80425	.61280	1.63158	30
31	.54333	1.84049	.55109	1.76611	.58942	1.80679	.61320	1.63049	29
32	.54371	1.83922	.55097	1.76489	.58981	1.80933	.61360	1.62940	28
33	.54409	1.83794	.55085	1.76367	.59020	1.81187	.61400	1.62831	27
34	.54446	1.83667	.55073	1.76245	.59059	1.81441	.61440	1.62722	26
35	.54484	1.83540	.55061	1.76123	.59098	1.81695	.61480	1.62613	25
36	.54522	1.83413	.55049	1.76001	.59137	1.81949	.61520	1.62504	24
37	.54560	1.83286	.55037	1.75879	.59176	1.82203	.61560	1.62395	23
38	.54597	1.83159	.55025	1.75757	.59215	1.82457	.61600	1.62286	22
39	.54635	1.83033	.55013	1.75635	.59254	1.82711	.61640	1.62177	21
40	.54673	1.82906	.55001	1.75513	.59293	1.82965	.61680	1.62068	20
41	.54711	1.82780	.54989	1.75391	.59332	1.83219	.61720	1.61959	19
42	.54748	1.82654	.54977	1.75269	.59371	1.83473	.61760	1.61850	18
43	.54786	1.82528	.54965	1.75147	.59410	1.83727	.61800	1.61741	17
44	.54824	1.82402	.54953	1.75025	.59449	1.83981	.61840	1.61632	16
45	.54862	1.82276	.54941	1.74903	.59488	1.84235	.61880	1.61523	15
46	.54900	1.82150	.54929	1.74781	.59527	1.84489	.61920	1.61414	14
47	.54938	1.82025	.54917	1.74659	.59566	1.84743	.61960	1.61305	13
48	.54976	1.81900	.54905	1.74537	.59605	1.84997	.62000	1.61196	12
49	.55013	1.81774	.54893	1.74415	.59644	1.85251	.62040	1.61087	11
50	.55051	1.81649	.54881	1.74293	.59683	1.85505	.62080	1.60978	10
51	.55089	1.81524	.54869	1.74171	.59722	1.85759	.62120	1.60869	9
52	.55127	1.81399	.54857	1.74049	.59761	1.86013	.62160	1.60760	8
53	.55165	1.81274	.54845	1.73927	.59800	1.86267	.62200	1.60651	7
54	.55203	1.81150	.54833	1.73805	.59839	1.86521	.62240	1.60542	6
55	.55241	1.81025	.54821	1.73683	.59878	1.86775	.62280	1.60433	5
56	.55279	1.80901	.54809	1.73561	.59917	1.87029	.62320	1.60324	4
57	.55317	1.80777	.54797	1.73439	.59956	1.87283	.62360	1.60215	3
58	.55355	1.80653	.54785	1.73317	.59995	1.87537	.62400	1.60106	2
59	.55393	1.80529	.54773	1.73195	.60034	1.87791	.62440	1.60000	1
60	.55431	1.80405	.54761	1.73073	.60073	1.88045	.62480	1.60000	0
	Cotang	Tang	Cotang	Tang	Cotang	Tang	Cotang	Tang	
	61°		60°		59°		58°		

TABLE V.—NATURAL TANGENTS AND COTANGENTS.

	32°		33°		34°		35°		
	Tang	Cotang	Tang	Cotang	Tang	Cotang	Tang	Cotang	
0	.62487	1.60088	.64941	1.58968	.67451	1.48256	.70021	1.42815	60
1	.62527	1.59980	.64982	1.58888	.67498	1.48168	.70064	1.42726	59
2	.62568	1.59896	.65024	1.58791	.67538	1.48070	.70107	1.42638	58
3	.62606	1.59728	.65065	1.58698	.67578	1.47977	.70151	1.42550	57
4	.62649	1.59580	.65106	1.58595	.67620	1.47885	.70194	1.42462	56
5	.62689	1.59417	.65148	1.58497	.67663	1.47792	.70238	1.42374	55
6	.62730	1.59244	.65189	1.58400	.67705	1.47699	.70281	1.42286	54
7	.62770	1.59111	.65231	1.58302	.67748	1.47607	.70325	1.42198	53
8	.62811	1.59006	.65272	1.58205	.67790	1.47514	.70368	1.42110	52
9	.62852	1.59105	.65314	1.58107	.67832	1.47422	.70412	1.42022	51
10	.62893	1.59002	.65355	1.58010	.67875	1.47330	.70455	1.41934	50
11	.62933	1.58900	.65397	1.57918	.67917	1.47238	.70499	1.41847	49
12	.62973	1.58797	.65438	1.52816	.67960	1.47146	.70542	1.41759	48
13	.63014	1.58695	.65480	1.52719	.68002	1.47053	.70586	1.41672	47
14	.63055	1.58593	.65521	1.52622	.68045	1.46960	.70629	1.41584	46
15	.63095	1.58490	.65563	1.52525	.68088	1.46867	.70673	1.41497	45
16	.63136	1.58388	.65604	1.52428	.68130	1.46775	.70717	1.41409	44
17	.63177	1.58286	.65646	1.52331	.68173	1.46682	.70760	1.41322	43
18	.63217	1.58184	.65688	1.52233	.68215	1.46589	.70804	1.41235	42
19	.63258	1.58083	.65729	1.52136	.68258	1.46496	.70848	1.41148	41
20	.63299	1.57981	.65771	1.52039	.68301	1.46411	.70891	1.41061	40
21	.63340	1.57879	.65813	1.51942	.68343	1.46320	.70935	1.40974	39
22	.63380	1.57778	.65854	1.51850	.68386	1.46229	.70979	1.40887	38
23	.63421	1.57676	.65896	1.51754	.68429	1.46137	.71023	1.40800	37
24	.63462	1.57575	.65938	1.51658	.68471	1.46046	.71066	1.40714	36
25	.63503	1.57474	.65980	1.51562	.68514	1.45955	.71110	1.40627	35
26	.63544	1.57373	.66021	1.51466	.68557	1.45864	.71154	1.40540	34
27	.63584	1.57272	.66063	1.51370	.68600	1.45773	.71198	1.40454	33
28	.63625	1.57170	.66105	1.51275	.68642	1.45682	.71242	1.40367	32
29	.63666	1.57069	.66147	1.51179	.68685	1.45592	.71285	1.40281	31
30	.63707	1.56969	.66189	1.51084	.68728	1.45501	.71329	1.40195	30
31	.63748	1.56868	.66230	1.50988	.68771	1.45410	.71373	1.40109	29
32	.63789	1.56767	.66272	1.50893	.68814	1.45320	.71417	1.40023	28
33	.63830	1.56666	.66314	1.50797	.68857	1.45229	.71461	1.39938	27
34	.63871	1.56566	.66356	1.50702	.68900	1.45139	.71505	1.39852	26
35	.63912	1.56466	.66398	1.50607	.68943	1.45049	.71549	1.39766	25
36	.63953	1.56366	.66440	1.50512	.68985	1.44958	.71593	1.39679	24
37	.63994	1.56266	.66482	1.50417	.69028	1.44868	.71637	1.39593	23
38	.64035	1.56165	.66524	1.50322	.69071	1.44778	.71681	1.39507	22
39	.64076	1.56065	.66566	1.50228	.69114	1.44688	.71725	1.39421	21
40	.64117	1.55966	.66608	1.50133	.69157	1.44598	.71769	1.39336	20
41	.64158	1.55866	.66650	1.50038	.69200	1.44508	.71813	1.39250	19
42	.64199	1.55766	.66692	1.49944	.69243	1.44418	.71857	1.39165	18
43	.64240	1.55666	.66734	1.49849	.69286	1.44329	.71901	1.39079	17
44	.64281	1.55567	.66776	1.49755	.69329	1.44239	.71946	1.38994	16
45	.64322	1.55467	.66818	1.49661	.69372	1.44149	.71990	1.38909	15
46	.64363	1.55368	.66860	1.49566	.69415	1.44060	.72034	1.38824	14
47	.64404	1.55269	.66902	1.49472	.69459	1.43970	.72078	1.38738	13
48	.64445	1.55170	.66944	1.49378	.69502	1.43881	.72122	1.38653	12
49	.64487	1.55071	.66986	1.49284	.69545	1.43792	.72167	1.38568	11
50	.64528	1.54973	.67028	1.49190	.69588	1.43703	.72211	1.38484	10
51	.64569	1.54875	.67071	1.49097	.69631	1.43614	.72255	1.38399	9
52	.64610	1.54777	.67113	1.49003	.69675	1.43525	.72299	1.38314	8
53	.64652	1.54675	.67155	1.48909	.69718	1.43436	.72344	1.38229	7
54	.64693	1.54576	.67197	1.48816	.69761	1.43347	.72388	1.38145	6
55	.64734	1.54478	.67239	1.48722	.69804	1.43258	.72433	1.38060	5
56	.64775	1.54379	.67282	1.48628	.69847	1.43169	.72477	1.37976	4
57	.64817	1.54281	.67324	1.48536	.69891	1.43080	.72521	1.37891	3
58	.64858	1.54183	.67366	1.48444	.69934	1.42992	.72565	1.37807	2
59	.64899	1.54085	.67409	1.48349	.69977	1.42903	.72610	1.37723	1
60	.64941	1.53986	.67451	1.48256	.70021	1.42815	.72654	1.37638	0
	Cotang	Tang	Cotang	Tang	Cotang	Tang	Cotang	Tang	
	57°		56°		55°		54°		

TABLE V.—NATURAL TANGENTS AND COTANGENTS.

°	36°		37°		38°		39°		°
	Tang	Cotang	Tang	Cotang	Tang	Cotang	Tang	Cotang	
0	.72654	1.37688	.75855	1.32704	.78129	1.27994	.80978	1.23949	60
1	.72699	1.37554	.75401	1.32824	.78175	1.27917	.81027	1.23416	59
2	.72743	1.37420	.75447	1.32544	.78222	1.27841	.81076	1.22883	58
3	.72788	1.37286	.75492	1.32464	.78269	1.27764	.81123	1.22350	57
4	.72832	1.37152	.75538	1.32384	.78316	1.27688	.81171	1.21816	56
5	.72877	1.37018	.75584	1.32304	.78363	1.27611	.81220	1.21283	55
6	.72921	1.36884	.75629	1.32224	.78410	1.27535	.81268	1.20750	54
7	.72966	1.36750	.75675	1.32144	.78457	1.27458	.81316	1.20217	53
8	.73010	1.36616	.75721	1.32064	.78504	1.27382	.81364	1.19684	52
9	.73055	1.36482	.75767	1.31984	.78551	1.27306	.81413	1.19151	51
10	.73100	1.36348	.75812	1.31904	.78598	1.27230	.81461	1.18618	50
11	.73144	1.36214	.75858	1.31825	.78645	1.27153	.81510	1.18085	49
12	.73189	1.36080	.75904	1.31745	.78692	1.27077	.81558	1.17552	48
13	.73234	1.35946	.75950	1.31666	.78739	1.27001	.81606	1.17019	47
14	.73278	1.35812	.75996	1.31586	.78786	1.26925	.81655	1.16486	46
15	.73323	1.35678	.76042	1.31507	.78834	1.26849	.81703	1.15953	45
16	.73368	1.35544	.76088	1.31427	.78881	1.26774	.81752	1.15420	44
17	.73413	1.35410	.76134	1.31348	.78928	1.26698	.81800	1.14887	43
18	.73457	1.35276	.76180	1.31269	.78975	1.26622	.81849	1.14354	42
19	.73502	1.35142	.76226	1.31190	.79022	1.26546	.81898	1.13821	41
20	.73547	1.35008	.76273	1.31110	.79070	1.26471	.81946	1.13288	40
21	.73592	1.34874	.76319	1.31031	.79117	1.26395	.81995	1.12755	39
22	.73637	1.34740	.76364	1.30952	.79164	1.26319	.82044	1.12222	38
23	.73681	1.34606	.76410	1.30873	.79212	1.26244	.82093	1.11689	37
24	.73726	1.34472	.76456	1.30794	.79259	1.26168	.82141	1.11156	36
25	.73771	1.34338	.76502	1.30715	.79306	1.26093	.82190	1.10623	35
26	.73816	1.34204	.76548	1.30636	.79354	1.26018	.82238	1.10090	34
27	.73861	1.34070	.76594	1.30557	.79401	1.25943	.82287	1.10557	33
28	.73906	1.33936	.76640	1.30478	.79449	1.25867	.82336	1.10024	32
29	.73951	1.33802	.76686	1.30400	.79496	1.25792	.82385	1.10491	31
30	.73996	1.33668	.76733	1.30321	.79544	1.25717	.82434	1.10958	30
31	.74041	1.33534	.76779	1.30242	.79591	1.25642	.82483	1.10425	29
32	.74086	1.33400	.76825	1.30163	.79639	1.25567	.82531	1.10892	28
33	.74131	1.33266	.76871	1.30084	.79686	1.25492	.82580	1.10359	27
34	.74176	1.33132	.76918	1.30005	.79734	1.25417	.82629	1.10826	26
35	.74221	1.32998	.76964	1.29926	.79781	1.25342	.82678	1.10293	25
36	.74267	1.32864	.77010	1.29847	.79829	1.25267	.82727	1.10760	24
37	.74312	1.32730	.77057	1.29768	.79877	1.25192	.82776	1.10227	23
38	.74357	1.32596	.77103	1.29689	.79924	1.25117	.82825	1.10694	22
39	.74402	1.32462	.77149	1.29610	.79972	1.25042	.82874	1.10161	21
40	.74447	1.32328	.77196	1.29531	.80020	1.24967	.82923	1.10628	20
41	.74492	1.32194	.77242	1.29452	.80067	1.24892	.82972	1.10095	19
42	.74538	1.32060	.77289	1.29373	.80115	1.24817	.83021	1.10562	18
43	.74583	1.31926	.77335	1.29294	.80163	1.24742	.83070	1.10029	17
44	.74628	1.31792	.77382	1.29215	.80211	1.24667	.83119	1.10496	16
45	.74674	1.31658	.77428	1.29136	.80258	1.24592	.83168	1.10963	15
46	.74719	1.31524	.77475	1.29057	.80306	1.24517	.83217	1.10430	14
47	.74764	1.31390	.77521	1.28978	.80354	1.24442	.83266	1.10897	13
48	.74810	1.31256	.77568	1.28899	.80402	1.24367	.83315	1.10364	12
49	.74855	1.31122	.77615	1.28820	.80450	1.24292	.83364	1.10831	11
50	.74900	1.30988	.77661	1.28741	.80498	1.24217	.83413	1.10298	10
51	.74946	1.30854	.77708	1.28662	.80546	1.24142	.83462	1.10765	9
52	.74991	1.30720	.77754	1.28583	.80594	1.24067	.83511	1.10232	8
53	.75037	1.30586	.77801	1.28504	.80642	1.23992	.83560	1.10699	7
54	.75082	1.30452	.77848	1.28425	.80690	1.23917	.83609	1.10166	6
55	.75128	1.30318	.77895	1.28346	.80738	1.23842	.83658	1.10633	5
56	.75173	1.30184	.77941	1.28267	.80786	1.23767	.83707	1.10100	4
57	.75219	1.30050	.77988	1.28188	.80834	1.23692	.83756	1.10567	3
58	.75264	1.29916	.78035	1.28109	.80882	1.23617	.83805	1.10034	2
59	.75310	1.29782	.78082	1.28030	.80930	1.23542	.83854	1.10501	1
60	.75355	1.29648	.78129	1.27951	.80978	1.23467	.83903	1.10968	0
	Cotang	Tang	Cotang	Tang	Cotang	Tang	Cotang	Tang	
	53°		52°		51°		50°		

TABLE V.—NATURAL TANGENTS AND COTANGENTS.

	40°		41°		42°		43°		
	Tang	Cotang	Tang	Cotang	Tang	Cotang	Tang	Cotang	
0	.83910	1.19176	.86929	1.15087	.90040	1.11061	.93253	1.07287	60
1	.83960	1.19105	.86980	1.14989	.90093	1.10996	.93306	1.07174	59
2	.84009	1.19035	.87031	1.14902	.90146	1.10931	.93360	1.07112	58
3	.84059	1.18964	.87082	1.14834	.90199	1.10867	.93415	1.07049	57
4	.84108	1.18894	.87133	1.14767	.90251	1.10802	.93469	1.06987	56
5	.84158	1.18824	.87184	1.14699	.90304	1.10737	.93524	1.06925	55
6	.84208	1.18754	.87236	1.14632	.90357	1.10672	.93578	1.06862	54
7	.84258	1.18684	.87287	1.14565	.90410	1.10607	.93633	1.06800	53
8	.84307	1.18614	.87338	1.14498	.90463	1.10543	.93688	1.06738	52
9	.84357	1.18544	.87389	1.14430	.90516	1.10478	.93742	1.06676	51
10	.84407	1.18474	.87441	1.14363	.90569	1.10414	.93797	1.06613	50
11	.84457	1.18404	.87492	1.14296	.90621	1.10349	.93852	1.06551	49
12	.84507	1.18334	.87543	1.14229	.90674	1.10285	.93906	1.06489	48
13	.84556	1.18264	.87595	1.14162	.90727	1.10220	.93961	1.06427	47
14	.84606	1.18194	.87646	1.14095	.90781	1.10155	.94016	1.06365	46
15	.84656	1.18124	.87698	1.14028	.90834	1.10091	.94071	1.06303	45
16	.84706	1.18055	.87749	1.13961	.90887	1.10027	.94125	1.06241	44
17	.84756	1.17986	.87801	1.13894	.90940	1.09963	.94180	1.06179	43
18	.84806	1.17916	.87852	1.13828	.90993	1.09899	.94235	1.06117	42
19	.84856	1.17846	.87904	1.13761	.91046	1.09834	.94290	1.06056	41
20	.84906	1.17777	.87955	1.13694	.91099	1.09770	.94345	1.05994	40
21	.84956	1.17708	.88007	1.13627	.91153	1.09706	.94400	1.05932	39
22	.85006	1.17638	.88059	1.13561	.91206	1.09642	.94455	1.05870	38
23	.85057	1.17569	.88110	1.13494	.91259	1.09578	.94510	1.05809	37
24	.85107	1.17500	.88162	1.13428	.91313	1.09514	.94565	1.05747	36
25	.85157	1.17430	.88214	1.13361	.91366	1.09450	.94620	1.05685	35
26	.85207	1.17361	.88265	1.13295	.91419	1.09386	.94675	1.05624	34
27	.85257	1.17292	.88317	1.13228	.91473	1.09322	.94731	1.05562	33
28	.85308	1.17223	.88369	1.13162	.91526	1.09258	.94786	1.05501	32
29	.85358	1.17154	.88421	1.13096	.91580	1.09195	.94841	1.05439	31
30	.85408	1.17085	.88473	1.13029	.91633	1.09131	.94896	1.05378	30
31	.85458	1.17016	.88524	1.12963	.91687	1.09067	.94952	1.05317	29
32	.85509	1.16947	.88576	1.12897	.91740	1.09003	.95007	1.05255	28
33	.85559	1.16878	.88628	1.12831	.91794	1.08940	.95062	1.05194	27
34	.85609	1.16809	.88680	1.12765	.91847	1.08876	.95118	1.05133	26
35	.85660	1.16741	.88732	1.12699	.91901	1.08813	.95173	1.05072	25
36	.85710	1.16672	.88784	1.12633	.91955	1.08749	.95229	1.05010	24
37	.85761	1.16603	.88836	1.12567	.92008	1.08686	.95284	1.04949	23
38	.85811	1.16535	.88888	1.12501	.92062	1.08622	.95340	1.04888	22
39	.85862	1.16466	.88940	1.12435	.92116	1.08559	.95395	1.04827	21
40	.85913	1.16398	.88992	1.12369	.92170	1.08496	.95451	1.04766	20
41	.85963	1.16329	.89045	1.12303	.92224	1.08432	.95506	1.04705	19
42	.86014	1.16261	.89097	1.12238	.92277	1.08369	.95562	1.04644	18
43	.86064	1.16192	.89149	1.12172	.92331	1.08306	.95618	1.04583	17
44	.86115	1.16124	.89201	1.12106	.92385	1.08243	.95673	1.04522	16
45	.86166	1.16056	.89253	1.12041	.92439	1.08179	.95729	1.04461	15
46	.86216	1.15987	.89306	1.11975	.92493	1.08116	.95785	1.04401	14
47	.86267	1.15919	.89358	1.11909	.92547	1.08053	.95841	1.04340	13
48	.86318	1.15851	.89410	1.11844	.92601	1.07990	.95897	1.04279	12
49	.86368	1.15783	.89463	1.11778	.92655	1.07927	.95952	1.04218	11
50	.86419	1.15715	.89515	1.11713	.92709	1.07864	.96008	1.04158	10
51	.86470	1.15647	.89567	1.11648	.92763	1.07801	.96064	1.04097	9
52	.86521	1.15579	.89620	1.11582	.92817	1.07738	.96120	1.04036	8
53	.86572	1.15511	.89672	1.11517	.92871	1.07676	.96176	1.03975	7
54	.86623	1.15443	.89725	1.11452	.92925	1.07613	.96232	1.03915	6
55	.86674	1.15375	.89777	1.11387	.92979	1.07550	.96288	1.03855	5
56	.86725	1.15308	.89830	1.11321	.93034	1.07487	.96344	1.03794	4
57	.86776	1.15240	.89883	1.11256	.93088	1.07425	.96400	1.03734	3
58	.86827	1.15172	.89935	1.11191	.93143	1.07362	.96457	1.03674	2
59	.86878	1.15104	.89988	1.11126	.93197	1.07299	.96513	1.03613	1
60	.86929	1.15037	.90040	1.11061	.93252	1.07237	.96569	1.03553	0
	Cotang	Tang	Cotang	Tang	Cotang	Tang	Cotang	Tang	
	49°		48°		47°		46°		

TABLE V.—NATURAL TANGENTS AND COTANGENTS.

	44°				44°				44°		
	Tang	Cotang			Tang	Cotang			Tang	Cotang	
0	.96569	1.08553	60	20	.97700	1.02855	40	40	.98848	1.01170	30
1	.96625	1.08498	59	21	.97756	1.02806	39	41	.98901	1.01112	19
2	.96681	1.08443	58	22	.97813	1.02758	38	42	.98958	1.01053	18
3	.96738	1.08387	57	23	.97870	1.02710	37	43	.99016	1.00994	17
4	.96794	1.08332	56	24	.97927	1.02662	36	44	.99073	1.00935	16
5	.96850	1.08276	55	25	.97984	1.02614	35	45	.99131	1.00876	15
6	.96907	1.08221	54	26	.98041	1.02566	34	46	.99189	1.00818	14
7	.96963	1.08165	53	27	.98098	1.02518	33	47	.99247	1.00759	13
8	.97020	1.08109	52	28	.98155	1.02470	32	48	.99304	1.00701	12
9	.97076	1.08053	51	29	.98213	1.02422	31	49	.99362	1.00642	11
10	.97133	1.08008	50	30	.98270	1.02374	30	50	.99420	1.00583	10
11	.97189	1.08002	49	31	.98327	1.02326	29	51	.99478	1.00525	9
12	.97246	1.08002	48	32	.98384	1.02278	28	52	.99536	1.00467	8
13	.97303	1.08002	47	33	.98441	1.02230	27	53	.99594	1.00408	7
14	.97359	1.08002	46	34	.98499	1.02182	26	54	.99652	1.00350	6
15	.97416	1.08002	45	35	.98556	1.02134	25	55	.99710	1.00291	5
16	.97473	1.08002	44	36	.98613	1.02086	24	56	.99768	1.00233	4
17	.97529	1.08002	43	37	.98671	1.02038	23	57	.99826	1.00175	3
18	.97586	1.08002	42	38	.98728	1.01990	22	58	.99884	1.00116	2
19	.97643	1.08002	41	39	.98786	1.01942	21	59	.99942	1.00058	1
20	.97700	1.08002	40	40	.98843	1.01894	20	60	1.00000	1.00000	0
	Cotang	Tang			Cotang	Tang			Cotang	Tang	
	45°				45°				45°		

TABLE VI.—LENGTHS OF CIRCULAR ARCS; RADIUS = 1.

Sec.	Length.	Min.	Length.	Deg.	Length.	Deg.	Length.
1	.0000048	1	.0002909	1	.0174533	61	1.0646508
2	.0000097	2	.0005818	2	.0349066	62	1.0631041
3	.0000145	3	.0008727	3	.0523600	63	1.0615574
4	.0000194	4	.0011636	4	.0698133	64	1.1170107
5	.0000242	5	.0014544	5	.0872665	65	1.1344640
6	.0000291	6	.0017453	6	.1047198	66	1.1519173
7	.0000339	7	.0020362	7	.1221730	67	1.1693706
8	.0000388	8	.0023271	8	.1396263	68	1.1868239
9	.0000436	9	.0026180	9	.1570796	69	1.2042772
10	.0000485	10	.0029089	10	.1745329	70	1.2217305
11	.0000533	11	.0031998	11	.1919862	71	1.2391838
12	.0000582	12	.0034907	12	.2094395	72	1.2566371
13	.0000630	13	.0037815	13	.2268928	73	1.2740904
14	.0000679	14	.0040724	14	.2443461	74	1.2915437
15	.0000727	15	.0043633	15	.2617994	75	1.3089970
16	.0000776	16	.0046542	16	.2792527	76	1.3264503
17	.0000824	17	.0049451	17	.2967060	77	1.3439036
18	.0000873	18	.0052360	18	.3141593	78	1.3613569
19	.0000921	19	.0055269	19	.3316126	79	1.3788102
20	.0000970	20	.0058178	20	.3490659	80	1.3962635
21	.0001018	21	.0061087	21	.3665192	81	1.4137168
22	.0001067	22	.0063995	22	.3839725	82	1.4311701
23	.0001115	23	.0066904	23	.4014257	83	1.4486234
24	.0001164	24	.0069813	24	.4188790	84	1.4660767
25	.0001212	25	.0072722	25	.4363323	85	1.4835300
26	.0001261	26	.0075631	26	.4537856	86	1.5009833
27	.0001309	27	.0078540	27	.4712389	87	1.5184366
28	.0001357	28	.0081449	28	.4886922	88	1.5358899
29	.0001406	29	.0084358	29	.5061455	89	1.5533432
30	.0001454	30	.0087266	30	.5235988	90	1.5707965
31	.0001503	31	.0090175	31	.5410521	91	1.5882498
32	.0001551	32	.0093084	32	.5585054	92	1.6057031
33	.0001600	33	.0095993	33	.5759587	93	1.6231564
34	.0001648	34	.0098902	34	.5934119	94	1.6406097
35	.0001697	35	.0101811	35	.6108652	95	1.6580630
36	.0001745	36	.0104720	36	.6283185	96	1.6755163
37	.0001794	37	.0107629	37	.6457718	97	1.6929696
38	.0001842	38	.0110538	38	.6632251	98	1.7104229
39	.0001891	39	.0113446	39	.6806784	99	1.7278762
40	.0001939	40	.0116355	40	.6981317	100	1.7453295
41	.0001988	41	.0119264	41	.7155850	101	1.7627828
42	.0002036	42	.0122173	42	.7330383	102	1.7802361
43	.0002085	43	.0125082	43	.7504916	103	1.7976894
44	.0002133	44	.0127991	44	.7679449	104	1.8151427
45	.0002182	45	.0130900	45	.7853982	105	1.8325960
46	.0002230	46	.0133809	46	.8028515	106	1.8500493
47	.0002279	47	.0136717	47	.8203048	107	1.8675026
48	.0002327	48	.0139626	48	.8377581	108	1.8849559
49	.0002376	49	.0142535	49	.8552114	109	1.9024092
50	.0002424	50	.0145444	50	.8726647	110	1.9198625
51	.0002473	51	.0148353	51	.8901179	111	1.9373158
52	.0002521	52	.0151262	52	.9075712	112	1.9547691
53	.0002570	53	.0154171	53	.9250245	113	1.9722224
54	.0002618	54	.0157080	54	.9424778	114	1.9896757
55	.0002666	55	.0159989	55	.9599311	115	2.0071290
56	.0002715	56	.0162897	56	.9773844	116	2.0245823
57	.0002763	57	.0165806	57	.9948377	117	2.0420356
58	.0002812	58	.0168715	58	1.0122910	118	2.0594889
59	.0002860	59	.0171624	59	1.0297443	119	2.0769422
60	.0002909	60	.0174533	60	1.0471976	120	2.0943955

TABLE VII.

MEAN REFRACTIONS IN DECLINATION.*

TO BE USED WITH THE SOLAR ATTACHMENT.

(Computed by Edward W. Arms, C. E., for W. & L. E. Gurley, Troy, N. Y.)

HOUR ANGLE.	DECLINATIONS.									
	FOR LATITUDE 2° 30'.									
	+20°	+15°	+10°	+5°	0°	-5°	-10°	-15°	-20°	
0 h.	-18"	-12"	-07"	-02"	+02"	07"	12"	18"	23"	
2	-18	-12	-07	-02	+02	07	12	18	23	
3	-17	-11	-06	-01	+03	08	13	19	25	
4	-15	-10	-05	0	+05	10	15	21	27	
5	-10	-05	0	+05	10	15	20	26	32	
FOR LATITUDE 5°.										
0 h.	-15"	-10"	-05"	0"	+05"	10"	15"	20"	27"	
2	-15	-10	-05	0	+05	10	15	20	27	
3	-13	-08	-03	+02	07	12	17	23	29	
4	-10	-05	0	+05	10	15	20	27	32	
5	-05	0	+05	10	15	20	27	32	40	
FOR LATITUDE 7° 30'.										
0 h.	-13"	-08"	-02"	+02"	08"	13"	18"	24"	29"	
2	-12	-07	-01	+03	09	14	19	25	31	
3	-10	-05	0	+05	10	15	20	26	32	
4	-05	0	+05	10	15	20	26	32	39	
5	+07	12	17	23	29	36	43	51	1'01"	
FOR LATITUDE 10°.										
0 h.	-10"	-05"	0"	+05"	10"	15"	20"	26"	32"	
2	-07	-03	+02	07	12	17	22	28	34	
3	-05	0	+03	08	13	19	25	31	38	
4	0	05	+10	15	20	26	32	39	46	
5	+15	20	26	32	39	46	55	1'06"	1'19"	
FOR LATITUDE 12° 30'.										
0 h.	-08"	-02"	+02"	8"	13"	18"	24"	30"	36"	
2	-06	00	+05	10	15	20	26	32	39	
3	+02	07	12	17	23	29	36	43	51	
4	04	09	14	20	25	31	40	48	56	
5	21	27	33	40	48	57	1'08"	1'23"	1'41"	
FOR LATITUDE 15°.										
0 h.	-05"	0"	+05"	10"	15"	21"	27"	33"	40"	
2	-03	+02	07	12	18	23	29	36	43	
3	+01	05	11	16	22	28	34	41	49	
4	08	12	19	24	30	37	44	53	1'04	
5	29	34	41	49	59	1'10	1'24	1'43	2 08	

* Printed by permission of W. & L. E. Gurley.

REFRACTIONS IN DECLINATION

HOUR ANGLE	DECLINATIONS.									
	FOR LATITUDE 17° 30'.									
	+20°	+18°	+10°	+5°	0°	-5°	-10°	-15°	-20°	
0 h.	-02"	+02"	08"	13"	18"	24"	30"	36"	44"	44"
2	0	05	10	15	21	27	33	40	48	48
3	+02	10	15	21	27	33	40	48	57	57
4	13	18	23	29	35	43	51	1'01	1'13	1'13
5	34	41	49	58	1'10	1'23	1'41	2 06	2 42	2 42
FOR LATITUDE 20°.										
0 h.	0"	05"	10"	15"	21"	27"	33"	40"	48"	48"
2	03	07	13	18	24	30	36	44	52	52
3	06	13	18	24	30	36	44	52	1'02	1'02
4	17	22	28	35	42	50	1'00	1'11	1 26	1 26
5	39	47	57	1'07	1'20	1'37	2 00	2 32	3 25	3 25
FOR LATITUDE 22° 30'.										
0 h.	02"	08"	13"	18"	24"	30"	36"	44"	52"	52"
2	06	11	15	21	27	33	40	48	57	57
3	11	15	21	27	33	40	48	57	1'08	1'08
4	20	26	32	39	46	56	1'07	1'19	1 37	1 37
5	45	53	1'08	1'16	1'31	1'52	2 21	3 07	4 28	4 28
FOR LATITUDE 25°.										
0 h.	05"	10"	15"	21"	27"	33"	40"	48"	57"	57"
2	08	14	19	25	31	38	46	54	1'05	1'05
3	12	18	24	30	37	44	53	1'04	1 18	1 18
4	23	29	35	45	53	1'03	1'16	1 31	1 52	1 52
5	49	59	1'10	1'24	1'52	2 07	2 44	3 46	5 43	5 43
FOR LATITUDE 27° 30'.										
0 h.	08"	13"	18"	24"	30"	36"	44"	52"	1'02"	1'02"
2	11	16	22	28	34	41	49	1'00	1 10	1 10
3	17	22	28	35	42	50	1'00	1 11	1 26	1 26
4	28	35	42	50	1'00	1'11	1 26	1 43	2 09	2 09
5	54	1'05	1'18	1'34	1 54	2 24	3 11	4 38	8 15	8 15
FOR LATITUDE 30°.										
0 h.	10"	15"	21"	27"	33"	40"	48"	57"	1'08"	1'08"
2	14	19	25	31	38	46	54	1'05	1 18	1 18
3	20	26	32	39	47	55	1'06	1 19	1 36	1 36
4	32	39	46	52	1'06	1'19	1 35	1 57	2 29	2 29
5	1'00	1'10	1'24	1'52	2 07	2 44	3 46	5 43	13'06	13'06
FOR LATITUDE 32° 30'.										
0 h.	13"	18"	24"	30"	36"	44"	52"	1'02"	1'14"	1'14"
2	17	22	28	35	42	50	1'00	1 11	1 26	1 26
3	23	29	35	43	51	1'01	1 13	1 28	1 47	1 47
4	35	43	51	1'01	1'13	1 27	1 46	2 13	2 54	2 54
5	1'03	1'15	1'31	1 53	2 20	3 05	4 25	7 36		

HOUR ANGLE		DECLINATIONS.								
		FOR LATITUDE 35°.								
		+20°	+15°	+10°	+5°	0°	-5°	-10°	-15°	-20°
0 h.	15"	21"	27"	33"	40"	48"	57"	1'08"	1'21"	
1	20	25	32	38	46	55	1'05	1'18	1'35	
2	26	33	39	47	56	1'07	1'21	1'38	2'00	
3	39	47	56	1'07	1'20	1'36	1'59	2'32	3'25	
4	1'07	1'20	1'38	2'00	2'34	3'29	5'14	10'16		
FOR LATITUDE 37° 30'.										
0 h.	18"	24"	30"	36"	44"	52"	1'02"	1'14"	1'29	
1	22	28	35	42	50	1'00	1'12	1'26	1'45	
2	29	36	43	52	1'02	1'14	1'29	1'49	2'16	
3	43	51	1'01	1'13	1'27	1'49	2'14	2'54	4'05	
4	1'11	1'26	1'54	2'10	2'49	3'55	6'15	14'58		
FOR LATITUDE 40°.										
0 h.	21"	27"	33"	40"	48"	57"	1'08"	1'21"	1'39"	
1	25	32	39	46	52	1'06	1'19	1'35	1'57	
2	33	40	48	57	1'08	1'21	1'38	2'02	2'36	
3	47	55	1'06	1'19	1'36	1'58	2'30	3'21	4'59	
4	1'15	1'31	1'51	2'20	3'05	4'25	7'34	25'18		
FOR LATITUDE 42° 30'.										
0 h.	24"	30"	36"	44"	52"	1'02"	1'14"	1'29"	1'49"	
1	28	35	39	50	1'00	1'12	1'26	1'45	2'11	
2	36	43	52	1'02	1'13	1'29	1'49	2'17	2'59	
3	50	1'00	1'11	1'26	1'44	2'10	2'49	3'55	6'16	
4	1'19	1'36	1'58	2'30	3'22	5'00	9'24			
FOR LATITUDE 45°.										
0 h.	27"	33"	40"	48"	57"	1'08"	1'21"	1'39"	2'02"	
1	32	39	46	52	1'06	1'19	1'35	1'57	2'29	
2	40	47	56	1'07	1'21	1'38	2'00	2'34	3'29	
3	54	1'04	1'16	1'33	1'54	2'24	3'11	4'38	8'15	
4	1'23	1'41	2'05	2'41	3'40	5'40	12'02			
FOR LATITUDE 47° 30'.										
0 h.	30"	36"	44"	52"	1'02"	1'14"	1'29"	1'49"	2'18"	
1	35	42	50	1'00	1'12	1'26	1'45	2'01	2'51	
2	43	51	1'01	1'13	1'28	1'47	2'15	2'56	4'08	
3	56	1'09	1'23	1'40	2'05	2'40	3'39	5'37	11'18	
4	1'27	1'46	2'12	2'52	4'01	6'30	16'19			
FOR LATITUDE 50°.										
0 h.	33"	40"	48"	57"	1'08"	1'21"	1'39"	2'02"	2'36"	
1	38	46	55	1'06	1'18	1'35	1'57	2'28	3'19	
2	47	56	1'06	1'19	1'36	2'29	2'31	3'23	5'02	
3	1'02	1'14	1'29	1'48	2'16	2'58	4'18	6'59	19'47	
4	1'30	1'51	2'19	3'04	4'22	7'28	24'10			

REFRACTIONS IN DECLINATION

H OR ANGLE		DECLINATIONS.								
		FOR LATITUDE 52° 30'.								
		+20"	+18"	+10"	+8"	0"	-8"	-10"	-18"	-20"
0 h.	36"	44"	52"	1'02"	1'14"	1'29"	1'49"	2'18"	3'05"	
2	43	50	59	1 11	1 26	1 42	2 23	2 49	3 55	
3	50	1'00	1'11	1 26	1 45	2 11	2 51	2 58	6 22	
4	1'05	1 18	1 35	2 10	2 28	3 19	4 53	8 42		
5	1 34	1 56	2 27	3 16	4 47	8 52				
		FOR LATITUDE 55°.								
0 h.	40"	48"	57"	1'08"	1'21"	1'39"	2'02"	2'36"	3'33"	
2	46	55	1'05	1 18	1 34	1 56	2 30	3 15	4 47	
3	55	1'06	1 19	1 35	1 58	2 30	3 21	4 58	9 19	
4	1'10	1 23	1 42	2 08	2 43	3 44	5 49	12 41		
5	1 37	2 01	2 34	3 28	5 15	10 18				
		FOR LATITUDE 57° 30'.								
0 h.	44"	52"	1'02"	1'14"	1'29"	1'49"	2'18"	3'05"	4'37"	
2	50	59	1 11	1 25	1 43	2 09	2 47	3 51	6 04	
3	58	1'10	1 24	1 42	2 07	2 43	3 45	5 50	12 47	
4	1'11	1 25	1 43	2 10	2 50	3 55	6 14	14 49		
5	1 41	2 06	2 42	3 42	5 46	12 28				
		FOR LATITUDE 60°.								
0 h.	48"	57"	1'08"	1'21"	1'39"	2'02"	2'36"	3'33"	5'23"	
2	54	1'04	1 17	1 33	1 54	2 24	3 12	4 38	8 15	
3	1'03	1 15	1 30	1 51	2 20	3 04	4 24	7 31	24 44	
4	1 18	1 34	1 56	2 28	3 18	4 50	8 53			
5	1 45	2 11	2 50	3 57	6 21	15 32				
		FOR LATITUDE 62° 30'.								
0 h.	52"	1'02"	1'14"	1'29"	1'50"	2'18"	3'00"	4'17"	7'13"	
2	58	1'09	1 23	1 41	2 06	2 43	3 44	5 50	12 44	
3	1'07"	1 23	1 38	2 01	2 35	3 30	5 16	10 24		
4	1 23	1 40	2 05	2 40	3 40	5 37	11 50			
5	1 48	2 17	2 59	4 14	7 03					
		FOR LATITUDE 65°.								
0 h.	57"	1'08"	1'21"	1'39"	2'02"	2'36"	3'33"	5'23"	10'51"	
2	1'03"	1 16	1 31	1 52	2 21	3 07	4 28	7 44		
3	1 12	1 27	1 46	2 12	2 52	4 02	6 33			
4	1 27	1 47	2 13	2 54	4 05	6 40				
5	1 52	2 22	3 08	4 30	7 52					
		FOR LATITUDE 67° 30'.								
0 h.	1'02"	1'14"	1'29"	1'50"	2'18"	3'00"	4'17"	7'13"		
2	1 08	1 22	1 40	2 03	2 39	3 37	5 32	11 28		
3	1 17	1 34	1 55	2 26	3 14	4 44	8 34			
4	1 32	1 53	2 23	3 14	4 35	8 05				
5	1 56	2 28	3 17	4 40	8 51					
		FOR LATITUDE 70°.								
0 h.	1'08"	1'21"	1'39"	2'02"	2'36"	3'33"	5'23"	10'51"		
2	1 14	1 29	1 50	2 18	3 00	4 17	7 13			
3	1 23	1 43	2 05	2 41	3 41	5 59	12 15			
4	1 37	2 00	2 34	3 28	5 20	10 12				
5	2 02	2 33	3 27	5 11	10 05					

TABLE VIII. TRIGONOMETRIC AND MISCELLANEOUS FORMULAS.

 <p style="text-align: center;">RIGHT TRIANGLE</p>	 <p style="text-align: center;">OBLIQUE TRIANGLE</p>	
SOLUTION OF RIGHT TRIANGLES.		
$\sin A = \frac{a}{c} = \cos B$	$\cos A = \frac{b}{c} = \sin B$	
$\tan A = \frac{a}{b} = \cot B$	$\cot A = \frac{b}{a} = \tan B$	
$\sec A = \frac{c}{b} = \operatorname{cosec} B$	$\operatorname{cosec} A = \frac{c}{a} = \sec B$	
$\operatorname{vers} A = \frac{c-b}{c} = \frac{d}{c}$	$\operatorname{exsec} A = \frac{e}{c}$	
$a = c \sin A = b \tan A = c \cos B = b \cot B = \sqrt{(c+b)(c-b)}$ $b = c \cos A = a \cot A = c \sin B = a \tan B = \sqrt{(c+a)(c-a)} = c - c \operatorname{vers} A$ $d = c \operatorname{vers} A$ $e = c \operatorname{exsec} A$		
$c = \frac{a}{\cos B} = \frac{b}{\sin B} = \frac{a}{\sin A} = \frac{b}{\cos A} = \frac{d}{\operatorname{vers} A} = \frac{e}{\operatorname{exsec} A} = b + b \operatorname{exsec} A$		
SOLUTION OF OBLIQUE TRIANGLES.		
Given.	Sought.	Formulas.
A, B, a	b, c	$b = \frac{a}{\sin A} \cdot \sin B, \quad c = \frac{a}{\sin A} \sin(A+B)$
A, a, b	B, c	$\sin B = \frac{\sin A}{a} \cdot b, \quad c = \frac{a}{\sin A} \cdot \sin C$
C, a, b	$A - B$	$\tan \frac{1}{2}(A - B) = \frac{a-b}{a+b} \tan \frac{1}{2}(A + B)$
a, b, c	A	If $s = \frac{1}{2}(a + b + c), \sin \frac{1}{2} A = \sqrt{\frac{(s-b)(s-c)}{bc}}$ $\cos \frac{1}{2} A = \sqrt{\frac{s(s-a)}{bc}}; \tan \frac{1}{2} A = \sqrt{\frac{(s-b)(s-c)}{s(s-a)}}$ $\sin A = \frac{2\sqrt{s(s-a)(s-b)(s-c)}}{bc};$ $\operatorname{vers} A = \frac{2(s-b)(s-c)}{bc}$
A, B, C, a	area	$\text{area} = \sqrt{s(s-a)(s-b)(s-c)}$
C, a, b	area	$\text{area} = \frac{a^2 \sin B \cdot \sin C}{2 \sin A}$ $\text{area} = \frac{1}{2} ab \sin C$

TABLE VIII. TRIGONOMETRIC AND MISCELLANEOUS FORMULAS.

GENERAL TRIGONOMETRIC FORMULAS.

$$\sin A = 2 \sin \frac{1}{2} A \cos \frac{1}{2} A = \sqrt{1 - \cos^2 A} = \tan A \cos A = \sqrt{\frac{1}{2}(1 - \cos 2A)}$$

$$\cos A = 2 \cos^2 \frac{1}{2} A - 1 = 1 - 2 \sin^2 \frac{1}{2} A = \cos^2 \frac{1}{2} A - \sin^2 \frac{1}{2} A = 1 - \text{vers } A$$

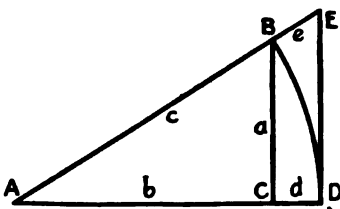
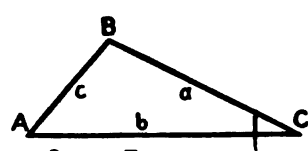
$$\tan A = \frac{\sin A}{\cos A} = \frac{\sqrt{1 - \cos^2 A}}{\cos A} = \frac{\sin 2A}{1 + \cos 2A}$$

$$\cot A = \frac{\cos A}{\sin A} = \frac{\sin 2A}{1 - \cos 2A} = \frac{\sin 2A}{\text{vers } 2A}$$

$$\text{vers } A = 1 - \cos A = \sin A \tan \frac{1}{2} A = 2 \sin^2 \frac{1}{2} A$$

$$\text{exsec } A = \sec A - 1 = \tan A \tan \frac{1}{2} A = \frac{\text{vers } A}{\cos A}$$

$$\sin 2A = 2 \sin A \cos A$$

$$\cos 2A = 2 \cos^2 A - 1 = \cos^2 A - \sin^2 A = 1 - 2 \sin^2 A$$

$$\tan 2A = \frac{2 \tan A}{1 - \tan^2 A}$$

$$\cot 2A = \frac{\cot^2 A - 1}{2 \cot A}$$

$$\text{vers } 2A = 2 \sin^2 A = 2 \sin A \cos A \tan A$$

$$\text{exsec } 2A = \frac{2 \tan^2 A}{1 - \tan^2 A}$$

$$\sin^2 A + \cos^2 A = 1$$

$$\sin(A \pm B) = \sin A \cos B \pm \sin B \cos A$$

$$\cos(A \pm B) = \cos A \cos B \mp \sin A \sin B$$

$$\sin A + \sin B = 2 \sin \frac{1}{2}(A+B) \cos \frac{1}{2}(A-B)$$

$$\sin A - \sin B = 2 \cos \frac{1}{2}(A+B) \sin \frac{1}{2}(A-B)$$

$$\cos A + \cos B = 2 \cos \frac{1}{2}(A+B) \cos \frac{1}{2}(A-B)$$

$$\cos B - \cos A = 2 \sin \frac{1}{2}(A+B) \sin \frac{1}{2}(A-B)$$

$$\sin^2 A - \sin^2 B = \cos^2 B - \cos^2 A = \sin(A+B) \sin(A-B)$$

$$\cos^2 A - \sin^2 B = \cos(A+B) \cos(A-B)$$

$$\tan A + \tan B = \frac{\sin(A+B)}{\cos A \cos B}$$

$$\tan A - \tan B = \frac{\sin(A-B)}{\cos A \cos B}$$

TABLE IX. CIRCULAR CURVE FORMULAS

R = Radius	M = Middle Ordinate
I = Central Angle	L_c = Length of Arc
T = Tangent Distance	C = Chord
E = External Distance	t = Tangent Offset

$T = R \tan \frac{1}{2} I$	$L_c - C = \frac{C^3}{24R^2}$ (Approximate)
$E = R \operatorname{exsec} \frac{1}{2} I$	$M = R - \sqrt{R^2 - \left(\frac{C}{2}\right)^2}$
$M = R \operatorname{vers} \frac{1}{2} I$	$M = \frac{C^2}{8R}$ (Approximate)
$C = 2R \sin \frac{1}{2} I$	$t = \frac{C^2}{2R}$
$L_c = R \times \text{Circular Measure } I.$	

TABLE X. GEOMETRIC FORMULAS.

Required.	Given.	Formulas.
Area of		
Circle	Radius = r	πr^2
Sector of Circle	Radius = r , Arc = L_c	$\frac{rL_c}{2}$
Segment of Circle	Chord = C , Middle Ordinate = M	$\frac{1}{2} CM$ (Approximate)
Ellipse	Semi-axes = a and b	πab
Surface of		
Cone	Radius of Base = r ; Slant Height = s	πrs
Cylinder	Radius = r , Height = h	$2\pi rh$
Sphere	Radius = r	$4\pi r^2$
Zone	Radius of Sphere = r , Height of Zone = h	$2\pi rh$
Volume of		
Prism or Cylinder	Area of Base = b ; Height = h	bh
Pyramid or Cone	Area of Base = b ; Height = h	$\frac{bh}{3}$
Frustum of Pyramid or Cone	Area of bases = b and b' ; Height = h	$\frac{h}{3}(b + b' + \sqrt{bb'})$
Sphere	Radius = r	$\frac{4}{3}\pi r^3$

TABLE XI. LINEAR MEASURE.

1 foot = 12 inches
 1 yard = 3 feet
 1 rod = $5\frac{1}{2}$ yards = $16\frac{1}{2}$ feet
 1 mile = 320 rods = 1760 yards = 5280 feet

TABLE XII. SQUARE MEASURE.

1 sq. foot = 144 sq. inches
 1 sq. yard = 9 sq. feet = 1296 sq. inches
 1 sq. rod = $30\frac{1}{4}$ sq. yards = $272\frac{1}{4}$ sq. feet
 1 acre = 160 sq. rods = 4840 sq. yards = 43,560 sq. feet
 1 sq. mile = 640 acres = 102,400 sq. rods = 27,878,400 sq. feet

TABLE XIII. LINEAR MEASURE—METRIC SYSTEM.

1 myriameter = 10 kilometers
 1 kilometer = 10 hectometers
 1 hectometer = 10 decameters
 1 decameter = 10 meters
 1 meter = 10 decimeters
 1 decimeter = 10 centimeters
 1 centimeter = 10 millimeters

TABLE XIV. SQUARE MEASURE—METRIC SYSTEM.

1 centare = 1 sq. meter
 1 are = 100 sq. meters
 1 hectare = 100 ares = 10,000 sq. meters

TABLE XV. CONSTANTS.

	Number.	Logarithm.
Ratio of circumference to diameter	3.14159	0.49715
Base of hyperbolic logarithms	2.71828	0.43429
Modulus of common system of logs	0.43429	9.63778-10
Length of seconds pendulum at N. Y. (inches)	39.1017	1.59220
Acceleration due to gravity at N. Y.	32.15949	1.50731
Cubic inches in 1 U. S. gallon	231	2.36361
Cubic feet in 1 U. S. gallon	0.1337	9.12613-10
U. S. gallons in 1 cubic foot	7.4805	0.87393
Pounds of water in 1 cubic foot	62.5	1.79588
Pounds of water in 1 U. S. gallon	8.355	0.92195
Pounds per square inch due to 1 atmosphere	14.7	1.16732
Pounds per square inch due to 1 foot head of water	0.434	9.63749-10
Feet of head for pressure of 1 pound per square inch	2.304	0.36248
Inches in 1 centimeter	0.3937	9.59517-10
Centimeters in 1 inch	2.5400	0.40483
Feet in 1 meter	3.2808	0.51598
Meters in 1 foot	0.3048	9.48402-10
Miles in 1 kilometer	0.62137	9.79335-10
Kilometers in 1 mile		
Square inches in 1 square centimeter	0.1550	9.19033-10
Square centimeters in 1 square inch	6.4520	0.80969
Square feet in 1 square meter	10.764	1.03197
Square meters in 1 square foot	0.09290	8.96802-10
Cubic feet in 1 cubic meter	35.3156	1.54797
Pounds (av.) in 1 kilogram	2.2046	0.34333
Kilograms in 1 pound (av.)	0.4536	9.65667-10
Ft.-lbs. in 1 kilogram-meter	7.23308	0.85932

APPROXIMATE VALUES OF SINES.

$$\text{Natural sine of } 1^\circ = \frac{1.75 \text{ ft.}}{100 \text{ ft.}} = \frac{1}{60} \text{ (roughly)}$$

$$\text{Natural sine of } 0^\circ 1' = \frac{0.03 \text{ ft.}}{100 \text{ ft.}}$$

$$\text{Natural sine of } 0^\circ 00' 01'' = \frac{0.3 \text{ inch}}{1 \text{ mile}}$$

GREEK ALPHABET.

LETTERS	NAME
A, α,	Alpha
B, β,	Beta
Γ, γ,	Gamma
Δ, δ,	Delta
E, ε,	Epsilon
Z, ζ,	Zeta
H, η,	Eta
Θ, θ,	Theta
I, ι,	Iota
K, κ,	Kappa
Λ, λ,	Lambda
M, μ,	Mu
N, ν,	Nu
Ξ, ξ,	Xi
O, ο,	Omicron
Π, π,	Pi
P, ρ,	Rho
Σ, σ, ς,	Sigma
T, τ,	Tau
Υ, υ,	Upsilon
Φ, φ,	Phi
X, χ,	Chi
Ψ, ψ,	Psi
Ω, ω,	Omega

INDEX.

- Abbreviations in notes, 113.
 Abney level and clinometer, 293.
 Abscissa, 256
 Accidental errors, 14.
 Accumulative errors, 14.
 Accuracy,
 in measuring lines, 12.
 of measurements, 14.
 of traverses, 111.
 Acre, 3.
 Additions, to blue prints, 396.
 Adit, 285.
 Adjusting screws, 25.
 Adjustment,
 of chain, 4.
 of compass, 25.
 of dumpy level, 91.
 of level, 88.
 bubble, 89.
 cross-hairs, 88.
 direct method, 91.
 indirect method, 89.
 peg method, 91.
 wyes, 90.
 of Locke level, 93.
 of solar attachment, 70.
 of transit, 56.
 bubble, 56.
 collimation, 58.
 cross-hairs, 57.
 long bubble on telescope, 59.
 objective slide, 60.
 standards, 59.
 of traverses, 358, 364.
 angles, 333.
 Agonic line, 25.
 Alignment, 8, 11, 13.
 Allen, C. F., 235, 342.
 Almanac, Nautical, 68, 184, 188.
 Altitude, of sun, 69, 190, 193.
 American Ephemeris (see almanac).
 Angles,
 brass, 83.
 calculated from bearings, 30.
 doubling, 108.
 deflection, 108.
 horizontal, 47.
 interior, 108.
 laying off, 50.
 measured by repetition, 48.
 parallel lines, 102.
 vertical, 54.
 Angular,
 convergence of meridians, 129, 154.
 value of one division of level, 73.
 Annual variation, 20.
 Apparent,
 motion of heavenly bodies, 180.
 declination of sun, 195.
 Apex,
 of vein, 285.
 staking out, 316.
 Approximate times of culmination and elonga-
 tion of Polaris, 186.
- Areas,**
 averaging end, 344.
 computation of,
 by double meridian distances, 352.
 by double parallel distances, 359.
 by offsets, 333.
 by Simpson's one-third rule, 334.
 by trapezoidal rule, 334.
 by triangles, 336.
 coordinates, 374.
 curved corner lot, 338.
 quadrilateral, 337.
 Arrangement of computations, 330.
Astronomy,
 observation for,
 azimuth, 180.
 latitude, 196.
Atmosphere, refraction, "boiling of," 87.
Attachment,
 for plumbing rods, 82.
 solar, 65.
Attraction, local magnetic, 29.
Aurora Borealis, 25.
Automatic tide gauge, 213.
Auxiliary level, 59.
Averaging end areas, 344.
Axe, 19.
Axis,
 polar, 65.
 adjustment of, 70.
Azimuth,
 angles, 17, 108.
 assumed, 109.
 at any hour, 188.
 in city triangulation, 262.
 needle checks on, 110.
 of line, 17.
 of Polaris, 183.
 to distant object, 372.
- Back,**
 bearing, 19.
 ground, 52.
 sight, 51, 86.
Balancing surveys, 358, 364.
Ball and socket joint, 16, 32.
Baltimore triangulation, 258.
Base, 200.
 board, 106.
 line, 122, 124, 261.
Batterboards, 253.
Bauer, L. A., 20.
Beam compass, 386.
Bearings, 16.
 method of taking, 18.
 reverse, 19.
Bed of stream, ownership, 118.
Bench, 202.
 marks, 202.
 establishing, 198.
 in cities, 226.
Bent,
 needle, 26.
 pivot, 27.

- Bisection,
 method, 172.
 target, 80.
 Black prints, 393.
 Blazing trees, 107, 130.
 Blue prints, 391.
 Blocks,
 irregular, 247.
 size of, 222.
 "Boiling" of atmosphere, 87.
 Border lines, 427.
 Bore holes, 307, 315.
 Borrow pits, 210, 343.
 Boston rod, 78.
 Boundaries,
 of land
 conventional sign for, 419.
 disputed, 117.
 identification, 106, 116.
 irregular, 105.
 relocating, 118.
 Bounds,
 control, 116.
 stone, 230.
 Breast, 301.
 Bubbles,
 levels, construction of vial, 72.
 angular value, one division, 73.
 Buildings, location of, 159, 168.
 Bulletin of University of Wisconsin, 69.
 Bureau of Equipment, Navy, 184.
 Bureau of Standards, 217.
 Burnt sienna, 396.

 Calculated bearings, 110.
 Calculating angles from bearings, 29.
 Calculation (see computation).
 Camel's-hair brush, 61, 391.
 Capstan-head screw, 36.
 Card, for sighting, 52.
 Care of instruments, 61.
 Carrying the transit, 62.
 Cassiopeia, 182.
 Catenary, 13.
 Celestial sphere, 65, 180.
 Cellar, excavation, 343.
 Centering pivot point, 27.
 Chaining,
 method of, 7.
 on slopes, 9.
 Chains,
 Gunter's, 3, 99.
 engineer's, 3.
 testing, 4.
 wearing, 14.
 Chain surveying, 106.
 Chainmen, 7, 11.
 Change, magnetic, 20, 119.
 Chart, isogonic, 22.
 Checking,
 angles, 110.
 azimuths, 109.
 bench marks, 199.
 buildings, 160.
 computation, 330, 337, 339.
 distances, 8, 11.
 field work, 109.
 lots, city, 249.
 target reading, 84.
 traverses, 100, 102, 105, 111, 156.
 traverses not closed, 156.
 Chinese white, 396.
 Chords, plotting by, 408.
 Circular curve, 233.
 City surveys, 216.

 City surveys (Continued)
 blocks, 222, 247.
 contour map, 219.
 datum, 226.
 laying out town site, 219, 227, 232.
 location of streets, 220.
 marking corners, 230.
 monuments, 228.
 permanent bench works, 226.
 plans, 255.
 provision for growth, 219.
 sewer system, 227.
 staking out, 251.
 standard, 218.
 steel tapes, 216.
 streets, 219, 251, 252.
 cross-section, 243, 246.
 curb lines, 249.
 grades, 224, 241, 252.
 gutters, 244.
 location, 220.
 width, 222.
 Claims, mining, 313.
 Clamps, 32.
 Clearing drawings, 430.
 Clinometer, 293, 316.
 Clips, 89.
 Closure, error of, 99.
 limits, public lands, 141.
 Cloth tape, 5.
 Coast and Geodetic Survey, 20, 22, 25, 77, 82,
 119, 184, 202.
 Coefficient of expansion, steel, 13.
 Co-latitude, 67.
 Collimators, 58.
 Compass, beam, 386.
 box, 16.
 Compass,
 surveyor's, 16.
 adjustments, 25.
 reading bearings, 18.
 remagnetizing, 28.
 running traverse with, 99.
 pocket (compass), 18.
 prismatic (compass), 18.
 Compartment, 285.
 Compensating errors, 14.
 Comstock's refraction formula, 69.
 Computations,
 area, 334.
 arrangement of, 330.
 book, 330.
 borrow pits, 342.
 checks, 330.
 coordinates, 373.
 deflection angles, 341.
 estimates, 345, 349.
 logarithmic, 327.
 preparing notes for, 333.
 prismoids, 344.
 short cuts, 328.
 significant figures, 323.
 slide rule, 330.
 triangulation, 372.
 volumes, 342.
 Concrete, 231.
 Connecting surface with underground, 298.
 Constellations, 181.
 Contour, 265, 410.
 found by cross-sections, 276.
 incorrectly sketched, 276.
 interpolated, 276.
 locating, 278.
 locating by hand level, 279.
 maps, 270.

- Contour (Continued)
 pen, 386.
 problem, 287.
 properties of, 268.
 Contracts, 121, 128.
 Control by triangulation, 256, 264.
 Conventional signs, 417, 419.
 Convergence of meridians, 121, 129, 154.
 Cooley, Chief Justice, 118.
 Coordinates,
 area by, 374.
 calculation, 373.
 plotting by, 401.
 system for cities, 255.
 Copying notes, 432.
 Copying plans, 385, 391.
 Corners,
 locating and marking, 106, 147.
 monuments, 228, 147.
 section, 123.
 selecting, 106.
 Correction,
 line, 123.
 triangle, 370.
 Corrections,
 for refraction,
 in altitude, 193.
 in declination, 60.
 on slopes, 3, 13, 217, 330.
 Counting, chain lengths, 8.
 Counterweight, on needle, 19.
 Courts, 117.
 Cross-cuts, 285.
 Cross-hairs, 34, 36.
 illuminating, 182.
 Cross-section,
 areas of, 344.
 contours determined by, 276.
 for earthwork, 207.
 paper, 390.
 road, 207.
 Crow foot, 108, 113.
 Crown, glass, 36.
 of pavements, 244.
 Culmination of Polaris, 180.
 Cultivated lands, conventional sign, 417.
 Cumulative errors, 14.
 Curb lines, 249.
 Currents, electric, 19, 311.
 Curvature and refraction, 3, 87.
 Curves,
 laying out, 234.
 principles, 233.
 street corners, 239.
 vertical, 242.
 Cut, 208.
 Cut-off line, 111, 157, 371.
 Daily, variation of needle, 20.
 Dam, 273.
 Dark glass, 190.
 Data,
 to be noted (public lands), 139.
 missing, 366.
 Datum plane, 198, 226.
 establishing, 211.
 Day, civil and astronomical, 187.
 Decimals of foot in inches, 6.
 Decimal division of vernier, 44.
 Declination,
 of needle, 19, 119.
 variation, 20, 119.
 daily, 20.
 secular, 20.
 irregular, 20.
 Declination (Continued)
 determination by observation, 25.
 of sun, 68, 194.
 correction for refraction, 193.
 Deed,
 description, 115.
 interpretation, 117.
 looking up, 120.
 recording, 120.
 survey for, 114.
 Deflection angles, 110, 234, 407.
 Degree of longitude, length of, 155.
 Delicacy of level, 72.
 Departure,
 computation of, 353.
 total, 401.
 Depth, cut or fill, 208.
 Detecting local attraction, 29.
 Dial, miner's, 287.
 Difference in elevation, 85.
 Differential leveling, 85.
 Dip of needle, 19.
 of vein, 285.
 Direct, adjustment, 91.
 position of instrument, 34.
 Direction,
 measurement of, 16.
 Discharge of streams, 310.
 measurement, 310.
 miner's inch, 310.
 Distances,
 with chain, 7.
 with stadia, 6.
 with tape, 10.
 between end points, 371.
 on slope, 13, 217, 333.
 Distant object, checking angles, 158.
 Disturbed corners, 232.
 Dividers,
 proportional, 387.
 Division of land, 368.
 Division of level tube, 73.
 Double area, 355.
 meridian distance, 355.
 rodded lines, 201.
 verniers, 39.
 Doubling angles, 50, 156.
 Drafts in shaft, 296.
 Drafting instruments, 381.
 Drainage,
 area, 219, 273.
 provision for, 220, 227.
 Drawing paper, 388.
 Drift, 286.
 Drill-hole, 229, 300.
 Drying prints, 392, 393.
 Dumpty level, 74.
 adjustment of, 91.
 Duty of surveyor, 116.
 Earth,
 curvature, 3, 87.
 magnetism, 19.
 Earthwork,
 computation, 342.
 end area method, 344.
 estimate of from contour map, 345, 349.
 prismoidal formula, 344.
 Easting, 352.
 Eccentric bearing telescope, 290.
 Eccentricity,
 of circles, 44.
 Economic principles, mining, 316.
 Effect of sag, 13.
 Elaborate, titles, etc., 427.

- Electric current, 19.
 Electric printing frame, 305.
 Electrification, compass cover, 18.
 Elevation,
 difference of, 85.
 Elimination of errors, 61, 87, 183, 200.
 Elongation,
 azimuth at, 181.
 of Polaris, times of, 186.
 meridian observation at, 182.
 Embankment, 208.
 End area method, 344.
 Engineer's,
 chain, 3, 4.
 scale, 387.
 transit, 34.
 Enlarging plans, 385.
 Ephemeris, 68, 184, 188.
 Equal backsights and foresights, 87.
 Equation of time, 196.
 Equator, 66.
 Erecting eyepiece, 37.
 Errors,
 accidental, 14.
 amount of, 12.
 cumulative, 14.
 compensating, 14.
 in compass work, 28.
 in measuring lines, 11.
 in tape, 11.
 in use of level, 94.
 in use of transit, 62.
 of adjustment, 61.
 elimination of, 61, 87.
 of closure, 99.
 of graduation, 49, 61.
 Establishing corners, 130.
 Estimates, earthwork, 345.
 Etched, marks on tape, 5.
 European surveys, 82.
 Excavation, 208.
 Expansion,
 coefficient of steel, 13.
 of paper, 428.
 Exterior, township, 127.
 External secant, 329.
 Extralateral rights, 314.
 Eyepiece, erecting and inverting, 37.

 Farm surveys, 99.
 Farnham, I. T., 239.
 Federal laws, mining, 313.
 Fences,
 measurement of, 110.
 conventional signs, 419.
 Field,
 book (see notes)
 checks, 109.
 methods, 101.
 notes, Pub. Lands, 142, 146.
 Land Surveying, 100, 103.
 Leveling, 200, 204.
 Topographical, 266.
 work, 99.
 Figures, significant, 323.
 Filing,
 drawings, 415.
 note-books, 431.
 Fill, 208.
 Finding, lost corners, 116.
 Finishing nail, 300.
 Floats, 52, 310.
 Flow,
 of streams, 310.
 miner's inch, 310.

 Focus, principal, 35.
 Focusing, 35.
 "Folding" vernier (Fig. 26), 43.
 Foresights, 51, 52, 53, 86, 87.
 Formulas,
 area by coordinates, 374.
 area of triangle, 336, 337.
 area curved corner lot, 338.
 azimuth by Polaris, 183, 187.
 azimuth by sun, 190, 194.
 convergence of meridians, 154.
 cross-section of street, 244.
 curves, 233.
 prismoid, 344.
 sag and alignment, 13.
 Simpson's rule, 334.
 side and top telescope, 208.
 tangent offset and middle ordinate, 339.
 trapezoid, 334.
 Fractional areas, 335.
 French curves, 387.
 Frost, 50, 229.
 Functions, judicial, of the surveyor, 116.

 Gallery, 294, 305, 306.
 Gauge,
 self registering, 213.
 tide staff, 212.
 Geodetic surveying, 3.
 Geographical meridian, 16.
 Geological Survey, U. S.,
 bench marks, 202.
 Geology, relation to topography, 273.
 Geometric principles, 159.
 Giving line, 111.
 Glass, magnifying, 47.
 Grade of street, 224.
 line, 207, 219, 251.
 leveling for, 210.
 Graduation,
 errors of, 49, 61.
 compass-box, 16.
 numbering, 32.
 tapes, 5.
 Grantee, 117.
 Grantor, 117.
 Gravity, 72.
 Great dipper, 182.
 Greenwich time, 68, 187.
 Group, of claims, 314.
 Growth of cities, 219.
 Guide meridians, 126.
 Gunter's chain, 3.

 Hachure, 267.
 Handkerchief, signals, 54.
 Hand level, 77.
 adjustments, 93.
 topography with, 278.
 Hayford, J. F., 188.
 Head,
 chainman, 7.
 shifting, 31.
 Heading, 286.
 Height of instrument, 198.
 High water mark, 135.
 Holman, S. W., 323.
 Horizon, 66.
 Horizontal,
 angles, 47.
 measurements, 3.
 line, defined, 72.
 Hourly change in declination of sun, 68, 191.
 Houses,
 conventional signs, 410.

Houses (Continued)

locating, 159.
Hypotenuse, 13.

Identification of bounds, 106.

Illumination,
cross-hairs, 182.
plumb line, 187.

Image, 34, 37.

Inaccessible distances, 174-178.

Inch, not used in surveying, 3.
miner's, 310.

Inclination,

correction for, 3, 13, 217, 333.
measured with clinometer, 293.

Index correction, 54.

Indexing, 432.

India ink, 396.

Indirect, adjustment, 89.

Information in notes, 114.

Initial point, 124.

Ink, 395.

Instructions, Manual of, 124.

Instrument,

care of, 61.
height of, 198.

Instrumental errors,

elimination of, 61, 87, 183, 200.

Instruments, drafting, 381.

Instruments, surveying and plotting,

Abney level, 293.

chain, 3.

compass, 16.

pocket, 18.

prismatic, 18.

level, 72, 73.

rod, 78.

Locke, 77.

lining pole, 7.

measuring rod, 6.

pins, 7.

planimeter, 330.

protractor, 382, 384, 398.

slide rule, 330.

stadia, 6.

targets, level rod, 80.

lamp, 299.

telescope, 34.

Thatcher rule, 333.

transit, 31.

solar attachment, 65.

Interchangeable side and top telescope, 290.

Interior angles, 108.

Interpolating contours, 276.

Interval, contour, 267.

Inverting eyepiece, 37.

Iron, effect on needle, 19.

Irregular,

areas, 344.

variation, 25.

Isogonic,

chart, 22, 25

lines, 25.

Judicial functions of the surveyor, 116.

Keys, 19.

Lamp targets, 299.

Land Office, 124, 126.

Land surveying,

by compass and chain, 99.

by transit and tape, 101.

error of closure, 99.

Land surveying (Continued)

computing area

by D. M. D.'s, 356.

by coordinates, 374.

additional areas, 334.

dividing land, 368.

obstacles, 170.

resurveys, 118.

supplying omissions, 117, 366.

survey for deed, 114.

U. S. Public Lands, 121.

Lateral,

adjustment, 89.

movement of transit head, 32.

Latitude,

difference, 352.

error in, 358, 364.

observation, 196.

of a line, 352.

parallel, 148.

total, 401.

Laws, mining, 313.

Laying out curves, 237.

Laying out land, 222.

Laying out town site, 219.

Least squares, method of, 14, 262.

Legal lines, 106.

Length,

absolute of, tape, 217.

standard of, 218.

Lenses, 36, 78.

Lettering on maps, 420, 421, 422.

Level,

bubble, 73.

dumpy, 74.

hand, 77.

line, 7.

Locke, 77.

precise, 73.

rod, 78.

section, 210.

surface, 72.

(term in mining), 286.

use of, 83.

vial, 72.

wye, 73.

Leveling, 198.

across a river, 213.

for bench marks, 198.

for grade line, 210.

for profile, 203.

instruments used in, 72.

rods, 78.

screws, 32.

signals used in, 85.

Levels,

divergence in duplicate lines, 201.

double rodDED lines, 201.

Limb,

of sun, 69, 192.

of transit (graduated), 31.

Lines,

clearing out, 150.

horizontal, 7.

legal, 106.

of collimation, 34.

stretching, 230.

Lining in, 8, 13.

Lining-poles, 18.

Link, 3.

Local,

attraction, 29.

laws, 314.

mean time, 187, 196.

- Locating,
 buildings, 159.
 points from transit line, 265.
 property lines, 263.
 Locke hand level, 77.
 Lode,
 claim, 313.
 coloring on maps, 306.
 Logarithms,
 computing by, 327.
 Long rod, 80.
 Longitude,
 difference, 352.
 table of lengths, 155.
 Lost monuments, 106, 116.
 Lots, city, 222.

 Magnet, earth a, 19.
 bar, used, 28.
 Magnetic,
 attraction, 29.
 bearing, 16.
 declination, 19.
 variation of, 20.
 observations for, 182.
 meridian, 16.
 needle, 16, 32.
 ore, 294.
 storms, 25.
 Magnetism, weakened, 27.
 of earth, 19.
 Magnifying glass, 47.
 Magnifying power, 37.
 Man-hole (mining), 286.
 "Manual of Instructions," 124, 188, 315.
 Map,
 Baltimore, 258.
 Washington, 223.
 Maps,
 city, 255.
 large, 429.
 lettering on, 420.
 mine, 305.
 topographical, 270.
 requirements, 114.
 Marking points in tape measurement, 10.
 Marsh, conventional sign, 417.
 Massachusetts,
 observed declinations, 20.
 Mean,
 tide, 198, 212.
 time, 187, 196.
 Meandering, 134.
 Meander lines, 135.
 Meandering a stream, 136.
 Measurements,
 accuracy of, 14.
 chain, 7.
 mistakes in recording, 11.
 odometer, 6.
 on slope-reducing, 328.
 pacing, 9.
 stadia, 6.
 tape, 10.
 Measuring,
 angles by repetition, 48.
 base line, 261.
 differences in elevation, 72.
 distances, 3.
 Mental estimates, 12, 330.
 Meridians,
 angular convergence of, 121, 129, 154.
 determination of, 180.
 by solar attachment, 66.
 guide, 126.

 Meridians (Continued)
 magnetic and true, 16, 17.
 on maps, 427.
 principal, 122, 126.
 Metallic tape, 5.
 Method of least squares, 14, 262.
 Method of surveying field, 101.
 Metric chain, 5.
 Metropolitan Water and Sewerage Board, 81.
 Microscope, 35.
 Mill-hole, 286.
 Mine,
 bore-holes, 315.
 boundaries, 312.
 claims, 313.
 carrying meridian into, 294.
 connecting surface and underground, 298.
 laying out work, 307.
 mapping, 305.
 patent surveying, 312.
 placer claims, 314.
 surface surveys, 311.
 surveys, 285.
 underground leveling, 306.
 underground surveying, 294.
 Miner's dial, 287.
 Mining, claims, 313.
 terms, 285.
 Missing data, 366.
 Missouri River Commission, 202.
 Mistakes,
 avoiding, 11.
 in compass work, 28.
 in level work, 94.
 in measuring lines, 11.
 in transit work, 62.
 in using solar attachment, 70.
 Moisture, effect on level rod, 83.
 Monuments,
 at section corner, 147.
 in city work, 228.
 lost, 116.
 significance and authority of, 116.
 Motion of fingers in leveling, 46.
 Multiplication by slide rule, 332.

 Nails, in marking points, 10, 300.
 Natural, functions, 327.
 scale of maps, 382.
 Nautical Almanac, 68, 184, 188.
 Navigators, 20.
 Needle, compass,
 bent, 26.
 remagnetizing, 28.
 New York rod, 80.
 Night, observations at, 182.
 Noon observation, 196.
 Normal position of telescope, 34.
 North star, 180.
 Northing, 352.
 Note book, 84, 100, 112.
 Notekeeper, 11.
 Notekeeping, 112.
 bench levels, 200.
 cross-section, 206.
 double rodded lines, 201.
 mine, 301.
 profile, 204.
 road, cross-section, 209.
 topographical survey, 266.
 Notes, 112.
 compass and chain, 100.
 transit and tape, 103.
 traverse, 157.

- Numbering,
 graduations, 32.
 townships, 122.
 sections, 123.
- Objective, 35.
 slide, adjustment, 60.
- Obstacles, 170, 173.
- Observations,
 for declination of needle, 25.
 for meridian by solar, 66.
 on Polaris, 182.
 on Polaris, with compass, 187.
- Odometer, 6.
- Office,
 plans, 431.
 work, 107.
- Offsetting transit line, 170, 173.
- Offsets, 105, 150.
- Omissions, supplied, 366.
- Optical, axis, 35.
 center, 36.
- Ordinates, 256.
- Ore, testing by electric currents, 311.
- Organization of transit party, 111.
- Origin of coordinates, 256.
- Original notes, 100, 112.
- Outcrop, 286.
- Owners of property, 117.
- Ownership of surveys, 114.
- Facing, 9.
- Pantograph, 385.
- Paper, 388.
 expansion of, 428.
 mounted, 388.
 protractor, 384.
- Parabolic curve, 242.
- Paraffin, 83.
- Parallax, 19, 34, 48.
- Parallel,
 of latitude, 148.
 ruler, 386.
 standard, 122, 126.
- Party, transit, 111.
- Patent, mining claims, 312.
- Peg adjustment, 91.
 adjustment for hand level, 93.
- Pen, contour, 386.
- Pencil, 52, 91, 112.
- Permanence, bench marks, 203.
- Philadelphia rod, 81.
- Photograph of landscape, 271.
- Pins, 7.
- Pitch, 286.
- Pivot, 16, 77.
 bent, 27.
 cap, 59.
- Placer, 314, 315.
- Plain transit, 34.
- Plan, 114, 255.
- Plane intersecting surface, 280.
- Plane surveying, 3.
- Planimeter, 340.
- Plates, of transit, 31.
- Plotting, 397.
 by coordinates, 401.
 by chords, 409.
 by protractor, 398.
 by tangents, 405.
 cross-sections, 411.
 details, 410.
 land surveys, 397.
- Plumb-bob, 32, 297.
- Plumb line, 52, 296.
 in chaining, 9.
- Plumbing,
 attachment, 82.
 down a shaft, 296.
 rod, 82.
- Plummet lamp, 300.
- Plus, station, 156.
- Pocket compass, 18.
- Polar axis, 65.
- Pole, 52, 180.
- Polaris,
 elongation of, 186.
 observation on, 25, 180.
 polar distance, 180, 184.
- Pole star, 18, 180.
- Position, zero point, 11.
- Precautions,
 in using level, 88.
 in using transit, 55.
- Pretise level, 73.
 rod, 82.
- Precision, 324.
- Preliminary railroad surveys, 6.
- Primary triangulation, 256, 264.
- Principal focus, 35.
- Principal meridian, 122, 126.
- Printing frames, 395.
- Prints, blue, 391.
 Vandyke, 393.
- Prismatic compass, 18.
 eyepiece, 293.
- Prismoidal formula, 344.
- Prismoids, 344.
- Process papers, 391.
- Profile,
 leveling, 203.
 paper, 390.
- Profiles, 430.
- Projection, 271.
- Proportion (see balancing surveys).
- Proportional dividers, 387.
- Protractors, 382, 398.
- Prussian blue, 396.
- Public land surveys, 121.
- Pull,
 chain, 9.
 tape, 12.
- Purposes, of surveys, 3.
- Quadrant, 17.
- Quadrilateral, 178, 337.
- Quarter-section, 133.
- Questioned measurement, 365.
- Rack and pinion, 34.
- Radius, of curve, level vial, 72.
- Railroads,
 curves, 387.
 surveys, 6.
 tracks, 251.
- Raise, 286.
- Random line, 51, 130, 169.
- Range,
 line, 123, 159, 160.
 pole, 7, 52, 53, 180.
 townships, 123.
- Raymond, W. G., 114.
- Reading glass, 47.
- Rear chainman, 7.
- Records, 255.
- Rectangular coordinates, 255.
- Reducing slope measurements, 328, 333.

- Reference measurements, 107 .
 Refraction,
 curvature and, 89.
 in altitude, 193.
 in declination, 507.
 Registry of deeds, 120.
 Remagnetizing needle, 28.
 Repeating angles, 48.
 tape measurements, 10.
 Report (see U. S. Coast and Geodetic Survey).
 Results, 323.
 Resurveys, 118.
 Reverse bearings, 29.
 Reverse position of telescope, 34.
 Reversing E. and W. points, 18.
 Reversion, 56.
 Revolution of wheel, 6.
 Right ascension, 188.
 Ring, cross-hair, 58.
 Rivers, 118.
 Roads,
 measuring on, 10.
 Rod, 3.
 Rod levels, 82.
 Rodman, 78.
 Rod readings, 84.
 for grade, 207.
 Rods,
 leveling, 78.
 Boston, 78.
 measuring, 6.
 New York, 80.
 Philadelphia, 81.
 precise level, 82.
 special, 81.
 tape, 81.
 Roof, transit on, 172.
 Rule,
 parallel, 386.
 slide, 330.
 two foot, 6.
 Runner, on slide rule, 331.
 Sag, 9, 13.
 Sand, 417.
 Scales,
 engineer's, 382.
 logarithmic, 331.
 of maps, 397, 429.
 Screen, for sun's image, 65.
 Screw, leveling, 32.
 Sea-level (see datum).
 Secant method, 148.
 Secondary triangulation, 263.
 Section, of level, 74.
 of transit, 31.
 Section, public lands, 123.
 Secular, variation, 20.
 Self-reading rods, 81.
 Setting up transit, 45.
 Sewer, 220, 227, 251.
 Shading (see hachures).
 Shafts, 286, 294, 298.
 Sherman, C. W., 218.
 Shifting head of transit, 31, 46.
 Shirley, Maj. J. W., 258.
 "Shooting in" grades, 211.
 Shop adjustments, 61.
 Shore lines, 280.
 Short rod, 80.
 Shrinkage of paper, 428.
 Side telescope, 287.
 Sidereal time, 188.
 Sights, compass, 16, 18.
 length of, 87.
 Sights (Continued)
 showing, 52.
 Sighting rod, 7.
 Signals,
 level work, 85.
 transit work, 53.
 triangulation, 256.
 Signs, conventional, 417, 419.
 Simpson's one-third rule, 334.
 Sines, 485.
 Sketch, 199.
 Sketching contours, 276.
 in mining, 312.
 Slide rule, 331.
 Thatcher rule, 333.
 Slopes,
 chaining on, 9.
 reducing slope measurements, 328, 333.
 side, 208.
 slope stakes, 208.
 Slow motion, 32.
 Solar,
 attachment, 65, 125.
 observations, 190, 193.
 Sources of error,
 compass work, 28.
 level work, 94.
 measuring lines, 11.
 transit work, 62.
 Southing, 352.
 Soundings, 310.
 Speaking rods (see self-reading).
 Spherical triangle, 67.
 Specimen notes, 146.
 Speed of floats, 310.
 Spider lines, 36.
 Spindle, 31.
 Spirit level, 16, 32, 72.
 Spline, 287.
 Spring balance, 216.
 Stadia, 6.
 Staff gauge, 212.
 Staking out lots, 227.
 Standard,
 length, 4, 12, 218.
 of transit, 32.
 parallel, 126.
 time, 68.
 State surveys, 158.
 Stations, 10, 156.
 marking, 300.
 Steel tape, 5, 10, 12.
 measurements, 10.
 Stopes, 286.
 Stop screw, 88.
 Straight-edge, 381.
 Straight-lines, 51, 52.
 Straightening crooked boundary, 336.
 Streams, 280.
 flow of, 310.
 meandering, 136.
 Streets, 219, 251.
 Stretch, tapes, 5.
 Striding level, 287.
 Strike, 286.
 Stull, 286.
 Sub-grade, 207.
 Subdivision of land, 368.
 Supplying missing data, 366.
 Surveying,
 plain and geodetic, 3.
 for area, 99.
 for deed, 114.
 public lands, 121.
 Surveyor general, 121, 314.

- Surveyor's,
 chain, 3.
 compass, 16.
 transit, 32.
 Surveys, accuracy of, 14.
 Swamp, conventional size, 417.
 Swing offset, 159.
 System, Public Lands, 121.
- T-square, 381, 400.
 Tack, 108.
- Tables,
 convergence of meridians, 129.
 decimals of foot in inches, 6.
 hourly change in sun's declination, 191.
 length of degree of longitude, 155.
 mean polar distances of Polaris, 184.
 observed declinations in Massachusetts, 20.
 refraction in altitude, 193.
 tangent method, parallel, 152, 153.
 times of elongation and culmination, 186.
 secant method, parallel, 149.
- Tag, on chain, 4.
 Tangent, method, 150.
 plotting by, 405.
 screws, 32.
- Tape-rod, 81, 206.
 Tapes, city work, 216.
 cloth, 5.
 metallic, 5.
 steel, 5.
- Target,
 bisection, 80.
 rod, 80.
- Telescope, 34, 287.
 Temperature, 13.
 Tension handle, 216.
 Tests, on transit, 55.
 Thacher slide rule, 333.
 Thermometer, on leveling rod, 82.
 Three arm protractor, 384.
- Tide,
 gauge, 212.
 observation of, 211.
- Ties, 101, 107, 159.
 Tiers, townships, 123.
 Time (see mean time).
 Titles, 423.
- Top telescope, 287.
 Topographical surveying, 264.
 Topographical symbols, 417, 419.
- Topography,
 contour map, 270.
 field methods, 264.
 methods of representing, 417, 419.
- Total latitude and departure, 401.
- Township, 121.
 corners, 147.
 exteriors, 127.
 numbering, 122.
 subdivision, 128.
- Tracing,
 cloth, 190, 389.
 paper, 389.
- Transit, 31.
 adjustment of, 56.
 carrying, 62.
 engineer's, 34.
 measuring angles with, 47, 48, 54.
 plain, 34.
 running straight line, 51.
 setting up, 45.
 solar attachment, 65.
- Transit (Continued)
 traversing, 101.
 used in land surveys, 125.
 used in mining, 287.
- Traverse, definition, 100.
 adjusting, 364.
- Traversing,
 with compass, 99.
 with transit, 101.
- Traverses,
 in city work, 263.
 inking in, 415.
 locating from, 159.
 underground, 299.
- Trench excavation, 210.
- Triangles, inaccurate, 402.
- Triangulation,
 calculation, 372.
 scheme, 258.
 stations, 256.
 system, 256, 293.
- Tripod, 32, 45, 61.
- Tube reflector, 300.
- Tunnel, 286.
- Turning points, 86, 198, 202.
 double (see double rodDED lines).
- True,
 bearing, 17.
 meridian (see observations).
- Two-foot rule, 6, 52.
- Underground surveys, 294.
- United States,
 Coast and Geodetic Survey, 20, 25, 77, 119,
 184, 202.
 Deputy surveyors (see deputy).
 Geological Survey, 202.
 Isogonic Chart, 22-23.
 Public Lands, Surveys, 121.
 angular convergence of meridians, 129.
 base line, 124.
 corners, 147.
 guide meridians, 126.
 legal requirements, 122.
 meandering, 134.
 notes, 142.
 principal meridian, 126.
 scheme of subdivision, 121.
 standard parallels, 126.
 subdivision of township, 128.
 township, 127.
 standard of length, 12.
 surveyor general, 121, 314.
- Units, 3, 4.
- Ursa Major, 182.
- Value of one division, level, 73.
- Valley, 220, 270.
- Vandyke paper, 393.
- Variation of compass (see declination).
 of declination, 20.
- Veins, 316.
- Velocity of stream, 310.
- Vermilion, 396.
- Vernier, 38.
- Vertical,
 angle, 54, 308.
 circle, 34.
- Volumes, 342.
- Wall, 286.
 conventional sign, 419.
- Washington, 223.
- Water, boundaries, 118.

Water (Continued)

color, 395.
lining, 417.
supply, 227.
Waterproof ink, 395.
Watershed, 260, 273.
Waving the rod, 84.
Wearing of chains, 13.
Westing, 352.

Wheel, revolution of, 6.
Wind, effect of, 11.
Winze, 286.
Wires, illuminating, 182.
Wooden rods, 6.
"Working into line," 51.

Zenith, 66.
Zero point, 11.

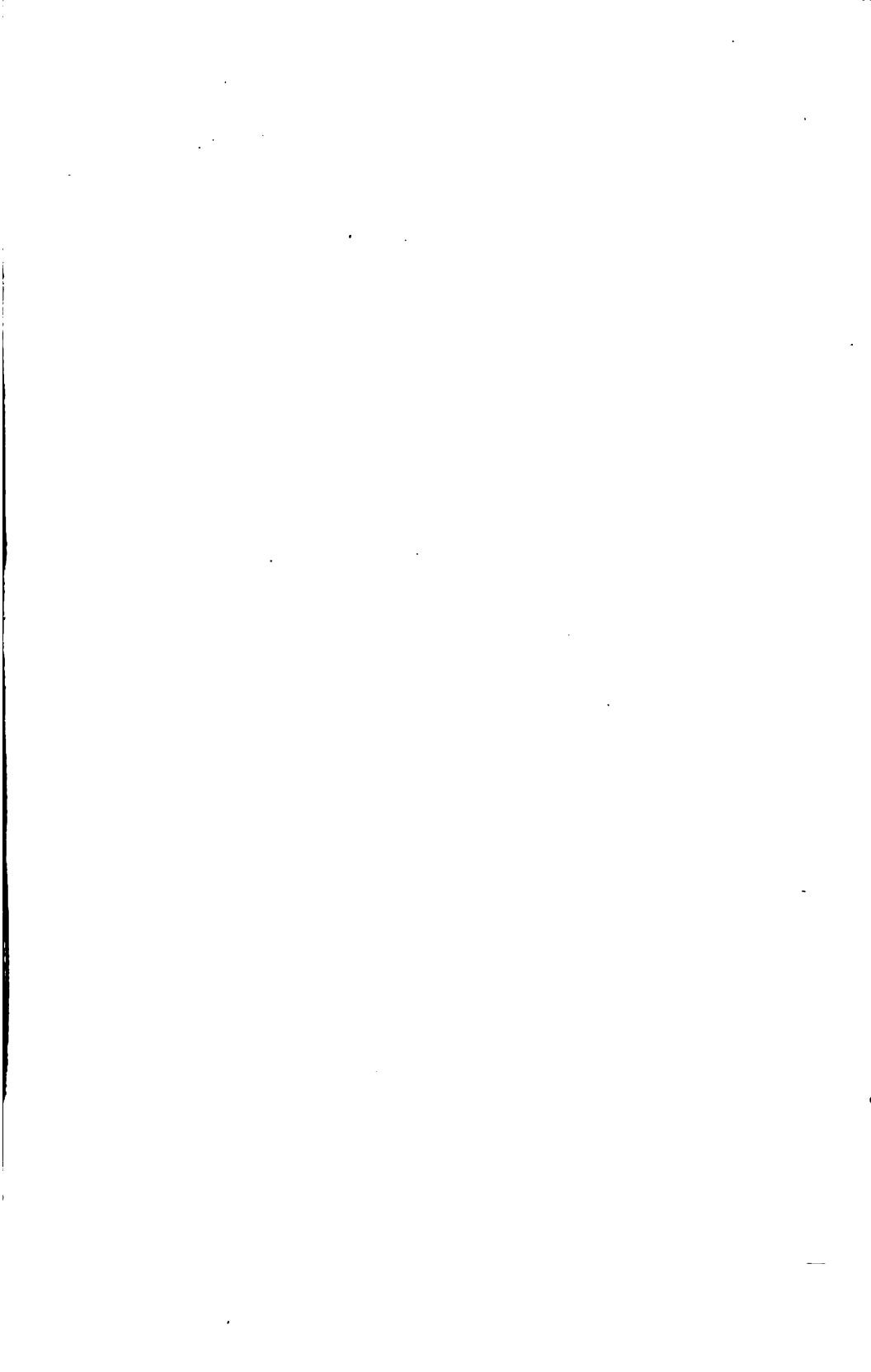

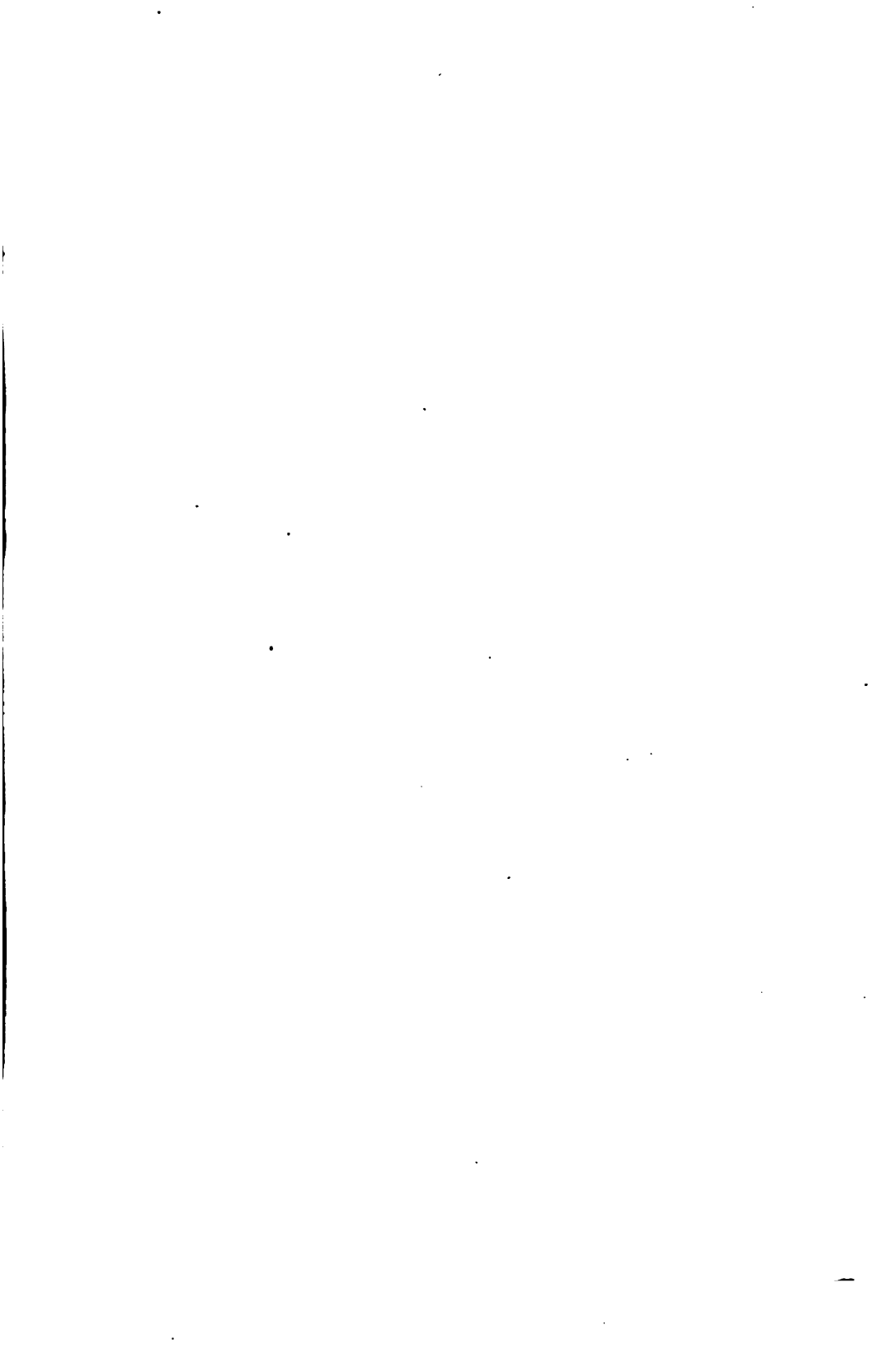







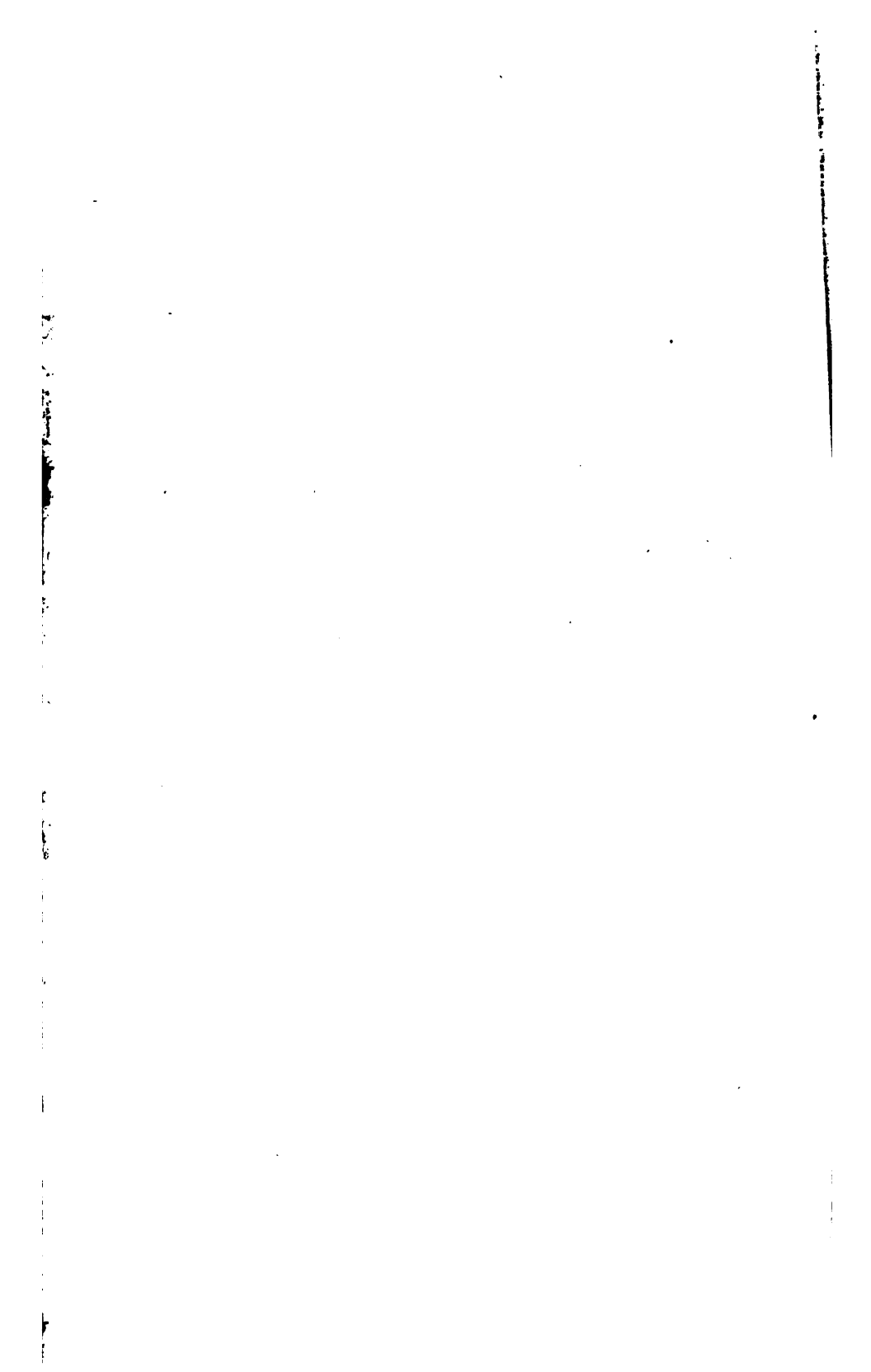

The book may

89078558327



B89078558327A