



This is a digital copy of a book that was preserved for generations on library shelves before it was carefully scanned by Google as part of a project to make the world's books discoverable online.

It has survived long enough for the copyright to expire and the book to enter the public domain. A public domain book is one that was never subject to copyright or whose legal copyright term has expired. Whether a book is in the public domain may vary country to country. Public domain books are our gateways to the past, representing a wealth of history, culture and knowledge that's often difficult to discover.

Marks, notations and other marginalia present in the original volume will appear in this file - a reminder of this book's long journey from the publisher to a library and finally to you.

Usage guidelines

Google is proud to partner with libraries to digitize public domain materials and make them widely accessible. Public domain books belong to the public and we are merely their custodians. Nevertheless, this work is expensive, so in order to keep providing this resource, we have taken steps to prevent abuse by commercial parties, including placing technical restrictions on automated querying.

We also ask that you:

- + *Make non-commercial use of the files* We designed Google Book Search for use by individuals, and we request that you use these files for personal, non-commercial purposes.
- + *Refrain from automated querying* Do not send automated queries of any sort to Google's system: If you are conducting research on machine translation, optical character recognition or other areas where access to a large amount of text is helpful, please contact us. We encourage the use of public domain materials for these purposes and may be able to help.
- + *Maintain attribution* The Google "watermark" you see on each file is essential for informing people about this project and helping them find additional materials through Google Book Search. Please do not remove it.
- + *Keep it legal* Whatever your use, remember that you are responsible for ensuring that what you are doing is legal. Do not assume that just because we believe a book is in the public domain for users in the United States, that the work is also in the public domain for users in other countries. Whether a book is still in copyright varies from country to country, and we can't offer guidance on whether any specific use of any specific book is allowed. Please do not assume that a book's appearance in Google Book Search means it can be used in any manner anywhere in the world. Copyright infringement liability can be quite severe.

About Google Book Search

Google's mission is to organize the world's information and to make it universally accessible and useful. Google Book Search helps readers discover the world's books while helping authors and publishers reach new audiences. You can search through the full text of this book on the web at <http://books.google.com/>

LANE MEDICAL LIBRARY STAMFORD
1425 BA0 1912
The principles of hygiene : a practical



24503299954

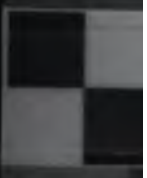

2156

LANE



MEDICAL

LIBRARY

Gift

San Francisco
County Medical Library

1882

1. 20

1882

1882

1882

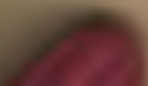





2156

THE PRINCIPLES
OF
HYGIENE

A Practical Manual for Students,
Physicians, and Health-Officers

BY

D. H. BERGEY, A.M., M.D.

First Assistant, Laboratory of Hygiene, and Assistant Professor of
Bacteriology, University of Pennsylvania

ILLUSTRATED

FOURTH EDITION, THOROUGHLY REVISED

PHILADELPHIA AND LONDON

W. B. SAUNDERS COMPANY

1912

Copyright, 1901, by W. B. Saunders and Company. Revised, reprinted,
and recopyrighted June, 1904. Reprinted May, 1906. Revised,
reprinted, and recopyrighted January, 1909. Reprinted
May, 1910. Revised, reprinted, and copy-
righted January, 1912.

Copyright, 1912, by W. B. Saunders Company.

PRINTED IN AMERICA

PRESS OF
W. B. SAUNDERS COMPANY
PHILADELPHIA



1000
1000
1000

PREFACE TO THE FOURTH EDITION.

IN preparing the present edition of this work the matters under discussion have been carefully reviewed with the object of bringing the statements up to date as far as possible. Many of the statements were revised, so as to conform with the accepted teaching of the present time. This form of revision is necessary in the discussion of subjects pertaining to hygiene, because of the great advancement in our knowledge concerning methods of causation and prevention of disease.

Marked advancement has been made in our knowledge of water and sewage purification, and these advances have been noted in the text. Similarly great advances have been made in methods of prevention of disease, especially in typhoid fever and dysentery. These forward steps have also been recorded.

The chapter on Immunity has again been revised in important particulars, in order to bring the statements into conformity with the advancements in our knowledge of this subject.

Advantage has been taken in correcting errors that had been pointed out by the reviewers, and the author wishes to record his appreciation for the kindly spirit in which these had been pointed out.

D. H. B.

January, 1912

PREFACE.

THIS book has been prepared to meet the needs of students of medicine in the acquirement of a knowledge of those principles on which modern hygienic practices are based; to aid students in architecture in comprehending the sanitary requirements in ventilation, heating, water-supply, and sewage-disposal; and to aid physicians and health officers in familiarizing themselves with the advances made in hygienic practices in recent years.

The rapid strides made in our knowledge of the entire subject of hygiene has rendered such a book, based upon the more recent discoveries, almost a necessity to students of medicine.

No attempt has been made to treat the subject in an exhaustive manner, the object being merely to give the general principles upon which the health officer and the physician work in their respective capacities in dealing with conditions which are detrimental to health or which tend to improve health.

The entire range of subjects comprising the comprehensive field of hygiene has not been discussed, but all those subjects which appeared to the author to be most important for those for whom the book has been prepared have received the consideration which their relative importance demanded.

The metric system of weights and measures has been employed throughout the work except in quotations,

because this system is now in general use in all scientific laboratories in the United States, and because it is in every way preferable to the cumbersome and complicated system, with its various units, which is still in common use. The metric system was employed also because it is in common use on the Continent of Europe, and is also a legal system in the United States since 1866, when Congress passed an act making its use lawful in the construction of contracts and in all legal proceedings. It is rapidly coming into general use in medicine and pharmacy, and its general adoption has the hearty endorsement of numerous scientific societies. At the present time a bill is passing through Congress which, when enacted, will make its employment compulsory in all departments of the Government after January 1, 1903.

In the Appendix the relative values of the units of weights and measures of the metric system have been given in terms of the English system, and *vice versa*.

D. H. B.

CONTENTS.

| | PAGE |
|---|------|
| INTRODUCTION..... | 17 |
| Causes of Disease, 17.—Sanitary Science, 27.—Hygiene, 27. | |
| CHAPTER I. | |
| AIR..... | 31 |
| Nature and Composition of the Atmosphere, 31.—Temperature of the Air, 33.—Pressure of the Atmosphere, 34.—Distribution of Atmospheric Pressure, 36.—Humidity of the Atmosphere, 37.—Hygrometry, 38.—Elastic Force of Vapor, 40.—Absolute Humidity, 40.—Relative Humidity, 40.—The Influence of Humidity on Health, 41.—Movements of the Atmosphere, 41.—Clouds, 42.—Precipitation of Moisture, 42.—Climate, 43.—Ground-air, 50.—Sewer-air, 51.—The Impurities in the Air, 51.—Examination of the Air by the Senses, 57.—Chemical Analysis of the Air, 57.—Diseases Produced by Impure Air, 60.—Effects of Vitiated Air Generally, 60. | |
| CHAPTER II. | |
| VENTILATION..... | 64 |
| Amount of Fresh Air Required, 64.—Cubic Space, 66.—General Rules for Ventilation, 68.—Natural Ventilation, 68.—Arrangements in Natural Ventilation, 70.—Artificial Ventilation, 78.—Removal of Dust, 83. | |
| CHAPTER III. | |
| HEATING..... | 86 |
| Loss of Heat from Buildings, 86.—Degree of Warmth, 86.—Heat Supplied by Radiating Surfaces, 87.—Systems of Heating, 89.—Direct Heating, 90.—Indirect Heating, 93. | |
| CHAPTER IV. | |
| WATER AND WATER-SUPPLY..... | 96 |
| Physical Properties of Water, 96.—Chemical Composition, 96.—Rain-water, 97.—Spring-water, 97.—Well-water, 98.—River-water, 98.—Lake-water, 99.—Sea-water, 99.—Comparison of Natural Waters, 99.—Impurities in Water, 100.—Effects of Impurities in Water, 104.—Dissolved Impurities, 105.—Approximate Composition of Drinking-water, 110.—Amount of Drinking-water Re- | |

quired Daily, 110.—Source of Water-supplies, 111.—Storage of Water, 116.—Purification of Water, 116.—Methods of Purification, 117.—Sterilization of Water by Means of Chemicals, 136.—Suitability of Water for Boiling Purposes, 138.—Standard Method of Water and Sewage Analysis, 139.

CHAPTER V.

THE REMOVAL AND DISPOSAL OF SEWAGE..... 151
 The Removal of Sewage, 151.—Water-closets, 151.—Traps, 154.—Disposal of Sewage, 158.—Chemical Treatment of Sewage, 159.—Modern Methods of Sewage Purification, 161.—Sewage Purification—Conversion of Nitrogenous Matter, 171.—Summary Concerning Sewage Purification Plants Now in Operation in America, 171.—Sprinkling Filters, 175.—The Removal of Sewage by Liernur System, 177.—Commercial Value of Sewage, 178.

CHAPTER VI.

GARBAGE DISPOSAL..... 180
 Collection and Removal of Garbage, 181.—Disposal of Garbage, 182.

CHAPTER VII.

FOOD AND DIETING..... 185
 Chemical Composition of the Body, 185.—Potential Energy in Food, 187.—Energy Derivable from Food, 189.—Nutritive Value and Cost of Food, 195.—Digestibility of Foods, 197.—Composition of Foods, 199.—Functions of the Alimentary Principles of Food, 200.—Water as Food, 201.—Different Varieties of Food, 202.—Animal Foods: Meat, 202.—Food-poisoning, 206.—Composition of Meat, 212.—Fish, 214.—Milk and Milk-products, 214.—Vegetable Foods, 227.—Bread, 229.—Preserved Vegetable Foods, 230.—Food-preservatives, 231.—Nuts and Their Uses as Food, 231.—Mineral Food, 232.—Beverages and Condiments, 232.—Adulterations of Food, 234.—Dieteries, 238.

CHAPTER VIII.

EXERCISE..... 242
 Effect on the Lungs, 242.—Effect on the Circulation, 244.—Effect on the Muscles, 245.—Fatigue, 245.—Effect on the Nervous System, 246.—Effect on the Elimination of Nitrogen, 246.—Amount of Exercise that Should Be Taken, 247.

CHAPTER IX.

CLOTHING..... 250
 Protection against Cold, 250.—Protection against Heat, 251.—Protection against Dampness, 251.—Protection against Injury, 252.—Injurious Effects of Clothing, 254.—Cleanliness in Relation to Clothing, 255.—Infected Clothes and Bedding, 256.

CONTENTS. 13

CHAPTER X. PAGE

| | |
|--|-----|
| PERSONAL HYGIENE..... | 258 |
| Cleanliness, 259.—The Bowels, 259.—The Passions, 259.—The Mouth and Teeth, 259.—Habitation, 260.—Occupation, 260.— Mental Attitude, 261. | |

CHAPTER XI.

| | |
|---|-----|
| INDUSTRIAL HYGIENE..... | 262 |
| The Effect of Anilin Dyes and Nitrobenzine and Its Compounds, 274.—Influence of the Length of the Working-day on the Health of the Laborers, 276.—Lighting of Industrial Establishments, 278. | |

CHAPTER XII.

| | |
|--|-----|
| SCHOOL HYGIENE..... | 281 |
| Site, or Location, with Reference to Drainage Capacity of the Soil, 281.—Structure of the Walls, 282.—Cubic Space and Floor Space, 282.—Relation of Window Space to Floor Space, 284.— Lighting, 285.—The Position of Blackboards, 286.—Corridors, Cloak-rooms, and Wardrobes, 286.—Ventilation, 287.—Heating, 288.—Water-supply and Sewage Disposal, 289.—Water-closets and Latrines, 289.—Desks and Seats, 290.—Defects in School-buildings, 292.—Medical Inspection of Schools, 294. | |

CHAPTER XIII.

| | |
|--|-----|
| MILITARY HYGIENE..... | 299 |
| The Recruit, 299.—Training of the Recruit, 302.—Food of the Soldier, 303.—Clothing of the Soldier, 305.—Camps, 309.—Barracks, 312.—Marches, 314.—Camp Diseases, 315.—Foot Inspection, 316.— Body Inspection, 317. | |

CHAPTER XIV.

| | |
|--|-----|
| NAVAL HYGIENE..... | 318 |
| Ventilation, 319.—Heating of the Vessel, 321.—Lighting, 321.— Cleansing the Vessel, 321.—Water-supply, 321.—Food-supply, 322.— Clothing, 323.—Selection of Marines, 323.—Principal Diseases Among Marines, 327. | |

CHAPTER XV.

| | |
|---|-----|
| SOIL..... | 329 |
| Ground-air, 329.—Ground-water, 330.—Pathogenic Bacteria in Soil, 332.—Improvement of a Damp Soil, 332.—Configuration of the Surface and Soil-covering, 332. | |

CHAPTER XVI.

| | |
|--|-----|
| HABITATIONS..... | 334 |
| Position of the House, 334.—The Foundation and Walls, 335.— The Roof, 335.—The Interior Arrangement, 336.—The Size of the Rooms, 336.—The Sleeping-rooms, 337.—The Floors and Floor- | |

coverings, 338.—The Wall-coverings, 338.—Ventilation and Heating, 339.—Cooling Devices, 340.—Plumbing and Drainage, 342.—Houses for the Poor, 342.—House-cleaning, 344.—Protection from Flies and Mosquitoes, 345.

CHAPTER XVII.

| | |
|--|-----|
| VITAL CAUSES OF DISEASE..... | 346 |
| Modes of Dissemination, 348.—Nature of Epidemics, 349.—Immunity and Susceptibility, 350.—Prevention of Infection by Inducing Active Immunity, 367.—The Haffkine Method of Protection, 368.—Value of Vaccination as a Protective against Small-pox, 373.—Precautions in Vaccination, 376.—Biologic Aids to Diagnosis, 377.—Personal Prophylaxis, 379.—Persistence of Pathogenic Bacteria in Dead Bodies, 383.—Prevention of Malaria, 384.—Prevention of Yellow Fever, 386.—Destruction of Vermin, 391.—Relation of Insects to the Spread of Disease, 393.—Remedies for Fleas, 398.—Animal Parasites, 401.—Prevention of Infection with Animal Parasites, 414.—Vegetable Parasites, 416. | |

CHAPTER XVIII.

| | |
|---|-----|
| DISINFECTION..... | 418 |
| Disinfectants in Common Use, 419.—The Action of Sunlight on Bacteria, with Special Reference to Bacillus Tuberculosis, 420.—Disinfection on Large Scale, 420.—Formaldehyd, 422.—Generation of Formaldehyd Gas, 423.—Liquid Formaldehyd Spraying, 426.—Sulphur Dioxid, 426.—Hydrocyanic Acid, 427.—Corrosive Sublimate, 427.—Carbolic Acid, 428.—Triresol, 428.—Creolin, 428.—Nitrate of Silver, 429.—Preparations of Lime, 429.—Washing Soda, 429.—Sulphate of Iron, 429.—Physical Agents, 429.—Disinfection of Infective Materials, 431.—Disinfection of Excreta, 431.—Disinfection of Sick-room, 432.—Disinfection of Habitations, 434.—Disinfection of Patient, 435.—Disinfection of Public Conveyances, 436.—Disinfection of Libraries, 438.—Barber-shops, 438. | |

CHAPTER XIX.

| | |
|--|-----|
| QUARANTINE..... | 440 |
| Maritime Quarantine, 440.—Inland Quarantine, 441.—Isolation or House Quarantine, 442.—Value of Disinfection and Isolation, 442.—Period of Isolation, 446.—Period of Detention of Those Exposed to the Infectious Diseases, 446.—Maritime Quarantine, 447.—Quarantine Laws of the United States, 448.—Quarantine Regulations, 460.—Special Quarantine Regulations for Fruit Vessels, 488.—Interstate Quarantine, 492.—State Quarantine Regulations, 498.—House Quarantine, 500. | |

CHAPTER XX.

| | |
|---|-----|
| VITAL STATISTICS..... | 503 |
| The Census as a Basis for Calculation, 505.—Standards of Age-distribution, 505.—Calculation of the Birth-rate and the Death-rate, | |

CONTENTS.

15

507.—Rate of Infant Mortality, 508.—Death-rate of Persons Engaged
in Various Occupations, 508.—Mortality in Relation to Seasons, 509.
—Mean Age at Death, 509.—Mean Duration of Life, 509.—Probable
Duration of Life, 510.—Expectation of Life, 510.—Relation of
Density of Population to the Death-rate, 511.—Necessity of System
of Notification, 512.—Hospital for Infectious Diseases, 513.

PAGE

APPENDIX 514

Rules for Interchange of Different Expressions of Results of Analy-
sis, 514.—Rules for Conversion of Degrees of One Thermometer
Scale into those of Another, 514.—Rules for Conversion of Kilo-
gram-meters into Foot-pounds and Foot-tons, and *vice versa*, 515.—
Values of Terms Employed in Connection with Fuel-value of Food,
515.—Comparison of Metric and English Weights and Measures, 515.

INDEX 517



THE PRINCIPLES OF HYGIENE.

INTRODUCTION.

THE comprehensive nature of the subject precludes the possibility of giving a short and precise definition. A late writer on hygiene has given the following definition : "Hygiene aims to make growth more perfect, life more vigorous, decay less rapid, death more remote." Hence hygiene treats of the laws of health ; of all those measures which tend to preserve the body in a healthy condition, as well as those which tend to improve the general health. It embraces a knowledge of the factors and conditions which bring about ill health and disease, as well as a knowledge of the methods of preventing disease, and of the measures which tend to fortify and improve the organism.

Health is that condition of the body in which all the various functions are performed normally, and without the manifestation of discomfort in any of its operations. **Disease**, on the other hand, implies the imperfect performance of one or more of the bodily functions because of the impaired structure of the corresponding organ or organs, and the consequent manifestation of discomfort, either in the part directly affected or in the body generally.

There are many factors which may operate in such a manner as to bring about disease. These factors are usually divided into the immediate and remote causes of disease.

The **immediate causes** of disease may be again divided into three classes, physical, chemical, and vital. The

physical causes of disease are such as are brought about by physical agencies. The diseases which are due to physical agencies are burns, cuts, bruises, fractures, and the like, and those diseases of the respiratory organs due to the inhalation of various forms of dust. The *chemical* causes of disease are corrosive and irritating drugs and chemicals which act directly through their corrosive action upon the part with which they are brought in contact, or indirectly through action upon the system after having been absorbed into the circulation. The *vital* causes of disease are the most important, because they are the most numerous and are frequently communicated from the sick to the well. They are also of great hygienic importance, because most of them are preventable. The vital causes of disease which are known to-day are the animal and vegetable parasites that are capable of lodging upon the surface of the body or penetrating into the blood and tissues, and thus give rise to disordered function either by producing obstruction, local irritation, absorbing large quantities of nourishment from the body, or by generating highly poisonous secretion and excretion products which produce disease through their local or general action. The principal animal parasites which produce disease are the various forms of intestinal worms, the trichinella spiralis, the filariæ, the itch mite, the trypanosomata, and the malarial organisms. The principal vegetable parasites which produce disease are the different forms of pathogenic bacteria and the plants of somewhat higher order which produce tinea favosa and other skin diseases.

The **remote causes** of disease operate in such a manner as gradually to reduce the physical powers of the body, so as to make it possible for the vital causes to operate. The remote causes of disease may be such factors as undue exposure to extremes of heat and cold, dampness or undue dryness of the atmosphere, undue exposure to bright lights or strong currents of air may operate in this manner, prolonged absence of sunlight, deficient ventilation, the use of excessive amounts of

certain kinds of food and drink, the continued use of a diet which is deficient in one or more of the elements which enter into the composition of the body, maintaining the body in abnormal positions for a long time, undue physical or mental exertion, deprivation of food and sleep, and wearing of apparel which constricts certain portions of the body.

The causes of disease may also be divided into the predisposing and the exciting causes. The **predisposing causes** of disease are the various conditions which, by their influence upon the body, render it less resistant to the invasion of pathogenic bacteria, or otherwise predispose to disordered health. The conditions which have been classed as remote causes of disease also belong in this class, but besides these there are other important conditions which predispose to disease, such as the age and sex of a person, hereditary influences, race, conjugal condition, the hygienic condition of the environment, the density of the population, the nature of the occupation, and the climate of the locality. Dr. Farr found that the mortality increases with the density of the population, not in direct proportion to the density, but as its sixth root.

The **exciting causes** of disease are the specific elements which are the etiologic factors in the production of disease. These are synonymous with the immediate causes of disease in the first classification, the physical, chemical, and vital causes of disease.

Predisposing Causes of Disease.—1. *Age.*—The influence of age is a most important factor in the production of disease. The age groups in which the mortality is greatest are to be found in the periods of growth and decline, while the mortality is lowest during youth and the earlier periods of adult maturity. The highest mortality occurs among children under one year of age, and then decreases rapidly until we reach the fifteenth year, after which it again gradually increases until we reach the period between sixty and seventy years, when

it again decreases. The following table, taken from the annual reports of the Bureau of Health of the city of Philadelphia, shows "the percentage of deaths to total mortality during specified periods of life," for the years 1889 to 1894, inclusive:

| YEARS. | 1889. | | 1890. | | 1891. | | 1892. | | 1893. | | 1894. | |
|---------|-------|---------|-------|---------|-------|---------|-------|---------|-------|---------|-------|---------|
| | | Per ct. | | Per ct. | | Per ct. | | Per ct. | | Per ct. | | Per ct. |
| 0-1 | 5268 | 25.66 | 5287 | 24.33 | 5488 | 23.49 | 5693 | 23.42 | 5710 | 24.13 | 5472 | 24.57 |
| 1-2 | 1287 | 6.27 | 1305 | 6.00 | 1439 | 6.16 | 1601 | 6.59 | 1446 | 6.11 | 1363 | 5.96 |
| 2-5 | 1197 | 5.83 | 1320 | 6.07 | 1552 | 6.64 | 1904 | 7.83 | 1534 | 6.49 | 1596 | 7.02 |
| 5-10 | 663 | 3.23 | 654 | 3.00 | 978 | 4.19 | 1083 | 4.45 | 811 | 3.42 | 870 | 3.83 |
| 10-15 | 307 | 1.49 | 322 | 1.48 | 359 | 1.54 | 362 | 1.49 | 353 | 1.49 | 330 | 1.45 |
| 15-20 | 613 | 2.99 | 587 | 2.71 | 623 | 2.67 | 601 | 2.47 | 584 | 2.47 | 546 | 2.40 |
| 20-30 | 1927 | 9.38 | 2095 | 9.65 | 2022 | 8.65 | 2051 | 8.44 | 2079 | 8.78 | 1941 | 8.55 |
| 30-40 | 1824 | 8.88 | 2018 | 9.29 | 2047 | 8.76 | 2173 | 8.94 | 2119 | 8.66 | 1987 | 8.76 |
| 40-50 | 1673 | 8.15 | 1854 | 8.53 | 1812 | 7.75 | 1893 | 7.67 | 2037 | 8.62 | 1918 | 8.45 |
| 50-60 | 1561 | 7.60 | 1717 | 7.91 | 1855 | 7.94 | 1990 | 8.19 | 1990 | 8.42 | 1932 | 8.51 |
| 60-70 | 1786 | 8.69 | 1953 | 8.98 | 2122 | 9.09 | 2070 | 8.52 | 2126 | 9.00 | 2029 | 8.90 |
| 70-80 | 1491 | 7.26 | 1604 | 7.38 | 1975 | 8.45 | 1866 | 7.43 | 1818 | 7.69 | 1766 | 7.78 |
| 80-90 | 817 | 3.98 | 850 | 3.91 | 954 | 4.08 | 944 | 3.89 | 893 | 3.77 | 801 | 3.53 |
| 90-100 | 116 | .56 | 158 | .73 | 133 | .56 | 159 | .65 | 144 | .61 | 123 | .54 |
| 100-110 | 6 | .03 | 8 | .03 | 8 | .03 | 5 | .02 | 10 | .04 | 6 | .02 |
| 110-120 | | | | | | | | | | | | |

The high infantile mortality is due, primarily, to the effects of faulty nutrition, owing to the fact that so many infants must be fed with artificial foods. The secondary causes of the high infant mortality are the acute catarrhal inflammations of the gastro-intestinal and respiratory tracts. The following table shows the relative frequency of the diseases of the type of acute catarrhal inflammations of the gastro-intestinal and respiratory tracts as compared with the death-rate from the acute infectious diseases, of diseases of the nervous system, and the deaths from all causes in children under one year of age, in Philadelphia during the years 1890 to 1894, inclusive:

| Deaths under one year from— | 1890. | 1891. | 1892. | 1893. | 1894. |
|---|-------|-------|-------|-------|-------|
| All causes | 5288 | 5488 | 5693 | 5710 | 5472 |
| Diseases of gastro-intestinal tract | 2223 | 2479 | 2683 | 2744 | 2694 |
| Diseases of respiratory tract | 767 | 809 | 882 | 856 | 775 |
| Acute infectious diseases | 325 | 303 | 300 | 328 | 325 |
| Diseases of nervous system | 940 | 986 | 908 | 916 | 843 |

The following table shows the total number of deaths

occurring in Philadelphia during 1894, the number of deaths occurring between the ages of twenty and sixty years, and the principal diseases from which these deaths have occurred:

| | |
|---|--------|
| Total number of deaths, all ages | 22,680 |
| All causes, twenty to sixty years | 7,778 |
| Tuberculosis, twenty to sixty years | 2,014 |
| Inflammation of the lungs | 754 |
| Diseases of the heart | 650 |
| Cancer | 340 |
| Casualties | 333 |
| Bright's disease | 267 |
| Apoplexy | 265 |
| Typhoid fever | 251 |
| Inflammation of kidneys | 227 |
| Inflammation of peritoneum | 210 |
| Inflammation of stomach and bowels | 130 |
| Uremia | 125 |
| Paralysis | 117 |
| Suicide | 103 |

The principal causes of death in persons over sixty years of age are shown in the following table, as indicated by the annual reports of the Bureau of Health of Philadelphia for the years 1890 to 1894, inclusive. The table also shows the total number of deaths for the same years, and the deaths from all causes for persons over sixty years of age.

| | 1890. | 1891. | 1892. | 1893. | 1894. |
|--|--------|--------|--------|--------|--------|
| Total deaths, all ages | 22,732 | 23,367 | 24,305 | 23,655 | 22,680 |
| All causes, over sixty years | 4,573 | 5,192 | 4,984 | 4,989 | 4,725 |
| Old age | 816 | 736 | 791 | 796 | 717 |
| Diseases of the heart | 605 | 690 | 639 | 691 | 588 |
| Inflammation of the lungs | 398 | 568 | 470 | 465 | 425 |
| Apoplexy | 314 | 386 | 410 | 456 | 439 |
| Paralysis | 263 | 302 | 257 | 243 | 218 |
| Tuberculosis | 234 | 255 | 232 | 257 | 240 |
| Cancer | 224 | 201 | 210 | 262 | 223 |
| Bright's disease | 165 | 215 | 202 | 196 | 183 |
| Influenza | 51 | 174 | 150 | 62 | 162 |
| Inflammation of bronchi | 138 | 147 | 154 | 145 | 136 |
| Inflammation of stomach and bowels | 102 | 120 | 99 | 138 | 125 |
| Inflammation of kidneys | 91 | 92 | 94 | 129 | 178 |
| Debility | 110 | 104 | 100 | 40 | 26 |

In the period of life now under discussion, the period of decline, diseases dependent upon degenerations of the tissues and organs are the most prevalent, especially diseases of the vascular system, and it is probable that the causes of those deaths described by the vague terms "old age" and "debility" are usually dependent upon degenerations of this character.

2. *Sex.*—The influence of sex as a predisposing cause of disease does not manifest itself to any extent until after puberty, and again becomes less marked after the age of forty-five to fifty years. Certain diseases are far more prevalent in women than in men, such as hysteria and allied nervous diseases; while epilepsy, locomotor ataxia, gout, and acute diseases of the respiratory tract are more prevalent in men than in women. Women have a greater average longevity than men, because they are exposed less and are not engaged in such dangerous occupations.

The following table, showing the death-rate per 1000 living in the registration area of the United States, 1900, by age and sex, was taken from the Twelfth Census, 1900:

| AGE PERIODS. | Males. | Females. |
|--|--------|----------|
| Under five years | 56.7 | 47.5 |
| Five to fourteen years | 4.4 | 4.2 |
| Fifteen to twenty-four years | 6.7 | 6.1 |
| Twenty-five to thirty-four years | 9.5 | 8.5 |
| Thirty-five to forty-four years | 12.4 | 10.5 |
| Forty-five to sixty-four years | 24.1 | 20.1 |
| Sixty-five and over | 91.1 | 82.6 |
| All ages | 18.9 | 16.6 |

3. *Heredity.*—Hereditary influences are such as act from within the body, and are, therefore, non-preventable. The influence of heredity is shown in the greater prevalence of certain diseases in one family than another. This difference is brought about by certain constitutional conditions which are transmitted from generation to generation, and consists in a lessened capability of resisting unfavorable influences upon the system. This condition was believed, until recently, to be actually a transmission of disease, as, for instance, in tuberculosis.

Since the discovery of the specific micro-organisms of a number of diseases the theory of direct transmission has been discarded to a great extent. At the present time it is believed, however, that a predisposition to develop tuberculosis is transmitted, and that in these subjects the disease is far more readily developed than in those without such hereditary predisposition. In like manner the transmission of a predisposition to develop other constitutional diseases is recognized to-day, such as carcinoma, gout, rheumatism, diabetes, disease of the circulatory organs, disease of the nervous system, especially insanity and hysteria, and malformations.

When the hereditary influences show themselves in the same sex in the offspring as in the parent, they are said to be homeomorphous, and when they show themselves in the opposite sex they are said to be heteromorphous.

Hereditary influences are intensified by the intermarriage of near relations, because these influences may be present in both parents.

Connate Conditions.—Connate conditions are such as are born into a person, as temperament, idiosyncrasy, and diathesis. Temperament refers mainly to the external appearance of the person, and indicates tendencies in various directions. The principal temperaments are the sanguine, the lymphatic, the neurotic, and the melancholic temperament. Idiosyncrasy has reference to special liability to certain affections, as hay fever; or peculiar susceptibility to the influence of drugs, as ipecac, opium, quinin, etc., or to certain articles of diet, as shell-fish, berries, etc. Diathesis has reference to special tendencies or predisposition to particular diseases, as catarrhal affections; the gouty and rheumatic diatheses, etc.; and indicates a weakness in a particular part of the body.

The late Prof. J. G. Richardson¹ states that "persons of a sanguine temperament are believed to be especially liable to organic diseases of the heart, to aneurysms, and to

¹ *Long Life, and How to Reach It.*

the bursting of blood-vessels in various parts of the body, so that they should especially guard against articles of food and habits of life which promote the formation of an excess of blood in the system. Individuals of lymphatic temperament seem particularly prone to scrofulous affections, consumption, dropsy, and skin diseases. Those of bilious temperament, to diseases of the liver, stomach, and intestines; and those of nervous temperament to palsy, St. Vitus's dance, epileptic fits, etc."

4. *Race*.—The influence of race as a predisposing cause of disease is quite marked for some races. The Jews, as shown in a special study of this race by Dr. John S. Billings, are more liable to diseases of the nervous system, especially diseases of the spinal cord, to diarrheal diseases, diphtheria, diseases of the circulatory organs, the urinary system, bones and joints, and diseases of the skin. They are less liable to tuberculosis than their neighbors.

Detailed studies of the vital statistics of Boston, New York and Brooklyn, Philadelphia, Baltimore, and Washington for the six years ending May 31, 1890, by Dr. Billings, have shown that the death-rate among children of Irish mothers is greater from consumption, pneumonia, inanition, debility, atrophy, heart disease and dropsy, and from typhoid fever, than among children of German mothers, while the death-rate among children of German mothers is markedly greater from Bright's disease than that of children of Irish mothers. A large part of the excessive death-rate among children of Irish mothers is due to tubercular diseases, and to the effects of alcohol, which last include a considerable part of the diseases of the nervous system, of the digestive tract, and of the urinary organs among adults. Cancer, tumor, and suicides are more frequent among those of German parentage.

The higher death-rate among the colored race was found to be due mainly to the excessively high death-rate among children of that race. The death-rate from consumption, pneumonia, typhoid fever, diphtheria and croup, diarrheal diseases of infants, diseases of the nerv-

ous system, and heart disease and dropsy, was found to be much greater among the colored population than among whites. The negro race is less liable to yellow fever and to malaria than the white race.

5. *Conjugal Condition.*—The influence of conjugal conditions upon death-rates is manifest from the following studies made in Baltimore and Washington for the Eleventh Census :

Death-rates.

| CONJUGAL CONDITION. | Baltimore. | | | | Washington. | | | |
|------------------------|------------|---------|----------|---------|-------------|---------|----------|---------|
| | White. | | Colored. | | White. | | Colored. | |
| | Male. | Female. | Male. | Female. | Male. | Female. | Male. | Female. |
| Single | 9.19 | 6.53 | 13.75 | 13.20 | 10.07 | 6.44 | 19.08 | 14.50 |
| Married | 8.98 | 9.76 | 13.49 | 16.31 | 9.06 | 9.56 | 16.60 | 16.70 |
| Widowed . . . | 26.90 | 12.10 | 12.02 | 14.36 | 40.17 | 13.65 | 50.51 | 15.12 |

The lower death-rate among the married than among either single or widowed is probably due to the better home care these individuals have, and also to the fact that they lead more regular lives. The extremely high death-rate among widowed males is, no doubt, traceable to the influences exerted by the destruction of the home and the effects entailed by this loss. Of course, the age factor also exerts an important influence upon these individuals.

6. *Hygienic Conditions of Environment.*—The influence of overcrowding and general unhealthy surroundings, along with privation and want, are most important as predisposing causes of disease. It is somewhat difficult to obtain statistical evidence of the unfavorable influence upon health of the general hygienic conditions of the surroundings, yet the following table, based upon the special Census Report for Philadelphia in 1890, shows this effect fairly well, especially with regard to the death-rate from consumption. It will be seen that, in general, in those wards in which the number of persons to a dwelling and the number of families to a dwelling are greater than the average for the entire city the death-rate from consumption is also above the average, and that, in general, in those wards in which the number of per-

sons to a dwelling and the number of families to a dwelling are below the average the death-rate from consumption is also below the average for the entire city.

Aside from the influence of overcrowding, there are other conditions of environment that may be classed as predisposing causes of disease. The most prominent of

Philadelphia, 1890. Census Report.

| WARD. | Persons to | | Death-rate per 1000 pop. | Death-rate per 100,000 pop. | Number of families to dwelling. | Population. | Area. |
|-------|------------|--------------------------|--------------------------|-----------------------------|---------------------------------|-------------|--------------------|
| | Dwelling. | Acre. | | | | | |
| | | | All causes. | Consumption. | | | Acres. |
| 5 | 7.48 | 88.94 | 25.67 | 498.02 | 1.43 | 16,987 | 205 |
| 6 | 6.81 | 44.68 | 24.30 | 418.46 | 1.38 | 8,712 | 205 |
| 11 | 6.71 | 95.95 | 28.31 | 330.86 | 1.38 | 12,953 | 135 |
| 4 | 6.53 | 141.56 | 29.98 | 441.11 | 1.24 | 20,384 | 147 |
| 9 | 6.45 | 38.25 | 25.10 | 364.04 | 1.10 | 9,791 | 256 |
| 8 | 6.41 | 61.27 | 24.26 | 332.28 | 1.08 | 16,971 | 278 |
| 7 | 6.35 | 110.14 | 24.30 | 408.91 | 1.20 | 30,179 | 281 |
| 10 | 6.33 | 98.69 | 19.88 | 278.12 | 1.07 | 21,514 | 230 |
| 27 | 6.30 | 4.51 | 31.91 | 504.81 | 1.05 | 32,905 | ¹ 7,475 |
| 3 | 6.19 | 164.67 | 23.91 | 313.33 | 1.23 | 19,925 | 122 |
| 15 | 6.09 | 99.82 | 20.08 | 288.71 | 1.10 | 52,705 | 671 |
| 12 | 6.08 | 114.27 | 21.57 | 314.16 | 1.21 | 14,170 | 124 |
| 2 | 6.06 | 115.62 | 23.93 | 316.35 | 1.23 | 31,563 | 283 |
| 13 | 5.90 | 109.96 | 20.67 | 260.98 | 1.16 | 17,923 | 163 |
| 17 | 5.82 | 122.93 | 28.89 | 355.83 | 1.19 | 19,546 | 161 |
| 34 | 5.66 | (Included in 24th ward). | | | 1.04 | | |
| 14 | 5.61 | 136.43 | 21.47 | 320.62 | 1.11 | 20,737 | 152 |
| 16 | 5.60 | 94.93 | 28.04 | 311.21 | 1.21 | 17,087 | 180 |
| 29 | 5.56 | 87.20 | 20.19 | 293.26 | 1.06 | 54,759 | 896 |
| 20 | 5.55 | 94.84 | 20.77 | 303.14 | 1.14 | 44,480 | 469 |
| 30 | 5.55 | 92.21 | 22.12 | 349.35 | 1.09 | 30,614 | 332 |
| 19 | 5.46 | 126.53 | 23.73 | 310.44 | 1.11 | 55,545 | 447 |
| 24 | 5.41 | 14.07 | 17.95 | 269.24 | 1.05 | 66,277 | 6,224 |
| 22 | 5.40 | 3.68 | 17.77 | 241.27 | 1.03 | 45,329 | 12,738 |
| 21 | 5.35 | 6.44 | 19.45 | 242.86 | 1.05 | 26,900 | 4,563 |
| 26 | 5.32 | 13.18 | 19.48 | 238.37 | 1.05 | 62,138 | 4,788 |
| 25 | 5.25 | 14.41 | 24.29 | 271.55 | 1.06 | 35,945 | 2,641 |
| 33 | 5.23 | 12.23 | 13.07 | 143.47 | 1.06 | 33,171 | 2,844 |
| 31 | 5.17 | 72.31 | 21.46 | 284.92 | 1.03 | 32,974 | 456 |
| 18 | 5.16 | 71.83 | 24.42 | 304.57 | 1.09 | 29,164 | 416 |
| 1 | 5.15 | 15.34 | 22.08 | 275.54 | 1.05 | 53,882 | 3,526 |
| 28 | 5.15 | 14.62 | 15.56 | 185.73 | 1.05 | 46,390 | 3,542 |
| 23 | 5.06 | 1.30 | 18.50 | 219.39 | 1.02 | 35,294 | 27,339 |
| 32 | 5.04 | 118.77 | 14.61 | 192.32 | 1.03 | 30,050 | 518 |
| City | 5.60 | 13.32 | 21.54 | 297.87 | 1.10 | 1,046,964 | 82,807 |

these factors are the nature of the water-supply and the character of the drainage. The relation of these factors

¹ Hospital and Almshouse.

to the public health will be considered in detail in special chapters. Dampness of the soil of a locality is also an important factor, and its influence in relation to consumption has been carefully investigated by Dr. Bowditch, of Boston, and Dr. Buchanan, of London. Their investigations have shown that the death-rate from consumption is in proportion to the dampness of the soil. Dampness of soil is also an important predisposing factor in the production of many other diseases, such as malaria, rheumatism, and catarrhal affections.

The influence of the nature of the occupation, and of the climate of a locality, as predisposing factors of disease will be discussed in detail in special chapters on these subjects.

Sanitary science refers to the investigation of the causes of disease and the means of avoiding or destroying them. It is not a specific department or separate branch of science, but is implied, in part, in a number of sciences, as chemistry, biology, physics, pathology, statistics, etc.

The term *sanitary* means conducive to the preservation of, and the term *sanitory* conducive to the restoration of, health. The sanitary condition of a place has reference to the presence or absence of the specific causes of disease. There is no such thing as *bad* hygiene: A place is either in hygienic condition or it is in an unhealthful condition.

Hygiene aims to discover the causes of all diseases known, and the best means of removing those causes or rendering them inoperative. It takes for granted a knowledge of the normal functions of the human organism, and seeks to discover the reasons for perverted action of a part or the whole of the organism. It involves a thorough knowledge of the normal conditions of man's environment as well as the various factors which tend to render that environment abnormal. It demands a thorough knowledge of the chemical and physical character of man's food-supply and those changes to which it is liable that tend to injure his health and produce disease. It aims to keep persons in perfect health, to train men to

be strong both mentally and physically. It also involves a knowledge of the physical and geological nature of the surface of the earth, and the manner in which these conditions, in different localities, influence the healthfulness of human habitations. It comprises a knowledge of all the various human occupations, and the manner in which these may be conducted so as to be free from danger to health or how to render them least objectionable.

Hygiene may be subdivided into several departments relating to the scope of its application, as public or general, military, naval, personal, municipal, school, and industrial hygiene. Public hygiene takes cognizance of factors which affect the general public, such as nuisances of different kinds: Foul odors, noxious gases or dust evolved in certain manufacturing processes, and loud noises. Nuisances are generally such conditions which aggravate existing disease rather than produce disease. Military, naval, personal, school, and industrial hygiene will be treated more or less generally in special chapters. Municipal hygiene has reference to those conditions which affect the general health of a community that fall directly under the control of municipal governments, such as the influence of impure water-supplies and imperfect drainage upon the general health; the influence of overcrowding in the habitations of the poor; the cleansing of city streets and the removal and satisfactory disposal of refuse matters; the regulation of the isolation and care of those affected with infectious diseases, and the proper disposal of the dead.

Development of Hygiene.—Modern hygiene has been gradually evolved out of the observations and discoveries of many men prominent in philanthropic work, in medicine, and in science. Among the prominent observations and discoveries made during the eighteenth century which have been most instrumental in the development of hygiene may be mentioned the discovery of Sir George Baker with regard to the production of lead-poisoning by cider stored in leaden vessels; the observa-

tions of John Howard with regard to the baneful influence of foul air and overcrowding and unhealthfulness of the surroundings upon the health of the occupants of prisons, poor-houses, and other habitations, and their relation to typhus fever; the demonstration by Captain James Cook, in his voyage around the world, that scurvy was a preventable disease which was due to the nature of the diet; and Sir Edward Jenner's discovery of inoculation as a preventative of small-pox. During the nineteenth century the movements and discoveries which stand out most prominently are the work of Dr. Thomas Southwood Smith and The Sanitary Committee in demonstrating the factors which are instrumental in influencing the health of towns, such as the accumulation of filth about premises, absence of sewers, and consequently the pollution of water-supplies, and the influence of insufficient air-supply and overcrowding upon the general health; the labors of Edwin Chadwick in organizing the first board of health in England; the work of Dr. William Farr, Registrar-General of England, in securing the registration of the *cause* of death in the health reports; the labors of Dr. E. A. Parkes in demonstrating the evil effects of defective drainage and the accumulation of filth upon the public health, and in securing the passage of various sanitary acts from 1848 to 1857; the work of Dr. John Simon, of London, and his able staff of medical inspectors with regard to the material causes of disease, and the legislation which was based upon these investigations; the studies of Dr. C. A. Louis, of Paris, upon typhoid, typhus, and relapsing fevers, and the differentiation between these, as well as similar studies made at the same time by Dr. William W. Gerhard, of Philadelphia; the studies of Dr. Henry I. Bowditch, of Boston, and those of Dr. George Buchanan, of London, upon the influence of dampness of the soil upon the prevalence of consumption; the studies of Louis Pasteur upon the causes of fermentation and the etiologic relation of micro-organisms to disease, as well as his discoveries with regard to the prevention

and treatment of these diseases ; the studies of Sir Joseph Lister with regard to the prevention of suppuration in wounds, which have been the starting-point of modern antiseptic and aseptic surgery ; the work of von Pettenkofer in introducing new methods of chemical research upon air, water, and food, and his studies upon the influence of soil-moisture upon the prevalence of typhoid fever and cholera; and the discoveries of Dr. Robert Koch of the specific micro-organisms of some of the infectious diseases, and in perfecting methods of bacteriologic investigation.

Since we have become acquainted with the direct causative factors of many of the contagious diseases, we have developed preventive measures that were impossible before the causes of disease were known. The discovery of the influence of different chemical and physical agents, in destroying the bacteria outside the body, has been of very great value in limiting the dissemination of disease. The discovery of immune serums, especially the antitoxins of diphtheria and tetanus, has been of great service in limiting the dissemination of disease when employed both as prophylactic and curative agents. The introduction of the methods of inoculation of attenuated living or dead cultures of bacteria for the prevention and cure of bacterial diseases has been an important step forward, especially in the control of cholera, plague, and typhoid fever. The discovery of the influence of certain suctorial insects in the dissemination of disease, as the several species of mosquitoes in the dissemination of malarial fevers, yellow fever, of filariasis, and of dengue ; the rôle played by the rat flea in the dissemination of plague, the tsetse fly in the dissemination of sleeping sickness, and the tick in the dissemination of African "tick" fever, are some of the more important of this class of diseases that can now be controlled more intelligently since the mode of dissemination is known. The introduction of modern methods of water purification and sewage disposal are also important factors in limiting the dissemination of disease by means that were unknown a quarter of a century ago.

CHAPTER I.

AIR.

Nature and Composition of the Atmosphere.—

Atmospheric air consists of a mechanical mixture of gases, the relative proportions of which are fairly constant in all parts of the world. It is colorless, odorless, transparent, and is, therefore, invisible and imperceptible when quiescent. It is only when it is itself in a state of motion, or when our bodies are in rapid motion, that we note its presence through the resistance which it manifests. It also possesses weight, and consequently exerts pressure. At the sea-level, when the temperature is 0° C., the normal pressure of the atmosphere is sufficient to support a column of mercury 760 millimeters in height, and amounts to 1033 grams on every square centimeter of surface. The pressure of the atmosphere decreases as we rise above the level of the sea, and increases as we descend below its level.

The several gases composing the atmosphere are not in chemical combination with each other, but exist as a more or less homogeneous mixture. The principal gases in the mixture are: Nitrogen in the proportion of 78.20 parts, by volume; oxygen, 20.76 parts; argon, 1 part; carbon dioxid, 0.04 part; a trace of ammonia; traces of nitrous and nitric acids; small amounts of ozone; varying proportions of aqueous vapor; and traces of several recently discovered constituents: neon, erythron, and krypton.

The proportion of nitrogen in natural air varies only within extremely narrow limits. It is an indifferent gas, and seems to serve principally as a diluent for the oxygen in the air. So far as known, the only biologic significance of nitrogen is its absorption by plants of the order *Leguminosæ* when growing in symbiosis with certain micro-organisms which find lodgement on the roots of

these plants, and where they cause the formation of the so-called root-tubercles. Indirectly nitrogen is also stored in the soil by certain soil bacteria and in turn vegetation obtains this nitrogen as food in the form of nitrates and ammonia. Argon, neon, erythron, and krypton are likewise inert gases so far as known at the present time.

The proportion of oxygen in the air varies within somewhat wider limits than that of nitrogen, but, under natural conditions, it is fairly constant, because any slight decrease in its proportion in circumscribed localities is readily corrected through the action of the principle of diffusion.

The proportion of carbon dioxid varies usually between 0.03 and 0.05 part per 100, but it is subject to still greater fluctuations at different points on the earth's surface, and at different seasons of the year. The fluctuations in the proportion of carbon dioxid are brought about by the active decomposition and putrefaction of organic matters through the agency of bacteria, and through the combustion of combustible materials in manufacturing centres. The overproduction of carbon dioxid at any point tends to become equalized through the operation of the principle of diffusion and the movements of the atmosphere. The proportion of carbon dioxid is, generally, greatest at the surface of the earth, and decreases as the elevation increases. It is least in winter and greatest in autumn; less during the day than at night; less on the seacoast than inland; and less on windy days than on calm days. It is decidedly diminished by rain, slightly so by snow, and slightly increased during foggy weather.

The relative proportions of oxygen and carbon dioxid are maintained through the combined action of the vegetable and animal world. The animal kingdom absorbs oxygen and gives off carbon dioxid in return as the result of tissue metabolism. On the other hand, those members of the vegetable kingdom which possess chlorophyl in their organism have the property of absorbing carbon dioxid from the air, assimilating the carbon and giving off the oxygen in return. This most

interesting cycle is an important factor in the maintenance of the relative proportions of these two gases in the air.

The proportion of aqueous vapor in air varies with the temperature—the average amount being about 1 per cent. The amount of moisture in the air may vary from less than 0.1 per cent. to as much as 4 per cent. The higher the temperature, the greater the amount of aqueous vapor that is taken up by air. The proportion which is most agreeable to the majority of persons, and therefore the most suitable for health, is about 75 per cent. of saturation at any given temperature.

Ozone—condensed or allotropic oxygen—is present in variable amounts in different places on the earth's surface. The average amount present is 1 milligram per 100 cubic meters of air; the maximum amount being about 3.5 milligrams. This gas is usually absent from the air of cities and the air which has passed through localities that are thickly populated. It is found in the atmosphere over fields covered with vegetation, over forests, and over the ocean. Ozone is an active oxidizing agent, and the air of cities is rich in oxidizable organic matter which absorbs it, consequently it is absent from the air of cities. Generally speaking, the healthiest parts of towns are those receiving the purer and fresher air, containing ozone, coming from cultivated fields, forests, or the ocean.

The amounts of ammonia, nitrous and nitric acids, found in ordinary atmospheric air are insufficient to have any biologic significance. They result principally from putrefaction and from various manufacturing industries.

The atmosphere forms a gaseous envelope which surrounds the earth, reaching a height of from 320 to 350 kilometers above the earth's surface, and penetrating into the porous soil, into caves and mines, and into the ocean to a great depth.

Temperature of the Air.—There are three main factors that influence the temperature of the air of any place, viz., latitude, altitude, and the relative proximity of large bodies of water. The temperature is greatest.

these plants, and where they cause the formation of the so-called root-tubercles. Indirectly nitrogen is also stored in the soil by certain soil bacteria and in turn vegetation obtains this nitrogen as food in the form of nitrates and ammonia. Argon, neon, erythron, and krypton are likewise inert gases so far as known at the present time.

The proportion of oxygen in the air varies within somewhat wider limits than that of nitrogen, but, under natural conditions, it is fairly constant, because any slight decrease in its proportion in circumscribed localities is readily corrected through the action of the principle of diffusion.

The proportion of carbon dioxid varies usually between 0.03 and 0.05 part per 100, but it is subject to still greater fluctuations at different points on the earth's surface, and at different seasons of the year. The fluctuations in the proportion of carbon dioxid are brought about by the active decomposition and putrefaction of organic matters through the agency of bacteria, and through the combustion of combustible materials in manufacturing centres. The overproduction of carbon dioxid at any point tends to become equalized through the operation of the principle of diffusion and the movements of the atmosphere. The proportion of carbon dioxid is, generally, greatest at the surface of the earth, and decreases as the elevation increases. It is least in winter and greatest in autumn; less during the day than at night; less on the seacoast than inland; and less on windy days than on calm days. It is decidedly diminished by rain, slightly so by snow, and slightly increased during foggy weather.

The relative proportions of oxygen and carbon dioxid are maintained through the combined action of the vegetable and animal world. The animal kingdom absorbs oxygen and gives off carbon dioxid in return as the result of tissue metabolism. On the other hand, those members of the vegetable kingdom which possess chlorophyl in their organism have the property of absorbing carbon dioxid from the air, assimilating the carbon and giving off the oxygen in return. This most

interesting cycle is an important factor in the maintenance of the relative proportions of these two gases in the air.

The proportion of aqueous vapor in air varies with the temperature—the average amount being about 1 per cent. The amount of moisture in the air may vary from less than 0.1 per cent. to as much as 4 per cent. The higher the temperature, the greater the amount of aqueous vapor that is taken up by air. The proportion which is most agreeable to the majority of persons, and therefore the most suitable for health, is about 75 per cent. of saturation at any given temperature.

Ozone—condensed or allotropic oxygen—is present in variable amounts in different places on the earth's surface. The average amount present is 1 milligram per 100 cubic meters of air; the maximum amount being about 3.5 milligrams. This gas is usually absent from the air of cities and the air which has passed through localities that are thickly populated. It is found in the atmosphere over fields covered with vegetation, over forests, and over the ocean. Ozone is an active oxidizing agent, and the air of cities is rich in oxidizable organic matter which absorbs it, consequently it is absent from the air of cities. Generally speaking, the healthiest parts of towns are those receiving the purer and fresher air, containing ozone, coming from cultivated fields, forests, or the ocean.

The amounts of ammonia, nitrous and nitric acids, found in ordinary atmospheric air are insufficient to have any biologic significance. They result principally from putrefaction and from various manufacturing industries.

The atmosphere forms a gaseous envelope which surrounds the earth, reaching a height of from 320 to 350 kilometers above the earth's surface, and penetrating into the porous soil, into caves and mines, and into the ocean to a great depth.

Temperature of the Air.—There are three main factors that influence the temperature of the air of any place, viz., latitude, altitude, and the relative proximity of large bodies of water. The temperature is greatest.

near the equator and decreases proportionately with the distance traversed in passing from the equator to the north or south pole. The temperature is also higher at the level of the sea than on the top of a mountain in the same latitude. Places near the seacoast also have a more equable climate than those in the interior. The other factors which influence the temperature of a locality are: The conformation of the earth's surface; the nature of the soil; the character and extent of the soil-covering; and the direction of the prevailing winds. Owing to the high specific heat of water (about five times that of earth and rocks) the ocean absorbs heat slowly and gives it off slowly, and, therefore, it acts as a reservoir of the heat, absorbing it during the day and giving it off during the night, also absorbing it during the summer and giving it off during the winter, thus lessening the heat of summer as well as the cold of winter for places along the seacoast.

Pressure of the Atmosphere.—The average pressure of the atmosphere varies according to the altitude of the locality, and also in the same locality at different times. At the sea-level this average pressure amounts to a little over a kilogram per square centimeter, and is sufficient to support a column of mercury 760 millimeters in height; hence the total weight supported by an average man is about 18,000 kilograms. This weight or pressure is considerable, but it is unnoticed because it is equalized by the internal pressure of our bodies, which adapt themselves to the normal fluctuations in the atmospheric pressure. Variations in the atmospheric pressure are measured by means of barometers. The mercurial barometer is usually employed in making these observations (Fig. 1). Marked deviations from the normal atmospheric pressure, such as are found in exceedingly high altitudes, in balloon ascensions to great heights, or when descending to great depths in mines, or working in tunnels, are manifested by effects which are referable to the increased or decreased tension of the atmosphere. Rarefied air as found at great heights induces a condition known as mountain sickness or balloon sickness, and consists in increased heart action,

more rapid respiration, headache, followed by graver symptoms as the rarefaction increases, such as vomiting of food, bile, and blood, with great pain in the stomach, followed by death. There are frequently minute hemorrhages into the spinal cord as the result of inspiring rarefied air. The insufficient supply of oxygen in the rarefied air is perhaps the principal cause of the symptoms manifested.

The effects of passing from the normal atmospheric pressure to a greater pressure, as in diving-bells, in tunnels under rivers, are different from those seen on ascending to a great height, and here the effects are due to the increased pressure upon the body. Every 10 meters of water adds the pressure of 1 atmosphere—1 kilogram per square centimeter of body surface. The increased pressure causes the sudden liberation of gases in the tissues and blood, where they interfere with the circulation and stop the heart. The difference in pressure on the tympanic cavity causes vertigo and pain in the ear, and if the difference in pressure is great the drum of the ear may be ruptured when the Eustachian tube is occluded. Ordinarily the difference in pressure is equalized by the act of swallowing. On coming out of a caisson the reverse in internal and external pressure takes place. This is also relieved in the same manner. Man can work at a kilometer below the sea-level without injury, and he can travel to a height of 5 or 6 kilometers without being affected by

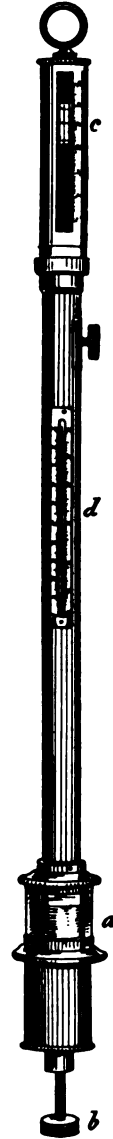

FIG. 1.—Mercurial barometer: *a*, cistern containing the mercury; *b*, screw in movable bottom of cistern, to raise or lower the mercury to the "fiducial" point; *c*, the vernier; *d*, the thermometer.

the decrease of pressure. When the pressure is suddenly increased or decreased beyond these points the effects are manifested. The more slowly the change is brought about, and the smaller the amount of exertion accompanying the change of pressure, the less the effect produced. Great variations from the normal atmospheric pressure are highly injurious to all persons suffering from organic disease of the heart and lungs, and to those suffering from an atheromatous condition of the arteries, because this condition prevents the arteries from readily adjusting themselves to the altered pressure, thus leading to hemorrhages. In coming out of the caisson the change in pressure must be brought about slowly. The too rapid change induces spinal hemorrhage. At least six to ten minutes should be allowed for each additional atmosphere of pressure to make the change safely. The air-locks, where the change of pressure is made, should be at the top of the shaft, and not at the bottom, so that the men are not obliged to climb the ladder when they come into the ordinary pressure.

Distribution of Atmospheric Pressure.—The barometer is high (1) when the air is very cold, for then the lower strata are denser and more contracted than when it is warm. The contraction causes the upper layers to sink down, bringing a greater number of air-particles—that is, a greater mass of air—into the column, so that the pressure at its base is greater; (2) when the air is dry, for then it is denser than when it is moist; (3) when in any way an upper current sets in toward a given area, for this compresses the strata underneath.

Conversely, the barometer is low (1) when the lower strata are heated, causing the surfaces of equal pressure to rise, and the upper layers to slide off, consequently the mass of air pressing on the area below is reduced; (2) when the air is damp, for as the density of aqueous vapor at 0° C. temperature and 760 millimeters pressure is 0.7721, air being 1, the mixture is lighter the more vapor it contains, and consequently damp air does not

press as heavily as dry air on the unit of area below; (3) when the air, from any cause, has an upward movement, for this, of course, acts in the same manner as when the lower strata are heated.

Humidity of the Atmosphere.—Atmospheric air contains more or less watery vapor at all times. The quantity of water present in the air, at any time and place, is

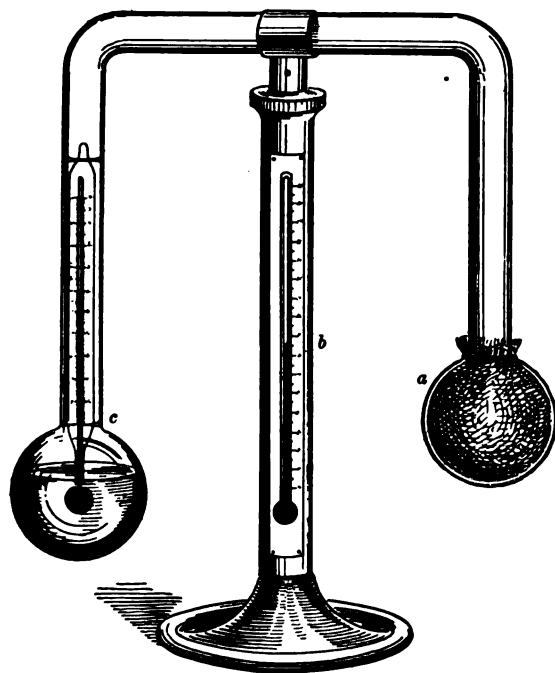

FIG. 2.—Daniell's hygrometer: *a*, bulb surrounded with cotton cloth; *b*, thermometer; *c*, bulb containing thermometer.

dependent—(*a*) upon the possibility of the air obtaining moisture from the surface of a large body of water; (*b*) upon the rate of diffusion of the moist air of the locality and its replacement by drier air; and (*c*) changes in the temperature of the air, inducing precipitation of the contained moisture. There is constant evaporation from the surface of bodies of water during sunshine. Considerable

evaporation also takes place from damp soil. The degree of humidity of the air at a particular point is dependent principally upon the rate of diffusion through which the

moist air is replaced by drier air. The humidity of the atmosphere is also influenced through precipitation. Whenever the air of a locality becomes saturated with moisture and then is cooled suddenly, some of the moisture is precipitated in the form of rain, hail, or snow.

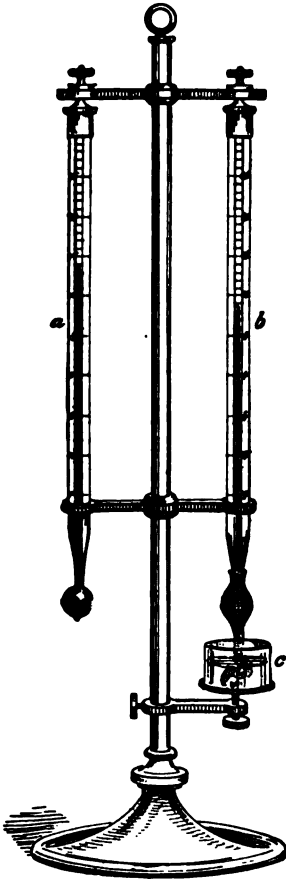

FIG. 3.—Psychrometer: *a*, dry-bulb thermometer; *b*, wet-bulb thermometer; *c*, reservoir containing water.

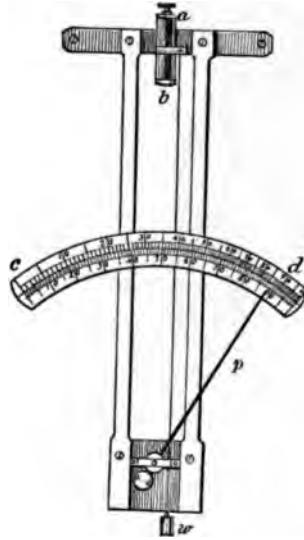

FIG. 4.—The hair hygrometer: *a*, *b*, point of suspension of hair; *p*, pointer; *c*, *d*, scale; *w*, weight.

Hygrometry.—Hygrometry is the determination of the amount of aqueous vapor in the air. Hygrometers are either direct, as Daniell's (Fig. 2), Dine's, and Regnault's, and determine directly the dew-point of the atmosphere; or indirect, as the wet- and dry-bulb ther-

rometer, or psychrometer (Fig. 3), and the hair hygrometer (Fig. 4).

The important items of information to be derived from observations with hygrometers are: The dew-point, the vapor-tension or absolute humidity, and the relative humidity of the atmosphere. The dew-point is that temperature at which the air is saturated with moisture, so that the least further fall in temperature causes a deposit of moisture in the form of dew. The higher the temperature of the air, the larger the amount of water it can contain in the form of vapor; and if the temperature be lowered, the amount of moisture remaining the same, eventually a point will be reached at which some of the moisture is precipitated. This temperature is indicated directly by the condensation hygrometers, or it can be calculated from the readings of the psychrometer, with the aid of tables or by means of Apjohn's formula:

E = elastic force of vapor corresponding to the dew-point,

e = elastic force corresponding to temperature of evaporation (wet-bulb thermometer),

t = dry-bulb temperature,

t' = wet-bulb temperature, and

h = height of barometer in millimeters.

$$E = e - 0.01147 (t - t') \times \frac{h - e}{30}.$$

For pressures of about 760 millimeters, $\frac{h - e}{30}$ may be neglected, and the formula becomes

$$E = e - \frac{(t - t')}{87}.$$

For temperatures below 0° C. the formula is

$$E = e - \frac{t - t'}{96}.$$

The tension (E) of the aqueous vapor in the atmosphere may be calculated from the readings of the wet- and dry-bulb thermometers by means of the following empirical formula:

$$E = e' - 0.00077 (t - t') \times h,$$

in which e^1 is the maximum tension corresponding to the temperature of the wet-bulb thermometer (Ganot).

If the dew-point is known, either by calculation from the readings of the wet- and dry-bulb thermometers, or by direct observation by means of the hygrometer, the elastic force or tension of vapor present in the atmosphere is found immediately by reference to a table of tensions.

Elastic Force of Vapor.—This is the amount of barometric pressure due to the vapor present in the air. The tension of aqueous vapor at 100° C. temperature is 760 millimeters—that is, the pressure of 1 atmosphere. At lower temperatures the elastic force of vapor is less than at 100° C. It is greatest within the tropics and diminishes toward the poles; it is greatest over the ocean, and decreases as we pass inland; it is greater in summer than in winter; it is greater at midday than in the morning; and it generally diminishes with increased elevation.

Absolute Humidity.—This is the weight of water in the form of vapor contained in a given volume of air expressed in grams per cubic meter. It varies with the temperature, and it may be computed from the readings of the wet- and dry-bulb thermometers by the use of tables.

Relative Humidity.—Complete saturation of the air being taken as 100, any degree of dryness may be expressed in percentage. The amount of aqueous vapor actually present, and the amount that would be present if the air were saturated, being known, the former is expressed as a percentage of the latter, giving the relative humidity. Relative humidity is greatest near the surface of the earth during night, when the temperature, being at or near the daily minimum, reaches the dew-point; it is also great in the morning, when the sun's rays have evaporated the dew, and the vapor is as yet diffused only a little way upward; and it is least during the greatest heat of the day.

The Influence of Humidity on Health.—The amount of relative humidity of the atmosphere, or its complement the deficiency of saturation, is of the greatest importance. The temperature of the body is regulated by the loss of heat by evaporation from the lungs and skin. At a temperature of 15° C., and with the relative humidity at 75 per cent., Pettenkofer and Voit estimated the loss of water from the lungs at 286 grams, and from the skin at 500 to 1700 grams daily. If the relative humidity be increased, there will be a hindrance to the escape of water from the body; and when this condition is combined with a high temperature the heat is far more oppressive than when the atmosphere is dry and allows free evaporation. On the other hand, a moist, cold atmosphere is far more distressing than when the air is dry and there is but little movement.

Movements of the Atmosphere.—The air is in constant motion as the result of changes in temperature affecting the density of the air of certain localities, the less dense or heated air being displaced by the colder, denser air. The direction in which the movement takes place is always along the line of least resistance and toward the point of less density. The rapidity of the movement is directly proportional to the magnitude of the change in density—that is, the rise in temperature. The most important cause of these movements is the relatively larger amount of heat transmitted by the sun in the tropics, which gives rise to what are known as “trade” winds. The varying amounts of heat transmitted by the sun in different latitudes and at different altitudes, and the variations in the temperature due to the revolutions of the earth on its axis, are the principal causes of winds. These movements of the atmosphere play an important part in the regulation of temperature and of the humidity of the air. If they did not occur, air would be perpetually warm in some places and perpetually cold in others. The wind carries warm air to cold regions and cold air to warm regions, thus tempering the climate of each. The wind also prevents the air

from remaining excessively dry in some regions and inordinately damp in others.

The **effects of wind upon health** are complex and not well defined. All wind, or movement of the air, favors evaporation, and therefore loss of heat from the body, unless the wind itself be warm and moist; a hot, dry wind favors evaporation but does not lower the temperature; a cold, moist wind lowers the temperature but does not increase the evaporation. Winds that are warm and moist are mild and relaxing; dry, cool winds are bracing; but cold winds are penetrating, and are considered dangerous to persons of delicate constitution.

Clouds.—When the condensed moisture of the air collects as fog in the lower strata and rises into the upper strata it takes the form and appearance which we call clouds. Clouds moderate radiation, both solar and terrestrial, and, therefore, have an equalizing influence on the temperature. Their amount is estimated from 0 (clear sky) to 10 (entirely overcast). There is most cloud in winter, in the middle of the day, and least in May and June, during the night.

Precipitation of Moisture.—The amount of cloud-formation bears a certain relation to the amount of precipitation. According to the temperature of the air, the precipitation takes place in the form of rain, snow, hail, or sleet. The amount of rainfall in a locality is dependent to a certain extent upon its vicinity to large bodies of water, upon the direction of the prevailing winds, upon the altitude, and upon the latitude. The nature and extent of the soil-covering of the locality also have a direct influence upon the amount of rainfall, as shown by the diminished rainfall in localities where the forests have been destroyed. The immediate effect of a fall of rain is to cleanse and purify the air from dust of all sorts, organic and inorganic, and from micro-organisms. Its action with regard to the micro-organisms is twofold: It not only washes them out of the air, but it tends to prevent their rising from the soil by rendering the surface

of the ground moist. So far the influence of rain is decidedly beneficial to health; but when rainfall is so excessive as largely to increase the humidity of the air, its hygienic effect becomes merged in that of humidity. Also, when the amount is so great as to render the soil waterlogged its effect becomes overshadowed by the effects of a damp soil.

Climate.—By climate we understand all the meteorologic conditions of a place or locality which have an influence upon health. Along with these conditions the character of the soil is also an important factor in determining and regulating the nature of the climate of a locality. Of all these conditions, meteorologic and telluric, temperature is the most important in determining the character of a climate, while humidity is the factor next in importance. Buchan states that there are four principal factors in the production of the climate of any locality: (1) Distance from the equator; (2) height above the sea-level; (3) distance from the sea; and (4) prevailing winds. Of the various classifications of climates that have been proposed, perhaps as satisfactory as any is one that rests mainly upon the first three conditions named, the fourth condition, that of the prevailing winds, introducing important modifications. Of all the factors, distance from the equator is incomparably the most potent, but irregularities in the distribution of land and water, and the prevalence of particular winds, often bring about a subversion of what Humboldt calls the solar climate of the earth. Differences of elevation also cause great differences in the climate of nearly adjacent places.

Climates may be divided into tropical, temperate, and polar; and the first two of these may be subdivided into continental, maritime, and mountain climates. A continental climate is subject to the extremes of heat and cold; has an atmospheric pressure that is normal; a moderate rainfall; slight humidity; often a clear sky; and variable winds. A maritime climate is equable—that is, without extremes of temperature; with consider-

NORMAL TEMPERATURE AND RAINFALL IN THE UNITED STATES
At Weather Bureau Stations; also Highest and Lowest Temperatures ever
Reported to September 1, 1899.

| States and territories. | Stations. | Temperature. | | | | Mean annual precipitation. Rain and melted snow. |
|--------------------------|-----------------------------|--------------|-------|---------------|--------------|---|
| | | Mean. | | Extreme. | | |
| | | Jan. | July. | High- est. | Low- est. | |
| | | ° C. | ° C. | ° C. | ° C. | Cm. |
| Alabama | { Mobile | 10.0 | 27.7 | 38.3 | -18.3 | 157.9 |
| | { Montgomery | 8.8 | 27.7 | 41.6 | -20.5 | 133.7 |
| Arizona | { Yuma | 12.2 | 33.3 | 47.7 | -5.5 | 7.6 |
| | { Fort Smith | 1.1 | 26.0 | 42.2 | -26.1 | 113.5 |
| Arkansas | { Little Rock | 4.4 | 27.3 | 40.5 | -22.2 | 136.1 |
| | { Red Bluff | 7.7 | 27.7 | 45.5 | -7.7 | 66.2 |
| California | { Sacramento | 7.7 | 22.2 | 43.3 | -8.3 | 53.0 |
| | { San Diego | 12.2 | 19.4 | 38.3 | -0.0 | 26.6 |
| Colorado | { Denver | -2.7 | 22.2 | 40.5 | -33.8 | 36.3 |
| Connecticut | { New Haven | -2.7 | 22.2 | 37.7 | -25.5 | 127.7 |
| Delaware | { Del. Breakwater | -0.5 | 22.7 | 33.8 | -17.2 | 82.8 |
| Dist. of Columbia | { Washington | -0.5 | 25.0 | 40.0 | -26.1 | 110.4 |
| Florida | { Jacksonville | 12.7 | 27.7 | 40.0 | -12.1 | 137.3 |
| | { Key West | 21.1 | 28.8 | 37.7 | 5.0 | 97.7 |
| Georgia | { Atlanta | 6.1 | 25.5 | 37.7 | -22.2 | 132.0 |
| | { Savannah | 10.5 | 27.7 | 40.5 | -13.3 | 131.8 |
| Idaho | { Boise | -2.2 | 23.3 | 41.6 | -33.3 | 33.5 |
| Illinois | { Chicago | -3.3 | 22.2 | 37.7 | -30.5 | 88.3 |
| | { Springfield | -3.8 | 25.0 | 38.8 | -30.0 | 96.5 |
| Indiana | { Indianapolis | -2.2 | 24.4 | 38.3 | -31.7 | 109.2 |
| Indian Territory | { Fort Sill | 1.3 | 27.7 | 41.6 | -22.7 | 79.2 |
| | { Des Moines | -8.3 | 23.7 | 40.0 | -34.4 | 84.0 |
| Iowa | { Keokuk | -5.0 | 25.0 | 40.0 | -31.1 | 90.4 |
| Kansas | { Dodge | -3.8 | 25.5 | 42.2 | -32.2 | 50.2 |
| Kentucky | { Louisville | 1.1 | 26.1 | 40.5 | -28.8 | 116.3 |
| Louisiana | { New Orleans | 12.2 | 28.3 | 37.3 | -13.9 | 153.6 |
| | { Shreveport | 7.3 | 28.3 | 41.6 | -20.5 | 123.4 |
| Maine | { Eastport | -5.0 | 15.5 | 32.7 | -29.4 | 114.8 |
| | { Portland | -6.6 | 20.7 | 36.1 | -27.3 | 107.4 |
| Maryland | { Baltimore | 1.1 | 25.5 | 40.0 | 21.6 | 111.2 |
| Massachusetts | { Boston | -3.3 | 21.6 | 38.3 | -25.0 | 114.3 |
| | { Marquette | -8.8 | 18.3 | 37.7 | -32.7 | 82.2 |
| Michigan | { Port Huron | -6.1 | 20.7 | 37.3 | -31.7 | 80.2 |
| Minnesota | { Duluth | -12.2 | 18.8 | 37.3 | -41.7 | 78.7 |
| | { St. Paul | -11.7 | 22.2 | 37.7 | -41.7 | 69.8 |
| Mississippi | { Vicksburg | 8.3 | 27.7 | 38.3 | -18.3 | 141.4 |
| Missouri | { St. Louis | -1.1 | 26.1 | 41.1 | -30.5 | 104.3 |
| | { Springfield | 0.0 | 23.7 | 38.8 | -33.8 | 116.0 |
| Montana | { Havre | -12.7 | 19.4 | 42.2 | -48.3 | 35.8 |
| | { Omaha | -7.3 | 24.4 | 41.1 | -35.5 | 80.5 |
| Nebraska | { Valentine | -10.0 | 23.3 | 41.1 | -38.8 | 48.5 |
| Nevada | { Winnemucca | -2.2 | 22.2 | 40.0 | -33.3 | 21.5 |
| North Carolina | { Hatteras | 6.6 | 25.5 | 33.3 | -13.3 | 168.6 |
| | { Wilmington | 8.3 | 26.6 | 39.4 | -15.0 | 137.8 |
| North Dakota | { Bismark | -15.5 | 19.4 | 40.5 | -42.2 | 46.7 |
| | { Williston | -16.1 | 20.0 | 41.6 | -45.0 | 35.5 |
| New Hampshire | { Manchester | -5.5 | 20.7 | 35.5 | -23.9 | 106.4 |
| New Jersey | { Cape May | 1.1 | 23.3 | 32.7 | -19.4 | 119.8 |
| | { New Brunswick | -2.2 | 23.3 | 37.7 | -23.3 | 118.8 |
| New Mexico | { Sante Fé | -2.2 | 20.0 | 36.1 | -25.0 | 40.5 |
| | { Albany | -5.0 | 22.7 | 37.7 | -27.7 | 96.2 |
| New York | { New York | -1.1 | 23.3 | 37.7 | -21.1 | 113.7 |
| | { Oswego | -3.8 | 20.7 | 37.7 | -30.5 | 88.9 |

| States and territories. | Stations. | Temperature. | | | | Mean annual precipitation. Rain and melted snow. |
|--------------------------|------------------------|--------------|-------|-----------|----------|--|
| | | Mean. | | Extreme. | | |
| | | Jan. | July. | High-est. | Low-est. | |
| | | ° C. | ° C. | ° C. | ° C. | Cm. |
| Ohio | { Cincinnati . . . | -0.5 | 25.5 | 40.0 | -27.3 | 101.3 |
| | { Toledo | -3.3 | 22.7 | 37.3 | -26.6 | 78.4 |
| Oregon | { Portland | 3.8 | 19.4 | 38.8 | -18.8 | 118.8 |
| | { Roseburg | 4.4 | 18.8 | 40.0 | -21.1 | 89.4 |
| Pennsylvania | { Philadelphia . . . | 0.0 | 24.4 | 38.8 | -21.1 | 101.2 |
| | { Pittsburg | -1.1 | 22.7 | 39.4 | -28.8 | 93.2 |
| Rhode Island | { Newport | -1.1 | 21.1 | 33.3 | -22.2 | 127.0 |
| South Carolina | { Charleston | 9.4 | 27.7 | 40.0 | -13.9 | 143.9 |
| South Dakota | { Yankton | -10.5 | 22.7 | 39.4 | -36.6 | 68.0 |
| Tennessee | { Memphis | 4.4 | 27.3 | 38.8 | -22.7 | 135.3 |
| | { Nashville | 3.3 | 26.6 | 40.0 | -25.0 | 127.2 |
| Texas | { El Paso | 6.6 | 27.7 | 45.0 | -20.5 | 23.6 |
| | { Palestine | 6.1 | 27.7 | 40.0 | -21.1 | 118.1 |
| Utah | { Salt Lake | -2.2 | 24.4 | 38.8 | -28.8 | 41.1 |
| Vermont | { Burlington | -7.2 | 21.6 | 36.1 | -31.7 | 72.2 |
| Virginia | { Lynchburg | 2.2 | 25.5 | 38.8 | -21.1 | 108.6 |
| | { Norfolk | 4.4 | 26.1 | 38.8 | -16.6 | 132.3 |
| Washington | { Dayton | -1.1 | 20.0 | 42.7 | -32.2 | 70.5 |
| | { Olympia | 3.3 | 16.6 | 36.1 | -18.8 | 134.8 |
| West Virginia | { Morgantown | 1.6 | 23.3 | 36.1 | -31.7 | 119.1 |
| Wisconsin | { La Crosse | -9.4 | 22.7 | 38.3 | -41.6 | 77.9 |
| | { Milwaukee | -7.2 | 20.7 | 37.7 | -31.7 | 81.5 |
| Wyoming | { Cheyenne | -3.8 | 19.4 | 37.7 | -38.8 | 30.9 |

NOTE.—The minus (-) indicates temperature below 0° C.

able atmospheric pressure; considerable humidity; moderate rainfall; a misty or cloudy sky; winds often regular. A mountain climate has a lower temperature and less pressure than the preceding; considerable rainfall; large relative, but small absolute, humidity; sky often clear, consequently considerable terrestrial radiation and low night temperature; and winds determined by the configuration of the earth's surface.

Some idea as to the climatic conditions of different localities in the United States may be gained by reference to the following table, showing the mean and extreme temperature, and the mean precipitation of these localities:

The Influence of Climate on Health.—In warm climates the functions of the liver and skin are particularly active; the digestion is not vigorous, though the activity of intestinal peristalsis is often great; the nervous system is excited or depressed according to the

degree of humidity of the air. In cold climates the digestive functions are vigorous; the nervous system sluggish; muscular development large; and life generally prolonged in spite of the severity of the climate. In temperate climates, which on the whole are the healthiest, there is no great strain on the liver, digestive organs, and skin as in hot, nor on the lungs and kidneys as in cold and damp climates.

A climate with 0 to 50 per cent. relative humidity is unusually dry, with 50 to 70 per cent. relative humidity is dry, with 70 to 85 per cent. relative humidity is moist, and with 85 to 100 per cent. relative humidity is unusually moist. The character of a climate is, however, also influenced by the temperature as well as the relative humidity. At low temperatures, but more especially at high temperatures, the relative humidity of the atmosphere plays a most important *role* in determining the healthfulness of the climate of a locality.

Influence of Tropical Climates upon the Body.—

Kohlbrügge¹ sought to determine the influence of tropical climates upon the body by means of two tests: the bleaching of the skin and the elasticity of the tissues. The bleaching of the skin of Europeans in the tropics is not always an evidence of permanent tropical anemia, as he has found it to exist in many persons in whom the blood count and hemoglobin were normal. In these instances he believes the bleaching is brought about through the influence of the free perspiration due to the high temperature and in consequence of the saturation of the superficial layers of the skin because of the hyperemia of certain vascular systems of the skin, as a result of which there is a thickening of these layers, so that the coloring-matter of the blood can no longer be seen through it. Since evaporation from the skin is inhibited because of the high atmospheric humidity, this bleaching effect remains permanent during residence in the tropics. Upon changing to a temperate climate the horny layer of the skin again becomes thinner in conse-

¹ *Arch. f. Schiffs- u. Tropenhyg.*, 1900, p. 20.

quence of diminished nutrition and more ready evaporation, and the coloring-matter of the blood again becomes visible.

The tropical climate acts upon the elasticity of the tissues most probably in such a manner that the elasticity of the different tissue-fibers is increased through the action of the heat. This is shown not only in natives, but also in the descendants of Europeans born in the tropics, and manifests itself in greater joint movement and in general sluggishness and relaxation.

Influence of Tropical Climate on Nutrition.—K. E. Ranke¹ made a study of the influence of climate on nutrition during a journey to South America.

The optimum temperature of the European with medium clothing is 15° to 18° C., if none of the other climatic factors produces any definite action. In a climate with a temperature of 18° to 22° C. there is increased evaporation of water, but no definite influence upon the appetite. In a climate of about 25° C., when the other climatic factors neither increase nor decrease the action of the temperature, there is a marked diminution in the appetite. With further increase in the temperature there is also further decrease in appetite, and at last it sinks below the requirements of an adult at complete rest. The protein nutrition does not sink below the maintenance minimum of the lower laboring-classes; each further diminution being made at the expense of the fats and carbohydrates. If there is opposition to this instinctive diminution of the appetite, pathologic effects manifest themselves: disturbance of the general comfort, increased temperature, and decrease of the natural resistance against infectious diseases. If the nutrition is constantly diminished below that required because of the heat elimination in a very hot climate, the deficient nutrition leads to dangerous consequences.

F. Hueppe² states that the dangers encountered by Europeans in the tropics in regions of less than 2000

¹ August Hirschwald, Berlin, 1900.

² *Berlin. klin. Wochenschr.*, 1901, p. 7.

meters' elevation are constant high temperature combined with high atmospheric humidity. These factors call forth increased efforts to cool the body, and hence affect the activity of the skin, heart, and lungs. The results of this increased activity are noticed in fatigue on slight exertion and decreased nervous and muscular power.

The high sensibility of the digestive organs of the European in the tropics is caused by the dilution of the digestive fluids from increased ingestion of fluids induced by the free perspiration. All these conditions vary in different individuals. General exercise, especially in the form of riding and swimming, is beneficial for all the body functions. The tropical climate operates especially unfavorably upon the female organism.

The greatest enemy of the European in the tropics is alcohol, the misuse of which increases enormously all the other unfavorable and detrimental influences. The infectious diseases, as yellow fever, cholera, plague, dysentery, and malaria, are the next greatest detrimental influences in the tropics.

The influence of climate upon the course of certain diseases has been the subject of numerous observations. The influence of a dry climate upon the course of tuberculosis is now well understood. The rarefied air as found in the Rocky Mountain region seems to be of great value in the treatment of this disease. This condition of the atmosphere produces an augmented respiratory activity which is highly beneficial in early stages of consumption.

The value of pine forests in localities having a dry, sandy soil and a climate of low relative humidity is also generally recognized. The pine belts of New York, New Jersey, and North Carolina are especially adapted for consumptives during the winter months of the year.

Probably the chief value of removal to another climate in the early stages of consumption is to be traced to the changed conditions of life. The outdoor life which these localities usually permit, along with the high percentage

of clear days, and the removal from the anxieties and constraints of business life, are as beneficial as the climate itself, if not more so. The conviction that this is the case has led a number of prominent physicians to advocate the high plateaus of the Blue Mountains in eastern Pennsylvania as a desirable locality for the recuperation of those likely to be benefited by change of climate. The locations which have been specially advocated are Pocono Mountain in Monroe County and Green Mountain in Lehigh County. This region is the natural home of the pine, though the operations of the lumbermen have long since caused its almost total disappearance. The State of Pennsylvania is acquiring a number of large areas of land in different parts of the State for forest reservations, and in time these will be valuable localities for the establishment of institutions for the climatic treatment of diseases similar to those found in the Adirondack region of New York and elsewhere.

Influence of Climate and Season on Mortality.—

The seasonal variations alone in the temperate zone are of great influence upon mortality aside from the general climatic conditions of a locality. Mild winters and cool summers both lower the mortality, the former exerting a special influence upon the aged, and the latter upon the young, more particularly the infantile population. A cool, damp summer is always accompanied by a low mortality. Season has also an important influence upon the character of the prevalent diseases—intestinal diseases being most prevalent in summer and respiratory diseases in winter. Typhoid fever is least prevalent in late spring and early summer, and most prevalent in the autumn. Typhoid fever reaches its mean about the end of the year; then there occurs a gradual fall to a minimum in April, sometimes interrupted by a slight outbreak in January or February. There is also a June or July minimum with a more rapid rise to maximum about the end of October or beginning of November. The curve of scarlet fever is very similar to that of typhoid fever, but

its minimum is in March, and it rises gradually to a maximum early in November.

Acclimatization is that process by which animals or plants become adapted to, and so thrive in, a climate different from that in which they are indigenous. For instance, almost all the domestic animals were originally natives of warm climates. As regards man, Arnould states that the race is acclimatized when it preserves (1) the natural increase in population; (2) its normal longevity; (3) its aptitude for physical and intellectual work. He gives the following as conditions favorable to the acclimatizing process: 1. Slight alteration in the latitude: to proceed from a warmer to a colder climate is an advantage. 2. Ethnical disposition. 3. Manners and customs. It is essential to adapt one's diet to the climate. Clothing and general habits should also be assimilated to the altered conditions of climate. 4. Aptitude for cross-breeding. 5. Soil and locality: where the soil is not unhealthy, acclimatization is much simplified; if an unhealthy soil is made healthy, by drainage, etc.

It is evident that a large part of the influences attributed to changes in climate is in reality due to the prevalence of certain diseases in different localities which are absent in others. For instance, those passing from the temperate zone into the tropical zone encounter diseases which are unknown in the temperate region, and for which they possess neither a congenital nor acquired immunity and hence are highly susceptible to such infections. After they have acquired an immunity against such diseases, it is probable that the more important feature of their acclimatization has been accomplished.

Ground-air.—The atmosphere does not stop at the surface of the soil, but penetrates into all the pores and crevices. The proportion of air in the soil is not great where there are no fissures or clefts, but in the superficial layer air is always present in appreciable proportions, and especially so in made soil. Soil-air is of somewhat different composition than the atmospheric air. We find present in it large quantities of the products of putrefac-

Y. S. A. S. U. I. N. G.

tion, which is very active in the soil. It is, therefore, far richer in carbon dioxid, besides containing other hydrocarbons as the result of putrefaction, principal among which is marsh gas. In subterranean caverns the air may have undergone such an amount of change as the result of putrefaction and chemical changes going on in the rocks that it is not fit for respiration, and may be highly inflammable as the result of the admixture of other gases. Soil-air is therefore injurious if inhaled in large quantities and for a long time. It tends to penetrate into houses from the surrounding soil, because the warmer air of the house has an upward tendency and thus abstracts the air from the soil. For this reason newly made soil is considered unhealthy and should be avoided. This is especially the case with the newly made soil in and around cities, where the materials employed in making the soil are frequently such as are capable of undergoing putrefaction.

Sewer-air.—Sewer-air in properly constructed modern sewers is merely atmospheric air which contains a slight excess of carbon dioxid and small amounts of gases resulting from putrefaction taking place in the sewage. Consequently there is also a slight decrease in the proportion of oxygen present. The proportion of micro-organisms is usually less than that of the air of streets and houses, and they are usually harmless species. The movement of air in sewers is rather slow, and affords abundant opportunity for the suspended particles, along with the micro-organisms, to become deposited on the moist walls of the sewer. When a portion of a sewer or the drainage-pipes of a house become obstructed, so that there is no longer a free circulation of air in the obstructed portion, then there is an accumulation of the gases resulting from putrefaction, such as carbon dioxid, hydrogen sulphid, marsh gas, etc., and these gases are highly injurious when inhaled in considerable quantities or in smaller amounts for a considerable time.

The Impurities in Air.—These are either gaseous or solid. The more important gaseous impurities in air are

carbon monoxid and dioxid, marsh gas, hydrogen sulphid, gaseous organic substances—such as amins, ammonia, and volatile fatty acids. The solid impurities in air are various forms of dust, inorganic and organic; the débris of vegetable and animal organisms, and living micro-organisms.

Sources of the Impurities.—*Impurities due to Respiration.*—The changes that take place in air that has been respired are both chemical and physical. (1) The volume of the expired air is from one-fiftieth to one-fortieth less than that taken in at the corresponding inspiration. (2) The temperature is raised, as a rule, to that of the blood. (3) Owing to this rise in the temperature there is actually an increase in volume of the expired over the inspired air to an extent of about one-ninth of the latter. (4) There is an increase in the amount of carbon dioxid to between 4 and 5 per cent. (5 and 6) There is an increase of ammonia and watery vapor. (7) The nitrogen is generally increased, but sometimes diminished. (8) The oxygen is diminished to about 16 per cent. There is an addition to the air of (9) hydrogen, (10) marsh gas, and (11) organic matter. Of these alterations, the most important are the increase in the amount of carbon dioxid and the corresponding decrease in the amount of oxygen, the increase of the aqueous vapor to saturation, and the addition of organic matter.

Carbon Dioxid.—The amount of carbon dioxid excreted has been variously estimated at from 31.5 to 37.5 grams per hour. According to Pettenkofer and Voit, the total amount excreted in twenty-four hours for male adults is, on an average, 800 grams, or 406 liters; and according to Vierordt, 900 grams, or 455.5 liters. Assuming the tidal air of each respiration to measure 500 cubic centimeters, and to contain 4 per cent. of carbon dioxid, and that 17 respirations are taken every minute, then the carbon dioxid excreted in one hour is $500 \times 0.04 \times 17 \times 60 = 20.4$ liters, or 489.6 liters in twenty-four hours.

Aqueous Vapor.—The expired air is nearly always sat-

urated with aqueous vapor. The absolute amount varies with the temperature of the expired air; but this itself varies very slightly, being nearly that of the blood, ranging from 33.8° to 36.1° C. According to Vierordt, 330 grams of water are given off from the lungs in twenty-four hours; and according to Valentine, 640 grams. Pettenkofer and Voit state that, with the temperature of the atmosphere at 15° C. and the relative humidity at 75 per cent., an adult gives off 286 grams of water from the lungs in twenty-four hours.

Organic Matter.—That organic matter is present in the expired air is obvious from its odor, which is often quite fetid, and from the fact that when it is collected by the condensation of the aqueous vapor it is putrescible. It has been supposed by some that this organic matter is derived from the alimentary canal and from the upper portion of the respiratory tract, but it has apparently been found in air drawn directly from the trachea. The greater portion of it, however, arises from decomposing particles of food lodged between the teeth, and only a small portion of it comes directly from the lungs. A small portion of it is also derived from the mucous membrane of the pharynx and larynx and, probably, from the stomach.

The nature of the organic matter is not known with certainty. It decolorizes solutions of potassium permanganate, and is, therefore, capable of being oxidized. When distilled it is broken up and yields ammonia, and is, therefore, nitrogenous. It is molecular rather than gaseous, and is probably in combination with water, because those substances which are most hygroscopic absorb most organic matter. The quantity of organic matter given off with the expired air has been estimated. Cornelly, Haldane, and Anderson found, in ten observations, that the amount of oxygen required to oxidize the organic matter varied from 1.7 to 13.6 milligrams per liter of condensed vapor, giving an average of 7.6 and 8.3 milligrams for two observers, respectively. Lehmann and Jessen found that between 3 and 4 milligrams of

oxygen were required to oxidize the organic matter in a liter of condensed vapor. Ransome's results indicate the exhalation of 20 milligrams of organic matter in twenty-four hours, and Beu's results, 15 milligrams. In my own experiments¹ I found the quantity of organic matter in the expired air of healthy men to be, on an average, 10.72 milligrams per liter of condensed vapor. I found also that the amount of organic matter is much greater three to four hours after a meal than immediately after eating, and, likewise, that the amount is directly dependent upon the degree of cleanliness of the mouth and teeth of the person from whom the vapor is collected; the average amount four hours after meals was 11.98 milligrams, half an hour after meals it was only 3.86 milligrams when the mouth and teeth had remained uncleaned for several days, while the average, four hours after meals, was only 2.49 milligrams when the teeth had first been brushed and the mouth thoroughly rinsed with warm water. The amount of organic matter is also greater in those having decayed teeth than in those having sound teeth. In vapor condensed from the breath of a man having an opening directly into the trachea, and in whom there was no communication between the trachea and pharynx, I found the average for three observations to be 9.68 milligrams. In a consumptive person I found the average amount to be 17.34 milligrams. I found the average amount of nitrogenous organic matter given off with the expired air to be 17.5 milligrams of free, and 9.0 milligrams of albuminoid, ammonia per liter of condensed vapor, for healthy persons; and 0.3 milligram of free, and 3.4 milligrams of albuminoid, ammonia in that of consumptive persons.

Bacteria in Expired Air.—No bacteria are given off with the expired air in ordinary, quiet respiration. In the forcible expirations during speaking, coughing, or sneezing it has been found that small particles of mucus and moisture are thrown off which carry microorganisms. In this manner a person suffering from the

¹ *Smithsonian Contributions to Knowledge*, 989, Washington, D. C., 1895.

various infectious diseases may infect the atmosphere and the furniture of the room in which he lives. It must be remembered, however, that only in several diseases which are localized in the respiratory tract would there be danger of the dissemination of the specific disease-producing bacteria. This mode of dissemination may take place in tuberculosis of the respiratory tract, in diphtheria, and in pneumonia. In those diseases in which the specific bacteria are localized in some other part of the body there would be no danger of their dissemination through coughing, speaking, etc.

Impurities due to Perspiration.—The secretions of the skin consist of sweat proper (an acid, watery fluid containing about 1.8 per cent. of solids) and of sebaceous matter, and the quantity varies greatly according to the temperature and humidity of the air, the amount of exertion, etc., but may be taken as ranging from 800 to 1000 cubic centimeters during twenty-four hours. Epithelial cells are constantly disengaged from the skin. Considerable amounts of carbon dioxid are also given off through the skin.

Impurities due to Combustion.—The principal impurities due to combustion are carbon, carbon monoxid, carbon dioxid, sulphur, sulphur dioxid, sulphuric acid, sometimes hydrogen sulphid, ammonia compounds, and water.

The impurities arising from illuminating-gas are olefiant gas and other hydrocarbon vapors, hydrogen, carbon monoxid, and marsh gas. Besides these normal constituents of the gas we frequently find present carbon dioxid, hydrogen sulphid, and other sulphur compounds.

Impurities in the Air of Work-rooms and Factories.—The air of work-rooms and factories contains the impurities arising from the respiration and perspiration of the occupants, and, in many instances, also the products of combustion arising from the process of heating and lighting. Such rooms are often overcrowded and overheated, and in consequence these impurities are

present in excessive amounts, while from lack of personal cleanliness there is a greater proportion of the organic impurities arising from perspiration.

The special impurities of the air resulting from the manufacturing processes present one or the other of the following conditions: (*a*) Increase of temperature, as in mines or bake-houses, the "gassing" rooms of silk mills, and the "sizing" sheds of cotton mills. (*b*) Excessive humidity, as in some deep mines and in the "sizing" sheds of cotton mills. (*c*) The presence of deleterious gases; in mines carbon monoxid and dioxid, carburetted hydrogen and hydrogen sulphid may be present; in bleaching works sulphur dioxid is evolved, and also in copper works, though in the latter it at once passes into the outer air. (*d*) Vapors of hydrochloric, sulphuric, and nitric acids, and of chlorin are given off in certain processes of the manufacture of steel. (*e*) Carbon disulphid is present in the air of vulcanized India-rubber works. (*f*) The fumes of phosphorus in match-making, and (*g*) the fumes of zinc in brass founding; (*h*) arsenical fumes in copper-smelting, the preparation of wall-paper, the manufacture of artificial flowers, and in the preparation of skins for mounting; and (*i*) mercurial vapors are given off in bronzing and gilding, and in the manufacture of artificial flowers.

Impurities in the Air of Dwellings.—The impurities in the air of houses are those arising from respiration, perspiration, and combustion, and, in addition, arsenical vapors may be present when the walls are covered with paper containing arsenic. In cities the air of houses may also contain impurities arising from sewers or from cesspools.

Dust in the Air.—The most injurious constituent of the air in certain manufactories and in the air of the streets of cities is dust. Mineral dust is given off in certain manufacturing processes and in mines. This is especially injurious in establishments where cutlery and files are made, also in gun factories. Dust of vegetable

origin is given off in the wood-working manufactories. The hard woods used in cabinet-making are especially injurious. In factories where hides and feathers are used dust of animal origin is found. In the arrangement of modern manufacturing establishments much of the danger from dust particles is overcome by special arrangements, by means of which the dust is extracted from each machine and is removed by a special flue by means of a strong current of air.

Examination of the Air by the Senses.—Immediately on entering the place where the air is to be examined, note the condition of the air as presented to the olfactory sense. Note whether it is fresh and sweet, rather close, very close, or fetid. The odor of animal organic matter when present in the air, even in small amounts, is very offensive and readily detectable, if the *first* impression on entering be noted; after half a minute this impression wears off. The readiness with which it is perceived depends largely on the humidity of the air, more so than on the increase of the temperature. A rise of 1 per cent. in the humidity has as much influence on the condition of the air, as judged by the sense of smell, as a rise of 2.32° C. in the temperature.

The recognition of the presence of organic matter in the air is the most important item of information to be gained by the senses; but the presence of illuminating-gas or any abnormal smell should, of course, also be noted, as well as the humidity of the air and the presence of notable quantities of dust.

Chemical Analysis of Air.—This includes, first and most important, the determination of the proportion of carbon dioxide, since this is commonly taken as an index of the other impurities in the air; second, the estimation of the humidity of the air; and, third, the determination of the quantity of oxidizable organic matter, as shown by the potassium permanganate test. A more complete chemical analysis would include the estimation of the amount of oxygen present, the amount of ammonia (free

and albuminoid), the amount of nitrous and nitric acids, of hydrogen sulphid, etc., in the air.

The proportion of carbon dioxid in the outside air should always be determined at the time when the air of an enclosed space is being examined. The excess of carbon dioxid in the inside air over that in the outside air is termed the "respiratory impurity" of the air. When, however, it is impossible to analyze the outside air, 0.4 may be taken as the average content of carbon dioxid per 1000 volumes of air.

Estimation of Carbon Dioxid in Air.—It has long been the custom to gauge the relative purity of the atmosphere of confined spaces by the determination of the proportion of carbon dioxid present. It has been shown that all the impurities of the air arising from human occupation increase in a fairly constant ratio, and that the estimation of the proportion of carbon dioxid in such air is indicative of the corresponding increase of the other impurities, such as organic matter, ammonia, moisture, etc. Moreover, on account of the relatively greater simplicity and accuracy of the methods of estimating the carbon dioxid the determination of the carbon dioxid content of air is generally employed in estimating the purity of an atmosphere.

The methods employed in the laboratory for the estimation of the carbon dioxid content of air have been devised by von Pettenkofer. Of the two methods devised by von Pettenkofer, that known as the flask method is the more serviceable. In both methods a solution of calcium, barium, or strontium hydroxid, of definite strength, is exposed to a known volume of air in a tared flask so as to combine the carbon dioxid with the basic hydroxid to form the corresponding carbonate. The subsequent titration of a portion of the alkaline solution with an acid solution of known strength shows the amount of the alkaline hydroxid that has been neutralized by combining with the carbon dioxid of the air.

In the flask method the air is forced into a four-liter bottle, the capacity of which has been accurately deter-

mined, by means of a hand bellows. When the bottle has been filled with the air to be examined, it is closed with a rubber cap. The alkaline hydroxid solution is now introduced by carefully lifting the rubber cap and again replacing it. In the von Pettenkofer tube method the alkaline hydroxid solution is placed in a specially constructed tube through which the air to be examined is slowly aspirated.

Estimation of the Humidity of Air.—The relative humidity of the air of a room is most readily determined by means of a sling psychrometer. Fairly satisfactory results can be obtained by means of a properly managed stationary psychrometer (Fig. 3), or with the hair hygrometer (Fig. 4).

The proportion of organic matter can only be determined indirectly, either by estimating the amount of oxygen required for its oxidation, or by determining the amount of nitrogenous organic matter from the quantity of free and albuminoid ammonia obtained through distillation.

Estimation of the Organic Matter in Air.—Thus far the methods devised for the estimation of organic matter in air have not proved very satisfactory. One of the prin-

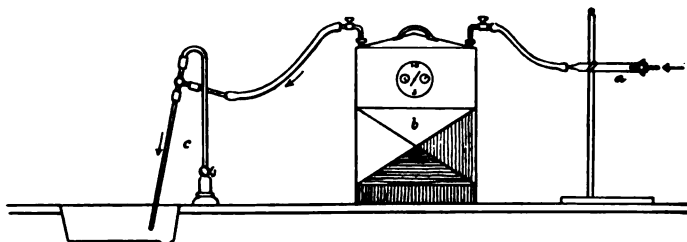

FIG. 5.—Apparatus required with this method. It consists of: *a*, a small glass tube, twenty centimeters in length, consisting of a narrow portion four centimeters long and three millimeters in its internal diameter, and a dilated portion sixteen centimeters long and twelve millimeters in its internal diameter. This tube contains the granular pumice-stone which serves as the absorbent material in this method; *b*, is the gas-meter; and *c*, a Chapman water pump.

cipal reasons for this fact is the necessity of very careful manipulation to avoid unusually large experimental

errors. The method which has given most satisfactory results in my hands¹ is that devised by Remsen (see Fig. 5), in which the air is aspirated through a small glass tube containing freshly ignited pumice-stone which has been moistened with twice-distilled water. After a definite volume of the air has been drawn through such a tube, the amount of organic matter adhering to the pumice-stone is determined either by the Wanklyn method as free and albuminoid ammonia, or by boiling with permanganate of potash solution as in the estimation of oxidizable organic matter in water.

Diseases Produced by Impure Air.—Carbon Dioxid.—This gas is poisonous in proportions exceeding 1 or 2 per cent.; but there is no doubt that the constant presence of even smaller amounts for long periods of time induce a progressive depression of the vitality, thus constituting a preparation for, and a predisposing cause of disease. The bad effects produced by breathing air vitiated by respiration are in part, though not entirely, due to the contained carbon dioxid.

Carbon Monoxid.—This is a powerful narcotic poison. Its poisonous action depends on the formation of a new and quite stable compound with the hemoglobin of the blood, the oxygen being entirely displaced. It produces unconsciousness, paralysis of the heart, and, at high temperatures, convulsions. Small quantities cause headache, giddiness, and speedy insensibility. A mixture of carbon monoxid and dioxid seems to be more poisonous than the monoxid alone.

Hydrogen Sulphid.—This gas acts as a narcotic poison; 1 volume per 1000 volumes of air being fatal to dogs. The chronic effects produced by the inhalation of small quantities are depression, digestive disturbances, and anemia, with narcotic or convulsive symptoms in more acute and severe cases.

Effects of Vitiating Air Generally.—Vitiating by Respiration and Perspiration.—It is impossible to sepa-

¹ Smithsonian Miscellaneous Collections, No. 1037, 1896.

rate the effects produced by these two forms of vitiation from one another, nor is it necessary, as they always coexist. In addition, the emanations from the alimentary tract are also a possible source of impurity. The effects produced by vitiated air of this character may be divided into two classes, those of extreme vitiation acting for a short time, and slighter vitiation extending over a long period of time.

Extreme vitiation for a short time, as produced by great overcrowding, may cause death from deficiency of oxygen and excess of carbon dioxide in the air breathed. It was supposed until recently that a large share of the effects produced by such an atmosphere was traceable to the organic matter present in expired air, but at present there is no convincing evidence that such is the case. On the other hand, the experiments on animals indicate that deficiency of oxygen, excess of carbon dioxide, increased temperature, with high relative humidity of the air, are the principal factors in producing the effects. The increased temperature and high relative humidity of the air are probably most important factors in producing the effects through their operation upon the heat-regulating functions of the body.

Slighter vitiation of the air when continued for some time causes anemia, weakness, and general depression of the vital forces, nutrition being gravely interfered with. Pulmonary affections appear to be produced, either directly or indirectly, by causing a predisposition to them. Such conditions of the air are met with in confined workshops and in overcrowded schools. In many instances the effects of breathing impure air are complicated with the sedentariness of the occupation and its consequent interference with the normal functions of the body; poverty and insufficient nourishment being frequent concomitants. It is a matter of fact that headache, malaise, want of appetite and of energy, are caused by habitual breathing of impure air.

The prevalence of certain diseases of the lungs in those

constantly breathing impure air indicates a causative relation. The prevalence of phthisis among soldiers and sailors was considered to be due to impure air by Parkes and many other competent observers. With the improvement of the ventilation of their quarters phthisis has diminished. Notwithstanding the indications, impure air is not directly the cause of phthisis; only indirectly, through the lowered vitality it produces and the facilities it affords for the transmission of the specific micro-organism. The reduction in the number of cases of phthisis among soldiers and sailors resulting from improvement in the ventilation of their quarters is brought about through the increased vitality induced, and through the greater dilution of the impurities in the air—the tubercle bacilli—and, in consequence, the facilities for their transmission are less favorable. The prevalence of pneumonia also appears to bear some relation to the degree of purity of the respired air. Typhus fever spreads rapidly in crowded dwellings, but with free ventilation it is rendered less dangerous, if not entirely harmless. In all the specific zymotic diseases, but especially in typhus fever, light and oxygen are the greatest enemies to the disease.

Effects of Air Vitiating by Combustion.—Generally speaking, the gaseous products of combustion are diffused so rapidly that there is no prejudicial effect on health; but in some instances, as in crowded work-rooms, where much gas is burned, and in hot, crowded places, such as theaters, the effects are obvious and not to be disregarded. The effects produced by such air when inhaled constantly are anemia, vital depression, headache, and sometimes gastric derangement when the exposure is only for a few hours.

In air vitiated by the combustion of illuminating gas distinct oppression is noticeable when the proportion of carbon dioxid has increased to 3 to 4 parts per 1000, while the addition of similar amounts of *pure* carbon dioxid to air has no such effect and is practically indis-

tinguishable from pure air. A corresponding deficiency in the oxygen of the air is also without sensible effect. In coal-mines the slow oxidation of the coal brings about an accumulation of carbon dioxide to the extent of 5 to 10 parts per 1000, with a corresponding decrease in the oxygen, yet such air is indistinguishable from pure air. The effects of air vitiated by combustion of illuminating gas has been traced to the presence of sulphur by Dr. Haldane. Sulphureted hydrogen and carbon disulphid are contained in crude illuminating gas and may be present in the proportion of 1 gram per cubic meter (40 grains per 100 cubic feet), and in such amounts exert a distinct depressing influence upon the occupants of a room illuminated with the gas. By passing the crude gas over quicklime, sulphid of lime, hydrated oxid of iron, or manganese dioxide, the sulphur compounds are absorbed and the purified gas contains only 0.2 gram of sulphur per cubic meter (8 grains per 100 cubic feet).

Effects of Solid Impurities in Air.—The solid impurities in the air may produce irritation of the mucous membrane of the respiratory tract and lead to bronchitis and laryngitis. The effects of the solid impurities are most frequently seen in those following certain occupations, as in coal-mining, cotton-weaving, emery-grinding, polishing of metals, etc.

In the pottery trade the workmen are exposed to dust, and as a result emphysema is quite common, and is known as "potters' asthma." Grinding of steel, especially of the finer tools, is very dangerous unless wet-grinding is employed or proper ventilation is introduced. The makers of pearl buttons suffer from chronic bronchitis. In the textile industries the fine particles of wool, flax, and cotton floating in the air are injurious. The makers of matches are not infrequent sufferers from phosphorus-poisoning.

CHAPTER II.

VENTILATION.

By the term *ventilation* we understand the continuous introduction of pure air into a room or building, thoroughly mixing it with the contained air, and the simultaneous extraction of a like quantity of impure air. The ventilation of rooms and buildings is necessary in order to prevent the accumulation of the impurities of respiration, perspiration, and combustion.

Diffusion of Gases.—The principles employed in ordinary ventilation depend upon a property common to all gases—that of diffusion. Gases which have no chemical affinity for each other will mingle regardless of their relative weight or density, and form a perfectly uniform mixture. The time required for the diffusion of gases is inversely proportional to the density, and directly proportional to the square root of the absolute temperature.

Amount of Fresh Air Required.—*Amount of Fresh Air Respired.*—The quantity of air taken into the lungs by an adult person at each ordinary inspiration averages 500 cubic centimeters. Assuming that 17 inspirations are taken each minute, the total amount of air inspired in twenty-four hours is 12,240 liters. About 5 per cent. of the oxygen contained in the inhaled air is absorbed. If 17,000 liters of air are inhaled in twenty-four hours, 850 liters, or 1200 grams, of oxygen are absorbed. These figures are based on results obtained when a fair amount of exercise is taken. A man of average weight excretes 17 liters of carbon dioxid per hour in repose, 25.5 liters with gentle exertion, and 51 liters with hard work. Weight for weight, children give off about twice as much carbon dioxid as adults.

The Standard of Purity.—The air under ordinary conditions contains about 0.4 part of carbon dioxide per 1000 parts, and the standard of purity for the air of dwellings is not to exceed 0.6 part in 1000, thus allowing an excess of 0.2 part per 1000 as “respiratory impurity.” The amount of fresh air required in order to maintain the standard of purity in the air of dwellings can be very readily determined, provided we know the velocity with which the air enters, the size of the openings, and the number of persons in the room.

If we take the proportion of carbon dioxide in the air as an index of the character of the ventilation, the method of calculating the amount of fresh air required to maintain the standard of purity is based on the following data: The amount of carbon dioxide exhaled per head per hour, and the ratio per 1000 of respiratory impurity.

The calculation is made according to the formula $\frac{e}{r} = d$, where

e = the amount of CO₂ expired, in liters, per head per hour,

r = the ratio per 1000 of CO₂—the permissible limit due to respiratory impurity, and

d = the delivery of fresh air per hour, expressed in cubic meters.

Example 1: Let $e = 17$ liters, the average amount for a mixed audience in repose, and $r = 0.2$ volume per 1000, then $17 \div 0.2 = 85$ cubic meters or 85,000 liters of fresh air per head per hour.

Example 2: With gentle exertion an adult man excretes 25.5 liters of carbon dioxide per hour. Then the formula $\frac{e}{r} = d$ becomes $\frac{25.5}{0.2} = 127.5$ cubic meters or 127,500 liters per head per hour. It has been found that the amount of air required per hour, in liters, is as follows:

| | In repose. | Gentle exertion. | Hard work. |
|---------------------|------------|------------------|------------|
| Adult males . . . | 85,000 | 127,500 | 255,000 |
| Adult females . . . | 57,000 | 85,000 | 170,000 |
| Children | 42,500 | 63,750 | 113,000 |

For muscular adults a larger amount of fresh air must be supplied than the average amounts given. A larger amount should also be supplied for the sick than for the healthy; an increase of one-fourth of the air-supply being

necessary for hospitals, or 106.25 cubic meters, or 106,250 liters, per head per hour.

The amount of carbon dioxid given off by school children may be assumed to be 10 liters, for a candle 15, for a petroleum lamp 60, and for a gas flame 100 liters; consequently in artificially lighted rooms additional space must be provided to prevent the accumulation of an excess of carbon dioxid. The amount of additional ventilation required for each form of illumination can be calculated in the same manner as already indicated by substituting the corresponding amounts of carbon dioxid yielded by each; for instance, a gas flame would require $\frac{e}{r} = d$, where $e = 100$, instead of 17, as in the first *example* given.

According to Hueppe, the degree of pollution of the air through different causes may be determined by taking into consideration the amount of carbon dioxid, heat, and watery vapor given off by a person or by any of the more common sources of illumination. The necessary data are contained in the following table:

| | Development of CO ₂ per hour in liters. | Heat in calories. | Watery vapor, in grams per hour. |
|------------------------------------|--|-------------------------|--|
| Child | 10.0 | 52 | 20 |
| Youth | 17.0 | 90 | 40 |
| Man, resting | 20.0 | 130 | 60 |
| Man, working | 36.0 | 255 | 130 |
| Candle | 15.0 | 106 | 10-12 |
| Petroleum lamp | 56-61 | 430-580 | 35-40 |
| Oil lamp | 31-56 | 200-390 | 26-40 |
| Gas light, flat burner | 90 | 600-875 | 130 |
| Gas light, Argand burner | 109 | 800-900 | 157 |

Cubic Space.—The amount of cubic space provided for each person depends to some extent on the nature of the occupation, and on the ease with which the contained air can be replenished. If 85 cubic meters of fresh air are to be supplied per head per hour, it is obvious that this can be more readily effected in a room of 25 cubic meters capacity than in one of only half the capacity

without producing disagreeable draughts. The velocity of the incoming air, the position and size of the inlet openings, as well as the temperature of the incoming air, must be so regulated as to prevent the sensation of draught.

It has been found that in temperate climates the air can be changed satisfactorily only about three times an hour unless it is introduced at a temperature above 18° C. In order that 85 cubic meters of air may be supplied, the cubic space for each person should be about one-third as large, or 28.3 cubic meters. For hospitals and sick-rooms the cubic space must be increased in the same proportion as in the fresh air-supply by about one-fourth, so as to provide a space of 35 to 37 cubic meters per head. For cases of infectious diseases a still larger space should be provided. In schools, as a rule, the cubic space provided is very small in proportion to the space required theoretically. In the schools of France and England the cubic space per head ranges from 2.83 to 4.675 cubic meters. In the modern school buildings of Philadelphia only about 5.6 cubic meters are provided for each pupil, and the air is changed about seven times an hour. With the modern systems of ventilation now in use this amount of space is possibly not much too low to meet the desired results.

According to Morin, we require—

| | Amount of ventilation in cubic meters per hour per person. | Maximum cubic space. |
|--|--|-------------------------|
| For hospitals | 60-100 | 30 -50 |
| For prisons | 50 | 25 |
| For factories | 60-100 | 30 -50 |
| For barracks | 30- 50 | 15 -25 |
| For theaters | 40- 50 | 20 -25 |
| For halls and assembly-rooms | 30- 60 | 15 -30 |
| For schools | 15- 20 | 7.5-10 |
| For class-rooms for adults | 25- 30 | 12 -15 |

It will be noted that Morin allows for a complete change of air only twice each hour. Where more frequent changes of air can be definitely secured a smaller

amount of cubic space per person may give satisfactory results.

General Rules for Ventilation.—The quality of the incoming air is of equal importance with the quantity; therefore, care must be exercised in selecting the source of the air-supply. In large towns it may be necessary to wash or filter the air before it is distributed.

The current of incoming air should be imperceptible. This is of special importance when, as is generally the case, the temperature of the outer air is lower than that of the air of the building. When cold draughts are produced the system of ventilation is faulty. The larger the area of the inlet and the outlet openings the slower the velocity of the air current, but obviously these openings cannot be enlarged indefinitely.

The fresh air must not only be supplied to a space, but it must also be diffused equably throughout the space, so as not to pass directly from the point of entrance to the point of exit. It is very difficult practically to attain this end, but unless it is attained we fail to secure the proper displacement and renewal of the vitiated air.

Ventilation is effected either by natural means or by the aid of mechanical contrivances. The former is called natural ventilation and the latter artificial ventilation.

Natural Ventilation.—In all buildings there is an interchange between the inside and outside air by diffusion through the substance of the walls and floors themselves, but this interchange is insufficient to replenish the contained air, and provision must be made to supply the necessary amount of fresh air through openings in the walls, as doors, windows, etc., or through special openings into ventilating shafts; the latter method being the preferable one, especially for large assembly-halls and school-rooms.

The forces which are continually acting in nature and produce natural ventilation are diffusion, the action of the wind, and the difference in density of masses of air of different temperatures; the latter being the most important.

Diffusion.—All gases, including the mixture of oxygen and nitrogen which constitutes atmospheric air, diffuse through space, the force of the diffusion being inversely as the square roots of the densities of the gases. The diffusion of carbon dioxid, and the other gaseous impurities in the air of an enclosed space, into the fresh air takes place not only through the natural openings of rooms, as doors, etc., but also through the walls, floor, and ceiling, because the materials of which these are constructed are always more or less porous and permeable. The amount of ventilation through walls varies with the porosity of the materials of which they are formed; the temperature of the inside and outside air; the force and direction of the wind, etc. Damp walls are less porous than dry walls, and this is partly the cause of the unhealthfulness of damp houses.

The Action of the Wind.—This is exerted in two ways: (1) By perflation—that is, blowing through an air space and thus changing the air contained therein; and (2) by aspiration—that is, sucking up masses of air in consequence of a partial vacuum that is produced on either side of a moving mass of air. Perflation takes place through doors and windows, as well as through walls and ceilings. In the wards of a hospital, where thorough ventilation is of especial importance, the windows should be placed on both sides of the room, so as to allow full sway to the perflating action of the wind. Aspiration is provided when the wind blows over the top of a chimney or ventilating shaft and causes an upward current at right angles to its course. A strong wind may impede the movement of the air up the chimney. Down draught may be produced and smoke forced into the rooms.

Difference in Temperature.—The movement produced by the difference in weight of masses of air of different temperatures is the chief force acting in natural ventilation. When a mass of air is heated it expands, and proportionate volumes of it become lighter; consequently it rises to a higher plane and is displaced by colder and

heavier air. The greater the difference in the temperature of masses of air the more rapid the movement that is produced. The rate of movement may be calculated according to either of the following rules:

1. The velocity of falling bodies is equal to the square root of the space or height through which they have fallen, multiplied by the square root of twice the accelerating force of gravity. $V = \sqrt{2gr}$.

2. Rule of Montgolfier: Fluids pass through an orifice in a partition with a velocity equal to that which a body would acquire in falling through a space or height equal to the difference in depth of the fluids on the two sides of the partition.

All gases under constant pressure expand equally. If V = the volume at 0° C., then the volume at $t^{\circ} = V \times (1 + a \cdot t)$, where $a = 0.003665$. The effect of heat on air, therefore, is to increase its volume and to lessen its density directly in proportion to the increase in temperature.

Arrangements in Natural Ventilation.—In cold and temperate climates the openings that are usually present in inhabited rooms are doors and windows. Chimneys are also generally present. Ventilation is not the primary object of these openings, but nevertheless they act as ventilators, and in very many instances they afford the only means for ventilation. Diffusion takes place through all these openings, as well as through the walls, floors, and ceilings, and generally no special arrangements are needed to assist it in ordinary dwellings.

The natural ventilation through the pores of the walls is of slight significance. It occurs constantly in a vertical direction through the floor and ceiling. In winter, when the house is heated, it occurs from below upward, and in summer in the opposite direction, because the house is colder than the outside air. Along the side walls the excess of pressure diminishes from the floor to the ceiling, between which points there is a neutral zone where it is zero. In winter, in consequence of warming the room air, there is an outward movement above this zone,

and below it an inward movement of cold outside air (see Fig. 6); the reverse takes place when the room is colder than the outside air (see Fig. 7).

The perflating action of the wind must be utilized and regulated. Open doors and windows allow the entrance

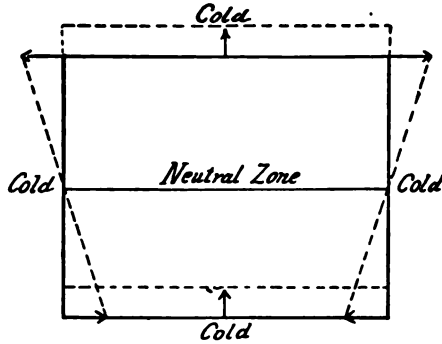

FIG. 6.

of moving masses of air, but if the movement is of sufficient rapidity to produce perceptible currents the doors and windows will probably be closed and the perflating

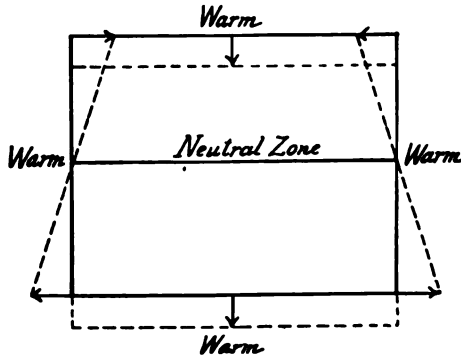

FIG. 7.

action of the wind arrested. The windows should always be placed on opposite sides of a room to secure free perflation and thorough change of the air. Even if this can be secured only at intervals, it is of special importance in the ventilation of wards of hospitals and of school-rooms.

If, however, some arrangement is made by which fresh air may be brought into a room without having the current impinging directly upon the occupants, the air of the room can be renewed, to a great extent, through the force of the wind. A simple plan by which this can be accomplished is to have the upper sash incline inward, leaving a space at the top through which air may enter, so as to direct the current of air upward toward the ceiling, where it is distributed to all parts of the room and slowly falls and displaces the contained air. Another plan is to place a narrow board beneath the lower sash, so as to raise its upper edge above the level of the bottom of the upper sash and form an opening between the two sashes, through which the air may enter (Fig. 8).

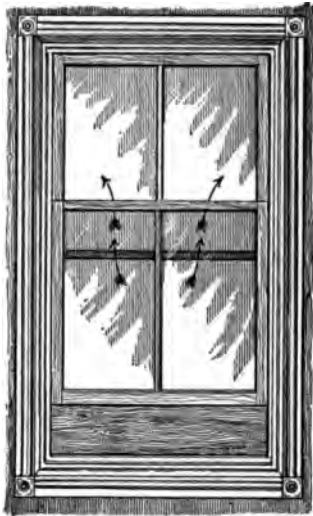

FIG. 8.—Window ventilator.

By this arrangement the entering current of air is also deflected upward toward the ceiling. The same results may also be obtained by placing a louver near the top of the upper sash; or by placing a movable glass disk, perforated with holes, over one of the panes, which is perforated in a similar manner, when by rotating the disk communication can be made with the outside air whenever desired.

Inlet openings in the walls to utilize the perfating action of the wind may be either direct openings through the walls by using "air bricks," or valved openings, as the Sherringham valve, in which, instead of the air brick, an iron frame, containing a movable plate or valve on its inner surface, is inserted into the opening. When the valve is open, it directs the current of air upward toward the ceiling. It is easily

closed by reason of a well-adjusted counterbalanced weight. These latter arrangements are frequently employed in connection with what is known as the direct-indirect system of heating (Fig. 9).

Perflation may be aided by cowls attached to the tops of ventilating shafts. The cowls are composed of two tubes, one within the other, having a hooded cover with one large opening, at right angles to the mouth of the shaft, which is turned toward the point from which the

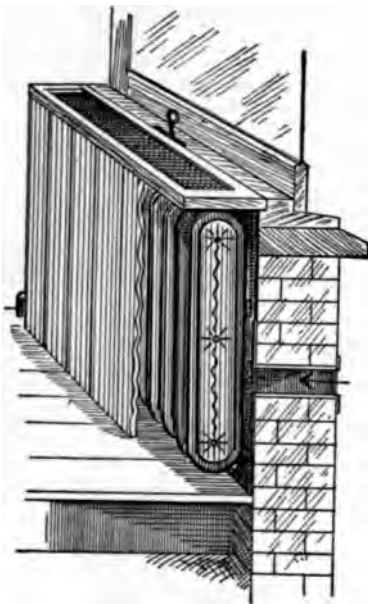

FIG. 9.—Wall air inlet.



FIG. 10.—Cowl.

wind is coming and directs its current downward through one of the tubes. They may be either movable or fixed; the latter being the preferable form, because it is less liable to get out of order. The best form of cowl consists of a fixed downcast tube with expanded, trumpet-shaped mouth, above which is a conical cap, the apex of which is turned upward (Fig. 10). With this arrange-

ment the aspirating force of the wind may be utilized to maintain a fairly constant current of air.

The movement produced by the unequal weights of masses of air of different temperatures takes place through

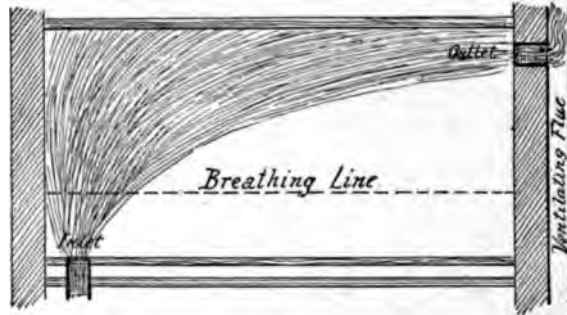

FIG. 11.—Air introduced at bottom, discharged at top.

the ordinary openings, and to some extent through the porous walls of a room; but, as the doors and windows may be closed and the movement be largely arrested, other openings should be provided to secure ventilation. The problem to be solved is—Which is the most satisfactory

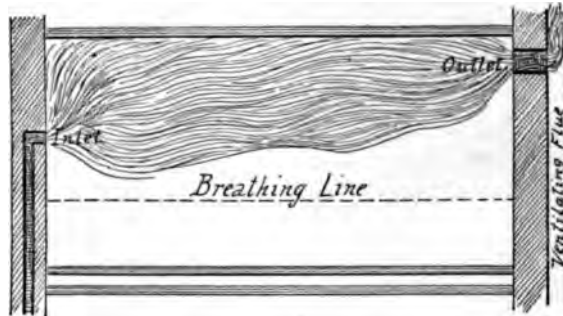

FIG. 12.—Air introduced on side, discharged at top.

location for an outlet through which the vitiated air of an enclosed space may readily escape, and an inlet through which the fresh outside air may enter without causing a perceptible draught? The expired air of human beings is warmed to within about one degree of centigrade of the body temperature, and consequently it rises into

the upper part of the enclosed space. The air surrounding the bodies of the occupants is also warmed to some extent, and rises into the upper part of the space. These facts indicate that the proper place for the outlet openings

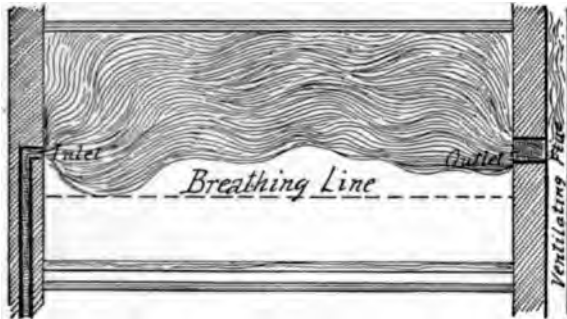

FIG. 13.—Air introduced on side, discharged on opposite side.

is in or near the ceiling. If artificial lighting is used, the air is heated as the result of the combustion and rises into the upper part of the space. This fact also indicates that the outlet openings should be placed in or near the ceiling, so as to allow air vitiated in this manner to

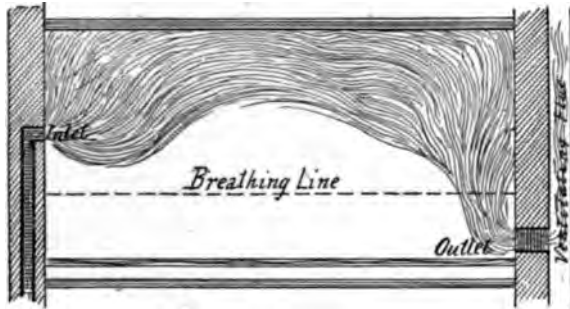

FIG. 14.—Air admitted on side, discharged near bottom.

escape as freely as possible, and to prevent it from mingling with the air that is to be respired.

With the outlet openings at the top of the enclosed space, the inlet openings should be at a lower level, preferably as near the floor as possible, in order to secure the greatest advantage possible from differences in density of

masses of air, by making the height of the column of heated air as great as possible. A current of cold air introduced at the level of the feet of the occupants would be unbearable, and various plans have been devised to

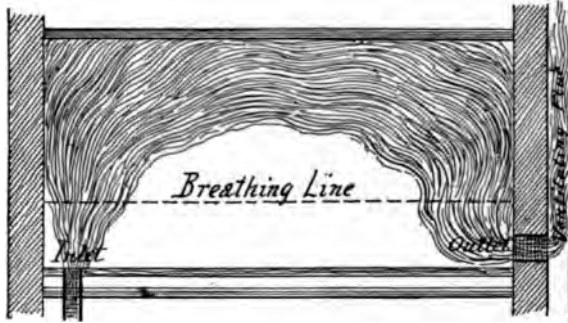

FIG. 15.—Air admitted at bottom, discharged near bottom.

obviate this difficulty, but in practice none of them has proved entirely satisfactory.

Some experiments were made by Mr. Warren R. Briggs, of Bridgeport, Conn.,¹ on the subject of the proper method of introducing pure air into rooms, and the best location for the inlet and outlet. The experiments were

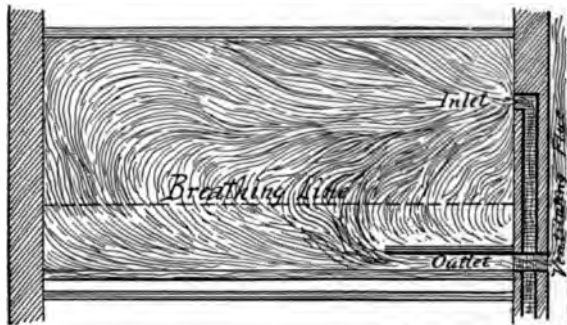

FIG. 16.—Inlet near top, discharge near bottom.

conducted with a model having about one-sixth the capacity of a school-room to which the perfected system was to be applied. The movements of the air in the model of the building were made visible by mingling

¹ Carpenter's *Heating and Ventilation of Buildings*, p. 49.

smoke with the inflowing air-stream, which made the movements of the air visible.

The results of the experiments are shown graphically in Figs. 11 to 16. In each case the distribution of the fresh air is indicated by the curved lines of shading. A study of these sketches is very suggestive, as it indicates the best results when the inlet is on the side near the top, and the outlet is at the bottom and near the center of the room. The tendency of the entering air to form direct currents, which in some instances tend to pass out without perfect diffusion, is well shown. This tendency is less as the velocity of the entering air is reduced, and we probably get nearly perfect diffusion in every case where the outlet is well below that of the inlet, provided the velocity of the entering air is low—less than 1.2 meters per second.

In order to prevent the formation of draughts in the ventilation of rooms, the movement of the incoming air must be slow and gentle, it must be agreeable in temperature, and its humidity must not be too great nor too low. The conditions which cause draught are (1) too great rapidity of current, (2) too low a temperature, (3) excessive or (4) insufficient humidity of the air.

With regard to the size of inlets and outlets, the conditions of temperature are so variable that it would be impossible to fix a size that would be universally applicable. As an average for the temperate zone, a size of 156 square centimeters per head for inlet, and the same for outlet, seems calculated to meet common conditions; but arrangement should be made for enabling this to be lessened in very cold weather, or if the influence of very strong winds is felt. Each opening should not be larger than 300 to 400 square centimeters. Air expands on being warmed, but it is unnecessary to have a larger outlet area than the inlet area; indeed, one of the best ways of preventing draught is to ensure greater facility for entrance than for exit of the air. The shape of the opening of the inlet or outlet tube that causes least friction is the

circular, inasmuch as the area is larger in proportion to the periphery than that of any other figure.

Friction.—Some degree of friction is inevitable, and a deduction of one-fourth should be made in every case on this account. In addition to this, a further loss of velocity arises from the following causes: Size of the opening, shape of the opening, length of the shaft, angles in the shaft, and the presence of dirt.

The velocity of the air-current is readily determined by means of an anemometer (Fig. 17). If we know the size of the ventilating shaft and the velocity of the air-

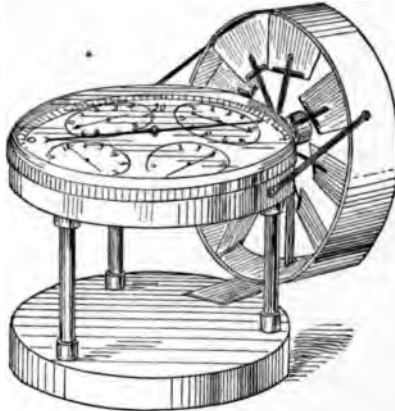

FIG. 17.—Portable anemometer.

current, we can readily ascertain the amount of fresh air supplied.

Artificial Ventilation.—By artificial ventilation is meant that form of ventilation in which movement of air is induced by artificial contrivances. These are, broadly, of two kinds: Heat and mechanical means, and either of these may be arranged for extraction of foul air or propulsion of fresh air, the former being sometimes called the vacuum, the latter the plenum system.

Heat.—In practice heat is employed only to produce ventilation by extraction, not by propulsion. The more common application of heat in artificial ventilation is in

the extraction of air from a room through the ordinary open fireplaces and chimneys. This action depends on the principle already treated of under natural ventilation—that of expansion of masses of heated air causing the production of upward currents.

The rate of flow up an ordinary chimney varies from 1 to 2 meters per second. Taking the ordinary size of a flue as 24 by 36 centimeters, it is seen that the discharge varies between 310 and 620 cubic meters, a quantity sufficient for 3 to 6 persons. The movement of the air will be toward the fire from all the openings in the room, which, if the fire burn briskly, are converted into inlet openings. The larger the fireplace and the fire, the greater the extractive force.

A heated column of air may also be produced by placing coils of hot-water pipes or steam pipes or gas-burners in a ventilating shaft. Whatever be the source of heat, it is best to place it at the bottom of the shaft, and not at the top. In places where a central lighting arrangement is adopted, as in the auditorium of theaters, advantage may be taken of the heat given off by the illuminating agent to carry off the impure air through a shaft placed above the chandelier.

The great disadvantage of extraction by heat is its irregularity of action. It is almost impossible to regulate the temperature of the column of heated air, consequently the upward current will sometimes be far more rapid than at other times. It is also costly on a large scale. Nevertheless, the ventilating power of the common open fireplace is so great that it is a most valuable method of ventilation.

Mechanical Means.—These are chiefly fans, pumps, and jets. *Fans* are almost always rotary, and may be either centrifugal or axial (Fig. 18). The efficiency of a fan is estimated in terms of the volume, velocity, and pressure of the induced air-current, compared with the horse-power required to produce it. Axial fans are more suitable where a large volume at low pressure and velocity is re-

quired; centrifugal fans, for the production of high velocity and high pressure. A large fan operated at low speed is more economical than a small one at high speed. The blades are best curved in centrifugal, flat and inclined in axial, fans. Fans can be used either for extraction or propulsion; they may be operated by steam, wind, water, or electricity. The amount of air delivered by a centrifugal fan can be calculated by taking the velocity of revolution of the periphery of the fan; three-fourths of this equals the velocity of the air, this allowance being

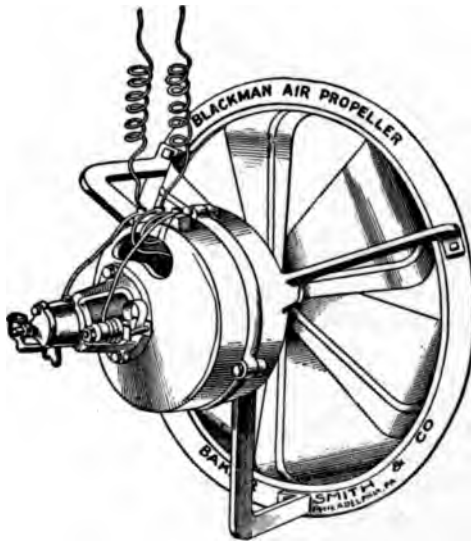

FIG. 18.—Air propeller, with electric motor attached.

necessary on account of friction. The sectional area of the conduit being known, the delivery per second can be calculated from these data.

Pumps are employed in the ventilation of mines, and may be used either for forcing in fresh air or extracting foul air. They are seldom employed in the ventilation of buildings.

Jets for producing currents of air are of three kinds—steam, compressed air, and water. Their efficiency de-

pends principally upon the degree of pressure at which the jets issue from the nozzle. All jets are apt to be noisy, compressed air being least so. They can be used either for extraction or propulsion; in the latter case the steam jet will moisten the incoming air considerably, which may be either an advantage or the reverse.

There are certain points that require attention in all arrangements for artificial ventilation:

(1) The point of intake for the fresh air should be selected principally for the purity of the air obtained, and, as a general rule, the purest air will be found at a height of 3 to 4.5 meters (10 to 15 feet) from the ground.

(2) The air may require cleansing or filtering. With this object in view it may be made to impinge on a sheet of still water, or, better, a film of glycerin, which retains impurities better and does not evaporate so readily. The air may be filtered through coarse cloth, or cotton; the latter being most effective, but is expensive and requires frequent renewal. A thickness of about 1.4 decimeters (6 inches) may be employed. The air may also be purified by washing it with a spray of water or passing it through a wire screen over which a fine stream of water is running. This adds moisture to the air and may require supervision, as hot, moist air produces languor.

(3) The temperature of the incoming air should be regulated. It may be cooled in summer by passing over ice, or, if the water spray is used, this may be cooled by ice, which is an effective method of reducing the temperature. An apparatus devised by Professor Gates, of Washington, for the cooling of rooms in summer, can be more cheaply operated than a coal stove in winter. It is simply a tall cylinder of galvanized iron resting in a large basin or pan, and connecting at the top with the ordinary stove pipe or with a tube leading out of a window. In the top of the cylinder's interior is a perforated tubular ring, and on a cock being turned on this ring an artificial shower is produced inside the cylinder. The water thus flowing down the sides takes on a rapid spiral motion

which sucks the air down the cylinder at a rapid rate; the fine spray inside cooling the air, reducing its humidity to normal, and purifying it of all dust and odor. The water collects in a basin below, from which it is drained off, the cool air escaping through openings just above the water surface of the basin. In some experiments made with this apparatus the temperature of the air on entering the cooling cylinder was observed to be 33° C., while it was 20° C. on taking its exit at the bottom. Recently "liquid air" has been introduced as a means of cooling the air, and has been applied with satisfaction in the ventilation of theaters.

The incoming air may be warmed by passing over or through a heating apparatus, such as hot-water or steam pipes. This is the method now commonly employed in the ventilation of large buildings. The whole of the air-supply, in a scheme of artificial ventilation, ought to be admitted at the required temperature to the chamber to be ventilated, and no attempt should be made to warm the room by superheated air. As a rule, the fresh air should be warmed as near as possible to the temperature desired in the room. In large buildings, consisting of many rooms, the scheme of ventilation requires separate and perhaps different arrangements in different portions. In other buildings, such as churches and theaters, a single central scheme is preferable.

(4) The channels through which the air is conducted should be so arranged as to be easily cleansed; this is especially necessary in propulsion methods, and inattention to this point has in many instances brought the method into disrepute. Where the air has been previously filtered there will, of course, be less deposit of dust on the sides of the inlet shafts. Extraction shafts also require to be kept clean.

The inlet and outlet openings must be so placed that a thorough aëration of the room is possible without the production of draughts. Different arrangements are required for the inlet and outlet openings for winter and

summer. In summer the cool air is brought in at a height of from 2 to 3 meters above the floor in such a manner that it is conducted toward the ceiling. From this point it sinks gradually, and when warmed rises and takes its exit at the opposite side of the room near the ceiling. In winter the air takes its exit near the floor.

The system of ventilation should be so constructed that it can be regulated to meet all reasonable requirements as to quantity of air furnished and the temperature that may be demanded by atmospheric conditions.

Removal of Dust.—The removal of dust in factories requires special arrangements. The circulation of air in closed rooms is insufficient to keep the dust from settling, and, especially in factories, special arrangements for its removal are required. Where large quantities of dust are produced, as in certain factories, it is often possible to apply a strong air current near the source of the dust in order to aspirate it, as in the case of circular saws and grindstones (Figs. 19, 20, 21). Where the dust cannot be satisfactorily removed by such a method it is often possible to modify the manufacturing process so as to prevent excessive dust formation. The use of a spray of water so as to render the material damp and thus prevent, in large part, the formation of dust will aid in keeping the air pure.

In houses and hospitals dust is to be prevented as much as possible. If dust has formed, it tends to settle upon horizontal surfaces, and should be removed with damp cloths.

Comparison of Extraction and Propulsion Methods.—The extraction method is less costly and utilizes the naturally high temperature of the vitiated air. Its disadvantages are that the source of the incoming air is not under control, and, consequently, impure air may be admitted and there is greater liability to draught. In the propulsion method the inlets are entirely under control if properly arranged, and the purity of the air can be assured, as well as its suitable temperature and velocity,

so as to avoid draughts. A proper diffusion of the incoming air throughout the room is more easily effected in the propulsion than in the extraction method. The disadvantage of propulsion is its greater cost. A combination of the two methods is frequently employed, and meets all the requirements.

Comparison of Natural and Artificial Methods.—(1) Natural ventilation is rarely sufficient, and usually re-

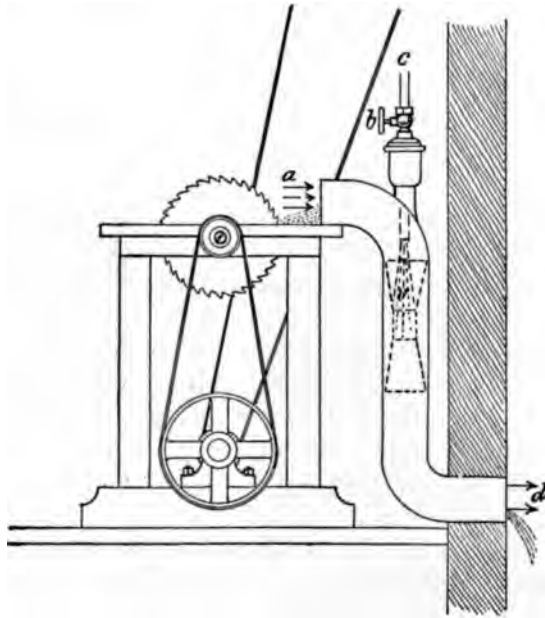

FIG. 19.—Apparatus for removing dust in manufacturing establishments: *a*, inlet to exhaust shaft; *b*, valve regulating spray; *c*, water-supply pipe; *d*, outlet of exhaust shaft.

quires to be supplemented. (2) For dwellings, extraction by heat by means of open fireplaces and chimneys is generally sufficient. It is automatic and requires no special attention, but it is not a perfect system of ventilation. (3) For large halls, churches, theaters, and schools artificial ventilation is necessary. In buildings of this character mechanical methods have a decided advantage over

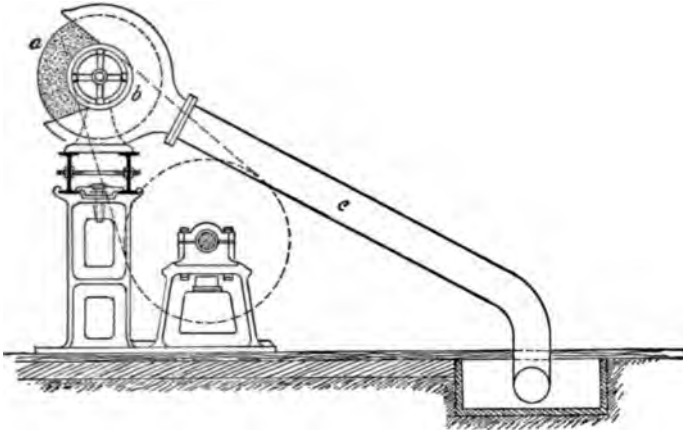

FIG. 20.—Apparatus for removing dust in manufacturing establishments:
a, emery wheel; *b*, hood over emery wheel; *c*, exhaust shaft.

natural ventilation, not only in the greater purity of the air, but in the more equable temperature attainable.

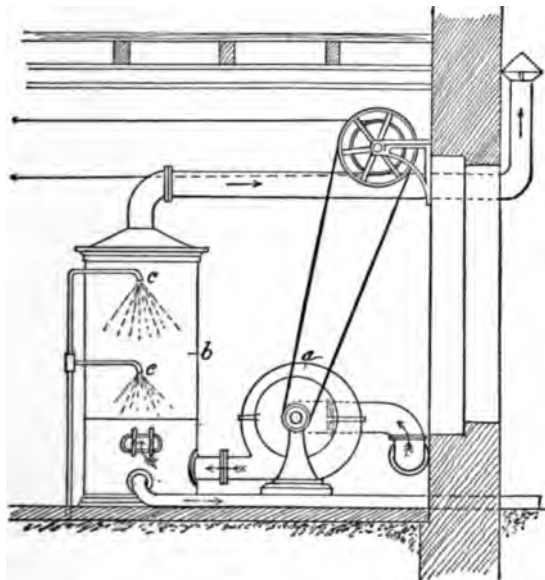

FIG. 21.—Apparatus for removing dust in manufacturing establishments:
a, blower; *b*, dust-collecting chamber; *c*, water-sprays.

CHAPTER III.

HEATING.

HEATING must always be considered in connection with ventilation. This is necessary for several reasons. The combustion of coal utilizes oxygen, and as a result the products of combustion are given off. In order to supply air for combustion and draught fresh air must be introduced. It is also necessary to have a supply of fresh air to replace the heated air which escapes from the building.

Loss of Heat from Buildings.—Heat is required to warm the air of a room to a given temperature, to supply the loss of the heat from radiation and conduction from the windows and walls, and to supply the heat for the air required for ventilation. The amount of heat required for these various purposes will depend largely upon the construction of the building, the amount needed for purposes of ventilation, and the difference between the inside and outside temperature. The loss of heat from the walls of buildings depends upon the material used, its thickness, the number of layers, the difference between the temperature of outside and inside surfaces, and the air exposure. For ordinary temperatures and pressures about 1 cubic meter of air will absorb 1 calorie in being warmed 1 degree C., and hence can be considered the equivalent of 1 kilogram of water. The number of calories required for ventilation can then be found by multiplying the number of cubic meters of air by the difference between the inside and outside temperature, and this product by the number of times the air is changed in an hour.

Degree of Warmth.—The temperature most suitable

for healthy persons ranges from 17° to 20° C. for living rooms, and 15° to 18° C. for bed-rooms. For children and aged persons a somewhat higher temperature is required. No standard temperature can be named, because a temperature just comfortable for one person may be too warm or too cold for others. Custom and occupation have a great influence in deciding the matter.

Heat Supplied by Radiating Surfaces.—The heat used in warming is obtained either by directly placing a heated surface in the apartment, in which case the heat

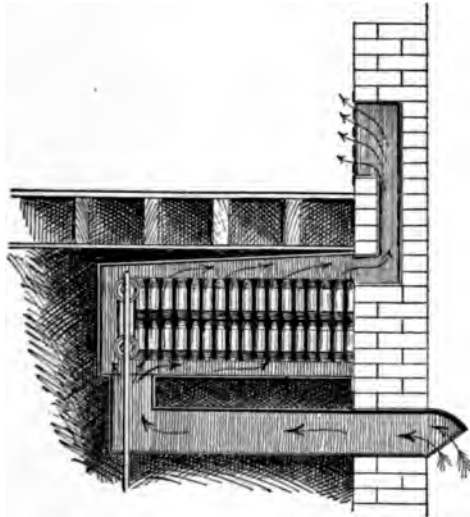

FIG. 22.—Arrangement of indirect heating surface.

is said to be obtained by direct radiation, or else by heating the air which is to be used for ventilating purposes while passing to the room, in which case the heating is said to be by indirect radiation (Fig. 22).

Direct heating is performed by locating the heated surface directly in the room, and this surface may be heated directly by fire, as is the case with stoves and fireplaces, or it may receive its heat from steam or hot water warmed in some other portion of the premises and conveyed in pipes. The general principles of heating are

the same in each case, but in the case of stoves the temperature is greatly in excess of that derived from steam or hot-water radiators. The heat is carried away from the heated surface partly by radiation, in which case the heat passes in straight lines in all directions and is absorbed by the bodies of persons, by the furniture and walls of the room, without warming the intervening air directly. The heat is also carried away by particles of air coming in contact with the heated surface—that is, by convection—which may be the radiating surface, the bodies of persons, or the furniture and walls of the room which have been warmed by the radiant heat.

The sensations produced by radiant and convected heat are quite different. Radiant heat has the effect of intensely heating on the side toward the source of heat, and producing no warming effect whatever on the opposite side. The heat which has passed off by convection is first utilized in warming the air, and the sensation produced is that of heat equably distributed. Radiant heat and convected heat are essentially of the same nature; in the one case it is derived directly from the source of heat, and at a high temperature; in the other case it is received from the air, which is at a comparatively low temperature.

Resistance to Radiation.—The heat in passing through any metallic substance raises its temperature to an extent which depends upon the facility with which heat is conducted by the body and discharged from the other surface. It is noted that heat meets with three distinct classes of resistance in passing through a metallic substance: First, that due to the inner surface; second, that due to the thickness of the material; and third, that due to the outer surface. The first and third resistances are due to change in media, and, when the material under consideration is a good conductor, constitute the principal portion of the resistance to the passage of the heat.

Heat Emitted by Radiation.—Heat emitted by radiation, per unit of surface and unit of time, is independent of

the form and extent of the heated body, provided there are no re-entrant surfaces which intercept rays of radiant heat. The amount of heat projected from a surface of such form as to radiate heat equally in all directions depends only on the nature of the surface, the excess of its temperature over that of the surrounding air, and the absolute value of its temperature. The rate of cooling due to radiation is the same for all bodies, but its absolute value varies with the nature of the surface. The construction of the ordinary form of radiator is such as to present very little free radiating surface, as all the heat which radiates from one tube to another is reflected or reabsorbed, and is consequently not used in heating the apartment. The greater portion of the heat removed is, no doubt, absorbed by the air which comes in contact with the surface, or by convection. The heat removed by convection is independent of the nature of the surface of the heated body and the surrounding absolute temperature. It depends on the velocity of the moving air, and is thought to vary with the square root of the velocity. It also depends on the form and dimensions of the heated body, and on the excess of its temperature over that of the surrounding air.

Systems of Heating.—There are three systems of heating in common use:

(1) *Direct*, where the heating surface is in the room, as a stove, steam coil, or open fireplace. The heat rays from an open fireplace are radiant. They do not warm the air directly. Heat from a moderately hot stove or from a steam coil is very little radiant. The particles of air are heated and brought into circulation—heating by convection. This is the cheapest, though probably the least satisfactory, method of heating.

(2) *Indirect*, where the heating surface is not in the room heated, but in some other portion of the premises, such as a furnace in the cellar. It is impossible to heat by the indirect method without bringing more or less air into the room. It necessitates some ventilation. It is

always more costly than the direct method, but is usually more satisfactory and less troublesome.

(3) *Direct-indirect*, where the heating surface is in the room, but has air coming from the outside at the same time (usually so arranged that the supply of outside air can be cut off, converting it into direct heating).

Direct Heating.—Open Fireplaces.—With open fireplaces the heating is almost entirely by radiation, as there is very little opportunity for convection of heat. Its advantages are limited, though important. It adds little of the impurities of combustion to the air of a room, and it ensures the extraction of considerable amounts of the room air. The objections to this mode of heating are that a very large proportion of the heat is lost, and the portion utilized is only given off as radiant heat, thus warming only one side of the body, while the opposite side remains cold. It is also productive of cold draughts, because the cold outside air always tends to flow directly toward the fireplace. The heating is inconstant on account of changes in the direction of the wind. This method of heating is of greatest importance as an adjunct to other systems, such as the heating of the wards of a hospital where an open fireplace is quite cheerful, when the system of heating is by means of hot air or by steam.

Stoves.—The principal advantages of stoves are that a considerable amount of the heat generated is utilized, and the heating is under more direct control and supervision. The disadvantages of this method of heating are that there is a tendency for the air to become dry, and there is no ready means for introducing fresh air. It is objectionable because of the large amount of dust which is produced.

Steam and Hot-water Radiators.—The use of steam and hot-water radiators involves the installation of a general heating system of which the radiators are only a small part. As far as efficiency of heating is concerned, there is very little to choose between these two methods. The hot-water system is more expensive to install, but

the running expenses are lower than for steam, because it is less expensive to warm the water to 100° C. than to convert it into steam at 100° C. Moreover, in hot-water heating the water is never heated to the boiling-point, hence much less fuel is required.

Heating by Steam.—When water is converted into steam 537 calories are absorbed or rendered latent; 1 kilogram of water at 100° C. requires as much heat to convert it into steam at 100° C. as would raise 537 kilograms 1 degree C., or 1 kilogram 537 degrees C. This is termed the latent heat of steam, and in condensing back into water this heat is given off and can be utilized for purposes of heating.

Steam-heating plants are either high or low pressure. High-pressure systems are now generally called expansive systems. They carry steam at a pressure of over 700 grams to the square centimeter, while the low-pressure systems carry steam at less than 700 grams, usually from 150 to 350 grams to the square centimeter. The low-pressure systems are now principally used.

Systems of Piping.—There are three systems of piping in use: (1) The two-pipe system, which is most commonly employed, and can be used for either high- or low-pressure steam. The main return riser is carried below the water-line of the boiler. Various modifications of this system are in use. Each radiator is provided with separate flow and return pipes. (2) A partial-circuit system, in which the main flow pipe rises to the highest part of the basement by one or more branches, whence the distributing pipes run at a slight incline, and finally connect with the boiler below the water-line. The radiators are connected by risers which carry both flow and return from and to the distributing pipes. The pipes must be made large. This system is employed quite extensively in private houses. (3) The complete-circuit system, often called the one-pipe system, in which the main pipe is led directly to the highest part of the building; thence distributing pipes are run to the various

return risers, which in turn connect with the radiating surface and discharge in the main return. The supply for the radiating surface is all taken from the return risers, and in some cases the entire downward circulation passes through the radiating system.

Exhaust-steam Heating.—This does not imply any particular method of running the pipes, but proper connections must be made between the exhaust and the heating pipes, and provision must be made for taking care of the condensed water.

Hot-water Heating.—On account of its high specific heat water is able to store heat, which it, on cooling, gives up. One kilogram of water in cooling from 100° C. to 20° C. gives up 80 calories, which can heat $8 \times 4 = 32$ kilograms of air through 10° C., because the specific heat of air is only one-fourth that of water. Thirty-two kilograms of air are equal to 24.61 cubic meters.

Methods of Piping.—A system of hot-water heating should present a perfect system of circulation from the heater to the radiating surface, and then back to the heater. An expansion tank, on the top floor, must be provided to prevent excessive pressure due to the heating and consequent expansion of the water. In the system ordinarily employed for hot-water heating the mains and distributing pipes have an inclination upward from the heater, while the returns are parallel to the main and have an inclination downward toward the heater, connecting at its lowest part. In this system great care must be taken to produce nearly equal resistance to flow in all the branches leading to the different radiators. It will be found that invariably the principal current of heated water will be in the path of least resistance, and that a small obstruction, as any irregularity in the piping, is sufficient to make very great differences in the amount of heat received in different parts of the same system.

The expansion tank must in every case be connected to a line of piping which cannot by any possibility be shut off from the boiler. It does not seem to matter

whether it is connected with the main flow or with the return.

Combination Systems of Heating.—Several methods have been devised for using the same system of piping alternately for steam or hot water, as the demand for higher or lower temperature might change.

Indirect Heating.—By Means of Steam Radiators.—Radiators which are placed in a passage or flue which supplies air to a room supply heat by the indirect method. These heaters are made in various forms. They should be placed in a chamber or box as nearly as possible at the foot of a vertical flue leading to the room to be heated. Air is admitted through a passage from the outside provided with suitable dampers. The chamber surrounding the radiator and the flue leading from the chamber are constructed of masonry or of galvanized iron, and that supplying the cold air of wood lined with tin. There should be a door into the chamber, so that the heater may be cleaned when necessary. It is of great advantage to have a by-pass and mixing dampers in the flues, so that the heated air can be mixed with cold air in order to attain the desired temperature of the incoming air. These dampers are often regulated automatically by means of thermoregulators, whereby the desired temperature is maintained by mixing requisite amounts of heated and cold air.

The system of indirect heating by means of steam radiators in stacks is now very generally in use for large buildings, and when a fan is used to propel the air through the building affords the most satisfactory system of ventilation and heating. When all the arrangements have been properly made the requisite amount of air can be forced into the building and at the desired temperature. In comparison with the efficiency of the ventilation and heating with this system the cost of the system is no great objection.

Heating with Hot Air.—The general laws which apply

to hot-air heating have already been considered in connection with ventilation and the indirect methods of heating. The outside air is conducted through an outer casing surrounding a furnace, and when heated rises through the flues and passes into the rooms above. The rapidity of the circulation depends entirely upon the heat of the furnace and the height of the flue through which it passes. In order that the circulation of air through the rooms may be more perfect, outlet openings must be provided for the escape of the impure air. This system is not adapted for large buildings, because the horizontal distance to which heated air will travel is somewhat limited. When properly proportioned, in buildings of moderate size, this system gives fairly satisfactory results.

In order that the hot-air system may be satisfactory in every respect, the furnace should be sufficiently large, and the ratio of heating surface to grate such that a large quantity of air may be heated to a low degree, rather than a small quantity to a high degree of temperature. The air-supply of the furnace is usually derived from the outside through a shaft specially constructed for this purpose, though in many private dwellings the air is drawn immediately from the basement. The disagreeable effects of the air of furnace-heated rooms are due to the dryness of the air. The principal objection to furnace-heating is the fact that when the supply of heat is shut off, the supply of fresh air is also excluded.

Heating with Electricity.—Electrical energy can be transformed into heat, and as there are certain advantages pertaining to its ready distribution, it is likely to come into more general use for heating. One watt for one hour, which is the ordinary commercial unit for electricity, is equal to 3.41 calories. Electricity is usually sold on the basis of 1000 watt-hours (1 kilowatt) as a unit of measurement, the watts being the product obtained by multiplying the amount of current estimated in ampères by the pressure or intensity estimated in volts;

on this basis 1000 watt-hours are equivalent to 3410 calories. The expense of electric heating must in every case be very great, unless electricity can be supplied at an exceedingly low price.

Heating by Means of Gas.—In many towns throughout the natural gas region gas is used for heating as well as for illuminating purposes. In these localities gas is the cheapest mode of heating. It is employed in both the direct and indirect systems of heating. When suitable arrangements are made for carrying off the products of combustion, and there is a proper supply of fresh air for purposes of ventilation, this is a very satisfactory method of heating. In cold weather, where the daily fluctuations in the temperature are not very great, the gas heater can be lighted and adjusted, and requires practically no attention for weeks or even months. It is therefore a great saving in time and annoyance, and there is no coal to shovel nor ashes to remove.

Heating by Means of Petroleum.—Within recent years petroleum has been brought into common use for heating purposes. The advantages of oil heaters are that they are portable and may be carried from one room to another, and the amount of heat can be readily controlled. These petroleum stoves are objectionable, however, from the fact that the combustion of the petroleum utilizes large quantities of the oxygen of the air of the room, giving off corresponding amounts of carbon dioxid. Babuke¹ has found that in a room of 12 cubic meters capacity, during the first hour the temperature was raised only 4 degrees C., and rose but slowly afterward. The proportion of carbon dioxid in the air exceeded 1 part per 1000, and reached in the vicinity of the floor 3-10 parts per 1000, and in the upper part of the room 6-12 parts per 1000, amounts which would be detrimental to health when inhaled constantly. The amount of petroleum consumed was about a liter in eight hours.

¹ *Zeitschrift f. Hygiene*, Bd. xxxii., S. 33.

CHAPTER IV.

WATER AND WATER-SUPPLY.

Physical Properties of Water.—Pure water is a colorless, odorless, and tasteless liquid, of neutral reaction, and is taken as the type of all liquids, as air is the type of all gases.

Chemical Composition.—Pure water consists of 2 parts by weight of hydrogen and 16 parts by weight of oxygen, having a molecular weight of 18. Two volumes of hydrogen combine with 1 volume of oxygen to form 2 volumes of water gas, having a density of 9. The chemical formula for water is H_2O . The percentage composition of water is hydrogen, 11.11; oxygen, 88.89.

Chemically pure water does not exist in nature, but is made in the laboratory by mixing the required amounts of hydrogen and oxygen gas and then passing an electric current through the mixture. The gases unite and form water. From the hygienic standpoint, water as found in nature is either "pure" or "impure." Hygienically pure water is one which does not contain any foreign matter which is injurious to health. Impure water is one that is unfit for domestic use. Water as it exists in nature contains a great variety of substances derived from the air through which it has fallen as rain or snow, and from the soil over and through which it has passed. The nature and quantity of the mineral salts dissolved out of the soil by water are dependent upon the chemical composition of the soil. The nature and amount of organic matter contained in the water are dependent largely upon the nature of the soil-covering over which the water has passed.

Water as it occurs in nature may be divided into rain-water, spring-, river-, lake-, and sea-water. Each of these natural waters varies somewhat according to the locality from which it is derived, though in a general way all of these natural waters possess characteristics which are common to all the waters of that particular class.

Rain-water.—If rain-water were collected in a chemically clean vessel at the moment when it was condensed, it would presumably be chemically pure, but in falling through the atmosphere it takes up some of the impurities in the air. Rain-water is one of the purest of the natural waters, but it varies in purity with the nature of the atmosphere through which it has fallen. It is always purer at the end than at the beginning of a shower. It contains dissolved gases derived from the atmosphere—on an average 25 cubic centimeters per liter, of which about 64 per cent. is nitrogen, 34 per cent. oxygen, and 2 per cent. carbon dioxide. The relatively large amount of carbon dioxide, in comparison with the proportion contained in atmospheric air, is due to its large absorption coefficient. Ammonia is also commonly present. The average amount of solid matter in rain-water is 39.5 parts per 1,000,000. Sodium chloride is the most abundant salt, while nitric acid and nitrates, sulphuric acid and sulphates, and a little organic matter are also commonly present.

Spring-water.—That portion of the rain-water which penetrates the ground exercises a powerful chemical action on the substances present in the soil and underlying rocks. This action consists of solution, hydration, oxidation, etc. Rain-water is an oxidizing agent on account of the considerable proportion of dissolved oxygen that it contains.

Springs may be divided into two classes: Common springs, yielding fresh, potable water; and mineral springs, yielding mineral, thermal, or medicinal waters, in which the dissolved mineral matters render them unfit

for ordinary domestic use, though of great value for therapeutic purposes.

Ordinary spring-water usually contains the gases of the atmosphere in solution. It also contains various mineral salts in solution, such as calcium carbonate and sulphate, magnesium carbonate and chlorid, sodium chlorid, alkaline sulphates and nitrates, and silicates. The amount of organic matter is usually small, and the content in free and albuminoid ammonia is low. The temperature of spring-water is usually lower than that of the surrounding air.

Well-water, if derived from a deep well, is similar in character to spring-water; but if derived from a shallow well it is contaminated with surface washings. Spring-water is usually soft, while some well-waters are moderately hard because of the presence of calcium and magnesium salts in the rocks of the locality. Spring- and well-waters are usually not rich in bacteria unless specially polluted.

River-water.—The course of a great river may be divided into three portions—the mountain track, the valley track, and the plain track; and the composition of the water varies considerably in these three portions of its course. In the first part it is comparatively pure and partakes of the nature of spring-water; in the second and third parts it is usually more or less polluted, depending upon the density of the population along its course. The composition of river-water is complex, as in the case of spring-water, as the water of rivers is largely derived from springs. The proportion of organic matter and of free and albuminoid ammonia is usually higher than in spring-water; and if polluted with sewage the proportion of chlorin is also considerably higher. The character of the water varies greatly with the amount of rainfall and with the nature of the soil-covering of the valley and plain tracks. River-water is usually rich in bacteria, the number and variety of species varying greatly with the season of the year and the amount of sewage pollution.

Lake-water.—Lake-water is of variable composition, the water of salt lakes being loaded with mineral constituents, while that of fresh lakes is usually of great purity. Fresh-water lakes act as settling basins for the inflowing water. The sudden diminution in the velocity of the current causes the subsidence of suspended matters, while oxidation of organic matters takes place from exposure of so large a surface to the atmosphere, and from the action of microscopic plants and bacteria.

Sea-water.—Sea-water is appreciably alkaline from the presence of carbonates. The proportion of solids in solution is about 3.5 per cent.; chlorin being the chief constituent, while sodium, calcium, and magnesium are next in amounts. It also contains considerable amounts of atmospheric gases, even at great depths, the average amount being from 2 to 3 per cent. by volume.

Comparison of Natural Waters.—The Rivers' Pollution Commission of England, in their sixth report, classify waters as follows:

I. In respect of wholesomeness, palatability, and general fitness for drinking and cooking:

- | | | | |
|----------------|---|--|-------------------------|
| a. Wholesome. | { | 1. Spring-water. | } Very palatable. |
| | { | 2. Deep-well water. | |
| | { | 3. Upland surface-water. | |
| b. Suspicious. | { | 4. Stored rain-water. | } Moderately palatable. |
| | { | 5. Surface-water from cultivated land. | |
| c. Dangerous. | { | 6. River-water to which sewage gains access. | } Palatable. |
| | { | 7. Shallow-well water. | |

II. In respect to softness:

1. Rain-water.
2. Upland surface-water.
3. Surface-water from cultivated land.
4. Polluted river-water.
5. Spring-water.
6. Deep-well water.
7. Shallow-well water.

NOTE.—These tables probably do not apply universally, though they afford an indication as to relative degree of wholesomeness, palatability, and softness of waters as they occur in nature.

Impurities in Water.—By the term impurities is meant such substances as are directly injurious to health, or that from their association are indicative of pollution though in themselves they may be harmless. The impurities in water may be either in suspension or solution, and they may be either gaseous or solid, organic or inorganic.

Many of the inorganic constituents of water are injurious only when present in considerable amounts—as, for instance, the salts of calcium and magnesium. These, when present in large amounts, render the water hard and therefore unsuited for domestic use, aside from the fact that they are productive of disordered function of the gastro-intestinal apparatus. Under certain conditions the salts of magnesium are also believed to produce goiter. The amount of sodium chlorid commonly found in natural waters is not objectionable, because it is much smaller than the amounts constantly used in seasoning food. Sodium chlorid is, however, a most important indication of the pollution of surface-waters with sewage, since sewage is rich in chlorin derived from urine. In determining the significance of the amount of chlorin found in any water, it is necessary to know the normal chlorin content of the surface-waters of the locality, since the amount of chlorin normally present in surface-waters varies greatly. The amount is influenced by the proximity to the ocean or other bodies of saline water, by the proximity to natural deposits of salt, and by the geologic formation of the locality. The chlorin content of surface-waters of the natural gas and oil regions is especially high, and this fact must be borne in mind in determining the significance of chlorin present in water from such a locality. The amount of nitrates and nitrites commonly found in surface-waters is without influence upon health. These substances are, however, of great interest and importance as indications of the length of time that has elapsed since the water has been polluted and the extent of the pollution.

The organic impurities in water are of two kinds, dead organic matter of vegetable and animal origin, and living organisms. The amount of dead organic matter commonly found in surface-waters is without effect upon health. It serves, however, as a most important indicator of the extent and character of pollution. The organic matter present in water is usually divided into the nitrogenous organic matter and the oxidizable organic matter. The nitrogenous organic matter usually represents animal organic matter, and is estimated in the form of free and albuminoid ammonia, though it is not always of animal origin, as certain vegetable compounds also yield ammonia on distillation, and, therefore, are nitrogenous in character. The oxidizable organic matter is usually of vegetable origin, and is determined by its bleaching effect upon a solution of potassium permanganate. Neither the nitrogenous organic matter nor the oxidizable organic matter is, as a rule, directly injurious to health, and these also are of importance principally as indicators of the nature and extent of pollution.

In making the estimates of the amounts of these various organic and inorganic impurities in water it is necessary to bear in mind that all waters contain certain amounts of these substances. It is only when the quantities of these substances found exceed to an appreciable extent the normal content of the surface-waters of the locality that they become indicators of pollution.

The living organisms found in water may be either of vegetable or animal origin. The vegetable organisms found in polluted water are of two kinds, the pathogenic and putrefactive bacteria, and those organisms which are of a somewhat higher organization—certain chlorophyll-bearing organisms.

The bacteria found in polluted water which are of the greatest importance are the various pathogenic organisms, the most important of which are the typhoid bacillus, the cholera organism, and *Bacillus sporogenes* of Klein. *Bacillus coli* is also of importance, because it is normally pres-

ent in the intestinal discharges of man and the domestic animals. But its discovery in any surface-water is not positive indication of sewage pollution, as it may have gained entrance from street-washings or from the fecal matter of any of the domestic animals. Its presence in water is cause, however, for suspicion, because it shows that the water is not properly protected against pollution.

The presence of *Bacillus sporogenes* is believed by Klein to indicate sewage pollution to an equal extent with the presence of the colon bacillus. It is regarded as a frequent factor in the production of diarrheal diseases, especially in infants. There are also a number of common putrefactive bacteria which are not normally present in pure surface-waters, and the presence of which is, to some extent at least, indicative of pollution. This is believed to be true of such organisms as those of the *proteus group* and the *lactic-acid group*, and the organisms may be instrumental in producing gastro-intestinal disturbances when present in water in large numbers. The various pyogenic cocci may also occasionally be found in polluted waters, and their presence in drinking-waters is objectionable. A streptococcus has been discovered in polluted waters by Houston and is known as the sewage streptococcus of Houston. This organism is believed by many investigators to indicate sewage contamination just as positively as does the presence of the colon bacillus.

Bacteria are present to a greater or less extent in all natural waters. Many species have their normal habitat in water and in the soil, through which they gain entrance to surface-waters. The point of hygienic importance is, therefore, not whether bacteria are present or absent, because they are practically never absent; not whether they are few or many in number, because no direct relation has been proved to exist between their number and the purity or impurity of the water, though, as a rule, the larger the number present the greater the amount of food-supply for bacteria in such water, and hence the better facility for growth and development of

all species; nor even how many different species are present. The point of real hygienic importance is to determine whether the water does or does not contain any of the organisms of specific diseases. Since the detection of the typhoid bacillus in suspected waters, by the methods known at the present time, is practically impossible the bacteriologist is compelled to base his opinion as to the purity of a water upon the associated species present, as well as upon the relative number of bacteria in the water. This is the only safe criterion at the present time. It is inferred that a water rich in bacteria contains the necessary food-supply for the growth and development of bacteria, and hence it would support the life of any pathogenic species that might gain access thereto, therefore a high bacterial content is looked upon as indicating possible contamination with sewage. If, in addition to this, the water contains well-known sewage bacteria, as *Bacillus coli*, *Bacillus vulgaris*, *Bacillus sporogenes*, and the sewage streptococcus, it is regarded as being polluted with sewage.

The chlorophyl-bearing organisms found in surface-waters are, as a rule, harmless, but certain species when present in reservoir-water give rise to disagreeable odors and taste, and hence are objectionable. These odors are usually produced by the growth of algæ, or diatoms. The principal algæ which have been found to produce these disagreeable odors in stored water are different varieties of *volvox*, *uroglæna*, and *anabena*. The diatom *asterionella* has been found to cause a "geranium" odor and taste in stored water. Another pest of water-works which has caused a great deal of trouble in filling up the pipes and causing a brown sediment in the water is the so-called "iron bacterium," or *crenothrix*. It has the power of secreting iron in its sheath. Although it is a decided nuisance, it is not known to have any harmful effect on health.

The organisms, producing the disagreeable odors in stored water, are unable to grow in the absence of sun-

light, and the most satisfactory means of inhibiting their growth in stored waters is to cover the reservoirs, so as to exclude light.

The more important animal organisms disseminated through water are the eggs and larvæ of certain animal parasites, as the eggs of the round worm, the eggs of *Ankylostoma duodenale* and *Rhabdonema intestinale*, and the larvæ of the Guinea-worm, all of which gain access through fecal matter. Amebic dysentery is another disease which it is believed may be carried in water.

The gaseous impurities in water are few in number and of somewhat doubtful importance. They are hydrogen sulphid, sulphur dioxid, and the gaseous emanations arising from putrefaction, as ammonia, carbon dioxid, hydrogen sulphid, and marsh gas. These gases are usually found in water that is charged with the gaseous emanations from sewers.

The solid impurities are principally mineral particles, such as sand, clay, and fine particles of mica. These arise from the soil over or through which the water passes, and are most plentiful at the time of freshets.

Effects of Impurities in Water.—Gaseous Impurities.—Hydrogen sulphid and the gaseous emanations from sewers appear to produce diarrhea. Sulphur dioxid, when present in considerable quantities, produces disease of the bones in cattle.

Solid Particles.—Any water that is markedly turbid, even though the suspended matter be without disease-producing qualities in itself, may cause diarrhea. This is the case with the muddy waters of the Ganges, the Mississippi and other rivers, especially at certain seasons of the year; the turbidity being due to clayey particles along with vegetable matter. Finely divided mica scales are said to cause the "hill diarrheas" of certain districts of India. Suspended animal matters (especially fecal) cause diarrhea and dysentery, and there is little doubt that such water predisposes to typhoid fever or cholera in some degree, by producing an irritated condition of the alimentary tract.

Dissolved Impurities.—Inorganic Impurities.—The inorganic impurities dissolved in water may be divided into three classes: The actively poisonous minerals sometimes found in water, as lead, zinc, and arsenic; the alkaline and earthy salts, and iron, derived from the soil; and those salts which, though not in themselves injurious to health, are indicative of the nature and extent of the pollution of the water.

The contamination of drinking-water by the poisonous metals is rare except in the case of lead. The solvent action of water on lead pipes is dependent upon a variety of conditions. The temperature of the water is an important factor. Hot water dissolves lead much more readily than cold water. The character of the water is also an important factor. Soft waters, as a rule, are better solvents than hard waters. The presence of considerable amounts of dissolved oxygen in water sometimes acts as a solvent. Certain organic acids in water are also believed to act as solvents. Certain forms of micro-organisms seem to favor the solvent action. The amount of lead which will produce symptoms of poisoning is variously stated by different authors, ranging from 1 part in 700,000 to 1 part in 7,000,000 parts of water; though it is probable that any quantity over 0.7 part per 1,000,000 should be considered as dangerous. A number of propositions have been made to prevent the solvent action of water on lead pipe, such as coating the interior of the pipes with tin, fusible metal, or with coal-tar varnish. The safest method of preventing lead-poisoning is the substitution of iron pipes for lead pipes wherever possible. Since the solvent action is a rather slow process, there is very little danger from the plumbing of modern dwellings unless water is used which has been standing in the pipes for some time. For this reason the first portion of the water drawn in the morning should always be discarded, as it is the portion most likely to contain lead.

The alkaline earthy salts in water, constituting what is known as the hardness of water, are believed to exer-

cise some effect on those constantly using hard waters. Such waters are believed to be productive of calculus and goiter. It is not easy to differentiate the effects of the several earthy salts, though the calcium salts appear to produce diarrhea, while the magnesium salts appear to be concerned in the production of goiter. Iron causes dyspepsia and constipation, and the sulphid is believed to be productive of goiter.

Organic Impurities.—Dissolved vegetable matters, if derived from marshes, are considered harmful. Any dissolved organic matter, whether vegetable or animal, if present in large amount, may produce diarrhea. The animal matter derived from graveyards appears to be especially injurious. It must be borne in mind, however, that the effects here attributed to the organic impurities in water, in the light of our present knowledge, must be attributed largely to the influence of micro-organisms simultaneously present.

Bacteria.—The diseases produced by the presence of specific pathogenic bacteria in drinking-water are typhoid fever, Asiatic cholera, dysentery, and diarrhea, the latter possibly through the presence of *Bacillus sporogenes*. In addition to these diseases, diarrhea and dysentery may be produced through the presence of certain other micro-organisms in drinking-water.

Typhoid Fever.—The belief that typhoid fever can be communicated through drinking-water is comparatively modern. Austin Flint, in this country, and Alfred Carpenter, in England, about 1852, having been the first to establish the fact. It is now hardly questioned by any one that has studied the history of different epidemics. Hirsch considers that few points in the etiology of typhoid fever are so certainly proved as the conveyance of the specific bacilli by drinking-water, or by food contaminated with polluted drinking-water. *Bacillus typhosus* is the actual cause of the disease, and no water can convey the disease without containing the specific organism.

A number of epidemics of typhoid fever have been traced directly to polluted drinking-water. The prevalence of typhoid fever in any community should always lead to an investigation of the nature of the water-supply and the removal of sources of pollution. Cities using polluted river- or lake-water always have a high death-rate from typhoid fever. Changing to a pure water-supply or the purification of the polluted water is followed immediately by a reduction in the mortality from typhoid fever. The reduction in the death-rate from typhoid fever at Lawrence, Mass., at Philadelphia, Pa., and other places after the introduction of filtered water, was most marked, and has continued low ever since. The reduction in the death-rate from typhoid fever in Newark and Jersey City, N. J., after abandoning the polluted water of the Passaic River for impounded surface-water, was also quite marked.

Asiatic Cholera.—The question of the spread of cholera by water is, in many respects, as well established as the spread of typhoid fever. The theory of the spread of cholera through drinking-water dates back to the writings of Dr. Snow in 1849 and 1854. The specific organism of cholera is the "comma bacillus," or spirillum discovered by Koch in 1882.

The relation of polluted water-supplies to outbreaks of cholera is shown most graphically in the accompanying chart (Fig. 23) indicating the experiences of the adjoining cities Hamburg and Altona, in 1892. Both cities derived their water-supply from the river Elbe. Hamburg used the raw, unfiltered water. The supply of Altona was taken from the river at a point below the Hamburg sewer outfall, but subjected to sand filtration. The two cities adjoin, and are practically one city; the division between the two for the most part follows one of the streets. There were 16,957 cases and 8606 deaths from cholera in Hamburg, and only 516 cases and 316 deaths in Altona during the same time, giving a death-rate of 1343 per 100,000 of population for unfiltered river-water, and a death-rate of 211 per 100,000 of popu-

lation for filtered water. A number of the cases occurring in Altona were traced directly to infection by Ham-



FIG. 45.—The black dots show the location and number of the cholera cases in both Hamburg (to the right of the red dividing line) and Altona (to the left of that line). (Abbott.)

burg water occurring in persons working in Hamburg but living in Altona.

Microbes and Machinery.—Klein¹ believes *Vibrio* *spontaneous* to be the etiologic factor in many cases of

¹ Report on the Medical Officer of the Local Government Board for 1893-94 and 1894-95.

diarrhea, and that it probably gains entrance to drinking-water through sewage and surface washings containing the fecal matter of domestic animals. *Bacillus dysenteriae* is now generally regarded as most probably also carried in infected waters. Besides these, certain putrefactive organisms, such as those of the proteus and lactic-acid groups, are also believed to be concerned in the causation of diarrhea under certain conditions.

The discovery of Messrs. Duval and Basset¹ that "infantile diarrhea" is due to *Bacillus dysenteriae* has stimulated bacteriologists to extended studies upon the etiology and modes of transmission of diarrheal diseases in general. The greater prevalence of diarrheal diseases in hand-fed, as compared with breast-fed, infants points to the food-supply as the source or carrier of the infectious agent. The results of the investigations upon the bacterial content of milk indicate that the specific micro-organisms of infantile diarrhea gain access to the milk through contaminated water used in cleansing the milk-containers, or water added for purposes of dilution.

The systematic study of more than fifty organisms of the colon group isolated from polluted waters failed to demonstrate the presence of *Bacillus dysenteriae* in these waters. Further investigations with improved methods may, however, show the presence of these organisms in polluted waters.

Goiter.—It has always been a widespread belief that goiter and cretinism are caused by the use of drinking-water from particular sources, and there is some foundation for this belief. These diseases appear to be associated, to some extent at least, with certain geologic formations, especially those localities in which magnesian limestone is found. Various observers have, in turn, considered the salts of calcium and magnesium, as well as other metallic substances, especially iron sulphate, or copper, or deficiency of chlorids or of iodine, to be the cause. Hirsch believes that endemic goiter should be

¹ *American Medicine*, vol. iv.

considered as an infectious disease produced by a specific poison.

Cancer.—Within recent years the discovery of certain appearances in the cells in cancerous tumors has given rise to the belief that this disease may be due to an organism derived from soil or water. Thus far no satisfactory evidence has been brought forward to substantiate this belief.

Approximate Composition of Drinking-water.—De Chaumont classified different waters into four classes, with regard to their degree of purity. This classification is serviceable in forming an opinion as to the usefulness of a water for domestic purposes, though it cannot be followed strictly in every particular, because geologic conditions may influence the constitution of a water to such an extent as to bring it under the class of suspicious or impure waters with regard to the mineral constituents, without really rendering the water suspicious. It is always necessary to have some knowledge of the geologic formation of the locality.

| Chemical constituents stated in parts per 1,000,000. | Pure. | Usable. | Suspicious. | Impure. |
|--|-----------|-----------|--------------------|---------|
| | Less than | Less than | | Over |
| Total solids | 70.000 | 430.000 | 430.000 to 710.000 | 710.000 |
| Chlorin | 14.000 | 40.000 | 40.000 to 70.000 | 70.000 |
| N as nitrates | 0.140 | 1.120 | 1.120 to 24.000 | 2.400 |
| N as nitrites | nil | nil | 0.500 | 0.500 |
| N as free NH ₃ | 0.020 | 0.050 | 0.050 to 0.100 | 0.100 |
| N as albuminoid NH ₃ | 0.050 | 0.100 | 0.100 to 0.125 | 0.125 |
| Organic matter | 0.250 | 1.000 | 1.000 to 1.500 | 1.500 |

Amount of Drinking-water Required Daily.—**For Drinking and Cooking.**—An adult requires, on an average, 3 liters of water daily; of this amount, 1 liter is contained in the solid food that is ingested. About 2 liters should be allowed for drinking-purposes, either as plain water, or as tea, coffee, etc.

For Ablution.—The quantity used varies very much according to the cleanliness of the individual. About 25 liters may be allowed, of which 10 to 15 liters will serve

for a sponge bath. If a general bath is taken, the daily amount is very much increased, and may be stated at from 250 to 300 liters.

For Laundry and Kitchen Use.—About 15 liters may serve for laundry purposes, and the same amount for house and utensil cleansing.

For Water-closets.—The usual quantity provided in the “water-waste-preventer” cisterns now supplied to closets is 10 to 15 liters. These contrivances effect a great saving in water and meet all the requirements.

For other Purposes.—The need of water in cities for other than domestic purposes, such as manufacturing, washing of sidewalks, sprinkling of streets and lawns, and for hospitals, brings the daily supply up to a very large amount. The estimations of the Chief of the Bureau of Water of Philadelphia, of 750 liters per head per day, should meet all legitimate requirements. The supply of 890 liters per day shows that there is an enormous waste of water.¹

Source of Water-supplies.—Surface-water.—By surface-water is meant the water discharged from the surface of a catchment area, as opposed to that collected from wells and galleries. Strictly speaking, the water in rivers and lakes is surface-water; but as the supply from these sources is often obtained by special works it is convenient to restrict the term surface-water to supplies obtained by means of impounding reservoirs. Such surface supplies depend upon the rainfall for their existence and upon the natural features of the watershed for their character.

It is generally possible to secure statistics of the rainfall in the neighborhood of most places large enough to have water-works, and from such statistics and an inspection of the catchment area the probable amount of water usually available may be determined. The maps of the State and National geologic surveys are of much

¹ See “Report of the Mayor of Philadelphia on Extension and Improvement of the Water-supply,” 1899.

value in determining the sources from which a supply may be obtained.

The surface area that is necessary in order to furnish a supply sufficient for a large city is enormous. The water-supply of a large part of New York City is derived from the Croton watershed, and it is frequently stated that the amount of water available is barely sufficient for present purposes, and that preparation must be made for an extension without delay. In a recent report to the mayor of the city the water-supply commissioner asserts: "The people and government of the city must now and without delay face the choice between two alternatives: They must either take prompt and decisive action for the acquisition of large additions to the water-supply beyond the Croton watersheds, or institute measures to reduce the per capita consumption of water. The average daily consumption of Croton water has increased from 223,000,000 gallons in 1898 to 253,000,000 gallons in 1899. At the same annual increase in succeeding years the limit of the capacity of the two Croton aqueducts—380,000,000 gallons a day—will be reached and exceeded in five years, a shorter time than that in which it would be possible to acquire new sources of supply and to build new reservoirs and new aqueducts."

The quality of the water from a watershed depends upon the population of the area, the number of swamps in it, and the nature of the geologic strata over which it flows. If the population on the watershed exceeds about 100 per square kilometer, the stored water is in danger of being polluted, and often proves troublesome from bad taste and odor. If there are numerous swamps on the watershed, the water is likely to be dark in color, and may be objectionable on this account. If limestone is common, the water is liable to be too hard for either domestic use or for manufacturing purposes.

The suitability of the water for a municipal supply depends upon its freedom from sewage contamination, the degree of hardness, as well as its color, odor, and

taste. Its general character may be determined by an inspection of the entire watershed.

Supplies from Rivers.—The nature and amount of water available from a river must be determined by systematic study of the flow at both high- and low-water seasons. The character of the river-water will depend upon the density of the population along its entire length, the nature of the surface-covering of the watershed, and the nature of the geologic formations.

In comparing the relative advantages of river-water and of impounded surface-water, it is necessary to take into account the amount of water obtainable from either source, the relative purity of each, and the expense of extending both systems so as to meet the demands of the future. This question had been under discussion in Philadelphia for a long time, owing to the degree of pollution of the water. Many competent observers had made more or less exhaustive studies of the conditions involved, but with varying results; some favoring the abandonment of the river-water and resorting to the use of impounded water from the headwaters of the tributaries of the Delaware and Schuylkill Rivers, others favoring the purification of the supply in use as being the most feasible and the less expensive procedure. The commission of experts appointed early in 1899 to make another detailed study of the whole question reported in favor of filtration of the river-water. This plan has been adopted, and almost the entire population of the city is now (1911) receiving river-water that has been purified by sand filtration, and by the end of another year it is probable that the entire city will be supplied with filtered water.

Lake and Pond Supplies.—The use of lakes and ponds as sources of supplies is not available for many localities. Where such supplies are available and they are of undoubted purity, they usually meet all the conditions. In the use of lake-waters the disposal of sewage, however, becomes a serious problem, as in Chicago. Here

the sewage was disposed of by leading it back into the lake, with the result of polluting the lake-water to such an extent as to render it dangerous. Even carrying the fresh-water intake far out into the lake failed to remedy the matter satisfactorily, and, as a result, the drainage canal leading to the Mississippi River was constructed to dispose of the sewage.

Ground-water Supplies.—There are two classes of ground-water, the water which filters from a river or pond into the soil forming its basin, and the water which has entered the ground from a variety of sources, but has been checked in its downward percolation by more or less impervious strata.

The water of the first class retains many of the characteristics of the river- or pond-water from which it is derived, though the nature of the soil through which it passes influences its character to some extent, improving it during its passage through the soil. The water of the second class is influenced to some extent by the geologic formation of the locality and the depth to which it has penetrated. Generally it is a water of considerable purity.

With regard to the method of collecting ground-water, the general plans must vary with the particular conditions presented by the locality. These methods, in a general way, may be said to be either by means of a large circular well, of tubular wells, or of filtering galleries.

The amount of water that may be obtained from deep and shallow wells depends upon the same conditions as those influencing the amount of surface-water. Besides this, the quantity is also dependent upon the porosity of the soil or its capacity for storing water. No more water can be obtained from an area drained by the well than that which falls upon the surface in the form of rain. The amount of ground-water is therefore somewhat limited. The largest yields of ground-water for the supply of cities in this country have been as follows:

| | | |
|----------------------------|---------|-----------------------|
| Brooklyn, N. Y., | 150,000 | cubic meters per day. |
| Memphis, Tenn., | 75,000 | “ “ |
| Lowell, Mass., | 56,250 | “ “ |
| Dayton, Ohio, | 31,650 | “ “ |

The amount of water that could be obtained from this source would be only a small fractional part of the daily consumption of a large city. For small towns this source of supply is available when there is no other that is equally pure and more accessible.

Springs.—The relative purity of spring-waters renders these a useful source of supply. For small communities the supply is often sufficient for ordinary requirements, or it may be extended by combining the supply of neighboring springs. The nature of the location of many springs renders them but little liable to pollution, and at the same time it frequently renders the collection and utilization of the water an easy matter.

Artesian Wells.—In many localities the only available source of supply is that from artesian wells. The depth of the wells is dependent upon the depth at which water-bearing strata are to be found. The nature of the water obtained is influenced directly by the chemical composition of the strata through which the water has passed. As a rule these waters are quite hard, though of great purity. In certain localities, as in North and South Dakota, the waters are quite alkaline and contain mineral matter to the extent of 4000 to 5000 parts per 1,000,000 parts of water, or even more. The healthfulness of these waters is directly dependent upon the nature and amount of mineral matter contained in them. It is evident that the constant use of such waters as those found in the Dakotas would prove of considerable injury to the organs of elimination, especially the kidneys. Experience has shown that these waters cannot be used constantly with impunity. They are usually used only when other available supplies fail from long-continued drought.

Storage of Water.—Water is stored on a large scale in reservoirs, and on a small scale in tanks or cisterns. Reservoirs are natural or artificial basins appropriated or formed for the purpose of reserving or storing water. They are called storage reservoirs when they are intended to retain the excess of rainfall during the rainy season ; service reservoirs when they are intended to hold the supply for immediate distribution. Cisterns are necessary in houses supplied on the intermittent system, as in rural districts. The size of the cistern will depend upon several conditions, as the amount of supply required according to the number of persons occupying the house, and the frequency with which the supply can be replenished. The materials used in the construction of cisterns are usually cement and slate. These materials yield nothing to the stored water. Common mortar should not be used, because it gives up lime to the water. Neither should any metal be employed.

Purification of Water.—The purification of water used for drinking-purposes may be directed to its physical, chemical, or biologic condition. Water that is turbid may be rendered clear; water that has a large amount of dissolved mineral impurities may be deprived of them, at least to some extent; water that contains micro-organisms, pathogenic or harmless, may be rendered almost or quite free from bacteria. Physical, chemical, and mechanical means are employed to accomplish these ends.

In former times mechanical purification alone was attempted, and a water that was clear and sparkling was considered fit to drink, no regard being had to its chemical and biologic impurities. With the advance in chemical science and application of the knowledge it afforded, the chief attention was directed to the mineral matters in solution, especially those indicating fecal pollution. Within recent years, since the cause and the mode of dissemination of certain epidemic diseases have been traced to the pollution of drinking-waters with sewage, the position is now taken that purification of water, to be

efficacious, must not only render a water clear and free from mechanical and mineral impurities, but must also deprive it of the pathogenic bacteria contained therein. This latter function is now considered the most important in any process of purification.

Methods of Purification.—Self-purification of Bodies of Water.—The power of self-purification which many streams and lakes exhibit is in some instances quite remarkable. It was supposed, not long since, that polluted rivers would, in time, completely purify themselves. This has, however, been refuted by recent investigations. The process of self-purification in streams and lakes is a composite one. The factors which are concerned in this process are the following :

1. Sedimentation. The suspended particles, both organic and inorganic, sink to the bottom.
2. Oxidation. In consequence of the movement of the current the water becomes aërated, and comes in contact with fresh portions of oxygen, and this oxidizes the organic matter. Sunlight accelerates the oxidation of the organic matter.
3. Precipitation. During the course of the stream certain insoluble inorganic compounds (as sulphur compounds) may be formed and precipitated, or humus substances may be precipitated through the action of clay, aluminum sulphate, and hydroxid.
4. Dilution. The entrance of pure water from the tributaries and from ground-water dilutes the water.
5. Water plants of different forms (as algæ) and infusoria digest dissolved and, at times, undissolved organic substances.
6. The bacteria convert the organic matter into simple inorganic compounds, such as carbon dioxid, ammonia, and water.

Jordan¹ studied the extent of the purifying power of bacteria in the Illinois River and its tributaries. Samples were collected at various points along the Chicago drainage canal and the Desplaines, Illinois, and Mississippi rivers. "In the flow of twenty-four miles between Morris and Ottawa, the river freed itself from a great

¹ *Jour. Exper. Med.*, Dec. 15, 1900.

mass of sewage bacteria with which it was originally laden, and at Ottawa this was not greatly in excess of that found in the flow of the tributary streams." He attaches most importance to the influence of sedimentation and to the diminution of the food-supply. Less influence is believed to be exerted by sunlight and the agencies of the animal and vegetable life in the stream. He believes that the influence of the diminution of the food-supply through the agencies of the bacteria themselves is a factor that has not received due consideration.

A very good example of the inadequacy of the self-purification of streams, in distances of 15 to 30 kilometers, is afforded by the Merrimac River, in Massachusetts. Epidemics of typhoid fever have followed one another, occurring first in Lowell, from two to three weeks later in Lawrence, and in one instance even in Newburyport. The refuse of one city was carried directly to the next, and the lower cities, using the river-water for drinking-purposes, were afflicted with serious epidemics. The dilution, sedimentation, and aëration were insufficient to remove the typhoid bacilli.

Filtration.—Filtration is one of the most satisfactory processes of purifying water. It was formerly supposed that the process was merely a mechanical one by which the particles suspended in the water were removed. While this is undoubtedly true, it is now well established that, besides removing suspended particles, the filtering process through properly constructed beds of sand will diminish the amount of organic matter in the water, while the bacteria are very much reduced in number. This process is similar to the natural processes of purification constantly going on in the soil, and is brought about through the activity of the same agents—the nitrifying bacteria. All well- and spring-water, the so-called ground-waters, have been filtered by the natural process.

The object of all filtration of water is purification. This purification, wherever necessary, should be carried out by the municipal authorities. In other words, a

water should be furnished to the public which requires no purification at the hands of the consumers themselves.

Sand Filtration.—Filtration on a large scale, through sand and gravel, was first done in London, in 1839, when one of the city water companies subjected the water it was furnishing to the city to this process in order to remove turbidity. It is, however, only during the last decade that the matter of sand filtration has received a great deal of attention. Experiments have been made on large and small scales, from which many important facts regarding such filters have been obtained. It has been found that even raw sewage can be treated in this way with remarkable results, and in water 98 to 99 per cent. of the bacteria and a large proportion of the organic matter are removed.

Sand filtration is spoken of as intermittent or continuous, depending on the fact whether water is kept on the filter continuously or not. The *continuous filter* is most useful in the following instances: When a city requires all the water a filter will take care of when running continuously; when the water is not greatly polluted; and when the conditions of temperature in winter are such that a certain amount of water must be kept on the filter bed in order to prevent freezing. The more rapid the rate of flow through the filter, the more impurities the filtered water will contain.

Intermittent filtration is resorted to when the water is highly polluted. A certain amount of air is necessary to complete the oxidation of the organic matter. Highly polluted water is deficient in dissolved oxygen, and hence the filter must be ventilated from time to time to allow the nitrifying bacteria to recuperate. When the flow of water is stopped the last portion of water, as it sinks down into the filter, draws the air after it, thus assisting in the aëration of the filter.

The continuous process of sand filtration is used successfully at Altona, Hamburg, Breslau, Berlin, Zurich,

and London, in Europe, and at Lawrence, Mass., Nyack, Poughkeepsie, and Albany in New York, Washington, D. C., and at Philadelphia, Pa.

The Lawrence filter, which is a type of the slow sand filters, was constructed as follows: "A bed was excavated to 7 feet below water, about 150 feet wide and 750 feet long, close to the Merrimac River. The excavated material that was suitable was put into a tight embankment on the ends and river-side of the bed, high enough to exclude the highest freshet. The excavation was then filled for about 5 feet with filtering sand underdrained into the old filtering gallery and into a small perforated conduit in extension of the gallery. The top of the sand, being about 2 feet below water, could be flooded by gravity to about 2 feet in depth, thus making a shallow pond of $2\frac{1}{2}$ acres area, which would gradually filter through the sand to the underdrains, and then be conveyed to the old gallery and thence to the pump well. Two sizes of sand were selected after experimentation, the finer being placed directly over the underdrains, and for 5 feet each side of them; and the coarser occupying the remaining 20 feet between the drains, and through which the water would move laterally and use up about the same amount of head as when flowing directly downward through the finer sand. The coarser sand was such that 70,000,000 gallons would flow in twenty-four hours through a foot in depth, covering an acre, with the expenditure of 1 foot head, and the finer sand would convey 50,000,000 gallons under the same conditions. This filter being used for two-thirds of a day would furnish between 4,000,000 and 5,000,000 gallons per day."

The Lawrence filter removes, on an average, 98.3 per cent. of the bacteria contained in the river water. The average number of deaths in the city from typhoid fever in previous years had been 43 for eight months, from October to May, while in the first year after starting the filter there were only 16. Of the 16 who died, 9 were

operatives in the mills, and were known to have used unfiltered canal water for drinking. In 1898 there were only 8 deaths from typhoid fever, a death-rate of 1.39 per 10,000 persons living.

The greater part of the purification of water in a sand filter is believed to be carried out on or near the surface of the filter. A slimy pellicle forms on the surface of the filter in a few days after the filtration is commenced. This pellicle is composed largely of so-called bacterial jelly, and it is the nitrifying bacteria in this pellicle that accomplish the purification. The efficiency of a filter is very low until this pellicle has had time to form, and when it is removed the efficiency of the filter is destroyed. Aside from this surface film, or "schmutzdecke," as the Germans call it, the individual sand grains in the upper portion of the filter are also covered with a coating of a similar nature.

The action of the filter as a whole must be taken into account. There is undoubtedly much mechanical work accomplished in the actual removal of the larger, troublesome, but not particularly dangerous organisms, and of the turbidity and sediment. This, however, is not the most important action of the sand filter. There is also a chemical action going on, an oxidation or burning up of the organic matter, and this is mainly due to the vital force in the filter—the nitrifying bacteria. These organisms appear to be antagonistic to water bacteria and to pathogenic organisms present in water, because those organisms are almost entirely removed in an efficient sand filter.

The changes which take place in the water as the result of filtration through a sand filter are as follows:

| | |
|--|---------------|
| Removal of solids in suspension | 100 per cent. |
| Reduction in free ammonia | 50 to 75 " |
| Reduction in albuminoid ammonia | 35 to 50 " |
| Reduction in oxidizable organic matter | 25 to 30 " |
| Increase in nitrates | 25 to 30 " |

The rate of filtration should not exceed very much 1.5 cubic meters per square meter of surface, though it may vary, according to the relative purity of the unfiltered

water, from 2,000,000 to 5,000,000 gallons per acre daily (22,000 to 56,000 cubic meters per hectare).

The height of water on the sand filters, or the amount of head, as it is called, in the continuous process of filtration varies according to the practice which is found to give the best results, the average depth of water being 50 to 75 centimeters, though many of the German filters contain as much as 100 to 125 centimeters.

The efficiency of sand filters is dependent, to some extent, upon the size of the sand particles composing the filter. The range of the size of the sand grains is from 0.09 to 0.38 of a millimeter in diameter. Within certain limits, the finer the sand particles the greater the efficiency of the filter.

When first constructed, the thickness of the sand layer ranges from $\frac{3}{4}$ to $1\frac{1}{2}$

meters. On account of the process of scraping, which is necessary to clean the filter from time to time, the thickness of the sand layer is reduced, and authorities

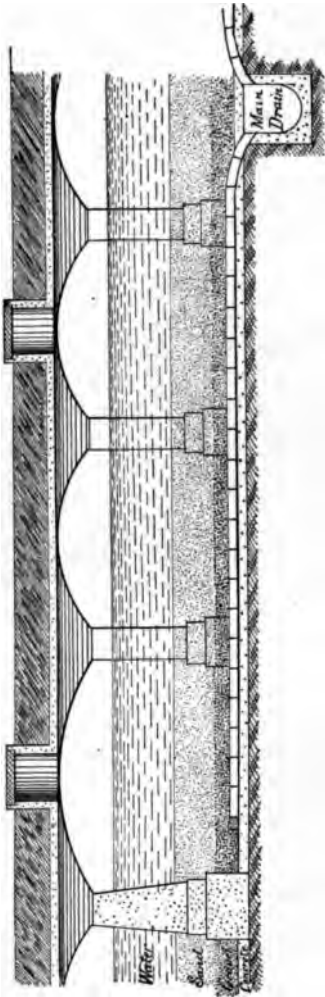

FIG. 24.—Section of covered sand filter.

differ as to the extent of the reduction that is permissible; some allowing a reduction to a depth of 3 decimeters; others contending that the reduction should never be greater than to 6 decimeters before the sand is replaced. In cleaning a filter the surface slime is taken off in a thin layer by means of a scraper. This sand is then removed from the filter and washed thoroughly, when it may be used over again. Fig. 24 shows a section of a covered sand filter such as is in use at Albany, N. Y., and similar in form to those constructed at Philadelphia and Washington.

In cold climates it is necessary to cover the filters in order to prevent freezing. In warm latitudes the filter should be covered over to prevent undue heating of the water. It is also advisable to cover the filters in order to exclude sunlight and thus prevent the growth of algæ, and to exclude dust.

The efficiency of large sand filters may be demonstrated, first, by a reduced mortality from typhoid fever and from cholera after the introduction of the filter. The bacterial efficiency of sand filters ranges from 98.1 to 99.93 per cent. The chemical efficiency of some of the London filters is such that all of the ammonia is removed, others removing from 75 to 80 per cent. In each instance the total solids are slightly reduced, the organic carbon and organic nitrogen are uniformly reduced; showing that sand filtration effects an appreciable reduction in the amount of organic matter.

Capacity of Filter Beds in Philadelphia.—The capacity of the works, as planned and now almost completed, is as follows:

*Torresdale Filters.*¹

| | Gallons per day. |
|---|-------------------|
| Fifty-five filters, Torresdale contingent and preliminary filters . . . | 210,000,000 |
| Ten filters, Queen Lane contingent and preliminary filters . . . | <u>38,000,000</u> |
| Total of Torresdale | 248,000,000 |

Belmont Filters.

| | |
|--|------------|
| Eighteen filters and preliminary filters | 67,000,000 |
|--|------------|

¹ Extract from address of Chief John W. Hill, before the Engineer's Club, of Philadelphia, February 31, 1903.

Roxborough Filters.

| | |
|--|-------------|
| Lower Roxborough, five filters and preliminary filters | 12,000,000 |
| Upper Roxborough, eight filters and subsided water | 20,000,000 |
| Total | 347,000,000 |

Upon the assumption that upon the completion of the works the city may adopt water-meters, or some other remedy for the unnecessary waste, and that an average allowance of 150 gallons per capita per diem will meet all reasonable requirements of consumption, the capacity of the works as planned and now under contract (excepting Queen Lane contingent of ten filters at Torresdale) will be as follows :

| | |
|--|-----------|
| Torresdale capacity will serve a population of | 1,680,000 |
| Belmont capacity will serve a population of | 420,000 |
| Roxborough capacity will serve a population of | 213,300 |
| Total | 3,313,300 |

It is estimated that the population of the city in 1950 will not exceed 3,500,000, and upon this basis the present works of filtration are projected from forty to fifty years in the future.

Population Supplied and Consumption of Water in Nineteen of the Largest American Cities.

| CITIES. | Population supplied. | Consumption. | |
|-------------------------|----------------------|----------------|---------------------|
| | | Gallons daily. | Gallons per capita. |
| Philadelphia | 1,254,000 | 287,188,000 | 229 |
| New York | 2,049,000 | 245,700,000 | 120 |
| Chicago | 1,698,600 | 323,000,000 | 190 |
| Brooklyn | 1,110,000 | 95,900,000 | 86 |
| Boston | 560,900 | 80,000,000 | 143 |
| Cleveland | 420,000 | 66,900,000 | 159 |
| Buffalo | 400,000 | 92,365,000 | 233 |
| St. Louis | 400,000 | 63,530,000 | 159 |
| San Francisco | 342,800 | 25,000,000 | 73 |
| Cincinnati | 325,900 | 39,600,000 | 121 |
| Detroit | 306,055 | 44,800,000 | 146 |
| Milwaukee | 300,000 | 24,000,000 | 80 |
| New Orleans | 287,104 | 13,820,000 | 48 |
| Pittsburg | 234,000 | 54,000,000 | 231 |
| Minneapolis | 202,718 | 18,813,000 | 93 |
| Providence | 187,300 | 10,130,000 | 54 |
| Indianapolis | 169,164 | 13,400,000 | 79 |
| Allegheny | 130,000 | 39,000,000 | 300 |
| Denver | 100,000 | 30,000,000 | 300 |

The proposition to so restrict the needless waste and reduce the per capita daily consumption of water possibly to 150 gallons is sustained by reference to certain cities in the above table of water consumption in nineteen of the principal cities of the country for the year 1902. Cincinnati, Cleveland, Milwaukee, Providence, and St. Louis, are all manufacturing cities, in which, excepting Milwaukee and Providence, meters are not generally used, and the consumption of water is regarded as excessive, and the same complaint of water-waste with the two exceptions noted is made there as it is in New York, Boston, and other cities not generally metered.

Assuming that the general introduction of water such as is now coming from the Lower Roxborough filters will have an effect to reduce, by 80 per cent., the typhoid-fever rates, the direct money value to the city of this reduction is estimated at \$2,284,000 per year, an amount which, capitalized at 5.5 per cent., the fixed charges on the bonds issued for construction of the works, for thirty years, equals \$33,195,656, which I consider as the present value of the general filtration of the public water-supply.

Nearly the entire city of Philadelphia is now served with filtered water, and the system is being extended rapidly so as to cover the entire city. The influence of the filtered water on the incidence of typhoid fever has been most satisfactory. There has been a reduction of more than 80 per cent. in the filtered water areas as compared with the unfiltered water areas. It is safe to assume that some of the typhoid fever occurring in the filtered water area has been contracted in the unfiltered water area, and that the remainder is due largely to milk infection and contact cases.

Mechanical Filtration.—Numerous mechanical filters are now on the market which permit the rapid filtration of large volumes of water through limited sand areas, and, in most instances, under considerable pressure. A number of these mechanical filters make use of some coagulant, such as alum or iron, in order to assist in clarifying and purifying the water. The flocculent precipitate which is formed takes with it the suspended matters as well as the bacteria, and the whole mass is caught on the surface of the sand as the water passes through. Usually these filters are cleaned by turning the water in the reverse direction, thus washing the filth, which has accumulated on the sand, into the sewer. Small filters of this nature are employed to filter the water of manufacturing establishments, of hotels, hospitals, and of private dwellings (see Fig. 25); larger sizes arranged in series, are now also employed to filter the water of municipalities where the nature of the impurities in the water makes it impossible to obtain satisfactory results by sand filtration. Louisville, Cincinnati, Providence, R. I., Vincennes, Ind., and Norfolk, Va., have filters of this character, using alum as a coagulant. A

great deal of objection has been raised by persons not fully informed on the subject, against the use of alum as a coagulant. If the alum is used intelligently, there is not the slightest danger from its use. It is converted into aluminum hydroxid, a white flocculent precipitate, and is retained on the surface of the sand in this form. Unless unusual amounts are used, none of it will be found in the filtered water.

Another form of mechanical filter in use is that in



FIG. 25.—Mechanical filter: A, inlet pipe; B, outlet pipe; C, waste pipe; D, valve to cut off water from filter; E, lever to operate the agitator; F, air valve; H, handle of valve used to change the course of the water through the filter; I, distal attachment of coagulating tank to inlet pipe; K, lever valve regulating the quantity of alum supplied; O, proximal attachment of coagulating tank to inlet pipe; P, waste pipe leading from the coagulating tank to the sewer; Q, valve which fastens on the cover of the coagulating tank; S, pointer which indicates the course of the water through the filter; T, sight glass.

which spongy iron and scrap iron are used as coagulants. In these filters there is an additional item of expense in the revolving machinery which is necessary to agitate the iron in the water. The scrap iron is contained in a revolving cylinder through which the water passes. After passing through this cylinder the water flows on to a sand filter. This process is not

adapted to the purification of brown, peaty waters, because the iron forms a soluble compound with the organic matter in these waters. A mechanical filter of this kind has been in successful operation at Wilmington, Del., for some years, and at Quincy, Ill.

The nature of the water and soil of a locality influences the kind of purification that will be most efficient. This can only be determined by a series of systematic tests. Such tests and studies have now been made at Louisville, Cincinnati, Providence, St. Louis, Pittsburg, Columbus and Lorain, Ohio, Washington, D. C., and at Philadelphia.

No city should be satisfied unless it possesses the best possible water-supply. The importance of having a supply of pure water must be evident. A municipality should be compelled to furnish its citizens with a water-supply which does not need house filtration nor boiling to render it safe. The insurance companies have brought the matter to a focus by making the quality and quantity of a municipal water-supply one of the factors in determining the insurance rates. The life-insurance rates are sometimes increased if the water is polluted, and the fire rates are increased if the quantity of the general water-supply is considered insufficient. One or more such cases of increased rates have occurred recently in the State of Indiana. No problem connected with modern municipal life is of greater vital importance than the purification and protection of the water-supply.

*“Specifications for a Mechanical Filter Plant.”*¹—As it is very rarely that specifications are prepared for a large municipal filter plant, it is believed that a few extracts from the set for such works at two of the pumping stations of the Brooklyn water-works will be of general interest. The filters on what is known as Baiseley's stream are to have a capacity of 5,000,000 gallons, and those on Springfield stream of 3,000,000 gallons; both to operate by gravity at a rate not exceeding 125,000,000

¹ *Engineering Record*, Nov. 16, 1900.

gallons per acre daily. The following extracts from the specifications give those features which are of most interest:

“*Purification Required.*—The purification required is as follows:

“1. When the applied water contains 2500 or more bacteria per cubic centimeter, there shall be an average reduction of bacteria in the filtered water from the whole plant in use of at least 98 per cent.

“2. When the applied water contains less than 2500 bacteria per cubic centimeter, the average number of bacteria in the filtered water from the whole plant in use shall not exceed 50 per cubic centimeter.

“3. When the applied water contains 2500 or more bacteria per cubic centimeter, not more than 5 per cent. of the samples of filtered water from the whole plant in use shall show a reduction of bacteria as compared with the applied water of less than 90 per cent.; when the applied water contains less than 2500 bacteria per cubic centimeter, not more than 5 per cent. of the samples of filtered water from the whole plant shall show more than 75 bacteria per cubic centimeter.

“4. When the applied water contains 2500 or more bacteria per cubic centimeter, not more than 10 per cent. of the samples of filtered water from any one filter shall show a reduction of bacteria as compared with the applied water of less than 90 per cent.; when the applied water contains less than 2500 bacteria per cubic centimeter, not more than 10 per cent. of the supplies of filtered water from any one filter shall show more than 75 bacteria per cubic centimeter.

“5. Not more than 5 per cent. of the samples of filtered water from the whole plant in use shall show a reduction of microscopic organisms, determined as standard units, of less than 98 per cent. as compared with those in the applied water.

“6. The filtered water shall contain no undecomposed coagulant and no more iron or aluminum than the

applied water; it shall not show an acid reaction, nor an alkalinity greater than that of the applied water.

“*Regulation.*—The filters shall be equipped with an automatic device which will regulate the rate of filtration, so that variations in the same will not exceed 2 per cent. of the rate fixed and desired at any time.

“*Waste.*—Separate pumps must be provided by the contractor for supplying wash water; the total amount of water used for washing and other purposes requiring it to be wasted shall not exceed 3 per cent. of the supply filtered.

“*Tests.*—To determine whether the requirements have been complied with, a test of each of the plants will be made, which test will be begun as soon after the filters have been erected, connected, and placed in operation as the engineer may direct, of which date of commencement for each station the contractor will be duly advised. The test of each plant will extend over a period of twelve weeks, and the observations will be made daily (Sundays excepted) in periods of two successive weeks at each plant, no observation being taken at one while they are carried on at the other, so that the full period devoted to each will be six weeks. While the tests are in progress the number of filters in use at each station shall bear as near the same proportion as possible (without exceeding the rate of filtration for which the plant is designed) to the whole number of filters provided at that point that the supply obtained bears to the full capacity of the station as herein specified; the number of filters so used shall be understood to comprise the ‘whole plant’ referred to under ‘purification required.’ During the test period of each plant regular samples for determination of the contract requirements shall be taken at such hours as the engineer may elect, and as follows:

“(a) Four samples daily of the applied water, to be collected either from the suction pipes leading to the engine, or from the force main leading to the filters.

“(b) Four samples daily of the filtered water from the

whole plant, to be collected either from the main collecting flume or from the discharge pipe leading to the conduit.

“(c) One or more samples of filtered water shall be taken daily from each of the filters, so timed that they will represent, as nearly as possible, the filtered product of the samples of applied water specified in paragraph *a*; these samples shall be collected from the outlet of the filter.

“The exact location of the points from which samples will be collected will be determined by the engineer, and all necessary facilities for taking same will be provided by the contractor.

“Bacterial determinations will be made of each regular sample taken; the number of microscopic organisms (standard units) in the applied water and in the filtered water from the whole plant will in each case be determined at least once daily, and oftener if the engineer shall deem necessary; the iron, aluminum, and alkalinity will be determined from regular or special samples, and as the engineer may deem necessary; and if unfiltered water is used for washing, the samples used for determination of iron will not be taken until at least one hour after washing. Complete chemical analyses of the applied water and of the filtered water from the whole plant will be made as often as practicable. All collection of samples and all of the other observations required will be made under the direction of the engineer and by such of his assistants as he shall see fit to designate. The results of the analyses and observations thus made will be used to determine whether the requirements of this contract as to purification, use of coagulant, regulation, and waste have been complied with; copies of the results of the examination will be furnished to the contractor as often as possible. The engineer shall adopt such measures as he may deem proper and necessary to determine the amount of coagulant used, and the contractor will furnish all necessary facilities and appliances to make such determinations. The method used for the

collection of all samples and for their examination will be open to proper inspection by the contractor, but no interference in such work on his part will be allowed.

“The samples for bacteriologic examination will be collected in sterilized bottles, and plated as soon as possible after collecting. The cultures will be made upon standard gelatin that has an acidity of 1.5 per cent. The bacteria will be allowed to develop for about forty-eight hours at a temperature at or about 20° C., and for as much longer period as can be obtained without liquefaction of the gelatin. The samples of applied water and filtered water used in determining the efficiency of filtration will be cultivated under the same conditions, and allowed to develop for the same length of time. Two or more duplicate plates will be made for each sample, and the average of the results will be used to determine the number of bacteria present in the sample. In case of the loss of a plate through the liquefaction of the gelatin or for any other sufficient reason, the determination of the efficiency depending upon the same will be omitted from the records.

“The variation in rate of filtration, total capacity of filters, and quantity of water used for waste and washing, shall be determined by meter measurement.”

Household Filters.—Household filters may be divided into two large classes, those which filter all the water supplied to a house, as small forms of the different types of mechanical filters, and those which filter only the portion used for cooking and for drinking purposes. A variety of filters is now on the market that is intended for this purpose. The essential characteristics of a good filter of the latter class may be stated as follows:

A. With regard to the *filtering medium*:

1. It should have sufficient purifying power, mechanically, to restrain all suspended matters; chemically, to remove dissolved organic or deleterious matter; and biologically, to arrest micro-organisms.

2. This purifying power should be reasonably lasting.

3. The filtering medium should give up to the water



FIG. 26.—Domestic filter—Berkefeld: *a*, point of attachment to faucet; *b*, outlet.

nothing that is either itself deleterious or that will favor the growth of low forms of life.

4. The delivery should be reasonably rapid, consistent with efficient purification.

B. With regard to the *filter construction*:

5. It should be so constructed as to be easily taken apart, inspected and cleaned.

6. There should be nothing that is liable to decay or capable of yielding up metallic or other impurities to the water.

The domestic filters of this class which meet all these conditions most satisfactorily are the Berkefeld filter (see Fig. 26), composed of cylinders of baked infusorial earth, and the Pasteur filter, composed of cylinders of baked, unglazed porcelain. These filters yield a water that is clear and sparkling, free from bacteria, and are readily taken apart and cleansed. After having been in use for several days the filtered water begins to show the presence of bacteria owing to the fact that these organisms have grown through the pores of the filter. For this reason these filters must be cleansed at frequent intervals. This cleansing should consist in scrubbing the outside of the cylinder and then boiling or baking for an hour. After such a cleansing they are almost as efficient as new filters.

Purification of Water without Filtration.—The processes of purification, aside from filtration, which may be employed, are distillation, boiling, and treatment with chemical substances. *Distillation*, if properly carried out, furnishes a pure water. It is, however, deprived of its oxygen and carbonic acid, and consequently it is tasteless. To remedy this defect a number of special

distilling apparatuses have been devised which aërate the water at the same time (see Fig. 27).

Boiling, next to distillation, furnishes a harmless water, though it does not remove the dissolved impurities, and at the same time it removes the gases dissolved in the water. It renders the water tasteless. Boiled water may be aërated to some extent by pouring it from one vessel to another. Boiling removes the temporary hardness, the hydrogen sulphid, and renders the dissolved organic matter and bacteria harmless.

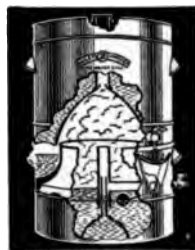

FIG. 27.—Domestic water still.

Where a water is objectionable merely on account of the bacteria contained in it, and there is danger of contracting one or the other of the water-borne diseases, a satisfactory mode of domestic purification is that by means of the Forbes water sterilizer (Figs. 28 and 29), in which the water is boiled and cooled during its passage through the apparatus, issuing from the apparatus with its temperature but little higher than at the point of entrance.

The treatment of water by means of *chemical substances* is conducted with the object of precipitating suspended matters, as by means of the salts of aluminum; the removal of hardness, by the addition of lime; to oxidize the organic impurities present, by the addition of potassium permanganate; the removal of pathogenic bacteria, as in the treatment with ozone, bromin, or hypochlorites.

Crystallized alum is very effectual in the precipitation of suspended matters in the proportion of 5 or 6 milligrams to the liter of water. The action is most marked if calcium carbonate is present. Calcium sulphate is formed, and a bulky precipitate of aluminum hydroxide which carries down the suspended matters. The water may then be filtered or on subsiding the clear water may be decanted.

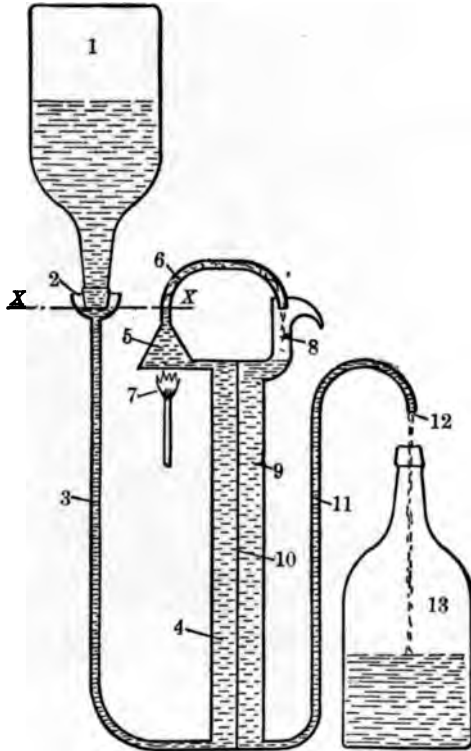

FIG. 28.—Forbes' portable water sterilizer, for use in the absence of a general water-supply. The raw water is supplied from the inverted bottle 1. The water runs from the bottle 1 into the cup 2, then down through the pipe 3 into the compartment 4 of the heat exchange, which it fills. When compartment 4 is filled, the water runs into the heater 5, and rises in the pipe 6 to the level X, where it stops. No more water will now run out of the bottle 1, because its mouth is sealed by the water in the cup 2 at the level X. The burner 7 is now lighted, and heat is applied under the heater 5, which causes the water in the heater to boil, and in boiling it rises in the pipe 6 and flows over into cup 8, just as a pot on a cooking range will boil over. It is therefore impossible for any water to pass through the apparatus until it has boiled, for it is only by boiling that it can rise sufficiently in the pipe 6 to flow over into the cup 8. The water continues to boil over into the cup 8, and quickly fills compartment 9 of the heat exchange. When compartment 9 is filled, the water runs out of the pipe 11 at the opening 12 into the receiving bottle 13. While passing down through the compartment 9 the heat of the water, which is boiling hot, is transferred, by conduction, through the thin metal partition or diaphragm 10 to the cold water passing up through compartment 4, so that the water which is boiled in the heater 5 passes out of the apparatus nearly as cold as that entering, while the cold water entering the apparatus becomes heated as it passes up through compartment 4, and reaches the heater 5 nearly at the boiling-point.

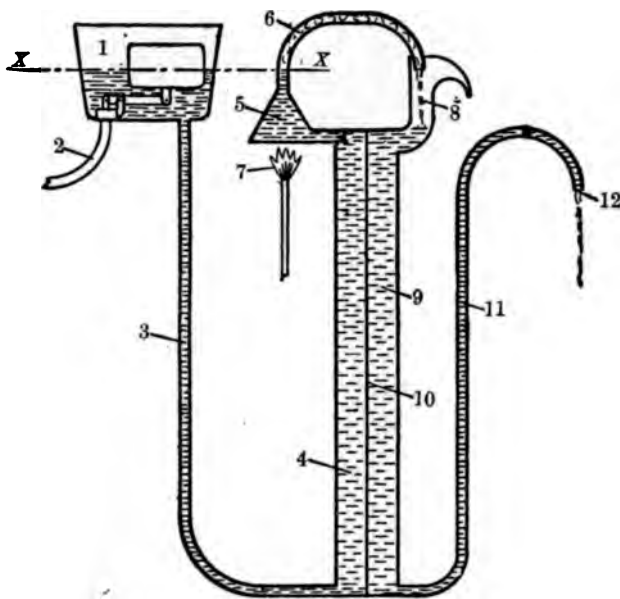

FIG. 29.—Forbes' stationary water sterilizer. The principle of operation of this apparatus is identical with that of the apparatus shown in Fig. 28, but the construction is slightly different. In this apparatus, 1 shows a water tank with a pipe, 2, through which water enters, and is allowed to fill the tank up to the water level *X*, but no higher, as it is restrained by the float-actuated valve shown in the tank.

The small tank with the float and valve merely take the place of the inverted bottle and aërostatic feed used in the first apparatus. Both the aërostatic device and the float and valve have the same functions, viz., maintaining the water level at the line *X*. In the second apparatus the pipe 2 is connected with a constant water-supply, such as a faucet or the water-supply pipe of the house.

After the water leaves the float box it runs down through the pipe 3, and the action of the apparatus from this point on is exactly like that of the portable sterilizer shown in Fig. 28.

Softening of Hard Waters.—Water is softened—that is, deprived of its temporary hardness—by the addition of lime-water. The lime combines with the carbon dioxide existing free in the water, forming calcium carbonate. This is precipitated together with the calcium carbonate and magnesium carbonate previously existing in solution, because they are rendered insoluble by the removal of the free carbon dioxide.

At Winnepeg, Manitoba, the following results were obtained :

| | Untreated. | Treated. |
|--|------------|----------|
| Calcium | 91.5 | 21.1 |
| Magnesium | 67.6 | 42.8 |
| Sodium | 167.2 | 167.8 |
| Iron and Aluminum | Trace | Trace |
| Silicic acid | 7.3 | 4.2 |
| Sulphuric acid | 172.9 | 172.4 |
| Chlorin | 242.0 | 242.0 |
| Hardness, as CaCO ₃ | 510.4 | 231.1 |

The hardness of the water due to other salts of calcium and magnesium is not affected by this treatment. The reaction which takes place on the addition of lime-water is as follows :

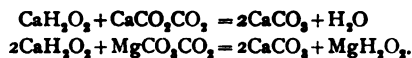

Great care must be exercised in regulating the amount of lime-water added to a hard water. This amount can be determined only by chemical tests.

Carbonate of sodium is efficacious for softening water for washing purposes, but it is unsuitable for water used for drinking purposes, as it leaves an unpleasant taste. Soda-ash combined with caustic lime is used for the softening of water for boiler purposes for the removal of sulphates and chlorids.

Sterilization of Water by Means of Chemicals.—

A large number of chemicals have been recommended for the sterilization of water, namely, alum, lime, salt, potassium and calcium permanganate, sulphate of iron, chalk, chlorid of iron, chlorid of lime, acetic acid, citric acid, formalin, sulphuric acid, alcohol, chloroform, iodine, chlorin, bromine, ozone, sulphate of copper, hypochlorites, etc. Upon bacteriologic experimentation it has been found that some of these are without any effect, while others require a very long time for their action. Many of them are objectionable on account of the fact that they discolor the water or alter its taste and odor in such a

manner as to render the water unsuitable for domestic use. The more these facts are borne in mind, the smaller the number of chemicals that can be used satisfactorily for the sterilization of water, and in practice only the following have proved serviceable—namely, chlorin, bromin, and ozone. The use of chlorin for the disinfection of water has found application in a number of localities where other methods of purification were not available. The chlorin is added in the form of calcium hypochlorite in amounts ranging from 2 to 10 mg. of free chlorin per liter of water. The amount of hypochlorite required to disinfect water is dependent upon the amount of organic matter present. A contact of about two hours should be allowed for the action of the chlorin. The amount of calcium hypochlorite employed should be carefully regulated in accordance with the amount of organic matter in the water. Excessive quantities of the disinfectant are to be avoided, not only because of the possible detrimental effects of the chlorin, but also because of the needless expense.

Bromin is used in the form of potassium bromid solution (60 mg. free bromin per liter of water). For the removal of the bromin from the water after it has been acting for a sufficient length of time the addition of ammonia or sodium sulphate or sodium carbonate is required.

Investigations have demonstrated that bromin is not capable of satisfactorily sterilizing water when applied on a large scale. Ozone seems to sterilize water satisfactorily in large quantities. This requires electrical apparatus such as is constructed by Siemens and Halske. In the application of ozone to the sterilization of water it is necessary to determine definitely the quantity of oxidizable matter in the water. The larger the quantity of such matter, the greater the quantity of ozone required, and consequently the greater the cost of operation. The relation between the ozone utilization and the oxidizable matter in the water must be under constant control, so

that an excess of ozone may be supplied at all times. The ozone, when present in sufficient quantities, kills all bacteria in the water without in the least affecting the taste, odor, or color of the water, and the excess of ozone remaining in the water after the sterilization disappears in a short time. This method of purification is expensive and requires constant, intelligent oversight.

Disinfection of Water with the Ultra-violet Light.

The application of the ultra-violet rays to the disinfection of water is made possible by the Westinghouse sterilizer. In this apparatus the water streams through a chamber in which it is exposed to the ultra-violet rays generated with a mercury-quartz lamp. Studies conducted with this apparatus by von Recklinghausen¹ show that with the use of less than twenty-six watt hours per cubic meter of water more than 600 cubic meters of water could be disinfected in twenty-four hours, and frequently the water was sterilized. All colon bacilli were killed. v. Recklinghausen believes that from the low cost for operation and the high efficiency of the method this method of disinfecting water has a bright future.

Suitability of Water for Boiler-purposes.—The suitability of water for boiler-purposes is largely an engineering question, though it is also of importance to the householder, because the conditions are the same in the boiler of the kitchen range or of the heating apparatus as in the boiler of a manufacturing establishment. Water may be unsuitable for boiler-purposes on account of its corroding action or on account of scale-formation. Water of the greatest purity is not always the best for boiler-purposes, because of its solvent action. This corrosive action may be increased by the oxygen and carbon dioxide in solution in the water. The corrosive action may also be due to the presence of organic and mineral acids in the water. Waters collected from swampy regions are usually rich in organic acids, while the waters derived from mines are rich in mineral acids. Water may also

¹ *Gesundheits-Ingenieur*, 34 Jahrg., 1911, p. 166.

possess a corrosive action because of the presence of soluble chlorids, especially sodium and magnesium chlorids. Oils may also favor the production of corrosive substances.

The corrosive action of water may be minimized or prevented by the removal of turbidity, by the addition of alkalies to neutralize the acidity, heating the water to drive off dissolved oxygen, while the action of the soluble chlorids may be prevented by the addition of the substances which will be described as useful in preventing scale-formation.

The ingredients in water which are most frequently concerned in scale-formation are the salts of calcium and magnesium. The amounts of silica and iron are rarely sufficient to cause scale-formation of any note. The most objectionable salt in water, with regard to scale-formation, is calcium sulphate.

Scale-formation is prevented by the neutralization of the carbon dioxid in the water. This acid operates in holding the calcium and magnesium carbonates in solution. The carbon dioxid may be driven off by heating the water before it passes into the boiler, so as to precipitate a portion of the calcium and magnesium. The carbon dioxid may also be neutralized by the addition of slaked lime or caustic soda to the water. These will combine with the carbon dioxid and precipitate it as well as the salts of calcium and magnesium.

Standard Method of Water and Sewage Analysis.

—A committee of the Section of Bacteriology and Chemistry of the American Public Health Association made a report on the standard methods of analysis at the annual meeting of the Association at Indianapolis, October, 1900, of which the following is an abstract of the more important points involved:¹

Collection of Samples.—Bottles for chemical samples should have a capacity of 1 gallon, should be made of clear white glass in order to facilitate inspection, and

¹ *Engineering Record*, October 27, 1900, and November 3, 1900.

should have glass stoppers. They should be washed each time before use with sulphuric acid and potassium bichromate, or with alkaline permanganate followed by sulphuric acid; they should then be thoroughly rinsed and dried. For shipment the stoppers and necks of the bottles should be protected with cloth tied over them. They should be packed in cases with separate compartments for each bottle, and lined with indented fiber paper, felt, or some similar substance, or provided with corner spring strips to prevent breaking. The packing boxes should be covered and provided with suitable fastenings.

“Bottles for microscopic samples should have a capacity of at least 1 quart, and should be of clear white glass, but they need not have glass stoppers. Bottles for bacterial samples should have a capacity of at least 2 ounces, and should have wide mouths and glass stoppers. Before use they should be washed as described above and then sterilized with dry heat for one hour at 160° C., or in an autoclave at 110° C. for one-half hour. For transportation they should be wrapped in sterilized cloth, or the neck should be covered with tin-foil and the bottles put in a tin box. When bacterial samples must of necessity stand for more than twelve hours before plating, it is profitable to use larger bottles than 2 ounces. The gallon bottle used for the chemical sample may be sterilized and used for the entire analysis. When samples are not plated at the time of collection, they should be kept on ice at not less than 10° C. Portable ice boxes with separate compartments for the ice and bottles may be sent by express with satisfactory results.

“The allowable time that may elapse between the collection of a sample and the beginning of its analysis cannot be stated definitely, as it depends upon the character of the sample and other conditions, but the following limits are generally safe :

“Chemical analysis. For fairly pure surface-waters, twenty-four to forty-eight hours; and for normal ground-waters, forty-eight to seventy-two hours. Polluted water requires analysis within twelve hours.

“Microscopic examination. For fairly pure waters, twenty-four hours. If fragile organisms, such as uroglena, synura, etc., are present, immediate examination may be necessary.

“Bacteriologic examination. Immediate plating is always best, but seldom practicable. Ordinary pure samples within twelve hours after collection will not introduce errors sufficient to vitiate the results.

“*Physical Examination.*—The physical examination includes observations of the temperature, general appearance, color, turbidity, and the odor in hot and cold samples.

“The temperature should be taken at the time of collection, and expressed, preferably, in centigrade degrees, to the nearest 0.5 degree. For obtaining the temperature of water at various depths the thermophone gives the most accurate results.

“The general appearance of the water should be determined by inspection in strong light after standing several hours. Substances remaining in suspension are then classed as ‘turbidity on standing,’ and substances settling to the bottom, as ‘sediment.’ The terms ‘none,’ ‘very slight,’ ‘slight,’ ‘distinct,’ ‘decided,’ etc., may be used for general work, as described in the reports of the Massachusetts State Board of Health. Where methods are used for expressing the turbidity and suspended matters numerically, as is necessary with sewage and some waters in some lines of work, the description of appearance may be omitted.

“At the present time there is no uniformity in the methods of measuring turbidity or suspended matter. The wire method, the disk method, the diaphanometer method, the gravimetric method, and the use of standards of comparison, all appear to have their field of usefulness. It is desirable that some system should be adopted for making the results by the various methods comparable, at least for those lines of work of the same general nature. In the absence of the necessary experimental

data, your Committee is unable to make a definite recommendation at present, although studies now in hand will probably make this possible another year.

“For measuring the amount of dissolved coloring-matter in waters, the platinum-cobalt scale appears to be very generally used, although the Nessler and natural-water standards and other methods are being used in important work. While the platinum standard does not appear to be wholly satisfactory, especially for very dark-colored waters, it appears to be generally suitable for ordinary use, and serves well as a basis of comparison for all results. Your Committee recommends that whenever any other method is used for color measurement the relation of this method to the platinum standard shall be indicated. In the case of waters which are appreciably turbid the suspended matters should be removed before determining the color which relates strictly to soluble matters.

“The odor should be observed in both hot and cold samples, and the results recorded in terms expressing quality and intensity, substantially as described in the paper on this subject presented to this Section last year.¹

“*Microscopic Examination.*—The modified Sedgwick-Rafter method appears to give general satisfaction. The majority of analysts express the results in ‘number of organisms per cubic centimeter,’ but those who have had the largest experience with the method prefer to express the results in ‘number of standard units per cubic centimeter.’ Inasmuch as the latter method takes into account the size of the various organisms, and may also be used for the amorphous matter, your Committee favors the general adoption of the standard unit method.

“*Chemical Analysis.*—So far as your Committee has been able to learn, the chemical methods used for an ordinary sanitary analysis of a water do not vary very

¹ *Trans. Amer. Public Health Assoc.*, p. 587, 1899.

materially in those laboratories where most of this work is now being done. As a rule, the differences which are found appear to be justified by the differences in the nature of the waters and the objects of the work. It appears, however, from general observation, that there is room for improvement in a number of laboratories in which water analyses are made in small numbers and at irregular intervals. The determinations which from general opinion are considered necessary for a satisfactory sanitary analysis of an ordinary water are as follows: Residue on evaporation, total and dissolved, with the loss on ignition in some instances; nitrogen as albuminoid and free ammonia, nitrites and nitrates; oxygen consumed; chlorine; and hardness. The general consensus of opinion regarding these determinations is quite harmonious on the whole, and the best current practice may be outlined in brief terms as given beyond.

“Within the past few years water analysts have had occasion to study types of water about which very little was known a few years ago, and to assist in a variety of special problems relative to water pollution and various processes for the purification of both water and sewage. Such investigations have naturally resulted in an increase in our knowledge concerning a number of analytical matters, about which there was comparatively little known, in practical terms in this country, a dozen years ago. Among the analytical methods relative to these studies, of a more or less special nature, may be mentioned those for alkalinity, iron, sulphuric acid, carbonic acid, and dissolved oxygen. While the methods for these and other determinations have been carefully worked out with reference to certain conditions and waters of certain types, it is felt by the Committee that there are a number of details which can to advantage be left in abeyance until another year. The general trend relative to these so-called special methods is outlined briefly beyond.

“With regard to the limits of accuracy of the several methods under various conditions, the determinations which can be best applied to various problems, the expression of the results of analyses, and the interpretation of their results, are all matters upon which the Committee has nothing to say until a further expression of experience and views is received from members of the Section.

“*Residue on Evaporation.*—The amount of water used should be preferably such that the residue will weigh from 3 to 12 milligrams, although with sewages a greater weight is allowable. Experience alone can indicate the volume of water to be taken. Relative to dissolved residue, the suspended matter can be satisfactorily removed from surface-waters of the glacial drift formation and from sewages by filtration through filter-paper. The submicroscopic clay particles of the southern and western waters can be best removed by a small Pasteur filter. This is not wholly satisfactory, as in some instances dissolved matters are absorbed by the filter, and in other cases they are removed from those stored in the filter. On an average it yields fair results, and no improvement can be suggested at this time.

“With regard to the use of sodium carbonate, practice varies; but it would seem to be wise to add it (with a deduction from total weight) to those waters and sewages in which it is of value to obtain the loss on ignition. Evaporation is almost invariably obtained in a steam bath at a temperature of nearly 100° C. The loss on ignition, it is believed, can be secured best with the use of a radiator, in accordance with Drown’s suggestions, although this device is not in general use. In fact, there is a growing tendency among workers to omit this determination, except for sewages and those waters relatively high in organic matter.

“*Chlorin.*—This is determined always by titration with a standard solution of silver nitrate, using potassium chromate as an indicator. Colored surface-waters first require decolorization by the addition of aluminum hy-

drate. The volume of water taken depends, of course, upon the amount of chlorids present. With unpolluted surface-waters in the East from 200 to 250 cubic centimeters should be concentrated by evaporation. In the case of sewages and highly polluted water containing much organic matter satisfactory results can be obtained by evaporation to dryness, ignition of the residue, and subsequent solution of the chlorids with hot distilled water. The titrations should be regularly made with volumes substantially the same as employed in the standardization of solutions.

“Nitrogen as Free and Albuminoid Ammonia.—The volume of ordinary water taken for distillation is 500 cubic centimeters, and with very highly polluted waters or sewages smaller quantities are taken and diluted to the above amount with ammonia-free distilled water. Where many sewages are analyzed, the volume taken may be 10 cubic centimeters or less, in accordance with Hazen's method. As a general rule, it seems advisable to add a few drops of a saturated solution of sodium carbonate before distillation. It is advisable to collect the distillate in the Nessler tubes in which this color is to be read. The rate of distillation should be 50 cubic centimeters in five or six minutes. It is an almost universal custom to collect 3 tubes of 50 cubic centimeters each for the free ammonia, and 5 tubes for the albuminoid ammonia. In regard to the preparation of alkaline permanganate and Nessler solutions, the directions in any good text-book may be followed, and the individuality of various workers in these particulars is apparently not a factor affecting unfavorably the accuracy of results. Both the distillates and the standard ammonia solutions should be of the same temperature before the addition of the Nessler solution.

“Nitrogen as Nitrites.—No method superior to the Warrington modification of the Griess method is now known.¹

¹ See *Special Report of the Mass. State Board of Health, Part II., 1890.*

Nitrogen as Nitrates.—The determination of nitrogen as nitrates is made almost exclusively by two methods, the phenol-sulphonic acid method of Grandval and Lajoux, and the aluminum reduction method. With waters comparatively high in nitrates, and if a good brand of nitrogen-free caustic soda can be obtained, the aluminum method is more easily worked, and gives better average results. With waters low in nitrates and low in chlorin the phenol-sulphonic acid method gives as good or better results than the reduction method. It is intended to consider the comparative merits of the two methods in detail in the later report.

Oxygen Consumed.—Practice varies widely both here and abroad with reference to the method for this determination; and many analysts omit it from the analyses of certain types of water. For sewages and those waters which are high in organic matter it undoubtedly yields valuable information. It would appear advisable to adopt a uniform procedure intermediate between the wide extremes now practised. Such would be afforded by the addition of the reagents to the water when cold, and boiling for five minutes.

Hardness.—For ordinary sanitary work the soap method is commonly used, and for the soft eastern waters it appears to give reasonably satisfactory results. For the hard waters of the West Höhner's acid method is preferred. There are some details connected with the determination of the permanent hardness by the Höhner method which require further study.

Alkalinity.—This determination can be satisfactorily made by Höhner's method. Methyl-orange is used by some workers as an indicator, while recent comparative studies give the preference to lacmoid or erythrosin. The latter indicators have the advantage, in connection with the use of coagulants, of affording the most reliable test for the presence of undecomposed alum in water.

“Relative to the latter point, the logwood test is considered satisfactory by some workers, while by others it

WATER AND SEWAGE ANALYSIS.

seems to be more of a qualitative test than a quantitative one. The differences in opinion are very likely due to unappreciated differences in manipulation which require further study.

“*Iron.*—There are evidently several methods of an allied nature which can be used successfully for this determination, provided they are carefully applied. In another report the Committee can probably give a graded set of procedures applicable to various conditions of practice. Thompson's method, as described in Sutton's *Volumetric Analysis*, appears to be most generally used.

“*Sulphuric Acid.*—Wildenstein's method as described by Ohlmüller has proved very satisfactory for certain lines of work, and is preferable to the gravimetric method. Whether or not this is true under a wide range of conditions remains to be seen.

“*Carbonic Acid.*—For eastern waters Pettenkofer's method as described by Sutton is considered to be generally satisfactory; while for the western waters Trillich's modification of this method, as described by Ohlmüller, is preferred by some workers. This method gives both the free and half-combined carbonic acid. There is a growing tendency among chemists to attach the more importance to the free carbonic acid alone. This can be obtained differentially by the method by which the free carbonic acid is removed by the passage of the water through a tube containing small gravel stones, with a current of air drawn in the opposite direction. Further study of this entire subject will place it on a more substantial basis.

“*Dissolved Oxygen.*—There appear to be several methods which can be used successfully for this determination. The method in most general use, however, is that of Winkler as described in the *Special Report of the Massachusetts State Board of Health*, Part I., 1890.

“By the way of general comment, it may be added that recent developments in sewage purification have indicated the desirability of special attention to several

matters. Among them is the advantage coming from a more general use of the determination of suspended matters in sewage, with the loss on ignition. Another point is the desirability of determining the organic nitrogen in unpurified sewage by the Kjeldahl method, in view of the varying percentage of this constituent which is afforded by the albuminoid ammonia. The so-called 'incubation-test,' to show the relation to putrefaction of sewage after purification, seems to have much practical value under certain conditions, although the details cannot be considered at this time.

Quantitative Bacterial Examinations.—With reference to this subject, there has recently been a marked improvement in the general results obtained in this country. It is true, however, that methods of different workers are still variable to a degree which seems unnecessary, and which is certainly not desirable, when we consider that the value of this class of data relates largely to purposes of comparison.

"The culture-medium now in general use is nutrient gelatin, prepared substantially as recommended by the Bacteriologic Committee in their report of 1897. Meat-extract, however, is still used by a number of workers in place of meat-infusion. Data are lacking to justify this as a general procedure. For some special lines of work nutrient agar is used with apparent advantage. These conditions refer to analyses of decomposed or stale sewage, where the number of bacteria capable of rapid liquefaction of gelatin is very large; and also to certain lines of field work. Several investigators have tried media of modified composition, containing new ingredients in some instances, but the present evidence is altogether too inconsistent and indefinite to permit of any recommendations along this line.

"Concerning the reaction of the nutrient gelatin, the optimum varies under different conditions. Speaking in general terms, the majority of waters now studied appear to require ordinarily about 1 per cent. of acid. There

WATER AND SEWAGE ANALYSIS.

are some waters for which this reaction is too acid, and the sewage of some manufacturing cities evidently requires an alkaline medium. For important continuous work the reaction to be used should be carefully worked out with reference to the local conditions.

“The amount of agitation which the sample of water should receive before plating, in order to insure mixing and a separation to a reasonable degree of groups of bacteria, is afforded by twenty-five vigorous shakes of the partially filled sample bottle.

“Most workers arrange, so far as practicable, to have not more than about 200 colonies on the ordinary plate, such as Petri dishes having a diameter of about 4 inches. For those waters in which such numbers of bacteria are contained in small fractions of 1 cubic centimeter, it is the general practice to dilute them with sterilized water, rather than to use pipets delivering small fractions of 1 cubic centimeter.

“The amount of nutrient gelatin used for each plate ranges at different laboratories from 5 to 10 cubic centimeters. Most workers use more than 7, while in some of the largest laboratories the quantity is 5 cubic centimeters. For results to be obtained after four or more days of cultivation the larger quantity is doubtless preferable. For results to be obtained after two days' growth 5 cubic centimeters are found to be more satisfactory.

“Practice varies with reference to mixing the water and the gelatin in the tube or on the dish, in those cases in which Petri dishes are used. There are no evidences to indicate that this is a point of much practical significance, affecting results beyond the ordinary limits of accuracy.

“With regard to standard conditions of cultivation, the best available evidence shows that it should take place in the dark and in an atmosphere in which moisture and oxygen are always present. Petri dishes sometimes fit too tightly to give satisfactory results, and special attention is necessary to these particulars. The tempera-

ture of cultivation should be uniformly at 20° C., and it is gratifying to note that in many laboratories this standard has been adopted, notwithstanding the care and expense which it sometimes involves.

“The period of cultivation still varies considerably in the different laboratories. There is a well-defined movement, however, toward shorter periods, in order to secure greater practical value for the data. These practical advantages outweigh the smaller numbers obtained from a shorter period, especially as all results have only a relative and not an absolute value. In Germany forty-eight hours is the standard period of cultivation, and daily results have been obtained on this basis from each of 26 water purification plants in operation in that country. There seems to be no good reason why the bacterial results to be obtained from the various water purification plants now in operation and about to be built in this country should not be comparable with those obtained abroad. This is especially true in view of the growing appreciation of the fact that the residual numbers of bacteria in a filtered water should receive attention as well as the percentage of bacterial removal. Taking everything into consideration, it would appear to your Committee to be advisable to adopt forty-eight hours as a standard period of cultivation under the conditions noted above. Before making a final recommendation there is requested a further expression of opinion on the part of the members of the Section of Bacteriology and Chemistry.”

CHAPTER V.

THE REMOVAL AND DISPOSAL OF SEWAGE.

THE term *sewage* includes not only human excreta, solid and liquid, but also the waste water and impurities coming from human habitations. The term sewage, however, does not include such impurities as proceed from manufactories, such as the refuse from dye-works, gas-works, etc.; these are termed manufacturing impurities. From a hygienic standpoint the human excreta are the most important constituents of sewage. The sewage of towns usually contains, besides human excreta and household wastes, the water used for washing and sprinkling streets, as well as the rain that falls which is not stored for household use. The total quantity of sewage depends largely upon the amount of pure water supplied per head per day. Sewage has an average composition of 998 parts of water, 1 part of urine, and 1 part of organic matter.

The Removal of Sewage.—The removal of sewage from the dwelling is accomplished by several different methods. That in general use in towns is by means of water. This system necessitates the introduction of the necessary waste pipes for the removal of the sewage itself, the introduction of a supply of water sufficient to flush out the drain pipes and keep them free from sewage. It also necessitates arrangements for the disposal of the sewage.

Water-closets.—Where water is employed for the removal of sewage the water-closet forms a most important factor in the system. The qualities required by all the appliances of a water-closet are durability, simplicity, accessibility, cleanliness, and general effectiveness. The

old-style pan closet (Fig. 30) is no longer in use. The principal forms of closet that are now in use are the

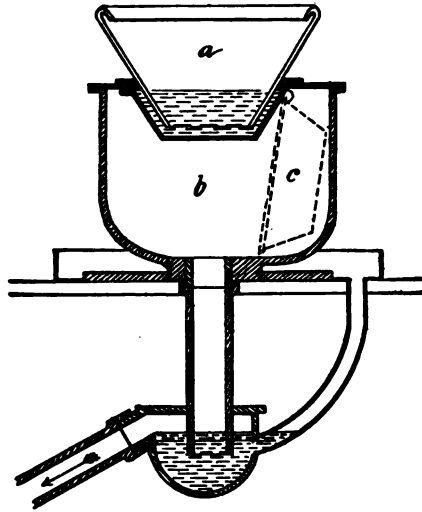

FIG. 30.—Pan closet.

hopper (Fig. 31), some form of wash-out or wash-down closet for private dwellings (Figs. 32, 33), and the

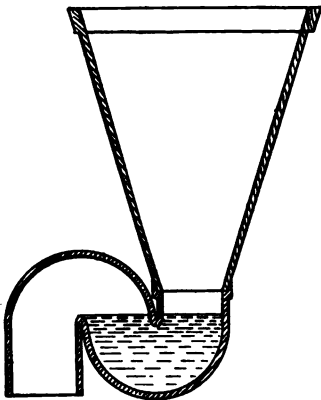

FIG. 31.—Hopper closet.

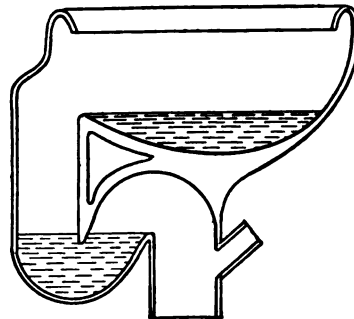

FIG. 32.—Wash-out closet.

trough closet or latrine for schools and public institutions.

The supply of water for the wash-down closet is obtained by the introduction of a separate cistern, used exclusively for the water-closet, generally termed a "water-waste

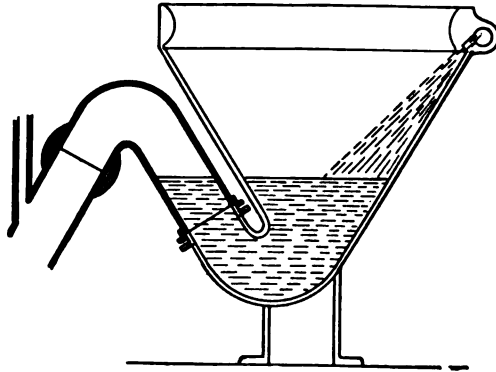

FIG. 33.—Wash-down closet.

preventer" (Fig. 34), because only a limited supply of water is available for delivery. The amount of water usually supplied in the cistern is about 15 liters. The

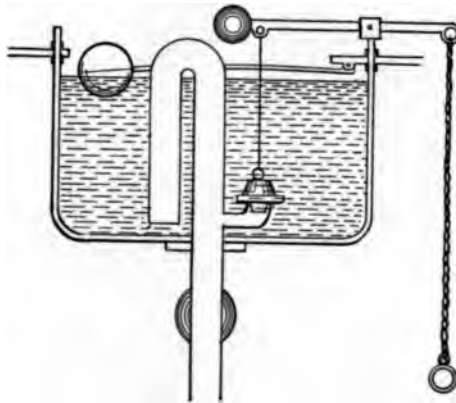

FIG. 34.—Water-waste preventer.

cistern is placed at some height (not less than a meter) above the closet, and has an exit pipe of considerable size, so that the water may descend with sufficient force to flush effectually the closet.

The position of the closet chamber is of importance. It should always be arranged along the outer wall of a building, so as to afford ventilation into the open air, and not into an air shaft. The closet itself should be along the inner wall, opposite a window, so as to afford plenty of light to detect any defects.

The arrangement of a bath-room, in which all the

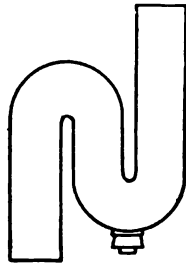

FIG. 36.—S-trap.

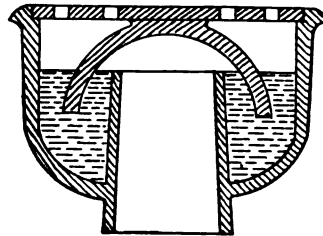

FIG. 37.—Bell-trap.

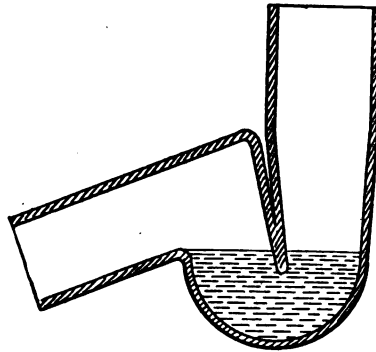

FIG. 38.—Anti-D trap.

modern improvements in the sanitary removal of sewage are supplied, is shown in Fig. 35. In the modern dwellings now being constructed the conveniences supplied in bath-rooms are important factors in conserving the health of the individual as well as of the community.

Traps.—A trap is a bend in the pipe which is filled with water so as to prevent the entrance of sewer or drain air into the house. It consists of a water seal in the pipe.



Fig. 35 — Arrangement of a modern bath-room (Trenton Potteries Co.).



All appliances on the drainage pipes of a house, such as water-closets, sinks, etc., must be supplied with a trap. The different forms of traps in use are the S-trap, the

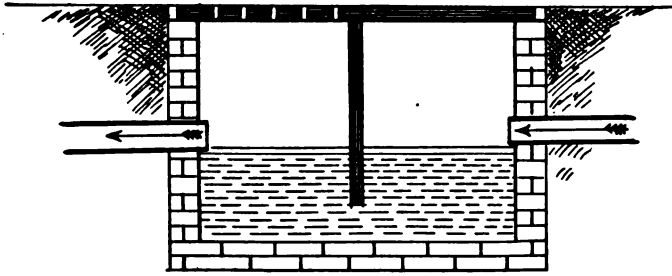

FIG. 39.—Mason's trap.

bell-trap, the anti-D trap, and Mason's trap (Figs. 36, 37, 38, and 39).

Soil Pipe.—The pipes for carrying away the sewage

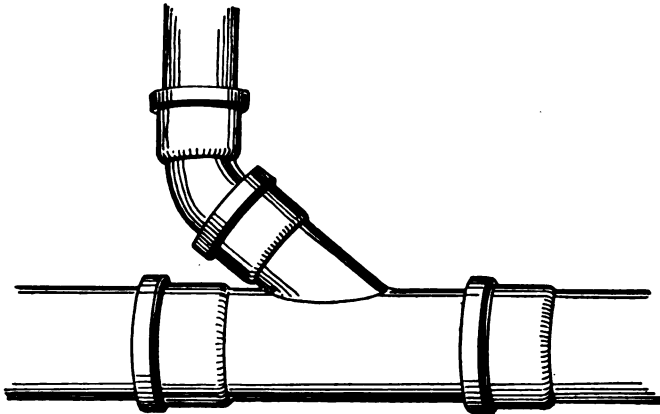

FIG. 40.—Method of connecting soil pipe with house drain.

from a house are called soil pipes. For an ordinary dwelling the soil pipes should be constructed of heavy iron tubing, with tight joints, circular in shape, and 10 centimeters in diameter. The interior of the soil pipe must be smooth, so as not to impede the flow of the sewage. The soil pipe is ventilated through the warming of its contained air, causing an upward current, the fresh air entering

through a ventilator opening on the outside of the house next the point of disposal, and takes its exit through the upper end of the pipe, which is carried up over the roof of the building. The soil pipe should have an S-shaped trap between the ventilator opening and the sewer. All connections of drainage pipes with the soil pipe must be absolutely tight, and should be made at an acute angle, not at a right angle with the soil pipe (Fig. 40).

Where several closets on different floors discharge into

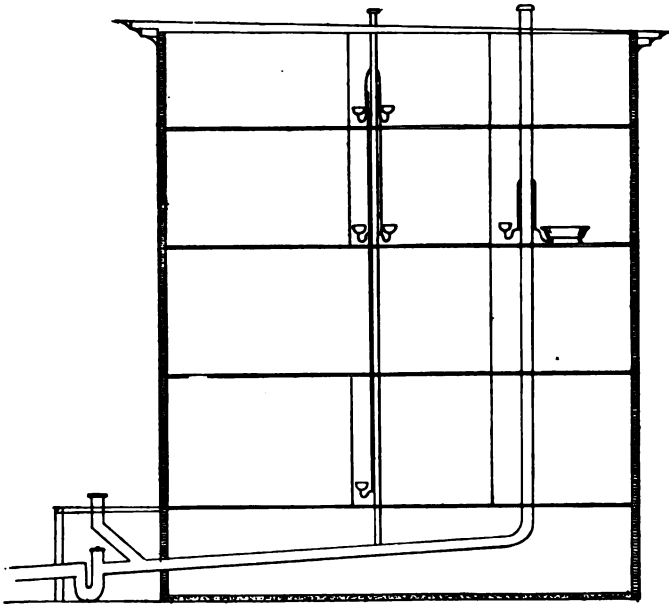

FIG. 41.—Arrangement of soil pipe.

the same soil pipe, the suction of the water in the soil pipe causes the trap of the other closet to become unsealed. To obviate this defect the traps are supplied with a separate ventilating pipe of small diameter, which enters into the soil pipe above the highest appliance of the system. These extra pipes also serve to ventilate the traps and pipes, and for this reason this is frequently spoken of as the "back-airing" of traps. It serves to

supply fresh air to the pipes, and thus serves to prevent the growth of anaërobic bacteria in the unventilated portion of the traps. This prevents the generation of disagreeable odors. The method of ventilation of soil pipe and the traps is represented in Fig. 41.

The required amount of fall for house drains may be determined according to the following rule: Multiply the diameter of the drain in centimeters by 4; thus a 10-centimeter drain should have a fall of 1 in 40; a 15-centimeter drain 1 in 60, and so on. If the distance from the

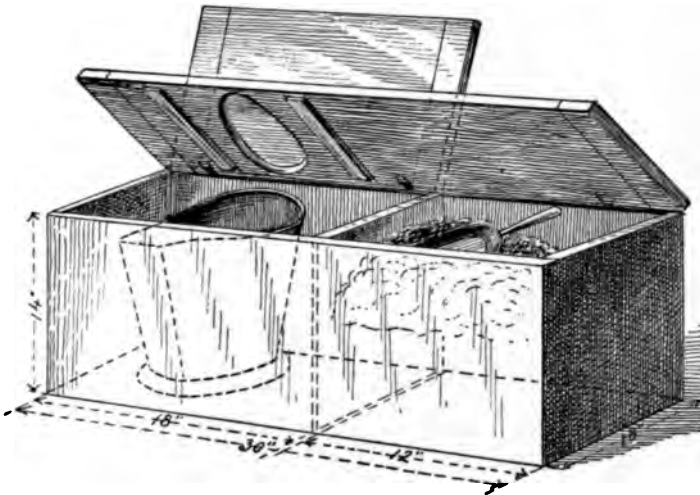

FIG. 42.—Dry-earth closet.

appliance to the soil pipe is too great to obtain the requisite amount of fall in the limited space between floor and ceiling, it will be necessary to have extensions from the soil pipe from the basement to the roof to receive these drains.

Another method of sewage removal is usually spoken of as **the dry method**. The pail system and the dry-earth closet are the principal types of the dry methods of sewage removal. In the pail system the excreta are simply received in boxes or tanks, and these are emptied whenever necessary. In the dry-earth closet a receptacle

containing dry earth is placed in the closet and about $\frac{1}{2}$ kilogram of dry earth is thrown over each evacuation (Fig. 42). The earth is a natural deodorizer and the mass remains inoffensive for a long time, the fecal matter being finally entirely disintegrated. A separate receptacle is supplied for the collection of the urine. This system is the least objectionable in such localities where a general water-supply is not available, or where the climate is too severe to render a water-closet safe and serviceable.

Disposal of Sewage.—The question of the disposal of sewage is distinct from that of sewage removal, but the method of disposal is dependent, to some extent, upon the method of removal. In the dry methods of removal the final disposal of the fecal matter is as fertilizer upon cultivated land. If the removal is by means of water, this will be either partial, as to a cesspool, and hence further removal, after longer or shorter intervals, as well as final disposal, may be necessary, or the removal may be partial through a sewerage system and final disposal into streams or large bodies of water, treatment by precipitation processes, or by the various methods of purification.

In rural districts where there is no general sewerage system the house drains usually discharge into cesspools or tanks for the storage of sewage. Cesspools differ in their construction and mode of operation according to the nature of the soil in which they are located. Where the soil permits and the amount of space is sufficient, the cesspool may be constructed so as to allow the fluid portion of the sewage to drain away at once. Where no wells are near enough to be affected by this process the cesspool may operate for a long time without being cleaned out. Where the nature of the soil does not permit this mode of disposal of the fluid portion of the sewage, or where there is danger of infecting neighboring wells, the cesspool should be so constructed as to be impervious. Under these conditions it will require

frequent cleansing, the contents removed serving as fertilizer. Such a cesspool should be removed from the house and well as far as possible, and in such a position that the flow of the ground water is always in the direction from the well toward the cesspool.

A large majority of towns discharge their sewage into neighboring streams. All new works of this nature are prohibited in England. In Ohio and Pennsylvania health authorities also have the power to prohibit new works of this nature wherever the stream serves as a source of water-supply for another town further down its course. The effect of discharging sewage into streams is such that the streams are polluted to an extent sufficient to destroy the fish contained in it. Such water is always injurious to health when used for drinking-purposes. The Rivers' Pollution Commission of England reached the conclusion that none of the rivers of England were long enough to purify themselves by the natural agencies after having been polluted.

Towns along the seaboard find the easiest and most economical method of sewage disposal is to discharge it into the sea. There are, however, objections to this method. If the discharge is made near a watering-place, it will injure the bathing. The sea-water will also cause the precipitation of certain constituents of the sewage, and this matter will cause the formation of a barrier or reef along the shore, unless it is carried out into deep water.

Chemical Treatment of Sewage.—Where there is removal by water, but no opportunity for disposal into streams or other bodies of water, the sewage may be subjected to one of several processes of precipitation. The sewage is sometimes first strained to remove the coarser particles by passing it through screens. The materials employed in precipitation processes are lime and ammonium sulphate; lime and iron protosulphate; the ABC mixture, consisting of alum, blood, and clay; and ferrozene and polarite. The precipitated matter, or sludge, as it is called, is used for fertilizing

purposes, and the fluid portion is discharged into streams.

Precipitation works are in use in the following cities of England : Acton, Ealing, and Sutton, and the process is still partially in use at Manchester, though here a portion of the sewage is treated by several of the modern methods of purification. Precipitation works are also in use at Frankfort-on-the-Main, at Alliance, O., and at Worcester, Mass., though at the latter place a portion of the sewage is purified by filtration.

The various methods of chemical treatment of sewage may be divided into the following groups :

1. Intermittent treatment in tanks from 1.5 to 2.5 meters deep, in which, after the addition and incorporation of the chemicals, the sewage is allowed to remain until the completion of the process.

2. Continuous treatment in a series of tanks through which, after the addition and incorporation of the chemicals, the sewage flows slowly; crude sewage and chemicals passing in at one end, and purified effluent passing out at the other.

3. Vertical tanks through which the sewage rises slowly after the addition of the chemicals.

There are a number of variations of these three systems, but none of them is important enough to justify further subdivision into classes.

The conditions necessary for success from chemical treatment are as follows :

1. The sewage should be treated while fresh.
2. The chemicals should be added to the flowing sewage and thoroughly mixed with it before it passes into the settling tanks.
3. There should be a liberal amount of tank space.
4. The arrangements for the removal of the sludge should be such as to insure its frequent removal.

The sludge obtained by the treatment of sewage is often a further trouble, because it has to be finally disposed of. It may be burned, or it may be used for

fertilizer if it can be disposed of in this manner. At Manchester, England, much of the sludge has been used in filling in low land adjacent to the precipitation works.

Modern Methods of Sewage Purification.—The old theory that filth containing pathogenic organisms would, when exposed to the sun, propagate various diseases, has been entirely overthrown. Experimentally and practically, sewage has been discharged upon land, which may or may not have been prepared to receive it, with the result that the pathogenic organisms and the offensive nature of the material are most effectively destroyed.

If the sewage is discharged onto a piece of land for the purpose of enriching the soil for raising crops, it is known as irrigation; if it is discharged over a large area, it is called broad irrigation; if it is discharged upon land specially prepared to receive it, with no idea of raising crops, it is known as filtration.

In broad irrigation the fields should be divided into sections 10 to 15 meters square, which are raised in the middle; or if the fields are uneven in contour, they should be raised into ridges of corresponding width. The sewage is conveyed to the middle of the section through an open drain. At certain distances dykes are placed in a drain, which cause the sewage to overflow on the slopes of the section. In order to operate satisfactorily, and carry the sewage to all parts of the field, it is discharged upon the field intermittently, either automatically by means of a Field flushing tank (Fig. 43) or by opening and closing sluices whenever a discharge is desired. In cold latitudes the operation of the irrigation field is inhibited by frost, as the absorptive power of the soil is feeble at low temperatures. From a sanitary standpoint the system has had a most careful investigation, especially in England, and these observations have failed to show the origin of any case of contagious disease from it.

Since 1870, when the Rivers' Pollution Commission of

England proposed in their report the purification of sewage by irrigation of cultivated land, the system has been introduced into over 145 English towns. Other European towns have also adopted it, including Berlin, Breslau, and Dantzig. In America it has been introduced at Wayne, Pa., Pullman, Ill., Greenfield, Mass., and Berlin, Ont. In the western States, where there is a scarcity of water, sewage has been utilized for irrigation with considerable success. In California, Fresno, Pasadena, Redding, Los Angeles, Santa Rosa, and Stockton, all irrigate with sewage. In Colorado, Colorado Springs and Trinidad utilize sewage for irrigation purposes.

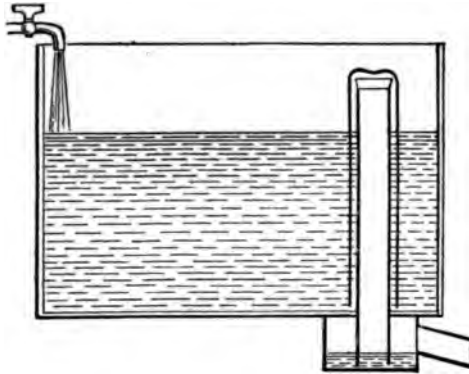

FIG. 43.—Field's flushing tank.

Helena, Mont., and Cheyenne, Wyo., also utilize sewage in this manner.

In order to operate satisfactorily the system requires 1 acre of area for each 2000 persons (2 square meters per person), and consequently it is not adapted for localities where cheap land in sufficient quantities and of suitable quality cannot be obtained. Large towns must, therefore, usually avail themselves of some other method of sewage purification.

Purification by Filtration Through Sand.—The filtration of sewage through specially constructed sand filters, or through a natural sandy, loamy soil, is efficacious

in the purification of sewage. Because of the absence of free oxygen in sewage the filtration must be carried on by the intermittent method in order to give the nitrifying bacteria an opportunity to recuperate. These filters are usually operated for half a day and then allowed to rest the second half of the day. This necessitates the construction of two filters that can be operated alternately.

Experimentally, much work has been done at the Lawrence, Mass., Experiment Station upon intermittent filtration, by passing sewage through various depths of different soils. It was found, among other results, that some forms of bacteria would pass through certain filters more readily than others; that in certain cases where the total number of sewage bacteria had increased while the sewage was passing through the filter, the number of species of bacteria had greatly diminished.

Intermittent filtration has been in practical operation for some time at Chichester and Sutton, England, and at Gardner, Marlborough, Clinton, South Framingham, Medfield, Worcester, and Brockton, Mass., Summit, N. J., East Cleveland, O., Hastings, Neb., Vassar College, Poughkeepsie, N. Y., and the Iowa State College, at Ames, also recently adopted this system of purification. In all of these towns the system employed is practically a combination of filtration and irrigation. The effluent water from this combined filtration and irrigation method in no way indicates its origin by temperature or smell. It may easily be mistaken for spring-water, as it comes out of the pipe clear and sparkling.

At Amherst, Mass., the sewage is collected in a stone tank 450 x 600 x 180 centimeters in size, divided into two equal compartments, in which the sewage is allowed to settle. This arrangement allows one compartment to be cleaned of its sludge while the other is receiving the sewage. The sludge is removed once a week. The effluent flows through a pipe to the river, about 150 meters distant. No further purification of the sewage is

attempted. This method is obviously incomplete, and should be used only as a preliminary step to irrigation, filtration, or chemical treatment.

The following table shows the average results of continuous filtration through 10½ feet of coarse broken stone, at an average rate of 1,897,000 gallons per acre daily for six days in the week, from May to November, inclusive (parts per 100,000):

FILTRATION THROUGH COARSE BROKEN STONE.

| | Sewage. | Effluent. |
|--|-----------|-----------|
| Temperature, degrees Fahr. | 63 | 63 |
| Free ammonia | 3.47 | 0.7265 |
| Albuminoid ammonia | 0.57 | 0.0963 |
| Chlorin | 7.58 | 5.96 |
| Nitrogen as nitrates | — | 1.88 |
| Nitrogen as nitrites | — | 0.1247 |
| Oxygen consumed | 3.72 | 1.09 |
| Bacteria per c.c. | 2,049,000 | 144,000 |
| Dissolved oxygen, percentage of saturation | — | 38 |

Subsurface Irrigation.—Another method of sewage disposal which is available for small towns or for isolated dwellings or hotels in rural districts, is what is known as subsurface irrigation. In this system pipes with open joints are distributed underneath the garden or lawn through which the sewage flows and percolates through the open joints into the soil. This system requires the introduction of a flushing tank in order to carry the sewage to all parts of the system. The household drains empty into a large flushing tank, having a capacity of about 15 cubic meters, separated into two chambers by a wire-cloth strainer to hold back obstructing material. A certain amount of sludge accumulates in the bottom of the tank and has to be removed at intervals. This system requires about 40 square meters of area for each person (1 acre per 100 persons).

The Cameron Septic Tank.—Within recent years the purification of sewage on a large scale has been studied experimentally and practically in what is known as the septic tank or bacterial treatment of sewage (Figs. 44, 45).

This is a complicated system which utilizes the dissolving and liquefying action of anaërobic species of bacteria in one portion, the so-called septic tank, and the oxidizing action of aërobic species of bacteria in another portion, the filter beds, several of which are arranged in series. Various modifications of the system are in use in England and America, all being on the general plans proposed by Cameron. The sewage is discharged into set-

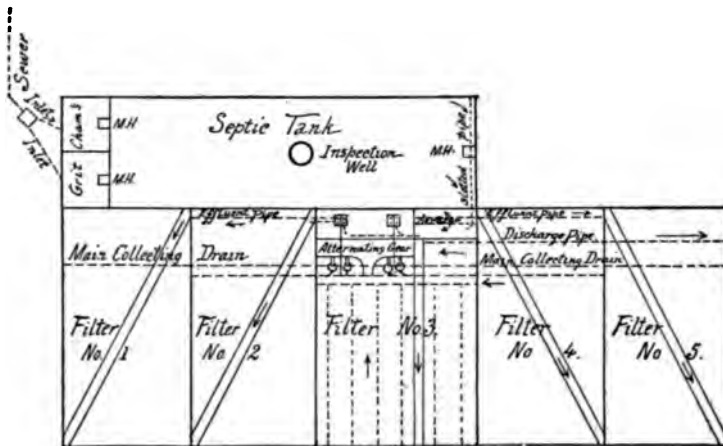

FIG. 44.—Arrangement of septic tank and series of filter beds.

ting basins, from which it is transferred to the septic tank. In some of the works the septic tank is made practically air-tight, so as to facilitate the growth of anaërobic species. In others it is simply an open tank, the idea being that since the sewage is devoid of free oxygen, therefore the conditions are favorable to the development of the anaërobic species, because the surface scum which forms renders the access of air without effect. Some of the action which it is proposed to obtain in the septic tank has already taken place in the sewage during its course to the disposal works. After the solid matters in the sewage have undergone solution and liquefaction in the septic tank the sewage is discharged upon the first series of four or five filters, on which a mixed action of anaërobic and aërobic bacteria takes

place, bringing about the breaking down of the intermediate dissolved bodies. These

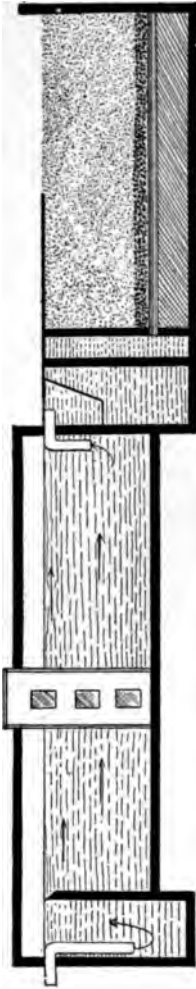

FIG. 45.—Section of septic tank and filter.

filters are operated automatically, so that one fills after the other. When the last filter begins to fill, the first filter discharges its contents. From these primary filters the sewage is discharged on to another set of filters, the secondary or aerobic filters, where the oxidation process is completed. In some of the works the sewage is discharged on to the secondary beds by means of a revolving sprinkler. Some of the works are without the secondary filter beds. The filter beds are composed of various kinds of material, as clinkers and coke.

The bacterial treatment of sewage by means of the septic tank has been carefully studied in various places in England. The London County Council has made extensive studies on the treatment of London sewage. The city of Manchester has studied the problem for several years. It has also been studied at Exeter, Oswestry, Redhill, and Sheffield, and at Urbana, Ill. This system has been intro-

duced at Independence, Mo., and has been thoroughly studied by the Massachusetts State Board of Health.

The results of these studies have been quite satisfactory, as shown in the following report:¹

“From the results obtained in England and at the Lawrence Experiment Station during 1898 and 1899, it

¹ *Report of Massachusetts State Board of Health*, p. 424, 1899.

has been fully demonstrated that the addition of a septic tank to a sewage purification plant may be of great value in many instances. It has been stated many times in the reports of this Board that the matter in suspension in sewage is the chief factor in clogging the surfaces of intermittent sand filters. By the action of the tank a very large proportion of these matters in suspension is eliminated from the sewage when it flows through the tank. A certain portion changes its form and escapes, while undoubtedly at times, as has been repeatedly noticed at Lawrence, considerable very finely divided solid matter comes from the tank. This occurs at times when the movement of the gas in the tank disturbs the sludge, and, while lasting only for a few minutes at a time, causes considerable solid matter to flow out in suspension. The solid matter removed in this way is of such a nature, however, that it is rapidly oxidized when reaching the filter. It is shown by the results obtained at Lawrence that a greater percentage of change occurs with the carbonaceous matters entering the tank than with the nitrogenous matters. It is also evident from observation that the clogging of the surfaces of intermittent sand filters is due largely to carbonaceous matters—cellulose, paper, etc.—rather than to nitrogenous matters. For example, the analysis of a typical sludge, which had covered in the form of a scum the surface of one of the beds at a filtration area of the State, showed that only 2.5 per cent. of it was organic nitrogen, while it lost 53 per cent. on ignition, due to the large amount of carbonaceous matter present. Careful inspection has shown that when these carbonaceous matters are exposed in comparatively thin layers on or near the surfaces of filters, and their destruction depends entirely on oxidation, they will remain for a very long period without much change. In the septic tank, however, where the oxidizing actions are eliminated, and only the putrefactive bacteria live and work, this carbonaceous matter is more quickly attacked by them, with the evolution of carbonic acid gas and marsh gas.”

The results obtained by the London County Council in its studies of the efficiency of the bacterial treatment of sewage show that, while the organic matter is destroyed, the pathogenic bacteria remain in the sewage in very nearly the original numbers in the crude sewage. For instance, there is practically no reduction in the number of colon bacilli present, and it is, therefore, fair to assume that there is no reduction in the number of typhoid bacilli. This fact indicates that the effluent from the coke beds is by no means free from danger when discharged into running streams. In order to overcome this objection the suggestion has been made that the effluent be further treated by passing it through a sand filter. It appears to be in good condition to be efficiently purified by sand filtration. The chemical purification of sewage at Oswestry, by this system, shows a reduction of 90.2 per cent. of the albuminoid ammonia, and of 89.8 per cent. of the oxygen consumed.

The operation of the septic tank in the purification of sewage depends upon the character of the sewage. Dr. Kinnicutt¹ states that the action of the septic tank may be summarized as follows: "1. The amount of total solids removed equals about 26 per cent. of the total quantity in the sewage. 2. The amount of suspended and dissolved solids removed depends greatly on the character of the sewage. With an alkaline domestic sewage the removal of suspended matter is greater and that of the dissolved matter less than with a sewage containing free acid and iron salts. 3. The amount of total organic matter removed, as judged from determinations of albuminoid ammonia, also depends upon the character of the sewage. It ranges from 17.5 to 60 per cent. As a rule, the stronger the sewage, the greater will be the percentage of organic matter removed; more is removed in warm weather than in cold, and more from an alkaline domestic sewage than from an acid sewage con-

¹ *Engineering Record*, 1902, vol. xlii., p. 295.

taining manufacturing waste. 4. The amount of sludge decomposed has been usually overestimated.

Sludge in Septic Tanks.¹—Septic tanks were first put in operation in the Lawrence Experiment Station of the Massachusetts Board of Health in 1898, and since that time tanks of this sort have been operated there. In the Board's last annual report there are some figures showing disappearance of sludge which has been observed in tanks; while such figures are applicable only to the local sewage, they are of considerable interest because made with both concentrated sewage containing large amounts of suspended matter, and with the regular station sewage. The two tanks receiving concentrated sewage were operated with storage periods of eighteen hours to fifteen days in one case, and of five hours in another, and showed a disappearance of 82 and 75 per cent. of the sludge respectively. In the tanks receiving station sewage, from 68 to 89 per cent. of the sludge disappeared. The detailed analytical and measurement results show that more than 80 per cent. of the volatile organic matter deposited in the septic tanks in question is passed into solution or given off as gas. At times gas evolution causes sediment to rise and pass from the tanks, so that much matter passes off this way, which causes the figures showing sludge destruction to be greater than is actually the case. This fact has been pointed out in earlier reports. The analytical results show an apparent decomposition of much mineral matter, but this must be due mainly to the passage of this matter from the tanks without being detected. The average station sewage contains about 2080 lbs. of suspended matter per million gallons.

The Bacteria or Contact-bed System.—In this system the sewage is treated in an open tank containing a bed of coke, clinker, or clay to a depth of 1 to 2 meters. On the floor of the tank are open-jointed collecting pipes. These contact beds are usually operated in pairs, the first or primary bed acting on the sewage for several hours and then discharging its contents on to the second bed by

¹ *Engineering Record*, Dec., 1907, p. 617.

gravity, where the sewage is treated for the same length of time. This system was devised by W. J. Dibdin, formerly Chief Chemist to the London County Council. The action of these contact beds is intermittent, but differs from intermittent downward filtration in that the sewage is held in contact with the bed material for some time. The coarseness of the material composing the beds makes it necessary to hold the sewage in contact with it to allow time for the nitrification to take place.

This system has been studied at Manchester and at several points in London during the past five or six years. The amount of purification brought about by this system, as shown by the Manchester experiments, is a reduction of the oxygen consumed from 77.4 to 83.4 per cent., and of albuminoid ammonia from 67.8 to 76.1 per cent. The contact beds received three and four fillings a day in the Manchester experiments, and the efficiency seemed greatest with four fillings a day.

The Garfield Coal Filters.—The first experiments with coal as the filtering material were made by Mr. Joseph Garfield at Wolverhampton, England, in 1896. Several experimental coal filters have since been constructed in other places, notably at Litchfield. The efficiency of these filters is indicated by a reduction of the oxygen consumed of 78 per cent., and of albuminoid ammonia of 71.2 per cent. The filtration is intermittent with a run of twelve hours and a rest of the same length of time.

The depth of the filtering material should not be less than $1\frac{1}{2}$ meters. The first layer of the filter consists of $1\frac{1}{2}$ decimeters of coal about a centimeter in size. This layer is blinded with a little of $\frac{1}{2}$ centimeter cube coal. Above this comes a layer of about $7\frac{1}{2}$ decimeters of cubes 3 millimeters in size and on top another layer of about $7\frac{1}{2}$ decimeters of cubes $1\frac{1}{2}$ millimeters in size. The top course is a $1\frac{1}{2}$ decimeter layer of coal dust which has passed through a $1\frac{1}{2}$ millimeter mesh. The rate of filtration has been 1100 cubic meters per hectare per day (1,000,000 gallons), and it is believed that the

rate may be increased without materially lessening the efficiency.

These bacterial systems of sewage purification are important advances in the purification of sewage, though the fact that the pathogenic organisms appear to be uninfluenced, and the further fact that there remains from 15 to 20 per cent. of the organic matter unreduced, leave these systems open to objection. The effluent is not safely disposed of in running streams that serve as water-supplies without further chemical treatment or further purification by passing it through sand filters.

Sewage Purification—Conversion of Nitrogenous Matter.—The nitrogen of the organic matter may take one of two entirely different courses, depending on the fact whether the process proceeds under aërobic or anaërobic conditions.

In the slow sand filter and in the sprinkling filter, where there is a plentiful supply of oxygen, the conversion of the nitrogen is induced by aërobic bacteria. In the sand filter, as much as 99 per cent. of the organic nitrogen is converted in this manner, from the organic molecule to ammonia and then to nitrites and nitrates.

Phelps and Farrel¹ found that in contact filters about 25 per cent. of the organic nitrogen is converted into ammonia, nitrites, and nitrates, while the remainder is converted under anaërobic conditions, through the reducing action of the bacteria, into amines. In turn the amines react with the nitrites formed, and this results in the liberation of a large percentage of the nitrogen in the form of gas. As much as 50 per cent. of the total nitrogen may thus disappear.

The Committee of the American Public Health Association makes the following

“Summary Concerning Sewage Purification Plants now in Operation in America.”²—It appears that there are now in operation in America several hundred sewage

¹ *Jour. of Infect. Dis.*, Supplement No. 1.

² *Engineering Record*, November, 1900.

purification plants, ranging in size from those for cities of more than 100,000 inhabitants down to those for small institutions and summer hotels. With regard to the larger ones, the available information indicates that there are about seventy-five which treat the sewage of about 500 persons or more. Many of these plants were installed to reduce the pollution of public water-supplies, while a large number are operated with a view to obviating nuisances, such as would arise from putrefactive changes in the bodies of water into which the effluents are discharged.

“More or less information of a general nature concerning many of these plants is available through official reports and articles in professional and technical journals. Detailed specific information upon various points of importance, however, is for the most part confined to the larger plants in Massachusetts, which have been examined by the Board of Health of that State. Compilations of the leading published information available from the larger plants have been made by your chairman, supplemented somewhat by personal inspection and by correspondence. While as yet the amount of directly comparable data is too meager to warrant a detailed presentation, yet these comparisons bring clearly to light a number of points of general interest and of suggestive value.

“The point upon which our knowledge has been most advanced through data coming from sewage purification plants in actual practice seems to be the composition of sewage. For years it has been known that the composition of all sewages varies widely at different times, and that American sewages are much more dilute than those abroad. It is the amount of suspended organic and mineral matters in a sewage which usually gives the best index to its composition with reference to purification. The reasons for this are that suspended mineral matter becomes a sludge, which, after greater or less accumulation, requires removal by physical means at considerable expense; while the suspended organic matter is the chief factor of difficulty in processes for thorough purification,

from the standpoint of both cost and efficiency. There are at least twelve places in this country where such information has been obtained with sufficient frequency to yield results which may be used as approximate averages. As a matter of reference, these results, taken from the reports of the State Boards of Health of Massachusetts and Connecticut, are given in the following table, beyond which are corresponding results from European sewages:

Record of Average Suspended Matters in some American Sewages (Parts per Million).

| PLACE. | Years. | Total. | Mineral. | Organic. | |
|-----------------------------------|---------|--------|----------|----------|-----------|
| | | | | Parts. | Per cent. |
| Brockton, Mass. | 1897-98 | 120 | 23 | 97 | 81 |
| Chicago Exposition | 1893 | 182 | 29 | 153 | 84 |
| Framingham, Mass. | 1893-98 | 1364 | 154 | 1210 | 89 |
| Gardner, Mass. | 1893-98 | 134 | 31 | 103 | 77 |
| Lawrence, Mass. | 1888-89 | 240 | 102 | 138 | 57 |
| Leicester, Mass. | 1897-98 | 106 | 25 | 81 | 77 |
| Marlboro, Mass. | 1892-98 | 201 | 53 | 148 | 74 |
| Medfield, Mass. | 1894-98 | 107 | 26 | 81 | 76 |
| Meriden, Conn. | 1897-98 | 120 | 38 | 82 | 68 |
| Natick, Mass. | 1897-98 | 23 | 12 | 11 | 45 |
| Spencer, Mass. | 1898 | 95 | 13 | 82 | 87 |
| Worcester, Mass. | 1893-94 | 212 | 99 | 113 | 53 |
| Total average | | 140 | 50 | 192 | 79 |
| Total except Framingham | | 140 | 41 | 99 | 71 |

Record of Average Suspended Matters in some European Sewages (Parts per Million).

| PLACE. | Authority. | Total. | Mineral. | Organic. | |
|---|--------------------------------|--------|----------|----------|-----------|
| | | | | Parts. | Per cent. |
| Average of 16 English water-closet towns. { | River Pollution Com. } | 447 | 242 | 205 | 46 |
| London, 1894 | Dibden | 450 | | | |
| Sutton, 1899 | Rideal | 609 | | | |
| Leeds | City Document | 531 | | | |
| Accrington, 1899 | Naylor | 305 | 203 | 300 | 59 |
| Danzig | Koenig | 582 | 226 | 356 | 60 |
| Berlin | Koenig | 1085 | 383 | 782 | 65 |
| Breslau | Koenig | 405 | 205 | 200 | 49 |
| Halle | Koenig | 594 | 189 | 405 | 68 |
| Frankfort | Koenig | 1193 | 387 | 866 | 67 |
| Leicester, 1898-99 | City Document | 624 | | | |
| Salford, 1892 | Vogel | 512 | 144 | 368 | 72 |
| Cassel | Hoepner and Paulmann | 5460 | 1246 | 4214 | 78 |

“With regard to the fundamental principles which control the operation of plants in practice for the purification of sewage by irrigation or intermittent filtration, the most comprehensive statement which can now be made is to the effect that the available evidence, so far as it goes, testifies to the soundness of the laws which were formulated at the Lawrence Experiment Station. In fact, there are some indications that somewhat better results may be expected in practice than have been obtained from the experimental filters, other things being equal.

“For a high degree of purification of sewage entering small, short feeders to public water-supplies, there is no evidence to indicate that this can be accomplished in a better manner than by intermittent filtration. The cost of this treatment depends largely upon local conditions. Where ample areas of suitable land are readily available at a low cost, as in the case of many places in New England, first-class results can be obtained at the least cost by this method in its simplest form; but where suitable land is very scarce and expensive, or where filters would have to be built of selected material brought from a distance, the indications are that economy demands that the sewage receive a preliminary treatment, so as to allow of higher rates of filtration. Such a preliminary treatment relates, of course, to clarification of the crude sewage, or, in other words, to the removal of the suspended matters which exert such a troublesome clogging at the surface of the filters.

“Much study for many years has been given to the clarification of sewage as a preliminary step in its purification, and the problem is still an open question. During the past few years the so-called septic tank system has been much talked about in this connection. Although this procedure is being tried on a greater or less scale at ten or twelve different places in this country, comparatively little is now known in definite terms concerning its practicability under various known conditions

as to the sewage treated and details of devices employed, Opinion as to its merits is widely at variance. Some very erroneously appear to regard it as a complete purification process by itself, and a successful solution of the difficulty of final disposition of matters suspended in sewage. Others seem to question its practicability on the basis that there will be a large accumulation of sludge in the septic tank, involving much expense for its removal as well as nuisances due to bad odors. Whatever the future may show to be the true merits of the septic tank, it is certain that it can never afford a final disposition for the suspended mineral matter in the sewage. This is a point of much significance, as the mineral matters form from 20 to 40, and sometimes 50 per cent. of the solids in suspension.

“With regard to filtration of sewage at comparatively high rates, to secure moderate purification for cases in which the effluents are very indirectly or not at all connected with public water-supplies, there is very little evidence from actual operations in this country. In general terms it would appear that success in this important field will be associated to a considerable degree with the freedom from suspended matters in the sewage as it reaches such filters. It is felt that much more information is needed in this branch of the work before large plants can be built with confidence as to permanency and economy.”

Sprinkling Filters.—Sprinkling filters are the outcome of experiments with gravel filters at the Lawrence Experiment Station,¹ but the experiments of Mr. Joseph Corbett, borough engineer of Salford, England, have brought this method of sewage purification into prominence in England. The filters are constructed of five feet of crushed stone resting on six inches of gravel, that is, gravel underdrains. The crushed stone employed varies in size from 0.25 to 2 inches in diameter.

The sewage is applied intermittently to the surface of the filter in the form of a spray. This gives opportunity for the sewage to become aerated. Satisfactory results

¹ *Special Report Mass. State Board of Health, 1890, part 2, pp. 549 and 565.*

are obtained when the sewage contains about 80 per cent. of the amount of air required to saturate it. Sewage may be applied to filters of this character at the rate of 2,000,000 gallons per acre per day and obtain an effluent that is not putrescible. The effluent will contain only about 10 per cent. of the applied bacteria, and will show a reduction of the organic matter and its conversion into nitrates and nitrites through the agency of the nitrifying bacteria.

During 1904-05 Mr. George A. Johnson conducted extensive investigations upon the serviceability of different modern methods of sewage purification at Columbus, Ohio. The methods of purification tested in these investigations were: sedimentation, precipitation, septic tank, filtration through sand filters, contact filters, and sprinkling filters.

The process which is recommended to the city of Columbus as being the most satisfactory is that of the sprinkling filters, preceded by the preliminary clarification of the sewage in settling basins:

"1. Preliminary clarification of the sewage in basins holding on an average about an eight-hour flow and operated on the basis of the septic treatment.

"2. Purification of the septic effluent to a non-putrescible state by sprinkling filters at an average rate of 2,000,000 gallons per acre daily.

"3. Final clarification of the effluent of the sprinkling filters in basins holding an average flow of about two hours."

At the Sewage Experiment Station in Philadelphia the efficiency of the sprinkling filter in the purification of sewage was studied in detail. With filters exposed to the weather and receiving sewage "partially settled" the maximum rate obtained was 250,000,000 gallons per acre per day. With a filter protected from the weather a rate of three and one-tenth million gallons was used. The filters were constructed of trap-rock, one to three inches in size, in beds ranging from six to nine feet in depth. The bacterial efficiency of the sprinkling filters, when

operated at a rate between 2,500,000 and 3,000,000 gallons per acre per day, was 400,000 per c.c., representing a reduction of 86 per cent.

Since 1859 the city of Birmingham, England, has been studying in a practical way various methods of sewage purification, beginning with sedimentation, chemical precipitation, filtration, septic tank treatment, and finally purification by means of sprinkling filters. They have found that the latter method is far cheaper and more satisfactory than any other method heretofore employed, and they are now displacing all other methods for the sprinkling filters.

Removal of Sewage by Liernur System.—The satisfactory disposal of sewage is influenced directly by the fact whether the removal is by the separate or combined system. In the separate system of removal two sets of pipes are provided, one set for the household sewage, and another for the storm-water. This simplifies the purification process to a considerable extent. When the separate system of removal is employed some provision must be made for either flushing out the pipes carrying the household sewage, such as a flushing tank at the head of each branch sewer, or one of the methods of "air removal" may be employed. The method of air removal in more common use is what is known as the Liernur system. In this system there are two sets of pipes, the one set containing air only, and by the production of a partial vacuum in this set of pipes the sewage is extracted from the drain pipes. The system is so arranged that the discharges from each house are delivered into an air-tight metal reservoir, from which they are in turn drawn by suction into larger collecting tanks, these latter delivering the matter into a stream or into the disposal works. The main collecting tanks, receiving the sewage from the different branches, are at the lowest point of the district drained. A powerful suction pump produces a vacuum in the system, and once a day the entire system is exhausted. Each branch drain and

reservoir is extracted in turn by closing off the rest of the system by means of valves; and finally the main collecting tanks are extracted. The entire operation is the work of one man, who makes the tour of the system, his only labor being the opening and closing of valves. There is nothing to give offence to the senses in this system, as all the tanks are underground and the valves are operated from connections at the surface of the ground. Owing to the manner in which the material is collected, its conversion into fertilizer is commercially possible, so as to yield a considerable revenue. At Trouville, France, where the population during the season reaches 20,000, it is estimated that the receipts from the sale of the poudrette will furnish a material income over and above the operating expenses. This system of air extraction is especially adapted for places in which the sewers lie too low to discharge directly into streams.

The Liernur system of extraction has been in operation for more than twenty-five years in Amsterdam and Leyden, and its success in these older installations has led to its introduction into other cities. The latest application of the method has recently been completed at the watering-place Trouville, France.

Commercial Value of Sewage.—Many scientists have attempted, by chemical analysis, to demonstrate the commercial value of the constituents of sewage as fertilizer. One investigator has estimated the yearly solid and liquid excreta of an adult person to yield 7.44 kilograms, an amount sufficient to fertilize about 365 kilograms of wheat, rye, or oats, or about 410 kilograms of barley; equivalent to 34 kilograms of Peruvian guana. Several scientists have estimated the manurial value of London sewage to range from $3\frac{1}{3}$ to 5 cents per ton, having an annual value of 14,000,000 to 20,000,000 dollars. It does not matter, however, what the intrinsic value may be of the manurial constituents of sewage, the nitrogen, phosphoric acid, and potash salts, so long as the conditions affecting supply and demand can neither

be controlled nor regulated, its commercial value must remain very small—indeed, so small that sewage is much more likely to become a source of expense than one of revenue to any community. This has been the experience almost everywhere where attempts have been made to utilize sewage as fertilizer. The compressed sludge, the product of precipitation works, accumulates far more rapidly than it can be disposed of as fertilizer, and it frequently becomes a troublesome matter to dispose of it economically and satisfactorily. Even in such instances where sewage is utilized to irrigate cultivated fields it has at times been found detrimental to the crops raised, principally on account of the excessive quantities applied keeping the land constantly in a water-logged condition. This is said to have been the experience at Pullman, Ill.

✓

CHAPTER VI.
GARBAGE DISPOSAL.

THE whole subject of the disposal of garbage and other household waste must be considered from an economic as well as from a sanitary standpoint, if satisfactory results are to be obtained. The question of utilization has heretofore been one of secondary consideration. If the cost of disposal can be reduced by utilizing a part or the whole of the refuse, then, for financial reasons, such utilization should be advocated.

The sanitary question seems to narrow itself down mainly to the prevention of all nuisance, no evidence having been obtained to indicate a serious effect upon the health of those engaged in the disposal of this refuse or in picking it over before final disposal.

In the southern States the term "garbage" is sometimes applied to dry refuse (Atlanta, Ga.), and to a mixture of dry refuse with animal and vegetable waste. In New England the word "swill" is more commonly used to designate kitchen waste, etc., while in Pennsylvania and one or two other States "slop" is the name applied to this material. The garbage is usually collected two or three times a week, but somewhat more frequently in densely populated districts, and during the hot weather daily collections should be made in cities. Ashes and dry refuse are usually collected once a week throughout the year. The collection is made either by private service, by contract, or by department employes.

The best information obtainable from analyses of garbage made in Europe shows the presence of 60 to 80 per cent. of moisture; rubbish, such as bottles, cans, rags, etc., about 7 per cent.; animal and vegetable dry matter, about 20 per cent.; and grease, from 2 to 4 per cent. The ashes

from the cremation of garbage constitute about 5 per cent. of the original mass. Mr. Westinghouse, of New York, estimates that garbage is composed of about 20 per cent. of carbon and 80 per cent. of water.

Collection and Removal of Garbage.—Where the garbage is removed either by the municipal authorities directly or by contractors, it should be collected in water-tight receptacles supplied with lids, so as to prevent pollution of the air and soil at the point of collection. These receptacles should be emptied daily during the summer months, and every other day during the remainder of the year.

The carts or wagons employed in removing garbage should be constructed of metal, and so designed as to suit the special conditions. These carts should be supplied with lids, so that none of the material may be lost during removal, and also to limit the escape of objectionable odors during transit.

The following form of ordinance, recently transmitted to councils by the mayor of Philadelphia, is intended to reform the mode of handling garbage, the reforms being based upon the regulations in force in New York and Boston:

“Section 1. That it shall be unlawful for any person or persons to keep in his house or on his land any kitchen garbage or offal, unless the same is placed in water-tight vessels, free from ashes and other refuse matter (except food cans and food bottles).

“Section 2. No person shall place or keep in or near any building, ashes or cinders in such a manner as to cause fire, nor mix them with other substances, nor place or keep them except in metallic vessels so placed as to be easily removed.

“Section 3. All other refuse, such as paper, rags, excelsior, straw mattress, old clothing, pasteboard boxes, carpet, and other household waste, shall be kept in suitable vessels free from ashes and garbage, or in bundles, firmly fastened so as to prevent the rubbish from being

scattered in the handling, and protected from the weather until collected by the proper authority.

“Section 4. Ashes placed out for removal shall be moistened sufficiently to keep down dust while handling, and placed within 4 feet of the building-line, in vessels that will hold their contents without spilling; shall be placed out only on the day set for such removal, and taken in when emptied of their contents.”

Disposal of Garbage.—There are a number of methods of disposal in use. This is partly due to the varying character of the refuse in different cities, as regards moisture, ashes, unburnt coal, and animal and vegetable matter, and partly to special circumstances which favor one or the other method. The system of disposal of garbage by reduction is used in about twelve cities in the United States. Cremation systems, by which garbage is destroyed by fire, are in use in a large number of cities. Eight cities dispose of their garbage by dumping it on land. This form of disposal costs from 11 to 39 cents per capita per year. In those cities which dump their garbage into the sea or into rivers the cost is from 36 to 75 cents per capita. In cities where the garbage is fed to animals the cost of collection and disposal varies from 28 to 37 cents per capita, and this probably takes into account the revenue which the contractor derives from the sale of this material. In smaller cities the cost of disposal by feeding to animals is sometimes as low as 9 cents per capita. The cost of disposal by reduction processes varies from 15 to 67 cents per capita. The cost of disposal by cremation is found to vary from 6 to 10 cents per capita in medium-sized cities, and in one small city a cost of 20 cents per capita is given.

Several years ago, New York City made a contract with the New York Sanitary Utilization Company for the disposal of garbage, the price being about \$90,000 per annum. It contemplates the treating of the garbage of the entire city by steam, sterilizing it, and then, by

great pressure, separating the water and grease from the residue (called "tankage"), which is salable as fertilizer. Recently, Mr. Westinghouse made the suggestion that the garbage of New York be utilized in the manufacture of gas to be used for fuel purposes. He estimates that New York produces about 509,000 kilograms of garbage annually. Dr. Hutchinson estimates that 450 grams of this refuse have a maximum theoretical heating value of approximately 2000 calories, and that if all of this energy could be recovered in the form of gas it would require 3.85 kilograms of refuse per unit (kilowatt-hour) of electrical energy, and that "a consideration of the elementary principles involved shows a probable relation of 6.8 kilograms of refuse per unit (kilowatt-hour) in comparison with 11.3 kilograms, deduced from extensive tests with steam." These suggestions are of the greatest financial as well as sanitary importance, and seem to offer something which will not only favor the more systematic collection of garbage, but also its disposal to the financial advantage of the community.

Where the municipal authorities fail to provide the necessary system for the removal and disposal of garbage the novel method of disposing, introduced several years ago, may be adopted by the individual householder. This is domestic disposal in a special apparatus attached to the kitchen range. It consists of a perforated sheet-iron basket, with a tight bottom and a capacity of two to three liters. It is inserted into an expanded section of the stove-pipe, a short distance above the kitchen range, and allows the hot air and smoke to pass on all sides of the basket. It is easily withdrawn from its position and replaced with one hand. The garbage is placed into the basket as fast as it accumulates, and the contents are removed once a day. It dries to charcoal without burning, and becomes an excellent fuel for kindling the fire in the morning. It does not impair the use of the stove, nor interfere with the draught, causes no odors, and does not require any extra fuel.

For hotels, hospitals, or other public institutions something of greater capacity must be provided for the disposal of the garbage. To meet this demand a portable furnace has been devised, occupying about one-third of a square meter of space, with an independent chimney connection, which will destroy the waste in quantities of nearly a barrel at once. This apparatus has a garbage receptacle or retort of cast iron, cylindrical in form, with a cast-iron grate at the bottom. This retort is suspended 30 to 40 centimeters above the fire pot in the furnace, and the whole is encased in a jacket of heavy sheet iron. In operating, the retort is filled with garbage introduced through the charging door, a moderate fire is started, and the process of cremation begins. A simple arrangement of air jets, automatically actuated by the natural draught of the chimney, exhausts all the smoke and odors of the burning garbage from the retort and carries them down and through the furnace fire, so that nothing but the thoroughly purified and odorless gases, liberated by combustion, can escape into the chimney flue. Such an apparatus requires a comparatively small amount of fuel.

CHAPTER VII.

FOOD AND DIETING.

NOT only the health and strength of the body, but the intellectual and moral character as well, are dependent upon the nature and quantity of the food-supply. For this reason the question of food and diet is most complex, and the sanitary phase of it is not the most important one. It is, however, of sufficient importance to demand consideration in connection with general hygienic conditions, because of its relation to the welfare of man in general, and because of the dangers that arise from improper food materials, and also because of the influence upon health of excessive, as well as deficient, amounts of food.

The late Dr. Atwater defined food as follows: "Food is that which, when taken into the body, builds up its tissues and keeps them in repair, or which is consumed in the body to yield energy in the form of heat to keep it warm and create strength for its work."

Chemical Composition of the Body.—In order to understand the needs of the body in the shape of food to maintain its form and character, it will be necessary to consider briefly its chemical constituents. These are both organic and inorganic in their nature, composed of the following elements combined into a number of compounds: Hydrogen, oxygen, nitrogen, carbon, chlorine, fluorine, sulphur, silicon, phosphorus, potassium, sodium, lithium, calcium, magnesium, and iron.

The inorganic constituents of the body are water, which comprises about two-thirds of its weight; different gases, such as oxygen, hydrogen, nitrogen, carbon dioxide, ammonia, hydrogen sulphide, and marsh gas;

salts, such as sodium chlorid, calcium phosphate (which forms more than one-half the substance of the bones), calcium carbonate and fluorid, sodium and potassium sulphate, potassium and ammonium chlorid, sodium, potassium, and magnesium phosphate, and sodium carbonate and bicarbonate; hydrochloric acid; silica; and iron.

The organic constituents may be divided into the nitrogenous and non-nitrogenous bodies, of which the nitrogenous are the most numerous. They consist of the albuminous bodies, or proteids; the albuminoid substances; certain complex bodies, such as the ferments, and coloring-matters, the ammonia derivatives. The non-nitrogenous bodies consist of two groups, fats and carbohydrates.

All of these various elements and chemical combinations, constituting the composition of the body, must be supplied in the food-supply in order that it may perform its normal functions and obtain energy for all of man's activities in life. Under normal physiologic conditions the amount of material absorbed from the food is about equal to that which is thrown off by the excretory organs. During the period of growth the amount absorbed exceeds the amount excreted, while in most acute diseases the amount excreted is far in excess of the amount absorbed, and, consequently, the body wastes. The body increases or diminishes in weight proportionately as the amount of material absorbed from the food is greater or less than the amount excreted. A man of average weight and activity takes about 325 grams of dry solid matter and from 1500 to 2000 grams of water, while about 550 grams of oxygen are absorbed by the lungs per day. Of the solids taken, about 40 grams are eliminated by the intestines, and the remaining 285 grams by the other excretory organs. The oxygen taken in is also excreted by these organs, after having been utilized; the latent or potential energy of the food being converted into kinetic energy. The body loses in

this way about one-twentieth of its weight daily, and this loss must be made up from the food ingested.

By latent or potential energy is meant the energy capable of performing work when called upon; such, for example, as resides in a suspended weight. By kinetic energy is meant energy which is doing work; such as the force exerted by the weight in falling to the ground. Heidenhain calculated that four-fifths of the total energy of the body takes the form of heat. It may be stated, therefore, that the body is a machine for converting potential energy into kinetic energy. The potential energy is supplied by the food, and the metabolism of the body converts this into the kinetic energy of heat and mechanical power.

Potential Energy in Food.—The potential energy contained in any substance is determined by ascertaining the amount of heat that is produced by its complete combustion. The potential energy contained in any substance is expressed in calories. By a calorie is meant the amount of heat required to warm 1 gram of water 1 degree centigrade. The amount of heat given off by the human adult body per day is equal to the heat required to warm 2,500,000 grams, or 2500 kilograms, of water 1 degree centigrade, and this amount of heat is generated by the body each day from the food ingested. According to König, the more common food-stuffs have values as fuel as follows:

| | | |
|--|------|-----------|
| 1 gram of dry meat yields | 5103 | calories. |
| 1 gram of albumin yields | 4998 | " |
| 1 gram of sugar yields | 3227 | " |
| 1 gram of starch (arrowroot) yields | 3912 | " |
| 1 gram of butter yields | 7264 | " |
| 1 gram of suet yields | 9096 | " |
| 1 gram of vegetable fibrin yields | 6231 | " |
| 1 gram of casein (milk) yields | 5785 | " |
| 1 gram of fibrin (blood) yields | 5709 | " |
| 1 gram of peptone (Schuhardt) yields | 5334 | " |
| 1 gram of gluten yields | 5943 | " |
| 1 gram of chondrin yields | 4909 | " |
| 1 gram of urea yields | 2537 | " |

| | | |
|--|------|-----------|
| 1 gram of Liebig's meat-extract yields | 3206 | calories. |
| 1 gram of fat (extracted with cold ether) yields | 9686 | " |
| 1 gram of fresh rye bread yields | 2727 | " |
| 1 gram of dry rye bread yields | 4421 | " |
| 1 gram of fresh wheat bread yields | 2807 | " |
| 1 gram of dry wheat bread yields | 4302 | " |

When we compare the nutrients in respect to their fuel values with their capacities for yielding heat and mechanical power, a gram of lean meat or albumin of egg is just about equivalent to 1 gram of sugar or starch, and a little over 2 grams of either would be required to equal 1 gram of fat meat or butter. These are called isodynamic values. Compared with each other, 100 grams of animal albumin are isodynamic with 52 grams of fat, 114 grams of starch, or 129 grams of dextrose; 100 grams of fat are isodynamic with 243 grams of dry flesh or 225 grams of dry syntonin.

The food is utilized in the body for the following different purposes: To form the tissues and fluids of the body; to repair the waste in the tissues; it is stored up in the body for future consumption; it is consumed as fuel, its potential energy being transformed into heat, muscular or other forms of energy; or, in being consumed, it protects the tissues or other food from consumption.

The proteid nutrients form tissue, and also serve as fuel; the fats form fatty tissue, and also serve as fuel; the carbohydrates are transformed into fat and serve as fuel.

The mechanical energy obtainable from various articles of food is dependent upon the amount of potential energy stored up in the food, which is expressed in terms of calories, and the extent to which the processes of the body can liberate and apply this energy. For instance, a gram of albumin gives rise to a certain amount of heat when burned in oxygen; but in the body thorough oxidation does not take place, because some of the constituents of the albumin are given off incompletely oxidized in the form of urea. A gram of sugar, on the other hand, is generally completely oxidized, being con-

verted into carbon dioxid and water, and its actual energy in the body is equal to its theoretical energy. The mechanical energy obtainable from the transformation of albumin is arrived at by multiplying the number of grams of its several constituents by a number, determined by exact experiment, representing the amount of heat produced by the oxidation of 1 gram of carbohydrate, fat, or proteid to water, carbon dioxid, and urea.

According to Rubner, the average calorific value of proteid matter is 4124 calories—that is, 1 gram of proteid oxidized to urea yields 4124 gram-degrees (or 4.1 kilogram-degrees) of heat; 1 gram of fat yields 9321 calories (9.3 kilogram-degrees); and 1 gram of carbohydrate (starch) yields 4116 calories (4.1 kilogram-degrees). Applying these numbers to Voit's diet for a man of 70 kilos doing hard muscular work, we obtain in round numbers:

| | | | |
|----------------------------------|---------|------|-------------------|
| 105 grams of assimilated proteid | × 4.1 = | 430 | kilogram-degrees. |
| 56 grams of fat | × 9.3 = | 520 | “ |
| 500 grams of carbohydrate | × 4.1 = | 2050 | “ |
| | | 3000 | kilogram-degrees, |

or 3,000,000 calories, as the potential energy of the food. This amount may be taken as the average required for a man. For women the amount is somewhat less than this, both absolutely and relatively. For children, though absolutely less, it is relatively greater.

Energy Derivable from Food.—In order to calculate how much mechanical work can be performed by, or is equal to, the potential energy expressed in calories, we must know the relation between heat and motion. According to Landois, the energy required to heat 1 gram of water 1 degree centigrade would raise a weight of 425.5 grams to a height of 1 meter; or 425.5 grams of water falling through 1 meter would raise the temperature of 1 gram of water 1 degree centigrade. The mechanical equivalent of the calorie is obtained by multiplying the calories by 425.5, and is expressed as a gram-meter. If we multiply the calorific value of the

alimentary principles by 425.5, we obtain the mechanical energy of 1 gram of each, as follows:

| | | |
|-------------------------|----------------|-------------------|
| Proteids | 4124 × 425.5 = | 1754 meter-kilos. |
| Fats | 9321 × 425.5 = | 3966 " |
| Carbohydrates | 4116 × 425.5 = | 1751 " |

In order to ascertain the mechanical energy contained in any diet we multiply the number of grams of each alimentary principle by the figures representing the mechanical energy of each. Taking the standard diet of Moleschott for a man performing moderate work we obtain the following results:

| | | |
|-------------------------|--------------|------------------------|
| Proteids | 145 × 1754 = | 254,330 |
| Fats | 45 × 3966 = | 193,470 |
| Carbohydrates | 605 × 1751 = | <u>1,059,355</u> |
| | | 1,507,155 meter-kilos. |

According to Hueppe, the loss of heat from the body during work is as follows:

| | |
|---|-----------------------|
| Loss through radiation and conduction | 1789 calories. |
| Loss through evaporation from the skin | 384 " |
| Loss through evaporation from the lungs | 192 " |
| Total | <u>2365</u> calories. |
| Loss of heat during rest | 1500 " |
| Excess during work | 865 calories. |

He gives the following dietaries from which he estimates the amount of energy available for mechanical work:

| Per 70 kilograms of body-weight. | Albumin. | Fat. | Carbohydrates. | Total calories per 70 kilograms of body-weight. | Calories per 1 kilogram of body-weight. |
|---|---|--|---|---|---|
| <p>A. Complete rest. According to Hueppe.</p> <p>{ The food contains— Having gross calories Having pure calories.</p> | <p>65 grams. (65 × 4.1) = 266.5 (65 × 3.4) = 221</p> | <p>30 grams. (30 × 9.3) = 279 (30 × 8.3) = 249</p> | <p>300 grams. (300 × 4.1) = 1230 (300 × 3.8) = 1140</p> | <p>1775.5 1610.0</p> | <p>25.364 23.000</p> |
| <p>B. Medium work (mason, soldier in garrison). 1. According to Voit.</p> <p>{ The food contains— Having gross calories Having pure calories.</p> | <p>118 grams. (118 × 4.1) = 483.8 (118 × 3.4) = 401.2</p> | <p>56 grams. (56 × 9.3) = 520.8 (56 × 8.3) = 464.8</p> | <p>500 grams. (500 × 4.1) = 2050 (500 × 3.8) = 1900</p> | <p>3054.6 2766.0</p> | <p>43.637 39.514</p> |
| <p>2. According to Hirschfeld.</p> <p>{ The food contains— Having gross calories Having pure calories.</p> | <p>100 grams. (100 × 4.1) = 410 (100 × 3.4) = 340</p> | <p>110 grams. (110 × 9.3) = 1023 (110 × 8.3) = 913</p> | <p>400 grams. (400 × 4.1) = 1640 (400 × 3.8) = 1520</p> | <p>3073.0 2773.0</p> | <p>43.900 41.700</p> |
| <p>C. Japanese, usual work, and vegetable diet. According to Scheube.</p> <p>{ The food contains— Having gross calories Having pure calories.</p> | <p>126 grams. (126 × 4.1) = 516.6 (126 × 3.4) = 378.0</p> | <p>16 grams. (16 × 9.3) = 148.8 (16 × 8.3) = 136.0</p> | <p>633 grams. (633 × 4.1) = 2595.3 (633 × 3.8) = 2405.4</p> | <p>3260.7 2919.4</p> | <p>46.581 41.700</p> |
| <p>D. German laborer at hard work (smith, soldier in the field). According to Voit.</p> <p>{ The food contains— Having gross calories Having pure calories.</p> | <p>145 grams. (145 × 4.1) = 594.5 (145 × 3.4) = 493.0</p> | <p>67 grams. (67 × 9.3) = 623.1 (67 × 8.3) = 556.1</p> | <p>500 grams. (500 × 4.1) = 2050 (500 × 3.8) = 1900</p> | <p>3267.6 2949.1</p> | <p>46.680 42.130</p> |

The available energy for mechanical work in the above diets (the mechanical equivalent = 425), after deducting the excess of heat lost during work, is as follows :

| | |
|--------------------|---|
| B ₁ . . | 1266 - 865 = 401 calories × 425 = 170,425 kgm. = 14.5 per cent. |
| B ₂ . . | 1273 - 865 = 408 calories × 425 = 173,400 kgm. = 15.0 " |
| C . . | 1419 - 865 = 554 calories × 425 = 235,450 kgm. = 19.0 " |
| D . . | 1449 - 865 = 584 calories × 425 = 248,200 kgm. = 20.0 " |

The maximum day's work of eight hours, tested on the ergograph, ranges from 200,000 to 250,000 meter-kilos.

The mechanical energy present in an ordinary diet may, therefore, be estimated at 1,250,000 meter-kilos. The work and heat of the body use up the following amounts, according to De Chaumont :

| | |
|---------------------------------------|-------------------------------|
| Work of circulation | 75,000 meter-kilos. |
| Work of respiration | 12,000 " |
| Calorific work | 781,000 " |
| External work (93,000 kgm.) | 465,000 " |
| | <u>1,333,000 meter-kilos.</u> |

This total is in excess of the total energy contained in the standard diet, but this is unavoidable, according to Davies, "in calculations of such an approximate nature as the present one ; the important point as regards dieting is the proportion that should exist between the different objects for which the total energy is supplied."

The following may be taken as an approximate basis for the calculation of diets according to size and work :

| Proximate. | For subsistence. | For work of 93,000 meter-kilos per diem. | For work of 100,000 meter-kilos per diem. |
|-------------------------|------------------------------------|--|---|
| Aliment. | Grams per kilogram of body-weight. | Grams per kilogram of body-weight. | Grams per kilogram of body-weight. |
| Proteids | 1.044 | 1.903 | 2.06 |
| Fats | 0.412 | 1.132 | 1.32 |
| Carbohydrates | 5.000 | 5.937 | 6.38 |
| Salts | 0.163 | 0.380 | 0.47 |
| Total | 6.619 | 9.352 | 10.23 |

Dietary Standards (Atwater).

| European standards for daily dietaries. | | Nutrients. | | | Fuel value. | Nutri- tive ra- tio. |
|---|-------------------------------------|------------|--------|---------------------|-------------|----------------------------|
| | | Protein. | Fats. | Carbohy- drates. | | |
| | | Grams. | Grams. | Grams. | Calories. | |
| 1 | Children, one to two years, average | 30.0 | 40.0 | 85.0 | 765 | 1 : 5.7 |
| 2 | Children, two to six " " | 60.0 | 45.0 | 220.0 | 1420 | 1 : 5.3 |
| 3 | Children, six to fifteen " " | 85.0 | 50.0 | 360.0 | 2040 | 1 : 5.6 |
| 4 | Aged woman | 90.0 | 55.0 | 285.0 | 1860 | 1 : 4.7 |
| 5 | Aged man | 110.0 | 75.0 | 385.0 | 2475 | 1 : 5.0 |
| 6 | Woman at moderate work | 100.0 | 50.0 | 440.0 | 2425 | 1 : 5.4 |
| 7 | Man " " (Voit) | 130.0 | 60.0 | 550.0 | 3055 | 1 : 5.3 |
| 8 | Man " hard " (Voit) | 160.0 | 110.0 | 495.0 | 3370 | 1 : 4.7 |
| 9 | Man " moderate " (Moleschott) | 145.0 | 45.0 | 605.0 | 3160 | 1 : 4.9 |
| 10 | Man " " (Wolff) | 140.0 | 40.0 | 595.0 | 3030 | 1 : 4.9 |
| 11 | Subsistence diet (Playfair) | 65.0 | 15.0 | 375.0 | 1760 | 1 : 6.5 |
| 12 | Diet in quietude (Playfair) | 80.0 | 30.0 | 375.0 | 1950 | 1 : 5.7 |
| 13 | Adults in full health (Playfair) | 130.0 | 55.0 | 185.0 | 3140 | 1 : 5.4 |
| 14 | Active laborers (Playfair) | 170.0 | 80.0 | 625.0 | 3630 | 1 : 4.7 |
| 15 | Hard-worked laborers (Playfair) | 205.0 | 80.0 | 625.0 | 3750 | 1 : 3.9 |
| American Standards. | | | | | | |
| 1 | Woman with light muscular exercise | 90 | | | 2400 | 1 : 5.5 |
| 2 | Woman with moderate " exercise | 100 | | | 2700 | 1 : 5.6 |
| 3 | Man without muscular work | 112 | | | 3000 | 1 : 5.5 |
| 4 | Man with light " " | | | | | |
| 5 | Man with moderate muscular work | 125 | | | 3500 | 1 : 5.8 |
| 6 | Man with hard " " | 150 | | | 4500 | 1 : 6.3 |

The figures of the foregoing tables represent the amounts of nutrients which different investigators have estimated to be proper for the daily food of different classes. The minimum standard of daily diet, approximately calculated, may be given as follows:¹

Minimum Standard of Daily Diet.

| | Albumin. | Fat. | Carbohy- drates. |
|---|----------|--------|---------------------|
| | Grams. | Grams. | Grams. |
| Child up to one and one-half years of age . . | 20-36 | 30-45 | 60-90 |
| Child from six to fifteen years | 70-80 | 37-50 | 250-400 |
| Man, at moderate labor | 118 | 56 | 500 |
| Woman, at moderate labor | 92 | 44 | 400 |
| Man, at severe labor | 120-145 | 100 | 500 |
| Man of advanced age | 100 | 68 | 350 |
| Woman of advanced age | 80 | 20 | 260 |

According to Hueppe, the following reductions must be made because all of the nutritive materials in the food ingested are not absorbed: In general 1.5 per cent. of the

¹ *Gesundheitsbüchlein*, Berlin, 1896, Imperial Board of Health.

albumin is not absorbed. Of the fat of pork, only 98 per cent. is absorbed; of beef, 90 per cent. Mixed with meat the digestibility of animal fats averages 83 per cent. Beef, with a content of 20.91 per cent. of nitrogenous matter and 5.19 per cent. of ether extract, has a gross value as follows: $100 \text{ gm.} = 20.91 \times 4124 + 5.19 \times 9321 = 86.232 + 48.376 = 134$ calories. If we assume that the digestibility of the albumin is 97.5 per cent., and that of the fat 83 per cent., then the true value is as follows: $100 \text{ gm.} = 86.232 \times 0.975 + 48.376 \times 0.83 = 84.076 + 40.152 = 124$ calories.

This calculation holds true for meat free from bones, but in the calculation of a general dietary a reduction of 15 per cent. must be made for bones. One hundred grams of commercial meat with 15 per cent. of bones contain 17.78 per cent. of nitrogenous matter and 4.41 per cent. of ether extract; and calculated as above, possess a true value of 105 calories.

According to von Reckenberg, the digestibility of meat per 100 grams of substance is as follows :

| | Nitrogenous substance. (Albumin.) | | Ether extract. (Fat.) | | Physiologic energy. without with reference to dig- estibility. | | |
|---|---|-------------------------|--------------------------|-------------------------|---|-----------------------------|-----|
| | Con- tent. gm. | Digesti- ble. gm. | Con- tent. gm. | Digesti- ble. gm. | Gross value. Calories. | True value. Calories. | |
| Beef . | Medium fat, without bones | 20.91 | 20.39 | 5.19 | 4.31 | 132 ¹ | 122 |
| | Medium fat, with 15 per cent. of bones | 17.78 | 17.33 | 4.41 | 3.66 | 112 | 104 |
| Pork . | Fat, without bones . | 14.54 | 14.18 | 37.34 | 30.99 | 409 | 348 |
| | Fat, with 10 per cent. of bones . . | 13.09 | 12.76 | 33.61 | 27.89 | 368 | 313 |
| A herring, 135 gm., 37 per cent. waste | 16.07 | 15.67 | 14.36 | 11.92 | 199 | 174 | |
| Fat, smoked | 2.6 | 2.54 | 77.80 | 64.57 | 742 | 617 | |
| Lard, rendered | 0.26 | 0.25 | 99.04 | 94.04 | 934 | 887 | |

The digestibility of the nitrogenous substance can be assumed to be the same for all kinds of meat. One gram

¹ In these calculations albumin is represented at 4003, and fat at 9320 calories.

of ether extract represents 9415 calories in pork, the bone refuse being reckoned as 10 per cent. Rendered swine and beef fat, as well as the fat of fish and geese, may be calculated as in the case of pork fat, while the fat of other animals must be calculated as in the case of beef. In smoked fat 1 gram of ether extract represents 9400 calories, because the ether extract does not contain pure fat.

Nutritive Value and Cost of Food.—The following tables are based on the tables in the Appendix of "Foods: Nutritive Value and Cost," by Prof. Atwater, *Farmer's Bulletin* No. 23, issued by the U. S. Department of Agriculture. In each of the tables the fuel value has been expressed in calories of the metric system instead of the amounts contained in the tables. The weight of the food materials has been expressed in grams instead of in ounces and pounds. "Table B gives the proportions of ingredients in a number of materials as found by analysis of specimens collected for the most part in New York and New England markets."

TABLE A.—Amounts of Nutrients furnished for 25 cents in Food Materials at Ordinary Prices.

| Food materials as purchased. | Prices per $\frac{1}{2}$ kg. (1 lb.) | Twenty-five cents will pay for— | | | | Fuel value. | |
|---|--------------------------------------|---------------------------------|------------|----------|--------|-------------|----------------|
| | | Total food materials. | Nutrients. | | | | |
| | | | Total. | Protein. | Fats. | | Carbo-hydrat's |
| | | Grams. | Grams. | Grams. | Grams. | Calories. | |
| Beef, sirloin | 25 | 500 | 155.0 | 75.0 | 80.0 | 970 | |
| Beef, round | 16 | 780 | 235.0 | 140.0 | 95.0 | 1335 | |
| Beef, neck | 8 | 1565 | 465.0 | 245.0 | 220.0 | 2755 | |
| Mutton, leg | 20 | 625 | 190.0 | 95.0 | 95.0 | 1170 | |
| Ham, smoked | 16 | 780 | 385.0 | 115.0 | 270.0 | 2705 | |
| Salt pork | 10 | 1250 | 1045.0 | 10.0 | 1035.0 | 2775 | |
| Codfish, fresh | 10 | 1250 | 135.0 | .. | .. | 510 | |
| Codfish, dried salt | 8 | 1565 | 255.0 | 250.0 | 5.0 | 985 | |
| Mackerel, salt | 10 | 1250 | 370.0 | 185.0 | 185.0 | 2275 | |
| Oysters, 25 cents per quart | 12.5 | 1000 | 120.0 | 65.0 | 15.0 | 520 | |
| Eggs, 8 cents per dozen | 14.7 | 850 | 190.0 | 105.0 | 85.0 | 1115 | |
| Milk, 8 cents per quart | 4 | 2125 | 385.0 | 115.0 | 125.0 | 2020 | |
| Cheese, whole milk | 15 | 835 | 545.0 | 235.0 | 225.0 | 3455 | |
| Cheese, skimmed milk | 10 | 1250 | 675.0 | 480.0 | 85.0 | 2910 | |
| Butter, 25 cents per pound | 25 | 500 | 430.0 | 5.0 | 425.0 | 3615 | |
| Sugar, 5 cents per pound | 5 | 2500 | 2445.0 | .. | 2445.0 | 9100 | |
| Wheat flour | 2.5 | 5000 | 4350.0 | 550.0 | 3745.0 | 16,450 | |
| Wheat bread | 5 | 2500 | 1670.0 | 220.0 | 40.0 | 6400 | |
| Oatmeal | 5 | 2500 | 2260.0 | 370.0 | 180.0 | 6225 | |
| Beans | 5 | 2500 | 2110.0 | 580.0 | 50.0 | 8075 | |
| Potatoes, 60 cents per bushel | 1 | 12,500 | 2135.0 | 225.0 | 10.0 | 8000 | |

TABLE B.—Composition of Different Food Materials.

| FOOD MATERIALS. | Refuse (bones, skin, shell, etc.). | Edible portion | | | | | | Fuel value of 500 grams. |
|--------------------------------------|------------------------------------|----------------|------------|----------|------|----------------|--------------------|--------------------------|
| | | Water. | Nutrients. | | | | | |
| | | | Total. | Protein. | Fat. | Carbohydrates. | Mineral mat- ters. | |
| <i>Animal foods as purchased.</i> | | | | | | | | |
| Beef: | - | - | - | - | - | - | - | Cal. |
| Neck | 20 | 49.6 | 30.4 | 15.6 | 14 | . . . | .8 | 880 |
| Shoulder | 12.6 | 55.8 | 31.6 | 17 | 13.7 | . . . | .8 | 895 |
| Chuck rib | 14.6 | 49.5 | 35.9 | 15 | 20.1 | . . . | .8 | 1125 |
| Rib | 21 | 38.2 | 40.8 | 12.2 | 27.9 | . . . | .7 | 1405 |
| Sirloin | 19.5 | 48.3 | 32.2 | 15 | 16.4 | . . . | .8 | 970 |
| Round steak | 7.8 | 60.9 | 31.3 | 18 | 12.3 | . . . | 1 | 855 |
| Side, without kidney fat | 19.2 | 44.3 | 36.5 | 13.9 | 21.8 | . . . | .8 | 1180 |
| Rump, corned | 5 | 70.8 | 24.2 | 16.7 | 5.1 | . . . | 2.4 | 525 |
| Flank, corned | 12.1 | 43.7 | 44.2 | 12.4 | 29.2 | . . . | 2.6 | 1460 |
| Veal, shoulder | 17.9 | 56.7 | 25.4 | 16.6 | 7.9 | . . . | .9 | 640 |
| Mutton: | | | | | | | | |
| Shoulder | 16.3 | 49 | 34.7 | 15.1 | 18.8 | . . . | .8 | 1075 |
| Leg | 18.1 | 50.6 | 31.3 | 15 | 15.6 | . . . | .7 | 935 |
| Loin | 15.8 | 41.5 | 42.7 | 12.6 | 29.5 | . . . | .6 | 1480 |
| Side, without kidney fat | 17.3 | 44.2 | 38.5 | 14 | 23.7 | . . . | .8 | 1260 |
| Pork: | | | | | | | | |
| Shoulder roast, fresh | 14.6 | 43 | 42.4 | 13.6 | 28 | . . . | .8 | 1435 |
| Ham, salted, smoked | 11.4 | 36.8 | 51.8 | 14.8 | 34.6 | . . . | 2.4 | 1735 |
| Chicken | | 38.2 | 44.6 | 17.2 | 15.1 | . . . | .9 | 330 |
| Turkey | | 32.4 | 44.7 | 22.9 | 16.1 | . . . | .9 | 550 |
| Eggs, in shell | | 13.7 | 63.1 | 23.2 | 12.1 | . . . | .9 | 655 |
| Fish, etc.: | | | | | | | | |
| Flounder, whole | 66.8 | 27.2 | 6 | 5.2 | .3 | . . . | .5 | 110 |
| Bluefish, dressed | 48.6 | 43 | 11.1 | 9.8 | .6 | . . . | .7 | 210 |
| Codfish, dressed | 29.9 | 58.5 | 11.6 | 10.6 | .2 | . . . | .8 | 205 |
| Shad, whole | 50.1 | 35.2 | 14.7 | 9.2 | 4.8 | . . . | .7 | 375 |
| Mackerel, whole | 44.8 | 40.4 | 15 | 10 | 4.3 | . . . | .7 | 365 |
| Halibut, dressed | 17.7 | 61.9 | 20.4 | 15.1 | 4.4 | . . . | .9 | 465 |
| Salmon, whole | 35.3 | 40.6 | 24.1 | 14.3 | 8.8 | . . . | 1 | 635 |
| Salted codfish | 42.1 | 40.5 | 17.6 | 16 | .4 | . . . | 1.2 | 315 |
| Smoked herring | 50.9 | 19.2 | 29.9 | 20.2 | 8.8 | . . . | .9 | 745 |
| Salted mackerel | 40.4 | 28.1 | 31.5 | 14.7 | 15.1 | . . . | 1.7 | 910 |
| Canned salmon | 4.9 | 59.3 | 35.8 | 19.3 | 15.3 | . . . | 1.2 | 1005 |
| Lobsters | 62.1 | 31 | 6.9 | 5.5 | .7 | . . . | .6 | 135 |
| Oysters | 82.3 | 15.4 | 2.3 | 1.1 | .2 | . . . | .4 | 40 |
| <i>Animal foods, edible portion.</i> | | | | | | | | |
| Beef: | | | | | | | | |
| Neck | | 62 | 38 | 19.5 | 17.5 | . . . | 1 | 1100 |
| Shoulder | | 63.9 | 36.1 | 19.5 | 15.6 | . . . | 1 | 1020 |
| Chuck rib | | 58 | 42 | 17.6 | 23.5 | . . . | .9 | 1320 |
| Rib | | 48.1 | 51.9 | 15.4 | 35.6 | . . . | .9 | 1790 |
| Sirloin | | 60 | 40 | 18.5 | 20.5 | . . . | 1 | 1210 |
| Round | | 68.2 | 31.8 | 20.5 | 10.1 | . . . | 1.2 | 805 |
| Side, without kidney fat | | 54.8 | 45.2 | 17.2 | 27.1 | . . . | .9 | 1465 |
| Rump, corned | | 58.1 | 41.9 | 13.3 | 26.6 | . . . | 2 | 1370 |
| Flank, corned | | 49.8 | 50.2 | 14.2 | 33 | . . . | 3 | 1655 |
| Veal, shoulder | | 68.8 | 31.2 | 20.2 | 9.8 | . . . | 1.2 | 790 |
| Mutton: | | | | | | | | |
| Shoulder | | 58.6 | 41.4 | 18.1 | 22.4 | . . . | .9 | 1280 |
| Leg | | 61.8 | 38.2 | 18.3 | 19 | . . . | .9 | 1140 |
| Loin | | 49.3 | 50.7 | 15 | 35 | . . . | .7 | 1755 |
| Side, without kidney fat | | 53.5 | 46.5 | 16.9 | 28.7 | . . . | .9 | 1525 |
| Pork: | | | | | | | | |
| Shoulder roast, fresh | | 50.3 | 49.7 | 16 | 32.8 | . . . | .9 | 1680 |
| Ham, salted, smoked | | 41.5 | 58.5 | 16.7 | 39.1 | . . . | 2.7 | 1960 |
| Fat, salted | | 12.1 | 87.9 | .9 | 82.8 | . . . | 4.2 | 3510 |
| Sausage: | | | | | | | | |
| Pork | | 41.5 | 58.8 | 13.8 | 42.8 | . . . | 2.3 | 2065 |
| Bologna | | 62.4 | 37.6 | 18.8 | 15.8 | . . . | .3 | 1015 |
| Chicken | | 72.2 | 27.8 | 24.4 | 2 | . . . | 1.4 | 540 |

TABLE B (continued).

| FOOD MATERIALS. | Refuse (bones, skin, shell, etc.). | Edible portion. | | | | | Fuel value of 500 grams. |
|--------------------------------|------------------------------------|-----------------|------------|-----------|------|----------------|--------------------------|
| | | Water. | Nutrients. | | | | |
| | | | Total. | Protein. | Fat. | Carbohydrates. | |
| Turkey | 66.2 | 33.8 | 23.9 | 8.7 | 1.2 | 810 | |
| Eggs | 73.8 | 26.2 | 14.9 | 10.5 | .8 | 721 | |
| Milk | 87 | 13 | 3.6 | 4 | 4.7 | 325 | |
| Butter | 10.5 | 89 | 1 | 85 | .5 | 3615 | |
| Oleomargarin | 11 | 89.5 | .6 | 85 | .4 | 3605 | |
| Cheese: | | | | | | | |
| Full cream | 30.2 | 69.8 | 28.3 | 35.5 | 1.8 | 2070 | |
| Skimmed milk | 41.3 | 58.7 | 38.4 | 6.8 | 8.9 | 1165 | |
| Fish: | | | | | | | |
| Flounder | 84.2 | 15.8 | 13.8 | 7 | 1.3 | 285 | |
| Haddock | 81.7 | 18.3 | 16.8 | .3 | 1.2 | 325 | |
| Codfish | 82.6 | 17.4 | 15.8 | .4 | 1.2 | 310 | |
| Shad | 70.6 | 29.4 | 18.6 | 9.5 | 1.3 | 745 | |
| Mackerel | 73.4 | 26.6 | 18.2 | 7.1 | 1.3 | 640 | |
| Halibut | 75.4 | 24.6 | 18.3 | 5.2 | 1.1 | 560 | |
| Salmon | 63.6 | 36.4 | 21.6 | 3 | 1.4 | 665 | |
| Salted cod | 53.6 | 46.4 | 21.4 | 3 | 1.6 | 410 | |
| Herring, salted | 34.6 | 65.4 | 36.4 | 15.8 | 1.5 | 1345 | |
| Mackerel, salted | 43.4 | 56.6 | 17.3 | 26.4 | 2.6 | 1660 | |
| Oysters | 87.1 | 12.9 | 6 | 1.2 | 3.7 | 1230 | |
| <i>Vegetable foods.</i> | | | | | | | |
| Wheat flour | 12.5 | 87.5 | 11 | 1.1 | 74.9 | 5 | 1645 |
| Graham flour (wheat) | 13.1 | 86.9 | 11.7 | 1.7 | 71.7 | 1.8 | 1625 |
| Rye flour | 13.1 | 86.9 | 6.7 | .8 | 78.7 | .7 | 1625 |
| Buckwheat flour | 14.6 | 85.4 | 6.9 | 1.4 | 76.1 | 1 | 1605 |
| Oatmeal | 7.6 | 92.4 | 15.1 | 7.1 | 68.2 | 2 | 1850 |
| Cornmeal | 15 | 85 | 19.2 | 3.8 | 70.1 | 1.4 | 1645 |
| Rice | 12.4 | 87.6 | 7.4 | .4 | 79.4 | .4 | 1630 |
| Peas | 12.3 | 87.7 | 26.7 | 1.7 | 56.4 | 2.9 | 1565 |
| Beans | 12.6 | 87.4 | 23.1 | 2 | 59.2 | 3.1 | 1615 |
| Potatoes | 78.9 | 21.1 | 2.1 | .1 | 17.9 | 1 | 375 |
| Sweet potatoes | 71.1 | 28.9 | 1.5 | .4 | 26 | 1 | 530 |
| Turnips | 89.4 | 10.6 | 1.2 | .2 | 8.2 | 1 | 185 |
| Carrots | 88.6 | 11.4 | 1.1 | .4 | 8.9 | 1 | 200 |
| Onions | 87.6 | 12.4 | 1.4 | .3 | 10.1 | .6 | 225 |
| String beans | 87.2 | 12.8 | 2.2 | .4 | 9.4 | .8 | 235 |
| Green peas | 78.1 | 21.9 | 4.4 | .6 | 16 | .9 | 405 |
| Green corn | 81.3 | 18.7 | 2.8 | 1.1 | 13.2 | .6 | 345 |
| Tomatoes | 96 | 4 | .8 | .4 | 2.5 | .3 | 80 |
| Cabbage | 91.9 | 8.1 | 2.1 | .3 | 5.5 | 1.1 | 155 |
| Apples | 83.2 | 16.8 | .2 | .4 | 15.9 | .3 | 315 |
| Sugar, granulated | 2 | 98 | | | 97 | .2 | 1820 |
| Molasses | 24.6 | 75.4 | | | 73.1 | 2.3 | 1360 |
| White bread (wheat) | 32.3 | 67.7 | 8.8 | 1.7 | 56.3 | .9 | 1280 |
| Boston crackers | 8.3 | 91.7 | 10.7 | 9.9 | 68.7 | 2.4 | 1895 |

Digestibility of Foods.—In general, the animal foods are somewhat more digestible than the vegetable foods. The proteid matter of ordinary meats, for instance, is practically all digested when eaten in moderate quantities by healthy persons (97.5 per cent.); but the same person might digest only nine-tenths of the proteid matter of wheat, and not more than three-fourths of that of potatoes. The fat of meats is less completely digested.

The sugar and starch of vegetables, when they are properly cooked, are very easily and completely digested.

According to the experiments of Dr. Beaumont on Alexis St. Martin, the digestibility of different food substances ranges itself in the following order: "Rice, tripe, whipped eggs, sago, tapioca, barley, boiled milk, raw eggs, lamb, parsnips, roasted and baked potatoes, and fricasseed chicken are most easily digested in the order given—the rice disappearing from the stomach in one hour, and the fricasseed chicken in two and three-fourths hours. Beef, mutton, pork, oysters, butter, bread, veal, boiled and roasted fowls are rather less digestible, roast beef disappearing from the stomach in three hours, and roast fowl in four hours. Salted beef and pork disappear in four and a quarter hours."

The following list (Chambers) shows the relative digestibility of different articles of food: "Roast mutton, sweetbread, boiled chicken, venison, soft-boiled eggs, new toasted cheese, roast fowl, turkey, partridge and pheasant, lamb, wild duck, oysters, periwinkles, omelette, tripe, boiled sole, haddock, skate, trout, perch, roast beef, boiled beef, rump steak, roast veal, boiled veal, rabbit, salmon, mackerel, herring, pilchard, sprat, hard-boiled and fried eggs, pigeon, hare, duck, goose, fried fish, roast and boiled pork, heart, liver, kidneys, lobster, salted fish, crab."

The digestibility of food depends upon the nature of the food substance, its hardness and cohesion, and on its chemical nature, as well as on the degree to which it is altered by cooking. It is also dependent upon the individual characteristic of each person, the digestive power of the organs of digestion. The admixture of different classes of foods also aids digestion; some of the accessory foods probably causing an increased flow of the digestive fluids. The degree of fineness of the food and, consequently, the thoroughness of mastication are important factors in favoring digestion. The amount of food taken at a time also plays an important influence in digestion.

Composition of Foods.—The ordinary food materials consist of refuse matter, such as the bones of meat and fish, the shells of shellfish, the skin of potatoes, and the bran of wheat; and of proteid matter, fats, carbohydrates, and salts.

Prof. Atwater, in his reports on the chemical composition of food materials, uses the term "protein," which "includes nominally the total nitrogenous substance of animal and vegetable food materials, exclusive of the so-called nitrogenous fats." The term "proteid," as used in the same reports, "includes (1) the simple proteids, *e. g.*, albuminoids, globulins and their derivatives, such as acid and alkali albumins, coagulated proteids, proteoses, and peptones; (2) the so-called combined or compound proteids; (3) the so-called gelatinoids (sometimes called 'glutinoids'), which are characteristic of animal connective tissue." The term "albuminoids" is used as a "collective designation of the substances of the first two groups, though many apply it to all three of these groups. Of late a number of investigators and writers have employed the term as a special designation for compounds of the third class." The term "non-proteid" is "used synonymously with the term non-albuminoid," and includes nitrogenous animal and vegetable compounds of simpler constitution than the proteids. The most important animal compounds of this class are the so-called "nitrogenous extractives" of muscular and connective tissue, such as creatin, creatinin, xanthin, hypoxanthin, and allied cleavage products of the proteids. The non-proteid nitrogenous compounds in vegetable foods consist of amids and amido-acids, of which asparagin and aspartic acid are familiar examples.

The total nitrogenous substance is estimated by determining the amount of nitrogen present and multiplying the product by the factor 6.25.

The fats include the true vegetable and animal fats, such as the fat of fat meat, the fat of milk, olive oil, cottonseed oil, etc., and various other substances, such

as the fatty acids, lecithins (nitrogenous fats), and the chlorophyls. The fats contain about 75 per cent. of carbon. Under carbohydrates are included the different sugars, starches, gums, and cellulose, or woody fiber. These substances are found most plentifully in the cereals, as wheat, oats, corn, rye, and barley, in the *Leguminosæ*, and in the different roots, tubers, and green vegetables.

Under mineral foods are included water, phosphates, sulphates, chlorids, and other salts of potassium, sodium, magnesium, and other metallic elements. Of these, sodium chlorid is the most important, its presence exciting assimilative changes and assisting in the secretion of many of the digestive fluids, especially of the gastric juice; and so necessary is it to the organism that when it is supplied in insufficient quantity it is retained by the tissues and not excreted. When deprived of it animals lose in weight and activity. The potassium salts are also indispensable, acting as excitors of the nervous system and increasing the cardiac pulsations. The phosphates are of importance because of the large amounts required to maintain the normal condition of the bones.

Functions of the Alimentary Principles of Food.

—The various nitrogenous substances in foods serve the following purposes when taken into the system: Formation and repair of the tissues and fluids of the body; the regulation of the absorption and utilization of oxygen; and they serve as regulators of digestion and assimilation, especially with reference to the gelatin group.

Of the non-nitrogenous substances in foods, the fats serve to supply fatty tissues and as nutrition to the nervous system. They also supply energy and animal heat by oxidation. The carbohydrates also serve to supply energy and animal heat by oxidation, and they are converted into fat by deoxidation, and stored in the body for future use. The vegetable acids serve to maintain the alkalinity of the blood by conversion into car-

bonates, and to furnish a small amount of energy or animal heat by oxidation.

The mineral matters of food serve to support the bony skeleton, supply hydrochloric acid for digestion, also as regulators of energy and nutrition.

In addition to the four alimentary principles in food, several groups of substances, which are not included in this classification, must also be mentioned. These are the condiments and beverages. The condiments are of importance because they serve to give flavor to food, and stimulate secretion and digestion, though they have but little direct influence in forming tissue or in supplying energy and heat.

Water as Food.—Since water forms about two-thirds of the weight of the body, a great deal of fluid must be taken into the system in order to balance the constant loss through the excretions. This fluid is in part supplied by the food as usually prepared, but a large proportion must be supplied directly as water or in the form of some beverage, as tea, coffee, milk, or some of the alcoholic or non-alcoholic beverages. The quantity of water required daily by an adult person is usually stated as 3 liters, of which 1 liter is contained in the food ingested, and the other 2 liters must be supplied in the form of plain water or one or other of the beverages named.

A deficient supply of water, or fluid of any kind, tends to induce affections of the kidneys and bladder from the concentrated condition of the blood and excreta. It also manifests itself in diminished nervous activity.

The supply of fluid taken should be so regulated as not to interfere with digestion. Large quantities of fluid taken with, or shortly after the meals, will dilute the gastric juice to such an extent as to retard digestion, and thus lead to disturbances of the digestive function. The experiments of Hawk and his associates have shown that, contrary to the generally accepted opinion, copious water-drinking is not injurious. In fact, in many instances it

was found beneficial because of the increased elimination induced.

DIFFERENT VARIETIES OF FOOD.

Animal Foods; Meat.—The flesh of herbivorous animals is most commonly used for food, though that of the pig, an omnivorous animal, is also used extensively in some countries. The flesh of young animals is more tender, because there is less connective tissue between the different muscular bands. Atwater has found that meat and fish are digested to the same extent by healthy men. The meat derived from young animals is less easily digested than that of older animals. Cooked meat is more difficult of digestion than raw meat. The meat of females is also more tender and less coarse than that of males. The flesh of wild animals is less fatty, higher in color, and richer in flavor and extractives than that of domestic animals.

The nitrogenous substances of meat are albumin, creatin, creatinin, sarkin, xanthin, inosin, uric acid, and urea. The muscular sheaths and connective tissue contain also myosin. The proportion of albumin ranges from 0.6 to 4.56 per cent.; Liebig gave the average amount as 2.96 per cent. Prof. Mallet has found, as the result of numerous experiments, that the creatinin is excreted unchanged, while the creatin is changed wholly or very largely to creatinin, and consequently he believes these two substances cannot be regarded as sources of energy, being excreted practically without having undergone change. The influence of creatin in the system, according to König, is to stimulate the nervous system.

The average composition of albumin may be taken as follows: In 100 parts, nitrogen 16, carbon 54, oxygen 22, hydrogen 7, and sulphur 1. In the group of substances headed by gelatin the proportion of nitrogen (= 18 per cent.) to carbon is greater, and these substances are much less nutritious than the albuminates proper.

Diseases Produced by Diseased Meat.—All animals slaughtered for food should be free from disease. Certain diseases from which the domestic animals suffer are directly communicable to man; others are not directly communicable to man, but the flesh of the animals suffering from them is unfit for food. The inspection should be made both before and after slaughtering.

The diseases of cattle which render their flesh unfit for food are epidemic pleuropneumonia, foot-and-mouth disease, Texas cattle fever, cattle plague, anthrax, actinomycosis, and tuberculosis. Dropsical conditions, as well as all inflammatory conditions, also render the flesh unfit for food. The diseases of the pig which render the flesh unfit for food are anthrax, muco-enteritis, hog-cholera, tuberculosis, *Cysticercus cellulosa*, and *Trichinella spiralis*.

Meat Inspection.—Some of the diseases of the domestic animals can be recognized before death, but most of them must be detected by post-mortem examination, either by general inspection of the carcass and of the organs and different portions of the body, or by microscopic examination.

The general inspection includes the observation of the nature and the quantity of fat, the color, odor, and consistence of the muscles, condition of the bone-marrow, and the condition of the lungs, liver, spleen, kidneys, and the lymphatic glands.

There should not be an excessive amount of fat, or else the proportion of proteid matter will be too low; it should be firm and not too yellow, and without hemorrhagic foci. The color of the fat will vary somewhat with the age, breed, and color of the animal, and the kind of food.

The muscles should be firm yet elastic. They should be tolerably dry and have a pleasant odor. There should be no lividity on cutting across some of the muscles. A purple color may be indicative that the animal has not been slaughtered, or that it suffered from some acute

disease. There should be a marbled appearance from the ramification of connective tissue and fat between the muscular bundles.

The bone-marrow of the hind legs is of a light rosy-red color, and remains solid for about twenty-four hours after death. If it is soft, brownish, or with dark points, the animal may have been sick, or putrefaction may be commencing. The marrow of the fore legs is somewhat softer and of a rose-red color.

The internal organs should be carefully inspected for the presence of tumors, parasites, or suppuration. The lungs and pleuræ will usually show the presence of tuberculosis, through the deposition of tubercles. Sometimes these are found first in the lymphatic glands of the mesentery and mediastinum.

The microscopic examination of meat is directed principally toward the detection of parasites, such as the cysticercus, psorospermia, and trichina. The cysticercus may be found in the flesh of cattle and pigs; the psorospermia in the flesh of fish, rabbits, and pigs; and the trichinia in the flesh of pigs. A power of from 25 to 50 diameters is sufficient to detect these parasites in meat.

Method of Meat Inspection.—The method of meat inspection, and the restrictions placed upon the sale of the meat of diseased cattle, differ very greatly in different countries. For instance, Saxony and Bavaria, in Germany, Italy, Russia, and Denmark allow the sale of the meat of tubercular animals when the disease has not become generalized, providing it is sold with the understanding that it is derived from diseased animals, or is sold as second-class meat. In most foreign countries, as well as in the United States, the meat of tubercular animals is sold without any declaration as to its nature as wholesome meat when the disease is localized.

In the United States the inspection of meat is in charge of the national government. Meat inspectors are stationed at the slaughter-houses of all large cities, and each carcass is inspected as soon as slaughtered. This

system of inspection should be extended so as to include towns of smaller size, because, especially in the West, three, four, or more small slaughter-houses are clustered on the outskirts of small towns, and each may become a focus for the dissemination of disease.

Meat intended for export is always subjected to rigid inspection. Edelmann¹ states that pigs' livers imported into Dresden from America or Denmark frequently contain trichinella. But in the year 1896 only four livers out of 2023 were found to be infected, and in each case the parasites were dead, probably owing to the use of antiseptics to preserve the meat. All pork intended for exportation is examined microscopically for the presence of the *Trichinella spiralis*. This inspection is made by the Federal authorities at the slaughter-house. Most of this work is done in Chicago. In most cities of the United States the meat intended for local consumption is inspected very superficially or not at all.

Ostertag² mentions the following points as forming the foundation upon which the rules governing the question of meat inspection must be based:

1. The erection of public slaughter-houses in all cities of more than 5000 inhabitants.
2. Compelling the butchers to kill their animals in these slaughter-houses, and to discontinue the use of private slaughter-houses.
3. Professional direction of the slaughter-houses, and the inspection of all animals both before and after the slaughter.
4. The provision of stalls for the sale of inferior but not unhealthy meat (not apt to cause disease in man), such as meat of an abnormal color, odor, bloody meat, and that from sick animals. The provision of a cooking or sterilizing apparatus, for cooking such meat as might cause disease if consumed raw, but would be harmless

¹ *Zeit. Fleisch- u. Milch-Hyg.*, 1898, p. 64.

² *Trans. German Veterinary Council for 1891.*

when cooked (meat containing cysticerchi, trichina, and tubercle bacilli).

5. The total destruction of those animals and parts of animals which are condemned as unfit for food.

6. The formation of a co-operative insurance society for the purpose of recompensing the owners of condemned cattle. It is best that this society should be conducted by the city or town, in order that the losses might be regularly distributed.

It seems evident, from the experiments of Woodhead and others, that there is positive danger from the use of meat of tubercular animals even though the disease has not been generalized. The point which seems to be entirely overlooked, and to which a great deal of importance should be attached, is that when the disease is localized in one or more organs there is great danger of infecting the entire carcass by the butcher's knife in removing these infected organs. Not only may the carcass containing the tubercular nodules become infected in this manner, but the infection may also be carried on the butcher's knife to the carcasses of other animals slaughtered by him.

Food-poisoning.—Several types of food-poisoning have been recognized. The first group of these food-poisonings to be considered is that due to *Bacillus botulinus*, an anaërobic organism discovered by Van Ermengem in 1895. This bacillus produces a highly toxic poison in meat which, when taken into the system, has an especial affinity for the nervous system, and hence the character of the symptoms seen in poisoning from tainted meat. Kemperer has found that it is possible to counteract these symptoms, at least in part, by means of an anti-toxin derived from the blood of animals immunized against the bacillus. Experiments have shown that dogs are immune to this organism even when fed in their food in pure cultures.

The second group results from the development of putrefactive bacteria in originally wholesome foods, and the

organisms encountered most frequently belong to the proteus group. The effects produced are due to putrefactive substances—ptomaines—formed as the result of the metabolic action of the bacteria.

The **third** group is caused by bacteria belonging to the hog cholera group. Clinically, the cases are usually characterized by acute, stormy onset, mostly with chills and high fever, severe and sometimes uncontrollable vomiting, violent diarrhea, cramps in the legs, and rapid loss of strength. Occasionally the course is milder and more like that of typhoid fever. Paratyphoid bacilli have been isolated from the organs and tissues of diseased animals, and it is clearly established that under certain circumstances animals from which we obtain food are subject to infection with paratyphoid bacilli. These infections appear to occur only sporadically, and the special conditions necessary for their development are not yet clearly understood.

In the majority of cases of poisoning due to paratyphoid bacilli it concerns an actual infection with bacilli in addition to intoxication with substances derived from them. This intoxication probably manifests itself in the severe symptoms often characteristic of the beginning of the attack. Paratyphoid bacilli, as well as the Gärtner bacillus, form toxic substances that are able to resist high temperatures and which in smaller animals cause diarrhea and convulsions. When only a small number of bacilli is introduced, it is thought that the milder form of the disease, a form of so-called paratyphoid fever, may develop, and in some of the epidemics both the clinical forms have been observed. Lentz, who has studied 200 cases of paratyphoid infection, saw in about 40 per cent. the typhoid-like course, while in the others the attack began suddenly with high fever and chills. It is interesting to note that in cases of paratyphoid intoxication herpes of the lips and nose is relatively common, and there may be roseola in large spots; there are rarely ulcers in the intestines; occasionally there is a pronounced, often hemorrhagic, enteritis.

Preservation of Meat.—Meat can be preserved in its normal state in cold climates for a week or more without undergoing any change detrimental to health. In warm climates it cannot be preserved longer than a day or two without resorting to some method to prevent the action of the bacteria of putrefaction. The methods in common use for this purpose are desiccation, sterilization by heat, refrigeration, salting, and the use of antiseptic substances,—that is, substances which prevent the development and action of putrefactive bacteria.

Desiccation takes away the moisture and thus prevents the growth of bacteria. In some exceptionally dry climates desiccation takes place on simple exposure to the air. Ordinarily, however, the desiccation must be brought about by artificial heat. In common practice the process is conducted in a smoke-house, where the smoke assists in preserving the meat.

Sterilization by heat is commonly resorted to in the household where other methods of preserving are not available. This method is also employed commercially, and the sterilized meat is preserved in hermetically sealed receptacles, in which it keeps indefinitely. The so-called "canned meat" used for the United States army during the Spanish-American war is a form of preserved meat. When the receptacle is once opened, the meat soon undergoes decomposition.

Salting is one of the oldest methods of preserving meat. The action of the salt is to remove moisture, to harden the muscle-fiber, and it is also deterrent to bacterial action, as the putrefactive organisms are unable to develop in the presence of large quantities of salt.

The use of various *antiseptic substances* for the preservation of meat is of recent date. Since all antiseptic substances are poisonous, they should not be employed for this purpose. Meat that has been preserved by means of antiseptic substances is not only poisonous because of the antiseptics contained in it, but it is also objectionable because these antiseptics render it tough

and indigestible, and therefore irritant to the gastrointestinal tract. The antiseptic substances employed for this purpose are boric and salicylic acids, sodium sulphite, and formaldehyd. All these substances hinder the process of digestion, and are therefore harmful.

The only safe and rational method of preserving meat is by *refrigeration*. In this way meat can be stored for a considerable time or shipped long distances without suffering in character or digestibility.

Smoked, salted, and sterilized meats are far more difficult to digest, besides being less palatable and less nutritious than fresh meat. Meat preserved by sterilization is less nutritious and less palatable than fresh meat, and it is also less nutritious because it is overcooked.

Detection of Meat Preservatives.—A. Beythien and H. Hempel¹ tested the Jörgensen method of estimating boric acid in meat preservatives. This method is based upon the fact that a watery solution of boric acid, neutral to phenolphthalein, after being treated with a sufficient quantity of glycerin, again takes on an acid reaction, and that by subsequent titration with caustic alkali solution the amount of boric acid can be estimated if the value of the alkali solution has been carefully determined.

The samples of meat treated with known amounts of boric acid are made strongly alkaline with caustic soda solution, and then extracted for several hours with hot water. The filtrate is evaporated to dryness, incinerated, and the ash dissolved in sulphuric acid. This solution is gently warmed for some time to remove the carbon dioxide, and, after cooling, is accurately neutralized to phenolphthalein.

The fluid, about 50 c.c. in amount, is then treated with 25 c.c. of glycerin and titrated with $\frac{n}{10}$ NaHO solution without regard to the phosphates that may be precipitated; the end-reaction is made more definite by the

¹ Abst. in *Hyg. Rundschau*, Bd. x, S. 744.

addition of ethyl alcohol. In this manner 94.94 per cent. of the boric acid added was recovered.

Bornträger¹ makes the following statements with regard to the use of sodium sulphite (Na_2SO_3) as a meat preservative: "The extensive use of food preservatives is not generally recognized by the physician. The continued use of food substances preserved in this manner is detrimental to health.

"When sodium sulphite is present in food sulphurous acid gas is liberated in the stomach through the action of the hydrochloric acid of the digestive fluid, and this leads to strong local irritation. The salt also acts in the organism as a free acid.

"After eating Frankfurt, Vienna, or Bock sausage, or drinking the so-called Rhine or Moselle wines, there was eructation of sulphurous acid and hydrogen sulphid, with pressure and discomfort in the stomach, and headache, which lasted a considerable time."

The use of borax, sodium sulphite, and other preservatives in meat produces definite trains of symptoms and pathological conditions, especially lesions of the kidneys, as the result of the attempts at elimination of these poisons.

Although the use of meat preservatives is prohibited by the pure food laws of the United States, there is reason to believe that systematic chemical examinations of meats would reveal frequent employment of these substances. Unless we can invoke the aid of national, state, and municipal governments in inhibiting the use of preservatives of this character, it is probable that the influence of all other hygienic measures which tend to prolong life will be nullified because of the greater detriment exerted by the constant use of meats containing these preservatives.

Cooking.—The value of meat as served on the table is influenced to a considerable extent by the manner in which it is cooked. The object of cooking meat is to render it more easy of mastication and digestion, and to render it more palatable. It also serves to kill any parasites present, and thus prevents infection.

¹ Abst. *Hyg. Rundschau*, Bd. x., S. 743.

Of the different methods of cooking meat, broiling and roasting are the best, as in these methods the juices of the meat are retained as much as possible. In boiling and stewing a considerable portion of the juices is extracted. Frying in oil renders the meat richer in fats, and therefore more difficult to digest than when roasted or broiled.

Effect of Light and Dark Meats.—In recent years there has been considerable discussion as to the influence of dark meats, especially in cases of chronic parenchymatous nephritis, and in diseases of the nervous system. This differentiation between light and dark meats has been traced back to the time of Sydenham, who allowed his neurasthenic patients the light meat of calves, chickens, and fish, but prohibited the use of beef, because it favored the production of nervous disease. Later it was prohibited because it was believed to favor the production of uric acid. In consequence of this fact the differentiation between light and dark meats began to play an important *role* in the treatment of diseases of the kidneys. In recent times stomach and intestinal diseases, acute and chronic rheumatism, and the functional neuroses are also believed to be influenced unfavorably by the use of the dark meats.

In the treatment of kidney diseases the prohibition of dark meats is based upon the fact that these meats contain a greater proportion of nitrogenous extractives, and that these extractives produce irritation of the kidneys when eliminated, or in deficient action of the kidneys they accumulate in the system and produce toxic effects. The nitrogenous extractives of meat to which this effect is traced are, more especially, the creatin and creatinin, xanthin, leucin and tyrosin, and ptomains, besides other extractives. Smoked and pickled meats contain other irritating products, besides those contained in fresh meat, and are therefore far more injurious.

The trend of opinion at the present time is to minimize

the differentiation. Pabst was unable to determine any appreciable difference in the amount of urine excreted, and the proportion of albumin eliminated, with a milk diet, a diet of dark meat, white meat, or a mixed diet.

The explanation for the supposed injurious effects of dark meats has also been attributed to the effect of the simultaneous use of carbohydrates (Kirk). The use of dark meats with the exclusion of the carbohydrates is stated to be of decided advantage in the treatment of neurasthenics. While there is some clinical evidence as to the validity of this assumption, it will be best to await more extended experience before abandoning the teaching of Sydenham.

Composition of Meat.—Lean beef is composed of about 76 per cent. of water, 21.5 per cent. of nitrogenous substances, 1.5 per cent. of fat, and 1 per cent. of salts. The composition varies, however, in the same animal according to the part from which it is taken, for instance: The neck contains 73.5 per cent. of water, 19.5 per cent. of nitrogenous substances, 5.8 per cent. of fat, and 1.2 per cent. of salts; the flank, 63.4 per cent. of water, 18.8 per cent. of nitrogenous substances, 16.7 per cent. of fat, and 1.1 per cent. of salts; the shoulder, 50.5 per cent. of water, 14.5 per cent. of nitrogenous substances, 34 per cent. of fat, and 1 per cent. of salts. With increase in fat the percentage of water decreases; the percentage of nitrogenous substance is, however, increased very little by the fattening process. The percentage of water is also greater in the flesh of young animals than in that of adult animals.

Veal.—Veal is usually more difficult of digestion than beef. König attributes this to the fact that it is more tender and therefore less resistant to the masticating process, and is, consequently, masticated with more difficulty than other meat. It contains a greater proportion of water than beef. Its nutritive value is dependent upon the age of the calf when slaughtered, the younger it is the more watery the flesh, and the lower the propor-

tion of nutritive substances. In some countries, as in the United States and Austria, veal is not permitted to be used for food under one month of age.

Composition of the Flesh of Domestic Animals.¹

| Animal. | Condition. | Per cent. | | | | |
|-----------------|--------------------|-----------|------------------------|-------|----------------------------|------|
| | | Water. | Nitrogenous substance. | Fat. | Nitrogen-free extractives. | Ash. |
| Ox | Very fat | 53.05 | 16.75 | 20.28 | | 0.92 |
| | Medium | 72.03 | 20.96 | 5.41 | 0.46 | 1.14 |
| | Lean | 73.67 | 20.71 | 1.74 | | 1.18 |
| Cow | Fat | 70.06 | 19.86 | 7.70 | 0.41 | 1.07 |
| | Lean | 76.35 | 20.54 | 1.78 | | 1.32 |
| Calf | Fat | 72.31 | 18.88 | 7.41 | 0.07 | 1.33 |
| | Lean | 78.82 | 19.86 | 0.82 | | 0.50 |
| Sheep | Fat | 53.31 | 16.62 | 28.61 | | 0.93 |
| | Lean | 75.99 | 17.11 | 5.77 | | 1.33 |
| Pig | Fat | 47.40 | 14.54 | 37.34 | | 0.72 |
| | Lean | 72.57 | 20.25 | 6.81 | | 1.10 |
| Horse | (Mean) | 74.20 | 21.70 | 0.46 | 0.46 | 1.01 |

Mutton.—The flesh of sheep and lambs is composed of finer muscular bundles than beef, and is, in general, easily digested.

Relative Composition of Different Kinds of Meat (König).

| | Water. | Nitrogenous substances. | Fat. | Nitrogen-free extractive substances. | Salts. | In dry substance. | | |
|----------------------------------|--------|-------------------------|-------|--------------------------------------|--------|-------------------------|-------|-----------|
| | | | | | | Nitrogenous substances. | Fat. | Nitrogen. |
| | | | | | | | | |
| Ox, fat | 45.5 | 14.5 | 30.17 | | 3.9 | | | |
| Calf, fat (9 analyses) | 72.31 | 18.8 | 7.41 | 0.07 | 1.33 | 68.87 | 26.04 | 11.02 |
| Lamb, fat (9 analyses) | 53.31 | 16.82 | 28.61 | | 0.93 | 35.59 | 61.28 | 5.70 |
| Pork, fat (5 analyses) | 47.40 | 14.54 | 37.34 | | 0.72 | 28.16 | 70.44 | 4.50 |
| Horse (12 analyses) | 74.27 | 21.71 | 2.55 | 0.46 | 1.61 | 85.60 | 8.46 | 13.71 |
| Chicken, fat | 76.22 | 18.48 | 9.34 | 1.20 | 0.91 | 61.76 | 31.19 | 9.88 |
| Duck, wild | 70.82 | 22.65 | 3.11 | 2.33 | 1.09 | 77.59 | 10.62 | 12.92 |
| Goose, fat | 38.00 | 15.91 | 45.59 | | 0.48 | 38.02 | 73.55 | 4.11 |
| Herring (2 analyses) | 74.64 | 14.55 | 9.03 | | 1.78 | 56.42 | 35.85 | 9.03 |
| Trout (8 analyses) | 79.63 | 18.42 | 0.53 | 0.46 | 0.96 | 99.59 | 2.42 | 14.50 |

Pork.—The nature of the food-supply influences the character of the flesh of pigs to an important extent,

¹ Mitchell, *Flesh Foods*, London, 1900, p. 47.

especially with regard to its flavor and the deposition of the fat. Pork is more difficult of digestion than the meat of any of the other domestic animals.

Poultry and Game.—The flesh of birds differs from that of mammals in the fact that the fat is deposited in the muscular tissue to only a limited extent. It is also of a more delicate flavor than that of mammals. It is easier to digest than the flesh of mammals and is therefore frequently recommended for invalids.

Fish.—The flesh of most fish is white because their blood is white, though some have red blood. It is rich in water, and varies in its fat content, both quantitatively and qualitatively. The flavor of the flesh is dependent upon the different character of the fat in different fish. The structure of the flesh is similar to that of mammals, and is equally nutritious. According to the investigations of Atwater, the flesh of fish is as readily digestible as beef. There are, however, individual differences.

Milk and Milk-products.—**Cows' Milk.**—Cows' milk forms a most important article of diet in the United States. It is of the greatest importance, therefore, that the milk placed on the market should be as pure and wholesome as possible. The fact that milk is such a favorable culture-medium for most classes of bacteria makes it possible for it to become the carrier of disease-producing organisms. It may also be dangerous because of the presence of disease-producing bacteria derived from the cow, or because of the presence and growth of non-pathogenic forms. If the milk could be collected and stored in such a manner as to prevent the entrance of bacteria, it would keep a long time; but this is impossible, because it is frequently contaminated with bacteria in the milk-ducts of the udder. It is also further contaminated with bacteria derived from the fur and udder of the cow, the hands of the milker, the air of the stable and milk-house, and the utensils in which it is collected and stored.

Some of these bacteria, as the lactic-acid group, fer-

ment the lactose and produce lactic acid, causing the milk to turn sour and the casein often to coagulate. Other classes of bacteria cause the milk to decompose, with the production of odors; these are the putrefactive organisms. It has been found that storing the milk in an ice-chest for several days inhibits the multiplication of the lactic-acid group of bacteria, but does not inhibit the multiplication of the putrefactive bacteria, so that the milk under these conditions becomes putrid before it turns sour.

Pure and wholesome milk can be obtained only from healthy cows, but the milk of healthy cows may soon be rendered useless through carelessness in collecting and storing. The precautions necessary for the marketing of pure and wholesome milk are, therefore, far-reaching, numerous, and exacting. These precautionary measures should include the selection of healthy cows; the treatment and housing should be such as to favor the maintenance of their health; the utmost cleanliness about the stables and milk-house; the cleanliness of the milker and of those who handle and market the milk; the utmost cleanliness of all utensils employed in collecting, storing, and marketing milk.

Diseases Conveyed through Milk.—A number of diseases may be conveyed through milk, and they may be derived either from the cow yielding the milk or from those who come in contact with the milk in collecting and marketing it. The diseases that may be conveyed directly from the cow are tuberculosis and micro-organisms of inflammatory diseases, such as the *Streptococcus* and *Staphylococcus pyogenes*.

While the positive conveyance of tuberculosis from the domestic animals to man is still disputed by some, especially that of bovine tuberculosis through the use of the milk and meat of tubercular animals, because of slight morphologic and biologic differences between the bacillus as found in bovine and human tuberculosis, the trend of opinion to-day is in favor of regarding the milk

of all tubercular animals as dangerous to health. The direct transmission of bovine tuberculosis to members of the human family is infrequently demonstrated, because of the insidious onset of the disease and its slow progress; yet there are some cases on record which appear beyond a doubt to have been contracted in this manner. Leonhart reports the case of a healthy infant, of healthy parents, which was weaned and put on cows' milk. The child soon died of tuberculosis of the meninges, intestines, and mesenteric glands. The cow from which the milk was derived was found to be tuberculous. Another child fed on the milk of the same cow died, at about the same time, from tubercular meningitis. Sonntag reports the case of a six months' old infant, of healthy parents, which at autopsy showed miliary tuberculosis of the meninges. It was fed on milk derived from a tubercular cow. Hermsdorf gives 3 instances in which there was extensive intestinal tuberculosis, besides general affection of other organs. One had taken uncooked milk from a tubercular cow. Demme reports the case of a four months' old infant which at autopsy showed tuberculosis of the mesenteric glands. There was no tuberculosis in the family for two generations on either side. The milk came from a cow with general tuberculosis. Bollinger cites Stang's case of a boy of five years, who sickened with ascites and enlarged glands in the abdomen. At autopsy the chief lesion was tuberculosis of the abdominal lymphatics, but there was also tuberculosis of the serous membranes and of the lungs. There was no tuberculosis in the family for two generations. The child had for years been in the habit of drinking milk warm from a cow, which, growing thin before the boy died, was killed, and found to be tubercular.

Holt reports on 1045 consecutive autopsies from the records of the New York Infant Asylum and Babies' Hospital—10 per cent. of which were found to be tuberculous. In the latter institution, which receives only sick children, the percentage was higher.

To guard against the dangers of infection through the use of milk from tubercular cows the thorough inspection of all cows kept for breeding purposes, or whose milk is offered for general consumption, should be insisted upon. The most reliable and ready method known to-day, by means of which we can detect the disease, even in its incipient stage, is the tuberculin test. This test is now employed in many States and in many foreign countries, and, if the tuberculin has been prepared by competent bacteriologists, it is believed to be without detrimental effects on healthy animals.

Among the laws enacted to arrest the spread of tuberculosis among cattle, and from cattle to man, may be mentioned the tuberculin law of Denmark, of 1893, which makes regulations for the exclusion from commerce of all animals apparently tubercular, as well as for the pasturing of such animals together with others. It also forbids the use of uninspected meat of such animals, and also the use of milk from cows suffering from tuberculosis of the udder. In this country several States have passed laws creating sanitary commissions for the inspection and slaughtering of diseased animals upon the voluntary request of the dairymen. The Act of May 21, 1895, establishing the State Live Stock Sanitary Board of Pennsylvania, is a law of this nature. The law of April 26, 1895, enacted by the legislature of Minnesota, will no doubt have more salutary effects, and seems to be more directly in the line of future action. This law directs that the city council of any city may, by ordinance, provide for the inspection of milk dairies and of dairy herds kept for the production of milk within its limits, and issue licenses, for which no fee shall be charged, for the sale of milk within its limits, and regulate the same, and may authorize and empower the board of health to enforce all laws and ordinances relating to the production and sale of milk, and the inspection of dairies and dairy herds producing milk for sale or consumption within such city, and to appoint such in-

spectors, experts, and chemists as are necessary for the proper enforcement of such laws and ordinances. Under this law the city council of Minneapolis passed, June 14, 1895, and approved June 21, 1895, an ordinance embodying all the features contained in the State law. The city of Port Huron, Michigan, also adopted a milk ordinance, September 26, 1896, to regulate and control the sale of milk in the city, in which the licensing of all milk-dealers, and the inspection of all dairy herds and dairies is required.

In New York City an ordinance was passed, in 1895, forbidding the sale of milk within the city without a permit from the department of health, and requiring that all wagons used for the transportation or delivery of milk should likewise have wagon permits. Before these permits are issued the holder must furnish information as to the source from which the milk is obtained, the number of animals, the character of the food-supply, and the sanitary conditions surrounding the dairy. All milk cows in the city have been subjected to the tuberculin-test, under the supervision of the health department, and the diseased animals killed. It is also proposed to require similar tests to be applied to all cows whose milk is sent to the city.

Dr. John R. Mohler, Chief of the Pathological Division, Bureau of Animal Industry, investigated the "Infectiveness of Milk of Cows which have reacted to the Tuberculin Test," and reached the following conclusions:

The tubercle bacillus may be demonstrated in milk from tuberculous cows when the udders show no perceptible evidence of disease either macroscopically or microscopically.

The bacillus of tuberculosis may be excreted from such an udder in sufficient numbers to produce infection in experimental animals both by ingestion and inoculation.

That in cows suffering from tuberculosis the udders may become infected at any moment.

The presence of tubercle bacillus in the milk of tuberculous cows is not constant, but varies from day to day.

Cows secreting virulent milk may be affected with tuberculosis to a degree that can be detected only by the tuberculin test. Physical examination or the general appearance of the animal does not always reveal the disease.

The milk of all cows which have reacted to the tuberculin test should be considered as suspicious, and should be subjected to sterilization before using.

Still better, tuberculous cows should not be used for general dairy purposes.

Recently, Beck, of Berlin, reported on an investigation of 56 samples of market milk as to the presence of pathogenic bacteria in such milk. He found tubercle bacilli in 30.3 per cent. of the samples, and streptococci in 62.3 per cent. These streptococci were pathogenic for guinea-pigs when injected intraperitoneally, the animals dying in from three to four days from a purulent peritonitis. The peritoneal exudate usually contained the streptococci in pure cultures. Mice were killed in about twenty-four hours by subcutaneous and intraperitoneal injections of small amounts of a bouillon culture of the streptococci, with symptoms of general infection. Rabbits died in two or three days after intravenous injections of a few drops of a bouillon culture; in some instances serous, purulent exudates into the joints were observed. A fresh culture rubbed into the skin of the rabbit's ear was productive of an erysipelatous inflammation of the entire ear, with considerable fever, though all of these animals recovered. The injection of 1 to 3.5 cubic centimeters of a fresh bouillon culture into the stomach of guinea-pigs resulted in the production of severe diarrhea, some of the animals dying of enteritis. On post-mortem examination of these animals the mucous membrane of the intestine was found to be markedly reddened, showing ecchymoses, and the fluid contents of the intestine contained numerous streptococci.

Beck believes these streptococci to be closely related to those found by Escherich in the enteritis of infants. He states that Romme also believes in the danger of infantile enteritis from these streptococci.

The use of milk derived from cows suffering from inflammatory disease of the milk-ducts is undoubtedly productive of inflammatory conditions of the gastro-intestinal tract, especially in infants. The cases of fatal streptococcus enteritis reported by Hirsch and Libbert appear to have been cases of this kind. Booker is also of the opinion that gastro-enteritis is not infrequently produced in this manner.

Of the diseases conveyed in milk, aside from those derived from the cows themselves, may be mentioned typhoid fever, cholera, diphtheria, and scarlet fever. These diseases are not produced by infection derived from the cows, but by contamination of the milk with polluted water, or by means of flies, and by means of infected hands and clothing of the milkers or those employed in collecting and marketing the milk.

Typhoid fever and cholera may be conveyed through milk in very much the same manner. These diseases are most frequently conveyed through impure drinking-water, but when the milking utensils are washed in polluted water, or the milk is diluted with water containing the typhoid and cholera organisms, the diseases may be conveyed in this manner. Again, flies and other insects are no doubt frequently concerned in conveying these diseases by coming in contact with the fresh evacuations of patients suffering therefrom, and then subsequently infecting milk. For these reasons the storing of milk in such a manner as to prevent the possibility of this mode of infection is of the greatest importance.

Diphtheria and scarlet fever may be conveyed in milk; and a number of epidemics of these diseases have been traced to their source in contaminated milk. The most common mode of contamination is through the infected hands of milkers and those handling the milk. The

most rigid care should be exercised to avoid the dissemination of these diseases in this manner. No one suffering from these diseases, nor any one coming in contact with those suffering from them, should be allowed to milk or handle any milk that is intended for general consumption. There is no evidence at hand to substantiate the belief that cattle suffer from either of these diseases. The milk is usually contaminated by the family of the dairyman, or others through whose hands the milk passes on its way to the consumer.

Municipal Control of the Milk-supply.—In order to make it possible for the poorer classes to obtain a milk-supply that is free from danger, it is necessary for municipalities to institute certain regulations to control the marketing of milk. This is especially necessary on account of the relation of the milk-supply to the high infantile mortality. There should be direct supervision of the dairies and their surroundings. This should include an investigation and repeated inspection of the health of the herd, the nature of their food-supply, the purity of the water on the farm, and the general sanitary conditions on the farm. All the milk-dealers in the city should be licensed, and their wagons distinctly marked so as to indicate the name of the dealer and the source of the milk. Especial importance should be attached to the sale of milk in stores and the sanitary precautions required in storing milk. The use of all preservatives must be strictly prohibited on account of their detrimental influence on health.

New Milk Law of Philadelphia.—The efforts to improve the milk supply of Philadelphia have led to the appointment of a commission which, in its report, makes numerous recommendations concerning the collection and distribution of milk. The commission recommended that the milk should reach the city at a temperature not exceeding 50° F. This regulation, if enforced, will prevent the enormous multiplication of bacteria in milk in transportation to the city.

FIFTY DAIRY RULES.¹

The Owner and His Helpers.—1. Read current dairy literature and keep posted on new ideas.

2. Observe and enforce the utmost cleanliness about the cattle, their attendants, the stable, the dairy, and all utensils.

3. A person suffering from any disease, or who has been exposed to a contagious disease, must remain away from the cows and the milk.

The Stable.—4. Keep dairy cattle in a room or building by themselves. It is preferable to have no cellar below and no storage loft above.

5. Stables should be well ventilated, lighted, and drained; should have tight floors and walls, and be plainly constructed.

6. Never use musty or dirty litter.

7. Allow no strongly smelling material in the stable for any length of time. Store the manure under cover outside the cow stable, and remove it to a distance as often as practicable.

8. Whitewash the stable once or twice a year. Use land plaster in the manure gutters daily.

9. Use no dry, dusty feed just previous to milking; if fodder is dusty, sprinkle it before it is fed.

10. Clean and thoroughly air the stable before milking. In hot weather sprinkle the floor.

11. Keep the stable and dairy-room in good condition, and then insist that the dairy, factory, or place where the milk goes be kept equally well.

The Cows.—12. Have the herd examined at least twice a year by a skilled veterinarian.

13. Promptly remove from the herd any animal suspected of being in bad health and reject her milk. Never add an animal to the herd until certain it is free from disease, especially tuberculosis.

14. Do not move cows faster than a comfortable walk while on the way to place of milking or feeding.

¹ Report of the Bureau of Animal Industry, 1898.

15. Never allow the cows to be excited by hard driving, abuse, loud talking, or unnecessary disturbance; do not expose them to cold or storm.

16. Do not change the feed suddenly.

17. Feed liberally, and use only fresh, palatable feed-stuffs; in no case should decomposed or mouldy material be used.

18. Provide water in abundance, easy of access, and always pure; fresh, but not too cold.

19. Salt should always be accessible.

20. Do not allow any strong-flavored food, like garlic, cabbage, and turnips to be eaten, except immediately after milking.

21. Clean the entire body of the cow daily. If the hair in the region of the udder is not easily kept clean, it should be clipped.

22. Do not use the milk within twenty days before calving, nor within three to five days afterward.

Milking.—23. The milker should be clean in all respects; he should not use tobacco; he should wash and dry his hands just before milking.

24. The milker should wear a clean outer garment; used only when milking, and kept in a clean place at other times.

25. Brush the udder and surrounding parts just before milking, and wipe them with a clean, damp cloth or sponge.

26. Milk quietly, quickly, cleanly, and thoroughly. Cows do not like unnecessary noise or delay. Commence milking at exactly the same hour every morning and evening, and milk the cows in the same order.

27. Throw away (but not on floor, better in the gutter) the first few streams from each teat; this milk is very watery and of little value, and it may injure the rest.

28. If in any milking a part of the milk is bloody or stringy or unnatural in appearance, the whole mess should be rejected.

29. Milk with dry hands; never allow the hands to come in contact with the milk.

30. Do not allow dogs, cats, or loafers to be around at milking-time.

31. If any accident occurs by which a pail full or partly full of milk becomes dirty, do not try to remedy this by straining, but reject all this milk and rinse the pail.

32. Weigh and record the milk given by each cow, and take a sample morning and night, at least once a week, for testing by the fat-test.

Care of Milk.—33. Remove the milk of every cow at once from the stable to a clean, dry room, where the air is pure and sweet. Do not allow cans to remain in stables while they are being filled.

34. Strain the milk through a metal gauze and a flannel cloth or layer of cotton as soon as it is drawn.

35. Aerate and cool the milk as soon as strained. If an apparatus for airing and cooling at the same time is not at hand, the milk should be aired first. This must be done in pure air, and it should then be cooled to 45° F. if the milk is for shipment, or to 60° F. if for home use or delivery to a factory.

36. Never close a can containing warm milk which has not been aerated.

37. If cover is left off the can, a piece of cloth or mosquito-netting should be used to keep out insects.

38. If milk is stored, it should be held in tanks of fresh, cold water (renewed daily), in a clean, dry, cold room. Unless it is desired to remove cream, it should be stirred with a tin stirrer often enough to prevent forming a thick cream layer.

39. Keep the night milk under shelter so that rain cannot get into the cans. In warm weather hold it in a tank of fresh cold water.

40. Never mix fresh warm milk with that which has been cooled.

41. Do not allow the milk to freeze.

42. Under no circumstances should anything be added to milk to prevent its souring. Cleanliness and cold are the only preventatives needed.

43. All milk should be in good condition when delivered. This may make it necessary to deliver twice a day during the hottest weather.

44. When cans are hauled far they should be full, and carried in a spring wagon.

45. In hot weather cover the cans, when moved in a wagon, with a clean wet blanket or canvas.

The Utensils.—46. Milk utensils for farm use should be made of metal, and have all joints smoothly soldered. Never allow utensils to become rusty or rough inside.

47. Do not haul waste products back to the farm in the cans used for delivering milk. When this is unavoidable, insist that the skimmed milk or whey can be kept clean.

48. Cans used for the return of skimmed milk or whey should be emptied and cleaned as soon as they arrive at the farm.

49. Clean all dairy utensils by first thoroughly rinsing them in warm water; then clean inside and out with a brush and hot water in which a cleaning material is dissolved; then rinse, and lastly sterilize by boiling water or steam. Use pure water only.

50. After cleansing, keep utensils inverted, in pure air, and sun if possible, until wanted for use.

Butter.—Butter serves as an important source of fat in the food of most people. It is very palatable to most persons, and it is easily digested when fresh and pure. When kept for some time butter becomes rancid—that is, the fat becomes changed through the action of bacteria contained in the butter, and in this condition it is more difficult to digest.

Butter may be injurious to health in two ways: It may contain the specific micro-organisms of certain diseases, as the typhoid bacillus or the *Bacillus tuberculosis*, or the presence of other fats of animal or vegetable origin. The typhoid bacillus may be present in butter through the use of polluted water in washing the utensils used in

the collection and storing of the milk, or in making the butter. The *Bacillus tuberculosis* may be derived from the cows from which the milk is obtained. Virulent tubercle bacilli have been found a number of times in butter made from the milk of tubercular cows.

The addition of other fatty substances to butter, or the substitution of these fats for butter, under the names of butterin and oleomargarin, is now prohibited by law, though it is by no means infrequent even at the present time. These fats are usually more difficult of digestion, aside from the fact that they are fraudulent substitutes for a more costly article of diet. If fats derived from diseased animals are added to butter, the bacteria contained in these may be a source of danger to the consumer.

Cheese.—The high nutritive value of cheese and its cheapness make it an important article of food, especially for the poorer classes.

Cheese may be injurious to health on account of the presence of tubercle bacilli when the milk is derived from tubercular cows, though it is claimed these organisms cannot live in cheese for more than fourteen days. The typhoid bacillus and cholera organism die after a very few days. Cheese may also be injurious to health because of the presence of poisonous products of non-pathogenic bacteria of certain species. This poisonous substance is of the nature of a ptomain. It has been extensively studied by Vaughan, who has called it tyrotoxicon. This form of poisoning by cheese is not infrequent. It may also occur in ice-cream, and in milk under certain circumstances. It is accompanied by grave gastro-intestinal disturbances and marked nervous depression.

Eggs as Food.—Eggs are used as food in very large quantities, and their use as a food has become a question of unusual importance in recent years because of the increasing demands for fresh eggs in feeding tuberculous

individuals. Eggs derived from healthy hens are occasionally contaminated with fecal bacteria. Hens suffering from chronic bacillary infection of the oviduct yield eggs that appear normal, but which may contain considerable numbers of bacteria.

Eggs that have been kept in cold storage for a time are in danger of the invasion of bacteria from the exterior. Under these circumstances the eggs may be highly injurious to the health of the consumer. The danger of the invasion of the interior of the egg by bacteria is still greater when the eggs are moist. When the shell is cracked, bacteria enter at once and produce alterations which, in a short time, render the egg putrid.

Vegetable Foods.—The vegetable foods exceed in number and form those derived from the animal kingdom. They differ from the animal foods principally in the form in which the nutritive substances (nitrogenous matter and fat) occur, and in the presence of starch, gums, sugars, and other nitrogen-free extractives which do not occur in animal foods. These latter substances contained in vegetable foods take the place, in part, of the fats in animal foods. The various forms of sugar found in vegetable foods, as glucose, saccharose, mannose, etc., take the place of the lactose and inosit of animal foods. Another nitrogen-free substance present in vegetable foods which is not found in animal foods is cellulose, which is partly digested, and in part serves other useful purposes in foods.

The nitrogenous substances contained in vegetable foods are vegetable albumin and casein, gluten, nuclein, besides other nitrogenous substances, as asparagin, leucin, amygdalin, allantoin, lecithin, etc.

The mineral substances contained in vegetable foods are qualitatively the same as those contained in animal foods.

Composition of the Cereals.

| Cereal. | No. of analyses. | Nitrogenous substances. | Fat. | Nitrogen-free extractives. | Cellulose. | Ash. | Nitrogen. |
|-----------------|------------------|-------------------------|---------|----------------------------|------------|---------|-----------|
| | | Per ct. | Per ct. | Per ct. | Per ct. | Per ct. | Per ct. |
| Wheat | 1358 | 13.89 | 2.20 | 79.75 | 2.19 | 1.97 | 2.22 |
| Rye, winter . . | 173 | 12.48 | 1.77 | 81.04 | 1.78 | 2.06 | 2.00 |
| Barley | 766 | 11.24 | 1.93 | 77.24 | 4.95 | 2.42 | 1.79 |
| Oats | 377 | 12.13 | 4.99 | 66.41 | 10.58 | 3.29 | 1.94 |
| Corn, flint . . | 80 | 11.74 | 4.78 | 79.20 | 1.67 | 1.40 | 1.88 |
| Rice | 10 | 7.00 | 2.00 | 84.76 | 4.00 | 1.16 | 1.12 |

Composition of the Leguminosæ.

| | No. of analyses. | Nitrogenous substances. | Fat. | Nitrogen-free extractives. | Cellulose. | Ash. | Nitrogen. |
|-----------------|------------------|-------------------------|---------|----------------------------|------------|---------|-----------|
| | | Per ct. | Per ct. | Per ct. | Per ct. | Per ct. | Per ct. |
| Beans | 63 | 29.26 | 1.68 | 55.86 | 8.06 | 3.13 | 4.68 |
| Peas | 72 | 26.39 | 1.39 | 61.21 | 5.68 | 2.68 | 4.30 |

The high protein content of the legumes makes these a valuable source of nitrogen. They are comparatively low in price, and are therefore at the command of families in the poorest circumstances. Their digestibility and flavor are dependent largely upon the method of preparation. When used in excessive amounts they give rise to flatulency, and hence should always be combined with other articles of food.

The proportion of water in vegetable foods varies greatly, ranging from about 90 per cent. in beets and turnips, to as low as 10 per cent. in some kinds of flour. In general, the dry seeds, as wheat, corn, beans, and different kinds of flour, contain about one-eighth part water and about seven-eighths parts nutrients. Beans and peas contain the largest proportions of proteid matter, and cornmeal, potatoes, rice, turnips, and beets the least. Of the cereals, wheat is the richest in proteid material. Wheat bread differs from wheat flour principally in the greater proportion of water present.

Comparison of Flour and Bread (Atwater).

| | Water. | Nutri- ents. | Proteid matter. | Fat. | Carbo- hydrates. | Mineral matter. | Fuel value of 1 gram. |
|-------------------|---------|-----------------|--------------------|---------|---------------------|--------------------|--------------------------|
| | Per ct. | Per ct. | Per ct. | Per ct. | Per ct. | Per ct. | Calories. |
| Wheat flour . . | 12.00 | 88.00 | 12.00 | 1.00 | 74.00 | 1.00 | 3.616 |
| Baker's bread . . | 32.00 | 68.00 | 9.00 | 2.00 | 56.00 | 1.00 | 2.866 |

Bread.—In bread-making the changes brought about by the process are twofold. The carbon dioxid generated by the yeast, or forced into the dough, causes it to be light and filled with small cavities. If the carbon dioxid is generated by the fermentative action of the yeast plant, the sugar present is converted into carbon dioxid, and at the same time a little lactic and butyric acids are formed, besides some extractive matter. A portion of the starch is also converted into dextrin and sugar. During the process of baking the fermentative action of the yeast plant is arrested and a portion of the albumin is coagulated. In bread made with the aid of baking-powders or by forcing carbon dioxid into the dough the products of fermentation are absent, and the only change produced is that brought about by the heat in baking.

Baking-powders.—There are three classes of baking-powders in use, the one class deriving its carbon dioxid from sodium or ammonium carbonate through the action of tartaric acid. These are frequently called “cream-of-tartar” baking-powders, because potassium acid tartrate is used to act upon the sodium carbonate, or bicarbonate, to generate the carbon dioxid. Another class of baking-powders differs from the foregoing in the use of phosphoric acid; these are called the phosphatic baking-powders. The other class of baking-powders is the “alum” baking-powders, because in these the double sulphate of aluminum and sodium is generally employed to act upon the carbonate to generate the carbon dioxid. This class of baking-powders is considered injurious to health. A great deal of evidence has been collected by a committee of the United States Senate, which uniformly condemns

the use of alum baking-powders. The continued use of alum is injurious to health, because of its irritant and astringent action in the alimentary tract, and when continued for a long time it impairs nutrition. The alum interferes with the secretion of the gastric juice, and has an irritant action on the intestines, and in time leads to constipation, and in certain instances to disease of the kidneys. The alum baking-powders also produce a heavier and more indigestible bread than the cream-of-tartar baking-powders. The use of alum in food, in any form, is prohibited in England, France, and Germany.

Preserved Vegetable Foods.—Vegetable foods may be preserved in several ways. The method which has long been in use is that of *drying*. This method is still used very generally in preserving certain kinds of food. The modification of this method in use in large manufacturing factories consists in exposing the fruit to the fumes of burning sulphur in a special apparatus. The fruit, when contained in galvanized-iron trays, is certain to take up appreciable amounts of zinc oxid. This fact has led to restriction of the importation of American dried fruits into foreign countries. The substitution of wooden, tin, or aluminum trays will obviate the danger of contamination with zinc. The amount of zinc formed averages about 10 milligrams for every 100 grams of the fruit. While this amount of zinc is probably harmless when taken occasionally, yet when constantly present in food may produce derangement of health through its irritant effect.

Another method of preserving vegetable foods is by means of *heat*. This method is unobjectionable where the food is stored in containers that yield no poisonous substances. The preservation of vegetable foods in tin cans is quite common, and there is some danger of lead-poisoning from these foods on account of the presence of lead in the solder employed in sealing the cans. This is especially the case with acid foods or foods that have been imperfectly preserved so that the

putrefactive organisms are not all destroyed. In such instances there is danger of solution of the lead through the action of bacterial products upon the solder.

Vegetable foods may also be preserved by the addition of *antiseptic substances*, so as to prevent the growth of micro-organisms. The antiseptics most commonly employed are salicylic acid and formaldehyd. These substances are in themselves irritant poisons when taken in certain amounts, while smaller amounts used for a long time are positively injurious, because of the irritant effect produced on the gastro-intestinal tract, and the inhibiting influence which they produce on the digestive processes. They are also injurious through the action they have on albuminous food-substances, in that they render them difficult of digestion. The use of all preservatives of this class should be strictly prohibited by law.

Food preservatives have been investigated by Prof. Bigelow, of the Agricultural Department at Washington, who finds that their manufacture has become a distinct line of business. Out of 67 samples of the most common preservatives in use, each of which was obtained with great difficulty when it was known that it was wanted for a chemical analysis, 33 contained borax or boric acid; 10 sodium, potassium, or calcium sulphite; 8 salicylic acid or its sodium compound; 7 benzoic acid or its sodium compound; 1 boric acid and salicylic acid; 1 boric acid and ammonium fluorid; 2 pyroligneous acid; and 1 β -naphthol. Prof. Bigelow holds that those undoubtedly injurious, such as formaldehyd, salicylic acid, and sulphites, should be proscribed, and a stringent law enacted to control the use of the less harmful ones.

Nuts and Their Uses as Food.—Nuts are a very concentrated food, even more so than cheese, but when used at regular meals they are well assimilated and may form a part of a well-balanced diet. Nuts are a very valuable source of protein and fat, these two nutrients being the

characteristic constituents of the more common nuts, of which the walnut and cocoanut may be taken as types. In the chestnut carbohydrates are a characteristic constituent. It is undoubtedly better to use nuts as a part of the regular diet than as a condiment or to supplement an otherwise hearty meal. Persons who use nuts in place of meat should not depend upon them as the main food-supply, but should supplement them with more bulky foods with a low content of protein and fat. Nuts may be classed among the staple foods, and not simply as food accessories.

Mineral Food.—The most important mineral food is sodium chlorid. It plays an important *rôle* in favoring the secretion of the digestive fluids. A drop of dilute salt solution placed upon the gastric mucous membrane of an animal causes a pouring out of gastric juice by the glands of the stomach. When taken into the mouth it causes the saliva to flow freely. Vegetable foods are somewhat deficient in salts, and require the addition of sodium chlorid to make up this deficiency, as well as to enhance their flavor and palatability. The vegetable foods are richer in potassium salts, and these, combining with the sodium salts of the body, cause an increased excretion of the latter; this action being compensated by the addition of sodium chlorid to the food. The amount of sodium chlorid taken during a year in a mixed diet ranges from 5 to 7 kilograms.

The other mineral food-substances contained in both vegetable and animal food are calcium and potassium phosphate; potassium, calcium, and sodium carbonate; and magnesium phosphate. All of these mineral substances have important nutritive functions in the body, but they are present in sufficient quantities in mixed diets, so that no further additions are required.

Beverages and Condiments.—Beverages may be classed as alcoholic and non-alcoholic. The alcoholic beverages differ from each other not only in the quantity

of alcohol present, but also with regard to the presence of various extractive substances and the amount and character of the mineral constituents.

Alcoholic Beverages.—Physiologic experiments have demonstrated that the alcoholic beverages may be regarded as articles of food, not only on account of the quantity of alcohol present, but also on account of the extractives which they contain. They serve to stimulate the digestion, the circulation, and the nervous system. They also diminish the oxidation processes of the body and lower the temperature. Small amounts of alcohol may be taken daily in the food, and, according to Prof. Atwater's experiments, these small amounts are oxidized in the system and are therefore a source of energy.

The principal objection to the use of alcoholic beverages is the fact that their constant use tends to the acquirement of the drink-habit. The constant use of large amounts of alcohol leads to grave derangement of health, and for this reason the use of alcoholic beverages is to be condemned, except under special conditions in disease where such a stimulant may be required.

Non-alcoholic Beverages.—The more important non-alcoholic beverages, besides water, are tea, coffee, and cocoa. These beverages have a stimulating effect because of the presence of an alkaloid in each—thein in tea, caffein in coffee, and theobromin in cocoa. Besides these alkaloids they contain various extractive substances and volatile oils, to which they owe their peculiar aroma. These beverages have no nutritive qualities in themselves, but the addition of sugar and milk makes them nutritious. Their principal effect is one of stimulation. They are used largely as convenient modes of administering water with the food.

The chief hygienic interest of these beverages is in the effects produced by excessive usage. The effects produced are most commonly insomnia, nervous irritability, indigestion, and palpitation of the heart.

Consumption of Fluids.—*The American Grocer* has been collecting statistics concerning the home consumption of beverages, excepting water and soda-fountain products, for the year 1900. According to this authority, the amount spent was \$1,228,674,925, in the following proportions:

| | |
|----------------------------|-----------------|
| Alcoholic drinks | \$1,059,563,787 |
| Coffee | 125,798,530 |
| Tea | 37,312,608 |
| Cocoa | 6,000,000 |
| Total | \$1,228,674,925 |

The consumption of spirits per capita fell from 5.4 liters in 1891 to 4.8 liters in 1900; wine, from 1.7 to 1.5 liters; and beer increased from 57.9 to 60.6 liters. This indicates that, in general, the use of alcoholic beverages is not on the increase.

Condiments.—Condiments are substances added to food to increase its palatability and to stimulate the appetite. The principal condiments are vinegar and lime- and lemon-juice when acids are desired, and mustard and pepper. These substances play an important part in digestion and nutrition. Their principal hygienic interest is with regard to excessive usage. The excessive use of vinegar tends to produce a watery condition of the blood, and is therefore injurious. The excessive use of mustard and pepper produces overstimulation of the digestive function, and finally leads to irritation and inflammation of the mucous membrane of the gastrointestinal tract.

Adulterations of Food.—Adulterations of food are of two kinds, injurious and non-injurious to health. Those which are without injurious effect are the most numerous, yet they are of importance because of their fraudulent character. They are chiefly of two kinds, the substitution of an inferior grade and the substitution of inert foreign substances. They are of hygienic importance because the food so adulterated is of lower nutritive value, and may, therefore, lead to deficient nutrition. In this manner they may pave the way to disease by reducing

the natural resistance of the body. A large majority of this class of adulterants is used to increase bulk and weight, cheapen the article, and rob the consumer. Among the poisonous adulterants employed are those used to color and cheapen confectionery, liquors, and canned vegetables, and the various antiseptics employed to preserve food.

Milk is most frequently adulterated by the addition of water, and at times by the abstraction of some of the cream. Milk altered in this way is not directly injurious to health, as a rule, but may be indirectly injurious because of its altered nutritive character. This form of adulteration may also be directly injurious to health when the milk is diluted with polluted water. Milk is also adulterated by the addition of coloring-matter to conceal dilution with water and the abstraction of cream, as well as by the addition of various preservatives. The latter are all directly injurious to health when used for a considerable time.

Butter is usually adulterated by the addition of other animal and vegetable fats, or the entire substitution of these fats for the butter fats. While these fats are somewhat more difficult of digestion, they are perhaps not otherwise injurious to health. The custom of adding chemical preservatives to the milk supplied to creameries, as now practised by small farmers who store the milk for several days before delivering it, yields butter containing these preservatives. Such butter, when used constantly in large quantities, may prove injurious to health.

Tea is adulterated in different ways. It may be treated with different substances to impart a definite color to the leaves; it may be partly exhausted of its active principle and extractives; there may be a substitution of foreign leaves, such as those of the ash, willow, sloe, birch, hawthorn, raspberry, etc.; the addition of foreign astringents, as catechu; or the addition of different forms of mineral matter, as soapstone, gypsum, iron salts, copper, sand, etc.

Coffee is adulterated by the addition of coloring-matter, the addition and substitution of chicory, acorns, figs, leguminous seeds, and cereals. While these substitutes, or imitation coffees, are without detriment to health, they are distinct frauds, and are indirectly injurious when the stimulating influence of coffee is especially desired.

Cocoa is very commonly adulterated, and sugar and starch are most frequently employed for this purpose. The addition of these adulterants necessitates the addition of some coloring-matter to conceal their presence.

Lard is commonly adulterated by the addition and substitution of cottonseed oil; stearins derived from lard, beef fat, and cottonseed oil; and the fat of animals that have died of disease.

Canned vegetables are adulterated by the addition of salts of copper and zinc to give them a bright-green color. These salts are often present in sufficient quantities to be directly poisonous. Canned vegetables are also frequently adulterated by the addition of antiseptic substances to assist in preserving them. These substances are all more or less poisonous, especially when used for some time. Canned vegetables also frequently contain lead from the vessels containing them. In Germany the law requires that the tins employed to hold the canned good shall not contain more than 1 per cent. of lead. In this country there is no restriction, and as high as 12 per cent. of lead has been found.

Malt liquors are most frequently adulterated by the addition of preservatives, especially salicylic acid. The presence of salicylic acid in beer, for instance, cannot fail, in time, to give rise to disturbances of the health in those who take large quantities of it daily.

Mustard and *pepper* are frequently adulterated by the addition of flour, rice, corn, and ginger.

Vinegar is adulterated by the addition of the mineral acids and water.

In 1898 the General Assembly of Kentucky enacted a law providing for the inspection of food-products sold in

that State. During 1898 and 1899, 727 samples of food-products were collected, of which 290 were found to be adulterated. The inspectors state that "fully 40 per cent. of all samples of food taken have been found adulterated. Some of the adulterants used are injurious to health; others have been put in to cheapen articles of food." As examples of the former, the inspectors found so-called "fruit jellies" made wholly or in part of glue and artificial coloring- and flavoring-matters. They found salicylic acid, sometimes in large quantities, in tomato catsups, preserves, and other food-products which were sold as pure, and formaldehyd and other preservatives in milk. The most striking example of this form of adulteration was found in essence of peppermint and essence of cinnamon. These extracts both contained wood alcohol as one of the ingredients. These analyses indicate the great necessity of the systematic control of all food-products, in order to prevent fraud and injury from adulterations.

A committee of the United States Senate has investigated the extent of food adulterations in this country, and the disclosures made by eminent chemists show adulteration of a large number of food-products. Samples of coffee berries were submitted to the committee (which could not be distinguished from the genuine by casual examination), that were composed of clay; spices that were prepared from prune-stones and cocoanut-shells; mustard consisting principally of plaster-of-Paris; pepper which was 90 per cent. charcoal and sawdust; wheat flour which contained only a small percentage of residue of wheat; jellies made of glucose and starch colored and flavored artificially, and preserved with salicylic acid; and olive oil which contained less than 10 per cent. extract of olives, the principal ingredient being cottonseed oil. All of these samples had been purchased in the market. Other adulterations which these chemists frequently found were: Salicylic acid in beer; temperance drinks, such as raspberry soda, containing sufficient anilin dye in a glassful to color

a piece of flannel 12.5 centimeters (5 inches) square; and the extensive use of borax as a preservative for meat, poultry, and fish. While only a few of these adulterants are directly prejudicial to health, they are, however, gross frauds, and should be prohibited.

Dieteries.—The diet of different individuals is influenced by a great many conditions, such as the financial and social status, the age, sex, and state of health, the temperature and climate of the place, the amount of work performed, and the availability of different articles of food. Diet is also influenced to a great extent by the habits and idiosyncrasies of the individual. Moleschott's standard diet is generally considered to be a fair average diet for an adult man. According to De Chaumont, a certain definite proportion between the carbon and nitrogen ought to be maintained. This proportion should be nitrogen 1 to carbon 15.

Diet in Infancy.—The natural diet of infants for the first fifteen to eighteen months is the mother's milk. If this fails, it is necessary to substitute some artificial food. A good substitute for mother's milk is cows' milk. Since cows' milk is richer in proteid material and poorer in sugar than mother's milk, it is necessary to dilute the milk and at the same time sweeten it. The extent of the dilution of cows' milk required must be determined with regard to the purity and richness of the cows' milk, and, especially, with reference to the digestive powers of the infant. The milk of the goat, ass, and mare are also good substitutes for mother's milk. In some localities these are more easily obtained than cows' milk. All farinaceous foods should be avoided until the incisor teeth have made their appearance.

Diet in Childhood.—After the period of infancy the diet may be gradually varied by the addition of rice or arrowroot to the milk, and by supplying one soft-boiled egg daily, König gives the following as a complete daily diet for children of six to seven years of age: Meat (raw), 170 grams; bread, 300 grams; potatoes, 180 grams; fat (butter and lard), 15 grams; milk, 250 grams; flour,

for soup, 100 grams; vegetables (various), 180 grams; or a total of 1195 grams. This yields 78 grams of nitrogen, 43.3 grams of fat, and 281 grams of carbohydrates.

Subsistence Diet for Adults.—Playfair gives the diet sufficient for the internal mechanical work of the body as follows: Proteids, 57 grams; fat, 14 grams; carbohydrates, 340 grams; and salts, 14 grams; but it is doubtful if an average man could subsist on this diet without losing weight, as there is no allowance for any bodily exertion. When allowance is made for slight bodily exertion the amounts are as follows: Proteids, 71 grams; fats, 28 grams; carbohydrates, 340 grams; and salts, 14 grams. For moderate work (93 kilogram-meters), Moleschott gives the following amounts for a man of 68 kilograms: Proteids, 130 grams; fats, 84 grams; carbohydrates, 404 grams; and salts, 30 grams. For a man performing very laborious work, or for a soldier in the field, the amounts should be: Proteids, 170 to 198 grams; fats, 99 to 128; carbohydrates, 454 to 510 grams; and salts, 34 to 43 grams.

A balanced ration is a diet in which the ingesta are just equal to the excreta. As an instance of complete equilibrium in a man weighing 70 kilograms, embracing both the nitrogen and carbon of the ingesta and excreta, the following balance table may be given (Burdon-Sanderson):

| INCOMINGS. | | | OUTGOINGS. | | |
|------------------------|------|------|-----------------------|------|--------|
| Food. | N. | C. | Excreta. | N. | C. |
| 100 gm. proteids . . . | 15.5 | 53. | Urine | 14.4 | 6.16 |
| 100 gm. fat | . . | 79. | Feces | 1.1 | 10.84 |
| 250 gm. carbohydrates | . . | 93. | Respiration | . . | 208.00 |
| | 15.5 | 225. | | 15.5 | 225. |

The following is an instance of a balance table (Neumeister) of a man weighing 70 kilograms, showing nitrogenous equilibrium only, some of the carbon of the ingesta (mostly representing stored fat) not reappearing in the excreta:

| INCOMINGS. | | | OUTGOINGS. | | |
|------------------------|-------|---------|-----------------------|-------|-------|
| Food. | N. | C. | Excreta. | N. | C. |
| 137 gm. proteids . . . | 19.5 | } 315.5 | Urine | 17.4 | 12.6 |
| 117 gm. fat | . . . | | Feces | 2.1 | 14.5 |
| 352 gm. carbohydrates | . . . | | Respiration | . . . | 248.6 |
| | 19.5 | 315.5 | | 19.5 | 275.7 |

It has been found that, although work can be done on a non-nitrogenous diet, it does not follow that nitrogen is unnecessary. Experience has shown that nitrogen must be supplied when work is done, and that the amount must increase with the amount of work done. When no nitrogen is ingested the body uses some of its own nitrogen, and becomes fatigued after a small amount of work is performed.

Diet for Old Age.—König gives the minimum diet for an old man as follows: Proteids, 100 grams; fats, 68 grams; and carbohydrates, 350 grams. For an old woman he gives the following amounts: Proteids, 80 grams; fats, 50 grams; and carbohydrates, 260 grams. The food of the aged should be easily digested. With decreased physical energy the digestive powers are also lowered, and hence the nature of the food has to be regulated. Over-indulgence is especially to be avoided in the aged. Milk, grains, and fruit are well adapted for aged persons.

In an article on "Vegetarianism," A. Schoenstadt¹ states that: "There are two parties among vegetarians—the one excludes all animal nutritive materials of whatever nature, and the radical adherents live on only a few vegetables, namely, cereals, fruit, baked food, and water. The other party uses, besides vegetable food, also animal food materials which are obtained without killing the animals, as eggs, milk, cheese, butter, honey. This is really not vegetarianism, but a mixed diet."

Schoenstadt believes that it is possible to subsist on a purely vegetable diet, but states that it is not sufficient

¹ *Deutsch. Vierteljahr. f. öffentl. Gesundheitspflege*, Bd. xxxii., S. 597.

nor natural for man. He is of opinion that there is great danger connected with a vegetable diet:

a. Because the nutritive materials supplied are insufficient to meet the requirements of the organism.

b. Because this diet leads to grave digestive disturbances.

He regards this diet as insufficient for the inmates of institutions and prisons.

Influence of Insufficient Food.—Deficiency in proteid materials in the dietary is attended with lessened activity and a general lowering of the vitality of the body. This adynamic condition favors the contraction of specific diseases. The omission of fats from the dietary results in illness in a few days. The body is unable to make up its carbon deficit from the other food-substances. Starch can be omitted from the dietary for a long time without detriment if fat is given. Deficiency in salts in the dietary is attended by malnutrition and a disorganized condition of the blood.

A form of deficient nutrition which was formerly quite common, and is still seen at times, is known as scurvy. This condition is brought about by a deficiency of fresh vegetables and fresh fruits, and sometimes to deficiency in fresh meats. It appears to be due to the absence from the dietary of certain organic acids and their salts.

Influence of Excessive Amounts of Food.—When much larger amounts of food are taken than can be utilized by the body the effects are manifested in dyspepsia, diarrhea, and gastro-intestinal irritation. Gout is a condition of the system in which the function of the liver and kidneys is disturbed because of long-continued efforts at eliminating excessive amounts of proteid materials ingested into the system. Excessive amounts of proteid material with deficient fat lead to wasting of the body-fat. Excessive amounts of fat and starch in the food lead to corpulency and disordered function of the digestive organs.

CHAPTER VIII.

EXERCISE.

IN order to maintain a perfect state of health of the body it is essential that each organ has a certain amount of exercise. All the bodily functions are attended with rhythmic motion, and these movements are facilitated by exercise. If there is deficient exercise of a portion of the body, continued for some time, the nutrition of this portion is impaired, the organs or members involved decrease in size and eventually degenerate in structure as well as in function. Overexertion of a portion of the body leads to abnormal nutrition and development of the organs or members involved, and if continued for some time degeneration may occur, which is as great as that resulting from disuse of the organs. It is essential, therefore, that the exercise is as uniform as possible for all the organs and members of the body so as to avoid over- or under-stimulation of any of its parts. Perfect health is dependent upon the uniform stimulation of all the functions, so that all the organs may be in a condition to act in their natural way and normal capacity.

The amount of energy expended in walking on a level is usually assumed to equal that required to lift one-twentieth of the body-weight through the distance walked. The most important effect of muscular exercise of any kind is produced on the lungs and circulation.

Effect on the Lungs.—Smith has found the effect of exercise on the amount of air respired, to vary in direct proportion with the amount of exertion. Taking the recumbent position as unity, he found the amounts of air inspired as follows:

| | | | |
|-------------------------------------|------|-----------------------------------|------|
| Recumbent position | 1.00 | Walking and carrying 28.5 kg. . . | 3.84 |
| Sitting | 1.18 | Walking and carrying 53.5 kg. . . | 4.75 |
| Standing | 1.33 | Walking 4 miles per hour . . . | 5.00 |
| Singing | 1.26 | Walking 6 miles per hour . . . | 7.00 |
| Walking 1 mile per hour | 1.90 | Riding and trotting | 4.05 |
| Walking 2 miles per hour | 2.76 | Swimming | 4.33 |
| Walking 3 miles per hour | 3.23 | Treadmill | 5.50 |
| Walking and carrying 15 kg. | 3.50 | | |

Under ordinary circumstances a man inspires 8.5 liters of air per minute; if he walks 6½ kilometers, or 4 miles, per hour he inspires (8.5 × 4 =) 34 liters; if he walks 9½ kilometers, or 6 miles per hour he inspires (8.5 × 6 =) 51 liters. With increased amount of work there is an increased amount of carbon dioxid exhaled. The relative amount of carbon dioxid exhaled is greater, the larger the amount of work performed, on account of the increased oxidation because of the muscular exertion. Pettenkofer and Voit found the relative amounts of oxygen absorbed, and of carbon dioxid, water, and urea eliminated in rest and while at work to be as follows:

| Weight of man experimented upon = 60 kilograms. | Absorption of oxygen in grams. | Elimination in grams of— | | |
|--|--------------------------------------|--------------------------|--------|-------|
| | | Carbon dioxid. | Water. | Urea. |
| Rest | 708.9 | 911.5 | 828.0 | 37.2 |
| Work | 954.5 | 1284.2 | 2042.1 | 37.0 |
| Excess and deficiency during work | 245.6 | 372.7 | 1214.1 | 0.2 |

The increased amount of carbon dioxid eliminated during exercise indicates the necessity of an increased amount of carbon in the food of persons performing work requiring much muscular effort. This increased amount of carbon is best given in the form of fats, rather than in the form of starches. The increased elimination of water calls for an increased supply of water with the food, and especially as drink. It is preferable to take this in the form of plain water. Alcoholic beverages decrease the elimination of carbon dioxid by the lungs, and are therefore contraindicated

during muscular exercise. For this reason all alcoholic beverages are prohibited for athletes while in training.

Effect on the Circulation.—The first effect of exercise is to increase the rapidity and force of the heart action, causing increased blood-supply to the muscles, as well as to all the organs. Excessive exercise, when continued for some time, leads to irregular action of the heart, accompanied by great rapidity and disturbance of its rhythmic action. Such a condition is highly injurious, and calls for prompt cessation of the exercise.

Long-continued strenuous labor, or excessive exercise, leads to hypertrophy of the heart-muscle and increased caliber of the heart cavities. Such a condition, when once established, remains permanent. This condition is quite common in laborers who have performed unusually hard work for some years, in soldiers who have been obliged to take very long and forced marches, and in athletes who have been in hard training for some time.

On the other hand, deficient exercise leads to degeneration of the heart-muscle, weakening of the heart action and of the general circulation. In this condition there may be dilatation of the heart cavities without compensatory hypertrophy; unusual deposition of fat on the outside of the heart, and even between the muscular bundles; and fatty degeneration of the heart-muscle.

In beginning athletic training the heart action should be carefully noted in order to determine whether it is properly accommodating itself to the increased demands made upon it by the muscular exercise, as well as the manner in which it behaves during the period of rest after the exercise. After exercise the heart action gradually slows down and falls slightly below the normal. The extent to which the heart action falls below the normal indicates the amount of fatigue produced, as well as the compensating power of the heart.

With proper care, in healthy subjects, there is no great danger from athletic training. The amount of exercise taken should be gradually increased as the compensating

power of the heart increases with the demands made upon it. The athletic training should not be suddenly relinquished. The work should be lessened gradually, in order to allow the heart to accustom itself gradually to the decreased demands of everyday life.

Effect on the Muscles.—The result of repeated contraction and relaxation of any group of muscles is to cause an increase in the muscular fibers, with increased firmness and more active response to the will-power. The extent of growth is limited, however, and when the stimulation is long continued, or excessive, degenerative processes set in. Under such conditions the muscles become soft and flabby, and respond imperfectly and feebly to the will. During exercise there is increased temperature in the muscles, dependent to some extent upon the amount of work performed. There is an increased amount of carbon dioxid formed in the muscles as the result of the increased oxidation.

All the muscles of the body should be exercised as uniformly as possible. There is less likelihood of muscular degeneration, in certain groups of muscles, when the entire muscular system is required to do a certain amount of work. In training for any particular kind of athletic contest, in which certain groups of muscles are specially called into action, it is best to vary the exercise continually so as to keep all the muscles fully developed. For this purpose the training should be so conducted as to allow a period of rest to follow the special exercise, and then, before resuming the training, a short period of exercise in the gymnasium, or some simple athletic game, is advisable.

Fatigue.—As the result of muscular exercise there is a feeling of exhaustion and fatigue, amounting sometimes to actual pain in the tired muscles. This condition is brought about by the accumulation in the muscles of the products of their activity, especially paralactic acid, and to deficiency of oxygen. During the period of rest the accumulated products are eliminated and the supply

of oxygen is renewed. There is also a deficiency of water in the system as the result of excessive elimination, and this must be replaced. Since the bodily functions require the presence of a considerable amount of water in the system, it seems essential that during exercise the loss of water should be compensated by the administration of small amounts of water at short intervals. The fatigue of the muscular system can only be relieved by a period of rest. The heart-muscle, under ordinary work, has a rest between the contractions, which is about twice as long as the time consumed by the contractions, and hence it requires no additional rest to recover itself.

Effect on the Nervous System.—The effect of exercise on the nervous system is more indirect than direct in its nature. Moderate exercise assists in maintaining all the bodily functions in their normal condition, and hence the nervous system is in a position to act most efficiently. This fact has had abundant demonstration in recent years since athletic sports have become such an important feature in college life. It has been found that, as a rule, the best athletes are rather above the average in their class records.

Overtraining is of course detrimental to the nervous system, because it undermines the general health. The effect of active exercise upon the mental activity is dependent to a certain extent upon individual conditions; but, as a rule, it is believed to be perfectly allowable in students that are able to keep up with the majority of their class. It is better to attain somewhat lower averages in class standing than to risk a breaking down of the nervous system as the result of overstudy or injury of the general health, because of too close application to study.

Effect on the Elimination of Nitrogen.—A large number of experiments have been made to determine the relative amounts of nitrogen eliminated during rest and exercise. The results obtained indicate that during exercise the amount of nitrogen assimilated is increased per-

ceptibly. The metabolism of nitrogen is influenced somewhat by the period of work and rest, and the severity of the work performed. During a period of active exercise the amount of nitrogen eliminated from the kidneys is slightly diminished, and after the exercise there is a slight excess of nitrogen excreted, continuing for some time. During severe exercise the amount of nitrogen eliminated appears to be increased. Voit and Krummacher are of the opinion that usually work does not directly produce a greater breaking down of proteid matter, but that an increase in the proteid cleavage is caused by the increased combustion of the nitrogen-free materials which protect the proteid matter. If it were possible, during the period of work, to supply the cells continuously with a sufficient amount of nitrogen-free material, then there would be no increase in the quantity of proteid material broken down. But this is a very difficult matter. Krummacher believes that the after-effect of muscular labor is not due to the continued excretion of nitrogenous cleavage-products, but to the fact that the nitrogen-free materials in the body were used up, and that it takes some time to provide the body with a new supply. In active exercise, therefore, an increased amount of nitrogen must be supplied in the food, as well as an increased amount of carbon. There must also be an increased supply of salts, especially sodium chlorid and potassium phosphate, to supply the loss in these salts during exercise.

Amount of Exercise that Should be Taken.—A good day's work for an average man is considered to be 150,000 kilogram-meters. Haughton has shown that walking on a level surface at the rate of 3 miles (4.8 kilometers) per hour is about equal to raising one-twentieth of the weight of the body through the distance walked.

In order to determine the work performed in walking 32,000 meters per day, we multiply the weight of the body in kilograms by the distance travelled, the result being the kilogram-meters of work performed. If a

pedestrian walks 32,000 meters a day, without a load, the energy expended, assuming him to weigh 70 kilograms, is $32,000 \times 70 = 2,240,000$ kilogram-meters. Houghton divides the work performed into "fatigue work," the effort necessary to carry the weight of the body, and "useful work," the energy expended in performing labor. For instance, Coulomb observed that the work done by porters employed to carry goods 2000 meters, returning unloaded, amounted to 348 kilograms in six journeys, or 58 kilograms at a time. The useful work performed was, therefore, $2000 \times 348 = 696,000$ kilogram-meters; the fatigue work was $2000 \times 2 \times 70 \times 6 = 1,680,000$ kilogram-meters. This allows 70 kilograms as the weight of the porter, and takes into consideration that the body is carried in both directions, or 4000 meters. The total energy expended was 2,376,000 kilogram-meters. He also found that pedlars, who always travelled loaded with their packs, were able, with a load of 44 kilograms, to travel 19,000 meters per day. Assuming their weight of 70 kilograms, we find—

$$\begin{aligned} 19,000 \times 44 &= 836,000 \text{ kilogram-meters} = \text{useful work.} \\ 19,000 \times 70 &= 1,330,000 \text{ kilogram-meters} = \text{fatigue work.} \\ \text{Total} &= 2,166,000 \text{ kilogram-meters.} \end{aligned}$$

The energy expended under the foregoing conditions was, then,

| | | |
|---|-----------|------------------|
| Man walking without a load | 2,240,000 | kilogram-meters. |
| Man alternately loaded and unloaded | 2,376,000 | " |
| Man loaded all day | 2,166,000 | " |

In athletic exercises it is essential that the amount of energy expended be carefully determined, in order to ascertain whether the exercise is likely to prove beneficial or otherwise. The amount of energy expended in athletic sports should not exceed that expended by laborers in hard manual labor. In athletic contests, of course, the energy expended is often in excess of this amount; but a period of comparative rest must follow the contest, in order to allow the body to recuperate from the fatigue

induced by the contest. The harmful effects of the large amount of energy expended in some athletic contests is frequently seen when these contests take place at too short intervals, allowing insufficient time for the contestants to recover from the fatigue of the previous contest. The same effects are also noted in soldiers who are compelled to make frequent forced marches over long distances.

From what has been learned of the effects of exercise, it will be seen that athletic training should aim to increase the breathing-power; to strengthen the power of the heart's action; to make the muscular action more vigorous and enduring; and to decrease the amount of fat. These results are obtained by careful dieting; by regular and systematic exercise; and by increasing the action of the eliminating organs, especially the skin.

CHAPTER IX.

CLOTHING.

THE function of clothing is to protect against the weather—heat, cold, and dampness—and to protect against injury. All other uses of clothing have no direct hygienic interest, only indirectly in so far as they may be injurious to health.

Protection against Cold.—The most important use of clothing in cold climates is to protect against cold. Clothing serves this purpose by diminishing the radiation of heat from the body. The radiation of heat from the body diminishes with the number of layers of clothing worn, and is also dependent upon the nature of the clothing worn. If we take the amount of radiation of heat from the naked body as 100, the radiation is reduced to 73 by means of a woollen shirt; to 60 by means of both a woollen and a linen shirt; to 46 by means of a woollen and a linen shirt and a vest; to 33 by the addition of a coat. Rubner found that if the radiation at 15° C. is taken as 100, at 23° C. it is only 69, at 29° C. it is 56, and at 32° C. it is 31.

The radiation of heat is directly dependent upon the thickness of the layer of clothing. If we take the loss of heat as 100, a thickness of 1 millimeter of cotton allows a radiation of 77 per cent.; 2 millimeters, of 68 per cent.; 3 millimeters, of 65 per cent.; 4 millimeters, of 57 per cent.; 5 millimeters, of 53 per cent.; 10 millimeters, of 41 per cent.; 15 millimeters, of 30 per cent.

The thickness of clothing, in our climate, must not be so great as to increase perceptibly the air-pressure by compression, nor so thin as to decrease perceptibly the air-pressure. The thickness of the clothing is, therefore,

one of the most important features. The radiation of heat from the body is very nearly the same whatever the nature of the clothing. Wool, silk, and cotton are equally warm when thickness of the layer is the same. The most rational clothing, however, is that which conserves the heat of the body with the least quantity of material. Flannel would be the lightest and warmest; but, since it wears so rapidly, woollen cloth is more serviceable, because it wears better. The smoothly woven cloths are not so warm as the tricot cloths, but they are more serviceable.

The clothing should not only be light, but it should functionate well with regard to the absorption of moisture from the skin. It should take up the moisture as readily as possible, and should quickly dry out. For this reason the clothing worn next the body should be porous, so that all the pores may not be filled with perspiration. Closely woven goods is not adapted for this purpose. Some authorities claim that linen, of coarse mesh, is best adapted for this purpose because it does not retain the moisture as long as wool.

Protection against Heat.—The degree of porosity is an important feature in summer clothing. The color of summer clothing is also important. Dark clothing absorbs heat to some extent, and in consequence it is somewhat warmer than white fabrics or those of lighter colors. The degree of porosity is, however, the most important factor, because on this property depends the interchange of air through the skin. The effect of the direct radiation of heat from the sun may be inhibited in part by a proper covering of the head. For this purpose straw hats with broad brims are most serviceable. They shade the head and face, and allow free ventilation of the scalp, with a layer of air between the head and the covering. This is important, because air is a poor conductor of heat.

Protection against Dampness. — During rainy weather the use of some impervious material serves to exclude the dampness from the body and clothing. Damp

clothing is injurious not only because it is liable to produce chill, but because it prevents the free evaporation of heat and moisture from the surface of the body. The importance of keeping the clothing dry in rainy weather is therefore self-evident.

Protection against Injury.—Clothing protects the body against mechanical injury, from frost, or from the direct rays of the sun. Among civilized peoples protection of the feet is also necessary to avoid injury or annoyance in walking over rough ground. The sole of the shoe should conform to the shape of the foot. This

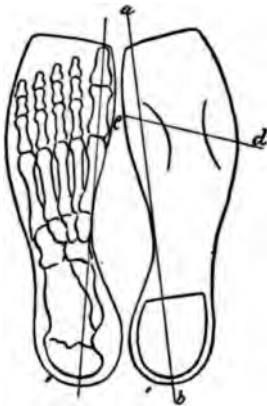

FIG. 46.—Correct sole (Hueppe).

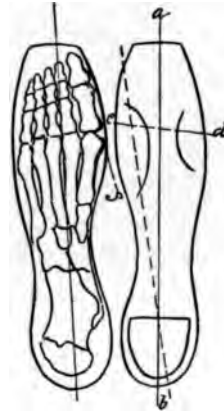

FIG. 47.—Shoemaker's sole (Hueppe).

is of the greatest importance. The length of the sole is the so-called Meyer line (Fig. 46, *ab*), which extends from the middle of the heel through the middle of the great toe, and lies parallel with the inner border of the anterior half of the foot. The breadth of the sole is indicated by the Starck line (Fig. 46, *cd*), which extends diagonally from the head of the first metatarsal bone to form the letter V. The shoemaker's sole is usually cut so that the shoe is symmetrically divided right and left by a line extending through the middle, and which commonly corresponds to the anatomical axis (Fig. 47). As the result

of wearing shoes with soles of this pattern we have subluxations of the great toe at *s*, whereby the latter is



FIG. 48.—Normal feet (Whitman).



FIG. 49.—Proper soles for normal feet (Whitman).

forced outward and increases the prominence of the ball of the great toe. This decreases the room for the other



FIG. 50.—Deformed feet (Whitman).



FIG. 51.—Shoemakers' soles (Whitman).

toes, and, in consequence, these are superimposed upon each other, instead of lying side by side.

Figs. 48, 49, 50, and 51 also give the outlines of

normal feet and the manner in which these normal outlines are deformed by the universal soles of the shoemaker. It will be seen that the shoemakers' soles, as figured by Whitman, in no way conform to the outlines of normal feet.

The heels should be low, broad, and long, so as to afford proper support to the body. High heels are especially injurious, because they place the larger part of the weight of the body on the ball of the foot. The shoes should not be so tight as to compress the feet. Laced shoes are the most rational, because they can be fastened to the feet in such a manner as to allow the least amount of friction. Rubber shoes should be worn only for a short time during wet weather, and should be removed as soon as they are not needed.

Injurious Effects of Clothing.—The clothing should be of such a pattern as to conform to the natural shape of the body without constricting or compressing any portion thereof. With regard to the covering of the feet, this point has already been discussed. Above all, there should be no constriction of the chest and abdomen. The abdominal organs and the lungs and heart should be as free to act as possible. The clothing worn by men is quite rational with this respect, but that worn by women, in general, is most irrational. The wearing of corsets is highly injurious, as has been frequently proved, and it is unnecessary to adduce facts to prove the statement. Corsets compress the chest and abdomen, thus impeding respiration and the movements of the heart. The abdominal organs and muscles are also compressed and correspondingly deformed and interfered with in their normal functions. The use of tight garters is also injurious. The clothing of women should be suspended from the shoulders, and not from the hips, in order to diffuse the weight more evenly.

The wearing of heavy head-coverings is also injurious, because it places a constant weight upon the spinal column. The use of veils is especially injurious, because

of the obstructed vision which they induce. The combination head-covering worn by women in mourning is injurious, and frequently leads to persistent nervous trouble, as well as to general fatigue from its weight. It is not unusual to see spinal curvature follow prolonged wearing of the head-covering fashionable in mourning.

Reforms in dress are quite difficult to bring into effect, especially if they are opposed by ancient custom as well as by modern fashion. As long as a form of dress is fashionable it is difficult to induce any one to relinquish it, no matter how injurious it may be or how desirable the change from a hygienic point of view.

Cleanliness in Relation to Clothing.—The excretions of the body through the skin are absorbed by the clothing, and consequently frequent changes should be made to prevent injurious effects from the accumulation of these products in the clothing. The excretions of the body fill the pores of the clothing and render it more impervious, and therefore less suited for the interchange of air. This is especially the case in those engaged in laborious work, where the amount of perspiration is great.

Starching and ironing tend to close the pores in clothing and render it more impervious. The wearing of unstarched clothing in hot weather is, therefore, more comfortable. In winter starching and ironing serve to conserve the heat of the body.

The amount of clothing worn must be varied with the season of the year and the sensations of each individual. The amount of clothing necessary to conserve the heat of the body of one person may be entirely too light or too heavy for another. The changes from lighter to heavier clothing, and *vice versa*, should not be made too suddenly. In localities where there is a variable climate, with frequent changes in the temperature and humidity of the atmosphere, as is the case in the northern States during spring and autumn, the change from heavy to light clothing, and *vice versa*, must be made with great

circumspection, in order to prevent the development of catarrhal diseases. The changes must be made according to the idiosyncrasies of the individual and the season of the year. The change can never be regulated by the calendar, because the conditions vary perceptibly from year to year. The time of the year when the changes may be made with safety must frequently become a question for the physician to decide for those under his care, because of his larger experience in questions of this nature on account of prolonged observation and study.

Infected Clothes and Bedding.—Viola and Morella have recently published the following conclusions, based upon their experiments :

Clothing, linen, and other garments are capable of holding a relatively large number of micro-organisms, varying from 915 to 571,962 for each square centimeter of goods. While the greater part of these bacteria are saprophytic, pathogenic germs are also found. The number of bacteria found in garments in actual contact with the human body is in direct ratio to the number of days the garments are worn. In general, the number of bacteria found in clothing of a person is proportional to the activity of his occupation. Wool has a greater capacity for germs than cotton or silk. Corresponding to the local bacteriologic flora of the surface of the human body, there is a quantitative difference in the bacterial contents of clothing covering different parts of the skin. In clothing actually being worn, pathogenic bacteria live a shorter time than in the same garments hanging in a wardrobe. Under all conditions pathogenic bacteria contained in clothing gradually die out. There is, with the passage of time, a gradual diminution in the number of disease-producing germs with which a given article of clothing has been contaminated. There is also a progressive decline in the power of development of bacteria, as they undergo a gradual diminution in virulence. The authors conclude that garments are a potent means for

the diffusion of infectious agents, and that without special treatment pathogenic germs can retain their virulence in human raiment for a considerable but not indefinite period.

CHAPTER X.

PERSONAL HYGIENE.

PERFECT health is dependent upon the normal activity of all the organs of the body. The organic functions of the body can be maintained in their normal condition only by observing all the general hygienic rules and regulations. These principles, while they are well recognized and of the utmost general value, cannot, however, be stated in very specific terms when applied to individual conditions, because the individual idiosyncrasies of different persons vary to such a great extent.

There must be continuous moderation in **diet**, both with regard to quality and quantity. The individual peculiarities as produced by inherited and acquired instincts influence the quality and quantity of food that are most suitable. The nature and amount of work performed is also an important factor in the matter of diet. So also are the temperature, latitude, and altitude of a locality, and the amount and nature of the clothing worn. Individual experience, therefore, plays a most important part in governing the diet of each person. The point to be borne in mind is that all excesses should be avoided. No more should be taken than the system demands and can conveniently utilize. If this point is properly regulated, one of the principal factors in the production of disease is eliminated. The food taken should be slowly and thoroughly masticated. This will favor the admixture of a plentiful supply of saliva, and will also facilitate the subsequent steps in the process of digestion. Proper mastication of the food cannot take place without sound teeth. Defective teeth frequently lie at the foundation of various affections of the stomach.

The supply of nitrogenous and carbonaceous foods should be regulated according to the demands of the body. If there is a deficiency of fatty deposit, the supply of carbohydrates is probably insufficient; on the other hand, if there is an excess of fatty deposit, the supply of fats and carbohydrates is excessive. These are points that can be regulated by each individual, to a certain extent, though it must be remembered that some persons are normally fatter or thinner than others.

Cleanliness is one of the most important factors in the preservation of health. This applies not only to cleanliness of the body, but to cleanliness in every particular of life. It goes without saying that cleanliness of body, clothing, and habitation are essential to good health. The number of baths taken, and the kind of bath, is a matter that is governed by individual conditions, such as habit, amount and character of the work performed, and the temperature of the locality.

Regular attention to **the bowels** is an important matter in regulating the health. The number of movements a day will be regulated by the diet and habit of each individual, though it is generally conceded that one movement a day is desirable in order to maintain the efficiency of the digestive apparatus.

The regulation of **the passions** is another matter for individual control, though all excesses should be avoided. The practice of vices is to be condemned in the most forcible manner because of the detrimental influence upon the nervous system and the entire organism. Parkes states that "we know that a widespread profligacy has eaten away the vigor of nations, and caused the downfall of nations; but we hardly recognize that, in a less degree, the same causes are active among us, and never realize what a State might be if its citizens were temperate in all things."

Cleanliness of **the mouth and teeth** is of the greatest importance. Proper care of the teeth, including systematic cleansing, will go far to preserve them in a

sound condition. This will also serve to prevent the accumulation of decaying food particles around the teeth and gums, and thus prevent the decay of the teeth and disease of the gums and of the mucous membrane of the mouth and throat. A decaying tooth should be filled as early as possible, in order to preserve it and to prevent more serious disease of the maxillary bone.

Great care should be exercised in the selection of a **habitation**. The nature of the water-supply is an important factor in the preservation of health. If the purity of the water-supply is doubtful, it will be the wisest course to have all the water boiled. The nature of the soil is also an important factor. Damp soils, as well as recently made soils, should be avoided, because they may prove injurious to health. The material used in constructing the house is of importance, as well as the position of the house with reference to the points of the compass. A southern exposure is usually preferable to a northern exposure. The number and arrangement of the windows should be considered. There should be plenty of light and free access of air. Sunlight is the great restorer and purifier, and it should be freely admitted to all houses when the temperature will permit.

The nature of the **occupation** and its influence upon health should be carefully considered. If the occupation selected should prove detrimental to health, it should be discarded for one that is less likely to operate in the same manner. If a sedentary occupation proves harmful, it should give way to another involving much outdoor activity. The amount of mental work that may be performed without injuring the health will depend upon the individual constitution. A sedentary occupation may be prevented from injuring the health by the employment of systematic exercise of some form or another. Whenever possible the occupation, as well as the bodily exercise, should be of a cheerful nature. The exercise indulged in may often be made most beneficial by taking it in conjunction with other persons. For this reason the

different athletic sports are of such great benefit. If outdoor exercise be taken, it may be made profitable as well as pleasurable by combining it with nature studies. Under such conditions the exercise is not so likely to become burdensome, because one loses sight of the feeling of compulsion.

The **mental attitude** of the individual is also an important factor in preserving health. Hopefulness and cheerfulness are great aids to health because of their beneficial influence on digestion. The mental condition is largely under the control of the will-power, and each individual is hopeful and cheerful or morose and despondent as he wills to be.

The regulation of work, rest, sleep, and meals is more or less under individual control. The amount of sleep required for perfect refreshment varies with the individual. It is usually greater in childhood and old age than in the prime of life. The amount of sleep taken in order to preserve the health should be sufficient to prevent, if possible, a feeling of sleepiness during the day. It is generally conceded that the most refreshing sleep is obtained in the early hours of the night, though some persons can accustom themselves to sleep soundly during any portion of the twenty-four hours. It is possible to deprive one's self of sleep for a considerable time, but eventually the effects will be felt in loss of nervous power. This is especially the case with those engaged in mental work. Sooner or later a period of insomnia supervenes which is not easily overcome.

CHAPTER XI.

INDUSTRIAL HYGIENE.

THE influence of occupation upon the health of laborers is a subject of the greatest hygienic importance. Certain occupations are far more dangerous than others because of the liability to accident; some occupations are more dangerous than others because of poisonous fumes and gases that are given off in certain manufacturing processes; again, other occupations are dangerous to health because of various kinds of dusts that are produced, thus leading to irritation of the respiratory organs. In other occupations certain groups of muscles and certain organs of the body are used excessively, thus leading to defects in these organs; while in others a constrained attitude is maintained while at work, or a sedentary life is induced, which may be the cause of ill health.

The occupations which are directly concerned in the production of disease are those in which irritating or poisonous gases are produced, such as sulphurous, nitric, and hydrochloric acid fumes; ammonia, chlorin, carbon monoxid and dioxid, hydrogen sulphid and carbon disulphid, iodin, bromin, and phosphorus vapors; turpentine and petroleum vapors; mercury, arsenic, lead, zinc, and copper poisoning; aniline vapors; those in which irritating or poisonous dusts are produced, such as coal-dust, metallic dust of various kinds, mineral dust, and vegetable dust; those in which there is local absorption of irritating or poisonous substances, such as arsenic, phosphorus, quinin, potassium bichromate, strong alkalis, and petroleum; those in which there is an elevated or variable temperature and atmospheric pressure.

Analyses of the deaths occurring in the different

occupations have given us a knowledge of the relative degree of danger from different forms of industrial pursuits. Such an analysis has been made of all the deaths occurring in Massachusetts, including all persons over twenty years of age, from May 1, 1843, to December 31, 1885, by the registration bureau of that State. The following table gives the detailed results of this analysis. The total number of deaths was 229,897, and the average age at death 51.82 years :

| OCCUPATIONS. | Number of persons. | Average age at death. | OCCUPATIONS. | Number of persons. | Average age at death. |
|---|--------------------|-----------------------|--|--------------------|-----------------------|
| Class I. Cultivators of the earth: Farmers, gardeners, etc. | 46,182 | 66.29 | Paper-makers | 463 | 48.65 |
| Class II. Active mechanics abroad. | 17,371 | 51.34 | Piano-forte makers | 210 | 48.30 |
| Brickmakers | 159 | 49.71 | Plumbers | 303 | 36.34 |
| Carpenters and joiners | 9,761 | 55.06 | Potters | 65 | 58.02 |
| Calkers and gravers | 281 | 58.91 | Pump- and block-makers | 124 | 58.23 |
| Masons | 2,889 | 53.33 | Reed-makers | 18 | 45.94 |
| Millwrights | 188 | 60.43 | Rope-makers | 371 | 60.01 |
| Riggers | 237 | 55.54 | Tallow-chandlers | 115 | 56.75 |
| Ship-carpenters | 1,305 | 61.36 | Tin-smiths | 640 | 42.95 |
| Slaters | 159 | 41.69 | Trunk-makers | 78 | 40.38 |
| Stone-cutters | 1,678 | 41.22 | Upholsterers | 287 | 40.98 |
| Tanners | 714 | 52.73 | Weavers | 971 | 44.65 |
| Class III. Active mechanics in shops. | 28,208 | 48.80 | Wheelwrights | 738 | 59.50 |
| Bakers | 751 | 49.16 | Wood-turners | 154 | 49.54 |
| Blacksmiths | 3,615 | 55.11 | Mechanics (trade not specified). | 3,369 | 47.35 |
| Brewers | 63 | 45.14 | Class IV. Inactive mechanics in shops. | 28,459 | 45.43 |
| Cabinet-makers | 1,250 | 50.66 | Barbers | 772 | 39.34 |
| Calico-printers | 16 | 58.87 | Basket-makers | 109 | 60.32 |
| Cord-makers | 52 | 50.42 | Book-binders | 258 | 43.56 |
| Carriage-makers and trimmers. | 479 | 51.87 | Brush-makers | 96 | 47.36 |
| Chair-makers | 234 | 46.49 | Carvers | 141 | 37.60 |
| Clothiers | 119 | 57.25 | Cigar-makers | 36 | 39.78 |
| Confectioners | 171 | 45.37 | Clock- and watch-makers | 205 | 51.47 |
| Cooks | 243 | 40.87 | Comb-makers | 222 | 54.09 |
| Coopers | 1,299 | 59.88 | Engravers | 200 | 39.74 |
| Coppersmiths | 150 | 46.09 | Glass-cutters | 124 | 44.40 |
| Carriers | 951 | 45.79 | Harness-makers | 676 | 50.00 |
| Cutlers | 218 | 42.01 | Jewellers | 782 | 41.62 |
| Distillers | 36 | 58.78 | Operatives | 4,662 | 41.28 |
| Dyers | 269 | 48.65 | Printers | 1,243 | 40.58 |
| Founders | 764 | 44.82 | Sail-makers | 310 | 55.17 |
| Furnace-men | 175 | 46.28 | Shoe-cutters | 795 | 47.06 |
| Glassblowers and glass-makers. | 202 | 41.61 | Shoe-makers | 14,802 | 46.34 |
| Gunsmiths | 306 | 50.35 | Silversmiths or goldsmiths. | 140 | 48.59 |
| Hatters | 539 | 34.55 | Tailors | 2,174 | 50.19 |
| Leather-dressers | 354 | 46.88 | Tobacconists | 61 | 50.41 |
| Machinists | 3,761 | 43.47 | Whip-makers | 143 | 44.50 |
| Millers | 386 | 58.69 | Wool-sorters | 238 | 46.92 |
| Musical instrument makers. | 61 | 49.25 | Class V. No special trades. | 43,716 | 49.06 |
| Nail-makers | 279 | 45.75 | Laborers | 42,532 | 49.16 |
| Pail- and tub-makers | 7 | 41.86 | Servants | 624 | 39.15 |
| Painters | 3,561 | 45.77 | Stewards | 123 | 54.07 |
| | | | Watchmen | 410 | 53.13 |
| | | | Workmen in powder-mills. | 27 | 37.41 |

| OCCUPATIONS. | Number of persons. | Average age at death. | OCCUPATIONS. | Number of persons. | Average age at death. |
|---|--------------------|-----------------------|--|--------------------|-----------------------|
| Class VI. Factors, laboring abroad, etc. } | 10,776 | 39.36 | Merchants | 6,200 | 56.45 |
| Baggage-masters | 72 | 36.25 | Newdealers or carriers | 76 | 43.78 |
| Brakemen | 509 | 27.12 | Railroad agents or conductors | 561 | 41.28 |
| Butchers | 888 | 50.50 | Saloon- and restaurant-keepers | 832 | 40.70 |
| Chimney-sweepers | 4 | 34.50 | Stove-dealers | 26 | 47.46 |
| Drivers | 681 | 40.36 | Telegraphers | 59 | 29.97 |
| Drovers | 28 | 51.32 | Traders | 4,732 | 50.39 |
| Engineers and firemen | 1,170 | 41.57 | Class IX. Professional men. } | 8,306 | 52.13 |
| Expressmen | 448 | 44.18 | Actors | 68 | 42.18 |
| Ferry-men | 11 | 51.27 | Architects | 71 | 46.23 |
| Lighthouse-keepers | 24 | 60.24 | Artists | 306 | 45.41 |
| Peddlers | 770 | 48.28 | Civil engineers | 188 | 43.91 |
| Seaton | 149 | 60.01 | Clergymen | 1,560 | 60.31 |
| Soldiers | 2,926 | 28.59 | Dentists | 193 | 45.47 |
| Stablers | 654 | 44.66 | Editors and reporters | 187 | 46.50 |
| Teamsters | 2,370 | 42.31 | Judges and justices | 46 | 66.17 |
| Weighers and gaugers | 39 | 57.72 | Lawyers | 1,017 | 56.41 |
| Wharfingers | 33 | 55.48 | Musicians | 419 | 43.13 |
| Class VII. Employed on the ocean. } | 12,394 | 48.57 | Photographers | 66 | 43.79 |
| Fishermen | 965 | 44.37 | Physicians | 1,804 | 56.51 |
| Mariners | 11 | 44.36 | Professors | 68 | 58.44 |
| Naval officers | 90 | 52.82 | Public officers | 637 | 56.44 |
| Pilots | 122 | 61.63 | Sheriffs, constables, and policemen. } | 407 | 52.30 |
| Seamen | 11,206 | 48.76 | Students | 460 | 23.67 |
| Class VIII. Merchants, financiers, agents, etc. } | 27,098 | 49.60 | Surveyors | 125 | 54.10 |
| Agents | 752 | 50.62 | Teachers | 694 | 44.62 |
| Bankers | 103 | 59.73 | Class X. Females. } | 7,387 | 39.19 |
| Bank officers | 243 | 57.10 | Domestics | 1,990 | 44.11 |
| Boardinghouse-keepers | 127 | 50.47 | Dress-makers | 595 | 42.35 |
| Booksellers | 104 | 54.75 | Milliners | 230 | 42.45 |
| Brokers | 382 | 52.13 | Nurses | 291 | 62.62 |
| Clerks and bookkeepers | 6,449 | 36.35 | Operatives | 2,237 | 29.71 |
| Druggists and apothecaries. } | 487 | 43.86 | Seamstresses | 476 | 47.25 |
| Gentlemen | 1,993 | 68.87 | Shoe-binders | 89 | 36.78 |
| Grocers | 1,019 | 48.80 | Straw-workers | 123 | 35.08 |
| Innkeepers | 734 | 51.63 | Tailoresses | 353 | 51.71 |
| Manufacturers | 2,219 | 54.92 | Teachers | 985 | 33.72 |
| | | | Telegraphers | 18 | 27.39 |

This table is not accurate in all its details, and also fails to present the relative healthfulness of different occupations, because persons are constantly changing from one occupation to another. It shows, however, very clearly the relation of certain occupations to longevity.

Dr. William Ogle, who has probably given more attention to this subject than anyone else, in a paper presented to the Seventh International Congress of Hygiene, 1891, on mortality in relation to occupation, states that "of all the various influences that tend to produce differences of mortality in different parts of a given country, there is none so potent as the character of the prevailing

occupations." He states further that "the only method of making death-rates that can be safely compared with each other is the laborious plan of calculating the death-rates for each occupation at each successive age-period, and then applying these successive death-rates to a population with precisely the same age-distribution in each industry. This method, indeed, is necessary, not only when the mortality of an occupation is being compared with that of any other, but generally in all comparisons of mortality, as, for instance, in comparison between the mortalities of different countries, or between the mortalities of the two sexes. It is, however, a method which, owing to its laboriousness, is rarely used, with the necessary consequence that many very erroneous comparisons are made."

He gives the mortality in different industries and professions which were derived from a comparison between the census returns of England for 1881 and the death-registers for the three years 1881, '82, and '83. The figures relate exclusively to males.

The lowest death-rate obtained was that of men in the clerical profession, and for the sake of comparison this is taken as the standard, being represented by 100, and the death-rate of each of the other professions or industries is represented by a figure proportionate to this standard.

Dr. Ogle classes the causes of high mortality under seven general headings:

"1. Working in a cramped or constrained attitude, and notably in such an attitude as cramps the chest and interferes with the action of the heart and lungs.

"2. Exposure to the action of special poisonous or irritating substances, such as phosphorus, mercury, lead, infected hair or wool, soot, etc.

"3. Excessive work, mental or physical.

"4. Working in confined spaces and in foul and overheated air. This is probably, in the aggregate, one of the most destructive agencies in operation, because of the very large number of trades that are exposed to it.

Comparative Mortality of Men, Twenty-five to Sixty-five Years of Age, in Different Occupations, 1881, 1882, and 1883.

| Occupation. | Comparative mortality. | Occupation. | Comparative mortality. |
|-------------------------------------|------------------------|-------------------------------------|------------------------|
| Clergymen, priests, ministers . . . | 100 | Builders, masons, bricklayers . . . | 174 |
| Lawyers | 152 | Carpenters, joiners | 148 |
| Medical men | 202 | Cabinet-makers, upholsterers . . . | 173 |
| Gardeners | 108 | Plumbers, painters, glaziers . . . | 216 |
| Farmers | 114 | Blacksmiths | 175 |
| Agricultural laborers | 126 | Engine-, machine-, boiler-makers . | 155 |
| Fishermen | 143 | Silk manufacture | 152 |
| Commercial clerks | 179 | Wool, worsted, manufacture . . . | 186 |
| Commercial travellers | 171 | Cotton manufacture | 196 |
| Innkeepers, liquor dealers | 274 | Cutlers, scissor-makers | 229 |
| Inn, hotel service | 397 | Gunsmiths | 186 |
| Brewers | 245 | File-makers | 300 |
| Butchers | 211 | Paper-makers | 129 |
| Bakers | 172 | Glass-workers | 214 |
| Corn-millers | 172 | Earthenware-makers | 314 |
| Grocers | 139 | Coal-miners | 160 |
| Drapers | 159 | Cornish miners | 331 |
| Shopkeepers generally | 158 | Stone, slate quarries | 202 |
| Tailors | 189 | Cab, omnibus service | 267 |
| Shoe-makers | 166 | Railway, road, laborers | 185 |
| Hatters | 192 | Costermongers, hawkers, street- | |
| Printers | 193 | sellers | 338 |
| Book-binders | 210 | | |

“5. Excessive use of alcoholic beverages.

“6. Liability to fatal accident.

“7. Exposure to inhalation of dust.”

Under the second cause Dr. Ogle gives the following table of the comparative mortality from lead-poisoning, based on the death-register for 1879-82, in males over fifteen years of age:

| | | |
|--|-----|---------------------|
| File-makers | 466 | per million living. |
| Painters, plumbers, glaziers | 224 | “ “ |
| Earthenware-makers | 152 | “ “ |
| Gas-fitters | 62 | “ “ |
| Printers | 27 | “ “ |
| All other males | 4 | “ “ |

Under the fourth cause he gives the following table, showing the effects upon the lungs alone, though the lungs are not the only organs affected by this cause. Fishermen, who suffer least from these diseases, are taken as the standard, and the mortality for this occupation is represented as 100.

Comparative Mortality from Phthisis and Lung Diseases of Men (Forty-five to Sixty-five Years) Working in Pure and Vitiated Air.

| Air. | Occupation. | Phthisis. | Diseases of respiratory organs. | Phthisis and diseases of the respiratory organs. |
|---------------------|-----------------------|-----------|---------------------------------|--|
| Pure air | Fishermen | 55 | 45 | 100 |
| | Farmers | 52 | 50 | 102 |
| | Gardeners | 61 | 56 | 117 |
| | Agricultural laborers | 62 | 79 | 141 |
| Confined air | Grocers | 84 | 59 | 143 |
| | Drapers | 152 | 65 | 217 |
| Highly vitiated air | Tailors | 144 | 94 | 238 |
| | Printers | 233 | 84 | 317 |

Under the fifth cause he gives the comparative mortality from various diseases of liquor-dealers and men generally. The trade most exposed to the effects of the excessive use of alcohol is that of dealers in these beverages—"innkeepers, publicans, and wine- and spirit-dealers." The table shows the comparative results obtained by taking the mortality of 1000 males of corresponding ages.

Under the seventh cause he gives the comparative mortality from phthisis and lung diseases in the various dust-inhaling occupations. The effects of the inhalation of dust are shown in an increased mortality from phthisis and from lung diseases, though the effects differ very greatly, not only with the amount of dust, but also with the character of the dust, the more irritating the dust the more injurious its effects.

Comparative Mortality of Liquor-dealers and Men generally.

| DISEASES. | Men twenty-five to sixty-five years of age. | |
|--|---|------------|
| | Liquor trade. | All males. |
| Alcoholism | 55 | 10 |
| Liver diseases | 240 | 39 |
| Gout | 13 | 3 |
| Diseases of the nervous system | 200 | 119 |
| Suicide | 26 | 14 |
| Diseases of the urinary system | 83 | 41 |
| Diseases of the circulatory system | 140 | 120 |
| All other causes | 764 | 654 |
| All causes | 1521 | 1000 |

Comparative Mortality from Phthisis and Respiratory Diseases of Men in various Dust-inhaling Occupations.

| Men twenty-five to sixty-five years of age. | Phthisis. | Lung diseases. | Phthisis and lung diseases. |
|---|-----------|----------------|-----------------------------|
| Fishermen (as standard). | 55 | 45 | 100 |
| Carpenters, joiners | 103 | 67 | 170 |
| Bakers | 107 | 94 | 201 |
| Wool-workers | 130 | 104 | 234 |
| Cotton-workers | 137 | 137 | 274 |
| Cutlers, scissors-workers | 187 | 196 | 383 |
| File-workers | 219 | 177 | 396 |
| Masons, bricklayers | 127 | 102 | 229 |
| Stone and slate quarrymen | 156 | 138 | 294 |
| Pottery-makers | 239 | 326 | 565 |
| Cornish miners | 348 | 231 | 579 |
| Coal-miners | 64 | 102 | 166 |

“The dust of ordinary kinds of woods, such as are commonly used by carpenters and joiners, appears to have very little, if any, injurious effect upon the air-passages, for the mortality of these artisans, both from phthisis and from diseases of the respiratory organs, is below the average for males generally. The harder woods, however, such as are used by cabinet-makers, are said to give off a much more injurious dust than do the softer woods used by carpenters.”

Sommerfeld ¹ gives the results of a detailed study of the influence of occupations without and with the formation of dust. His calculations are based on the results obtained in thirty-eight Berlin hospitals. During the time over which the investigation extended there were 906,341 patients in these hospitals, of which number 9761 died. Of the deaths, 5449 resulted from diseases of the respiratory organs, of which number 4675 were due to tuberculosis.

If the occupations are divided into those without and those with dust, we find marked differences. In the first group the death-rate from tuberculosis is 2.39 per 1000; in the second group, 5.42 per 1000; of 1000 deaths, there were in the first group 381 from tuberculosis, in the second, 480. If these results are compared with the conditions among adult males in Berlin, over fifteen years of age, we find that the laborers in occupations in which there is formation of dust are affected not very much more unfavorably than the average, the laborers in the occupations without dust-formation far more favorably.

| | Of 1000 living, there died of tuberculosis— | Of 1000 deaths, there were from tuberculosis— |
|---|---|---|
| Occupations without dust-formation | 2.39 | 381.0 |
| Occupations with dust-formation | 5.42 | 480.0 |
| Occupations with formation of— | | |
| 1. Metallic dust | 5.84 | 470.58 |
| <i>a.</i> Copper dust | 5.31 | 520.5 |
| <i>b.</i> Iron dust | 5.55 | 403.7 |
| <i>c.</i> Lead dust | 7.79 | 501.0 |
| 2. Organic dust | 5.64 | 537.04 |
| 3. Mineral dust | 4.42 | 403.43 |
| Average | 5.16 | 478.9 |
| Adult males of Berlin of same age, } general population. | 4.93 | 332.3 |

Among the occupations in which there is mineral dust, stone-cutters and workers in glass and porcelain are

¹ *Hygienische Rundschau*, Jahrg. vii., S. 44.

excluded. When we include these the table is changed in that the occupations with mineral dust assume the first place. Of 1358 stone-cutters, distributed among ten places, Sommerfeld found 61 deaths, indicating a death-rate of 39 per 1000; of 497 deaths, 444 were due to tuberculosis = 893.3 per 1000. Among workers in glass the death-rate from tuberculosis was 375 per 1000; among glass-grinders, 500 per 1000; and among workers in porcelain, 600 per 1000.

A great deal has been accomplished in recent years in preventing the detrimental influence of the different irritating and poisonous gases and fumes evolved in certain manufacturing processes. The employment of special ventilating flues and hoods to remove the poisonous gases obviates, to a large extent, the danger from such gases, and has rendered these occupations far more healthful.

In the mechanical trades, where irritating dusts are most frequently encountered, there has also been great improvement through the introduction of special appliances around each machine, whereby the dust is exhausted from the work-room at the point of production, though it is impossible to remove these dusts entirely. In the grinding of metals the formation of dust has been greatly diminished in many localities by the prohibition of dry grinding.

Moritz and Röpke¹ report upon a detailed study of the hygienic condition of the metal-grinders of Solingen, Germany. The death-rate among the grinders from 1885 to 1895 was 20.6 per cent., as compared with only 13.6 per cent. for the remainder of the population. Of 100 deaths in men over fourteen years of age during the same time, 72.5 per cent. of the deaths among the grinders were due to tuberculosis; among the remainder of the population, only 35.5 per cent. On examination of the grinders, only 16 per cent. were found to be healthy; 5.7 per cent. complained, but in these no disease

¹ *Zeitschrift f. Hygiene*, Bd. xxxi., S. 231.

was found; and 78.3 per cent. were diseased. Of those over forty-five years of age, none were found that were healthy.

Moritz and Röpke state that the dust produces an irritation of the mucous membrane of the nose, resulting in the formation of boils. There is also a cutaneous eruption and a swelling of the nose. Later, a certain degree of tolerance is established, but the mucous membrane of the nose becomes atrophic. This condition was found in 23.2 per cent. of the workmen, as compared with 12.2 per cent. in the remainder of the population. 32.2 per cent. suffered from chronic nasal catarrh, 48.2 per cent. from catarrh of the pharynx, and 12 per cent. had disease of the lungs. The feeling of dryness of the throat leads to the consumption of large amounts of fluid. The effects of the excessive use of alcoholic beverages was shown in 11 per cent. with fatty heart, and 5.4 per cent. with fatty liver. Rheumatic affections were found in 4.4 per cent.

The authors state that in order to prevent the formation of dust wet-grinding is to be recommended wherever possible. For the removal of dust from the point of production, ventilation apparatus of special construction must be used; but, since even with the most perfect dust-exhaustion apparatus the penetration of dust into the work-room is not entirely prevented, it is necessary to remove the dust deposited on the surfaces in the room as frequently as possible.

The grinders must exercise the greatest degree of cleanliness, not only of the work-room, but also of their persons, and the introduction of shower-baths into new establishments is desirable.

In order to protect the health of the grinders from the highly injurious effects of the dust, they should be required to breathe through the nose, and assume an upright position as much as possible.

The reduction of the number of working-hours is also recommended, and the observation of pauses about the

middle of the forenoon and afternoon to permit the workmen to spend a short time in an atmosphere free from dust. A ten-hour day for adults, and an eight-hour day for youths, are considered the maximum.

The following regulations were passed in 1883 concerning establishments in which metal goods are ground and polished: The work-rooms of all new establishments erected, or of extensions of old establishments, must have a height of at least 3.5 meters, the windows must have at least one-twelfth the floor surface, and each person must be supplied with 16 cubic meters of air space. The floors must be tight, and the walls must be freshly painted or whitewashed at least once a year. Clay floors in new establishments or extensions are prohibited.

Shuler has made a detailed study of the hygienic condition of the millers of Switzerland.¹ He studied the sick lists of hospitals, and gives an analysis of 108 cases. These were:

| | |
|--|----|
| Diseases of the digestive organs | 17 |
| Diseases of the respiratory organs | 34 |
| Diseases of the circulatory organs | 3 |
| Tuberculosis | 12 |
| Rheumatism | 19 |
| Diseases of the eyes | 4 |
| Diseases of the skin | 19 |

Under the diseases of the respiratory organs there were 8 cases of pneumonia and pleurisy, and under the diseases of the skin there were 6 cases of itch and pediculosis, and 3 of eczema.

Shuler states that if we take certain disease-groups into consideration, we find in 1000 workmen the number suffering from diseases of the respiratory organs distributed as follows: Millers, 42.3; cotton-spinners, 47.7; embroiderers, 70.7; and workmen in mechanical establishments, 76.8. The number suffering from diseases of the skin are distributed as follows: Millers, 10.2; cotton-spinners, 16.5; embroiderers, 24.2; and mechanics, 32.8.

¹ *Deutsche Vierteljahr. f. oeffentliche Gesundheitspflege*, Bd. xxix., S. 513.

The millers, who in 1888 numbered 5412, had, in the years 1883 and 1884, 1388 deaths, at the following ages:

| AGE. | Fifteen to nineteen. | Twenty to twenty-nine. | Thirty to thirty-nine. | Forty to forty-nine. | Fifty to fifty-nine. | Sixty to sixty-nine. | Seventy to seventy-nine. | Over eighty years. |
|------------------------|----------------------|------------------------|------------------------|----------------------|----------------------|----------------------|--------------------------|--------------------|
| Total | 24 | 85 | 130 | 200 | 320 | 360 | 267 | 82 |
| Tuberculosis | 6 | 29 | 46 | 59 | 63 | 26 | 8 | 0 |

Of the millers, 16 per cent. died of pulmonary tuberculosis, while in the same years for the total population of the cities of Switzerland, with over 10,000 inhabitants, only 14.4 per cent. died of the same disease. The death-rate from tuberculosis in the cities is 2.95 per 1000, while among millers it is 3.65 per 1000.

In the report of Dr. Kummer, formerly Chief of the Statistical Bureau, in Bertillon's *Encyclopedia of Hygiene*, on the death-rate from tuberculosis in Switzerland for the years 1879 to 1882, the rate is given for a number of different occupations. In 1895 Dr. Crevoisier reported on the same subject in the Swiss statistical Zeitschrift based on material of the statistical bureau for the years 1881 to 1890. These reports differ as to the general death-rate from tuberculosis, but coincide fairly well as to the death-rate from this disease for the different trades.

| ACCORDING TO KUMMER. | | ACCORDING TO CREVOISIER. | |
|------------------------------|------|---|------|
| Landlords | 1.37 | Landlords | 1.80 |
| Textile-workers | 2.14 | Cotton-weavers | 2.15 |
| Laborers (indoors) | 2.58 | Laborers (indoors) | 3.10 |
| Millers | 2.70 | Millers | 3.50 |
| Masons | 2.74 | Bakers | 3.70 |
| Shoemakers | 2.90 | Silk-weavers | 3.70 |
| Machinists | 2.96 | Masons | 3.80 |
| Butchers | 3.14 | Shoe-makers | 4.00 |
| Bakers | 3.33 | Machinists | 4.20 |
| Tailors | 3.34 | Dyers and Printers | 4.70 |
| Carpenters | 3.40 | Carpenters | 4.70 |
| Book-printers | 3.65 | Book-printers and Lithographers | 6.60 |
| Locksmiths | 4.88 | Locksmiths | 7.01 |
| Stone-cutters | 6.87 | Stone-cutters | 8.00 |

The danger from accidents varies in the different trades and occupations. The Swiss Secretary of Labor states that among 1000 laborers accidents occur as follows:

| | | | |
|-------------------------------|------|-------------------------|-------|
| Cotton-spinners | 22.2 | Brewers | 66.7 |
| Millers | 28.0 | Masons | 80.5 |
| Paper-manufacturing | 31.1 | Smiths | 93.1 |
| Carpenters | 35.2 | Metal-turners | 102.1 |
| Locksmiths | 46.9 | Moulders | 132.4 |

The Effect of Anilin Dyes and Nitrobenzine and Its Compounds.—Dr. Walter Malden¹ investigated the poisonous action of these substances upon individuals whose occupation was concerned with constant handling of these substances, as well as the influence of these substances upon animals.

In anilin workers the following appear to be the most important points which are shown by a blood examination. (1) An increase in the number of red corpuscles when the amount of poison absorbed is small and constant. (2) A decrease in the specific gravity and hemoglobin of from 5 per cent. to 50 per cent. (3) A low color index, showing that renovation of the corpuscles is proceeding more rapidly than the manufacture of hemoglobin. (4) Degeneration or imperfect development of the red corpuscles as shown by the variations in size and the presence of corpuscles containing basophil granulations. (5) Abnormal leukocytic percentages, consisting principally in a diminution in the polymorphonuclears and an increase in the other cells, particularly the lymphocytes, eosinophils, and mast cells. The following appear to be the most important effects: (1) Dinitrobenzol is more toxic than anilin, and causes more cases of acute poisoning than any other of the nitrobenzine series. (2) It quickly affects the men who work in it, even within one week. (3) The occurrence of red corpuscles showing basophil granulations is the first recognizable sign in the blood of poisoning by this substance. (4) The number of red cor-

¹ *Jour. of Hyg.*, vol. vii., Oct., 1907, p. 672.

puscles is reduced after a short time by one to one and a half million per cubic millimeter. (5) The specific gravity and hemoglobin content are reduced in about the same ratio as the red corpuscles; therefore, the color index is not far removed from unity. (6) Some leukocytosis, principally lymphocytosis, occurs in some stage of chronic poisoning. (7) Even when there is considerable cyanosis, the presence of methemoglobin cannot be detected spectroscopically except in the more severe cases.

Malden showed by animal experiments that anilin, whether injected subcutaneously or inhaled as vapor, very rapidly produces its destructive action on the blood.

This action is manifested by the following points in chronological sequence: (1) Production of methemoglobin in the blood. (2) Hemolysis and destruction of red corpuscles. (3) Rapid fall in the specific gravity and hemoglobin content of the blood, accompanied by a slight reduction in the number of leukocytes. (4) A continued increase in the number of polymorphonuclears, with a corresponding increase in the lymphocytes. (5) The occurrence in the red corpuscles of basophil granules and polychromasia. (6) The occurrence of nucleated red cells in severe cases. (7) Recovery after severe poisoning is rapid and continuous, and apparently no permanent disability is entailed.

These animal experiments corroborate the findings in the blood of anilin and nitrobenzine workers and enable us to follow the sequence of events, which appear to be the same in cases of poisoning by either of these substances, though they are much more marked in the case of the latter. These substances may gain access to the body by—(1) inhalation of their vapors; (2) absorption through the skin; (3) absorption from the alimentary canal after being swallowed.

In the less severe cases of poisoning in which methemoglobin is not present in sufficient amount to be detected spectroscopically, the changes which may be found in the blood are sufficiently characteristic to enable

a diagnosis of anilin or nitrobenzine poisoning to be made. These consist in : (1) A decrease in the percentage of hemoglobin as estimated from the specific gravity of the blood of from 5 per cent. to 50 per cent. (2) A decrease in the number of red corpuscles, if the amount of poison absorbed is considerable ; if the dose is very small, this decrease is not found, blood formation apparently keeping pace with blood destruction. (3) Degeneration and imperfect development of the red corpuscles, as shown by the occurrence of basophil granulations, polychromasia, poikilocytosis, and variations in size. (4) The presence of nucleated red corpuscles in severe cases. (5) A decrease in leukocytes, rapidly followed by an increase, the increase being principally due to the number of lymphocytes.

The simultaneous occurrence of all or several of these signs in the blood enables a diagnosis of poisoning by anilin or nitrobenzine to be made in quite mild cases. Cessation from work for a short time enables the blood to recover rapidly from the effects of poisoning.

Influence of the Length of the Working-day on the Health of the Laborers.—Dr. E. Roth,¹ in a paper on this subject, makes the following statements :

“ 1. The length of the working-day must be shorter the greater the amount of mental or physical energy required, or the greater the danger from the industrial occupation.

“ 2. The length of the working-period must be shorter the less developed and the less resistant the organism of the laborer.

“ 3. Women and youths must be excluded from all work in which great physical energy is required ; also from industries in which their health may be affected by the action of poisonous substances or dust, or which require special and continued attention.

“ 4. Laborers of eighteen years of age are to be included in the protected class of fourteen to sixteen years of age.

¹ *Deutsche Vierteljahr. f. öffentliche Gesundheitspflege*, Bd. xxvii., S. 277.

LENGTH OF WORKING-DAY OF LABORERS. 277

“5. Even where the factory-work does not exert a direct effect upon the mental or physical condition, and is not accompanied with particular danger from accident, the length of day must not exceed a definite number of hours.

“If a universal maximum is to be established, then a ten-hour working-day may be established in general when the existing conditions are favorable, and a longer working-period may not be allowed either in the interest of the laborers or their employers. Exception must be made in those occupations in which no definite working-day can be established.

The following tables do not indicate any marked decrease in the number of sick-days per laborer after a reduction in the length of the working-day from nine to eight hours :

Male Laborers.

| YEAR. | Length of working-day. | Average number working. | Number of working-days. | Number of sick-days. | Per cent. of working-days. | Sick-days per laborer. | |
|-------|------------------------|-------------------------|-------------------------|----------------------|----------------------------|------------------------|--------------------------|
| 1889 | 9 hours. | 114 | 35,568 | 726 | 2.04 | 6.37 | } 8 hours after April 1. |
| 1890 | 9 " | 141 | 43,992 | 808 | 1.84 | 5.73 | |
| 1891 | 9 " | 116 | 36,192 | 478 | 1.32 | 4.1 | |
| 1892 | 8 " | 97 | 30,264 | 256 | 0.84 | 2.64 | |
| 1893 | 8 " | 105 | 32,760 | 660 | 2.01 | 6.2 | |

Female Laborers.

| YEAR. | Length of working-day. | Average number working. | Number of working-days. | Number of sick-days. | Per cent. of working-days. | Sick-days per laborer. | |
|-------|------------------------|-------------------------|-------------------------|----------------------|----------------------------|------------------------|--------------------------|
| 1889 | 9 hours. | 225 | 70,200 | 1286 | 1.83 | 5.71 | } 8 hours after April 1. |
| 1890 | 9 " | 236 | 73,632 | 1942 | 2.63 | 8.2 | |
| 1891 | 9 " | 247 | 77,064 | 1007 | 1.30 | 4.08 | |
| 1892 | 8 " | 230 | 71,760 | 1205 | 1.61 | 5.2 | |
| 1893 | 8 " | 204 | 63,684 | 1404 | 2.20 | 6.9 | |

“6. The system of working overtime should be earnestly discouraged.

“7. For youthful workers a forenoon and an afternoon pause are necessary aside from the midday intermission.

“For adult laborers these special pauses are required when the midday pause is only one hour, and when the

working period of the forenoon and afternoon exceeds four hours, or the total working-day exceeds eight hours.”

Lighting of Industrial Establishments.—The hygienic requirements in the artificial lighting of industrial establishments are given very succinctly by Erismann, in a paper on “Artificial Lighting, with Special Reference to Distribution of Light,”¹ in which he states that: “Hygiene makes the following demands on the lighting technic:

“1. The quantity of light falling upon each workplace—the so-called degree of light—as well as the brightness of the surface, must be sufficiently great. For coarser work on good reflecting surfaces 10 meter-candles are sufficient; for finer work and with unfavorable reflection conditions, on the other hand, at least 25 to 30 meter-candles are required. The quantity of light is to be measured photometrically.

“2. The pollution of the air by the products of complete or incomplete combustion of the illuminating-material shall be as low as possible. The purity of the illuminating-material must be insisted upon. And since with the increased amount consumed the absolute quantity of the combustion-point is increased, under like conditions that form of illumination is to be desired in which the total consumption of illuminating-material per degree of light is lowest.

“3. Artificial lighting must not produce any perceptible increase in the temperature of the illuminated room; therefore the heating effect of the source of light must be as low as possible. In systems of illumination in which large quantities of hot combustible gases are produced, these must be efficiently removed. To lessen the heat-production through hot gases, it is important that as large an amount as possible of the energy produced is converted into light, and in consequence that the consumption of illuminating-material in proportion to the brightness of the flame is as low as possible.

¹ *Deutsche Vierteljahr. f. oeffentliche Gesundheitspflege*, Bd. xxxii., S. 11.

“4. The heat-rays of the source of light must not produce any discomfort. The discomfort can be diminished by increasing the distance between the heated body and the persons in the room. Since, however, the amount of light is rapidly diminished by this means, the conditions for diminishing the discomfort from heat-rays must be sought in the system of illumination itself; therefore such sources of light are to be selected in which the caloric equivalent of the non-luminous portion of the flame is as low as possible. The construction of the burners or the lighting apparatus must be of such a nature that the lowest possible radiating effect is obtained. As the best source of light, other conditions being the same, must be considered that in which the heat-radiation per candle-power of light is the lowest. The heat-radiation of an ideal source of light should be extremely small. From this standpoint the color of the light is not without significance, since a light which possesses many red rays indicates, in general, a high, and a light with principally green and blue, on the other hand, a low heat-radiation.

“5. Sources of light that possess a high reflecting power, in which a large amount of light falls upon a unit of surface, must be shaded from the eyes or weakened in some way.

“6. Flickering of the light and decrease in the intensity of the light are to be avoided in the illumination of rooms. A uniform, steady light is everywhere to be desired, and is absolutely necessary where work is carried on in which the eyes are used for a long time, or to a large extent (school-rooms, certain factories, etc.).

“7. The dangers—poisoning, explosion, fire, electric shock—to which the consumer or the public is exposed in general through installation or conduction of illuminating-arrangements, shall be as small as possible.

“8. Of not less importance, and for certain rooms (school) of more importance than the supplying of as large a quantity of light as possible, are the uniform dis-

tribution of the light and the reduction of shadow-production. This requirement can be fulfilled in direct illumination only under especial circumstances. The end is most simply and surely attained by the use of indirect (electric) light. For school-rooms this is the only mode of illumination which meets all the hygienic requirements. It can also yield very good results in factories. The discomfort from heat-radiation is entirely removed, because the source of light is raised high above the heads of the occupants.

“A combination of direct light with indirect, by means of white-glass reflectors, is not to be recommended where there is shadow-formation (as in writing), and metal reflectors are to be preferred.”

CHAPTER XII.

SCHOOL HYGIENE.

A LARGE proportion of the ill health of a community is found in children of school age, and since such a high percentage of this ill health can be prevented, it is necessary to treat briefly the subject of school hygiene.

Site, or Location, with Reference to Drainage Capacity of the Soil.—In school architecture a question of primary importance, the consideration of which is frequently neglected, is that of location with regard to the nature of the soil and its drainage capacity. Satisfactory sanitary arrangements can rarely be secured in any building unless the site of the building is carefully selected with regard to the drainage capacity of the soil. The soil structure as regards the preponderance of definite-sized grains, coarse or fine, influences the drainage capacity, and consequently the healthfulness of the site. The amount of slope and the proximity of streams, either surface or underground, also influence the character of the soil. For these reasons it is of primary importance that the site selected for a school-building shall be of such a nature as to afford the very best facilities for drainage, not only for refuse and excreta collected in the building, but for surface- and rain-water flowing over the soil. Whenever the soil of the site is not perfectly dry, it should first be underdrained.

Parkes states that the conditions which insure healthy habitations are:

1. A site that is dry and not malarious, and an aspect which gives light and cheerfulness.
2. A pure supply and proper removal of water, by

means of which perfect cleanliness of all parts of the house can be secured.

3. A system of immediate and perfect sewage removal, which renders it impossible that the air or water shall be contaminated from excreta.

4. A system of ventilation which carries off all respiratory impurities.

5. A condition of house construction which insures perfect dryness of the foundation, walls, and roof.

Structure of Walls.—Having selected a proper site for the building, the nature of the building is of considerable importance. The building itself should be detached, so as to obtain an abundant supply of fresh air and the greatest amount of light. The character of the materials composing the walls and the thickness of the walls, the number of layers composing them, all have an important influence on the character of the building. The walls should be rendered impervious to moisture, and it is preferable, therefore, to have double walls with an air space between the inner and outer surface. The materials employed in constructing the walls will be governed by circumstances, and their nature is not of great importance if they are properly used. Stone walls are usually somewhat damp, but can be rendered perfectly dry by allowing an air space between the inner and outer layers.

Cubic Space and Floor Space.—**Cubic Space.**—From calculations made by Prof. Parkes and Dr. de Chaumont, the amount of air required for each adult per hour, in order to maintain a certain degree of purity in the atmosphere, is 85 cubic meters. The respiratory impurity added to the air will, of course, be less with children than adults, consequently the amount of air required to maintain the standard of purity will be less. Though children evolve less carbon dioxide in a given time than adults, yet relatively for their body-weight they expire more. In fixing a standard for schools, the age of the children ought also to be considered; the average amount of air re-

quired being about 55 cubic meters per hour. Parkes says that it is highly desirable that some general agreement should be arrived at as to the amount of air necessary, even if it be admitted that the desired amount cannot always be obtained. If we adopt the following amounts of carbon dioxid as being evolved during an hour in repose, we shall not be far from the probable truth:

| | | |
|--|-------------------|------------|
| Adult males . (say 70 kilograms weight), | 0.72 cubic foot = | 20 liters. |
| Adult females (" 51 " "), | 0.6 " = | 17 " " |
| Children . . (" 35 " "), | 0.4 " = | 11.25 " " |
| Average of a mixed assembly | 0.6 " = | 17 " " |

The amount of fresh air that must be supplied in order to prevent the impurity due to products of respiration exceeding a particular limit, is measured by the quantity of carbon dioxid present in excess over that in external air, according to either of the standards in use, and may be calculated from the formula $\frac{e}{r} = d$, where e = amount of carbon dioxid expired in liters per head per hour; r = admissible limit of carbon dioxid due to respiratory impurity, stated per liter; d = delivery of fresh air per head in cubic meters.

Under these conditions the amount of fresh air to be supplied in health during repose ought to be:

| | | |
|-----------------------------|-------------------------------------|-------------------|
| For adult males | 3600 cubic feet per head per hour = | 102 cubic meters. |
| For adult females | 3000 " " " = | 85 " " |
| For children . . | 2000 " " " = | 57 " " |
| For a mixed assembly . . | 3000 " " " = | 85 " " |

The law of Massachusetts requires that each occupant of a school-room receive a quota of 850 liters of air per minute. If this is taken as the basis for the minimum amount of air required by each child, and we require further that the air be changed but three times each hour, then the minimum amount of cubic space allowable for each child is 17 cubic meters. This is slightly lower than the theoretical amount, as shown by the calculations of Parkes,

but it is far in excess of the amount of space usually supplied in common schools.

When the air of a room is changed more frequently than three times an hour, there is always more or less draft in some portions of the room, and for this reason the minimum amount of space allowed should be 17 cubic meters. Even with this amount of cubic space it is impossible to keep the air of rooms of the same purity as outside air, owing to the gases given off during respiration. For this reason a certain amount of respiratory impurity, as it is called, is permissible in well-ventilated rooms. With the outside air containing 0.4 part in 1000 of carbon dioxid, the additional amount permissible as coming from respiration is 0.2 part in 1000, making a total amount of carbon dioxid in the air of 0.6 part in 1000. It should be our aim in the ventilation of school-rooms to maintain the respiratory impurity at this low standard, and this it is possible to do if the initial cubic space is sufficient—say 17 cubic meters—and we have reliable mechanical means for introducing the requisite amount of fresh air each hour. If the cubic space is less, or the arrangements for the introduction of fresh air are imperfect, it is impossible to have perfect ventilation and pure air. It is, therefore, merely a matter of choice on our part whether we will elect to have efficient ventilation or not. It can be obtained by making the necessary expenditure. Without this it is impossible to obtain it.

Floor Space.—Each child should have a floor space of at least 4.25 square meters. This amount of floor space, when the height of the room is 4 meters, will give each child a minimum cubic space of 17 cubic meters. The amount of floor space is an important factor, inasmuch as it is brought into relation with the height of the room.

Relation of Window Space to Cubic Space.—In fixing the height of stories, when not governed by the amount to be expended, the height of the basement should be 2.8 to 3 meters. The first story should be

3.9 and the second story 3.8 meters in height. Light in rooms of the second story is always superior to that of the first, consequently the increased height of the first story. There is also usually an increase of glass surface provided for the first story to equalize the difference in light. The window heads should be finished to the top, so that no shadow can be thrown on the ceiling. The sills of windows should be 1 meter from the floor. The proportion of light to floor of class-rooms should never be less than 1 square meter of glass surface to 6 square meters of floor surface, for rooms 10 meters wide, lighted from only one side. Within the limits of a city, where the adjoining buildings are about 6 meters from the exterior walls, this proportion should be increased to 1 to 5. The length of the school-room should not be over 15 meters, and the width not over 10 meters, while the height should be at least 3.8 meters.

Lighting.—The lighting of school-buildings is a matter of very great importance. The windows should never be in the front of the room, only at the sides and rear. It is preferable to have them on the left side of the room, so as to have the light falling over the left shoulder of the pupil. The windows should be provided with shades or blinds, so that direct sunlight can be excluded as required.

As the sense of sight is the chief medium of education, it is hardly possible to overestimate the importance and necessity for carefully observing the management of light in school-rooms. It has been positively established by careful and extensive statistics that myopia is most frequently, if not exclusively, developed during school-life. This is due partly to the fact that the eye during this period of growth is more liable to change in form, and partly to the fact that children have much stronger power of accommodation than adults, and therefore hold objects more closely to the eye. The book or paper should never be closer to the eye than 25 centimeters. If there is myopia sufficient to prevent the letters from

being distinct at this distance, it is better to wear glasses in the study-room. In erecting public schools it involves a little extra expense to provide windows of sufficient size. Architectural beauty ought to be a secondary consideration where such grave practical interests are involved. Dr. Cohn maintains that a school-room cannot have too much light, and recommends the very large proportion of 1 square meter of window glass for every square meter of floor surface, and that less than about one-half of this proportion should never in any case be allowed. The arrangement that Mr. Eiberich advocates is to have the class-rooms of oblong shape, the windows being on one of the long sides and the desks arranged parallel to the short walls, so that the light falls from the left side.

The Position of Blackboards.—The blackboards should be on the inner wall of the room, where the greatest amount of light will fall upon them, and they should be of a dull-black color. The principal cause of defective eyesight in school-children is no doubt traceable to improper lighting of the room, which may be either excessive light or deficient light, or light coming from the wrong direction. The position of the blackboards and their frequent use for copying exercises, while the child is at its desk, require rapid changes in the accommodation, which is also a factor in producing defective eyesight. Another factor, independent of the arrangement of the school-room, is the use of books printed with defective type or with too small a type.

Corridors, Cloak-rooms, and Wardrobes.—The corridors should be without obstruction, and never less than 2.4 meters, preferably 3 meters, wide. The stairways should be 1.8 meters wide, and each flight should be broken with a landing. These stairs should be as near to the exit as possible, and equally placed at each end of the building. The walls should be of brick, and finished in white enamelled brick or white enamelled paint. Wallpaper should never be allowed in school-rooms, because

of the difficulty of maintaining it in a proper sanitary condition.

As contagion is most likely to occur from garments, which, if porous, absorb and transport gases, bacteria, etc., it is necessary to have two wardrobes properly arranged on each floor, one for each sex. The latest improved wardrobes, set up in separate rooms or in the corridors, either in the basement or on each story, are made with separate stalls of channel iron. At the bottom is a shelf for rubbers, two rings and cups for umbrellas, with hangings on each side. The best place for wardrobes is in each corridor, provided it is wide enough. Wardrobes seem to be the most difficult problem of school sanitation, there being many advantages in the method of placing them in wide corridors, unless special rooms can be provided, with thorough circulation of fresh air. The advantage of having wardrobes in the corridors is that the teacher in charge of that floor maintains the discipline, and there will be no travelling up and down to the basement.

Ventilation.—With regard to the introduction of fresh air, probably the most satisfactory arrangement for a school-building is that by means of indirect heating, where the air required for ventilation is brought in at the desired temperature, thus maintaining the temperature of the room, while the purity of the atmosphere is secured at the same time.

As to the best method to introduce the requisite amount of air into school-buildings, numerous systems of ventilation and heating are in use, several of which give satisfactory results, if properly constructed. If the building contains as many as eight or ten rooms, and is two or three stories in height, it is impossible to ventilate it satisfactorily without the introduction of fans to assist in either propelling the incoming air or extracting the foul air of the rooms. It is customary to have one of these blowers in the shaft through which fresh air, already heated by passing over steam coils, makes its entrance

into the room to be warmed and ventilated. These shafts are usually supplied with a by-pass valve, which is under the control of a thermo-regulator, so that the supply of air is kept at a definite temperature automatically. As soon as the temperature rises above the desired point, the thermo-regulator cuts off the supply of heated air, and allows cold air to enter and mix with the heated air. This not only facilitates the proper ventilation of the rooms, but likewise economizes the amount of fuel used. By means of fans it is possible to introduce a definite amount of air in a definite period of time, the entire circulation of air being under control.

In this method of ventilation and heating it is possible to place the intake of fresh air at such a point as to prevent some of the grosser atmospheric impurities from gaining access to the building. This point of intake may vary according to the location of the building; ordinarily, it should be at least 2 or 3 meters above ground. It may be over the roof of the house, if it is found that at that point the air is purer than at a lower level. It is also possible by this method of ventilation and heating to filter the air, in order to remove the grosser dust particles, by passing it through a screen over which a constant stream of water is flowing. It is also possible to regulate the humidity of the air, to some extent, through this method of filtration, the air taking up some moisture in passing over the screen.

Heating.—Heating may be accomplished either by what is known as direct heating, as by use of a stove or open fireplace, or through steam or hot-water radiators in the room. Or it may be by what is known as indirect heating, where the radiating surface is in some other portion of the building, and the rooms are heated by bringing in air that is warmed by passing over steam or hot-water coils. Where a system of direct heating is employed, whether with steam or hot water, the capacity of the heating plant should be adapted to meet

the requirements placed upon it. Mr. William J. Baldwin, in his *Steam Heating Data*, states that the question of condensation of steam receives the first consideration in making calculations for the heating of a building. If asked the question why condensation is considered first, he would reply that "it furnishes us with the first item of data on which to base our calculations. For instance, when we find the amount of cooling or condensation that is to take place within a building in the coldest weather, we then know the amount of water it is necessary to evaporate to do this work. Having the amount of water evaporated, we can then obtain, in the order we please, the size of boiler necessary to evaporate the water, the amount of coal or other fuel that will evaporate that amount of water, the size of the grate on which to burn the coal, the size and height of chimney necessary to supply air for combustion, the size of the radiators necessary to condense the steam, the size of pipes necessary to convey steam or hot water to the radiators, and all other attendant data which will develop as we proceed."

Water-supply and Sewage Disposal.—The building should have an abundant supply of pure water, so as to insure against the diseases ordinarily carried by water; also to facilitate the maintaining of strict cleanliness among the children in the building. It is also necessary to devise some method for the disposal of the sewage, in the absence of a system of sewers. This becomes a separate question in different localities. In some instances, where the price of land permits, it will probably be safest and cheapest in the end to have some form of surface irrigation. Where the price of land does not permit this method of disposal, it may be necessary to resort to properly constructed cesspools or some of the modern methods of purification.

Water-closets and Latrines.—Where there are no sewers we unhesitatingly use the closets; but these should discharge into specially constructed tanks or cesspools, so that the sewage may be disposed of in a sanitary

manner. There should be no connection of any kind between the class-rooms and the water-closets. In no case should wastes of sinks be discharged into the vaults. The wastes should enter a cesspool, preferably a double cesspool—with a tight compartment for solids and a leeching one for liquids. The best urinal is of slate, with the dry-earth system. There should be a connecting waste from the trough and a connection with the cesspool drain. Water-closets for the pupils' use, where there is water carriage, should be with automatic seats. Thick porcelain slabs, with backs, are the best and cheapest devices for drinking-fountains in the corridors. The plumbing of the building should be the best obtainable, with tight joints and as few bends in the pipes as possible; and these pipes should be properly ventilated by means of an open trap outside the building, between it and the sewer, and by carrying the other end of the soil pipe up over the roof of the building, of the same diameter throughout. All the traps of the water-closets and sinks must be back-aired, in order to insure against the production of foul odors in the unventilated ends of the pipe; and also to prevent the unsealing of these traps.

Each story of the school-building should be provided with suitable water-closets, with automatic flushing arrangements. These toilet-rooms should also be provided with sinks, so as to facilitate maintaining a proper degree of cleanliness of the hands and persons of the pupils. The expense of soap and towels to the community is a small one compared with the detriment occasioned by permitting the children to come in contact with each other when some of them are not as cleanly as they should be.

Desks and Seats.—The height of the seat must correspond with the length of the pupil's legs below the knees. The seat may be horizontal or slightly curved. The back of the seat should be composed of an upper concave portion and of a lower convex portion, so as to conform to the back of the pupil, and it should be of suffi-



FIG. 52.—Comparative diagram showing (a) the proper position at a desk; (b) the position when the desk is too low; and (c) the position when the desk is too high (after Cohn).

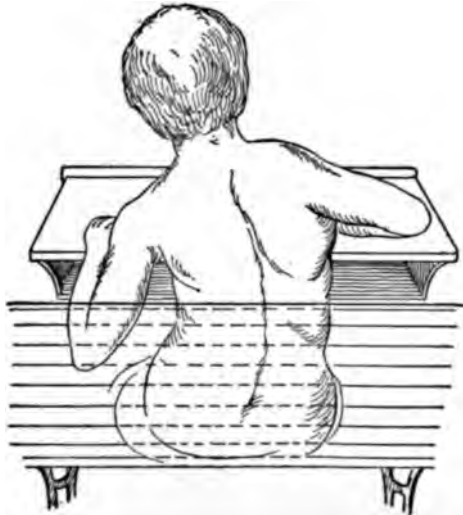

FIG. 53.—Position assumed in writing with the desk too high.

cient height to support properly the pupil's back. The writing desk should have an inclination of about 15 degrees. The desk should be fitted to the size of each pupil. The prevalence of lateral curvature of the spine in children is traceable to the use of desks that are entirely too high or too low (Figs. 53 and 54).

Defects in School-buildings.—During 1896-97 a committee of the Women's Health Protective Association of Philadelphia, with the assistance of Professor Woodbridge, of the Boston Institute of Technology, made a

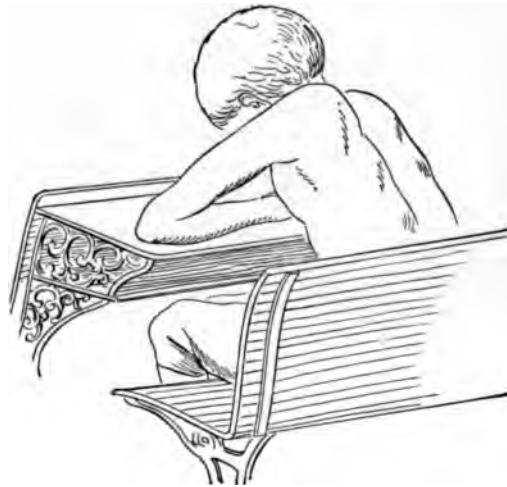

FIG. 54.—Position assumed in writing with the desk too low.

very thorough examination into the hygienic condition of 160 public-school buildings of Philadelphia. In summing up the result of their investigation they say that, next to uncleanliness, the greatest evil related to improper ventilation; of small yards, due to the close proximity of buildings, some of them many stories in height; the presence of coal gas; lack of sunshine; in the outside air, close proximity of outhouses improperly constructed or carelessly cleaned and flushed; the keeping of wraps in school-rooms or adjacent unventilated closets, and the almost total absence of ventilation by transoms,

and in many instances the use of storm doors, rendering ventilation impossible save at the expense of the children's health. In one building, accommodating 200 children, the sun never entered, save in one room at the noon intermission. In some buildings there were as many as nine rooms never cheered by the sun. Fan or shaft ventilation could not be introduced without great expense, but properly arranged door and window transoms for ventilation could be placed in every building at little cost, thus admitting fresh air without occasioning draft. This committee recommended that every building should be supplied with such means of ventilation as will insure free circulation of air throughout the building. The prolific cause of the spread of contagious diseases is the keeping of wraps in school-rooms. The committee found that at least three-quarters of the older buildings had no cloak-rooms, or very inadequate ones. In many cases there were no means of ventilating such rooms except through the school-rooms.

It is a well-known fact that the constant breathing of air markedly vitiated by the excretions from the lungs of other persons exerts a detrimental influence upon the vital powers of the system. Nevertheless we find many of our public-school buildings overcrowded, and in consequence the way is opened for the more general distribution of the micro-organisms of disease when brought into such an overcrowded space.

The greater prevalence of such diseases as diphtheria, measles, and scarlatina during the autumn months can be definitely traced to the very intimate association of children in overcrowded and poorly ventilated school-rooms, and to the diminished resistance of their bodies to infection in consequence of the injurious effects of such overcrowding.

We have a general knowledge of the overcrowded condition of the public schools in different places, but, so far as I know, no systematic effort has been made to gather detailed information regarding the ventilation

of the public schools, except that published by the State Board of Health of Ohio (1901) for all the schools in cities and towns of that State. This report is most interesting and important, and should be duplicated elsewhere. The tables given in this report show the number of square feet of floor space and the air space for each pupil in a room, as well as the ratio of window area to floor space. The investigation shows that 18 per cent. of the schools contain one or more rooms that fall below the minimum standard of 15 square feet of floor space, and a still greater number (28 per cent.) fall below the minimum standard of 200 cubic feet of air space, while 75 per cent. of the school-buildings have rooms that are deficient in light in that they fall below the standard of a window area of 20 per cent. of that of the floor space.

Conditions such as these are, no doubt, very general throughout the country, since there is no probability that the conditions are worse in Ohio than elsewhere. With conditions such as these prevailing in our public schools it is no wonder that diseases of the respiratory tract are so readily disseminated among school-children. Moreover, deficient ventilation and lighting are potent agencies in undermining the vitality of the bodies of growing children. It is of the greatest importance that the children of our public schools be protected from all detrimental agencies possible.

Medical Inspection of Schools.—Medical inspection of schools and school children is conducted on one of two principal plans. In many European states the inspection is far-reaching in its effects, as the general health and development of the child are considered. Any defects in the physical condition of the children or their home and school surroundings are investigated and remedied. The other plan of school inspection is directed primarily toward the detection of infectious diseases among the children and the exclusion of sick children from school until they are well.

In some of the countries of Europe medical inspection of schools has been developed to a high plane. In Hungary, for instance, the position of school physician is an established one, and the duties of this officer are well defined. It is the duty of the school physician to examine and study the school-buildings from a sanitary standpoint, as well as their contents and surroundings. It is his duty to investigate the purity of the air in each class-room, and analyze it systematically from time to time. He must inspect the lighting, heating, and ventilation of each of the class-rooms, and regulate the number of children in each room. On the basis of yearly measurement and examination of the children, he must direct the proper seating of each, not only with regard to the adaptability of the form and size of the desks to the age of the pupils, but also with regard to special requirements of certain pupils on account of defective eyesight or hearing. He is also required to analyze the drinking-water used in the schools, and endeavor to procure healthy drinking-water. When disinfection of the school becomes necessary, he must see that it is properly carried out.

When the school physician, in any of these instances, notices hygienic defects, he must inform the director of the institution, and make suggestions for remedying or removing such defects. He must also see that the laws of public health and the legislation of the board are carefully carried out.

With regard to the health of the pupils, it is the duty of the school physician to examine all new pupils on entering a school. These examinations are to be of such a detailed and systematic character as to afford a knowledge of the health of each child. He must make special observations to determine the extent to which the pupil may safely take part in the regular gymnastic exercises of the school, or whether these must be in part or entirely prohibited. He must examine each new pupil to determine whether it is suffering from any infectious

disease, especially tuberculosis. He must also examine the spinal column to determine the presence of curvature, in order that special gymnastic exercises may be prescribed to overcome this defect. He must examine the eyes and ears, and determine the degree of vision and the hearing power.

These systematic examinations of the pupils are repeated during the school year, and a careful record must be kept of the progress of each pupil in regard to the uniform and healthful development of the body.

The sanitary inspection of schools and school-children has been very generally adopted in the larger cities of the United States during the last decade. Where such a system is adopted, as in New York, Boston, Chicago, and Philadelphia, a corps of medical inspectors is appointed, whose duty it is to examine all children whom the teacher believes to be suffering from disease. In this manner many incipient cases of infectious disease are detected and isolated before the danger of dissemination is very great. The great value of these inspections is shown in a report made by Dr. A. R. Reynolds, Health Commissioner of Chicago, October 30, 1900, to the Board of Education. "Since the beginning of the year 75,000 children have been detained by school principals for medical inspection, and of these, 4539 were temporarily excluded from school on account of danger of contagion. As a result of this precaution there has been a very notable decrease in the mortality from infectious diseases, especially diphtheria and scarlet fever." The report of the medical inspectors of Philadelphia, made October 30, 1900, and covering the first eight months of their work, shows that 5876 cases of diseases were found in the public schools, of which 3446 were contagious. Among the latter were 12 cases of diphtheria, 4 of scarlet fever, 112 of measles, 118 of mumps, and 212 of pediculosis; contagious skin-diseases, 116; ringworm, 753; conjunctivitis, 397; scabies, 8; whooping-cough, 20; typhoid

fever, 3; tuberculosis, 2; and scalp diseases, 8. More than 1000 cases of defective vision were found.

The medical department of the Philadelphia High School for girls was established in 1893. Prior to this time the attendance of any physician was depended upon in an emergency, so that much time was lost, and the uncertainty of obtaining assistance was great. In 1893 the services of a graduate of the Woman's Medical College were secured. The duties of the head of the medical department constantly increased from one hour a day to continual attendance from the opening of the school at 9 A. M. until the close of the session at 2 P. M.

At the beginning of each school year in September all vaccination certificates and scars are examined; in doubtful cases a certified re-vaccination is required. Teachers at the beginning of each morning session inquire whether any student is suffering from sore throat, headache or other ailment; all such are at once referred to the medical room. A daily record of students sent to the medical room is carefully kept. Any student with a temperature of 100° F. is detained in the "sick-room" until the temperature becomes normal. If a rise takes place, the student is sent home in a carriage. On stormy days students who have wet shoes, stockings, or skirts are required to report at the medical room, where dry garments are provided. All wet clothing is dried in a room prepared for the purpose, and is made ready for the student at recess in the medical room at noon. Every part of the entire building is thoroughly cleansed daily. The balustrades and desks throughout are carefully cleansed each day with antiseptic solution. The drinking-water is filtered, then sterilized, and the ice is made from sterile water. The sanitary condition of the toilet-rooms is excellent. There are now individual compartments, where formerly there were congregate rooms.

The objects to be attained in the systematic daily medical inspection of schools are: (1) The early detection of any cases of communicable diseases among the children

and their prompt exclusion from the school. (2) The discovery of children suffering from non-communicable diseases or physical defects which hinder their proper advancement in their studies, such as defective vision and hearing. (3) To note the growth and development of the school-children. Defects in development and imperfect growth should be noted and the causes underlying them ascertained. In this respect the intelligent teacher can be of great assistance to the medical inspector in pointing out the defects noted through the more intimate association with the children. Where imperfect development arises from lack of proper or sufficient food and clothing, the social and financial condition of the parents should be brought to the attention of charitable organizations for investigation and amelioration.

CHAPTER XIII.

MILITARY HYGIENE.

THE health and efficiency of an army are dependent upon the physical condition of the individual soldier and the hygienic condition of his environment, the nature of his food-supply, qualitatively as well as quantitatively; the nature of his clothing, and the nature and extent of his physical exercise.

The Recruit.—It is evident that the health and efficiency of an army rest fundamentally upon the physical condition of the recruit, and consequently great care is exercised in the selection of individuals for enlistment. The physical condition and endurance of the recruit are influenced directly by his age, height, weight, and general physical development.

The age of the recruit has an important influence upon his physical endurance and adaptability to the service. In men of eighteen to twenty years of age the ossification of the bones and the general muscular development are as yet incomplete, and therefore they are more liable to succumb to the strenuous duties of the soldier. In like manner, men over forty-five years of age frequently lack endurance because of beginning degenerative changes in the circulatory organs. It has been found that the most inefficient armies were those in which the largest proportion of the men were below twenty-two years of age, though it has also been found that young men are most easily trained and are more likely to follow orders without question. The age-limit, except in cases of re-enlistment, should, therefore, be from twenty-one to thirty-five years.

In peace the maximum age for cavalry is thirty years,

for all other arms, thirty-five years; the minimum for musicians, sixteen years, for all others, eighteen years. Volunteers are accepted between eighteen and forty-five, but men were drafted in the Civil War only between twenty and forty-five years. The unorganized militia are between eighteen and forty-five years. In the English army, according to Parke, men are enlisted from eighteen to twenty-five years of age.

The relative proportions of height, weight, and chest measurement of the recruit are valuable indicators of his general physical development, and, therefore, of his adaptability for the service.

The following table¹ shows the relative proportions of height, weight, and chest measurement as found in average men:

| Height. | | | Weight. | | Chest Measurement. | | | |
|------------------|---------|-------|---------|------|--------------------|------|-----------------|-----|
| | | | | | At Expiration. | | Mobility. | |
| Feet. | Inches. | Cm. | Pounds. | Kg. | Inches. | Cm. | Inches. | Cm. |
| 5 $\frac{4}{8}$ | 64 | 162.5 | 128 | 57.9 | 32 | 81.2 | 2 | 5.0 |
| 5 $\frac{5}{8}$ | 65 | 165.1 | 130 | 58.8 | 32 | 83.8 | 2 | 5.0 |
| 5 $\frac{6}{8}$ | 66 | 167.6 | 132 | 59.7 | 32 $\frac{1}{2}$ | 85.0 | 2 | 5.0 |
| 5 $\frac{7}{8}$ | 67 | 170.1 | 134 | 60.7 | 33 | 86.3 | 2 | 5.0 |
| 5 $\frac{8}{8}$ | 68 | 172.7 | 141 | 63.8 | 33 $\frac{1}{2}$ | 86.9 | 2 $\frac{1}{2}$ | 6.3 |
| 5 $\frac{9}{8}$ | 69 | 175.2 | 148 | 67.0 | 33 $\frac{1}{2}$ | 87.6 | 2 $\frac{1}{2}$ | 6.3 |
| 5 $\frac{10}{8}$ | 70 | 177.8 | 155 | 70.2 | 34 | 88.9 | 2 $\frac{1}{2}$ | 6.3 |
| 5 $\frac{11}{8}$ | 71 | 180.3 | 162 | 73.3 | 34 $\frac{1}{2}$ | 89.5 | 2 $\frac{1}{2}$ | 6.3 |
| 6 | 72 | 182.8 | 169 | 76.5 | 34 $\frac{1}{2}$ | 90.8 | 3 | 8.8 |
| 6 $\frac{1}{8}$ | 73 | 185.4 | 176 | 79.7 | 35 $\frac{1}{2}$ | 92.0 | 3 | 8.8 |

It is, however, the manual states, not necessary for the recruit to conform exactly to the figures in the table. A variation of 10 pounds (4.5 kg.) in weight or 2 inches (5 cm.) in chest measurement (at expiration) below the standard given in the table is admissible, provided the applicant is otherwise vigorous and healthy.

The Surgeon-General gives the following directions for the examination of recruits:

“The minimum height of a recruit is at present fixed at 5 feet 4 inches for all branches of the service, although

¹ *Manual of the Medical Department of the Army*, edition of 1900, p. 101.

recruiting officers are allowed to exercise their discretion as to the enlistment of desirable recruits (such as band musicians, school-teachers, tailors, etc.) who may fall not more than $\frac{1}{4}$ inch below the minimum standard of height; the maximum height for the calvary service is 5 feet 10 inches; that for infantry and artillery is governed by the maximum weight, to which should be applied the rule for proportion in height.

“The minimum weight for all recruits is 125 pounds, except for the cavalry, in which enlistment may be made without regard to a minimum weight provided the chest measurement and chest mobility are satisfactory. The maximum for infantry and artillery is 190 pounds; for cavalry and light artillery, 165 pounds.

“The chest mobility—*i. e.*, the difference between the measurement at inspiration and expiration—should be at least 2 inches in men below 5 feet 7 inches in height, and $2\frac{1}{2}$ in those above that height.”

The height of recruits must be at least 165 centimeters; minimum chest measurement, 75 centimeters, with at least 5 centimeters expansion; and the weight 54 to 81 kilograms. In the cavalry service the maximum weight is 75 kilograms.

According to Parke, probably 63 inches at nineteen years of age, and 120 pounds weight, should be the minimum height and weight according to age, even in times of greatest pressure.

In France the weight is reckoned at the rate of 700 to 725 grams for each centimeter of chest circumference.

Any defect or deformity which is likely to interfere with the duties of a soldier will cause the rejection of the applicant. He must have free use of his limbs and be active and vigorous. The character of the feet and legs is a most important matter for investigation by the recruiting officer because of the nature of the service in which the soldier engages. Any defects or imperfect development of the feet and legs will probably be detected by the examining officer from the exercise in walking,

running, and jumping to which the applicant is subjected. The hearing must be normal and the vision without evident defect. The recruit must be "effective, able-bodied, sober, free from disease, and of good character and habits." The mere fact that the recruit presents himself for examination in ragged or filthy clothes, or is filthy in his person, is sufficient to cause his rejection. The most frequent cause of rejection of applicants is some form of defective development. For the year 1899 there were examined 70,311 men for enlistment in the regular army, of whom 47,899 were accepted, or 681.24 out of every 1000 examined. "Of every 1000 examined, 74.56 were rejected on account of imperfect physique, including overheight, underheight, overweight, and underweight; 41.43 for diseases of the eye, 38.06 for diseases of the circulatory system, 26.53 for diseases of the digestive system, 22.43 for affections of the genito-urinary system, 17 for venereal diseases, 9.61 for hernia; while 9.81 were rejected as generally unfit or undesirable, 3.74 as minors, 3.12 on account of bad or doubtful character, and only 1.32 on account of illiteracy, imperfect knowledge of the English language, or mental insufficiency."¹

Training of the Recruit.—Physical Training.—In order to increase his endurance, as well as add to his general usefulness as a soldier, the recruit must be subjected to thorough physical training as well as training in the art of war before engaging in active warfare. Physical training, if conducted systematically, will greatly increase the endurance of the raw recruit. Without this preliminary training most men, however well proportioned they may be, will succumb to the arduous duties of active warfare.

The recruit should be instructed in swimming, not only because it is a most useful physical training, but also because it is an acquirement that may be of the greatest service in his calling. Dancing, fencing, and general gymnastic exercises are of great value in training

¹ *Report of the Surgeon-General*, p. 27, 1900.

the coördinate movement of muscles, as well as in aiding in the uniform development of the body and in increasing the general physical endurance. Exercises in singing are valuable in improving the lungs and in developing the breathing capacity. Any exercise that aids in improving the general physical condition of the body should be made use of in the preliminary training of the recruit.

Moral Training.—The great danger from vice in the army arises principally from the fact that large numbers of men are brought together, and are, in times of peace, compelled to spend a portion of their time in comparative idleness. The utilization of definite portions of each day in perfecting the men in their knowledge of the military art will, in large part, prevent vice, and gives at the same time healthful occupation to the mind, thus preventing home-sickness. The soldier should also be instructed in other lines of useful knowledge, such as cooking, washing, and sewing, so that he may contribute toward the general comfort of the army as well as his own welfare.

The influence of the canteen law has given rise to a great deal of discussion recently. There are two sides to this question, each having its earnest advocates, and it is evident that the solution of the problem should be left to the efficient heads of the army. They have opportunities for the formation of unbiased judgment which are denied to those on the outside. *A priori*, the entire exclusion of alcoholic beverages would be preferable, by far, if it could be accomplished.

The Association of Military Surgeons, in its annual convention at St. Paul, May, 1901, unanimously adopted a resolution declaring that the abolition of the canteen had resulted in an increase of "intemperance, insubordination, discontent, desertion, and disease," at the various army posts, and urging that it should be re-established at the earliest possible date, "in the interests of discipline, morality, and sanitation."

Food of the Soldier.—Under present laws and regu-

lations the soldier may have any variation of his diet within certain money value limits which his officers consider necessary for his well-being. His ration is fixed by law, but his diet depends on the intelligent supervision of company officers and the ability of company cooks. Major Howard¹ states that "the diet of the soldier is what the company commander and his first sergeant and cook may choose to make it, the materials being amply provided by the official ration."

The soldier's ration consists of the following: 342 grams of pork or bacon, or 567 of fresh beef; 454 of hard bread, or 566 of flour; 68 of beans or peas, or 45 of rice or hominy; 45 of green coffee; 17 of salt; 68 of sugar; besides pepper, vinegar, and, at times, tea instead of coffee.

The food should be thoroughly cooked, and free from fermentative or putrefactive changes. Ripe fruit may be eaten in moderation, but green or over-ripe fruit should be avoided, because these give rise to disturbances of the digestive organs.

With such ample provision of materials it has generally been found possible to adapt the diet to any climatic conditions to which our army has been subjected in the past few years. No doubt some difficulty was experienced in supplying the full complement of fresh meat and vegetables in the tropics at all times, on account of the great distance from the base of supplies, but, in general, there appears to have been little real inconvenience.

There has been considerable discussion as to the suitability of the ration to tropical conditions, some claiming that an excess of fat and a deficiency of carbohydrates in the form of fresh vegetables and fruit was supplied. There is, however, provision in the law allowing commutation of the rations, thus permitting the purchase of food in the local markets, and in this manner any defects in the materials supplied can be remedied to advantage.

Unless the duties of the soldier in the tropics are

¹ *Surgeon-General's Report*, p. 174, 1900.

arduous, thus necessitating a diet rich in proteids, the use of a greater proportion of vegetables and ripe fruit than is the custom in colder climates would serve to reduce the danger from disordered gastro-intestinal function in large part. Along with the use of pure water such a diet should serve to lessen the suffering from diarrhea and dysentery.

New Ration for Soldiers.—Since the unpleasant results during the Spanish war from the use of canned beef in the tropics the Government has substituted fresh meats for the troops in the Philippines. At considerably greater expense the Government has bought refrigerated beef in Australia for the army in the Philippines, but it is only available for troops stationed at seaports or within easy reach inland. It will keep twenty days in good condition for use, but it is not an ideal meat ration for active field service where troops are on the march. The most practical method of maintaining a meat-supply for moving troops has been to drive cattle along with the marching column.

The trial of a new ration called "roast-beef hash" seems now likely to solve some of the problems of subsistence for men in the field. This is a canned beef that has been thoroughly cooked and mixed with chopped and cooked potatoes and onions. It will keep indefinitely and is said to be most appetizing. The men like it, and the first trial has proved so successful that a larger amount will be shipped. It is packed in boxes and can be transported readily and served out to each mess quickly, supplying on occasion a complete meal ready cooked. On forced marches or in a country where a fire is not desirable it is a very convenient food. It is adapted to rapid marching, where it is impracticable to take along a supply train, pack animals being able to carry a considerable amount, and in case of necessity each man can put a day's supply in his haversack.

Clothing of the Soldier.—The clothing of the soldier requires intelligent supervision in order to adapt it to the

climate of the locality in which he is serving as well as to seasonal variations.

Underclothing.—Light woollen underclothing should be supplied, even in the tropics, because it takes up moisture from the skin very readily, and thus protects against chill after exercise. The stockings, on the other hand, should be composed of about equal parts of cotton and wool. Woollen stockings are apt to cause sweating of the feet, and thus induce a tender condition of the feet which is likely to produce discomfort or even suffering. Cotton stockings are apt to be cold, and are therefore not suited for colder climates. Gray flannel shirts should be supplied except for service in the tropics, where a cotton shirt may be substituted when light woollen underclothing is worn.

Outer Garments.—The uniform should be adapted to the occupation and to the climate. In colder climates woollen garments should be supplied, the weight of the goods being regulated according to the locality. In the tropics, and during summer in the temperate zone, the garments should be made of materials which allow of the free circulation of air. The khaki cloth now generally in use for the uniform supplied to troops in the tropics has proved quite satisfactory.

The color of the uniform is of great importance, not only on account of its heat-absorbing powers and the facility with which it allows the heat of the body to pass off, but likewise because of the extent to which it renders the soldier visible at a distance. Red is the most conspicuous color, white is next in order, while gray is least conspicuous. The khaki uniforms are very well adapted from this standpoint. This is a point that should be considered by the State in order to conserve the life and safety of its soldiers. During the conflict in South Africa the British officers are reported to have suffered disproportionately on account of the color of their uniform.

The head-covering is of great importance, especially

in the tropics, where the head and face should be shaded from the fierce rays of the sun and against rain. The hat worn by the troops in the tropics meets these points fairly well. It is light, and allows free circulation of air, thus limiting the danger from sunstroke.

The shoes should be adapted, as near as may be, to the feet of the individual wearing them. In order to be able to meet this demand satisfactorily, the State should supply the common sizes and shapes of sole, and, besides this, make to order the shoes of those that cannot be fitted properly from stock. A great deal of discomfort and suffering may be avoided by such a course, besides enhancing the endurance and efficiency of the soldier.

While on the march each soldier carries also his blanket and waterproof, and in cold climates his overcoat. These articles of clothing are made up into a roll, together with the toilet articles, and this is slung over the shoulder. It is not likely that the knapsack formerly in use will again find favor. It gave rise to discomfort, and at times proved positively injurious because it had to be buckled on firmly and therefore impeded the free movements of the soldier's arms and chest.

When the soldier's clothing or bedding becomes damp from exposure to rain or heavy dews, it should be dried in the sun or by fires at the first opportunity that presents itself.

The following is Major Meacham's opinion with regard to the soldier's clothing for field-service in the tropics, based upon his experience in northern Luzon, P. I. :

"The clothes must be loose and comfortable. On the march, part woollen should be worn next the body. Experience during the past wet and dry seasons shows that the clothing now furnished is fairly well adapted to this climate. The supply at the depots has been sufficient. The shoes and socks give entire satisfaction. For the march the light woollen sock is preferable.

"The recent issue of campaign hat, with corrugated sweat-bands and ventilation in the sides, possesses ad-

vantages not obtainable in other forms of headgear for constant use and all-around field-service. It is far superior to the straw hat, and, during the rainy season, to any cork or pith helmet. The latter requires more or less care at all times, both on and off the head.

“A part woollen undershirt is necessary to protect the body from sudden chilling. The cotton or nankeen undershirt is cold, clammy, and sticks to the body while in profuse perspiration. This is especially noticeable during the five minutes' rest given hourly on a regular march.

“The lighter issue of the blue flannel shirt answers fairly well at all times, but is objectionable in some respects. Its color more rapidly absorbs the heat, and can be distinguished a long distance, making the wearer a good mark for the enemy. A gray flannel shirt of medium weight is preferable. The flannel shirt has the advantage of keeping the body warm, even when wet, night and day. The soldier prefers to wear the blue flannel shirt on the march, with no undershirt, the sleeves rolled up, open in front, and the collar well rolled back. It is thus made very comfortable, the campaigner readily becoming accustomed to the sun's rays. One great objection to this shirt is its irritating effect on the skin. On returning to camp at night the soldier puts on the cotton undershirt as a protection against this irritation.

“Of the clothing furnished at present for active campaigning I have found that the light-gray woollen undershirt of light weight, with an overshirt of chambray or gingham, gives comfort and satisfaction. Personally I have found the most comfort from the gray outing flannel of medium weight, worn with no undershirt. This same material of a khaki color would be still better. It prevents chilling; is never too warm, nor sticks to the body, but absorbs the perspiration and dries readily. A cotton undershirt worn under this while in camp gives one the greatest amount of comfort, and is sufficiently warm for the night. As the nights here are usually cool, sufficient covering for the abdomen must be worn. For this the

blue flannel shirt answers well; in fact, it has become quite customary when not on the march, but lying in camp, for the soldiers to wear the blue flannel shirt at night. The coolness of the night while lying down is severely felt upon the abdomen often enough to keep one awake and interrupt his rest. Even a slight covering is a help, and for this the flannel belly-band is worn. The neglect of this is undoubtedly the predisposing, if not the actual exciting cause of many of our intestinal ailments.

“The white jean drawers answer all conditions at all times; they are loose, comfortable, and safe.

“The khaki fatigue uniforms are excellent.

“During the wet season the large pouches now furnished are of more service than the rain coat or mackintosh. They protect sufficiently well and are not as hot as the mackintosh; besides they serve as a blanket or covering at night.”

Camps.—Tents.—The tents used in the army are the hospital tent, the officers' wall tent, the A-tent, and the shelter tent, which is a modification of the last. Soldiers give the preference to the shelter tent, which is light, each man's piece weighing only 1.18 kilograms. Two pieces being joined together by buttons and button-holes, and thrown over a ridge pole supported by four uprights, and the four corners fastened to pegs driven into the ground, form a tent 1.2 meters high, 1.65 meters long, and having a spread at the base of between 1.8 and 2.1 meters. Such a tent will form a comfortable shelter for two men, unless there should be strong winds or driving rains, when the ends should be closed by blankets or an extra piece of shelter tent. The uprights and ridge are steadied by short guy ropes, one of which is furnished with each piece of tent.

Location of the Camp.—The camp should not be located on a spot that has recently been used for the same purpose. Camp sites should also be frequently changed, in order to avoid the effects of soil pollution

which might result from long-continued occupation. The camp site should be selected with reference to several important particulars. The soil of the locality should be dry, sandy in character, and well drained. The site should also be so located as to afford a plentiful supply of pure and wholesome water. Too much stress cannot be laid upon this point. Low-lying, damp, or marshy localities should be avoided for obvious reasons.

The camp should be laid out in regular order with streets, so as to provide ways of passing freely through the camp. The camp should be as compact as will be permissible with health and cleanliness.

A trench, at least 10 centimeters in depth, should be dug around each tent, so as to exclude surface water, and this should lead, with the trenches from the other tents, into a larger one for each street, so as to conduct the rain-water from the camp-ground.

Sanitary Policing of the Camp.—Frequently this matter is left to hired civilians, though not always. The camp streets should be cleaned regularly every day and all rubbish burned as promptly as possible. All kitchen refuse should be collected twice a day and removed from the camp-grounds or buried in trenches dug for the purpose. The tents should be aired each day by opening the doors and raising the walls after the men have left them in the morning. All bedding should likewise be exposed to the air every day unless the weather is such as to prevent it.

Water-supply.—There should be an abundant supply of pure water for all purposes for which it is needed. Where the wholesomeness of the water is doubtful, some method of purification should be provided. For this purpose the Forbes portable water sterilizer (Fig. 55) is now frequently employed.

This apparatus is in very common use in the various army camps in the tropics, and the universal report is most favorable as to its efficiency in preventing the development of typhoid fever and diarrheal diseases

among the troops. Even in localities where typhoid fever prevailed the introduction of the apparatus and the exclusive use of boiled or sterilized water arrested the outbreak.



FIG. 55.—Forbes' portable water sterilizer, army type.

A board of army surgeons, consisting of Majors Reed, Shakespeare, and Vaughn, appointed for the purpose of testing various types of apparatus submitted to the war department for use in sterilizing water in the field, report that "all living micro-organisms, except a few spore-bearing bacteria, are destroyed by the degree of heat attained during the passage of the water through the apparatus. The disadvantage of the escape of a few spore-forming bacteria through this apparatus is con-

sidered to be of no practical importance by the Board." They also found that "there is no loss of the natural gases during the passage of the water through the apparatus."

Provision should be made of ample opportunities for bathing. In the absence of large bodies of water in the vicinity of the camp permitting the soldiers to engage in swimming, shower-baths, at least, should be supplied at convenient points on the camping-ground.

Latrines.—The latrines should be situated from 140 to 150 meters to the leeward of the camp. A deep and narrow trench should be dug for the purpose. It must not be too wide, or it will require more earth to cover the excreta. At least three times each day the excreta should be covered with earth to a depth of 2 to 3 decimeters, or with slaked lime. The dry earth readily absorbs the putrifying material and thus renders it inoffensive. The bacteria in the soil destroy the organic matter contained in the excreta, thus rendering them harmless. This procedure will protect the excreta from flies and insects, and limit one source of danger of general infection should there be unrecognized cases of typhoid fever in the camp. The excreta of all cases of typhoid fever and dysentery should be disinfected at once. They should never be thrown into the trenches without this precaution. The excreta in the trench may also be burned daily by pouring kerosene upon them and applying the torch. In the tropics, during the rainy season, the dry-earth closet is being used for hospitals and camps in towns. The excreta are collected in galvanized vessels, covered with dry earth, and emptied at frequent intervals. New sinks should be dug when the old ones are filled to within 6 decimeters of the top, the old sinks being completely filled with earth.

Barracks.—Besides healthful sites, the essential conditions of barracks are dryness, warmth, light, amount of floor space, and air-supply.

In the squad-room each man should have at least 30

cubic meters of air space and 465 square decimeters of floor space, and south of 36 degrees north latitude the proportions should be 40 and 665, respectively.

There should be more space allowed if the barracks are constantly occupied, because the dimensions given are

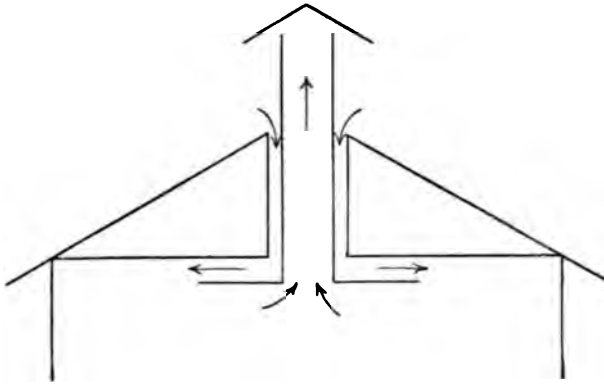

FIG. 56.—Diagram illustrating ridge ventilation.

too low for constant occupation during active exercise. The official recommendations for English troops in India range from 75 to 150 cubic meters of air space, and from 620 to 1240 square decimeters of floor space.

The squad room should be not less than 35 decimeters nor more than 42.5 decimeters in height, and preferably about 70 decimeters wide. Excessive height and width should be avoided because of greater difficulty in efficient ventilation.

Ridge ventilation is perfectly satisfactory for barracks, or it may be accomplished by means of double inlet and outlet tubes in the roof (see Fig. 56), so constructed that the fresh air enters through the outer tube and the vitiated air takes its exit through the inner tube.

There should be ample provision for bathing, and the water supplied as pure as can be obtained. If its purity is open to question, it should be purified by sterilization, boiling, or filtration.

The latrines require careful attention. If it is possible

to use water-closets, these will give rise to least difficulty. If the dry-earth closet system is employed, the receptacles should be emptied at frequent intervals. This work is often delegated to civilians. The latrines should not be near the kitchen or mess-room, nor near the sleeping-quarters of the troops.

The kitchens should be in separate buildings from the sleeping-quarters, or at least removed from them as far as possible.

When numerous cases of tonsillitis occur in barracks, deficient ventilation may usually be suspected. The accumulation of infective dust, along with vitiated air, in barracks is frequently the predisposing cause of tuberculosis and pneumonia among troops.

Marches.—The effects of marches are dependent upon the distance covered, the rate of travelling, the load carried by the soldier, the condition of the weather, and the character of the roads. An important influence upon the soldier during long marches is the length of the step taken and the number of steps per minute.

At the end of each hour a rest of at least five minutes should be allowed. This will permit the fatigued soldier to recuperate, at least partially, and increases his endurance to a very large extent. Whenever possible, marches should be made before ten in the morning or after five in the afternoon if the weather is warm, and the troops should be allowed to rest during the hottest part of the day.

The canteens are to be filled with water or tea before beginning a march, but no fluid should be drunk while marching, or as little as possible, and then only in small quantities at a time.

Under ordinary conditions, both in cold and hot countries, the men are healthy on the march. But marches are sometimes harmful :

1. When a single long and heavy march is undertaken, when the men are overloaded, without food, and perhaps without water.

2. When the marches, which singly are not too long, are prolonged over many days or weeks without rest.

3. When special circumstances produce disease.

Camp Diseases.—The value of hygienic measures in the army, and the destructive effects of diseases, are clearly shown by the records of the Civil War of 1861–65, when the casualties of battle were exceeded fourfold by the deaths caused by diseases, the most important and fatal of which were pneumonia, typhoid fever, diarrhea, and dysentery. During the Spanish-American War, in spite of the great advancements in our knowledge of the etiology and modes of dissemination of typhoid fever, a very large proportion of the army was rendered useless for several months owing to the prevalence of this disease alone.

The close companionship entailed by the military service and the neglect of individual cleanliness are largely blamable for the wide dissemination of typhoid fever, diarrhea, and dysentery. Under these conditions it would seem a much greater degree of personal cleanliness is necessary than in private life. Another factor to be considered is the large number of mild cases, the so-called "walking" cases, which prevailed in some of the camps during the late war. Aside from this the influence of infected dust and the agency of flies and insects must also be taken into consideration.

The value of antityphoid vaccination, first introduced into the English army by Sir A. E. Wright, and since adopted by the German army, is, beyond question, limiting the incidence of the disease and reducing the mortality. The adoption of this method of protection for the soldiers of the United States army has already brought the sickness-rate and the death-rate from typhoid fever to comparatively low figures. All new recruits under thirty-five years of age are obliged to be inoculated on enlisting in the service.

Pneumonia and acute bronchitis are more prevalent during the winter months, and these are traceable to exposure, dampness, imperfect nutrition, insufficient

clothing, these being the most common predisposing factors. Rheumatism also is favored by the same predisposing causes.

In certain localities malarial fevers also prevail to a considerable extent among soldiers. This has been the case with our soldiers in the tropics. The preventive measures which would tend to render a malarious locality healthful are draining of damp soil, pouring oil upon all stagnant bodies of water, the protection of the soldier by means of mosquito-bars wherever possible, and the avoidance of exposure after nightfall.

In camps composed of recently enlisted soldiers measles is very likely to make its appearance. Thus far no definite mode of prevention can be outlined against this disease except the prompt isolation of cases as they appear.

Tuberculosis is also prevalent among soldiers. This is the case in both camp and barrack, though in the latter it is encountered most frequently.

Diseases of the heart and blood-vessels are frequent as the result of the strenuous duties of the soldier. Long and forced marches result in the exhaustion of those with a weak circulatory apparatus.

Venereal diseases are always prevalent among soldiers. The prevention of these diseases is a most difficult matter, because it is impossible to control such a large body of men in their moral and social relations. Some good may be accomplished by banishing all known prostitutes from the neighborhood of the camp.

Scurvy is far less frequent than formerly, though it is not unknown even at the present day. This condition may be prevented by proper regulation of the food-supply, since it is known to be a disease due to improper nutrition. Fresh vegetables and ripe fruit are the most serviceable in this respect. In the absence of sufficient supplies of these, the use of lime-juice and vinegar will prove of great value.

Foot Inspection.—In the German army the feet of the soldiers are carefully examined, each man's feet

being inspected by one of his company officers, a medical officer, and the *lazareth helper*, at least twice a week in barracks, and oftener in active field maneuvers. The method of making this inspection is to form the companies in squads, standing upon tables or benches sufficiently high to bring the feet directly under the eye of the inspecting officer, and to bring under his observation any wincing or flinching when the inspected man jumps to the ground barefoot. The inspecting officer passes down the line carefully examining the front of the feet and legs, which are bared to the knees, searching for strained tendons, blisters, improperly cut nails, or untrimmed corns.

Having passed down the line, the men are about-faced and the tendo-achilles carefully examined, and as they raise one foot and then the other the soles are inspected. As a man passes from the table or bench he leaps to the ground and runs to his shoes and stockings. This is to show any bruised soles or periostitis of the tarsus. Any cases of blisters, improperly cut nails, or tenosynovitis are at once cared for by the *lazareth helper*. Those with more serious disorders are sent to quarters or hospital.

At the same time each man's socks and boots are carefully inspected as to the degree of cleanliness. As the infantry regiments average in marching a kilometer in ten minutes, being often pressed to a kilometer in from seven and a half to eight minutes, each man carrying 27 kilograms, this care of feet is necessary. When tables or benches are not available, the trunk of a fallen tree or a block of stone is used as a place to conduct the inspection.

Body Inspection.—The entire body of every man in the German army is inspected by a company officer and a medical officer, careful search being made for any heart lesion, hernia, venereal disorder, skin disease, eczema, etc. This is in order that any physical defect that might be concealed by clothing or by the improper modesty or wilfulness of the enlisted man may be carefully noted, cared for, and reported.

CHAPTER XIV.

NAVAL HYGIENE.

THE term *naval hygiene* usually includes all that relates to maritime life, whether relating to war or to commerce. In a certain sense the application of hygienic measures to such a small and isolated community as found in a vessel is extremely simple. In modern vessels it is far easier than in those of even a decade ago. The improvements in construction, arrangement, and equipment have had a most salient influence upon the health of sailors and marines, and upon the comfort of passengers.

Though there have been important advancements in the construction and arrangement of vessels, it is still a difficult matter to supply pure air in sufficient quantities, because with the advancement in equipment there has been no relative increase of the air space available for each person. The air space on shipboard being necessarily limited, the average space per individual can only be indirectly increased by reducing the number of seamen to the lowest point permissible.

The vessel should be as large as possible with reference to the purpose for which it is intended, the arrangement of machinery and cargo should be such as to economize the utilization of space, and the size and location of the cabins should be regulated so as to afford a maximum amount of space for each person. The arrangement of cabins should be made in such a manner that it may be possible to secure complete isolation of any cases of infectious disease at some point removed from the seamen in their usual duties. The amount of space provided for each seaman is greater than had formerly been the case, but even at the present time it falls below theoretic

standards. The hospital cabins should be of greater space, because they are occupied during every hour of the day. These quarters should not be located in the fore-castle, but at some point as far removed from the noise of the machinery as possible.

The cubic space allotted to each marine on war vessels has not been accurately determined and no data are available on this point. The fact that marines sleep in hammocks may be the cause of supplying a somewhat greater cubic space for them than for sailors on vessels of commerce where hammocks are not employed.

With regard to passenger ships, the German laws direct that each between-deck passenger have an air space of 2.85 cubic meters, and a floor space of 0.45 square meter. For first- and second-class passengers no directions have been made. The English laws direct that each man have 72 cubic feet of air space and 12 square feet of floor space.

Ventilation.—In modern vessels propelled by steam the introduction of forced ventilation by the use of fans or steam jets is a comparatively easy matter. In this manner a definite air-supply can be assured, either by propulsion of fresh air or extraction of the vitiated air. By this method the defects arising from the small amount of air space usually supplied can be remedied to a great extent.

According to information derived from the Bureau of Construction and Repair of the Navy Department of the United States, "All ships of war are ventilated on two principles, natural and artificial. Natural ventilation is obtained through hatches, ventilating ducts, and other openings leading directly to the compartment to be ventilated, and depending upon a supply of air through cowls which are turned toward the wind. All living-spaces are further ventilated artificially, either by means of steam or electric blowers, which supply the air to or exhaust it from the compartments in question. Some compartments are fitted with both supply and exhaust blowers, but in general only one system is fitted, a natural

exhaust being obtained through the hatches or other openings into the compartment.

“No rules can be given for the cubic meters of space allowed per man. This is entirely dependent upon the design of the ship and the number of men carried. The design of the ventilating system, however, is such as to renew the air in various spaces in certain intervals of time, which may be stated approximately as follows: General crew space, the air to be changed once in eight minutes; officers' quarters, once in twelve minutes; engine-room or steering-engine room (where the air is hot and vitiated), once in two minutes; dynamo-room, once every three-fourths of a minute.

“The supply of air to a compartment depends not only on its capacity and the number of men in it, but also upon the temperature, which in some parts of the ship is excessively high, and in others is naturally low. No figures on efficiency are available.”

Dr. Coppinger¹ states that “the question of air space and ventilation, as applied to men-of-war, has always been a difficult problem, and the progress of modern naval architecture, necessitated by altered conditions of warfare, tends in many ways to make its solution more difficult of attainment. Among these conditions may be mentioned (1) the very great amount of air space occupied by machinery and stores connected with torpedo work, and (2) the introduction of water-tight bulkheads. These latter partitions are a great source of difficulty in respect to obtaining complete circulation of air throughout the ship.

“The introduction of the turret and barbet system of construction into battleships, with the consequent reduction and almost complete abolition of apertures for natural ventilation by means of ports and hatchways, has rendered necessary a very general introduction of artificial ventilation by means of rotary fans, to supplement artificial ventilation by means of funnel and funnel casing.”

¹ *Trans. Seventh International Congress of Hygiene.*

In order to cool the air between decks of vessels while in the tropics, it has been suggested that this might be accomplished by the aid of compressed air. This may be utilized both as a source of motion for propelling the air and also to abstract heat when undergoing expansion.

Heating of the Vessel.—The application of steam to navigation makes it possible to utilize the exhaust steam for purposes of heating. This precludes the attempt to heat by any other methods, and affords a safe and satisfactory solution to this problem, which formerly gave rise to such great difficulties.

Lighting.—The employment of electricity on all large modern vessels makes it possible to utilize this method of lighting; thus a great factor in the vitiation of the air in certain parts of ships is removed.

Cleansing the Vessel.—The excessive use of water for purposes of cleansing should be prohibited. It was formerly the custom to keep the floors constantly soaked by the frequent washing of the ship, thus giving rise to a most unhealthful condition from dampness. A satisfactory degree of cleanliness can be maintained without the constant application of copious amounts of water, and with the use of steam for heating purposes modern vessels are much dryer than formerly, and consequently more healthful.

The interior of iron ships is apt to be damp on account of the condensation of moisture on the sides of the vessels. The prevention of the condensation of moisture is sought through the application of paint containing small particles of cork, or a cork lining. The use of wood in modern warships has been avoided as much as possible for two reasons: First, the danger from fire; and second, the disastrous effects from splintering of the wood by perforating shot. The first objection to the use of wood is efficiently removed by the use of fire-proofing materials which have lately come into use, but the second objection remains.

Water-supply.—Great care should be exercised in

taking on board a supply of pure and wholesome water for culinary purposes. In the event of a pure water-supply being unavailable, the necessary apparatus should be on board for sterilizing the water or for distilling sea water. Water-closets and bath-rooms should be installed in different parts of the ship, so as to be conveniently accessible.

Food-supply.—In the case of ships of commerce it is comparatively easy to maintain a fairly satisfactory supply of food. In the case of war vessels the State supplies prescribed rations, which, however, can be supplemented, if necessary, by additional purchases when beyond the base of supplies. Moreover, modern war vessels are equipped with refrigerator appliances, so that fresh meat and vegetables may be carried long distances.

The following is the daily ration supplied to United States marines, based upon the amounts supplied weekly :

| | | |
|--|-----|--------|
| Biscuit, cornmeal or oatmeal | 454 | grams. |
| Fresh meat, or | 567 | " |
| Tinned meat, or | 454 | " |
| Salted beef or pork | 340 | " |
| Peas, beans, or tomatoes, or | 227 | " |
| Fresh vegetables, or | 567 | " |
| Canned vegetables | 170 | " |
| Butter | 24 | " |
| Coffee, or | 57 | " |
| Tea, or | 14 | " |
| Cocoa | 57 | " |
| Pickles | 32 | " |
| Syrup | 16 | " |
| Vinegar | 32 | " |

The diet should be regulated so as to avoid undue monotony. The harmful influences of excessive amounts of salted meat should be overcome by the use of refrigerated or preserved meats and the use of sufficient amounts of vegetables and fruit. Besides guarding against the use of improper proportions of certain food elements at all times, it is necessary to adapt the dietary to the climate as well as to the nature of the work done by the men. The diet should at all times be sufficient to nourish prop-

erly the men under whatever external conditions they may be placed.

Dr. Henry G. Beyer¹ calculates that the regular naval ration affords daily 142 gm. nitrogenous matter, 51 gm. fats, and 398 gm. carbohydrates.

On German war-vessels each man receives daily 150 gm. nitrogenous materials, 500 gm. carbohydrates, 100 gm. fats, 35 gm. salt. In the German navy scorbatus is prevented by giving each man 20 grams of citric acid daily when the voyage is longer than fourteen days, especially in the tropics.

Clothing.—The clothing of marines is adapted to the climate of the locality and the season of the year. During hot weather white duck uniforms are worn, while in cold weather woollen clothes and underclothes are supplied. In the navy the question of clothing does not require the same degree of attention and forethought as is often the case in the army, because each individual sailor is not required to carry his wardrobe on his back wherever he goes.

Selection of Marines.—In the selection of marines the same careful physical examination is necessary as in the selection of recruits for the army. This physical examination is directed to the determination of the age, height, weight, chest measurement, sight, and hearing of the applicant. As the result of the careful physical examination of the nude bodies of 6129 lads applying for admission to the U. S. Naval Academy at Annapolis, Dr. Gihon found the following means at different ages (see page 324):

Dr. Gihon concludes that at every age there is a latitude of from 22.5 to 27 kilograms in weight, 17.7 to 21.8 centimeters in height, and 15.2 to 17.7 centimeters in circumference of chest, within which over 99% of every 1000 adolescents will be found, and "it must be recognized as a fact that perfect health and bodily vigor, and the development peculiar to the type and temperament

¹ *Proceedings U. S. Naval Institute*, p. 120, 121.

Table showing Means for Annual Periods, and for Each Year.

| Ages. | Weight. | | Height. | | Circumference of chest. | | Expansion. | | Strength. | | Vital Capacity. | | | |
|---------------------------|---------|------|---------|-------|-------------------------|------|------------|-----|----------------|-------------|-----------------|---------|-------------|---------|
| | Pounds. | Kg. | Inches. | Cm. | Inches. | Cm. | Inches. | Cm. | Pounds lifted. | Kg. lifted. | Gihon. | | Hutchinson. | |
| | | | | | | | | | | | Cu. in. | Liters. | Cu. in. | Liters. |
| From 13 to 14 years . . . | 83.5 | 37.8 | 57.8 | 146.7 | 27.8 | 70.5 | 2.5 | 6.3 | 155 | 70.2 | 157 | 2.57 | 160 | 2.62 |
| At 14 years | 85.6 | 38.7 | 59.6 | 151.3 | 28.2 | 71.5 | 2.5 | 6.3 | 169 | 76.5 | 157 | 2.57 | | |
| From 14 to 15 years . . . | 95.9 | 43.4 | 61.1 | 155.1 | 29.0 | 73.6 | 2.3 | 5.6 | 188 | 85.1 | 186 | 3.04 | 182 | 2.98 |
| At 15 years | 99.7 | 45.1 | 62.3 | 158.1 | 29.5 | 74.9 | 2.4 | 5.8 | 195 | 88.3 | 172 | 2.81 | | |
| From 15 to 16 years . . . | 106.4 | 48.0 | 63.9 | 162.2 | 30.3 | 76.9 | 2.5 | 6.3 | 203 | 91.9 | 197 | 3.23 | 198 | 3.24 |
| At 16 years | 111.9 | 50.6 | 64.6 | 164.0 | 30.9 | 78.4 | 2.5 | 6.3 | 214 | 96.9 | 203 | 3.32 | | |
| From 16 to 17 years . . . | 116.2 | 52.5 | 65.4 | 166.0 | 31.5 | 80.9 | 2.6 | 6.6 | 220 | 99.6 | 210 | 3.44 | 214 | 3.50 |
| At 17 years | 117.3 | 43.1 | 65.6 | 166.5 | 31.8 | 81.7 | 2.7 | 6.8 | 230 | 104.1 | 214 | 3.50 | | |
| From 17 to 18 years . . . | 123.0 | 55.7 | 66.4 | 168.5 | 32.3 | 82.0 | 2.8 | 7.1 | 236 | 104.4 | 219 | 3.58 | 222 | 3.63 |
| At 18 years | 128.2 | 58.0 | 66.8 | 169.6 | 32.8 | 83.2 | 2.9 | 7.3 | 246 | 111.4 | 224 | 3.67 | | |
| From 18 to 19 years . . . | 130.1 | 58.9 | 66.9 | 169.8 | 33.1 | 84.0 | 3.1 | 7.8 | 239 | 104.5 | 227 | 3.71 | 226 | 3.70 |
| At 19 years | 131.0 | 60.7 | 67.3 | 170.8 | 33.4 | 84.8 | 3.1 | 7.8 | 248 | 112.3 | 234 | 3.83 | | |
| From 19 to 20 years . . . | 133.3 | 60.3 | 67.3 | 170.8 | 33.4 | 84.8 | 3.1 | 7.8 | 256 | 115.9 | 230 | 3.76 | 230 | 3.76 |
| At 20 years | 134.1 | 60.7 | 67.4 | 171.1 | 34.4 | 84.8 | 3.0 | 7.6 | 275 | 124.5 | 234 | 3.83 | | |
| From 20 to 21 years . . . | 135.7 | 61.4 | 67.4 | 171.1 | 33.8 | 85.8 | 3.1 | 7.8 | 276 | 125.0 | 236 | 3.84 | 230 | 3.76 |
| At 21 years | 135.4 | 61.3 | 67.4 | 171.1 | 33.8 | 85.8 | 3.0 | 7.6 | 278 | 125.9 | 233 | 3.81 | | |
| From 21 to 22 years . . . | 135.3 | 61.2 | 67.4 | 171.1 | 33.9 | 86.0 | 3.0 | 7.6 | 279 | 126.3 | 239 | 3.91 | 230 | 3.76 |
| At 22 years | 134.7 | 61.0 | 67.3 | 170.8 | 33.8 | 85.8 | 3.1 | 7.8 | 279 | 126.3 | 234 | 3.83 | | |
| From 22 to 23 years . . . | 136.9 | 62.0 | 67.6 | 171.8 | 34.0 | 86.3 | 3.2 | 8.1 | 265 | 120.0 | 242 | 3.96 | 234 | 3.83 |
| At 23 years | 136.2 | 61.6 | 67.5 | 171.6 | 33.6 | 84.5 | 3.5 | 8.8 | 276 | 125.0 | 237 | 3.88 | | |
| From 23 to 27 years . . . | 139.0 | 62.9 | 67.8 | 172.3 | 34.5 | 87.0 | 3.5 | 8.8 | 252 | 114.1 | 244 | 3.99 | 234 | 3.83 |

of the individual, are not inconsistent with an average departure below the mean of 12 kilograms in weight, 10 centimeters in height, and 7.5 centimeters in circumference of chest."

Enlistment of boys in the U. S. naval service is made under the following regulations:

"1. Boys between the ages of fifteen and seventeen years may, with the consent of their parents or guardians, be enlisted to serve in the navy until they shall arrive at the age of twenty-one years.

"2. No minor under the age of fifteen years, no insane or intoxicated person, and no deserter from the naval or military service of the United States, can be enlisted.

"3. Boys enlisted for the naval service must be of robust frame, intelligent, of perfectly sound and healthy constitution, and free from any of the following defects:

"Greatly retarded development; feeble constitution, inherited or acquired; permanently impaired general health; decided cachexia, diathesis, or predisposition; weak or disordered intellect; epilepsy, or other convulsions within five years; impaired vision or chronic disease of the organs of vision; great dulness of hearing or chronic disease of the ears; chronic nasal catarrh; ozena, polypi or great enlargement of the tonsils; marked impediment of speech; decided indications of liability to pulmonary disease; chronic cardiac affection; hernia or retention of testes in inguinal cavity; cirrhosis, hydrocele, stricture, fistula or hemorrhoids; large varicose veins of lower limbs; aneurism of cord; chronic rheumatism; syphilis and communicable diseases; unnatural curvature of the spine; vertebrae or other deformity; permanent lameness of either of the extremities or articulations from any cause; defective teeth; the loss or extensive caries of four or more teeth.

"4. Physical examinations will be made by the medical officers of the ship upon which a boy presents himself for enlistment.

"5. Boys must have the following qualities and none of the following defects:

| Age. | Height not less than— | Weight not less than— | Chest measurement, breathing naturally, not less than— |
|---------------------|-----------------------|-----------------------|--|
| Fifteen years . . . | 4 feet 11 inches. | 80 pounds. | 27 inches. |
| Sixteen years . . . | 5 feet 1 inch. | 90 pounds. | 28 inches. |

“6. They must be able to read and write.

“7. In special cases, where a boy shows general intelligence, and is otherwise qualified, he may be enlisted notwithstanding his reading and writing are imperfect.

“8. Each boy presenting himself for enlistment must be accompanied by his father, or by his mother in case the father be deceased, or by his legally appointed guardian in case he has neither father nor mother living, and the parent or guardian presenting the boy must sign the prescribed ‘Consent, declaration, and oath,’ which forms part of the shipping articles.

“9. In cases where parents or guardians may, by reason of distance, infirmity, or other causes, be unable to appear at the place of enlistment, they will, on written application to the commanding officer of either of the ships upon which enlistments are made, be furnished with the printed form of ‘Consent, declaration, and oath,’ in duplicate, by executing which the enlistments will be perfected, should the boys be accepted by the board of examining officers.”

“On first enlistment men must be between the following ages:

| Rating. | Years of age. | Rating. | Years of age. |
|-------------------------------------|---------------|--------------------------------------|---------------|
| Seamen | 21 to 35 | Firemen, second class | 21 to 35 |
| Ordinary seamen | 18 “ 30 | Coal-passers | 21 “ 35 |
| Landsmen | 18 “ 25 | Hospital stewards | 21 “ 30 |
| Shipwrights | 21 “ 35 | Hospital apprentices, 1st class | 18 “ 25 |
| Blacksmiths | 21 “ 35 | Hospital apprentices, 2d class | 18 “ 25 |
| Plumbers and fitters | 21 “ 35 | Officers’ stewards | 21 “ 35 |
| Sailmakers’ mates | 21 “ 35 | Officers’ cooks | 21 “ 35 |
| Machinists, first class | 21 “ 35 | Mess attendants | 18 “ 30 |
| Machinists, second class | 21 “ 35 | Ships’ cooks, fourth class | 18 “ 30 |
| Electricians, third class | 21 “ 35 | Musicians, first class | 21 “ 35 |
| Boilermakers | 21 “ 35 | Musicians, second class | 21 “ 35 |
| Coppersmiths | 21 “ 35 | Buglers | 21 “ 35 |
| Firemen, first class | 21 “ 35 | Painters | 21 “ 35 |

PRINCIPAL DISEASES AMONG MARINERS. 327

“Minimum height for ratings herein mentioned, 5 feet and 4 inches, stripped; the candidate should be well developed, considering his age and height.

“Persons possessing a mechanical trade may be enlisted even if over twenty-five, provided they are under thirty-five years of age.

“No person, except an honorably discharged ex-apprentice, shall be enlisted as a seaman unless he shall have been four years at sea, nor as an ordinary seaman unless he shall have been two years at sea before the mast. In both cases applicants shall be required to pass a satisfactory examination.”

The general appearance of the applicant is also taken into consideration, and those that are uncleanly in their person or attire are discarded because they prove incapable of efficient training.

Recently the character of the teeth in applicants for both the naval and military service has been taken into consideration. It is evident that a man whose grinding and biting capacity is seriously impaired will more readily suffer from gastro-intestinal trouble than one with a full set of perfect teeth. The loss of five teeth, absent or unsound in any degree, is usually considered as cause for rejection; even the loss of three or four molars or incisors in the same jaw is sufficient to render a young man unfit for service in the navy.

Principal Diseases among Mariners.—The average strength of the active list of the U. S. Navy for the year 1899 was 20,019. The total number of admissions for disease was 12,794, and for injuries 2955, giving a ratio per 1000 of strength of 636.11 and 146.92, respectively. During the year there were admitted to the sick list, of the total force—

| | | | |
|--------------------------------|------------|----------------------------|------------|
| Malarial diseases | 943 cases. | Epidemic catarrh | 672 cases. |
| Diarrheal affections | 900 “ | Dengue | 297 “ |
| Wounds | 884 “ | Alcoholism | 193 “ |
| Rheumatic affections | 716 “ | Heat-stroke | 154 “ |
| Bronchial affections | 685 “ | Typhoid fever | 134 “ |

| | | | |
|----------------------------------|------------|-------------------------|-----------|
| Pneumonia | 117 cases. | Nephritis | 31 cases. |
| Pulmonary tuberculosis | 87 " | Scarlet fever | 29 " |
| Dysentery | 68 " | Yellow fever | 8 " |
| Organic heart-disease | 42 " | Small-pox | 6 " |
| Measles | 37 " | | |

Of the 943 cases of malarial diseases, nearly one-third were from the navy-yard and marine headquarters, Washington, D. C. ; of the 134 cases of typhoid fever reported during the year, 49 were under treatment in the naval hospital, Newport, R. I. Of this number, 45 originated among the *personnel* of the training station, 1 was received from the torpedo station, and 3 from ships of the North Atlantic squadron.

CHAPTER XV.

SOIL.

THE nature of the soil in its relation to health is an important subject. The relation of the soil of a locality to the public health is dependent upon its intimate structure. Soils are composed of varying proportions of mineral, vegetable, and animal constituents. These constituents vary in size not only in different localities, but even in the same locality. The interstices of the soil are filled either with air or with water. A soil is moist or dry according to the preponderance of small- or large-sized soil-particles. The finer and more uniform the soil-particles, the greater the amount of moisture usually contained in the soil.

All soils are porous, and contain varying amounts of air and moisture. The relation of the soil to health is influenced by the amount and nature of the contained air and water. The degree of purity of the ground-air and ground-water is influenced by the amount and nature of the vegetable and animal organic matter contained in the soil, and the temperature of the locality—whether favorable or unfavorable to the decomposition of organic matter through the agency of bacteria.

Ground-air.—Ground-air is usually rich in carbon dioxid, derived from decomposing organic matter in the soil. It is also very moist, because there is usually plenty of opportunity to take up moisture. It also contains decomposition-products, such as marsh-gas, hydrogen sulphid, and ammonia. This air is, consequently, not suitable for respiratory purposes. The amount of soil-air that gains access to houses under ordinary conditions is, however, so small that its influence prob-

ably is not felt. In newly made soils, in which there is considerable decaying organic matter, there is some danger of the entrance of large amounts of ground-air into houses built on such soils unless special provision is made to exclude it. In such houses there should be cemented foundation walls and cellars, and the supply of fresh air should be derived from the outside at some distance above the ground. Unless the foundation walls and cellars are cemented, the houses, when warmed, may serve as immense chimneys in extracting the air from the surrounding soil.

Ground-water.—Ground-water is rain-water that has fallen upon the soil of the locality and penetrated its surface. It differs from stored rain-water according to the nature of the soil constituents. It is richer in dissolved solids, and contains also the products of decomposition derived from decaying organic matter in the soil. It contains also numerous bacteria derived from the soil. The relation of ground-water to health is directly dependent upon the presence or absence of pathogenic bacteria in the soil, and the presence or absence of mineral constituents derived from the soil which may be injurious to health, such as salts of calcium, magnesium, or iron in large amounts.

Pettenkofer's theory of the relation of soil moisture to typhoid fever and cholera is no longer tenable. We know now that the height of the level of the ground-water has no direct influence in the production of either of these two diseases. There is evidently an indirect relation between low ground-water and the development of these diseases, because at such times the drainage area of all wells is increased, and the polluting material in or upon the soil of a correspondingly greater area is conducted into the well. In the same manner, when drinking-water is derived from streams, there is greater opportunity for the entrance of concentrated polluting matter into the stream, and it exists there in a more concentrated form than in times of flood.

The relation of a damp soil to the greater prevalence of consumption, as originally pointed out by Bowditch, cannot be regarded as a direct one. The damp soil probably predisposes to colds and diseases of the lungs, and thus paves the way for the contraction of consumption. There is thus far no evidence that the bacillus of tuberculosis is capable of multiplying in damp soils.

The relation of damp, marshy soils to malaria has received a great deal of elucidation in recent years. It is believed at the present time that the malarial organism is contracted most frequently, if not entirely, through the sting of a particular genus of mosquito—*Anopheles*. These mosquitoes are usually indigenous to the soil of certain marshy localities, but thus far no definite relation between the nature of the soil of these localities and the prevalence of mosquitoes has been demonstrated. Marshy localities, when drained so as to prevent the development of mosquitoes, also become healthful and free from malaria. Where drainage is impossible, it is known that the application of some oil, such as crude petroleum, on the surface of the water will prevent the development of the mosquitoes and thus eradicate malaria from those localities.¹

Damp soils are likely to be productive of diarrheal diseases, though these affections are most probably brought about by certain bacteria in the soil along with the detrimental influence of the dampness itself. The amount of decaying organic matter in and upon the soil is most probably in direct relation to the prevalence of diarrheal diseases in a locality.

In the same manner the amount of moisture in the soil will influence the prevalence of other diseases, such as rheumatism, bronchitis, pneumonia, and the exanthemata. The relation of soil moisture to these diseases is probably only an indirect one, in that it tends to lower

¹ Recent studies in Africa indicate that probably other diseases, especially filariasis, are conveyed by species of mosquitoes.

the general vitality of the individuals living in the locality.

Pathogenic Bacteria in Soil.—Some of the pathogenic bacteria are apparently capable of living in the soil for a long time, and some of them may even be able to multiply in the soil. Among these, *Bacillus anthracis*, *Bacillus tetani*, and *Bacillus œdemæ* are perhaps most capable of subsisting in the soil because of their faculty of passing into the spore stage. *Bacillus sporogenes* of Klein may also be included in this class.

Bacillus typhosus and the cholera organism are less tenacious, and die after a time through the detrimental influence of the soil organisms. *Bacillus tuberculosis* can remain alive in soil for some time when protected from the influence of soil organisms, though the danger of infection through polluted soil is probably a remote one. The pyogenic cocci and the diphtheria bacillus cannot exist in the soil for any length of time unless protected from the influence of the soil organisms.

Improvement of a Damp Soil.—A damp soil may be improved by opening the outflow or by laying a system of underground drains. The construction of sewers often serves to drain the soil to a considerable extent because the ground-water follows the outside of the sewer.

Configuration of the Surface and Soil-covering.—Aside from the intrinsic nature of the soil itself, and the character and amount of air and water contained in its interstices, the healthfulness of a soil is influenced also by the configuration of the surface, the condition of the surface, and the nature of the soil-covering. With regard to the configuration of the surface, it may be said that, as a rule, highlands are more healthful than lowlands. The degree of healthfulness of lowlands is influenced by the nature of the soil composing them. The condition of the surface of the soil with regard to soil-covering which is least healthful is what is known as a desert. Here the soil is exceedingly dry and cannot be cultivated.

Cultivated areas and areas covered with forests are more healthful, because the soil is shaded and thus the heating effect of the sun's rays is partly excluded. Cultivated areas that are thickly populated are less healthful because of the organic impurities which gain access to the soil. The soil of cities can be maintained in a comparatively healthful condition only by systematic drainage, so as to carry away all the organic impurities without contaminating the soil, air, or drinking-water.

CHAPTER XVI.

HABITATIONS.

THE first consideration in the selection of a site for a habitation is the nature of the soil with regard to dampness and organic impurity, since these are the principal factors in rendering a soil unhealthful. The house should stand upon a site the subsoil of which is naturally dry, or is properly drained and free from impurity. The configuration of the surface, the elevation, and the exposure are important features in rendering the locality favorable for a healthy habitation. The nature, source, and amount of the water-supply should be investigated. The possibility for the economic and safe disposal of all refuse matter must also be considered. The locality should be sufficiently elevated to secure good drainage away from the house. A southern exposure is preferable, especially in colder climates. The proximity of large bodies of water and of marshy areas have detrimental influences upon the healthfulness of the locality.

The habitation should be so situated with relation to others surrounding it that an abundant supply of fresh air and sunlight can be secured. The healthful influences of sunlight and fresh air cannot be ignored. The absence of sunlight and deficiency of fresh air are the most important factors in inducing disease in the homes of the poorer classes in our large cities.

Position of the House.—If possible, the house, especially when located on open ground, should face the south or west, in order to secure the greatest amount of sunlight in that portion of the house most constantly occupied. The windows require protection with blinds and awnings in summer, to exclude the heat and glaring

effect of the sun; but in winter the full and free action of sunlight should be secured, at least during a part of each day, because of its purifying influence upon the air of the house.

Foundation and Walls.—The foundations and walls should be as dry as possible, and in damp soils this can be secured only by draining the subsoil below the foundations, and by cementing the foundation walls and cellar floor. If there is no cellar, the floors should be raised about 0.5 meter above the ground, so as to secure thorough ventilation beneath the floor. Dryness of the walls

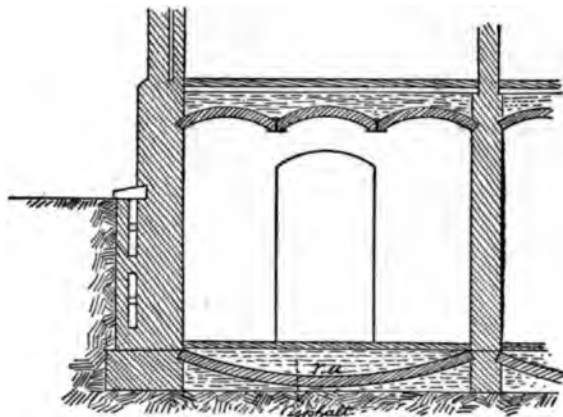

FIG. 57.—Double foundation walls.

is best secured by means of hollow walls (Fig. 57), or by coating the walls with cement or slate. Bricks are quite porous and absorb a great deal of moisture, and thus render the walls damp. Stone also is porous and retains moisture for a long time, consequently stone houses are liable to be damp.

The Roof.—The roof of the house must be carefully constructed and frequently examined in order to prevent leaking. The material composing the roof is of no vital importance so long as it excludes rain. The rain-water falling upon the roof should be conducted away from the

house, so as to prevent the soil of the locality from becoming unduly damp from this cause.

The Interior Arrangement.—The interior of the house should be arranged so as to afford the greatest facility for the use of every part of it for the purposes for which it is intended. The stairways should be wide and the steps broad, with easy slope, so as to prevent fatigue as much as possible in going from one floor to another. The rooms on each floor should communicate with each other, or with a common hallway, so as to favor easy access and insure more efficient ventilation.

Size of the Rooms.—The size of the rooms is a matter of the greatest importance in maintaining the purity of the contained air. The detrimental influence of insufficient air space is well known. The point of greatest hygienic importance is not *how many rooms* a person has, but *how much room*. A small room may be overcrowded with a single person in it, while a large room is not overcrowded with four to six persons in it. Aside from the matter of cubic space, the question of the dimensions of the room is of the greatest importance. The minimum amount of cubic space allowable in sleeping-rooms per adult person is 25 cubic meters. It is evident that a room 3 meters high is far more easily ventilated than one that is 10 meters high with the same amount of air space. Sleeping-rooms should be at least 2.75 meters high, though a height much in excess of 3 meters is not desirable. A room less than 2 meters in height is not suitable for a sleeping-room. The floor space of a sleeping-room should be at least 8 square meters. The living-rooms of a house should possess a cubic space of about 30 cubic meters.

If the arrangements for ventilation are efficient, the air will require to be changed about three times an hour in a room of 25 to 30 cubic meters capacity, while in a room of only 10 to 12 cubic meters the air must be changed seven to eight times an hour in order to maintain its purity. The living-rooms of a house should be

correspondingly larger than the sleeping-rooms, in order to accommodate the larger number of persons occupying them, and the greater amount of exhalation from the body, and the greater amount of impurity derived from heating and lighting. It has been estimated that every lighted gas-burner requires from 300 to 400 cubic meters of fresh air per hour in order to prevent an undue amount of pollution of the air of a room from this source, and to maintain the standard of purity.

The Sleeping-rooms.—Lawson Tait, in a recent paper, gives his views on bed-rooms and bed-room furniture, based on a lifelong experience and observation. He directs that the bed-room shall have a capacity of 56 cubic meters, with tight-fitting doors and windows, and a ventilating flue of at least 1.5 decimeters in diameter. The window-panes should be of plate glass to prevent the too rapid cooling of the air of the room. He advises the construction of houses with double walls, with an air space between them of at least 0.75 decimeter, in order to prevent dampness of the walls. If possible, the room should be warmed by means of gas, as this is the best means of maintaining a uniform temperature. He directs that the bedstead shall be of steel or iron, 2 meters in length, and of a width sufficient to accommodate only one person. Two such bedsteads should be placed side by side. The danger of communicating such a disease as consumption from one person to another while sleeping together is quite evident. The healthfulness of single beds is generally recognized, though in America, as in England, they are not in very common use.

Since we have learned the great value of the open-air treatment of tuberculosis and other diseases, the advisability of spending more of our time in the open air has been apparent, and physicians are advising their patients to sleep with windows open all the year. Where the rooms are heated during the day one may prepare for

bed in a warm room and open the windows on retiring. In this way the bedclothes are kept warm and dry, and there is no danger in sleeping with the windows wide open as long as the sleeper is protected against the cold blasts of the wind. It is necessary to guard against direct draughts and to supply abundant bed-clothes. Under these conditions sleep is far more sound and refreshing, and the body maintains its vigorous state under greater stress than otherwise.

The Floors and Floor-coverings.—Hard-wood floors are to be preferred, because they are less pervious to dust and therefore more easily kept in a sanitary condition.

The covering of the floors of a house has an important influence upon its healthfulness. Carpets and matting are objectionable, because they are fastened to the floor and are allowed to remain in place for months or even years. It is preferable to have the floors painted and covered with a rug that can be removed, aired, and cleaned at frequent intervals.

The Wall-covering.—The covering of the walls of rooms is a matter of the greatest importance. Wall-paper or paint of a bright-green or red color should be avoided, because these colors may contain arsenic. The arsenic in wall-papers will eventually become detached and be present in the air of the room as arsenical vapor. Sufficient arsenic has been found in the air of rooms, derived from these sources, to produce poisonous effects in those constantly breathing the air. The custom of placing a new layer of wall-paper on the old and soiled paper cannot be condemned too vigorously. This custom is very generally practised in spite of repeated remonstrances and warnings of the danger involved. All the filth contained on the old paper is allowed to remain on the walls, and is simply covered over with another layer of paper. This goes on until the number of layers of paper is so great that its weight prevents it from adhering to the walls any longer. Whenever a room needs paper-

ing, the old paper should be carefully removed and the walls scraped before a layer of new paper is placed upon them.

The prevalence of tuberculosis in certain houses year after year and generation after generation can be traced, at least in considerable part, to the custom of repapering the walls without previously removing the soiled paper, as well as to neglect of disinfection and cleansing after death or removal of a case of tuberculosis. This condition will continue until compulsory registration of all tubercular patients is secured. The tubercle bacillus is capable of existing in the dust of rooms for a long time, and the inhalation of this infectious dust by susceptible persons is no doubt a frequent source of infection. When moving into an old house, therefore, it will be safest to give it a thorough cleansing and disinfection, to prevent the contraction of disease from infected dust and the soiled walls and woodwork of the house.

It is preferable to have the walls painted, in order that they may be cleaned and disinfected without injury. Where the delicate nature of the wall paint does not permit efficient cleansing and disinfection a fresh coat of paint should be applied instead. This will serve to disinfect the walls in an efficient manner.

Ventilation and Heating.—When a general system of heating and ventilation is employed, by means of a furnace or indirect heating with steam, provision should be made for securing pure, fresh outside air. The more or less stagnant air of the cellar should not be employed for this purpose. Ventilating flues of appropriate size should lead to each of the rooms, so that the ventilation of each may be independent of every other part of the house. Provision must also be made for the escape of the impure air from each room, a matter which is very frequently neglected.

When the rooms are warmed by direct heating of some form or another it is still necessary to provide for the entrance of fresh air. In such a system of heating the out-

side air cannot always be brought in at the desired temperature, and it becomes necessary to provide special devices for bringing in the fresh air without creating draught. The fresh air cannot be brought in by simply opening the windows without creating draughts. The simplest method is by placing a board underneath the lower sash, so as to allow the air to enter between the lower and upper sash (see Fig. 8). In this way the incoming air will continue its upward course and become distributed through the upper portion of the room. A number of devices have been invented to bring about the same results without the use of a board beneath the lower sash, among which are perforated window-panes, and an upper sash that slopes inward. Fresh air may also be admitted through special openings in the walls, but in this method it is necessary to conduct the incoming air upward toward the ceiling, so as to avoid draught. The inlet openings should always be high enough to prevent the current of air impinging on the occupants of the room. In order to secure efficient ventilation where the system of indirect heating is employed, it is necessary to provide exit openings for the impure air in the room.

Cooling Devices.—During the summer months it is frequently desirable to cool the air of a room or of the entire house. For the purpose of cooling the air of a single room small electric fans are in very general use. These serve to propel the air through the room at a high rate of speed, and thus produce a cooling effect through the greater evaporation from the surface of the body. Recent experiments on human beings, confined in a special chamber, demonstrate that when the air is in a highly vitiated state through the accumulation of the products of respiration, the setting up of active movements in the air with an electric fan will at once relieve the oppression of the occupants.

The air of an entire house may be cooled by passing it through a chamber filled with ice, the air being propelled throughout the different parts of the house by a

large fan or blower. This method is, however, very expensive, as it requires large quantities of ice or the employment of an ice machine of one or more tons daily capacity, according to the size of the house to be cooled and the initial temperature of the outside air. Passing the incoming air through a large screen, over which a spray of ice-water is falling, will also serve to cool the air.

Liquid air has been employed as a means of cooling the air of theaters in summer and has proved satisfactory, although this is also an expensive method. Within recent years Professor Gates, of Washington, devised an

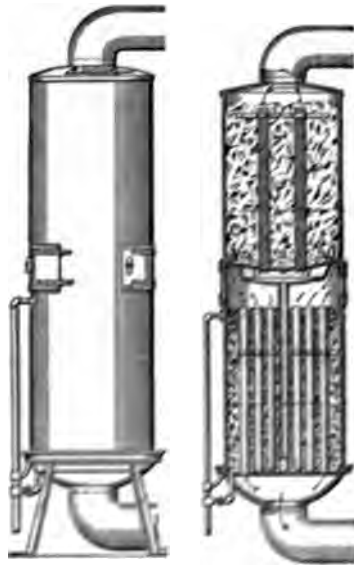

FIG. 58.—The Nevo. Front and sectional views.

apparatus for cooling the air which, it is claimed, can be operated more cheaply than a stove. Professor Willis L. Moore, of the United States Weather Bureau, has also devised an apparatus for this purpose called the "Nevo" (Fig. 58). This apparatus consists of a cylinder containing compartments filled with cracked ice and salt, through

which the warm air descends. The cool air issues at the bottom, and from this point gradually mingles with the air of the room. The higher the outside temperature, the greater the volume of air which passes through the apparatus. Different sizes of this apparatus adapted for use in single rooms or larger apartments are now on the market.

Plumbing and Drainage.—The character of the plumbing and drainage of urban houses has a direct influence upon the health of the occupants. All the appliances, such as sinks, water-closets, and bath-tubs, should be supplied with appropriate traps, in order to exclude the drain-air. These traps are now generally required by the sanitary laws of all large municipalities, and the form and character of the traps to be employed are frequently stated in these laws. While the danger from sewer-air spoken of in the older text-books is greatly exaggerated, it is well known that such air must be rigidly excluded from houses to avoid any possible injurious effects. Continued breathing of air containing the considerable quantities of carbon dioxid found in sewer-air, besides the other putrefactive gases present in it, will eventually prove injurious.

The plumbing should serve to bring into the house an abundant supply of water and distribute it to all parts for convenient use. The drainage system should be so constructed as to remove promptly and safely all sewage and waste water from the house.

Houses for the Poor.—The overcrowded condition and unhealthful character of the habitations of the poor have called forth special regulations governing this matter in many large cities. The causes which have led to overcrowding are numerous, the principal being (1) the necessity of living near their work, (2) the high price of land arising from the same fact, (3) the higher taxes and rents resulting from the same conditions, and (4) limited means, which prevent them from living under better conditions.

In recent years this condition of overcrowding has been greatly diminished through the influence of several factors, such as (1) the employment of electricity as a motive power for street railways. By this means the cost of travelling has been diminished, the speed of the cars has been increased, and the lines of travel have been extended into the suburbs of cities, where cheaper and more healthful houses can be procured. (2) The destruction by the municipal authorities of the more objectionable of the overcrowded tenements. (3) The regulation of the size, construction, and arrangement of all new dwellings by means of legislation. One of the most efficient ways of preventing overcrowding is to be sought in affording better communication between the periphery and center of a city, so that those working in the city are not compelled to live there, but make it possible for them to live in the suburbs.

According to the investigations of J. Bertillon,¹ the population of Paris is distributed in the following manner: 149 per 1000 live in overcrowded dwellings, 373 per 1000 have insufficient room, 266 per 1000 have sufficient room, and 222 per 1000 have more than sufficient room.

According to the same authority, the proportion of population living in overcrowded dwellings in the larger European cities is as follows:

| 260 per 1000 of the Paris | population. |
|---------------------------|-------------|
| 200 " " London | " |
| 300 " " Moscow | " |
| 460 " " St. Petersburg | " |
| 740 " " Antwerp | " |

Of the Paris population, 378 per 1000 have 2 persons per family, 687 per 1000 have 3 persons per family, 758 per 1000 have 4 persons per family, and 205,000 out of 667,000 families consist of only 1 person; and 30,000 out of 662,000 dwellings have 1 room.

Municipal legislation regulating the construction of

¹ *Rev. d'Hyg.*, vol. 14, p. 524

workingmen's homes should prescribe the size of the rooms, the number of square meters of floor space for each occupant, and the amount of window surface in relation to the floor surface. The regulations should also direct the character of the drainage facilities that are to be supplied.

In many European cities the construction of new houses is so regulated as to prohibit the utilization of more than a definite proportion of the ground surface for building purposes. This feature prevents the construction of houses in too close proximity to adjoining houses. In many of these regulations the height of the houses is regulated by the width of the streets on which they front, or the section of the city in which they are located. For instance, in Bonn, a city with 50,000 inhabitants, the smallest size of the yards in the business section is 25 per cent. of the ground surface for buildings one story in height, and 35 per cent. for buildings more than one story in height, and the greatest height allowed is 20 meters. In the residence portion of the city the smallest size of the yards is 25 per cent. for houses of one story in height, and 50 per cent. for houses of more than one story in height, and the greatest height allowed is 17 meters.

Building regulations should also include the requirements of lodging- and boarding-houses, because it is in these that a great degree of overcrowding is found. These regulations should state the amount of cubic space that must be allowed for each lodger, according to age, and the arrangements for the efficient ventilation of the rooms that are necessary to secure a continuous supply of pure air. These regulations should also provide for the general sanitary supervision of the premises and arrangements by competent inspectors.

House-cleaning.—From the fact that living bacteria may be contained in the dust of rooms the method of house cleaning is of importance. Great care should be exercised to avoid disseminating collections of dust on

horizontal surfaces. All the furniture, woodwork, and painted walls should be wiped carefully with a dampened cloth, in order to remove the dust without causing it to rise into the air of the room.

The rugs on the floor should be removed from time to time and thoroughly dried and cleaned. The floors should be waxed and polished before replacing the rugs. Special preparations have been perfected for this purpose. These are applied by means of a long-handled brush and then rubbed into the floor by means of a large burnisher. Some of these floor preparations contain turpentine, or other antiseptic substances, and serve a useful purpose in addition to preserving the quality of the floor.

Protection from Flies and Mosquitoes.—Since flies are frequent carriers of disease, they should be rigidly excluded from the house. Flies feed on filth, and in this manner their bodies may become soiled with pathogenic bacteria, and they no doubt carry these bacteria from place to place and contaminate whatever they light upon. During the Spanish-American War the spreading of typhoid fever from one portion of a camp to another was probably in part due to this mode of dissemination of the typhoid bacillus. During the summer months, therefore, all the doors and windows should be fitted with efficient mosquito-bars, in order to exclude flies and mosquitoes. The experiences of the several commissions which have been sent to malarious localities in Africa, Italy, and India have demonstrated the fact that simply excluding mosquitoes from habitations by means of mosquito-bars serves to protect the occupants against malarial infection.

CHAPTER XVII.

VITAL CAUSES OF DISEASE.

THE vital causes of disease are those vegetable and animal organisms which are capable of existing as parasites in or upon the human host, and by their mere presence, or through the production of poisonous products, cause disease. The vegetable organisms producing disease are of two classes—the bacteria, and various fungi which produce local affections of the skin. Fortunately, only a small proportion of the bacteria found in nature are pathogenic. A number of the specific diseases, however, have been traced to the activity of these organisms. All of these pathogenic organisms are transmissible from one individual to another if not already immune. One attack of certain of these specific diseases confers immunity against subsequent infection from the same species of organism. In some instances this immunity is permanent, lasting throughout life, while in other diseases it is of short duration, lasting only a few weeks or months. The specific organisms of each disease differ in their morphologic and biologic characters from those causing other diseases to such an extent that they can be recognized and isolated.

The micro-organisms which are pathogenic for man, and the specific organisms of the following diseases, have been discovered and isolated, as follows:

- 1839, parasite of favus;
- 1863, bacillus of anthrax—Davaine;
- 1873, spirochæte of relapsing fever—Obermeier;
- 1875, bacillus of malignant œdema—Pasteur;
- 1878, actinomyces bovis—Bollinger;
- 1879, micrococcus of gonorrhœa—Neisser;

- 1880, plasmodium malariae—Laveran;
 1880, micrococcus lanceolatus (pneumonia)—Sternberg;
 1880, bacillus of typhoid fever—Eberth;
 1881, micrococcus tetragenus—Koch and Gaffky;
 1882, bacillus pyocyaneus—Gessard;
 1882, bacillus of tuberculosis—Koch;
 1882, bacillus of glanders—Löffler and Schütz;
 1882, bacillus of rhinoscleroma—von Fisch;
 1883, streptococcus pyogenes—Fehleisen;
 1883, bacillus lanceolatus—Friedländer and Frobenius;
 1884, vibrio of Asiatic cholera—Koch;
 1884, staphylococcus aureus and albus—Rosenbach;
 1884, bacillus of diphtheria—Klebs and Löffler;
 1884, bacillus of tetanus—Nicolaiier;
 1885, staphylococcus citreus—Passet;
 1885, bacillus vulgaris—Hauser;
 1886, bacillus coli—Escherich;
 1886, bacillus aërogenes—Escherich;
 1887, micrococcus intracellularis—Weichselbaum;
 1889, bacillus capsulatus—Pfeiffer;
 1892, bacillus of influenza—Pfeiffer;
 1894, bacillus of bubonic plague—Yersin and Kitasato;
 1894, bacillus of infectious conjunctivitis—Koch-
 Weeks;
 1895, bacillus botulinus—Van Ermengen;
 1897, bacillus sporogenes—Klein;
 1897, micrococcus melitensis—Bruce;
 1900, bacillus mortiferus—Harris;
 1902, trypanosoma gambiense—Dutton;
 1905, spirochæta pertenuis—Castellani;
 1906, spirochæta pallida—Schaudinn and Hoffmann;
 1906, spirochæta duttonii, Breinl.

In the following diseases no specific organisms have as yet been isolated, though from their clinical manifestations and contagious character they are believed to be due to some specific agent: Small-pox, varicella, measles, scarlet fever, whooping-cough, mumps, dengue, typhus fever, yellow fever, rabies, and rheumatism. A variety

of micro-organisms has been found in most of these diseases, though none of them has been positively demonstrated as specific.

Modes of Dissemination.—Those diseases which are infectious may be disseminated in several different ways. The confusion which is more or less prevalent with regard to the exact term to employ in each disease, whether infectious or contagious, has led numerous writers to abandon one or the other term. Since all contagious diseases are infectious, it seems preferable to abandon both, and to substitute the term transmissible, as has been done by Dr. Abbott,¹ and call those diseases which were formerly designated as contagious, transmissible by direct contact, and those diseases which were formerly designated as infectious, transmissible by indirect contact. Diseases like small-pox, measles, and scarlet fever are transmissible by direct contact; and diseases like typhoid fever are usually transmissible by indirect contact.

Some of the diseases, however, which are frequently disseminated by direct contact may be, and often are, disseminated indirectly through the medium of food infected with the specific micro-organisms, or through the agency of flies or other insects whose bodies have become infected by coming in contact with infective materials. A number of diseases, prominent among which are those due to animal parasites, are disseminated through the use of meat derived from infected animals, through water polluted with animal excrement, or through green vegetables that have come in contact with such excrement.

In addition to diseases transmitted by the methods indicated, there are some diseases in which the infective agent passes one of its cycles in the body of an insect, and is disseminated through the bite of such infected insect. The disease which is best known as being disseminated in this manner is malaria, which is disseminated through the bite of infected anopheles, while filaria-

¹ *The Hygiene of Transmissible Diseases.*

sis is believed to be disseminated through the bite of another mosquito, a species of culex, and the recent studies upon yellow fever show conclusively that this disease is disseminated through the bite of another mosquito—*stegomyia fasciata*.

In the light of the discoveries in regard to the mode of dissemination of malaria, filariasis, and yellow fever by mosquitoes, and the dissemination of Texas cattle fever, the spotted fever of the Bitter Root Mountains, and African tick fever by ticks, and sleeping sickness by the tsetse fly, it is safe to predict that other diseases will be found to be disseminated by somewhat similar agencies. There is no doubt that in the immediate future the investigations of scientists will be directed toward the discovery of such disseminating agencies, and with the discovery of such agencies the causes of these diseases, as yet undetermined, may likewise be discovered, and our measures of prevention placed upon a more satisfactory basis.

Nature of Epidemics.—The opinions of authorities differ with regard to the number of cases of any infectious disease that may exist in a community before the disease may be declared to be epidemic in its character. A few isolated cases are usually spoken of as an "outbreak" of the disease; but when the number of cases amounts to 1 per 1000 of the population, it is usually said to be epidemic. In England, measles is said to be epidemic when the number of cases amounts to 1.2 per 1000 of the population. Some years ago yellow fever was said to be epidemic when the number of deaths from that disease exceeded the number from all other causes. More recently the disease was considered epidemic in New Orleans when there were between 2000 and 5000 cases, or about 22 per 1000 of population. Usually when 10 cases of any disease develop in close proximity to each other, when all sanitary precautions have been exercised, the disease is said to be epidemic.

A disease is said to be *epidemic* when the infection has

been imported into a locality and spreads over an area. A disease is said to be *endemic* when it develops within a locality, or is peculiar to a locality, and spreads over an area. A disease is said to be *pandemic* when it spreads over very large areas or prevails in several continents at the same time. The term *pandemic disease* is usually applied to cholera, yellow fever, influenza, and plague. The different pandemic diseases have local habitats from which they are rarely or never absent. The habitat of influenza is in Russia, that of cholera in the valley of the Ganges River, that of plague in Indo-China, and that of yellow fever in countries bordering on the Gulf of Mexico and Caribbean Sea.

Immunity and Susceptibility.—When we undertake to investigate the causative factors underlying the results of the exposure of an entire community to a source of infection, with the idea of ascertaining the reasons why a certain proportion of such a community escapes the infection, a number of questions of great practical importance present themselves. We are frequently satisfied in solving these questions by saying that those members of the community which escaped the disease did so from the fact that they were not susceptible, or, probably, that they were immune, and that those who contracted the disease were susceptible, or that they were not immune.

It will be necessary to consider briefly what is meant by the terms susceptibility and immunity, and then we shall better understand why such differences in effects manifest themselves.

Immunity may be described as that condition of the body in which it resists the invasion of disease-producing bacteria, or resists their growth and activity after they have gained an entrance; while susceptibility is a condition in which, instead of the resistance of the body overcoming the action of the invading parasites, the parasites overcome the resistive forces of the body and disease results.

Immunity is either natural or acquired. Natural immunity is the inherent, vital reaction of a healthy organism against the invasion of disease-producing bacteria. There is greater susceptibility of some races to certain diseases than to others. Also there may be a family resistance transmitted from generation to generation, or it may be individual.

The principal factors upon which natural immunity depends are the following: (1) The normal fluids of the body are germicidal either through the presence of acids or through the presence of bactericidal, agglutinative, opsonic, and antitoxic substances, which can always be detected in the blood in limited amounts. (2) The skin and mucous membranes are so constructed as to prevent the invasion of bacteria. (3) Those bacteria which escape the foregoing defensive agents of the body may be taken up and destroyed by the phagocytes after they have been acted upon by the opsonins.

This natural immunity, in man as well as in animals, is frequently destroyed through external agencies, such as changes in the nature and quantity of the food-supply, changes of modes of living, as from outdoor occupations to indoor occupations, undue exposure, close confinement through lack of sunshine and fresh air, as well as many other changes in the environment which tend to lower the general vitality of the system. By modifications in the activity and environment of the lower animals it is often possible to render them susceptible to the action of certain bacteria which do not affect them normally.

Acquired immunity may be divided into—(a) Naturally acquired, that induced by recovery from a previous attack of a disease, as is the case with some of the common diseases of childhood, as rubeola, scarlatina, and vari-cella. One attack of these diseases usually confers immunity for life. That induced by an attack of an allied disease, as in the immunity conferred by vaccinia against variola. (b) Artificially acquired, that induced by the injection of antitoxic substances, as in diphtheria. That

induced by the injection of vaccine, as in the protection against typhoid fever, cholera, and plague by means of dead cultures of the specific organisms of these diseases. It has been demonstrated over and over again in epidemics of diphtheria that the injection of small doses of antitoxin into children exposed to infection serves to break up the epidemic. The latter form of artificially acquired immunity is, however, of short duration, lasting only from one to two months. The first two forms of acquired immunity are "active" immunity, while that conferred by means of antitoxin is "passive" immunity, because the body takes no part in its development. The immunity developed as the result of the employment of vaccines is also active in character, though it probably does not last as long as does the immunity acquired through recovery from an attack of the disease.

With equal propriety we may speak of susceptibility as being either natural or acquired. Susceptibility may be said to have been acquired when disease is contracted because of the lowered tone of the body through the influence of the many factors which tend to destroy natural immunity. This is especially the case in children when an attack of some acute infectious disease follows before convalescence from some other disease has been completed.

A number of theories have been proposed to explain the phenomena of acquired immunity, but some of the earlier ones have been found to be erroneous and are no longer tenable. A few of the more important of these may be briefly stated before taking up those which are held at the present day. The first is the "exhaustion" theory proposed by Pasteur in 1880, which assumed that through the growth of the bacteria in the body they destroyed some substance essential to their life and so made subsequent growth of the same species of bacteria impossible in such an individual, the complete destruction of this substance in the body conferring complete immunity. Another theory, known as the "retention" theory, pro-

posed by Chauveau about the same time, which assumed that some product of the vital activity of the bacteria was retained in the system which was prejudicial to the subsequent development of the same species. Both of these theories have now been discarded as affording no satisfactory explanation of acquired immunity. Besides these, another theory has been proposed which, while presenting considerable evidence in explanation of the phenomenon, was not generally accepted because it failed to meet all the conditions. This is the "phagocytosis" theory, propounded by Metchnikoff in 1884. He demonstrated that certain cells of the body—the connective-tissue cells and the leukocytes—have the power of absorbing living bacteria from the fluids and tissues of the body. This fact can be very readily demonstrated experimentally by inoculating certain bacteria into animals. The presence in the blood of enormous numbers of leukocytes at certain stages of many bacterial diseases is likewise a strong indication that they have important functions to perform in these diseases. According to this theory, the extent of the affinity of the leukocytes for the bacteria is directly dependent upon the degree of immunity. After taking up the bacteria the leukocytes are carried in the blood-current to the large glandular organs, the liver and spleen, where they are probably destroyed along with their contained bacteria, or, in the case of wounds, they are cast off as pus with the other débris resulting from the disease-process.

The studies of Sir A. E. Wright and his associates during the past ten years have strengthened the "phagocytosis" theory of Metchnikoff, though it is now evident that the phagocytic powers of the leukocytes are due to the presence of certain antibodies in the blood—the opsonins—which first act upon the bacteria and prepare these for ingestion by the leukocytes. In some of the bacterial diseases this type of immunity is of primary importance and constitutes the more important factor in the restoration of health.

Another theory proposed to explain immunity is known as the "humoral" theory, and has been advanced by Buchner. It is well known that the serum of normal individuals has the power, to a considerable extent, of destroying bacteria, and on this fact Buchner based his theory that the pathogenic bacteria are destroyed within the body by the bactericidal action of the blood-plasma, and not by the leukocytes. Many of the normal fluids of the body also possess this bactericidal action to a certain extent. Buchner has applied the term alexins to the bactericidal proteid substances of the blood. Detailed studies upon the bactericidal influences of blood-serum have demonstrated that this effect is due to the presence of two substances, as will be seen in the elucidation of Ehrlich's theory of immunity.

In 1895 Pfeiffer published some experiments upon the effects of the peritoneal fluid of an animal immune against cholera upon the cholera organisms. He demonstrated that if an animal was rendered immune to cholera and then received an injection of cholera organisms into its peritoneal cavity, the injected organisms underwent rapid deterioration and were completely destroyed in a short time. These experiments demonstrated that immunity against the bacteria themselves was due not to protective substances normally present in the body, but to something which had developed during the course of immunization.

The demonstration by Bordet, in 1896, that one species of animal could be immunized against the blood of another species, and when so immunized the blood-serum of the immune animal was capable of dissolving the red blood-corpuscles of the species with whose blood it had been immunized, opened up a new field of research which has afforded most valuable information upon the subject of immunity in general.

Ehrlich's Hypothesis.—In the light of our later knowledge upon the subject Ehrlich, in 1898, formulated his hypothesis of the mechanism of immunity which is re-

ceiving very general acceptance by scientists to-day. His theory of the mechanism of immunity is based upon Weigert's teaching of the process of tissue repair. It is a matter of universal observation that nature is prodigal in her attempts to repair an injury. This is shown in the healing process in an ordinary wound. A much larger amount of material is thrown out to bridge the chasm than is really utilized in the formation of new tissue. The presence of an excessive amount of new material is shown by the fact that the part is raised above the level of the surrounding sound tissue, and this excess is removed gradually as the newly formed tissue becomes stronger and stronger, until, finally, the wound is marked by a line of white scar tissue, the excess gradually passing into the blood current.

Ehrlich believed that the mechanism of immunity was explainable on a similar basis. It had become evident from the experiments of Wasserman with the tetanus bacillus that its toxin had an especial affinity for the cells of the central nervous system. Experiments with other bacteria pointed to the fact that the toxins of different species of bacteria had an especial affinity for the cells of different organs of the body. When the amount of poison entering the body is insufficient to destroy the cells which have an especial affinity for it, these cells may be injured only to such an extent as to permit subsequent repair. In order to comprehend Ehrlich's hypothesis, it is necessary to conceive the cells of the body as having a complex structure which may be stated diagrammatically as consisting of a central mass or nucleus from which radiate a number of "side chains," or lateral bonds, each of which serves to bind the cell to other substances. In the case of the cells of the central nervous system one of these lateral bonds has an especial affinity for tetanus toxin and suffers destruction. The cell now finds itself in unstable equilibrium, and at once proceeds to repair the damage wrought. As in the case of tissue repair, the new material produced to repair the breach is

far in excess of the required amount. The excess finds its way into the blood-current. This material now circulating in the blood-current has the same affinity for tetanus toxin as when united with the central mass of a cell as its lateral bond, and can, therefore, combine with tetanus toxin floating in the blood-current, thus preserving other cells from injury. The union formed between the lateral bond of the cell, which is really the antitoxin, and the tetanus toxin results in the formation of a compound which is physiologically inert. According to Ehrlich's idea, therefore, the antitoxin is simply the excess of lateral bonds floating in the blood-current. This substance can neutralize the effect of the tetanus toxin in a test-tube just as readily as it does within the body.

This hypothesis of the mechanism of immunity has been very materially strengthened by the extension of Bordet's experiments upon the immunization of animals with alien bloods which Ehrlich made in collaboration with Morgenroth. From the results of these studies he has broadened his theory of immunity so that it serves to explain certain facts which were previously not fully comprehensible. Ehrlich recognizes three types of immunity which differ in their mechanism according to the nature of the substance employed in the immunization. Any substance which exerts an injurious effect upon the body-cells finds in these cells side chains with which it can unite. These side chains are called "receptors," and different kinds of receptors unite with different forms of foreign substances.

1. In the immunity conferred by toxins, when antitoxins are formed, Ehrlich conceives the receptors to be of the simplest nature, and he calls these uniceptors, or receptors of the first order. These receptors possess simply one bond of attachment to which the toxin unites. These bonds of attachment he calls "haptophores," because they may be compared with prehensile arms. Similarly the toxin molecule also possesses a haptophore group through which it becomes attached to body-cells and exerts its destructive action. When toxin and antitoxin

are mixed *in vitro* in equal proportions, they unite with each other by means of their combining arms, and, in consequence, the toxin is neutralized.

2. In the immunization of animals with such substances as milk there is formed in the blood of the immune animal a substance which exerts a coagulating action when mixed with milk of the same species with which the immunization was brought about. This coagulation is produced by receptors circulating in the blood of the immune animal. These receptors differ somewhat from those of the first order in that they possess, in addition to the haptophore group, a zymophore group (so called from its enzyme-like capabilities) which brings about the coagulation. This constitutes the second order of receptors.

Receptors of a similar character are formed in the immunization of animals with serous fluids of other species. When the blood-serum of such an immune animal is mixed in a test-tube with the serum of the species of animal furnishing the blood for the immunization, a precipitate is formed. This test has now become of valuable service in medicolegal work in the detection of human blood. Old dried clots of blood can be taken up in physiologic salt solution and mixed with the serum of an animal immunized with human blood. If the blood-clot was of human origin, a precipitate will be formed. This is now the most delicate test that can be applied for the detection of human blood. Animals immunized with albuminous human urine give similar reactions to those immunized with whole blood or with blood-serum of human origin.

3. Ehrlich's studies of the mechanism of the immunity conferred by an alien blood revealed the fact that if the blood-serum of an animal immunized against an alien blood was heated to 56° C. for half an hour, it lost its hemolytic power, but that this serum could again be rendered active by the addition of a drop of normal blood-serum. This fact demonstrated that the hemolytic power of the immune serum was dependent upon two sub-

stances: the one present in normal blood and destroyed by a low degree of heat, and the other present only in the serum of the immune animal and more resistant to heat. The first substance he named the "complement," because of its complementary action to the second substance, which he called the "immune body." He believes the complement to be of the nature of an enzyme, and, therefore, the substance through which the immune body really brings about the solution of the corpuscles. In his later communications Ehrlich calls the immune body the amboceptor. This name is indicative of the two combining arms or haptophores possessed by the immune body, the one serving to unite it with the complement, which he calls the complementophilic haptophore, and the other, the cytophilic haptophore, serving to unite it with the blood-corpuscle, bacterium, epithelial cell, etc., against which the animal has been immunized.

In the immunization of animals with bacteria, blood-corpuscles, epithelial cells, etc., there is formed a receptor having two haptophores—amboceptor or immune body. These are receptors of the third order. This amboceptor is specific for the particular cells employed in the immunization. If the animal has been immunized with the red blood-corpuscles of another species, the amboceptor has the property of uniting with the erythrocytes of that species of animal by one of its haptophores, while with the other haptophore it unites with the complement of the blood-serum and brings about solution of the corpuscles—hemolysis. The same effect is produced when the serum of an animal immunized with typhoid organisms is mixed with such organisms in a test-tube. The amboceptor unites with the bacilli with one of its haptophores, while with the other it unites with the complement existing in the blood-serum and brings about the destruction of the organism—bacteriolysis. Immune serums which have been produced through the immunization of an animal with erythrocytes are known as hemolytic serums, while those produced through the

immunization of an animal with certain species of bacteria are known as bacteriolytic or bactericidal sera. A bacteriolytic serum produced by the immunization of an animal with *Bacillus typhosus* may be called a typhoid-immune serum, while a serum produced by the immunization of an animal with *Bacillus dysenteriae* may be called a dysentery-immune serum, each serum being specific for the organism with which the animal has been immunized.

The hemolytic and bacteriolytic sera contain, in addition to the specific amboceptor, another receptor which is regarded as being of the second order, since it exerts an agglutinating effect upon the cells with which the animal has been immunized. This receptor is instrumental in bringing about the agglutination of the cells used in the immunization, and hence is called "agglutinin." The Gruber-Widal reaction, which is now so commonly employed in the diagnosis of certain diseases, rests upon the activity of this substance. When an immune serum containing agglutinin is mixed with the bacteria employed in the immunization, it brings about the clumping of the organisms which constitutes the Gruber-Widal test.

The complement or enzyme-like element of the blood-serum, which destroys the bacteria when brought in contact with them through the intermediation of the amboceptor, is a normal constituent of the blood. Ehrlich and his followers have demonstrated conclusively that there is a multiplicity of complements in normal blood.¹ According to Ehrlich's conception of the mechanism of immunity, the haptophores of the amboceptor and complement must fit each other like lock and key, so that unless both are of like configuration, they cannot unite. Fortunately, the human complements conform to those of the domestic animals to a marked degree, so that ani-

¹ Ehrlich and Sachs, *Berlin. klin. Wochenschr.*, 1902.

mals of this character may be employed for the purpose of preparing immune serum.

The Antitoxic Sera.—It must be borne in mind that each of the different antitoxins known is specific for only one kind of poison, and this must be quite evident if Ehrlich's theory as to the mode of formation of antitoxins holds true. We know that in chemistry we have only one particular compound formed when we mix silver and hydrochloric acid together, and for the same reason each particular toxin or poison can lead to the formation of only one kind of antitoxin, and this antitoxin can probably neutralize only that particular kind of poison.

The antitoxin which is best known to-day and which is most successfully employed as a therapeutic agent is that of diphtheria. Diphtheria is a distinctly toxic disease; the symptoms and lesions, except those at the seat of infection, are almost entirely due to the action of the toxin circulating in the blood. The fever, debility, and the paralysis occurring during convalescence are probably entirely due to the action of the toxin. The bacilli are found in the membranous exudation forming upon the fauces, and occasionally in the later stages of the disease they are found in the lungs and the heart's blood.

Tetanus is also a purely toxic disease. The tetanus bacillus appears to be localized at the point of inoculation where it produces its toxin. The toxin is taken up by the peripheral nerves, and through these reaches the central nervous system, for which it has an especial affinity. It is possible to produce an efficient antitoxin against tetanus, but, on account of the affinity of the toxin for the cells of the central nervous system, the antitoxin has proved of less signal benefit in the treatment of the disease than is the case in diphtheria. By the time tetanic symptoms manifest themselves in tetanus such large numbers of the cells of the central nervous system have been injured by the toxin that the antitoxin frequently fails to preserve life. The subdural adminis-

tration of the antitoxin appears to give the most favorable results because it brings the antitoxin into closer proximity to the injured nerve-cells.

Probably the most signal benefit of the tetanus antitoxin has been as a prophylactic when administered early before the manifestation of tetanic symptoms in suspected cases of tetanus. There is at present no very positive method of determining the probability of infection by the tetanus bacillus, and hence the use of the tetanus antitoxin as a prophylactic is largely, if not entirely, empirical.

The Bacteriolytic Sera.—Antibodies are found in greater or lesser amounts in the blood of individuals suffering from the different bacterial diseases, and scientists have for a number of years been engaged in the study of the problems connected with the commercial production of immune sera.

In several bacterial diseases, as in typhoid fever, cholera, and to a large degree in dysentery, the immunity is of a bacteriolytic character, in that the blood-serum of convalescents contains much greater amounts of the specific amboceptors than are found in the blood of normal individuals.

Typhoid Immune Serum.—Among the earlier experimenters who studied the production of a typhoid immune serum are Lewin¹ and Jez,² and their results appeared to be quite promising. Beumer and Pfeiffer³ were able to show that their serum had not only immunizing powers, but also curative powers.

Among the attempts to perfect an immune serum for typhoid fever the work of Chantemesse⁴ is of interest. His recent report on the subject is most encouraging, covering as it does the work of six years. He reports that in the 1000 patients subjected to this method of treatment during the past six years the mortality was

¹ *Deutsche medicinische Wochenschrift*, January 19, 1899.

² *Wiener medicinische Wochenschrift*, February 18, 1899.

³ *Zeitschrift für klinische Medicin*, Bd. xxviii.

⁴ *L'Hygiene Gen. et Appliquee*, October, 1907.

4.3 per cent., while the mortality in 5621 patients treated at the other hospitals of Paris during this period was 17 per cent. These patients all received hydrotherapy in addition to the serum treatment to control the temperature. In the hands of Brunon and of Josias this method gave equally good results, and at the military hospital of Val-de-Grace there were but five deaths in ninety cases so treated, the mortality for the preceding six years, before the introduction of the serum treatment, being 10.6 per cent. Chantemesse emphasizes the importance of using the serum as early as possible, stating, in fact, that he has never seen a fatal result when the patient received the serum within ten days of the onset of the disease.

The serum of Chantemesse is obtained from horses, which for long periods have been injected with filtered and sterilized cultures grown on bouillon of beef spleen. The dose of the serum is from one to five drops, given under the skin. After such an injection there follows a period of reaction, when the temperature seldom falls and frequently is somewhat elevated. The general condition is not improved during this reaction, which lasts from a few hours to several days. Chantemesse regards this phenomenon as the result of the destruction of the bacilli in the body and the consequent release of an additional amount of toxin. A study of the influence of the serum on the opsonic power of the blood indicates that the bactericidal action of the serum is in large part due to its stimulating effect on this phenomenon. The opsonic index is found to be increased to a greater degree in severe infections than in the mild ones, and for this reason Chantemesse advises using a minimum dose of the serum in severe cases, as the greater the bactericidal power of the blood, the greater will be the reaction.

Following the period of reaction comes a period of defervescence, when the temperature falls gradually and the

condition of the patient is in every way improved. The pulse is slowed, the blood-pressure is raised, the quantity of urine is notably increased, and the patient feels much more comfortable. The temperature usually continues to fall for ten or twelve days, when it may remain stationary for a few days and then go on to a rapid convalescence or a mild relapse. The influence of the serum seems to have been exhausted by this time, and a second injection may be required. An interesting observation was a very definite increase in the splenic dullness, which is seen after about twenty-four hours. This is a part of the general stimulation of the lymphoid and myeloid tissue which has been shown to be the result of the serum in experimental animals.

Burroughs, Wellcome & Co., London, manufacture an antityphoid serum which is obtained from horses that have been treated with killed cultures of *Bacillus typhosus*.

Antistreptococcus Serum.—The clinical application of Marmorek's earlier antistreptococcus serum was not very encouraging because of the absence of uniformly positive results and on account of the large doses required. The conviction gradually gained prominence that the principal cause for the uncertain results obtained with Marmorek's serum was explainable on the ground of the heterogeneity of the streptococci in different disease conditions. So firmly has this conviction been established that for the past few years the antistreptococcus sera on the market have been prepared with organisms isolated from different disease conditions. This is especially true of the earlier sera prepared by Aronson, Tavel, Deneys, Paltauf, and Moser.

The prophylactic and therapeutic value of antistreptococcus serum is still under dispute; some investigators claim distinct prophylactic and curative values, while others dispute the efficacy of this serum, for instance, Zangemeister¹ states that he has been unable to ob-

¹ *Deutsche med. Wochenschrift*, 1906, p. 1077.

tain any definite effects when the serum was employed either as a protective agent against wound infection, and still less so when used after infection had taken place. On the other hand, we find in the literature on this subject, frequent statements as to the prophylactic and therapeutic value of the antistreptococcus serum in isolated cases, for instance, Fromme¹ reports on investigations carried out in the Halle Maternity Clinic, and states that as a prophylactic Menzer's serum was very satisfactory. In the treatment of cases of endometritis the serum also had a beneficial effect; though in streptococcus peritonitis it seemed to be without effect, nor did it seem to be of any value in cases of pyemia.

Marmorek prepares two kinds of antistreptococcus serum: (*a*) By the treatment of horses with living cultures of streptococcus; (*b*) by the treatment of horses with the toxin produced by the streptococci. In order to meet the conditions more certainly a mixture of the two sera is administered.

Tavel, Menzer, and Moser employ living cultures of streptococci which are secured from different pathologic conditions. These cultures are maintained at their original degree of virulence by cultivation in suitable media. Marmorek, Aronson, Denys, and Paltauf prepare their sera with cultures that have been passed through animals.

Aronson at first employed cultures of streptococcus that had been rendered highly virulent by repeated passage through animals. The studies of Meyer, as well as his own later studies, convinced Aronson of the definite difference between the effects of a serum prepared with organisms that had been rendered highly virulent for animals and a serum prepared from the same organisms without passage through animals. Aronson now prepared two kinds of serum: (*a*) By immunizing horses with organisms of unaltered virulence; and (*b*) by immunizing horses with organisms raised to a high degree of virulence by passage through animals.

¹ *Münchener med. Wochenschrift*, 1906, p. 20.

Moser's serum is prepared with cultures obtained from cases of scarlet fever. The use of this serum in the treatment of scarlet fever is said to be of considerable value, though it is recognized that streptococci are not the causative factors of the disease, but merely contributory factors.

Antistreptococcus serum is also marketed by Burroughs, Wellcome & Co., London, the Cutter Laboratory, Berkeley, California, the Lederle Laboratory, New York, Mulford & Co., Philadelphia, Parke, Davis & Co. and Stearns & Co., Detroit. These are all polyvalent sera.

The studies of Michaelis and of Aronson indicate that the antistreptococcus sera are not bactericidal in their action, since streptococci grow almost equally well in normal and immune serum. The conclusions reached by these two investigators are that the immune serum supplies the specific opsonin which prepares the streptococci for ingestion by the phagocytes.

The Antituberculosis Serum of Marmorek.—Wohlberg¹ treated 16 cases of tuberculosis with Marmorek's serum, and reaches the conclusion that the serum is of great value in the treatment of scrofulosis. In fully developed cases of tuberculosis the serum did not seem to be of definite service.

An antitubercle serum is also prepared by Parke, Davis & Co., Detroit. This is prepared by treating horses for several months with the toxic products of the tubercle germs.

Antimeningococcus Serum.—Flexner in America and Jochmann in Germany have prepared an antiserum for the treatment of cerebrospinal meningitis. Flexner's serum has been employed in a number of cases of cerebrospinal fever in various stages of the disease, and the results appear to indicate the curative value of the serum, though the question may be said to be still under investigation, as it will require a large series of cases to establish its relative value.

¹ *Berliner klinische Wochenschrift*, November 18, 1907, p. 1486.

Antimeningococcus serum is prepared by Meister, Lucius and Bruening, Höchst A. M., Germany, and by H. K. Mulford Co., Philadelphia. This serum is employed for prophylactic and curative purposes.

Serum Therapy and Serum Prophylaxis in Acute Infectious Diseases.—W. Kolle,¹ in a clinical lecture, speaks of the diphtheria and tetanus sera, which contain the antitoxins discovered by von Behring; he states that the employment of diphtheria antitoxin is still at times attended with failure, which is partly due to mixed infections, and partly due to disease of important organs, as the heart and kidneys, and in part to unknown causes. He believes that the latter source of failure may be eliminated by the employment of a serum which possesses, aside from its antitoxic powers, also agglutinative and bactericidal powers. With the tetanus serum the protective action is far greater than the curative power. The curative power is uncertain, and can only be expected with certainty when the serum is employed a short time after infection. The failure of the serum to relieve after development of the disease is attributed to the fact that before the appearance of the nervous symptoms the cells of the central nervous system and of the nerve-tracts have combined with the tetanus poison and hence the antitoxin circulating in the blood-stream remains without effect.

In typhoid fever and cholera the anti-infectious forms of serum which have been prepared against the endotoxins contained in the bodies of the bacteria are more promising than the antitoxic sera. The immune substances contained in these sera consist of bacteriolysins, agglutinins, precipitins, and opsonins.

In the treatment of dysentery antitoxic as well as bactericidal sera have shown themselves to be practical, and Kolle recommends the use of both simultaneously.

With regard to antistreptococcus serum, many favorable results as well as many unfavorable results have been reported. There is no antitoxic action, and we have as

¹ *Deutsche med. Wochenschrift*, 1907, p. 621.

yet no knowledge of a soluble streptococcus poison. Kolle is inclined to believe that the polyvalent is preferable to the monovalent serum.

On the other hand, the polyvalent plague serum has not shown itself to be superior to the monovalent serum. Antiplague serum produces a passive immunity, and is, therefore, a reliable protective, but one cannot rely upon its curative action. Its value can be easily determined by experiments upon rats. In the test-tube no distinct bactericidal action is to be demonstrated, as is the case with cholera and typhoid sera.

The meningococcus serum exerts no antitoxic action, and its value is very difficult to measure because we have no susceptible animals upon which to test it. Kolle and Wassermann have perfected a procedure in which specific substances in this serum can be demonstrated through complement deviation. As to its curative value, no definite conclusion is possible at this time. Its employment in the very beginning of the disease will make success more probable.

Prevention of Infection by Inducing Active Immunity.—An enormous amount of work has been performed to discover methods of preventing the action of pathogenic bacteria by means of their metabolic products.

The use of the metabolic products of the tubercle bacillus, the tuberculin of Koch, in the treatment of tuberculosis was not attended by the favorable results at first expected. This agent is, however, of great value as a diagnostic agent for the discovery of the presence of the disease in the early stages in man and animals. In this manner it becomes a most important preventive agent by the early discovery of the disease in cattle, thus limiting the danger of the dissemination of the disease through infected meat, milk, and milk products.

The valuable results obtained in the prophylactic treatment of cattle with anthrax vaccine—an attenuated culture of the anthrax bacillus; the important work of Pearson and Gilliland in the vaccination of cattle

against tuberculosis; the prophylactic treatment of cattle with blackleg virus—a highly attenuated culture of the blackleg bacillus; as well as other animal diseases which are treated or prevented by antitoxin; and the value of the prophylactic measures against small-pox and diphtheria as practised in the human family, lead us to hope that other prophylactic agents may be discovered to combat the development of infectious diseases.

The Haffkine Method of Protection.—The Haffkine method of protection against typhoid fever, cholera, and bubonic plague by means of heated cultures of the respective organisms has been found of great value. The protection of English soldiers and army nurses against typhoid fever by the injection of killed cultures appears to have been of signal benefit during the past few years. It has been the experience of English army surgeons in South Africa that, where heretofore nurses in the army hospitals frequently contracted typhoid fever from patients, since the introduction of this method of protection the danger of infection of nurses has been practically eliminated. The experience in the German army serving in South Africa has been found to be equally satisfactory. The same method has been employed in the protection of the soldiers in the United States army with very satisfactory results. In a similar manner dead cultures of the cholera organism are being employed to protect individuals against cholera, and dead plague cultures to protect against plague. Usually bouillon cultures are employed that have been killed by subjecting them to heat. Such heated cultures have been designated Haffkine fluids, as they were first proposed by Haffkine.

The prophylactic agents employed act in different ways. The anthrax and blackleg viruses act by inducing a mild type of the disease, and in this manner confer immunity. The metabolic products of the bacteria when injected into an animal also cause the formation of specific antibodies in the blood of the animal, and this renders it immune. The use of dead cultures, as in the Haffkine

method and in the Wright method, confers an active immunity against the disease which lasts for a year or longer.

With the view of overcoming the disadvantages of the Haffkine injections, Besredka¹ injected a culture of an organism which had been treated with the specific amboceptors for that organism. It will be recalled that amboceptors are the intermediary bodies that bind the complement to the bacilli. The amboceptors resist heat, low degrees of which (56° C.) destroy complement. For example, a culture of the typhoid bacillus was suspended in salt solution and enough heated antityphoid serum added to cause complete agglutination. The mixture was allowed to stand for six hours, during which time the bacteriolytic amboceptors, as well as the agglutinating bodies, are fixed to the bacteria. The bacteria were then washed free of serum by repeated centrifugating in salt solution. The sediment, consisting of typhoid bacilli plus the immune bodies, was then injected into animals. It was found that immediate immunity was conferred, which endured for at least five or six months. No general or local symptoms followed the injection; and this was true of an injection Besredka made in himself. The same experiments were made with cholera and plague; in working with the latter killed organisms were used.

Protective Inoculation Against Plague.—W. Kolle and Richard P. Strong² experimented with a lowly virulent plague culture which had been cultivated four months at 41° to 43° C., so that it had become attenuated to such a degree that guinea-pigs and rats, which are very susceptible to plague, could withstand a millionfold the quantity of culture. It was shown by inoculations of forty-two human beings that this vaccine is without detrimental effect other than a slight fever and a slight local reaction, both of which disappeared within three days in 29 of these

¹ Besredka, *Ann. de l'Inst. Past.*, 1902, vol. xvi., p. 918.

² *Deutsche med. Wochenschrift*, 1906, p. 413.

individuals. The blood was examined as to its agglutinating power as well as for its protective power when administered to animals, and was found to agglutinate fresh plague cultures as well as to protect animals against inoculations of plague cultures.

Prophylactic Inoculation Against Cholera.—Leon Karwacki¹ inoculated himself and ten other persons with cholera vaccine. At the first inoculation he employed one cubic centimeter, and at the second inoculation, made five days later, he employed two cubic centimeters, injected under the skin of the arm. The effects of the inoculations were reddening and swelling at the point of inoculation, and in some of the individuals swelling of the axillary lymphatics, a slight rise in temperature, never reaching 38° C., a slight general indisposition, and headache. After the second inoculation the reddening of the skin at the point of inoculation was the only effect noticed. Blood was drawn from these eleven persons before inoculation, five days after the first inoculation, and ten days after the second inoculation, and tested in regard to its bacteriolytic power. While the blood before the inoculation in its undiluted state in about half the tests gave a satisfactory Pfeiffer reaction, after the first inoculation the tests showed an average of fifty bacteriolytic units, and after the second inoculation it rose to 5000 to 10,000 units. In three convalescents from cholera the bacteriolytic power of one was of 1000 units and of the other two, 5000 units. The same increase in the agglutinating power was noted in the blood as the result of the inoculations. After the second inoculation the antibody formation reached about the height of that found in individuals who had recovered from cholera.

S. Serkowski² made altogether 353 prophylactic inoculations against cholera. Besides the Kolle method, he employed in 7 cases the Neisser-Shiga method. There was no difference in the results obtained by the two meth-

¹ *Zeitschr. f. Hyg.*, Bd. liv., p. 39.

² *Centralbl. f. Bakt.*, Bd. xli., p. 255.

ods, but there was a decided preference for the Kolle method because of the simplicity of the technique. In forty-one individuals he determined the bacteriolytic power of the blood before the first inoculation, and five days after the second and third inoculations. He was able to note a definite increase in the bacteriolytic power corresponding with the size of the doses injected and the number of injections. But there was not a similar relation between the dose of the vaccine and the agglutinative power of the blood. Repeated inoculations increase the degree of immunity as well as its permanency, and he concludes with Kolle that injections of the largest possible doses of dead cultures give the best and most permanent results.

Protective Inoculation Against Typhoid Fever.—No hygienic measure discovered in modern times compares in value with the beneficial effects which result from the prophylactic inoculation of soldiers against typhoid fever. During the Spanish-American War, out of a total strength of 107,973 men, there were 20,738 cases of typhoid fever and 1580 deaths, representing 86.24 per cent. of the entire mortality of the war.¹

During the first eighteen months after antityphoid vaccination had been introduced into the United States Army 12,644 persons were vaccinated. Five cases of typhoid fever occurred among these men, but no deaths, or 0.39 cases per thousand vaccinated persons. During the same period in the remaining six-sevenths of the force there were 418 cases and 32 deaths.

The following experience is taken from Major Russell's report to Congress:

"On June 14, 1910, 92 men of Company H, First Battalion of Engineers, were vaccinated. On June 24 the company left Washington, D. C., en route to Gettysburg, Pa. The total strength of the company was 118 men. Ninety-two of these had received at least one in-

¹ Russell, House of Representatives, Sixty-first Congress, Third Session, Document No. 1445, Washington, 1911.

oculation, two others gave a history of having had typhoid and may be considered immune, thus leaving 24 men unprotected by either a previous attack of the disease or by vaccination. On August 11, five days after returning from maneuvers, two cases of typhoid fever occurred among the unvaccinated and four secondary cases occurred between the 20th and 23d, also among the unvaccinated. No cases occurred among the vaccinated, while 25 per cent. of the non-immune living under exactly the same conditions succumbed to infection."

The commander of the German troops sent to South Africa makes the following report upon two incidents as to the influence of these inoculations and the mortality of typhoid fever.¹ Four hundred and twenty-four cases of typhoid fever came under observation, of which 100 had been inoculated. The mortality among the latter was 4 per cent., while among the uninoculated it was 11.1 per cent. In the inoculated the disease pursued a lighter course; the intoxication, as indicated by headache, disturbances of the sensorium, and the heart action, is slight, the complications fewer, and the relapses less frequent.

Protective Vaccination of Cattle Against Tuberculosis.—

F. Hutyra² tested von Behring's method of vaccinating cattle, and the results obtained led to a quite optimistic expression of belief in the permanent value of this method, but later experiments have caused him to speak of the method with greater reserve. It appears that the resistance conferred by von Behring's method against subsequent intravenous injection with tubercle bacilli declines quite rapidly and disappears entirely toward the end of the first year. The resistance of inoculated cattle toward natural infection from other tuberculous cattle is never striking and disappears after a few months.

In further experiments to test von Behring's method two intravenous vaccinations were given in the place of

¹ *Arch. f. Schiff- u. Tropenhyg.*, Bd. ix., p. 527.

² *Ztschr. f. Tuberkulose*, 1907, pp. 97-122.

one, as previously recommended. It was found that the resisting power of cattle thus treated was at first very pronounced or almost absolute, but that it was not of long duration, disappearing entirely within eighteen months. Hutyra concludes from his experiments that at present the only method for controlling tuberculosis which has stood practical test is that of Bang.

Value of Vaccination as a Protective against Small-pox.—Vaccination is the only preventive against small-pox. This has been demonstrated by the experience in countries where compulsory vaccination is in force, as well as in the experience of employees of small-pox hospitals. A single vaccination in infancy is usually not sufficient to protect against small-pox during life. Revaccination should be required at stated intervals, every five or seven years, where no small-pox exists. Whenever there is an outbreak in the community, all persons should be vaccinated at once and the revaccination continued as long as there is any reaction to the vaccine. Repeated vaccination until there is no longer any reaction is believed to be absolutely protective against small-pox. This is the only protection employed for physicians, nurses, and undertakers who come in daily contact with small-pox patients. It has been found that this form of protection is even more effective than a previous attack of small-pox, especially if some years have elapsed since the attack.

Erismann¹ states that in Prussia at the beginning of the nineteenth century, before vaccination became general, there were 2000 to 3000 deaths from small-pox annually. After vaccination was made compulsory the death-rate from small-pox was reduced to 200 per 1,000,000 inhabitants per year; and since the law of 1874, requiring re-vaccination in schools and the army, the disease is still rarer. In 1894 there were 88, in 1895 there were 27, and in 1896 there were 10 deaths from

¹ Abst., *Centralblatt f. Bacteriologie*, Bd. xxviii., S. 617.

small-pox. The results in neighboring countries are as follows:

| | Number of deaths in | | | |
|-------------------|---------------------|-------|-------|-------|
| | 1893. | 1894. | 1895. | 1896. |
| Austria | 5821 | . . | . . | 865 |
| Hungary | 1224 | 837 | 1937 | |
| Italy | . . | . . | 2998 | 2039 |
| France | 8001 | 859 | | |

Finkelburg² discusses the dangers from vaccination by means of bovine lymph, and states that the practical experiences of vaccine physicians teach that the regulations for the production of the lymph are not altogether satisfactory from a sanitary standpoint, and advises "(1) the introduction of a simple method of disinfection of the vaccination field and of the instruments; and (2) obligatory direction of the use of a protective bandage, which is applied at once and remains in position until the pustule has healed."

According to Haase,³ when the vaccination field is not washed, 31.45 per cent. of the vaccinations present marked reaction; washing with soap and water reduces the number to 22.63 per cent.; while after disinfection with alcohol, or water, soap, and alcohol, none of the cases showed marked reaction. No protective bandage was employed.

Schoen⁴ reports on small-pox among the native black races of Africa. The disease is generally distributed along the upper tributaries of the Nile in Nubia, Cordova, Abyssinia, Soudan, and along the eastern coast. In Western Africa the disease is less generally distributed because there is less intercourse with the central portion of Africa and with Asia. At times, however, the disease

¹ Estimated.

² *Centralblatt f. allgemeine Gesundheitspflege*, Bd. xviii, S. 357.

³ *Zeitschrift f. Medizinalbeamte*, 1899.

⁴ *Centralblatt f. Bacteriologie*, vol. xx., p. 641.

is introduced, and large epidemics and pandemics result, extending over entire districts and tribes. In Bogamayo (East Africa) nearly all the natives are pock-marked. In 1892, Salaam lost 10 per cent. of its inhabitants from small-pox. In the southern portion of East Soudan an epidemic destroyed 600 out of 1400 members of a tribe and 5 per cent. of the total population. According to Steudel, about one-half of the natives die of small-pox in Central Africa. According to Becker, most of the natives of German Africa who reach the age of manhood have had the disease. Compulsory vaccination is the only remedy, according to Schoen.

The extremely low death-rate from small-pox in Germany indicates the importance of re-vaccinations at stated intervals. It is also evident from observations in England and America that both the incidence and the mortality of the disease are directly proportional to the protection afforded by vaccination as indicated by the number and distinctness of the vaccination marks.

Dr. William M. Welch, of the Municipal Hospital for Contagious and Infectious Diseases, Philadelphia,¹ states that "in every epidemic of small-pox that has occurred in Philadelphia within the past thirty years, instances have been observed of whole families having removed to the hospital because of an outbreak of the disease (small-pox) in these families. In such instances the unvaccinated children have suffered and often perished, while those who were vaccinated remained perfectly exempt, although living, eating, and sleeping in the infected atmosphere for several weeks. But I have yet to see a single unvaccinated child escape the disease under similar conditions of exposure. Furthermore, I have more than once seen a vaccinated infant take its daily supply of nourishment from the breast of its mother who was suffering from varioloid, and the infant continue as free from small-pox as if the disease were a hundred miles away, and the food derived from the

¹ *American Medicine*, 1902, vol. iv.

most wholesome source. This is evidence of the prophylactic power of vaccination that does not appear in mortality reports nor in statistical records.

“Not many weeks since a pregnant woman nearly at term was admitted with varioloid. In the course of the disease labor occurred, and a male child weighing $8\frac{1}{2}$ pounds was born. About five hours after its birth the infant was vaccinated, two insertions being made. Again, two days subsequently, two more insertions were made. Four large vaccine vesicles developed, causing a very sore arm, but did not give rise to any considerable elevation of temperature nor to any apparent disturbance of the health of the infant. After remaining in the hospital thirty-two days and proving its newly acquired immunity to small-pox in a most indubitable manner, the infant was taken home by its mother, who had made a good recovery without untoward symptoms.”

Precautions in Vaccination.—More or less objection to vaccination is encountered in some communities. This objection may be divided into several different classes: (1) That of the anti-vaccinationists, which it is not necessary to consider here. (2) That of those who fear the transmission of some disease in the vaccine. This objection is groundless at the present day, since all the vaccine on the market is of bovine origin. It is doubtful whether any cases of tetanus following vaccination have been certainly traced to the vaccine virus. (3) That of those who fear the development of very sore arms with danger of blood-poisoning. This danger is largely due to the ignorance and neglect of the vaccinated. In order to avoid unnecessary discomfort in this respect, the operation should be conducted under aseptic precautions and the vaccinated wound properly protected. The arm should be first thoroughly washed with soap and water and the site of the operation then washed with alcohol. After the vaccination is made the site should be protected from rubbing by means of

a piece of clean soft muslin pinned to the undershirt. This should be changed each day until the scab falls off. It is probable that this procedure is far preferable to the use of the different forms of shields which have been placed on the market in recent years. Great care must be exercised to prevent the rupture of the vesicle or the premature removal of the scab. Should either of these contingencies occur, the vaccination should be treated like any other open wound.

The vaccination operation consists in exposing the true skin by removing the cuticle by means of a blunt sterilized needle. No blood should be drawn in the operation. The exposed area should not exceed five millimeters in diameter (one-fourth of an inch).

Biologic Aids to Diagnosis.—The importance of the early diagnosis of transmissible diseases cannot be too strongly emphasized, and we must welcome, therefore, everything that will render an early diagnosis more certain. In addition to the direct bacteriological examinations, as applied to the diagnosis of diphtheria, tuberculosis, gonorrhoea, cerebrospinal meningitis, and other diseases, we have for a number of years employed the agglutination reaction for the early diagnosis of typhoid fever, and the tuberculin test for the detection of tuberculosis. During recent years we have added several important additional aids to diagnosis and to our management of transmissible diseases.

Von Pirquet called attention, on May 8, 1907, to the fact that tuberculosis can be diagnosed in children by the introduction, into cutaneous scarifications, of 25 per cent. tuberculin, the reaction being the formation of a typical papule at the point of instillation in those that are tubercular, while no reaction is seen in non-tubercular persons. A week later Wolff-Eisner reported that a similar reaction could be obtained by the instillation of 10 per cent. tuberculin into the conjunctival sac. Calmette has since advised the use of a 1 per cent. tuberculin for the eye reaction.

Chantemesse¹ reports on an ophthalmo-diagnostic test in typhoid fever, which consists of the instillation, into the conjunctival sac, of $\frac{1}{2}$ mg. of a dry powder obtained from typhoid bacilli, suspended in a drop of water, which calls forth a reaction in those suffering from typhoid fever, while it is without effect in healthy individuals. He found this ophthalmic reaction to antedate the agglutination reaction by several days. In 70 typhoid patients the reaction was positive in each instance, while it was negative in 50 non-typhoid individuals.

Martel² has demonstrated that the von Pirquet cutaneous reaction, as well as the ophthalmic reaction, can be successfully produced with mallein in individuals who suffer from glanders. In every individual suffering from glanders that was tested there was a definite reaction, while there was no effect in healthy individuals. Mallein was used in 1 : 10 to 1 : 4 dilution for the cutaneous test, and in 1 : 60 dilution for the ophthalmic test.

Deehan³ has perfected an extract from the typhoid bacillus which, in his hands, served to diagnose typhoid fever when employed in cutaneous scarifications.

Wassermann, Neisser, and Bruck⁴ have proposed a serum diagnostic test for syphilis which is based upon the complement binding method of Bordet and Gengou. They found that the serum of monkeys that had been treated with syphilitic material after a time acquired the property of binding complement when brought in relation with extracts of syphilitic materials. If now there are added a heated hemolytic serum and blood-corpuscles, no hemolysis takes place, since the complement has been combined with an antibody in the syphilitic extract.

Michaelis⁵ has found that it is possible to diagnose the presence of syphilis by means of a precipitation reaction when syphilitic serum and syphilitic liver extract are

¹ *Deutsche med. Wochenschrift*, 1907, p. 1572.

² *Berlin. klin. Wochenschrift*, Bd. xlv., p. 451.

³ *Univ. of Penna. Med. Mag.*, 1909.

⁴ *Deutsche med. Wochenschrift*, 1906, p. 745.

⁵ *Berliner klin. Wochenschrift*, Bd. xlvi., p. 1477, November 18, 1907.

mixed in certain definite proportions. The precipitation reaction is not produced with normal serum and syphilitic liver extract, nor with syphilitic serum and normal liver extract.

Personal Prophylaxis.—In treating cases of infectious diseases, it is inadvisable for the physician to wear specially constructed suits for his protection against infection. There are, however, a number of precautionary measures that should be taken. The physician may wear a linen duster or operating-coat over his clothing while in the sick-room, since this will not be so likely to alarm the patient, and will serve in a large measure to keep infective materials from his own clothing. This coat should be left in an ante-room or just outside the door of the sick-room, and should be disinfected after each visit in such diseases as small-pox and scarlet fever. He should time his visits so as to have a full stomach, and should spend as much time as possible in the open air subsequently. He should secure at least eight hours of sleep, so as to maintain his physical vigor. He should abstain from the use of alcoholic beverages. Personal cleanliness is of the greatest importance, and daily baths are to be recommended. Great care should be taken in keeping the hands and nails scrupulously clean, and it is advisable for the physician to wash his hands immediately after handling the patient. There is no doubt that many physicians have lost their lives in consequence of neglect of this point. This is especially true of typhoid fever, where the patient's body and clothing are soiled by fecal matter and urine. The same precautions apply with equal, or even greater, force to the nurse. Drugs have no influence whatever in warding off disease, though there is a widespread belief to the contrary among the laity.

Physicians as Carriers of Infection.—Dr. A. G. Young, Secretary of the Maine State Board of Health, gives the following method practised by him in rural districts to prevent the carrying of infection.

The Etiologic Factor, Avenues of Entrance, Sources of Infection, Modes of Dissemination, and Chief Preventive Measures of the Principal Acute Infectious Diseases.

| Disease. | Etiologic factor. | Avenues of entrance. | Sources of infection. | Modes of dissemination. | Preventive measures. |
|---|--|----------------------|--------------------------------------|---------------------------------------|--|
| Pneumonia | Bacterium pneumonie | Respiratory | { Direct and in- direct contact } | Sputum | Isolation and disinfection. |
| Diphtheria | Bacterium diphtherie | " | { Direct and in- direct contact } | Saliva | { Isolation, disinfection, and antitoxin. |
| Typhoid fever | Bacillus typhosus | Alimentary | Water and food | Feces and urine | { Isolation, disinfection, boil- ing water, and food. In- oculation. |
| Yellow fever | | Local | Mosquito bites | { Infected mos- quitoes } | { Isolation, disinfection, and exclusion of mosquitoes. |
| Tuberculosis | Bacterium tuberculosis | " | { Direct and in- direct contact } | Sputum and pus | Isolation and disinfection. |
| Erysipelas | Streptococcus pyogenes | " | { Direct and in- direct contact } | { Secretions, epi- thelial cells } | " " " |
| Cholera | Vibrio cholere | Alimentary | Water and food | Feces | { Isolation, disinfection, boil- ing water, and food. In- oculation. |
| Cerebrospinal meningitis } Influenza | M. intracellularis | Respiratory (?) | { Direct and in- direct contact } | Excretions | Isolation and disinfection. |
| Tetanus | Bacterium influenza | Respiratory | { Direct and in- direct contact } | Sputum | " " " |
| Plague | Bacillus tetani | Local | Infected dust | Pus | " " " |
| Gonorrhoea | Bacillus pestis | " | Flea bites | Fleas | { Isolation and destruction of rats. Inoculation. |
| Anthrax | Micrococcus gonorrhoe | " | { Secretions and dust, fomites } | Pus | Isolation and disinfection. |
| Malignant edema | Bacterium anthracis | " | { Infected dust Bedbugs (?) } | " | " " " |
| Relapsing fever. | Bacillus cedemre Spirochaeta obermeieri | Unknown | | Secretions Insects (?) | " " " Destruction of bedbugs. |

| | | | | | |
|-------------------------|---------------------------|-------------|---|----------------|--|
| Leprosy. | Bacterium lepre | Local | { Fomites and secretions } { Secretions from lesions } { Secretions } | Secretions | Isolation and disinfection. |
| Syphilis. | Spirochaeta pallida | " | " | " | " |
| Glanders | Bacterium mallei | " | " | " | " |
| Actinomycosis | Actinomyces bovis | " | " | " | " |
| Small-pox | Unknown | Unknown | Fomites | Desquamations | Vaccination. |
| Measles | " | " | " | " | " |
| Scarlet fever | " | " | " | Saliva | " |
| Mumps | " | Respiratory | Contact | Sputum | " |
| Whooping-cough | " | " | " | Mosquitoes | " |
| Malaria | Plasmodium malariz | Local | Mosquito-bites | " | { Exclusion of mosquitoes and isolation of cases. } |
| Filaria | Filaria sanguinis hominis | " | " | " | { Exclusion of mosquitoes and isolation of cases. } |
| Carbuncle | Staphylococcus pyogenes | " | Contact | Pus | Isolation and disinfection. |
| Trichinosis | Trichina spiralis | Alimentary | Diseased meat | Feces | Destruction of diseased animals and meat. |
| Favus | Achorion Schönleinii | Local | Contact | Secretions | Isolation and disinfection. |
| Dysentery | Bacillus dysenteriz | Alimentary | Water and milk | Feces | Isolation, disinfection, boiling water and food. |
| Botulismus | Bacillus botulinus | " | Infected meat. | " | " |
| Varicella | Unknown | Unknown | Fomites | Desquamations | " |
| Dengue | " | " | Fomites (?) | Secretions (?) | " |
| Typhus fever. | " | " | " | " | " |
| Rabies | " | Local | Bite of animal | Saliva | { Cauterization of wound, destruction of diseased animals, and muzzling of dogs. } |
| Rheumatism | " | Unknown | " | " | " |
| Scabies | Sarcoptes scabiei | Local | { Direct contact } { Infected water and milk } | Direct contact | Isolation and disinfection. |
| Euteritis | Bacillus sporogenes | Alimentary | " | Feces | Boiling water and milk. |

When visiting cases of small-pox, diphtheria, or other infectious diseases, a good method of procedure is to leave overcoat, hat, undercoat, and usually collar and necktie outside of the house containing the patient. Call for an earthenware washbowl from the house and a quart of hot water—nothing else. From a small and tightly closing bag take out a bottle of bichlorid tablets, one or two of which are dropped into the washbowl to be dissolving while inside ; then take out and slip on a pair of white duck trousers, then a barber's white coat with an extra button which buttons up closely around the neck. Rubber bands around the ends of the sleeves of the coat and a silk skull-cap complete the attire. After leaving the infected room soak the hands in the bichlorid solution, remove a towel from the grip, a two-ounce vial of formaldehyd solution, and two surgeon's hand-brushes. Then take off the white coat and trousers, roll them up carefully, and place them in the grip with the cap. Then wash the hands again in the disinfecting solution, and wash the wrists, head, face, and neck, wetting the hair thoroughly. Dipping the brushes in the bichlorid solution, scrub down the clothing, particularly the lower part of the trousers, and finally the boots. Then all the remaining things are placed in the grip, the towel on top. Upon this towel pour an ounce or more of formaldehyd solution, and close the grip immediately. The things are disinfected in five or six hours. The bag usually remains closed the following night, and the next morning is opened and the things are aired for further use.

The following scheme is one that is very easily applied and has been adopted by hundreds of physicians as at once practical and effective :

After contact with a contagious case, the clothing is removed and hung in a tight closet; a Schering lamp lighted and placed therein, and the closet-door shut. If the closet is tight, the clothing hung loosely, and the door kept closed while the lamp is burning, five or six hours' contact will give efficient disinfection.

In the preceding table an attempt has been made to present in concise form the more important points with regard to the direction in which it is necessary to extend our energies in controlling the principal infectious diseases. Not all of the preventive measures employed in the different diseases are here given, but only those which are deemed to be the leading measures. The details with regard to the special modes of disinfection adapted to the more important of these diseases are given in the chapter on Disinfection.

Persistence of Pathogenic Bacteria in Dead Bodies.—The possible danger of the infection of the soil and water through pathogenic bacteria derived from dead bodies after burial has been frequently discussed.¹ Klein has made a practical investigation of the subject. He inoculated guinea-pigs intraperitoneally with different organisms, and after death they were wrapped in cotton, placed in small wooden or tin boxes, or without these, and buried in moist earth or sand. When exhumed, the abdominal cavity of the animals was opened and washed out with 1 or 2 cubic centimeters of sterile salt solution, and this fluid was used to make cultures. *Bacillus prodigiosus* and *Staphylococcus aureus* were found alive after twenty-eight days, but had disappeared entirely in six to eight weeks. Cholera organisms were found alive after nineteen days, but had disappeared after twenty-eight days. Similar results were obtained with typhoid, diphtheria, and plague bacilli. Tubercle bacilli died during the first seven weeks. The studies of Gildersleeve² show that virulent bacteria, such as *Bacillus tuberculosis* and *Staphylococcus pyogenes aureus*, can be recovered from dead bodies in the dissecting-room. Bodies preserved in strong brine or kept in cold storage for as long as six months still contained the virulent bacteria.

These results indicate that there is danger of the con-

¹ *Centralbl. f. Bacteriologie*, Bd. xxv., S. 727.

² *Univ. Penna. Med. Bull.*, November, 1901.

tamination of the soil and water in the vicinity of cemeteries when the bodies of those dying from infectious diseases are not disposed of in a proper manner. The bodies should be wrapped in sheets moistened with 1 : 1000 bichlorid of mercury solution, or 5 per cent. carbolic acid solution; all the orifices should first be efficiently plugged. The bodies should be placed in hermetically sealed coffins, so that there is no possibility for the infectious material to escape. Cremation would be the quickest and safest method of disposal of the bodies of persons dying of infectious diseases, but this mode of disposal is objectionable to many persons.

Prevention of Malaria.—As was shown by Smith and Kilborne, and substantiated by Koch, certain insects are the carriers of the infective organisms of Texas cattle fever. Manson and Ross have demonstrated that a certain kind of fly is the carrier of infection for birds, and that certain species of mosquitoes are the carriers of the malarial infection for human beings. They found the evolution cycles of the resistant form of the malaria parasites in the bodies of Anopheles, while in man the parasites assume the asporulation phase, so that man is merely the temporary host of the parasites. According to Mattei,¹ the evolution cycle of the malaria parasites consists, therefore, of a chain of two rings—man and the mosquito—man infected with malaria infects healthy mosquitoes, and the infected mosquitoes infect healthy persons, thus completing the cycle.

The species of mosquito which appears to be principally, if not entirely, concerned in carrying malarial infection to man is the Anopheles. Mattei found that protection against mosquitoes by means of wire screens at windows and doors, and mosquito-netting, served to protect against malaria while sojourning in malarious localities. Sambon and Low, of the London School of Tropical Medicine, demonstrated the same thing while living in notoriously malarious localities in Italy.

¹ *Centralbl. f. Bacteriologie*, Bd. xxviii., S. 189.

Dr. Elliott, a member of the Liverpool Expedition to West Africa, and Prof. Grassi,¹ the leader of an Italian expedition to the plains of Capaccio, Italy, report similar results. Wire screens and mosquito-netting were found to exclude the *Anopheles* from habitations, but failed to exclude the non-infecting *Culex*.

A. Celli² succeeded in limiting the incidence of malaria

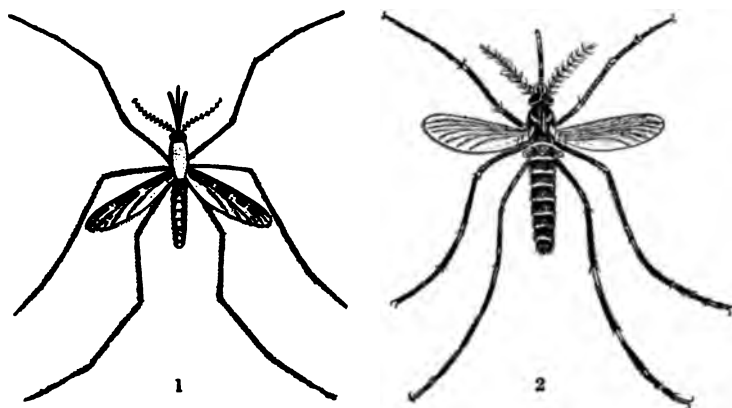

FIG. 59.—Mosquitoes instrumental in the dissemination of malarial and yellow fevers: 1, *Anopheles*; 2, *Stegomyia*.

in the railroad employees of the malarious districts of Italy by protecting the windows with wire screening of 1 to 1.5 square millimeters mesh, attaching automatic locks to the doors, covering the chimneys with wire screening, and whitewashing the walls. In front of the doors was placed an antechamber constructed of wire screening. Those who were obliged to work out-of-doors at night had all exposed portions of the body protected: the head and face by means of a wire mask, and the hands by means of gloves. Of the 207 officials protected in this

¹ *Centralbl. f. Bacteriologie*, Bd. xxviii., S. 535.

² *Ibid.*, Bd. xxviii., S. 696.

manner, only 10 contracted malaria, while all unprotected persons in the same locality suffered from the disease.

Manson¹ reports a most interesting experiment demonstrating the direct relation of mosquitoes to malarial infection. He reports the successful inoculation in London with malaria of an uninfected individual by means of mosquitoes brought from Italy. The subject, Dr. Manson's son, submitted on three occasions to the bites of the imported and infected mosquitoes, with the result that within a few days after the third inoculation symptoms of tertian malarial fever appeared, together with the presence of the corresponding parasites in the blood. Relief was promptly afforded by the administration of quinin. Similar observations are said to have been made in New York City on a patient in Bellevue Hospital, who volunteered for the purpose of the experiment.

Immunity against Malaria.—Koch believed that long-continued residence in a malarious district led to immunity as indicated by the absence of parasites in the blood of adults. This position is disputed by Glogner,² who does not regard the absence of parasites in the blood as proof positive of freedom from malaria. He contends that the continued infection of these persons is shown in the marked anemia and enlarged spleens which they present. Glogner does not believe that there is any immunity conferred by an attack of malaria.

Prevention of Yellow Fever.—The theory of the propagation of yellow fever by mosquitoes was advanced by Dr. Carlos J. Finlay, of Havana, as early as 1881. In a preliminary report of the investigations of a commission sent to Cuba by the Surgeon-General of the U. S. Army, to study yellow fever, which Dr. Walter Reed presented before the American Public Health Association at Indianapolis, Ind., October 24, 1900, are brought forward most interesting and important facts with regard to this mode of dissemination of the disease. These investigations by the commission confirm the observations of Dr.

¹ *British Medical Journal*, Sept. 29, 1900, p. 949.

² *Virchow's Archiv*, vol. clxii., p. 222.

Henry R. Carter, Surgeon of the Marine-Hospital Service at Orwood and Taylor, Miss., that "the period from the first (infecting) case to the first group of cases infected at these houses (isolated farm-houses) is generally from two to three weeks." After the houses had become infected susceptible individuals thereafter visiting the houses for a few hours fall sick with the disease in the usual period of incubation,—one to seven days.¹

Other observations, made by Reed and his assistants in Cuba, confirmed Dr. Carter's conclusions, "thus pointing, as it seemed to us, to the presence of an intermediate host, such as the mosquito, which, having taken the parasite into its stomach, soon after the entrance of the patient into the non-infected house, was able after a certain interval to convey the infecting agent to other individuals, thereby converting the non-infected house into an 'infected' house. This interval would appear to be from nine to sixteen days (allowing for the period of incubation), which agrees fairly closely with the time required for the passage of the parasite from the stomach of the mosquito to its salivary glands."

The members of the Yellow Fever Commission of the Liverpool School of Tropical Medicine, Drs. Durham and Meyers, were impressed, also, with the importance of Dr. Carter's observations.²

The species of mosquito which serves as the intermediate host in yellow fever has been identified by L. O. Howard, Ph.D., Entomologist, Department of Agriculture, Washington, D. C., as *Stegomyia fasciata*, Fabr.

The present views of Dr. Finlay on this subject are as follows: "First, reproduction of the disease, in a mild form, within from five to twenty-five days after having applied contaminated mosquitoes to susceptible subjects. Second, partial or complete immunity against yellow fever obtained even when no pathogenous manifestations had followed these inoculations."³

¹ *Philadelphia Medical Journal*, October 27, 1900.

² *British Medical Journal*, pp. 656-7, September 8, 1900.

³ *Medical Record*, vol. lv., No. 21, May 27, 1899.

Reed and his assistants failed to find any specific micro-organisms in the blood of yellow-fever patients, nor in the cadavers of yellow-fever subjects. They were able, however, to inoculate the disease successfully by means of infected mosquitoes in non-immune subjects after ten to twelve days had elapsed from the time of sucking the blood of yellow-fever patients; the period of incubation was the usual one, and the symptoms developed were typical.

These facts tend to explain many of the points that were obscure heretofore; notably, the fact that frost arrests the spread of yellow fever. This fact is, no doubt, due to the destruction of infected mosquitoes by the frost. The immunity of the pine belt of the Southern States may also be explained by the fact that in these regions the conditions of life and multiplication are unfavorable to mosquitoes.

Extermination of the mosquito in Havana resulted in the virtual eradication of yellow fever. In an official report Major W. C. Gorgas, of the Army Medical Department, who was chief sanitary officer of General Wood's staff, says:

"We commence June with the city free from yellow fever, no cases being on hand. This is probably the first time Havana has ever entered June free from yellow fever. April and May also commenced in the same way.

"Formerly we paid no particular attention to the mosquito, merely disinfecting for yellow fever, as we do for other infectious diseases. The amount of sanitary work done formerly continues, but most of our attention is now being paid to the destruction of mosquitoes.

"The suburbs and the small streams in the suburbs have been thoroughly cleaned out, and pools have been oiled and drained. The Mayor has issued an order prohibiting the keeping of standing water within the city limits unless made mosquito-proof. This is being enforced, and all standing water found not protected is emptied and the owner fined."

The results of regulations instituted in Cuba by the military authorities of the United States for the control of yellow fever have been most gratifying. Aside from a diminution of the incidence of malaria, there was a rapid diminution of the death-rate from yellow fever. While the average death-rate from yellow fever had been 467 annually, the number fell, soon after the introduction of the preventive regulations, to 5 in 1901, and since September 28, 1901, there has been no case of yellow fever in Havana.

The Destruction of Mosquitoes in the City.—C. Fermi and S. Lumbao¹ give brief biologic notes on the mosquitoes which most commonly infest cities. As insecticides against mosquito larvæ, the authors used petroleum and chrysanthemum powder with good success. Several substances were experimented with for the purpose of discovering means for the prevention of the too rapid evaporation of petroleum from the surface of infested water. The substances which were spread upon the surface of the petroleum for this purpose were lanolin, vaselin, tar, naphthalin, olive oil, flaxseed oil, castor oil, and lard. Vaselin and tar spread rapidly over the surface of the oil without coagulating. A large number of plant substances were tried in combination with chrysanthemum powder in the destruction of mosquito larvæ. For the destruction of adult mosquitoes the authors tried fumigation with a number of substances, among which the following gave the best results: chloroform, turpentine and vinegar, sulphuric ether, tobacco fumes, and eucalyptus fumes.

The relation of marshy ground to yellow fever is probably less direct than that of its relation to malaria, since the *Stegomyia* appears to breed in water-tanks and places of that character rather than in marshes, as is the case with the *Anopheles*. The experience of the military authorities of the United States during the occupation of Cuba demonstrated that general hygienic measures

¹ *Centralbl. f. Bact.*, 1 abst., pp. 179-185, 1900.

along with the drainage of the marshes had only a moderate influence in reducing the incidence of yellow fever during the first year of the occupation. During the second year, when, in addition to this, energetic measures were employed to eradicate the mosquitoes, the influence upon the incidence of yellow fever was most striking, and with the continuation of the measures it has continued so up to the present time.

During the experiments with petroleum it was found that 5 c.c. per square meter of water surface killed all mosquito larvæ. It was not found necessary to renew the kerosene upon the surface oftener than once in fourteen days.

Dr. M. J. Rosenau¹ studied the relative efficiency of formaldehyd and sulphur dioxid as disinfectants against mosquitoes. Young healthy mosquitoes were exposed to the disinfectants in pill-boxes and at the same time test-objects containing bacteria were also exposed to the gas for purposes of comparison.

Rosenau reached the conclusion that formaldehyd is a feeble insecticide. "To succeed in killing all the mosquitoes in a closed space with formaldehyd gas, the following requirements are essential: A very large volume of gas must be liberated quickly, so that it may diffuse to all portions of the space in sufficient concentration. The room must have all the cracks and chinks where the insects may breathe the fresh air carefully sealed by pasting strips of paper over them. The room must not contain heavy folds of drapery, clothing, bedding, or fabrics in heaps, or so dispersed that the insects may hide away from the full effects of the gas."

With regard to sulphur dioxid, the results were far more satisfactory. Rosenau states that "sulphur dioxid is unexcelled as an insecticide. Very diluted atmospheres of the gas will quickly kill mosquitoes. It is as efficacious for this purpose when dry as when moist, whereas the dry gas has practically no power against bac-

¹ *Bulletin No. 6 of the Hygienic Laboratory, 1901.*

teria. Contrary to formaldehyd it has surprising powers of penetrating through clothing and fabrics, killing the mosquitoes, even when hidden under four layers of towel- ing, in one hour's time—and in very diluted proportions. This substance, which has so long been disparaged as a disinfectant because it fails to kill spores, must now be considered as holding first rank in disinfection against yellow fever, malaria, filariasis, and other insect-borne diseases."

Destruction of Vermin.—Vermin of other sorts than mosquitoes transmit disease. Rats have been known to carry the plague from ships; flies have carried tuberculosis and typhoid; bedbugs and fleas are considered dangerous.

Experiments in disinfection for getting rid of vermin have shown that the work is one of some difficulty. In the *Annales de Pharmacie* a report is given of the investigations of Mr. V. Haazen.

According to Mr. Haazen's results, bedbugs resist exposure for twenty-four hours to an atmosphere containing 6 grams of formaldehyd gas per cubic meter (or 2.6 grains per cubic foot).

Bedbugs were partly, but not entirely, killed by a concentration of 8 grams per cubic meter (3.5 grains per cubic foot). All perished when the concentration was made 9 grams per cubic meter (3.9 grains per cubic foot).

The complete destruction of bedbugs is accomplished also by burning 25 grams of sulphur for each cubic meter of space (or 10.7 grains per cubic foot).

Flies and mosquitoes are killed by burning 2 grams of solidified formaldehyd for each cubic meter of air (0.88 grains per cubic foot).

Fleas require for destruction 7 grams of the formaldehyd per cubic meter (3.08 grains per cubic foot).

For rats and mice an exposure of thirty-six hours to an atmosphere containing 15 grams of formaldehyd per cubic meter (6.6 grains per cubic foot) was found necessary.

The **extermination of rats**,¹ because they are the carriers of plague-infection, seems fast becoming a duty of all civilized governments. The Local Government Board of England recognizes this fact in a circular to the sanitary authorities on the risk of importing the disease by means of ships infested with plague-infected rats and the precautions necessary to prevent such introduction. On other grounds it would be well if these justly detested animals could all be killed. These pests have been supposed to be scavengers, but the answer to the plea is that the filth upon which they live is unnecessary, and even a danger.

Simon believes the infection is due to the fleas with which rats are commonly infested; but Dr. Nuttall, who has made an extensive study of the subject, claims that his researches do not bear out Simon's theory. Prof. Ashburton Thompson, in an account of the plague in New South Wales, says that he is convinced the disease reached Sidney through the rats on vessels from Noumea, at which place the plague existed. His investigations lack a connecting link between rats and man, and the hypothesis that infection is conveyed by a suctorial insect infecting rats and transferable to man would furnish this link. Certain it is that rats are easily inoculable, and that they do carry the disease over the world. Their ingenuity and pertinacity in infesting all ships and the unsanitary quarters of all cities are most remarkable. The medical commission of the Japanese Government says that to avoid the spread of bubonic plague rats must be exterminated. But this is plainly an almost impossible task. It would, however, seem possible to kill them on ships from infected ports. An effective method of doing this has been suggested by means of sulphurous acid forced into all parts of the vessel for twenty-four hours.

Extermination of rats, by means of the generation of sulphurous acid gas of a high strength, has been successfully tried on the "Jelunga," a steamer of the British

¹ *American Medicine*, vol. i., 1901.

India line. The apparatus used was a small cylinder in which rolled sulphur was burned until it vaporized and air being admitted into the chamber where this vaporizing took place the combination of oxygen and sulphur vapors furnished the sulphur dioxid gas. The hatches of the "Jelunga" were closed and the gas admitted. The space to be operated on held 2100 cubic meters. The next day when the vessel was opened dead rats were lying about and all other forms of vermin were also killed.

Relation of Insects to the Spread of Disease.—

Within recent years we have come to regard many of the common insect pests with suspicion. This is especially true since the discovery by Ross that the mosquito plays the part of definitive host for the parasite of malaria. The earliest positive demonstration of the instrumentality of insects in the dissemination of disease was made by Smith and Kilbourne. They demonstrated that the tick—*Boophilus bovis*—infesting the cattle of the Southern States is instrumental in disseminating the disease Texas fever from sick cattle to the well. Within the last few years a number of other diseases have been found to be disseminated, wholly or in part, through the agency of insects. The relation of insects to the spread of disease may be divided into several classes according to the nature of the organisms and the mode of transmission.

1. Insects may convey pathogenic bacteria on their bodies by coming in contact with infective materials, as tubercular sputum, typhoid, dysentery, or cholera stools. Bacteria may be conveyed considerable distances and then deposited on food-materials, and thus form a new focus of infection. The insect which is probably most frequently the disseminating agent of such diseases is the common house-fly—*Musca domestica*.

An epidemic of typhoid fever in Chicago during the summer of 1902 was most severe in one of the wards of that city. In this ward, containing one-thirty-sixth of the population of the city, there occurred over one-

seventh of the deaths from this disease. The epidemic could not be attributed to the character of the food or to the water-supply, as these did not differ in any respect from the supplies of neighboring wards. An examination of the sewerage of the ward revealed the fact that many of the sewers were too small to carry the sewage. Only 48 per cent. of the houses had sanitary plumbing, while 7 per cent. had defective plumbing, 22 per cent. had water-closets with intermittent water-supply, and 11 per cent. had privies with no sewer connections. Flies caught in two undrained privies, on the fences of two yards, on the walls of two houses, and in the room of a typhoid patient were inoculated into eighteen tubes, and from five of these tubes the typhoid bacillus was isolated. It is evident that this epidemic was brought about by the dissemination of the infectious material by flies.

Roaches may also become agents in disseminating typhoid, dysentery, and cholera by coming into contact with infective material in drains and sewers and subsequently carrying the infectious materials on their bodies to food-materials.

2. Flies may carry tubercle bacilli within their bodies when they are permitted to feed on tubercular sputum. Live tubercle bacilli have been obtained from the feces of flies fed on tubercular sputum. Consequently the feces of flies may be a source of danger. Flies may also serve to carry, in a similar manner, the micro-organisms of a number of other infectious diseases, as diphtheria, pneumonia, erysipelas, suppuration, and possibly of small-pox, though we have as yet no positive proof of the conveyance of small-pox in this manner. Dr. Ficker¹ has found that flies fed on typhoid cultures give off the bacilli twenty-three days after infection. Typhoid bacilli were found in the intestine nine days after feeding on typhoid materials.

3. Suctorial insects, by sucking the blood of persons or animals containing certain bacteria or animal parasites,

¹ *Arch. f. Hygiene*, Bd. xlvi., S. 274.

may transmit these organisms by means of the proboscis to healthy persons or animals. Gad-flies or horse-flies may carry anthrax bacilli in this manner and infect healthy persons or animals. The common bed-bug is believed to be instrumental in disseminating the parasite of relapsing fever in a similar manner. Dr. Karlinski¹ believes that bed-bugs are the direct transmitting agents of relapsing fever. The spirilla were found in the intestinal contents after twenty days, while they disappeared rapidly in lice and fleas. The agency of fleas in the dissemination of bubonic plague has been claimed, and this is probably one of the modes of transmission of the disease. Gauthier² shows that fleas transmit plague from rat to rat. Fleas taken from a living infected rat caused plague in nine of ten rats. The fleas of these animals were also found to bite human beings, and Gauthier therefore concludes that the connection between the presence of infected rats in a district and the sufferers from plague is represented by these insects. Dr. Zirolia³ found *Bacillus pestis* in fleas fed on infected mice. These bacilli were found to be virulent seven to eight days after infection. The bacilli were also demonstrated in the feces. The work of the English Plague Commission⁴ leaves little doubt that this is the mode of dissemination of the disease from infected to healthy rats. It appears quite probable that the dissemination of the disease to human beings occurs through the bite of infected rat fleas. The flea which is found most commonly on rats in warm countries is *Pulex cheops*. These fleas occur on both *Mus rattus* and *Mus decumanus*. The rat flea in northern countries, where observations have been made, is *Ceratophyllus fasciatus*. This flea is also found on the common house mouse, *Mus musculus*, but less commonly than *Ctenopsylla musculi*.

¹ *Centralbl. f. Bacteriologie*, Bd. xxxi., S. 566.

² *Bull. de l'Acad. de Mtd.*, December 16, 1902.

³ *Centralbl. f. Bacteriologie*, Bd. xxxi., S. 87.

⁴ *Jour. of Hygiene*, March, 1908.

The flea which is most likely to harbor on human beings is *Pulex irritans*, though *Pulex cheops*, the common rat flea, will also bite human beings when its natural host is absent.

Fleas are instrumental in carrying trypanosomes to rats. Trypanosomes have also been found in the stomachs of lice feeding on the blood of infected animals. In Africa trypanosomes are transmitted to horses, cows, sheep, and dogs through the bite of the tsetse fly, *Glossina morsitans*. Sleeping sickness, a trypanosomiasis in human beings prevalent in Africa, is transmitted by another species of tsetse fly—*Glossina palpalis*.

4. The transmission of the malarial and yellow-fever parasites to man, as well as the transmission of similar parasites to birds, through the agency of certain species of mosquitoes, is now well established. In the transmission of these diseases the insects are not merely the carriers of the parasites, but also serve the important function of hosts for the parasites in that a certain phase of the life-cycle of the parasite is passed in the bodies of these insects. Without either man or the specific mosquito the malarial and yellow-fever parasites would perish, as it is believed that both are necessary for the completion of the life-cycles of the parasites. The *Anopheles* is the species of mosquito instrumental in the transmission of malaria, while the *Stegomyia* is the species instrumental in the transmission of yellow fever. These insects suck the blood of patients suffering from these diseases, and then the fecundated female elements penetrate the wall of the stomach of the mosquito and become encysted. After maturation of the sporocysts they rupture into the body cavity, whence the young parasites find their way into the salivary glands of the mosquito and are then projected through the proboscis into the tissues of healthy persons during the act of sucking blood. In the transmission of parasites similar in nature to the malarial organism from diseased to healthy birds—sparrows, canaries, crows, buzzards, etc.—it is believed

that the common *Culex* variety of mosquito is the disseminating agent. In the diseases of birds the mosquito plays the same part as in the transmission of malaria and yellow fever in that the parasites undergo one phase of their life-cycle in the bodies of the mosquitoes. The conditions necessary for the occurrence of malaria or yellow fever in a community are the following: (*a*) The primary existence or importation of a case of the particular disease; (*b*) the presence of the particular genus of mosquitoes; (*c*) the infection of the mosquitoes by sucking the blood of the patient; (*d*) the presence of non-immune persons in the community to which the infected mosquitoes may transmit the disease after the lapse of time necessary for the maturity of the young parasites in the body of the mosquito; (*e*) the continuance of the epidemic subsequent to the occurrence of secondary cases requires suitable climatic and telluric conditions for the breeding of the mosquitoes; and (*f*) suitable temperature for development of the zygote in the stomach of the mosquito.

The prevention of the dissemination of either malaria or yellow fever requires observation of the following conditions: (*a*) It is necessary to prevent mosquitoes from gaining access to patients suffering from the disease by suitable screening, because non-infected mosquitoes cannot transmit the disease; (*b*) the protection of healthy persons from mosquito-bites; in this manner they can be kept free from the disease even though infected mosquitoes exist in the community; (*c*) the adoption of measures for the destruction of mosquitoes in all stages of their development—*i. e.*, draining all marshy places, pouring oil on all stagnant waters that cannot be drained, protecting water-tanks, etc., so as to prevent mosquitoes from gaining access thereto; destruction of adult mosquitoes in houses by means of insecticides, as petroleum, pyrethrum powder, or sulphur dioxid gas.

The transmission of filaria by means of mosquitoes

presents certain factors which are similar to those appertaining to the transmission of malaria and yellow fever. The parasite is taken into the stomach of the mosquito, and transmission to other individuals takes place after it has undergone a certain phase of its development in the body of the mosquito. The young parasites are lodged in the sublingual region at the root of the proboscis, whence they find their way into the saliva and are transmitted in the act of biting. Both *Culex* and *Anopheles* are believed to be instrumental in the transmission of filaria.

5. Still another manner in which insects transmit disease is that of the transmission of Texas cattle fever by means of the cattle tick—*Boöphilus bovis*. This mode of transmission differs from those already considered in that the fecundated female tick sucks the blood of infected cattle and transmits the parasite to her eggs, and the young ticks in turn transmit the parasite to healthy cattle while sucking their blood. Two generations of ticks are necessary for the transmission of the disease from sick to healthy cattle. The exact manner of the transmission of the parasite from the infected tick to the egg and offspring has not been demonstrated.

A tick—*Dermacentor occidentalis*—is instrumental in the transmission of the "spotted fever" of the Rocky Mountain regions. Another tick—*Ornithodoris moubata*—is instrumental in the transmission of African tick fever.

Remedies for Fleas.—The subject of domestic pests has been fully treated in publications of the Division of Entomology of the Department of Agriculture, and the work of the Division has been supplemented by interesting experiments along the same line by several of the State Experiment Stations. Especially valuable results have recently been obtained in experiments with remedies for the extermination of fleas.

At times fleas, especially the dog- and cat-flea, become one of the most troublesome of household pests. Nu-

merous remedies have been recommended for ridding houses and animal pets of these pests, but these remedies have not proved effective under all circumstances. The Division of Entomology recommends thorough sweeping and cleaning of floors and walls, the disuse of carpets and mattings and their replacement with rugs, which are to be removed and beaten at frequent intervals. It is also recommended that infested carpets and other such objects be dusted with pyrethrum powder or sprinkled with benzine. Failing in these measures the removal of carpets and thorough scrubbing with hot soapsuds are recommended.

In some experiments made in Scotland by R. S. MacDougall it was found desirable to cleanse dog-kennels with lime-wash, to wash dogs and cats with soapsuds, and then sprinkle them thoroughly with pyrethrum powder. The use of creolinated water in a 10 per cent. solution was also found effective in ridding houses of fleas and in destroying these insects upon dogs. In some parts of Mexico, according to MacDougall, brooms are made of *Asclepias curassivica*, a kind of milk-weed, and walls and floors of infested houses are swept with these brooms. The odor of this plant when thus utilized has been found to check the spread of the flea nuisance in houses.

At the Vermont Experiment Station satisfactory results were obtained by sprinkling infested animals and kennels with kerosene emulsion, but this remedy is not applicable in households on account of the disagreeable odor and other effects of kerosene. At the Michigan Experiment Station pyrethrum gave excellent results in ridding houses of fleas. This remedy, however, has not always proved effective, and in some instances was apparently without effect.

In experiments at the New Hampshire Experiment Station it was found that creolin was the most satisfactory remedy. This may be used in a diluted form as a

disinfectant, deodorant, insecticide, and repellent. It was found that a 3 per cent. solution was sufficiently strong for ordinary purposes. Infested dogs and cats may be thoroughly washed with this mixture, which may be made slightly weaker for cats on account of the greater sensitiveness of the fur of this animal. The animals may also be dipped in the solution. Commercial creolin may be purchased at drug-stores for about 25 cents a pint. A 3 per cent. mixture with water may be made by adding 4 teaspoonfuls of creolin to a quart of water or 4 tablespoonfuls to a gallon. A 2 per cent. solution is obtained by adding 2 teaspoonfuls to the quart or 2 tablespoonfuls to the gallon of water. When thoroughly shaken, the mixture is ready for use. The mixture may be applied to the animal with the hands or a brush, or, as already suggested, the animal may be submerged in the solution for about five minutes. The animal requires no further care or treatment after the application. This treatment not only destroys the fleas, but also serves as a deodorant.

In treating floors it is recommended that all unnecessary objects be removed, and that cracks and crevices should be scrubbed with a 5 per cent. solution of creolin. The bedding of animal pets infested with fleas should be thoroughly saturated from time to time with a 5 per cent. solution of creolin.

Two other remedies which are quite effective against fleas have been recommended with some reservation, but these remedies are perhaps too dangerous for general use in households. Reference is had to fumigation with carbon disulphid and hydrocyanic acid.

The above-mentioned remedies include nearly all the substances which have been found effective in destroying fleas. In combating these insects, however, it should always be remembered, as the Division of Entomology of the Department of Agriculture points out, that the infestation of houses is due to the presence of flea-

fested dogs or cats, which are allowed to occupy some portion of the house during a part or all the time. Fleas normally live as parasites upon the animals which they infest or upon man, but eggs which are laid by the parasitic adult insects may fall upon the floor or the carpets of houses, and after hatching, may live for an indefinite period upon the dust which accumulates under carpets and in the cracks of floors. In ridding a house of fleas attention should, therefore, be directed first to treatment of the dogs or cats from which infestation originates. This treatment, if done in a thorough manner, will rid the animal pets of fleas and will prevent re-infestation of the house after a thorough application of the insecticides.

Animal Parasites.—Animal parasites are living organisms which live in or upon other living organisms for the purpose of obtaining nutrition, and live there either temporarily or permanently. The parasitism is of different forms and various grades in the different parasites, and Leuckart has divided them into two classes—temporary and permanent parasites. Among the temporary parasites may be mentioned the flea (*Pulex irritans*), the bed-bug (*Cimex lectularia*), the leech (*Hirudo medicinalis*), the different species of mosquitoes, as well as others which seek the host merely for the purpose of sucking blood, and depart after having satisfied their hunger. Their entire existence from the egg to the adult stage is passed outside the body of the host. These parasites attack only the surface of the body of the host, and hence have been called epizoa or ectoparasites, though these terms do not apply to the temporary parasites alone.

The permanent parasites pass a portion or even their entire life in or upon the body of the host, so that they obtain lodging as well as nutrition from the affected host. These parasites usually live within the body of the host, principally in those organs which are readily accessible from the outside, as the intestines and their append-

ages, though others invade the muscles, lymphatic system, circulatory system, bone-marrow, brain, etc.

In many instances it is not possible to demonstrate a definite influence exerted by the parasite upon the host organism. But in other instances the presence of the parasite is manifested by its particular location, the number of parasites, the movements induced, or the nutrition absorbed from the host, in consequence of which they induce more or less marked disturbances of the health of the host, or may even lead to its destruction. Certain of the animal parasites evidently produce poisonous metabolic or excretory products which give rise to definite symptoms. There is evidence to believe that in malaria, yellow fever, trypanosomiasis, and other diseases the grave symptoms produced by the infection are due to poisons generated by the parasites as the result of their development and metabolism.

Protozoa.—The protozoa are unicellular animal organisms which multiply in two ways: sexual and asexual development. The asexual development takes place within the body of the host under favorable conditions, and as a result there may be an enormous increase in the number of individuals. The sexual mode of development serves for the preservation of the species in that it supplies a phase in the life of the parasite when it may be transplanted from one host to another. Most of the protozoa are nourished either by osmosis or by the invagination of small food-particles. One class of the protozoa, the suctoria, possess small suctorial tubes through which they take up their nutrition.

Amoeba coli (Loesch).—This parasite was found by Koch and Gaffky in 1883 in Egypt in the intestines of five cases of dysentery that came to autopsy. Since that time the parasite has been found in all parts of the civilized world, and is regarded as the etiologic factor of tropical dysentery.

This parasite is evidently taken into the system in polluted water, or food that has been grown on

soil fertilized with human excrement. The preventive measures which are most serviceable are prompt disinfection of all stools from cases of chronic dysentery, filtration or sterilization of infected water-supplies, and the avoidance of raw food that might possibly be the carrier of the infective agents.

Source of the Ameba and Mode of Infection.—Futcher¹ states that "very little is known regarding the source of the ameba and the mode of infection. We are still absolutely unfamiliar with the life-history of the parasite outside of the body. Inoculation experiments by way of the mouth, with the possible exception of those of Quincke and Roos with the so-called encysted forms, have been entirely negative. It is highly probable that infection takes place by way of the gastro-intestinal tract, and that amebic dysentery is contracted in much the same way that typhoid fever, cholera, and bacillary dysentery are contracted."

The Plasmodium of Malaria.—The plasmodium of malaria belongs in the order Hæmosporidia, class Sporozoa. Three different parasites, the Plasmodium malariae, the parasite of quartan, Plasmodium vivax, the parasite of tertian, and Laverania malariae, the parasite of quotidian fever. Though these three parasites differ in their morphologic and biologic characters, it is believed that each of them finds in the Anopheles its appropriate definitive host in which it undergoes sexual development or sporogony. In man it undergoes the non-sexual development, or schizogony.

Trypanosomiasis.—The occurrence of trypanosomes in human blood was first reported by Dutton.² The prevalent type of trypanosomiasis infection in Africa is sleeping sickness. The parasite found in man has been named Trypanosoma gambiense, and is believed to differ from the trypanosomes producing nagana, or tsetse-fly disease of horses, occurring in Zululand and South and West

¹ Futcher, *Jour. Amer. Med. Assoc.*, 1903, vol. i., p. 480.

² *Thompson-Yates Laboratory Reports*, 1902, vol. iv.

Africa; surra, in India; dourin, in Algiers; mal de Cad-
eras, in South America; and a disease of cattle recently
discovered in Pretoria. The experimental evidence at
hand indicates that each of the parasites producing these
diseases differs in certain morphologic and biologic char-
acters, the most convincing of which is the lack of im-
munity induced by one parasite against infection by
another.

Sleeping sickness is transmitted through the bite of
the tsetse fly, *Glossina palpalis*. The bite of these in-
sects is associated with local pain, and, besides this, there
is severe abdominal pain, accompanied with diarrhea,
vomiting, fever, and delirium.

Sleeping sickness is as yet confined to certain areas in
central Africa, but it is extending to wider and wider
areas, and it is also attacking Europeans as well as the
natives, so that recently this disease has created much
interest and concern.

Sleeping sickness is stated to have been the cause of
600,000 deaths in central Africa during the past ten
years, and hence it is a disease of great importance from
a public health standpoint, especially because it tends to
extend to new territory as the means of communication
become favorable.

Whether the parasite of sleeping sickness, *Trypano-
soma gambiense*, undergoes some form of development in
the body of the fly, or whether it is transmitted directly
by means of the infected proboscis, cannot be stated
definitely, but the general opinion is that it is transmitted
directly without undergoing any transformation in the
body of the fly.

The species *Glossina palpalis*, which is the transmit-
ting agent for *Trypanosoma gambiense*, is believed to
differ somewhat from the variety *Glossina morsitans*,
which transmits the parasite of a trypanosomatic infection
of horses, due to *Trypanosoma brucei*, although morpho-
logically the two parasites resemble each other. There

is, however, an important difference between the two parasites in that *Trypanosoma brucei* is easily affected by human blood-serum, while *Trypanosoma gambiense* is not. Several other forms of trypanosomatic infection occur in horses, cattle, sheep, dogs, and birds, which are believed to be transmitted by means of blood-sucking insects. The trypanosomatic infection seen in rats, due to infection by *Trypanosoma lewisi*, is believed to be carried from diseased to healthy rats by fleas. McNeal has also found that *Trypanosoma lewisi* is transmitted from diseased to healthy rats by infected lice. Lice that had been allowed to suck the blood of infected rats had the parasites in their stomachs for some time. He found no evidence that the parasites underwent transformation in the lice.

The parasite of nagana, *Trypanosoma brucei*, is transmitted through the bite of the tsetse-fly (*Glossina morsitans*); the parasite of dourin, *Trypanosoma rosetti*, is transmitted during coition; while nothing definite is known regarding the mode of transmission of *Trypanosoma evansi*, the parasite of surra; *Trypanosoma elmasiani*, the parasite of mal de Caderas; nor of *Trypanosoma theileri*, the parasite occurring in cattle in Pretoria.

Trypanosomiasis is a common disease of gray rats, and it is believed that the disease is transmitted through the bite of fleas. Whether the disease in human beings is transmitted through the bite of flies, fleas, or other insects cannot be stated definitely; but it is known that sleeping sickness is due to a trypanosome, and that this parasite is transmitted by a biting fly which is indigenous to the locality in which the disease occurs. The fly believed to be concerned in the transmission of sleeping sickness is *Glossina palpalis*.

Piroplasmoses.—Diseases in which the red blood-corpuscles are invaded by an animal parasite which differs materially from the parasites of malaria have been discovered in cattle, sheep, dogs, horses, and in man. Because of the peculiar appearance of the parasite of piroplas-

moses, the distinctive name has been coined for it. In all of these diseases a certain type of tick has been discovered to be the transmitting agent.

Texas Cattle Fever.—Though not infectious to a marked degree, this disease has an important relation to the subject under discussion. The mode of transmission of Texas cattle fever is of a type entirely different from that seen in any of the diseases discussed. The transmitting agent in this disease is the cattle tick, *Boophilus bovis*, as discovered by Theobald Smith in 1891. This insect is believed to be incapable of transmitting the disease directly. The fecundated female tick sucks the blood of infected cattle and then falls to the ground to deposit its eggs. The eggs hatch after twenty to forty-five days, and the young ticks attach themselves to the cattle and carry the infection.

It will be seen that in the transmission of this disease two generations of ticks are requisite to complete the cycle of development of the parasite and permit the dissemination of the disease from infected to healthy cattle.

Although piroplasmoses of cattle are not frequently transmitted to human beings, Lingard has found the *Piroplasma bigeminus* in a herdsman who was suffering from malaria. He regards it as probable that the tick is capable of transmitting the parasite of cattle fever to individuals that are otherwise debilitated.

Other species of ticks are also believed to be instrumental in the transmission of disease among sheep, dogs, and other animals. None of these diseases is, however, infective to man, so far as known.

Spotted Fever of the Rocky Mountains.—This disease is localized along the foothills of the Rocky Mountains in Montana and Idaho. It is believed to be due to a parasite localized in the red blood-corpuscles of human beings, and which is transmitted by means of a tick, *Dermacentor occidentalis*, infesting the gopher. While certain details of the nature of this disease and the mode of its transmis-

sion are still unsettled, it is of importance in this particular, because the evidence seems to indicate a close similarity in the form of the parasite and in the mode of its transmission to that seen in piroplasmoses of the domestic animals.

Other Diseases in which the Occurrence of Animal Parasites has been Reported.—The most important disease of man which has recently been regarded as due to animal parasites is *small-pox*. The recent work of Councilman and his associates seems to present strong evidence in favor of the parasitic theory of the causation of small-pox. Councilman believes he has demonstrated two life-cycles of the parasite, sexual and asexual, the former occurring only in human beings and in monkeys, while the latter occurs in man, as well as in the lower animals (*vaccinia*). These facts, if correct, indicate that man is the definitive host of the small-pox parasite, and that cattle serve merely as an intermediate host.

Graham¹ presents facts which indicate that the etiologic factor of *dengue* is also an animal parasite. Graham believes that the parasite of dengue is transmitted by a species of mosquito—*Culex fatigans*. He states that mosquitoes that had bitten a sick person were carried into a locality where there was no case of dengue; two persons bitten by them contracted the disease after the normal incubation period of four to five days respectively; no new cases occurred subsequently in the village. The rôle of the mosquito in the propagation of dengue appears to accord with these facts.

Naturally Graham has sought hematozoa in the blood of the sick. He discovered an endoglobular hematozoön with ameboid movements which he found constantly in blood taken from individuals attacked by a typical form, and where the temperature was above 38° C. (100° F.). Graham's description of the parasite is made solely after examinations in the fresh state; he did not succeed with stained preparations.

¹ *Jour. of Tropical Medicine*, 1903, vol. vi.

Graham endeavored to follow the evolution of his *Piroplasma* in the blood of mosquitoes ; he found that it produced spores, and very soon the walls of the stomach and the salivary glands contained spores. Mrs. Graham was attacked with dengue the third day after having been bitten accidentally by one of these mosquitoes.

A person inoculated with an emulsion of salivary glands from the same mosquitoes had, three days later, a particularly intense attack of dengue.

Gotschlich¹ reports the observation of forms occurring in the red blood-corpuscles in cases of *typhus fever* which he regards as animal parasites, and is inclined to believe are the etiologic factors in the disease, though he expresses himself with some reserve.

His studies show that the parasite has some of the morphologic characteristics of *Pyrosoma bigeminum* of Texas fever in cattle. The following facts have been demonstrated :

First, the forms which he has seen are micro-organisms and not degeneration-products of the blood-elements.

Second, their confusion with malarial organisms is absolutely excluded, as the description of the forms will show. The parasite occurs within the red blood-corpuscles (endoglobular form) as well as free in the blood (two forms: encysted and flagellate body). For the staining of the endoglobular forms the most satisfactory results were obtained with diluted borax methylene-blue solution ; for the demonstration of the extraglobular form staining with undiluted Ziehl's carbol-fuchsin solution for a few seconds, followed by careful washing in water.

An investigation into the cause of the so-called "*spotted fever*" of the Rocky Mountains by Drs. Wilson and Chowning² demonstrated the presence of an animal parasite in the blood of the patients.

Bacteriologic examination of the blood and tissues of persons dying of the disease revealed only well-

¹ *Deutsches med. Wochenschr.*, Jahrg. 29, p. 329.

² *Jour. Amer. Med. Assoc.*, July 19, 1902.

known species of bacteria normally present in the body. On the other hand, the blood was found to contain large numbers of a parasite somewhat resembling that found in Texas fever of cattle, although it is larger than that organism and possesses ameboid motion. The organism varies greatly in form, size, and staining reaction at various stages of its development. The smallest forms are from 1 to 2 μ in size, ovoidal in form, and possess no ameboid movement. Another phase of the parasite is usually ovoidal in form, from 3 to 5 μ in size, and possesses ameboid movement. In freshly drawn blood bodies are sometimes found that resemble diplococci which are 0.5 to 1 μ in size and are without movement. These forms are extracellular, and stain faintly with methylene-blue.

The organism of "spotted fever" is a *hematozoön*, and is found in the red blood-cells in the circulating blood, but more plentifully in the blood-cells lying in the congested capillaries of the tissues. The fact that no pigment was found in the organism leads the discoverers to conclude that the parasite belongs in the class with the Texas fever organism and not with the malarial group.

Wilson and Chowning believe that the parasite is conveyed to man by the bite of ticks, several species of which are found in the infected locality. Though no infected ticks have yet been encountered, there is strong presumptive evidence that they serve as the carriers of the parasite, from the fact that the disease prevails at the season of the year when the ticks are prevalent—that is, from March to July.

Inoculation experiments upon rabbits with the blood of a fatal case were successful, the parasites persisting in the blood of the rabbit for four weeks.

The discovery of a hematozoön in the blood of cases of "spotted fever" has been confirmed by Dr. John F. Anderson.¹

¹ *Bulletin No. 14*, Hygienic Laboratory, Public Health and Marine-Hospital Service of the United States, July, 1903.

Helminthiasis.—Infection by different kinds of worms is of less hygienic interest, since most of them occur in more or less isolated localities, or are less generally distributed than some of the *sporozoa*.

The larvæ of the trematodes live in water and gain access to food. They are also disseminated by green vegetables grown on soil that has been fertilized with night-soil. Of the nematodes, the larvæ of *Uncinaria* and *Anguillula* are disseminated in a similar manner. The larvæ of *Filaria medinensis* live in *Cyclops quadricornis*, which is so common in fresh water. It has been determined by Manson that the developmental cycle of *Filaria medinensis* in the body of *Cyclops* requires from five to nine weeks, and the cycle in the human being is completed by the next year, when the young cyclops is again at hand to serve as the intermediate host of the parasite.

The mosquito, probably both *Culex* and *Anopheles*, serves as the intermediate host of *Filaria nocturna*. The embryos of the parasite, after reaching the stomach of the mosquito, penetrate into the musculature of the thorax, and thence, after undergoing further development, they pass into the root of the proboscis. When they reach this point, they are injected into the tissues of the person in the act of sucking blood.

| PARASITE. | Found as Human Parasite in | | Type of Parasitism. | Recorded frequency as human parasite. |
|--|----------------------------|----------------|---------------------|---------------------------------------|
| | Stage of Parasite. | Organ of Host. | | |
| TREMATODA (flukes)— | | | | |
| <i>Gastrodiscus hominis</i> | Adult | Colon | Occasional | Twice |
| <i>Fasciola hepatica</i> | " | Liver | " | Rare |
| <i>Fasciola angusta</i> | " | (?) | (?) | Once |
| <i>Fasciolopsis buski</i> | " | Intestine | Normal | Rare |
| <i>Fasciolopsis rathouisi</i> | " | " | Occasional | Once |
| <i>Paragonimus westermanii</i> | " | Lung | Normal | Abundant |
| <i>Opisthorchis felineus</i> | " | Liver | " | Frequent |
| <i>Opisthorchis sinensis</i> | " | " | " | " |
| <i>Opisthorchis noverca</i> | " | " | Occasional(?) | Once |
| <i>Metorchis truncatus</i> | " | " | Occasional | " (?) |
| <i>Heterophyes heterophyes</i> | " | Intestine | Normal | Frequent |
| <i>Dicrocoelium lanceatum</i> | " | Liver | Occasional | Rare |
| <i>Schistosoma hæmatobium</i> | " | Portal vein | Normal | Frequent |

? Record open to question.

| PARASITE. | Found as Human Parasite in | | Type of Parasitism. | Recorded frequency as human parasite. |
|--|----------------------------|-------------------|---------------------|---------------------------------------|
| | Stage of Parasite. | Organ of Host. | | |
| CESTODA (tape-worms)— | | | | |
| <i>Dibothriocephalus latus</i> | Adult | Intestine | Normal | Abundant |
| <i>Dibothriocephalus cordatus</i> | " | " | Occasional | Rare |
| <i>Diplogonoporus grandis</i> | " | " | " | " |
| <i>Bothriocephalus mansoni</i> | Larva | Connective tissue | " | " |
| <i>Dipylidium caninum</i> | Adult | Intestine | " | " |
| <i>Hymenolepis nana</i> | " | " | Normal(?) | Frequent |
| <i>Hymenolepis diminuta</i> | " | " | Occasional | Rare |
| <i>Hymenolepis lanceolata</i> | " | " | " | Once |
| <i>Davainea madagascariensis</i> | " | " | " | Rare |
| <i>Davainea (?) asiatica</i> | " | " | (?) | Once |
| <i>Tænia solium</i> | " | " | Normal | Abundant |
| <i>Cysticercus cellulose</i> | Larva | Connective tissue | Occasional | Rare |
| <i>Tænia saginata</i> | Adult | Intestine | Normal | Abundant |
| <i>Tænia marginata</i> | Larva | Connective tissue | (?) | Once(?) |
| <i>Tænia serrata</i> | Adult | Intestine | Occasional | Twice(?) |
| <i>Tænia africana</i> | " | " | Normal(?) | Once |
| <i>Tænia confusa</i> | " | " | (?) | Twice |
| <i>Tænia echinococcus (Echinococcus polymorphus)</i> | Larva | Connective tissue | Normal | Frequent |
| <i>Tænia hominis</i> | Adult | Intestine | " (?) | Once |
| NEMATODA (round-worms)— | | | | |
| <i>Leptodera pello</i> | Adult | Vagina | Accidental | Once |
| <i>Leptodera niellyi</i> | Larva | Skin | Accidental(?) | " |
| <i>Anguillula aceti</i> | Adult | Bladder | Accidental | Rare |
| <i>Strongyloides stercoralis</i> | " | Intestine | Normal | Abundant |
| <i>Gnathostoma siamense</i> | " | Skin | Occasional | Once |
| <i>Filaria medinensis</i> | " | " | Normal | Abundant |
| <i>Filaria loa</i> | " | Eye | " | Frequent |
| <i>Filaria volvulus</i> | " | Lymph-vessels | (?) | Rare |
| <i>Filaria conjunctivæ</i> | " | Conjunctiva | Occasional | " |
| <i>Filaria lentis</i> | Young | Eye | (?) | Uncertain |
| <i>Filaria restiformis</i> | Adult | Bladder(?) | (?) | Once |
| <i>Filaria hominis oris</i> | (?) | (?) | (?) | " |
| <i>Filaria labialis</i> | (?) | Lip | (?) | " |
| <i>Filaria lymphatica</i> | Adult | Lymph-vessels | Occasional(?) | Twice |
| <i>Filaria immitis</i> | (?) | (?) | (?) | Uncertain |
| <i>Filaria bancrofti</i> | Adult | Lymph-vessels | Normal | Abundant |
| | Larva | Blood | " | Frequent |
| <i>Filaria magalhaesi</i> | Adult | Heart | Normal(?) | Rare |
| | Larva | Blood | " | " |
| <i>Filaria perstans</i> | Adult | Connective tissue | " (?) | Once |
| | Larva | Blood | " | " |
| <i>Filaria diurna</i> | " | " | Normal | Frequent |
| <i>Filaria demarquayi</i> | " | " | Normal(?) | Rare |
| <i>Filaria romanorum orientalis</i> | " | " | (?) | Once |
| <i>Filaria ozzardi</i> | Adult(?) | Connective tissue | " | " |
| | Larva | Blood | Normal(?) | Rare |
| <i>Filaria kilimare</i> | Adult | Body cavity | (?) | Once |
| <i>Trichuris trichiura</i> | " | Colon | Normal | Abundant |
| <i>Trichinella spiralis</i> | " | Intestine | " | " |
| | Larva | Muscle, | " | " |
| <i>Strongylus apri</i> | Adult | Lung | Occasional | Rare |
| <i>Strongylus subtilis</i> | " | Stomach | Normal(?) | Twice |
| <i>Diocophyme renale</i> | " | Kidney | Occasional | Rare |
| | " | Intestine | Normal | Abundant |
| <i>Uncinaria duodenalis</i> | Larva | Connective tissue | " | " |
| | Adult | Intestine | " | " |
| <i>Physaloptera caucasica</i> | " | " | (?) | Once |
| <i>Ascaris lumbricoides</i> | " | " | Normal | Abundant |
| <i>Ascaris canis</i> | " | " | Occasional | Rare |
| <i>Ascaris maritima</i> | " (?) | (?) | (?) | Once |
| <i>Oxyuris vermicularis</i> | " | Intestine | Normal | Abundant |
| <i>Gigantorhynchus gigas</i> | " | " | Occasional | Rare |
| <i>Gigantorhynchus moniliformis</i> | " | " | " | " |
| <i>Echinorhynchus hominis</i> | " | " | (?) | Once |

? Record open to question.

The table on pages 410 and 411, taken from the paper of Dr. Henry B. Ward,¹ lists all the human parasites of the various groups of worms heretofore recorded, and is based largely on the classification given by Braun.

The occurrence and distribution of the different forms of intestinal parasites in the United States are far more general than has heretofore been believed. The marked prevalence of different forms of intestinal parasites in those exposed to infection in the tropics is shown by the following report :

In Bulletin No. 13 of the Hygienic Laboratory of the Public Health and Marine-Hospital Service there was reported a statistical study of the intestinal parasites of 500 white male patients at the United States Government's Hospital for the Insane. A summary of the results obtained in this study shows :

1. That 13.2 per cent. of the patients examined were infected with intestinal parasites. The parasites found were hook-worms (*Uncinaria Americana* or *Anchylostoma duodenale*), whip-worms (*Trichuris trichiura*), seat-worms (*Oxyuris vermicularis*), Cochin-China worms (*Strongyloides stercoralis*), eel-worms (*Ascaris lumbricoides*). No evidence of infection with tape-worms, flukes, or coccidia was found.

2. The results obtained differ from those of most foreign investigators principally in the lower rate of infection, in the absence of tape-worms, and in the presence of hook-worms and of the Cochin-China worms.

3. The results show that the percentage of infection tends to vary inversely with the age and with the duration of institutional life of the patients.

4. They also indicate that army life is conducive to parasitic infection of the intestine, and, moreover, that a high percentage of the United States soldiers returning from service in the Philippine Islands have intestinal parasites.

5. The presence of a moderate number of worms in

¹ *Jour. Amer. Med. Assoc.*, September 19, 1903.

the intestine has no relation to the presence of undigested starch and meat in the dejecta or to the litmus reaction of the feces.

Frequency of Infection.—Of the 500 patients examined, 66 patients, or 13.2 per cent., showed parasitic infection of the intestines; 10 patients had a double infection, and in one case three different parasites were present, making a total of 78 infections. These were distributed among five parasites as follows:

Uncinaria Americana, or *Anchylostoma duodenale* (hook-worms), 15 cases, or 3 per cent. of the cases examined.

Trichuris trichiura (whip-worms), 54 cases, or 10.8 per cent.

Oxyuris vermicularis (seat-worms), 4 cases, or 0.8 per cent.

Strongyloides stercoralis (Cochin-China worms), 3 cases, or 0.6 per cent.

Ascaris lumbricoides (eel-worms), 2 cases, or 0.4 per cent.

The Hook-worm Disease (Uncinariasis).—Stiles¹ states that—“This is a newly recognized factor in anemias in America. In traveling from Virginia to Florida, as we go south anemia increases. The cases may be divided into two general classes, one due to malarial infection and the other to the *Uncinaria Americana*. The former is especially prevalent where the soils are impervious, and the latter occurs in the sandy areas. At Waycross, in southeastern Georgia, there are about twenty cases of hook-worm disease to one case of malaria.

“The hook-worm disease of Europe is due to the *Uncinaria duodenalis*, while the American disease is caused by another species of the same parasite, known as the *Uncinaria Americana*. The parasites live in the small intestine and suck the blood. One factor in the production of the disease is the loss of blood taken by the parasite. In addition, minute hemorrhages occur

¹ *Brooklyn Medical Journal*, 1903, vol. xvii., p. 51.

from the wounds made by the worms. These wounds may ulcerate. The intestinal walls are thickened, and their digestive surface is decreased. The parasites apparently produce a poisonous substance. All these factors are involved in the symptoms of the disorder."

Trichinosis.—The *Trichinella spiralis* is ingested through the use of raw meat, more particularly raw pork, though among the flesh-yielding domestic animals, calves and sheep may also be infected. Rats, cats, and hogs serve as intermediate hosts of the parasite.

The thorough cooking of all meat will be a positive safeguard against infection from this parasite, as it is destroyed when heated above 65° C. for several minutes. Complete drying also destroys the parasite, and pickling the meat serves to kill the parasite in a few months.

Prevention of Infection with Animal Parasites.—

In a paper presented to the International Congress of Hygiene (1891, vol. 1), Dr. Prospero Sonsino gives succinct directions for preventing this form of infection:

"1. Pure spring-water, or else boiled or filtered water, alone are to be drunk. Drinking-water is to be preserved in good and well-covered vessels. River- or lake-water not to be imbibed while bathing. This rule regards prevention especially from *Bilharzia hæmatobia*, *Filaria sanguinis hominis*, *Ranunculus medinensis*, *Rhabdonema intestinale*, and probably from *Filaria loa* and many others. The relatively large dimensions of the eggs and larval stage of entozoa hinder their passage with drinking-water through a good filter; therefore proper filtration of drinking-water suffices.

"2. Meat, fresh-water fish, and vegetables are to be well cooked and kept from insects (flies). For children and invalids, raw meat can be used, provided that it is well pounded and passed through a suitable sieve. This rule regards prevention especially from *Trichina spiralis*; *Tænia solium*, *T. saginata* (*mediocanellata*), *Bothriocephalus latus*, *Ascaris lumbricoides*, *A. mystax*, *Dis-*

toma lanceolatum, Fasciola hepatica, and others. The modern use of raw beef for children and invalids has been the cause of an extraordinary spread of *Tænia saginata*.

“Depraved tastes for substances not possessed of alimentary qualities (*pica* and *geophagia*) are not to be yielded to. This rule regards the prevention from *Tænia nana*, *leptocephalia*, *canina*, and probably from *Distoma heterophyes*, *Echinorhynchus hominis*, *Ascaris lumbricoides*, *A. mystax*. Many of these entozoa have, or are suspected to have, insects as intermediary hosts, which may be conveyed to the stomach of man through the habit of those affected with *pica* and *geophagia* of eating dirty things.

“4. Special forms of food in use by the natives of countries possessing special entozoa are to be avoided, or only taken after thorough cooking. This rule is calculated to prevent *Bothriocephalus cordatus*, *B. Mansoni*, *Distoma crassum*, *D. heterophyes*, *D. sinense*, and *D. Ringeri*.

“5. Hands and nails are to be kept thoroughly clean, particularly when about to eat. Domestic animals are to be handled with caution—dogs especially. Caution in handling entozoa; their speedy and complete destruction by fire whenever it is not necessary to preserve them for medical purposes. This rule is of great importance, especially for preserving man from *Anchylostoma duodenale*, *echinococcus*, *Pentastoma denticulatum*, *Tænia canina*, *T. solium*, and *Oxyuris vermicularis*.

“6. The body is to be kept free from epizoa (mosquitoes, bugs, fleas, etc.). This rule is of great importance in guarding against some of the above-mentioned worms, so as to interfere with the life-cycle of those parasites, as well as with that of several of the *filiaræ*.”

It is safe to assume that protection against epizoa will be of value in preventing infection from a number of other diseases the specific causes of which are as yet undetermined. Our knowledge with regard to the dis-

semination of disease by means of insects has been carefully summarized by Nuttall.¹

Vegetable Parasites.—The vegetable parasites are less formidable in their action than the animal parasites. The diseases due to the vegetable parasites are usually slow in development and less destructive in their action.

The *Trichophyton fungus* is a common parasite among the poorer classes. The diseases produced by it are known as tinea circinata, tonsurans, and sycosis, according to the location of the disease. Cleanliness and simple antiseptic treatment serve to eradicate the disease.

The *Microsporon furfur* produces the disease known as tinea versicolor, and is but slightly contagious. The *Achorion Schönleini* produces the disease known as tinea favosa, which is distinctly contagious in character and difficult to eradicate. The *Microsporon minutissimum* produces the disease known as erythrasma, which is similar in many respects to tinea versicolor.

Actinomyces is a disease due to an organism which is regarded as being higher in the scale of the vegetable kingdom than the bacteria, and may be briefly considered here. A considerable group of organisms has been discovered which have some of the characters of the ray fungus, among which are the *Bacillus tuberculosis* and the related "acid-fast" organisms found in butter, hay, and grass. This whole group of organisms, including the *Bacillus tuberculosis*, is now classed together under the name actinomycetes.

The *Actinomyces bovis*, or ray fungus, affects man as well as animals. It is believed to gain entrance to the body through carious teeth. It produces deep subcutaneous swellings or tumors, which finally break down and suppurate, discharging a thin, bloody sero-pus containing characteristic yellow granules.

The disease often yields to the administration of large doses of potassium iodid.

Actinomyces maduræ is a vegetable parasite which is

¹ *Hygienische Rundschau*, Jahrg. 9., 1899.

the cause of an endemic disease known as Madura foot, and which is characterized by disintegration of the tissues, chiefly of the foot and hand. The disease occurs most frequently in India, though Wright encountered a case in Boston. The disease pursues a chronic course, and the only successful treatment is by means of the knife or curet.

Oidiomycosis.—Ricketts¹ has collected a number of cases of disease of the skin which were traced to organisms belonging to the genus *Oidium*. The variations among the organisms represented three morphologic types : (1) Blastomycetoid or yeast-like ; (2) oïdium-like ; (3) hyphomycetoid.

The *Oidium albicans* is the organism which produces thrush, a disease of the mucous membranes in enfeebled infants.

The *Oidium lactis* is found in sour milk, on bread and decayed fruit, and, so far as known, is non-pathogenic. It is frequently encountered in the mouth.

Cancer.—For several years past the etiology of cancer has been under investigation, following the description of peculiar bodies in the cancerous tissue by Russell, Ruffer and Walker, and Plimmer. The bodies which have been described are most frequently classed as blastomycetes. The exact relation of these bodies to cancer as well as the etiology of cancer are as yet not definitely determined.

¹ *Jour. of Med. Research*, 1901, vol. vi.

CHAPTER XVIII.

DISINFECTION.

ASIDE from the prophylactic measures already spoken of, there are other measures in common use to limit the spreading of the infectious diseases. These measures are employed to destroy the specific bacteria and other infective agents outside the body. These measures are commonly included under the broad term disinfection. To disinfect is to render non-infective, and a disinfectant is, therefore, any agent that is capable of destroying infective materials or of rendering them inert. Chemical substances which in certain definite proportions kill bacteria in fluids, and when present in smaller amounts prevent their multiplication, are disinfectants. When present in the larger amounts they act as germicides—that is, they kill the bacteria; while in the smaller amounts they are simply disinfectants, because they render the bacteria incapable of multiplication. The term disinfectant is also sometimes applied to substances which destroy bad odors. This is, however, an improper use of the term disinfectant. These substances which destroy bad odors are deodorants, and may or may not be disinfectants. Substances which retard or prevent the growth of bacteria are usually spoken of as antiseptics, because they prevent the growth of the septic bacteria as well as others. These antiseptic substances, in larger amounts, generally are germicides.

A reliable disinfecting agent is, therefore, one that is germicidal in its action. A good disinfectant should, however, be as free as possible from poisonous action upon those who use it, and, at the same time, it should not be destructive to the articles to be disinfected.

The latter quality is a most important one from the fact that a number of very useful disinfecting agents have an injurious or even destructive action upon the articles to be disinfected. For this reason dry heat is not applicable to the disinfection of fabrics, because the degree of heat required to disinfect thoroughly would be sufficient to char them. Articles of clothing containing blood or other stains should not be disinfected by means of hot water or steam, because these agents fix the stains so that they remain permanent. Many of the other disinfecting agents have a corrosive action upon metals, and are, therefore, not adapted for the disinfection of metallic articles. Consequently it is necessary to select that disinfecting agent which is least likely to prove objectionable. Fortunately we have a rather wide range of substances and agencies to select from according to the nature of the articles to be disinfected.

The disinfecting agent should be cheap, in order to lessen the expense as much as possible. Here again it is possible to select, for certain purposes, agents that are comparatively cheap and yet quite efficient. Under other circumstances it is not possible to avail ourselves of the cheapest agents, because they are not suitable for other reasons. For instance, milk of lime is a most excellent disinfectant for rough work, but it would not be applicable under all conditions.

All our present knowledge of the value and efficiency of the different disinfecting agents is based upon laboratory experiments, and it is only since the evolution of modern bacteriology and the perfection of bacteriologic methods that it was possible to give intelligent direction to our efforts toward the limitation and eradication of disease by such means.

Disinfectants in Common Use.—The disinfectants in common use are of two classes, heat and chemical substances. Heat may be employed as a disinfectant in several different ways—as dry heat, 150° to 175° C., for one to two hours; or as moist heat, as steam or boiling

water. The principal chemical disinfectants are formaldehyd gas and solution, mercuric chlorid solution, carbolic acid solution, trikresol, chlorid of lime and caustic lime, sulphur dioxid, zinc chlorid, and copper sulphate. Fire is also a most efficient disinfectant, but is applicable only for substances that are not combustible, or for combustible substances that are of little or no value. Sunlight is also an efficient disinfectant. This agent is constantly acting and, no doubt, removes most of the detrimental agents on surfaces exposed to the sun. Most bacteria grow best in the dark. Many species fail to grow at all in diffuse daylight, while direct sunlight is injurious to all species.

The Action of Sunlight Upon Bacteria, With Special Reference to Bacillus Tuberculosis.—J. Weinzirl¹ made a study of the various methods which have been used in determining the effect of sunlight upon bacteria. Objections are found to most of these methods in that they do not constitute true exposures, the bacteria being covered with glass or other material which absorbs and reflects some of the sun's rays. When bacteria were directly exposed to the rays of the sun without any covering over them, the author found that the germicidal action of sunlight was much more effective than it had previously been considered.

The organisms upon which observations were made were the bacilli of tuberculosis, typhoid fever, cholera, diphtheria, etc., but particular attention was given to the tubercle bacillus. It was found that this organism, as well as other pathogenic nonspore-bearing bacteria, is destroyed in from two to ten minutes by direct exposure to sunlight. According to the author, the hygienic importance of sunlight has been considerably underestimated and nonspore-bearing bacteria, when freely exposed, are killed in from one-fifth to one-twentieth of the time previously considered necessary.

Disinfection on Large Scale.—Disinfection on a

¹ *Jour. Infect. Diseases*, May, 1907, Sup. 3, pp. 128-153, pls. 2.

large scale, for infected clothing and bedding, is usually accomplished by means of steam under pressure. A special form of apparatus is required for this purpose (see Fig. 60). A special building should be constructed for a municipal disinfecting plant. The disinfecting chamber should be so arranged that the infected clothing is brought into one room, where it is introduced into the disinfecting chamber. After it has been disinfected, it is

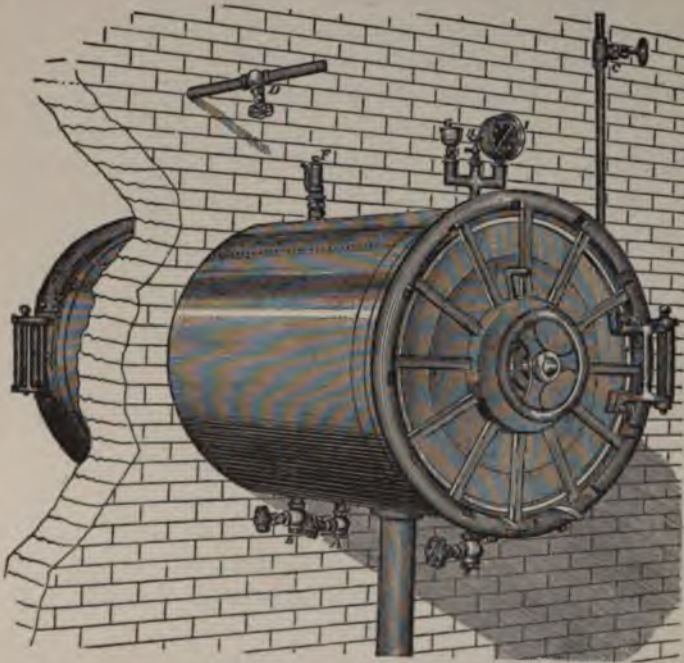

FIG. 60.—Steam disinfecting plant.

taken out of the chamber from the other side of a partition wall and stored in a room that has no connection with the first room except through the disinfecting chamber. The doors of the disinfecting chamber should be so arranged that only one can be opened at a time, so as to prevent infectious materials from being carried over into the room containing the disinfected clothing. The attendants handling the infected clothing should not

come in contact with those who handle the disinfected clothing. The disinfected clothing should never be returned in the same conveyance used for the collection of infected clothing.

The disinfecting power of steam is dependent upon the extent of the pressure to which it is subjected, the greater the pressure the higher its disinfecting power, because the temperature of the steam increases with the increased pressure. The steam given off from boiling water in an open vessel has the same temperature as that of the water— 100°C . At one additional atmosphere pressure we obtain a temperature of 121.5°C .; at two atmospheres, 135°C .; at three atmospheres, 145°C .; at four atmospheres, 153.3°C .; and at five atmospheres, 160°C . A pressure of one atmosphere is equal to 1 kilogram per square centimeter of surface. Spores are not destroyed when heated to the temperature of boiling water, but at a pressure of two to three additional atmospheres disinfection by steam kills spores almost immediately. All pathogenic bacteria in the vegetative stage are killed when heated to from 65° to 75°C ., so that the temperature of boiling water is sufficient to kill a large number of the different species of pathogenic bacteria—the non-spore-bearing forms. When infected clothing and bedding are to be disinfected by means of steam, it is necessary to use steam under pressure to cause the heat to penetrate into the interior of the bundles to be disinfected.

Formaldehyd.—Of the different chemical disinfectants, formaldehyd is now considered the most efficient, and is in general use for the purpose of room disinfection. The disinfectant action of formaldehyd was discovered in 1886 by O. Loew. The formaldehyd gas, as generally employed for purposes of disinfection, has no great penetrating powers, and it cannot, therefore, be relied upon for the disinfection of bundles of clothing and bedding. For the disinfection of such articles the gas must be applied under pressure by means of a vacuum chamber. This

disinfectant is most commonly used for the disinfection of rooms in which there have been cases of infectious diseases. It is entirely harmless for all classes of household goods. Upon the removal of the patient the room is closed as tightly as possible, and all cracks are closed by means of gummed paper; all the bedding and clothing are spread out, the drawers, doors of cupboards, and closets are opened, and the gas is introduced through the keyhole of the door. The gas is generated in a special apparatus outside the room, either from an aqueous solution of the gas by the application of heat, by the oxidation of wood alcohol, or by the volatilization of paraform by means of heat.

Generation of Formaldehyd Gas.—An excellent form of formaldehyd gas regenerator is that manufactured by Lentz & Sons, of Philadelphia (Fig. 61), which consists of a stout copper retort of about $2\frac{1}{2}$ liters (4 pints) capacity, with fannel filling tube and level indicator, a stopper of special construction, and inclined brass outlet tube of large bore, connected by means of a flexible tube with another and smaller brass tube, which is inserted through the keyhole of the room to be disinfected.

The solution in the retort is heated by means of a special form of "Primus" lamp, D, which burns kerosene and develops a temperature of 1150° C. (2100° F.). The solution is introduced into the bottom of the retort through the small funnel at the top, and the stopcock A on the connection is allowed to remain open, so that exhaustion of the solution is at once detected by the escape of gas. The cap of the retort is held in position by means of a strong iron yoke, provided with a clamping screw, B. When the supply of solution in the retort is exhausted the flame is at once extinguished by turning the thumb-screw F to the left. If it is desired to continue the disinfection, a filled retort can be substituted for the exhausted one by turning the screw C, which holds the retort in place. The heat of the flame is perfectly under the control of the operator. It can be in-

creased by means of the pump G, or decreased by means of the valve.

The efficiency of this apparatus is attested by the fact that the United States War Department has over one hundred of them in use, besides large numbers in use by boards of health in many of the larger cities, by hospitals, schools, and physicians.

Fig. 62 represents the Trenner-Lee formaldehyd re-



FIG. 61.—Formaldehyd gas regenerator.

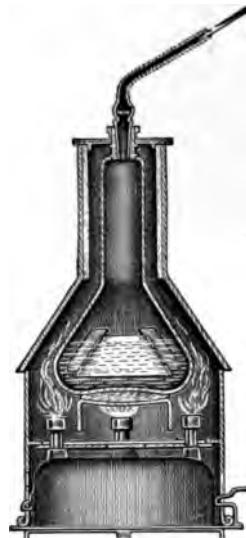

FIG. 62.—Formaldehyd gas regenerator.

generator, for which certain important advantages are claimed. It is so constructed as to permit its use either within the room to be disinfected or outside the room. The introduction of copper plates in the interior of the retort serves to prevent the frothing of the boiling fluid, and hence prevents the projection of fluid from the apparatus.

The use of a large alcohol burner makes it possible to generate the gas very quickly, rapidly, and uniformly, and the amount of alcohol in the burner can be so regulated as to become exhausted and extinguish the flame when all the solution has been utilized. This is an important advantage when the apparatus is to be placed in the room to be disinfected.

The formaldehyd gas acts most efficiently when moist and at a high temperature. To meet these conditions the gas is either mixed with steam or it is generated from a mixture of formaldehyd solution and glycerin. The glycerin prevents the gas from polymerizing as readily as when in the dry state. The moisture may be supplied also by spraying all the surfaces of the room, as well as all articles contained in it, with a solution of formaldehyd before beginning the disinfection, or by suspending sheets, saturated with formaldehyd, in the room. It is entirely harmless in its action upon fabrics, and is not highly poisonous, though it has an irritant action upon the mucous membrane when respired.¹ The formic aldehyd solution contains about 40 per cent. of the gas, and is relatively cheap. It can be purchased everywhere in this form, and is also sold, at a much higher price, under the trade name of "formalin." From 500 to 600 cubic centimeters of the glycerin-formaldehyd mixture (1 : 50) are usually employed to disinfect a space of from 25 to 30 cubic meters. A liter of wood alcohol will yield 748 grams = 361 liters of aldehyd. This amount of gas in a room of 25 to 30 cubic meters would give 1.25 to 1.5 per cent. of aldehyd in the air of the room. Stüver concludes that a closed room must contain 2.5 grams of formaldehyd per cubic meter of space. 1.6 grams per cubic meter kills all organisms not in the spore stage. The room should remain closed for six hours after the gas has been generated.

¹ Disinfection by means of formaldehyd has been rendered quite safe, with regard to danger from fire, since the modern apparatuses permit the evolution of the gas outside the room to be disinfected, the gas being conducted into the room through the key-hole.

Liquid Formaldehyd - spraying.—The Board of Health of Philadelphia has for some years abandoned formaldehyd generators, and has relied solely upon the spraying of infected rooms with formaldehyd by means of a large spraying apparatus. There is no doubt that the disinfection of houses as practised to-day is not always efficacious. Disinfection by burning sulphur in a room is almost valueless for the bacterial infections, since it is impossible to generate sufficient sulphur dioxid in this manner to kill the pathogenic organisms. In like manner the generation of formaldehyd gas by the different methods in use is rarely efficacious, since in practical experiments, under the most favorable conditions that can be improvised, only about 80 per cent. of the test objects are destroyed. The use of formaldehyd in solution by means of a large spraying apparatus gives the most satisfactory results, as by this means it is possible to destroy 100 per cent. of test objects. With such an efficient method of disinfection in use we may hope to see a more prompt subsidence of outbreaks of the transmissible diseases than has ever been the case. Moreover, this method of disinfection is unattended with the dangers of fire that always attend the older methods. Three pints of equal parts of formaldehyd (40 per cent. solution) and water is sufficient to disinfect a room having 1000 cubic feet of space. This solution is sprayed over the bed-clothes, furniture, walls, floors, etc., and is allowed to act for twenty-four hours, after which the room may be thoroughly aired.

Sulphur Dioxid.—Sulphur dioxid was formerly employed to a large extent for the purposes for which formaldehyd is now employed. The gas is generated by burning ordinary sulphur in the room to be disinfected. All the crevices and cracks in the room should be closed as carefully as possible, so as to retain the gas in as large volume as possible within the room. It should form from 4 to 10 per cent. of the volume of the air of the room, and should be allowed to act from twelve to

twenty-four hours. To generate this amount of the gas, it is necessary to burn about $1\frac{1}{2}$ kilograms of sulphur for each 25-30 cubic meters of space. This gas also acts most efficiently in a moist state—in fact, it is of small penetrating power in the dry state. The moisture may be generated by spraying the articles in the room or by introducing steam during the time the gas is being generated.

The use of sulphur dioxid for purposes of disinfection is, at present, largely confined to the disinfection of ships.¹ The preference of sulphur dioxid over formaldehyd in the disinfection of ships is due to its efficiency in the destruction of rats and other vermin. In this respect sulphur dioxid is far more efficient than formaldehyd. In vessels infected with plague it is especially desirable to destroy all rats on board ship because of their evident capability of serving as carriers of the infection.

Hydrocyanic Acid.—Recently the use of hydrocyanic acid has been advocated for the disinfection of rooms. Aside from its value in the destruction of pathogenic bacteria, this gas possesses the additional value of being particularly efficacious in the destruction of vermin. Contrary to the generally accepted opinion, this gas is claimed to be far less dangerous to those employing it than was formerly supposed to be the case.

Corrosive Sublimate.—For a long time corrosive sublimate had been regarded as the most reliable and efficient disinfecting substance, on account of its high germicidal powers, but it is less highly esteemed at the present time, because it has been found to have certain very important limitations. It is a most highly poisonous substance, and is therefore not safe for general use. It is also objectionable from the fact that it is precipitated by means of albuminous substances, and consequently it should not be employed in the presence of such substances. The addition of acids prevents the destruction, to some extent, of the corrosive sublimate through combination with albu-

¹ See Sect. 162 of the Quarantine Laws of the United States, p. 486

minous substances. Tartaric or sulphuric acid is best adapted for this purpose. Because of its poisonous effects, it is customary to add one of the anilin dyes to give it a distinctive color and thus limit the danger of accidental poisoning. It is capable of fixing permanently any stains on clothing, and is, in consequence, not adapted for use with such materials. It kills all bacteria and their spores in a few minutes in 1 : 1000 solution, and in a few hours in 1 : 5000 solution. The mercury unites with the protoplasm of the organisms and forms albuminate of mercury, and thus kills them.

Carbolic Acid.—This is a very active germicide, and is therefore an efficient disinfectant. It is sparingly soluble in water, the extreme being about 5 per cent. in saturated solution. A solution of this strength kills bacteria in the vegetative stage in less than a minute. Like corrosive sublimate, carbolic acid is also rendered less effective by the presence of albuminous substances in the material to be disinfected. The addition of sulphuric acid increases its action, and for the roughest work a mixture of equal parts of crude carbolic acid and commercial sulphuric acid is most serviceable. This mixture is employed in 2 to 3 per cent. solution. Another mode of employment is in the form of carbol soap. This mixture is of great value in the disinfection of soiled clothing and bedding, inasmuch as it does not fix the stains, and yet disinfects them efficiently.

Trikresol.—The cresols are most efficient disinfectants, and are contained in considerable quantities in crude carbolic acid. Trikresol is a mixture of the three cresols, para-, meta-, and ortho-cresol, in the following proportions: Para-cresol, 25 per cent.; meta-cresol, 40 per cent.; ortho-cresol, 35 per cent. This mixture is soluble in water in the proportion of 2 to 5 per cent. It is poisonous, and its action is also increased by the addition of sulphuric acid.

Creolin.—This substance has a high disinfectant value. It is insoluble in water, but is employed as an emulsion

in water in the proportion of 2 to 5 per cent. It is used for rougher work, as around kennels, stables, and cellars.

Nitrate of Silver.—The use of this substance is limited by its cost, its poisonous qualities, and the facility with which it is precipitated by albuminous substances. It appears, however, to possess special value as a disinfectant of the throat in convalescent cases of diphtheria. The application of a 20 per cent. solution of nitrate of silver to the throat, as recommended by Dr. Hand, serves to render it free from diphtheria bacilli in about seven days, while the average length of time that they persist in throats treated by other methods is about twenty-eight days.

Preparations of Lime.—Chlorinated Lime.—This is one of the most serviceable disinfectants known at the present time on account of its cheapness and because it is not so highly poisonous as many of the other disinfectants in use. It should contain at least 25 per cent. of available chlorine as hypochlorite. In 0.5 to 1 per cent. watery solution it kills typhoid and cholera organisms in ten minutes. It is especially adapted for the disinfection of typhoid stools and for use in the disinfection of school-rooms and school furniture. The odor of chlorinated lime may be readily removed by exposing cloths saturated with a solution of washing soda in the room where lime has been used.

Milk of Lime, or whitewash, is also a serviceable disinfectant, and is usually employed in the disinfection of cesspools and privy-vaults. It is a most efficient deodorant, and in this respect it serves a double purpose when applied to walls of cellars, etc.

Washing Soda.—This is a serviceable disinfectant, and no doubt serves a good purpose when applied to floors in the ordinary cleansing operations. In 2 per cent. solution it is an efficient disinfectant for instruments when boiled in it for ten minutes.

Sulphate of Iron.—For rougher work, as privy-vaults, cesspools, etc., this substance is most frequently

employed. It is not a strong disinfectant, but it is serviceable as a deodorant. It should be used in the proportion of 1 kilogram (dissolved in 10 liters of water) to a cubic meter of the contents of the vault.

Physical Agents.—The principal physical agents employed for purposes of disinfection are dry and moist heat, fire, and sunlight.

Dry Heat.—This agent is not employed in ordinary disinfection. Its use is confined to the laboratory, where it is employed in the disinfection of glassware, etc.

Moist Heat.—The use of moist heat is almost universal, and has many advantages over chemical disinfectants. It is entirely safe and very efficient, besides being cheap, so that it has all the requisites. It may be employed in the form of boiling water or in the form of steam. Boiling water added in double quantity to typhoid or cholera stools disinfects them in an hour. It kills the diphtheria bacillus in five minutes, and the tubercle bacillus in ten minutes, and consequently it is most serviceable for the disinfection of napkins soiled with the discharges of diphtheria or tubercular patients.

Steam is now used largely in the disinfection of clothing and bedding, such as mattresses and pillows, which cannot be disinfected by means of hot water. A special apparatus is required for the larger pieces which boards of health are obliged to deal with.¹ In the sick-room an ordinary potato-steamer or the ordinary milk-sterilizing apparatus may be employed.

Fire, of course, is the best of all disinfectants, because it is positive in its action. It can, however, be employed only in the destruction of infected articles that are of little or no further use. It is frequently best to resort to

¹ In these large steam disinfecting apparatuses the air can be exhausted and the steam retained under pressure. With increase in pressure there is an increase in temperature, and consequently an increase in the effectiveness of the operation. At 760 mm. barometric pressure water is turned into steam at 100° C. (212° F.). At a pressure of one additional atmosphere we obtain a temperature of 121.5° C. (250° F.). At a pressure of two additional atmospheres we obtain a temperature of 135° C. (275° F.).

the use of this efficient disinfecting agent, even if the infected articles are of slight value, because we are then certain no danger can result therefrom.

Sunlight.—The direct action of the sun's rays kills non-spore-bearing organisms in half an hour. It has, however, but little penetrating power, and consequently it is of limited applicability. The combined influence of sunlight and drying as a purifying agent should not be altogether ignored, but should not be relied upon exclusively.

Disinfection of Infective Materials.—The chemical disinfectants are used principally by direct application to infected materials. Mercuric chlorid is used in solutions of 1 : 500 to 1 : 4000 strength. Carbolic acid is used in 2 to 5 per cent. solutions. Chlorid of lime is employed in 0.5 to 1 per cent. solution, prepared from a preparation having from 25 to 30 per cent. of available chlorin.

Disinfection of Excreta.—For the disinfection of excreta solutions of carbolic acid and chlorid of lime are usually employed. The excreta should be well mixed with equal quantities of the disinfectant solution, and allowed to stand for several hours before they are finally disposed of. Milk of lime, or caustic lime, may also be used for this purpose. Mercuric chlorid solution is not adapted for the disinfection of excreta, because the albuminous material present combines with the mercury to form insoluble albuminate of mercury, which is inert. Mercuric chlorid is not adapted for the disinfection of clothing and bedding, because it fixes any stains that may be present, and thus prevents their subsequent removal.

In order to obviate the destruction of the disinfectant properties of mercuric chlorid through the agency of albuminoid materials, acids may be added to the solution. In France the following mixture is employed :

| | |
|----------------------------|----------|
| Mercuric chlorid | 2 grams. |
| Tartaric acid | 24 " |
| Water | 1000 " |

A few drops of a 5 per cent. solution of carminate of indigo are added to give the solution a distinctive color.

In England the following mixture is employed :

| | |
|-----------------------------|------------|
| Mercuric chlorid | 1 ounce. |
| Hydrochloric acid | 10 ounces. |
| Water | 1 gallon. |

This solution is colored with anilin blue.

Disinfection of the Sick-room.—The disinfection of the sick-room during the time it is occupied by the patient is essential to prevent the spread of infectious diseases. The prophylactic measures necessary are dependent upon the nature of the disease, though, in a general way, they may be summarized under three divisions: First, those applicable to the exanthemata; second, those applicable to diseases of the respiratory apparatus; and third, those applicable to diseases of the gastrointestinal tract. The principal diseases falling within the first group are small-pox, measles, and scarlet fever; those of the second group are diphtheria, pneumonia, and tuberculosis; and those of the third group are cholera, dysentery, and typhoid fever.

In the Exanthemata.—In the first group of diseases the infectious material, whatever its nature, seems to be thrown off principally from the skin. It is most essential, therefore, to prevent the emanations from the skin gaining access to the air of the room. This is best accomplished by daily anointing the patient's body with some bland oil. The bed-clothing is to be removed with as little agitation as possible, and at once placed in a tub of water or a weak antiseptic solution before it is removed from the room. The floor, walls, furniture, and all horizontal surfaces in the room should be wiped daily with a damp cloth. The cloth may be dampened with a 2 per cent. solution of carbolic acid to increase the efficiency of the cleansing operation. There should be abundant ventilation of the room, and the most scrupu-

lous cleanliness. As soon as any article of clothing or bedding is soiled, it should be removed in the manner described. The sick-room must be rigidly isolated from the remainder of the house, and the family must be excluded from it.

In the Respiratory Diseases.—In the diseases of the second group the infectious material is contained in the secretions of the nose and throat and in the expectorations. The most rigid care must, therefore, be exercised in the collection and removal of this material. Great care must be taken to prevent the patient from infecting his hands and person, and thus everything with which he comes in contact. The sputum should be collected in a special receptacle containing a disinfectant solution; this receptacle must be removed once or twice daily, emptied, and disinfected. The patient's hands must be disinfected frequently with a solution of chlorid of lime or of carbolic acid. The nurse also should disinfect her hands after each handling of the patient. The clothing and bedding must be removed as soon as soiled, in the manner described under the first group of infectious diseases. The room must also be disinfected in the manner already described. The table utensils used in feeding the patient should be disinfected before they are mixed with those in use by the family. All food not eaten by the patient should be destroyed.

In the Intestinal Diseases.—In the third group of diseases the infectious material is contained in the urine and feces and in the vomit. All these excreta must be disinfected by means of equal quantities of chlorid of lime solution or 5 per cent. carbolic acid solution. Special care is necessary in the care of the patient's hands and person. Daily disinfection of the body of the patient is necessary whenever the evacuations are frequent and not carefully collected and removed. All soiled clothing and bedding must be removed and disinfected. The nurse's hands should be disinfected after handling the patient.

In the intestinal diseases special attention should be given to the purity of the water-supply. All the water used for drinking-purposes should be boiled whenever it is believed to be the source of the infection. This applies not only to the water used by the patient, as is sometimes directed, but to all the water used by the household or community using the water for domestic purposes.

When these prophylactic measures are carefully followed, the air of the room should be practically free from infective dust. This is the principal danger in all the infectious diseases, aside from direct contact with the patient, his clothing, or the excreta. There is no danger of contracting any of the infectious diseases from the breath of the patient. None of the specific pathogenic organisms are given off with the expired air in ordinary quiet respiration. Bacteria may be projected from the mucous surfaces of the mouth and nose in coughing, sneezing, or energetic talking, but never in quiet respiration.

In Other Infectious Diseases.—The prophylactic measures necessary in the other infectious diseases will be apparent to anyone who is familiar with their character and the excreta with which the infectious material leaves the body. Common sense will teach any intelligent person to apply the prophylactic measures in the right direction if these factors are borne in mind.

Disinfection of Habitations.—After recovery or death from cholera, small-pox, relapsing, typhoid, typhus, and scarlet fevers, diphtheria, measles, cerebrospinal meningitis, and severe dysentery, the effects and rooms occupied by the patient during sickness should be promptly disinfected. All large municipalities have a specially trained force of men who carry out the details of disinfection of habitations before the placard is removed from the house.

The clothing and bedding which are to be disinfected by means of steam should be carefully wrapped in cloths

saturated with 1 per cent. carbolic acid solution, placed in a wagon, and taken to the disinfecting station. After the bed has been stripped, all refuse matter, paper, and articles of little value are wrapped in cloths saturated with carbolic acid and burned in a stove or furnace.

The floor, doors, windows, furniture, and the walls for a distance of $1\frac{1}{2}$ meters from the floor should be washed with 5 per cent. carbolic acid solution. The walls and ceiling of the room should subsequently be sprayed with 1 : 1000 bichlorid of mercury solution. If the walls are papered, it is advisable to remove carefully the paper before beginning the disinfection. The room is then closed as tightly as possible and disinfected by means of formaldehyd.

In the disinfection of habitations after diseases of the alimentary type the hopper of each water-closet should be disinfected by pouring into it 3 liters of chlorinated lime; and the householder or landlord should be instructed to use in the same manner 1 liter of chlorinated lime daily for several days afterward.

The vessels in which the excretions of the patient (stools, vomit, sputum) had been collected should be washed with 5 per cent. carbolic acid solution, and then filled with the same solution and allowed to stand for twenty-four hours before they are emptied.

Disinfection of the Patient.—After convalescence has been established the question arises, How soon may the patient mingle with the remainder of the family without danger of carrying the infection? It is quite evident that this period of time will vary not only with different diseases but also in the same disease. This is manifest when we take pains to determine the length of time during which virulent diphtheria bacilli persist in the throat after all symptoms have subsided. This has extended over a period of three months or more in some cases, the average being about four weeks.

In the exanthemata it is customary to raise the quar-

antine when the physician reports the recovery of the patient, but the child is not allowed to attend school for thirty days afterward. As long as we do not know definitely the cause of the exanthemata, it is safest to fix some arbitrary time during which these patients must still be regarded as dangerous to the well.

In diphtheria it is possible to determine when the patient is free from the infectious agents by bacteriologic means. As soon as the throat, nose, and the accessory cavities are free from diphtheria bacilli, the patient may safely mingle with the well. Unfortunately, in the exanthemata we are unable to apply any such practical test. The only test we possess is completion of desquamation.

In typhoid fever it has been found that the bacilli persist in the urine and feces for a considerable time, and here also it is possible to apply the cultural test to determine the time when the patient is no longer a menace to the community.

When the patient has recovered from an infectious disease, he should be given a general bath with soap and water. In addition to this, he may be bathed with chlorinated soda solution, and in the exanthemata it may be advisable to anoint his body again unless all desquamation has ceased. After a general bath has been given, the patient may be allowed to mingle with the well.

In most localities the convalescent from certain diseases, especially small-pox, is washed with 1 : 2000 bichlorid of mercury solution, clothed with clean clothing, and then transferred to a disinfected room.

Disinfection of Public Conveyances.—The danger of disseminating disease through public conveyances has led to a great deal of discussion, and in many communities it has passed beyond the stage of discussion. Many local and State boards of health prohibit the promiscuous expectoration in public places which was once so common. The danger of disseminating infectious diseases by allowing sick persons to be conveyed in the ordinary

public conveyances has led to the appointment of a committee on car sanitation by the American Public Health Association. This committee rendered and had adopted the following report :

"1. When a passenger is known to be contagiously ill, he should be isolated in a compartment appropriately equipped and ventilated in such a manner as to separate it from the rest of the car. Through trains should be provided with rooms for the sick as well as state-rooms, interchangeable in use.

"2. The interior of passenger cars should be plain, and finished with hard, smooth, and polished surfaces.

"3. All furnishings should be as non-absorbent as possible.

"4. Coaches should be furnished with effective means for continuously supplying not less than 1000 cubic feet of warm air an hour for each single seat, and for distributing and removing the air without troublesome draught.

"5. The temperature should be regulated.

"6. The cleaning of cars should be frequent and thorough.

"7. Floors and sanitary lavatory fixtures should be frequently treated with a disinfecting wash.

"8. All fabrics in cars should receive sterilizing treatment. All bed and lavatory linen should be thoroughly sterilized in the process of laundering.

"9. Sewage-tanks and earth-closets should be provided under the cars. The practice of disposing of excreta by scattering it over roadbeds is dangerous.

"10. Water and ice should be obtained from the purest available sources. The use of tongs in handling ice should be insisted upon.

"11. The water-tank should be frequently cleansed and periodically sterilized with boiling water or otherwise.

"12. The public should be educated to use individual

cups. Paper paraffined cups might be provided by a cent-in-the-slot device.

“13. The use of canned goods in buffet-car service makes careful inspection of such goods imperative. Fruits and all eatables before and after purchase should be stored with care, to avoid all unnecessary exposure to street and car dust.

“14. The filthy habit of spitting on car floors should be dealt with in a manner to cause its prompt discontinuance. It should be punished as one of the most flagrant of the thoughtless offences against the public right to health.

“15. Station premises should receive attention directed to general cleanliness of floors, furnishings, air, sanitariums, lavatories, platforms, and approaches, and should be plentifully supplied with approved disinfecting material.”

The Disinfection of Libraries.—Formaldehyd gas may be conveniently applied for the disinfection of books by the use of a Schering lamp. A perfectly tight box should be provided. It should be lined inside with a heavy calendered paper, and the joints tightly closed. The books should be opened out with all leaves exposed, and placed on shelves or racks within the box.

More convenient than a box would be a small closet with a lattice-work or shelves upon which to expose the books.

The problem of disinfecting a number of books at once is quite a difficult one. Library books are infected through handling. The infection is apt to adhere to the leaves of the book, and each individual leaf must be opened in such a way as to become penetrated by the formaldehyd gas. Large libraries are now generally equipped with disinfecting apparatus so as to be in a position to disinfect books that may have been in relation with any of the infectious diseases.

Barber-shops.—The danger of contracting disease in barber-shops is now receiving more general recognition. The selection of a barber is evidently a matter of some

consideration, and should be influenced largely by the care which he exercises to prevent the dissemination of contagion. Health Commissioner Lederie recently issued the following ten rules for the governance of barbers in Greater New York :

1. Barbers must wash their hands thoroughly with soap and hot water before attending any person.

2. No alum or other astringent shall be used in stick form. If used at all to stop flow of blood, it must be applied in powder form.

3. The use of powder-puffs is prohibited.

4. No towel shall be used for more than one person without being washed.

5. The use of sponges is prohibited.

6. Mugs and shaving-brushes shall be thoroughly washed after use on each person.

7. Combs, razors, clippers, and scissors shall be thoroughly cleansed by dipping in boiling water or other germicide after separate use thereof.

8. No barber, unless he be a licensed physician, shall prescribe for any skin disease.

9. Floors must be swept or mopped every day and all furniture and woodwork kept free from dust.

10. Hot and cold water must be provided.

Similar rules have been adopted by the Board of Health of New Orleans and of other cities.

CHAPTER XIX.

QUARANTINE.

QUARANTINE applies to the detention of ships with cases of infectious diseases on board to the ports in which they are found, to the detention of persons in infected localities, and to the detention of the occupants of a house in which there is a case of infectious disease. The first is commonly spoken of as maritime quarantine, the detention of persons in infected localities as inland quarantine, and the last as house quarantine.

Maritime Quarantine.—Maritime quarantine consists of the detention of the infected ship, the isolation of the sick in a special hospital at the quarantine station, the disinfection of the ship and its cargo as well as the clothing and bedding of the well, the detention of all well persons in barracks until after the period of incubation of the particular disease has elapsed and all danger of dissemination has been eliminated. The period of detention, the mode of disinfection, as well as all the other prophylactic measures employed, will depend entirely upon the character of the disease, its period of incubation, and the nature of the ship's cargo. The disinfecting agents commonly employed are superheated steam and formaldehyd.

The national government maintains quarantine and inspection stations at the following points: Portland, Me.; Boston, Mass.; New York, N. Y.; Delaware Breakwater and Reedy Island, Del.; Alexandria and Cape Charles, Va.; Beaufort, Cape Fear, Newbern, and Washington, N. C.; Brunswick, Blackbeard Island, and Savannah, Ga.; Tortugas Islands, Fla.; Pascagoula and Ship Island, Miss.; San Diego, San Pedro, San Fran-

cisco, Los Angeles, and Eureka, Cal.; Columbia River, Ore.; Port Townsend, Grays Harbor, and Port Angeles, Wash.; Dutch Harbor and Nome, Alaska.

Some of the States and municipalities having important seaports have also established quarantine and inspection stations in addition to those of the national government, as follows: Bangor, Me.; Boston and New Bedford, Mass.; Providence and Newport, R. I.; New York, N. Y.; Marcus Hook, Pa.; Baltimore, Md.; Newport News and Elizabeth River, Va.; Port Royal, St. Helena Entrance, and Charleston, S. C.; Mayport, Tampa Bay, Pensacola, Auclote, Carrabelle, Charlotte Harbor, Cedar Keys, and Key West, Fla.; Mobile Bay, Ala.; New Orleans, La.; Galveston, Quintana, Sabine Pass, and Pass Cavallo, Tex.; and Gardiner, Ore.

Inland Quarantine.—Inland quarantine is employed in times of epidemics confined to certain localities of the country. In the United States this form of quarantine has been frequently applied to localities infected with yellow fever. The prevention of all communication with the locality is sometimes enforced by means of a line of guards surrounding the locality, and hence is frequently spoken of as "shotgun" quarantine. Where important railroad centers are involved in an infected area, this form of quarantine is commonly known as railroad quarantine, and all intercourse with the infected area by rail is stopped. All merchandise and mail coming from the infected area are disinfected whenever traffic is not completely at a standstill.

The extension of inland quarantine to interstate commerce and traffic is known as interstate quarantine, and becomes necessary where large areas are infected and there is danger of general dissemination of the infectious disease. The establishment of definite interstate quarantine regulations by the U. S. Treasury department obviates in large part the confusion which frequently existed during an epidemic of yellow fever, because of the conflicting, and in many instances ridiculous, quar-

antine regulations formulated by State, county, and municipal authorities.

Isolation or House Quarantine.—The infectious diseases against which house quarantine is usually employed are small-pox, scarlet fever, diphtheria, cerebrospinal meningitis, cholera, typhus and typhoid fevers, yellow fever, relapsing fever, and leprosy. Plague is now also included in this category.

The patient suffering from any of these infectious diseases should be isolated from the rest of the family, preferably in a room on an upper floor of the house. All persons residing in the house are prohibited from attending any school whatsoever, as well as from going to any other places of public assembly. No one is allowed to enter the house during the course of the disease except those in direct charge of the patient, and no one is permitted to visit the sick-room except the physicians and attendants. The house is placarded by the local health authorities with a placard indicating the nature of the disease and the danger of communicating the disease to others. The placard is not removed by the health authorities until after the patient has either recovered or died, and the premises have been thoroughly disinfected.

Value of Disinfection and Isolation.—It is impossible to give definite information with regard to the value of disinfection alone, because at the present time it is almost always practised along with isolation. The value of these measures in such a disease as small-pox is well known. In other diseases they are no doubt of equal value. The only figures obtainable which bear directly upon this point are contained in the reports of the State Board of Health of Michigan. In the report for the year 1898 are given some comparative observations made during a number of outbreaks of diphtheria and scarlet fever in that State during the eleven years from 1887 to and including 1898. In some of these outbreaks isolation and disinfection were enforced, in others they were

TABLE I.—*Diphtheria*.—Exhibiting for the eleven years, 1887-97, the Number of Reported Outbreaks, Cases, and Deaths; also for this eleven-year period the average number of cases and deaths, per outbreak, in all outbreaks in which isolation or disinfection was doubtful; in which both isolation and disinfection were neglected; in which both isolation and disinfection were enforced; and also the number of cases and deaths indicated to have been prevented by isolation and disinfection.

| Year. | All outbreaks. | | | | Isolation and disinfection, or both, not mentioned, or statements doubtful. | | | | Isolation and disinfection both neglected. | | | | Isolation and disinfection both enforced. | | | | Indicated saving of cases and lives by isolation and disinfection. | |
|--|----------------|--------|---------|-------------|---|---------|-------------|--------|--|-------------|--------|---------|---|---------|--------|---------|--|--|
| | Out-breaks. | Cases. | Deaths. | Out-breaks. | Cases. | Deaths. | Out-breaks. | Cases. | Deaths. | Out-breaks. | Cases. | Deaths. | Cases. | Deaths. | Cases. | Deaths. | | |
| 1887 | 398 | 2,321 | 561 | 202 | 732 | 190 | 60 | 822 | 195 | 79 | 198 | 51 | 3,132 | 733 | | | | |
| 1888 | 311 | 1,529 | 324 | 199 | 810 | 189 | 34 | 527 | 81 | 58 | 101 | 31 | 3,292 | 416 | | | | |
| 1889 | 376 | 1,986 | 418 | 254 | 1,314 | 280 | 41 | 478 | 108 | 63 | 98 | 14 | 2,398 | 570 | | | | |
| 1890 | 439 | 2,713 | 619 | 291 | 1,649 | 401 | 71 | 902 | 169 | 46 | 70 | 15 | 2,862 | 426 | | | | |
| 1891 | 532 | 2,965 | 643 | 366 | 1,777 | 389 | 79 | 944 | 194 | 70 | 157 | 24 | 3,392 | 666 | | | | |
| 1892 | 525 | 3,485 | 740 | 323 | 2,341 | 456 | 52 | 957 | 147 | 49 | 105 | 33 | 3,146 | 746 | | | | |
| 1893 | 536 | 3,133 | 746 | 303 | 1,081 | 362 | 74 | 1,020 | 282 | 65 | 159 | 45 | 4,253 | 1,296 | | | | |
| 1894 | 420 | 2,262 | 404 | 202 | 986 | 174 | 56 | 738 | 122 | 81 | 176 | 37 | 3,274 | 512 | | | | |
| 1895 | 388 | 2,292 | 425 | 178 | 1,102 | 209 | 45 | 610 | 119 | 70 | 146 | 28 | 2,969 | 599 | | | | |
| 1896 | 405 | 2,460 | 432 | 153 | 925 | 165 | 64 | 794 | 142 | 69 | 164 | 27 | 2,566 | 467 | | | | |
| 1897 | 464 | 2,838 | 497 | 165 | 916 | 137 | 100 | 1,366 | 252 | 93 | 225 | 46 | 3,500 | 672 | | | | |
| Totals for 11 yrs. 1887-97. | 4,794 | 27,984 | 5,809 | 2,636 | 14,233 | 2,952 | 676 | 8,858 | 1,811 | 742 | 1,599 | 351 | 34,784 | 7,103 | | | | |
| Average for the 11 yrs. 1887-97. | 436 | 2,544 | 528 | 240 | 1,294 | 268 | 61 | 805 | 165 | 67 | 145 | 32 | 3,162 | 646 | | | | |
| Average cases and deaths, per outbreak, for the 11 yrs. 1887-97. | | 5.83 | 1.21 | | 5.39 | 1.12 | | 13.20 | 2.70 | | 2.16 | 0.48 | | | | | | |

TABLE. II.—*Scarlet Fever*.—Exhibiting for the eleven years, and for each of the eleven years, 1887-97, the Number of Reported Outbreaks, Cases, and Deaths; also for this eleven-year period the average number of cases and deaths, per outbreak, in all outbreaks; in those outbreaks in which isolation or disinfection or both were doubtful; isolation and disinfection both neglected; isolation and disinfection both enforced; and also the number of cases and deaths indicated as having been prevented by isolation and disinfection.

| Years. | All outbreaks. | | | Isolation or disinfection, or both, not mentioned, or statements doubtful. | | | Isolation and disinfection both neglected. | | | Isolation and disinfection both enforced. | | | Cases and deaths indicated as having been prevented by isolation and disinfection. | |
|--|----------------|--------|---------|--|--------|---------|--|--------|---------|---|--------|---------|--|---------|
| | Outbreaks. | Cases. | Deaths. | Outbreaks. | Cases. | Deaths. | Outbreaks. | Cases. | Deaths. | Outbreaks. | Cases. | Deaths. | Cases. | Deaths. |
| 1887 | 299 | 1,882 | 141 | 190 | 1,200 | 93 | 32 | 440 | 34 | 64 | 148 | 11 | 2,229 | 176 |
| 1888 | 340 | 1,838 | 112 | 225 | 955 | 74 | 61 | 724 | 33 | 36 | 80 | 3 | 2,198 | 72 |
| 1889 | 417 | 1,822 | 123 | 284 | 1,455 | 61 | 72 | 1,208 | 48 | 52 | 140 | 10 | 4,175 | 156 |
| 1890 | 477 | 3,054 | 115 | 302 | 1,711 | 67 | 94 | 1,137 | 36 | 42 | 76 | 1 | 2,718 | 66 |
| 1891 | 602 | 4,930 | 193 | 380 | 3,012 | 91 | 141 | 1,704 | 66 | 42 | 107 | 1 | 2,342 | 90 |
| 1892 | 622 | 5,240 | 306 | 377 | 2,944 | 188 | 110 | 1,621 | 59 | 42 | 97 | 7 | 3,928 | 30 |
| 1893 | 667 | 5,219 | 327 | 387 | 3,197 | 204 | 124 | 1,511 | 99 | 60 | 157 | 8 | 2,912 | 207 |
| 1894 | 662 | 4,349 | 175 | 378 | 2,366 | 93 | 104 | 1,348 | 42 | 74 | 187 | 9 | 4,231 | 90 |
| 1895 | 555 | 2,995 | 85 | 275 | 1,259 | 42 | 82 | 1,139 | 27 | 92 | 162 | 4 | 4,798 | 98 |
| 1896 | 389 | 1,534 | 42 | 148 | 485 | 15 | 80 | 681 | 16 | 78 | 153 | 4 | 1,776 | 36 |
| 1897 | 330 | 1,531 | 52 | 130 | 654 | 21 | 63 | 427 | 17 | 59 | 127 | 5 | 747 | 39 |
| Totals | 5,366 | 35,310 | 1,671 | 3,076 | 19,236 | 949 | 963 | 11,939 | 477 | 641 | 1,434 | 63 | 31,228 | 1,012 |
| Average, 11 years. | 488 | 3,210 | 152 | 280 | 1,749 | 86 | 88 | 1,085 | 43 | 58 | 130 | 6 | 2,914 | 96 |
| Average cases and deaths, per outbreak, for 11 yrs. 1887-97. | | 6.58 | 0.31 | | 6.25 | 0.31 | | 12.40 | 0.50 | | 2.24 | 0.10 | | |

neglected. The detailed results are given in Tables I. and II., and are also graphically presented in Chart I.

These studies indicate that 34,784 cases and 7103 deaths were saved from diphtheria, and 31,228 cases and 1012 deaths from scarlet fever, during the eleven years. If we take into consideration the immense financial saving alone that is represented by these figures, we see the great economic value to the State of the application of these preventive measures, a large part of which can no doubt be safely attributed to the employment of disinfectants.

The value of isolation and disinfection as usually practised is shown graphically in the following chart, reproduced from the proceedings of the third annual conference of the health officers of Michigan, 1896:

Isolation and Disinfection in Scarlet Fever and Diphtheria in Michigan during the Five Years 1886-90.

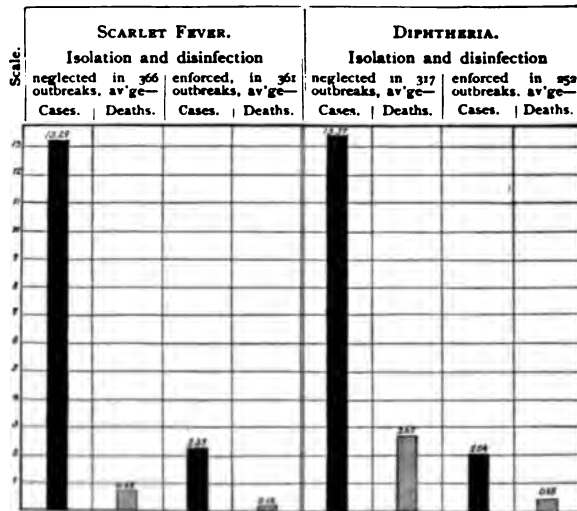

Figure 63 represents influence of isolation and disinfection in scarlet fever according to recent experience in England.¹

¹ *Jour. of Hygiene*, vol. i., 1901.

Period of Isolation.—The period of time during which the infectiveness of a patient continues varies with each disease. In the exanthemata the quarantine is usually raised two weeks after the eruption has entirely disappeared, except for small-pox, for which the period of isolation is thirty days. In diphtheria the quarantine

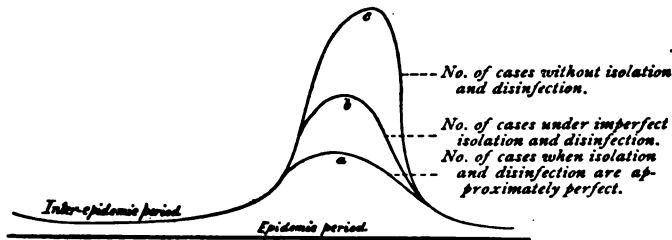

FIG. 63.—Isolation and disinfection in scarlet fever.

is not raised until cultures taken from the throat of the patient fail to show the presence of the diphtheria bacillus. This period varies very greatly in different cases, ranging from five to one hundred or more days after the total disappearance of the membrane.

Period of Detention of Those Exposed to the Infectious Diseases.—Those exposed to the infectious diseases are detained until after the period of incubation of the particular disease has elapsed. The following table shows the period of incubation of the more common infectious diseases:

| | |
|-------------------------|----------|
| Small-pox | 12 days. |
| Measles | 10 " |
| Scarlet fever | 3 " |
| Diphtheria | 3 " |
| Cholera | 10 " |
| Typhoid fever | 14 " |
| Yellow fever | 5 " |

If no new outbreaks occur during the period of detention among those who have been exposed to the infection, the quarantine is raised after the period of incubation of the particular disease has elapsed.

Maritime Quarantine.—Maritime quarantine is practised against cholera, typhus fever, yellow fever, small-pox, leprosy, and plague, though any of the acute infectious diseases may be quarantined.

In a recent paper on modern quarantine in Canada and the United States, Dr. Montizambert, of Quebec, states that the requirements for a quarantine station are held to be as follows:

“1. A boarding station, so placed as to command the channel leading to the port.

“2. A boarding steamer fitted with hospital cabins, for landing the sick, and with appliances for disinfecting in the offing ships' hospitals with mercuric chlorid douche, and with steam when such disinfection is found to be all that the vessel requires.

“3. A reserve steamer to replace the usual boarding steamer on emergency, and—where the station is isolated—to act as a supply and mail steamer, for forwarding convalescents, etc.

“4. An anchorage for vessels under quarantine or observation. It should be placed conveniently for the main establishment, and safely remote from the track of commerce.

“5. A deep-water pier. The depth of water at low tide at its end should be at least equal to the draught of the largest vessels coming to the port, with a frontage sufficient for such vessels to moor to it if required. Upon this pier there should be constructed—

“*a.* A warehouse;

“*b.* Elevated tanks for disinfecting solutions;

“*c.* A disinfecting-house containing steam disinfecting cylinders;

“*d.* Sulphur furnace, engine, exhaust fans, etc., for fumigation.

“6. A lazarette or hospital for the treatment of infectious diseases.

“7. Separate accommodations for non-infectious cases from infected vessels in quarantine.

"8. Detention-houses for the detention, under observation, in groups, of "suspects" or persons who have been exposed to infection.

"9. Quarters for officers and staff.

"10. Telegraphic communication with the rest of the world. Telephonic communication between the different parts of the station.

"11. A bacteriologic laboratory.

"12. A cremation furnace for the disposal of the bodies of those who have died of infectious diseases."

Within the last few years most of the quarantine stations have been equipped with formaldehyd gas generators for use in the disinfection of infected vessels.

All maritime and interstate quarantine powers of the United States have been conferred upon the Supervising Surgeon-General of the Public Health and Marine-Hospital Service, and this service is under the direction of the Secretary of the Treasury. The following is a transcript of the acts of Congress conferring these powers, as well as the quarantine laws of the United States :

QUARANTINE LAWS OF THE UNITED STATES.

AN ACT TO INCREASE THE EFFICIENCY AND CHANGE THE NAME OF THE UNITED STATES MARINE-HOSPITAL SERVICE.

[Approved July 1, 1902.]

Be it enacted by the Senate and House of Representatives of the United States of America in Congress assembled, That the United States Marine-Hospital Service shall hereafter be known and designated as the Public Health and Marine-Hospital Service of the United States, and the Supervising Surgeon-General and the officers now or hereafter commissioned under the Act of January fourth, eighteen hundred and eighty-nine, entitled "An Act to regulate appointments in the Marine-Hospital Service of the United States," and Acts amendatory thereof, shall hereafter be known as the Surgeon-General, surgeons, passed assistant surgeons, and assistant surgeons of the Public Health and Marine-Hospital Service of the United States. Nothing in this Act contained shall be held or construed to discharge any of the officers above named, or any of the acting assistant surgeons, pharmacists, and other employees of the Marine-Hospital Service, or to deprive

QUARANTINE LAWS OF THE UNITED STATES. 449

any officer of his commission or the benefits derived by longevity of service. The care of sick and disabled seamen and all other duties now required by law to be performed by the Marine-Hospital Service shall hereafter be performed by the Public Health and Marine-Hospital Service, and all funds and appropriations now provided by law for use by the Marine-Hospital Service and all properties and rights pertaining to said service shall be available for use for like purposes and in like manner, under the Treasury Department, by the Public Health and Marine-Hospital Service.

SEC. 2. That the salary of the Surgeon-General of the Public Health and Marine-Hospital Service shall be five thousand dollars per annum, and the salaries and allowances of the commissioned medical officers of said service shall be the same as now provided by regulations of the Marine-Hospital Service.

SEC. 3. That commissioned medical officers, when detailed by the Surgeon-General for duty in the Public Health and Marine-Hospital Bureau at Washington, District of Columbia, in charge of the administrative divisions thereof, namely, marine hospitals and relief, domestic quarantine, foreign and insular quarantine, personnel and accounts, sanitary reports and statistics, and scientific research, shall, while thus serving, be assistant surgeons-general of the Public Health and Marine-Hospital Service, but their pay and allowances shall be the same as now provided by regulations of the Marine-Hospital Service for officers in charge of said divisions; and the senior officer thus serving shall be the assistant within the meaning of section one hundred and seventy-eight, Revised Statutes of the United States: *Provided, however,* That no such officer shall be detailed in charge of said divisions who is below the rank of passed assistant surgeon.

SEC. 4. That the President is authorized, in his discretion, to utilize the Public Health and Marine-Hospital Service in times of threatened or actual war to such extent and in such manner as shall in his judgment promote the public interest without, however, in any wise impairing the efficiency of the service for the purposes for which the same was created and is maintained.

SEC. 5. That there shall be an advisory board for the hygienic laboratory provided by the Act of Congress approved March third, nineteen hundred and one, for consultation with the Surgeon-General of the Public Health and Marine-Hospital Service relative to the investigations to be inaugurated, and the methods of conducting the same, in said laboratory. Said board shall consist of three competent experts, to be detailed from the Army, the Navy, and the Bureau of Animal Industry by the Surgeon-General of the Army, the Surgeon-General of the Navy, and the Secretary of Agriculture, respectively, which experts, with the director of the said laboratory, shall be ex officio members of the board, and serve without additional compensation. Five other members of said board shall be appointed by the Surgeon-Gen-

eral of Public Health and Marine-Hospital Service, with the approval of the Secretary of the Treasury, who shall be skilled in laboratory work in its relation to the public health, and not in the regular employment of the Government. The said five members shall each receive compensation of ten dollars per diem while serving in conference, as aforesaid, together with allowance for actual and necessary traveling expenses and hotel expenses while in conference. Said conference is not to exceed ten days in any one fiscal year. The term of service of the five members of said board, not in the regular employment of the Government, first appointed shall be so arranged that one of said members shall retire each year, the subsequent appointments to be for a period of five years. Appointments to fill vacancies occurring in a manner other than as above provided shall be made for the unexpired term of the member whose place has become vacant.

SEC. 6. That there shall be appointed by the Surgeon-General, with the approval of the Secretary of the Treasury, whenever, in the opinion of the Surgeon-General, commissioned medical officers of the Public Health and Marine-Hospital Service are not available for this duty by detail, competent persons to take charge of the divisions, respectively, of chemistry, zoology, and pharmacology of the hygienic laboratory, who shall each receive such pay as shall be fixed by the Surgeon-General, with the approval of the Secretary of the Treasury. The director of the said laboratory shall be an officer detailed from the corps of commissioned medical officers of the Public Health and Marine-Hospital Service, as now provided by regulations for said detail from the Marine-Hospital Service, and while thus serving shall have the pay and emoluments of a surgeon: *Provided*, That all commissioned officers of the Public Health and Marine-Hospital Service not below the grade of passed assistant surgeon shall be eligible to assignment to duty in charge of the said divisions of the hygienic laboratory, and while serving in such capacity shall be entitled to the pay and emoluments of their rank.

SEC. 7. That when, in the opinion of the Surgeon-General of the Public Health and Marine-Hospital Service of the United States, the interests of the public health would be promoted by a conference of said service with State or Territorial boards of health, quarantine authorities, or State health officers, the District of Columbia included, he may invite as many of said health and quarantine authorities as he deems necessary or proper to send delegates, not more than one from each State or Territory and District of Columbia, to said conference: *Provided*, That an annual conference of the health authorities of all the States and Territories and the District of Columbia shall be called, each of said States, Territories, and the District of Columbia to be entitled to one delegate: *And provided, further*, That it shall be the duty of the said Surgeon-General to call a conference upon the application of not less than five State or Territorial boards of

QUARANTINE LAWS OF THE UNITED STATES. 451

health, quarantine authorities, or State health officers, each of said States and Territories joining in such request to be represented by one delegate.

SEC. 8. That to secure uniformity in the registration of mortality, morbidity, and vital statistics it shall be the duty of the Surgeon-General of the Public Health and Marine-Hospital Service, after the annual conference required by section seven to be called, to prepare and distribute suitable and necessary forms for the collection and compilation of such statistics, and said statistics, when transmitted to the Public Health and Marine-Hospital Bureau on said forms, shall be compiled and published by the Public Health and Marine-Hospital Service as a part of the health reports published by said service.

SEC. 9. That the President shall from time to time prescribe rules for the conduct of the Public Health and Marine-Hospital Service. He shall also prescribe regulations respecting its internal administration and discipline, and the uniforms of its officers and employees. It shall be the duty of the Surgeon-General to transmit annually to the Secretary of the Treasury, for transmission by said Secretary to Congress, a full and complete report of the transactions of said service, including a detailed statement of receipts and disbursements.

AN ACT GRANTING ADDITIONAL QUARANTINE POWERS AND IMPOSING ADDITIONAL DUTIES UPON THE MARINE-HOSPITAL SERVICE.

[Approved, February 15, 1893.]

Be it enacted by the Senate and House of Representatives of the United States of America in Congress assembled, That it shall be unlawful for any merchant ship or other vessel from any foreign port or place of [to] enter any port of the United States except in accordance with the provisions of this act and with such rules and regulations of State and municipal health authorities as may be made in pursuance of, or consistent with, this act; and any such vessel which shall enter, or attempt to enter, a port of the United States in violation thereof shall forfeit to the United States a sum, to be awarded in the discretion of the court, not exceeding five thousand dollars, which shall be a lien upon said vessel, to be recovered by proceedings in the proper district court of the United States. In all such proceedings the United States district attorney for such district shall appear on behalf of the United States; and all such proceedings shall be conducted in accordance with the rules and laws governing cases of seizure of vessels for violation of the revenue laws of the United States.

SEC. 2. That any vessel at any foreign port clearing for any port or place in the United States shall be required to obtain from the consul, vice-consul, or other consular officer of the United States at the port of departure, or from the medical officer where such officer has been detailed by the President for that

purpose, a bill of health, in duplicate, in the form prescribed by the Secretary of the Treasury, setting forth the sanitary history and condition of said vessel, and that it has in all respects complied with the rules and regulations in such cases prescribed for securing the best sanitary condition of the said vessel, its cargo, passengers, and crew; and said consular or medical officer is required, before granting such duplicate bill of health, to be satisfied that the matters and things therein stated are true; and for his services in that behalf he shall be entitled to demand and receive such fees as shall by lawful regulation be allowed, to be accounted for as is required in other cases.

The President, in his discretion, is authorized to detail any medical officer of the Government to serve in the office of the consul at any foreign port for the purpose of furnishing information and making the inspection and giving the bills of health hereinbefore mentioned. Any vessel clearing and sailing from any such port without such bill of health, and entering any port of the United States, shall forfeit to the United States not more than five thousand dollars, the amount to be determined by the court, which shall be a lien on the same, to be recovered by proceedings in the proper district court of the United States. In all such proceedings the United States district attorney for such district shall appear on behalf of the United States; and all such proceedings shall be conducted in accordance with the rules and laws governing cases of seizure of vessels for violation of the revenue laws of the United States.

SEC. 3. That the Supervising Surgeon-General of the Marine-Hospital Service shall, immediately after this act takes effect, examine the quarantine regulations of all State and municipal boards of health, and shall, under the direction of the Secretary of the Treasury, cooperate with and aid State and municipal boards of health in the execution and enforcement of the rules and regulations of such boards and in the execution and enforcement of the rules and regulations made by the Secretary of the Treasury, to prevent the introduction of contagious or infectious diseases into the United States from foreign countries, and into one State or Territory or the District of Columbia from another State or Territory or the District of Columbia; and all rules and regulations made by the Secretary of the Treasury shall operate uniformly and in no manner discriminate against any port or place; and at such ports and places within the United States as have no quarantine regulations under State or municipal authority, where such regulations are, in the opinion of the Secretary of the Treasury, necessary to prevent the introduction of contagious or infectious diseases into the United States from foreign countries, or into one State or Territory or the District of Columbia from another State or Territory or the District of Columbia, and at such ports and places within the United States where quarantine regulations exist under the

authority of the State or municipality which, in the opinion of the Secretary of the Treasury, are not sufficient to prevent the introduction of such diseases into the United States, or into one State or Territory or the District of Columbia from another State or Territory or the District of Columbia, the Secretary of the Treasury shall, if in his judgment it is necessary and proper, make such additional rules and regulations as are necessary to prevent the introduction of such diseases into the United States from foreign countries, or into one State or Territory or the District of Columbia from another State or Territory or the District of Columbia, and when said rules and regulations have been made they shall be promulgated by the Secretary of the Treasury and enforced by the sanitary authorities of the States and municipalities, where the State or municipal health authorities will undertake to execute and enforce them ; but if the State or municipal authorities shall fail or refuse to enforce said rules and regulations, the President shall execute and enforce the same and adopt such measures as in his judgment shall be necessary to prevent the introduction or spread of such diseases, and may detail or appoint officers for that purpose. The Secretary of the Treasury shall make such rules and regulations as are necessary to be observed by vessels at the port of departure and on the voyage, where such vessels sail from any foreign port or place to any port or place in the United States, to secure the best sanitary condition of such vessel, her cargo, passengers, and crew ; which shall be published and communicated to and enforced by the consular officers of the United States. None of the penalties herein imposed shall attach to any vessel or owner or officer thereof until a copy of this act, with the rules and regulations made in pursuance thereof, has been posted up in the office of the consul or other consular officer of the United States for ten days, in the port from which said vessel sailed ; and the certificate of such consul or consular officer over his official signature shall be competent evidence of such posting in any court of the United States.

SEC. 4. That it shall be the duty of the Supervising Surgeon-General of the Marine-Hospital Service, under the direction of the Secretary of the Treasury, to perform all the duties in respect to quarantine and quarantine regulations which are provided for by this act, and to obtain information of the sanitary condition of foreign ports and places from which contagious and infectious diseases are or may be imported into the United States, and to this end the consular officers of the United States at such ports and places as shall be designated by the Secretary of the Treasury shall make to the Secretary of the Treasury weekly reports of the sanitary condition of the ports and places at which they are respectively stationed, according to such forms as the Secretary of the Treasury shall prescribe ; and the Secretary of the Treasury shall also obtain, through all sources accessible, including State and municipal sanitary authorities throughout the United

States, weekly reports of the sanitary condition of ports and places within the United States, and shall prepare, publish, and transmit to collectors of customs and to State and municipal health officers and other sanitarians weekly abstracts of the consular sanitary reports and other pertinent information received by him, and shall also, as far as he may be able, by means of the voluntary coöperation of State and municipal authorities, of public associations, and private persons, procure information relating to the climatic and other conditions affecting the public health, and shall make an annual report of his operations to Congress, with such recommendations as he may deem important to the public interests.

SEC. 5. That the Secretary of the Treasury shall from time to time issue to the consular officers of the United States and to the medical officers serving at any foreign port, and otherwise make publicly known, the rules and regulations made by him, to be used and complied with by vessels in foreign ports, for securing the best sanitary condition of such vessels, their cargoes, passengers, and crew, before their departure for any port in the United States, and in the course of the voyage; and all such other rules and regulations as shall be observed in the inspection of the same on the arrival thereof at any quarantine station at the port of destination, and for the disinfection and isolation of the same, and the treatment of cargo and persons on board, so as to prevent the introduction of cholera, yellow fever, or other contagious or infectious diseases; and it shall not be lawful for any vessel to enter said port to discharge its cargo, or land its passengers, except upon a certificate of the health officer at such quarantine station certifying that said rules and regulations have in all respects been observed and complied with, as well on his part as on the part of the said vessel and its master, in respect to the same and to its cargo, passengers, and crew; and the master of every such vessel shall produce and deliver to the collector of customs at said port of entry, together with the other papers of the vessel, the said bills of health required to be obtained at the port of departure and the certificate herein required to be obtained from the health officer at the port of entry; and that the bills of health herein prescribed shall be considered as part of the ship's papers, and when duly certified to by the proper consular officer or other officer of the United States, over his official signature and seal, shall be accepted as evidence of the statements therein contained in any court of the United States.

SEC. 6. That on the arrival of an infected vessel at any port not provided with proper facilities for treatment of the same, the Secretary of the Treasury may remand said vessel, at its own expense, to the nearest national or other quarantine station, where accommodations and appliances are provided for the necessary disinfection and treatment of the vessel, passengers, and cargo; and after treatment of any infected vessel at a national

quarantine station, and after certificate shall have been given by the United States quarantine officer at said station that the vessel, cargo, and passengers are each and all free from infectious disease, or danger of conveying the same, said vessel shall be admitted to entry to any port of the United States named within the certificate. But at any ports where sufficient quarantine provision has been made by State or local authorities the Secretary of the Treasury may direct vessels bound for said ports to undergo quarantine at said State or local station.

SEC. 7. That whenever it shall be shown to the satisfaction of the President that by reason of the existence of cholera or other infectious or contagious diseases in a foreign country there is serious danger of the introduction of the same into the United States, and that notwithstanding the quarantine defence this danger is so increased by the introduction of persons or property from such country that a suspension of the right to introduce the same is demanded in the interest of the public health, the President shall have power to prohibit, in whole or in part, the introduction of persons and property from such countries or places as he shall designate and for such period of time as he may deem necessary.

SEC. 8. That whenever the proper authorities of a State shall surrender to the United States the use of the buildings and disinfecting apparatus at a State quarantine station the Secretary of the Treasury shall be authorized to receive them and to pay a reasonable compensation to the State for their use, if, in his opinion, they are necessary to the United States.

SEC. 9. That the act entitled "An act to prevent the introduction of infectious or contagious diseases into the United States, and to establish a national board of health," approved March 3, 1879, be, and the same is hereby, repealed. And the Secretary of the Treasury is directed to obtain possession of any property, furniture, books, paper, or records belonging to the United States which are not in the possession of an officer of the United States under the Treasury Department which were formerly in the use of the National Board of Health or any officer or employé thereof.

[Act of Congress, approved August 18, 1894.]

AN ACT to amend section two of the act approved February fifteenth, eighteen hundred and ninety-three, entitled "An act granting additional quarantine powers and imposing additional duties upon the Marine-Hospital Service."

Be it enacted by the Senate and House of Representatives of the United States of America in Congress assembled, That section two of the act approved February fifteenth, eighteen hundred and ninety-three, entitled "An act granting additional quarantine powers and imposing additional duties upon the Marine-Hospital Service," is hereby amended by adding to the end of said section the following :

“The provisions of this section shall not apply to vessels plying between foreign ports on or near the frontiers of the United States and ports of the United States adjacent thereto; but the Secretary of the Treasury is hereby authorized, when, in his discretion, it is expedient for the preservation of the public health, to establish regulations governing such vessels.”

REVISED STATUTES.

SEC. 4794. There shall be purchased or erected, under the orders of the President, suitable warehouses, with wharves and inclosures, where merchandise may be unladen and deposited from any vessel which shall be subject to a quarantine or other restraint, pursuant to the health laws of any State, at such convenient places therein as the safety of the public revenue and the observance of such health laws may require.

SEC. 4795. Whenever the cargo of a vessel is unladen at some other place than the port of entry or delivery under the foregoing provisions, all the articles of such cargo shall be deposited, at the risk of the parties concerned therein, in such public or other warehouses or inclosures as the collector shall designate, there to remain under the joint custody of such collector and of the owner, or master, or other person having charge of such vessel, until the same are entirely unladen or discharged, and until the articles so deposited may be safely removed without contravening such health laws. And when such removal is allowed, the collector having charge of such articles may grant permits to the respective owners or consignees, their factors or agents, to receive all merchandise which has been entered, and the duties accruing upon which have been paid, upon the payment by them of a reasonable rate of storage; which shall be fixed by the Secretary of the Treasury for all public warehouses and inclosures.

SEC. 4796. The Secretary of the Treasury is authorized, whenever a conformity to such quarantine and health laws requires it, and in respect to vessels subject thereto, to prolong the terms limited for the entry of the same and the report or entry of their cargoes, and to vary or dispense with any other regulations applicable to such reports or entries. No part of the cargo of any vessel shall, however, in any case be taken out or unladen therefrom otherwise than is allowed by law, or according to the regulations hereinafter established.

SEC. 4797. Whenever, by the prevalence of any contagious or epidemic disease in or near the place by law established as the port of entry for any collection district, it becomes dangerous or inconvenient for the officers of the revenue employed therein to continue the discharge of their respective offices at such port, the Secretary of the Treasury, or, in his absence, the First Comptroller, may direct the removal of the officers of the revenue

from such port to any other more convenient place within or as near as may be to such collection district. And at such place such officers may exercise the same powers and shall be liable to the same duties, according to existing circumstances, as in the port or district established by law. Public notice of any such removal shall be given as soon as may be.

SEC. 4798. In case of the prevalence of a contagious or epidemic disease at the seat of Government, the President may permit and direct the removal of any or all the public offices to such other place or places as he shall deem most safe and convenient for conducting the public business.

SEC. 4799. Whenever, in the opinion of the Chief Justice, or, in case of his death or inability, of the senior associate justice, of the Supreme Court, a contagious or epidemic sickness shall render it hazardous to hold the next stated session of the court at the seat of Government, the chief or such associate justice may issue his order to the marshal of the Supreme Court, directing him to adjourn the next session of the court to such other place as such justice deems convenient. The marshal shall thereupon adjourn the court by making publication thereof in one or more public papers printed at the seat of Government from the time he shall receive such order until the time by law prescribed for commencing the session. The several circuit and district judges shall, respectively, under the same circumstances, have the same power, by the same means, to direct adjournments of the several circuit and district courts to some convenient place within their districts, respectively.

SEC. 4800. The judge of any district court within whose district any contagious or epidemic disease shall at any time prevail, so as, in his opinion, to endanger the lives of persons confined in the prison of such district, in pursuance of any law of the United States, may direct the marshal to cause the persons so confined to be removed to the next adjacent prison where such disease does not prevail, there to be confined until they may safely be removed back to the place of their first confinement. Such removals shall be at the expense of the United States.

SEC. 4263. The master of any vessel employed in transporting passengers between the United States and Europe is authorized to maintain good discipline and such habits of cleanliness among the passengers as will tend to the preservation and promotion of health, and to that end he shall cause such regulations as he may adopt for this purpose to be posted up, before sailing, on board such vessel, in a place accessible to such passengers, and shall keep the same so posted up during the voyage. Such master shall cause the apartments occupied by such passengers to be kept at all times in a clean, healthy state; and the owners of every such vessel so employed are required to construct the decks and all parts of the apartments so that they can be thoroughly cleansed, and also to provide a safe, convenient privy, or

water-closet, for the exclusive use of every one hundred such passengers. The master shall also, when the weather is such that the passengers can not be mustered on deck with their bedding, and at such other times as he may deem necessary, cause the deck occupied by such passengers to be cleansed with chlorid of lime or some other equally efficient disinfecting agent. And for each neglect or violation of any of the provisions of this section the master and owner of any such vessel shall be severally liable to the United States in a penalty of fifty dollars, to be recovered in any circuit or district court within the jurisdiction of which such vessel may arrive or from which she is about to depart, or at any place where the owner or master may be found.

[Extract from act August 1, 1888.]

Whenever any person shall trespass upon the grounds belonging to any quarantine reservation, such person, trespassing, shall, upon conviction thereof, pay a fine of not more than three hundred dollars, or be sentenced to imprisonment for a period of not more than thirty days, or shall be punished by both fine and imprisonment, at the discretion of the court. And it shall be the duty of the United States Attorney in the district where the misdemeanor shall have been committed to take immediate cognizance of the offence, upon report made to him by any medical officer of the Marine-Hospital Service, or by any officer of the customs service, or by any State officer acting under authority of section five of said act.

AN ACT TO PREVENT THE INTRODUCTION OF CONTAGIOUS DISEASES FROM ONE STATE TO ANOTHER AND FOR THE PUNISHMENT OF CERTAIN OFFENCES.

[Act March 27, 1890.]

Be it enacted by the Senate and House of Representatives of the United States of America in Congress assembled, That whenever it shall be made to appear to the satisfaction of the President that cholera, yellow fever, small-pox, or plague exists in any State or Territory, or in the District of Columbia, and that there is danger of the spread of such disease into other States, Territories, or the District of Columbia, he is hereby authorized to cause the Secretary of the Treasury to promulgate such rules and regulations as in his judgment may be necessary to prevent the spread of such disease from one State or Territory into another, or from any State or Territory into the District of Columbia, or from the District of Columbia into any State or territory, and to employ such inspectors and other persons as may be necessary to execute such regulations to prevent the spread of such disease. The said rules and regulations shall be prepared by the Supervising Surgeon-General of the Marine-Hospital Service under the direction of the Secre-

QUARANTINE LAWS OF THE UNITED STATES. 459

tary of the Treasury. And any person who shall willfully violate any rule or regulation so made and promulgated shall be deemed guilty of a misdemeanor, and upon conviction shall be punished by a fine of not more than five hundred dollars, or imprisonment for not more than two years, or both, in the discretion of the court.

SEC. 2. That any officer, or person acting as an officer, or agent of the United States at any quarantine station, or other person employed to aid in preventing the spread of such disease, who shall willfully violate any of the quarantine laws of the United States, or any of the rules and regulations made and promulgated by the Secretary of the Treasury as provided for in Section 1 of this act, or any lawful order of his superior officer or officers, shall be deemed guilty of a misdemeanor, and upon conviction shall be punished by a fine of not more than three hundred dollars or imprisonment for not more than one year, or both, in the discretion of the court.

SEC. 3. That when any common carrier or officer, agent, or employé of any common carrier shall willfully violate any of the quarantine laws of the United States, or the rules and regulations made and promulgated as provided for in Section 1 of this act, such common carrier, officer, agent, or employé shall be deemed guilty of a misdemeanor, and shall, on conviction, be punished by a fine of not more than five hundred dollars, or imprisonment for not more than two years, or both, in the discretion of the court.

AN ACT TO AMEND "AN ACT GRANTING ADDITIONAL QUARANTINE POWER AND IMPOSING ADDITIONAL DUTIES UPON THE MARINE HOSPITAL SERVICE," APPROVED FEBRUARY FIFTEENTH, EIGHTEEN HUNDRED AND NINETY-THREE.

[Act March 2, 1901.]

Be it enacted by the Senate and House of Representatives of the United States of America in Congress assembled, That an Act granting additional quarantine powers and imposing additional duties upon the Marine-Hospital Service, approved February fifteenth, eighteen hundred and ninety-three, be amended by addition of the following sections:

"SEC. 10. That the Supervising Surgeon-General, with the approval of the Secretary of the Treasury, is authorized to designate and mark the boundaries of the quarantine grounds and quarantine anchorages for vessels which are reserved for use at each United States quarantine station; and any vessel or officer of any vessel or other person, other than State or municipal health or quarantine officers, trespassing or otherwise entering upon such grounds or anchorages in disregard of the quarantine rules and regulations, or without permission of the officer in charge of such station, shall be deemed guilty of a misdemeanor and subject to arrest, and upon conviction thereof be punished by a fine of not more than three hundred dollars or imprisonment for

not more than one year, or both, in the discretion of the court. Any master or owner of any vessel, or any person violating any provision of this Act or any rule or regulation made in accordance with this Act, relating to inspection of vessels or relating to the prevention of the introduction of contagious or infectious diseases, or any master, owner, or agent of any vessel making a false statement relative to the sanitary condition of said vessel or its contents or as to the health of any passenger or person thereon, shall be deemed guilty of a misdemeanor and subject to arrest, and upon conviction thereof be punished by a fine of not more than five hundred dollars or imprisonment for not more than one year, or both, in the discretion of the court.

“SEC. 11. That any vessel sailing from any foreign port without the bill of health required by section two of this Act, and arriving within the limits of any collection district of the United States, and not entering or attempting to enter any port of the United States, shall be subject to such quarantine measures as shall be prescribed by regulations of the Secretary of the Treasury, and the cost of such measures shall be a lien on said vessel, to be recovered by proceedings in the proper district court of the United States and in the manner set forth above as regards vessels from foreign ports without bills of health and entering any port of the United States.

“SEC. 12. That the medical officers of the United States, duly clothed with authority to act as quarantine officers at any port or place within the United States, and when performing the said duties, are hereby authorized to take declarations and administer oaths in matters pertaining to the administration of the quarantine laws and regulations of the United States.”

QUARANTINE REGULATIONS.

QUARANTINABLE DISEASES.

1. For the purpose of these regulations the quarantinable diseases are cholera, yellow fever, small-pox, typhus fever, leprosy, and plague.

FOREIGN REGULATIONS.

Quarantine Regulations to be Observed at Foreign Ports and at Ports in the Possessions and Dependencies of the United States.

BILLS OF HEALTH.

2. Masters of vessels departing from any foreign port, or from any port in the possessions or other dependencies of the United States for a port in the United States or its possessions or other dependencies, must obtain a bill of health, in duplicate, signed by the proper officer or officers of the United States as provided for by law, except as provided for in paragraph 4.

The following form is prescribed :

QUARANTINE LAWS OF THE UNITED STATES. 461

[Form No. 1937.]

UNITED STATES BILL OF HEALTH.

Name of vessel, _____. Nationality, _____. Rig, _____. Master, _____.
 Tonnage, gross, _____; net, _____. Iron or wood. Number of compart-
 ments for cargo, _____; for steerage passengers, _____; for crew, _____.
 Name of medical officer, _____.
 Number of officers, _____.
 Number of members of officers' families, _____.
 Number of crew, including petty officers, _____.
 Number of passengers, cabin, _____.
 Number of passengers, steerage, _____.
 Number of persons on board, all told, _____.
 Port of departure, _____.
 Where last from, _____.
 Number of cases of sickness and character, during last voyage, _____.
 Vessel engaged in _____ trade, and plies between _____ and _____.
 Sanitary condition of vessel, _____.
 Nature, sanitary history, and condition of cargo, _____.
 Source and wholesomeness of water-supply, _____.
 Source and wholesomeness of food-supply, _____.
 Sanitary history and health of officers and crew, _____.
 Sanitary history and health of passengers, cabin, _____.
 Sanitary history and health of passengers, steerage, _____.
 Sanitary history and condition of their effects, _____.
 Prevailing diseases at port and vicinity, _____.
 Location of vessel while discharging and loading—open bay or wharf, _____.
 Number of cases and deaths from the following-named diseases during the
 past two weeks:

| Diseases. | No. of cases. | No. of deaths. |
|--|---------------|----------------|
| Yellow fever | _____ | _____ |
| Asiatic cholera | _____ | _____ |
| Cholera nostras or cholérine | _____ | _____ |
| Small-pox | _____ | _____ |
| Typhus fever | _____ | _____ |
| Plague | _____ | _____ |
| Leprosy | _____ | _____ |

Number of cases of sickness and character of same while vessel was in this
 port, _____.

Any conditions affecting the public health existing in the port of departure or
 vicinity to be here stated, _____.

I certify that the vessel has complied with the rules and regulations made
 under the act of February 15, 1893, and that the vessel leaves this port bound
 _____ for _____, U. S. of America, via _____.

Given under my hand and seal this _____ day of _____, 190 .
 (Signature of consular officer:) _____,

3. Vessels clearing from a foreign port or from any port in the possessions
 or other dependencies of the United States for any port in the United States,
 its possessions or other dependencies, and entering or calling at intermediate
 ports, must procure at all said ports a supplemental bill of health in duplicate
 signed by the proper officer or officers of the United States, as provided in the
 law. If a quarantinable disease has appeared on board the vessel after leaving
 the original port of departure, or other circumstances presumably render the
 vessel infected, the supplemental bill of health should be withheld until such
 sanitary measures have been taken as are necessary.

The following form is prescribed:

QUARANTINE.

SUPPLEMENTAL BILL OF HEALTH.

PORT OF _____.

Vessel _____, bound from _____ to _____, U. S. A.

Sanitary condition of port, _____.

State diseases prevailing at port and in surrounding country, _____.

Number of cases and the deaths from the following-named diseases during the past two weeks :

| Diseases. | No. of cases. | No. of deaths. | Remarks. (Any condition affecting the public health existing in the port to be stated here.) |
|--|---------------|----------------|---|
| Yellow fever . . . | | | |
| Asiatic cholera, cholera nostras, or cholera | | | |
| Small-pox | | | |
| Typhus fever | | | |
| Plague | | | |
| Leprosy | | | |

Number and sanitary condition of passengers and crew landed at this port.

Cabin, No. _____. Sanitary condition and history, _____.

Steerage, No. _____. Sanitary condition and history, _____.

Crew, No. _____. Sanitary condition and history, _____.

NOTE.—If disembarked on account of sickness, state disease, _____.

Number and sanitary condition of passengers and crew taken on at this port, and sanitary condition of effects.

Cabin, No. _____. Sanitary condition and history, _____.

Steerage, No. _____. Sanitary condition and history, _____.

Crew, No. _____. Sanitary condition and history, _____.

Sanitary condition of effects, _____.

Sanitary history of vessel since leaving last port.

(Cancel Form A, B, or C, as the case requires.)

Form.

A.—To the best of my knowledge and belief—

(Form A will be used at intermediate ports where the vessel does not enter and clear.)

B.—I have satisfied myself that—

(Form B will be used at intermediate ports where the vessel enters and clears.)

no quarantinable disease has appeared aboard since leaving _____.

C.—Since leaving _____ the following quarantinable disease has appeared on board _____, and I certify that the necessary sanitary measures have been taken.

I certify also that with reference to the passengers, effects, and cargo taken on at this port, the vessel has complied with the rules and regulations made under the act of February 15, 1893.

Given under my hand and seal this ____ day of _____, 190 .

(Signature of consular officer:) _____.

QUARANTINE LAWS OF THE UNITED STATES. 463

4. Under the act of Congress approved August 18, 1894, vessels plying between Canadian ports on the St. Croix River, the St. Lawrence River, the Niagara River, the Detroit River, the St. Clair River, and the St. Mary's River, and adjacent ports of the United States on the same waters; also vessels plying between Canadian ports on the following-named lakes, viz., Ontario, Erie, St. Clair, Huron, Superior, Rainy Lake, Lake of the Woods, and Lake Champlain, and ports in the United States; also vessels plying between Mexican ports on the Rio Grande River and adjacent ports in the United States, are exempt from the provisions of section 2 of the act granting additional quarantine powers and imposing additional duties upon the Marine-Hospital Service, approved February 15, 1893, which requires vessels clearing from a foreign port for a port in the United States to obtain from the consular or medical officer a bill of health. During the prevalence of any of the quarantinable diseases at the foreign port of departure, vessels above referred to are hereby required to obtain from the consular officer of the United States, or from the medical officer of the United States, when such officer has been detailed by the President for this purpose, a bill of health, or a supplemental bill of health, in duplicate, in the form prescribed by the Secretary of the Treasury.

INSPECTION OF VESSELS LEAVING FOREIGN PORTS AND PORTS IN THE POSSESSIONS OR OTHER DEPENDENCIES OF THE UNITED STATES FOR PORTS IN THE UNITED STATES OR ITS POSSESSIONS OR OTHER DEPENDENCIES.

5. The officer issuing the bill of health shall satisfy himself, by inspection, if necessary, that the conditions certified to therein are true, and is authorized, in accordance with the law, to withhold the bill of health or the supplemental bill of health until he is satisfied that the vessel, the passengers, the crew, and the cargo have complied with all the quarantine laws and regulations of the United States.

6. Inspection is required of—

(a) All vessels from ports at which cholera, yellow fever, or plague prevails, or at which small-pox or typhus fever prevails in epidemic form.

(b) All vessels carrying steerage passengers; but need only include the inspection of such passengers and their living apartments, if sailing from a healthy port.

7. Inspection of the vessel is such an examination of the vessel, cargo, passengers, crew, personal effects of same, including examination of manifests and other papers, food and water supply, the ascertainment of its relations with the shore, the manner of loading and possibilities of invasion by small animals as will enable the inspecting officer to determine if these regulations have been complied with.

8. When an inspection is required, it should be made by daylight, as late as practicable before sailing. The vessel should be inspected before the passengers go aboard, the passengers just before embarkation, and the crew on deck; and no communication should be had with the vessel after such inspection except by permission of the officer issuing the bill of health.

REQUIREMENTS WITH REGARD TO VESSELS.

9. Vessels, prior to storing cargo or receiving passengers, should be mechanically clean in all parts, especially the hold, forecastle, and steerage; the bilges and limbers free from odor and deposit. The air streaks should be sufficient in number and open for ventilation.

10. Any portions of the vessel liable to have been infected by any communicable disease should be disinfected before the issuance of the bill of health.

11. The air space, ventilation, food and water supply, hospital accommodations, and all other matters mentioned therein promotive of the health and comfort of the passengers must be in accordance with the provisions of the act of Congress approved August 2, 1882, entitled "An act to regulate the carriage of passengers by sea."

12. At ports where cholera prevails in epidemic form, special care should be taken to prevent the water and the food supply from being infected. The drinking-water should be boiled and the food thoroughly cooked and protected against contamination by flies, etc.

13. At ports where yellow fever prevails, in addition to the other measures presented hereafter, precautions should be taken to prevent the introduction of mosquitoes on board the vessel. Water tanks, water buckets, and other collections of water about the vessel should be guarded in such a manner that they shall not become breeding places for mosquitoes. Measures should also be taken to destroy mosquitoes that may have come on board. Baggage destined directly or indirectly for any State should be disinfected at the request of the health officer of said State. All baggage from such ports must be rigidly inspected and the exclusion of mosquitoes assured.

14. At ports or places where plague prevails, every precaution must be taken to prevent the vessel becoming infected through the agency of rats, ants, flies, fleas, or other animals. At such ports or places the vessel should not lie at a dock, or tie to the shore, or anchor near any place where such animals may gain access to the vessel. In case cables are led to the shore they should be freshly tarred and provided with inverted cones or such other devices as may prevent rats and other animals passing to the ship. The introduction of vermin on board the vessel from lighters and all other sources should be guarded against. In such

ports sulphur fumigation should be resorted to in the holds when empty and from time to time during loading in order to destroy vermin.

15. At all infected ports or places, communication between the vessel and shore should be reduced to a minimum.

16. Vessels carrying passengers from any port or place where quarantinable disease prevails in epidemic form should have one medical officer; and from ports where cholera or plague prevails in epidemic form should have two medical officers if more than 250 passengers are carried.

CARGO.

17. Earth, loam, soft or porous rock should not be taken as ballast at ports infected with cholera or plague. Street sweepings, city cleanings, or anything containing organic refuse should not be taken as ballast from any port. Where practicable, hard rock or clean beach sand or sea-water ballast should be given preference.

18. Household goods, personal effects, bedding, and second-hand articles generally, coming from a district known to be infected with cholera, small-pox, typhus fever, or plague, or as to the origin of which no positive evidence can be obtained, and which the consular or medical officer has reason to believe are infected, should be disinfected prior to shipment. Measures should be taken with articles of this class from districts infected with yellow fever to insure their freedom from mosquitoes.

19. New merchandise in general may be accepted for shipment without restriction, and articles of new merchandise—textile fabrics and the like—which have been packed or prepared for shipment in an infected port or place, with a special view to protect the same from moisture incident to the voyage, may be accepted and exempted from disinfection.

20. Certain food products, viz., unsalted meats, sausages, dressed poultry, fresh butter, fresh milk (unsterilized), fresh cheese, coming from cholera-infected localities or through such localities, if exposed to infection therein, should not be shipped. Fresh fruits and vegetables, from districts where cholera prevails, shall be shipped only under such sanitary supervision as will enable the inspector to certify that they have not been exposed to infection.

21. All rags and textile fabrics used in the manufacture of paper and for other purposes which are collected, packed, or handled in any foreign port or place, with the exceptions as hereinafter specified, shall, prior to shipment to the United States, be subjected to disinfection by one of the prescribed methods. (Jute bags or bagging used in baling cotton, old rope, new cotton, or linen cuttings from factories not included.) The disinfection of the articles mentioned above shall be performed under the supervision of a United States consul or a medical officer of the United States, and a certificate in duplicate, signed by said consul or

medical officer, shall be issued with each consignment of same, which certificate shall identify the articles and state that they have been disinfected in accordance with the United States quarantine regulations. The original certificate of disinfection shall be attached to the consignee's invoice, and where the articles are carried by sea the duplicate certificate of disinfection shall be attached to the bill of health issued to the vessel conveying the same.

Exceptions.—Such articles shipped from the Dominion of Canada directly to the United States shall be exempt from this requirement if accompanied by affidavits demonstrating to the satisfaction of the collector of customs at the port of arrival that they have actually originated in Canada and have not been shipped from a foreign country to Canada, and thence shipped to the United States; and further, that the port or place where collected or handled has been free from quarantinable disease for thirty days prior to shipment.

22. New feathers for bedding, human and other hair (unmanufactured), bristles, wool, hides not chemically cured, coming from a district where cholera or plague prevails, shall be refused entry into the United States until thirty days have elapsed since last exposure in case of cholera, and sixty days in case of plague, unless unpacked and disinfected. Feathers which have been used should be disinfected, and invariably by steam.

Bristles which have been boiled, and wool and new feathers which have been packed in naphthalin preparatory to shipment, may be shipped without further treatment.

Dry hides packed in naphthalin may be shipped as chemically cured hides.

Unsalted green hides from a district where cholera prevails must not be shipped.

23. The articles enumerated in the preceding paragraph coming from a district where small-pox, typhus fever, cholera, or plague prevails in epidemic form, should be refused shipment unless disinfected as hereinafter provided.

24. Nothing in these regulations shall be construed to modify or affect in any way any existing restrictions promulgated by the Secretary of the Treasury at the instance of the Bureau of Animal Industry, Department of Agriculture, regarding the importation of hides of neat cattle.

25. Any covering, shipped from or through an infected port or place, and which the consul or medical officer has reason to believe infected, should be disinfected.

26. Any article presumably infected, which cannot be disinfected, should not be shipped.

PASSENGERS AND CREW.

27. Passengers, for the purposes of these regulations, are divided into two classes, cabin and steerage.

28. When practicable, passengers should not ship from an infected port.

29. No person suffering from a quarantinable disease, or scarlet fever, measles, diphtheria, or other communicable disease, should be allowed to ship.

30. Steerage passengers and crew coming from cholera-infected districts should be detained five days in suitable houses or barracks located where there is no danger from infection, and all baggage disinfected.

31. Steerage passengers and crew from districts not infected with cholera, shipping at a port infected with cholera, unless passed through without danger of infection and no communication allowed between such persons and the infected locality, should be treated as those in the last paragraph.

32. Cabin passengers coming from cholera-infected districts embarking at a clean or an infected port should produce satisfactory evidence as to their exact places of abode during the five days immediately preceding embarkation. And if it appears that they or their baggage have been exposed to infection, the baggage should be disinfected and the passengers detained under medical supervision a sufficient time to cover the period of incubation since last exposure.

33. Steerage passengers and crew who, in the opinion of the inspecting officer, have been exposed to the infection of yellow fever, should be held under medical observation in a place free from danger of infection for a period of five days before embarkation.

34. Steerage passengers and crew, coming from districts where small-pox prevails in epidemic form, or who have been exposed to small-pox, should be vaccinated before embarkation, unless they show evidence of having acquired immunity to small-pox by previous attack or recent successful vaccination.

35. Steerage passengers and crew who, in the opinion of the inspecting officer, have been exposed to the infection of typhus fever, should not be allowed to embark for a period of at least twelve days after such exposure and the disinfection of their baggage.

36. Steerage passengers and crew who, in the opinion of the inspecting officer, have been exposed to the infection of plague should be held under medical observation in a place free from danger of infection for a period of seven days before embarkation, and their baggage disinfected.

37. Cabin passengers coming from plague-infected districts, whether embarking at a clean or an infected port, should produce satisfactory evidence as to their exact places of abode during the seven days immediately preceding embarkation. And if it

QUARANTINE.

| INSPECTION CARD. | | | |
|---|---|---|--|
| [Immigrants and steerage passengers.] | | | |
| Port of departure..... | | Date of departure..... | |
| Name of ship..... | | | |
| Name of immigrant..... | | Last permanent residence..... | |
| Inspected and passed at [Seal or stamp of consular medical officer.] | Passed at quarantine, port of, United States. [Date.] | Passed by Immigration Bureau, port of..... [Date.] | |
| [The following to be filled in by ship's surgeon or agent prior to or after embarkation.] | | | |
| Ship's list or manifest..... | | No. on ship's list or manifest..... | |
| Berth No. | Steam- ship inspec- tion. | 1st day. 1 2 3 4 5 6 7 8 9 10 11 12 13 14 | To be punched by ship's surgeon at daily inspec- tion. |

VACCINATED.

[Signature or Stamp.]

[REVERSE SIDE.]

Keep this Card to avoid detention at Quarantine and on Railroads in the United States.

Diese Karte muss aufbewahrt werden, um Aufenthalt an der Quarantäne, sowie auf den Eisenbahnen der Vereinigten Staaten zu vermeiden.

Cette carte doit être conservée pour éviter une détention à la Quarantine, ainsi que sur les chemins de fer des États-Unis.

Deze kaart moet bewaard worden, ten einde ophoud aan de Quarantijn, alsook op de ijzeren wegen der Vereenigde Staten te vermijden.

Conservate questo biglietto onde evitare detenzione alla Quarantina e sulle Ferrovie degli Stati Uniti.

Tento lístek musíte uschovati, nechcete-li ukarantény (zastavení ohledně zjištění zdraví) neb na dráze ve spojených státech zdržení byti.

Tuto kartocku treba trítat' u sebe aby sa predeslo zderzovanu v karantene aj na zeleznici ve Spojených Státoch.

appears that they or their baggage have been exposed to infection the baggage should be disinfected and the passengers detained under medical supervision a sufficient time to cover the period of incubation since last exposure.

38. Should quarantinable disease appear in the barracks or houses in which passengers are undergoing detention, no passenger from said houses or barracks who has been presumably exposed to this new infection should embark until after the expiration of the period of incubation of the disease in question subsequent to the last exposure to infection and the application of all necessary sanitary measures.

39. All baggage of steerage passengers destined for the United States should be labeled. If the baggage is in good sanitary condition, the label shall be a red label bearing the name of the port, the steamship on which the baggage is to be carried, the word "passed" in large type, the date of inspection, and the seal or stamp of the consular or medical officer of the United States. All baggage that has been disinfected shall bear a yellow label, upon which shall be printed the name of the port, the steamship upon which the baggage is to be carried, the word "disinfected" in large type, the date of disinfection, and the seal or stamp of the consular or medical officer of the United States. It is understood, and it will be so printed on the blank, that the label is not valid unless bearing the consular or medical officer's stamp or seal.

40. Each steerage passenger shall be furnished with an inspection card (see p. 468). This card, stamped by the consular or medical officer, is to be issued to every member of a family as well as to the head thereof.

41. In a port where any quarantinable disease prevails, the personnel of vessels should remain on board during their stay in such port.

42. Passengers and crews, merchandise and baggage, prior to shipment at a non-infected port, but coming from an infected locality, should be subject to the same restrictions as are imposed at an infected port.

RECORDS, REPORTS, ETC.

43. The officer making the inspection will preserve in his office a record of each inspection made and of each immunity certificate given; a copy of each certificate of disinfection and of each bill of health issued.

A weekly report of the transactions of his office shall be forwarded to the Surgeon-General at Washington, D. C.

44. In addition to the duties prescribed, the medical officer when detailed in accordance with the act of Congress approved February 15, 1893, shall furnish such reports to the Surgeon-General of the Public Health and Marine-Hospital Service as he may be able to make upon sanitary conditions and other matters affecting the public health and the welfare of the Service administration.

REQUIREMENTS AT SEA.¹

45. The master of a vessel should observe the following measures on board his vessel :

(a) The water-closets, fore-castle, bilges, and similar portions of the vessel liable to harbor infection should be disinfected and frequently cleansed.

(b) Free ventilation and rigorous cleanliness should be maintained in all portions of the ship during the voyage and measures taken to destroy rats, mice, fleas, flies, roaches, mosquitoes, and other vermin.

(c) A patient sick of a communicable disease should be isolated and one member of the crew detailed for his care and comfort, who, if practicable, should be immune to the disease.

(d) Communication between the patient or his nurse and other persons on board should be reduced to a minimum.

(e) Used clothing, body linen, and bedding of the patient and nurse should be immersed at once in boiling water or in a disinfecting solution.

(f) The compartment from which the patient was removed should be disinfected and thoroughly cleansed. Articles liable to convey infection should remain in the compartments during the disinfection when gaseous disinfection is used.

(g) Any person suffering from malaria or yellow fever should be kept under mosquito bars and the apartment in which he is confined closely screened with mosquito netting. All mosquitoes on board should be destroyed by burning pyrethrum powder (Persian insect powder) or by fumigation with sulphur. Mosquito larvæ (wigglers or wiggle-tails) should be destroyed in water-barrels, casks, and other collections of water about the vessel by the use of petroleum (kerosene); where this is not practicable, use mosquito netting to prevent the exit of mosquitoes from such breeding places.

(h) In the case of plague, special measures must be taken to destroy rats, mice, fleas, flies, ants, and other vermin on board.

(i) In the case of cholera, typhoid fever, or dysentery, the drinking water should be boiled and the food thoroughly cooked. The discharges from the patient should be immediately disinfected and thrown overboard.

46. An inspection of the vessel, including the steerage, should be made by the ship's physician once each day.

47. Should cholera, yellow fever, small-pox, typhus fever, plague, or any other communicable disease appear on board a ship while at sea, those who show symptoms of these diseases should be immediately isolated in a proper place; the ship's physician should then immediately notify the captain, who should

¹ These requirements at sea are largely advisory in character, but it is nevertheless true that a careful compliance with them should tend, at the port of arrival, to largely relieve the stringency of quarantine measures.

note same in his log, and all of the effects liable to convey infection which have been exposed to infection should be destroyed or disinfected.

48. The hospital should be disinfected as soon as it becomes vacant.

49. The dead should be enveloped in a sheet saturated with one of the strong disinfecting solutions, without previous washing of the body, and at once buried at sea or placed in a coffin hermetically sealed.

50. A complete clinical record should be kept by the ship's surgeon of all cases of sickness on board, and the record delivered to the quarantine officer at the port of arrival.

51. The following disinfecting solutions are recommended for use at sea :

FORMULAS FOR STRONG DISINFECTING SOLUTIONS.

Bichlorid of Mercury (1 : 500).

| | |
|--------------------------------|------------|
| Bichlorid of mercury | 1 part |
| Sea-water | 500 parts. |
| Mix. | |

Carbolic Acid (5 per cent.).

| | |
|--------------------------------|------------|
| Alcohol | 50 parts |
| Carbolic acid, pure | 50 parts |
| Mix. | |
| Then add fresh water | 900 parts. |

FORMULAS FOR WEAK SOLUTIONS.

Bichlorid of Mercury (1 : 1000).

| | |
|--------------------------------|-------------|
| Bichlorid of mercury | 1 part |
| Sea-water | 1000 parts. |

Carbolic Acid (2½ per cent.).

| | |
|-------------------------------|-------------|
| Carbolic acid, pure | 25 parts |
| Fresh water | 1000 parts. |

Formalin (5 per cent.).

| | |
|--------------------------------|------------|
| Formalin (or formol) | 50 parts |
| Water | 950 parts. |

It is suggested that a vessel should carry for every 100 passengers: Bichlorid of mercury, 5 pounds; carbolic acid, 10 pounds; alcohol, 10 pounds, and formalin, 10 pounds.

DOMESTIC REGULATIONS.

Quarantine Regulations to be Observed at Ports and on the Frontiers of the United States and its Possessions and Dependencies.

PREAMBLE.

52. At or convenient to the principal ports, quarantine stations should be equipped with all appliances for the inspection and treatment of vessels, their passengers, crews, and cargoes.

53. For all ports where such provisions have not been made, inspection stations should be maintained. An inspection service should be maintained for every port throughout the year.

54. At a fully equipped quarantine station there should be adequate provision for boarding and inspection, apparatus for mechanical cleansing of vessels, apparatus for disinfection by steam, by sulphur, by formaldehyd, by disinfecting solutions, or any other methods prescribed in these regulations; also a clinical laboratory, hospitals for contagious and doubtful cases, a steam laundry, detention barracks for suspects, bathing facilities, a crematory, a sufficient supply of good water, and a proper system for the disposal of sewage.

55. The personnel of quarantine stations in the yellow-fever zone and on fruiters and other vessels of regular lines bound for southern ports from ports where yellow fever prevails should be immune to yellow fever.

56. At quarantine stations all articles liable to convey infection should be handled only by the employees of said station unless the services of the crew of the vessel in quarantine are indispensable.

57. Vessels having been treated at national quarantine stations that are located a considerable distance from the ports of entry of said vessels may be inspected by the local quarantine officer, and if for any sanitary reason it is considered inadvisable to admit the vessel, he should report the facts immediately by telegraph, when possible, to the Surgeon-General of the Public Health and Marine-Hospital Service, detaining the vessel pending his action.

58. The following regulations are the required minimum standard and do not prevent the addition of such other rules as, for special reasons, may be legally made by State or local authorities.

INSPECTION.

59. Every vessel subject to quarantine inspection, entering a port of the United States, its possessions or dependencies, shall be considered in quarantine until given free pratique. Such vessel shall fly a yellow flag at the foremost head from sunrise to sunset, and shall observe all the other requirements of vessels actually quarantined.

60. Vessels arriving at ports of the United States under the following conditions shall be inspected by a quarantine officer prior to entry:

(a) All vessels from foreign ports except those enumerated in paragraph 4.

(b) Any vessel with sickness on board.

(c) Vessels from domestic ports where cholera, plague, or yellow fever prevails, or where small-pox or typhus fever prevails in epidemic form.

(d) Vessels from ports suspected of infection with yellow fever,

having entered a port north of the southern boundary of Maryland without disinfection, shall be subjected to a second inspection before entering any ports south of said latitude during the quarantine season of such port.

61. The inspections of vessels required by these regulations shall be made between sunrise and sunset, except in case of vessels in distress. Exception may also be made in the case of fruit vessels carrying perishable cargoes, and regular line vessels carrying passengers, under regulations approved by the Secretary of the Treasury.

62. In making the inspection of a vessel, the bill of health and clinical record of all cases treated during the voyage, crew and passengers' lists and manifests, and when necessary, the ship's log shall be examined. The crew and passengers shall be mustered and examined and compared with the lists and manifests and any discrepancies investigated. The clinical thermometer should be used in the examination of the personnel of vessels under suspicion. When a freight manifest shows that rags and other articles requiring disinfection under these regulations are carried by the vessel, a certificate of disinfection, signed by a United States consul or a medical officer of the United States, shall be exhibited and compared with same. If no certificate of disinfection is produced, the collector of customs at the port of entry shall be notified of same by the quarantine officer. The collector of customs shall then hold such consignment in a designated place separate from other freight pending the arrival of the certificate of disinfection; and in the event of its non-arrival, the articles shall be disinfected as hereinbefore prescribed, or shall be returned by the common carrier conveying same.

63. The medical officers of the United States, duly clothed with authority to act as quarantine officers at any port or place within the United States, and when performing the said duties, are hereby authorized to take declarations and administer oaths in matters pertaining to the administration of the quarantine laws and regulations of the United States. (Act of Mar. 2, 1901, sec. 12.)

64. No person, except the quarantine officer, his employees, United States customs officers, pilots, or other persons authorized by the quarantine officer, shall be permitted to board any vessel subject to quarantine inspection until after the vessel has been inspected by the quarantine officer and granted free pratique, and all such persons so boarding such vessel shall, in the discretion of the quarantine officer, be subject to the same restrictions as the personnel of the vessel.

65. Towboats or any other vessels having had communication with vessels subject to inspection shall themselves be subject to inspection.

66. After arrival at a quarantine station of a vessel carrying immigrants and upon which there has appeared during the last voyage a case of cholera, small-pox, typhus fever, or plague, and after quarantine measures provided by regulations of the Treasury

Department have been enforced and the vessel given free pratique, it is hereby ordered that notification of the above-mentioned facts be transmitted by the quarantine officer to the Commissioner of Immigration at the port of arrival, who shall be requested to transmit, by mail or telegraph, to the State health authorities of the several States to which immigrants from said vessel are destined, the date of departure, route, number of immigrants, and the point of destination in the respective States of the immigrants from said vessel, together with the statement that said immigrants are from a vessel which has been subject to quarantine by reason of infectious disease, naming the disease. This information is furnished to State health officers for the purpose of enabling them to maintain such surveillance over the arriving immigrants as they may deem necessary.

67. When a vessel arriving at quarantine has on board any of the communicable but unquarantinable diseases, the quarantine officer shall promptly inform the local health authorities of the existence of such disease aboard and shall make every effort to furnish such notification in ample time, if possible, to permit of the case being seen by the local authorities before discharge from the vessel.

QUARANTINE.

68. Vessels arriving under the following conditions shall be placed in quarantine:

(a) With quarantinable disease on board or having had such disease on board during the voyage.

(b) Any vessel which the quarantine officer considers infected.

(c) If arriving at a port south of the southern boundary of Maryland in the season of close quarantine, April 1 to November 1, directly or via a northern port, from a tropical American port, unless said port is known to be free from yellow fever.

(d) In the case of vessels arriving at a northern port without sickness on board from ports where yellow fever prevails, the personnel shall be detained under observation at quarantine to complete five days from the port of departure.

(e) Towboats and other vessels having had communication with vessels subject to quarantine shall themselves be quarantined if they have been exposed to infection.

69. Vessels arriving under the following conditions need not be subject to quarantine:

A. Vessels from yellow fever ports bound for ports in the United States north of the southern boundary of Maryland, with good sanitary condition and history, having had no sickness on board at ports of departure, en route or on arrival, provided they have been five days from last infected or suspected port.

B. Vessels engaged in the fruit trade may be admitted to entry without detention, provided that they have complied in all respects with the special rules and regulations made by the Secretary of the Treasury with regard to vessels engaged in said trade.

GENERAL REQUIREMENTS AT QUARANTINE.

70. Pilots will be detained in quarantine a sufficient time to cover the period of incubation of the disease for which the vessel is quarantined, if, in the opinion of the quarantine officer, such pilots have been exposed to infection. The dunnage of pilots shall be disinfected when necessary.

71. No direct communication shall be allowed between any vessel in quarantine and any person or place outside, and no communication whatever between quarantine or any vessel in quarantine and any person or place outside except under the supervision of the quarantine officer.

72. Street cleanings, street sweepings, or any other form of ballast containing organic refuse must be discharged at the quarantine station.

73. No presumably infected ballast shall be allowed to leave the quarantine station until disinfected.

74. After a vessel has been rendered free from infection, it may be furnished with a fresh crew and released from quarantine, while all or part of the personnel is detained. Under these circumstances the quarantine officer must exercise the greatest care that the vessel shall not become reinfected, especially by contact with persons in quarantine or infected objects.

75. Vessels detained at any national quarantine will be subject to such additional rules and regulations as may be promulgated from time to time by the Surgeon-General.

76. The form of certificate which shall be issued to a vessel by the health officer when he releases her from quarantine shall be prescribed by the Surgeon-General of the Public Health and Marine-Hospital Service, and shall embody the statement that the vessel has in all respects complied with the quarantine regulations prescribed by the Secretary of the Treasury, and that in the opinion of the quarantine officer she will not convey quarantinable disease, and that said vessel is granted free pratique to enter her port of destination, the name of which is to be embodied in the blank.

77. The persons detained shall be inspected by the physician twice daily, and be under his constant surveillance, and no intercourse will be allowed between different groups while in quarantine.

78. No articles from an infected vessel shall be carried into the place of detention until disinfected.

79. Cleanliness of quarters and of person shall be enjoined and daily enforced. Disinfection shall be practised where there is any possibility of infection.

80. The water and food supply shall be strictly guarded to prevent any contamination.

81. Water-closets, urinals, privies, or troughs shall be provided, and their contents disinfected before they are discharged.

82. In any group in which communicable disease appears, the sick will be immediately isolated in hospital, and the remaining

persons in the group and their effects appropriately treated and then removed to other quarters, if possible, and the compartments disinfected.

83. Communication between the physician and attendants of the hospital and those detained in other parts of the quarantine station shall be reduced to a minimum.

84. No convalescent shall be discharged from quarantine until after a sufficient time has elapsed to insure his freedom from infection, and this is to be determined by bacteriologic examination where possible.

85. No other person shall be discharged from quarantine until the period of incubation of the disease has elapsed since the last exposure to infection.

86. The body of no person dead of quarantinable disease shall be allowed to pass through quarantine until one year has elapsed since death. Such bodies must be transported in hermetically sealed coffins, the outsides of which have been carefully disinfected.

In the case of the bodies of such persons as may have died on the voyage or upon arrival at quarantine, cremation should be resorted to if practicable and consented to; if not, the body should be wrapped without preliminary washing in a sheet saturated with a solution of bichlorid of mercury 1 : 500 and buried, surrounded by caustic lime.

87. The quarantine officer shall report to the Secretary of the Treasury all violations of the quarantine laws. He should also report the facts in the case to the Surgeon-General of the Public Health and Marine-Hospital Service.

88. The quarantine officer shall report to the collector of customs any vessel which arrives without the bill of health hereinbefore prescribed.

89. All vessels requiring inspection under these regulations must present to the collector of customs at the port of entry the quarantine certificate above prescribed.

SPECIAL REGULATIONS ON ACCOUNT OF CHOLERA.

90. For the purpose of these regulations five days shall be considered as the period of incubation of cholera.

91. If the vessel carry persons from cholera-infected ports or places, a bacteriologic examination should be made of any cases of diarrhea to exclude cholera before granting free pratique.

92. If cholera has appeared on board, remove all passengers from the vessel and all of the crew, save those necessary to care for her; place the sick in hospital. Carefully isolate those especially suspected, and segregate the remainder in small groups. No communication should be held between these groups. Those believed to be especially capable of conveying infection must not enter the place of detention until they are bathed and furnished

with non-infected clothing ; nor shall any material capable of conveying infection be taken into the place of detention, especially food and water.

93. Water and food supply must be strictly guarded to prevent contamination, and issued to each group separately.

94. Food of a simple character, sufficient in quantity, thoroughly cooked, shall be issued to those detained in quarantine. No fruit or uncooked vegetables shall be permitted.

95. The greatest care must be exercised to prevent the spread of the infection through the agency of flies or other insects.

96. The dejecta from all persons in quarantine on account of cholera shall be disinfected before final disposition.

97. The water supply of the vessel, if suspected of infection, must be disinfected and then changed without delay ; the casks or tanks disinfected, and after thorough rinsing refilled from a source of undoubted purity, or the water furnished must have been recently boiled.

98. The baggage or effects of passengers and crew that may have been exposed to infection must be disinfected.

99. Articles of cargo which have been exposed to infection and are liable to convey the same must be disinfected.

100. Living apartments and their contents and such other portions of the vessel as have been exposed to infection must be disinfected.

101. Water ballast taken on at a cholera-infected port should be discharged at sea, or if discharged in fresh or brackish water, must previously be disinfected. Vessels arriving with water ballast presumably infected must return to sea under guard in order to discharge such ballast. If practicable, the tanks should be disinfected before being flushed, and refilled with sea-water.

SPECIAL REGULATIONS ON ACCOUNT OF YELLOW FEVER.

102. For the purpose of these regulations, five days shall be considered as the period of incubation of yellow fever.

103. Where practicable, remove the sick to hospital ; remove and isolate all persons not required for care of vessel.

104. For the destruction of mosquitoes there shall be a preliminary and simultaneous fumigation of all parts of the vessel by sulphur dioxid gas. In cabins containing articles liable to damage by sulphur dioxid, pyrethrum powder may be burned instead.

105. If, from the disposition of the cargo or any other reason, the previous fumigation is deemed not to have been effective, a complete fumigation is now to be done, simultaneously, of the whole vessel. Measures are in all cases to be taken to destroy larvæ of mosquitoes aboard.

106. The personnel of the vessel shall be detained five days from completion of disinfection, or if they have been removed

before disinfection of the vessel, their detention shall begin from last possible exposure to infection.

If cases of yellow fever have occurred aboard, the time of detention at stations south of the southern boundary of Maryland must be extended to six days.¹

107. If the vessel has in all respects complied with the quarantine regulations to be observed at foreign ports in such cases, and has been disinfected under the supervision of an accredited medical officer of the United States at the port of departure, she may, upon arrival at her port of destination in the United States, with good sanitary history and in good condition, be subject to the following treatment :

(a) If arriving in five days or less, she may be admitted to pratique after being fumigated again, but without further detention than is necessary to complete the five days from port of departure.

(b) If arriving after five days and within ten days, she may be immediately fumigated and admitted without detention.

(c) If arriving after a longer voyage than ten days, she shall be treated as if she had not been subjected to any previous treatment.²

108. Passenger traffic without detention may be allowed during the close quarantine season, May 1 to November 1, from ports infected with yellow fever to ports in the United States south of the southern boundary of Maryland under the following conditions :

(a) Vessels to be of iron or the best class of wooden vessels, and to be cleaned immediately prior to taking on passengers. The officer issuing the bill of health to these vessels shall withhold the same if the vessel is not in first-class sanitary condition and complying in every respect with the conditions stated in this paragraph.

(b) The vessel must lie at approved moorings in the open harbor ; must not approach the wharves, nor must the crew be allowed ashore at the port of departure. Every possible precaution must be taken to prevent the ingress of mosquitoes, and to provide for the destruction of these should they find ingress.

(c) All passengers and crew must be immune to yellow fever, and so certified by the United States medical officer.³

109. The disinfection of baggage for yellow fever is not required, but baggage destined directly or indirectly for any State shall be disinfected at the request of the health officer of said State. All baggage shall be inspected and the absence of mos-

¹ The period of incubation of yellow fever is not rarely over five days.

² If the vessel should have been in transit for a considerable number of days, it is obvious that a case of yellow fever may have occurred and recovered, leaving the vessel infected, and not affording any opportunity to the quarantine officer to determine same.

³ The evidence of immunity which may be accepted by the sanitary inspector is: First, proof of previous attack of yellow fever; second, proof of continued residence in an endemic focus of yellow fever for ten years.

QUARANTINE LAWS OF THE UNITED STATES. 479

quitoes definitely proved. The presence of any mosquitoes, regarding the infection of which the quarantine officer has doubts, shall be sufficient grounds for such further measures as the quarantine officer may deem justifiable.

SPECIAL REGULATIONS ON ACCOUNT OF SMALL-POX.

110. For the purpose of these regulations, fourteen days shall be considered as the period of incubation of small-pox.

111. On all vessels arriving with small-pox on board, or having had small-pox on board during the voyage, any of the personnel who have been exposed to the infection of the disease must be vaccinated or detained in quarantine not less than fourteen days, unless they show satisfactory evidence of recent successful vaccination or of having had small-pox.

112. Vessels arriving with small-pox on board which has been properly isolated and other sufficient precautions taken to prevent the spread of the disease need not be quarantined further than the removal of the sick, the disinfection of all compartments, baggage, and objects that have been exposed to the liability of infection, and such vaccination of the personnel as required in paragraph 111.

113. On vessels arriving with small-pox on board and where the proper isolation and other precautions have not been taken, all those whom the quarantine officer believes to have been exposed to the infection will be detained unless they have had small-pox or unless they show satisfactory signs of having been properly vaccinated within one year.

114. Living compartments and their contents or any other parts of the vessel exposed to the infection must be disinfected.

115. The baggage and effects of passengers and crew that have been exposed to the infection must be disinfected.

SPECIAL REGULATIONS ON ACCOUNT OF TYPHUS FEVER.

116. For the purpose of these regulations twelve days shall be considered as the period of incubation of typhus fever.

117. Vessels in otherwise good sanitary condition, but having typhus fever on board which has been properly isolated, need not be quarantined further than the removal of the sick, and disinfection of the compartments and their contents exposed to infection.

118. If the case has not been isolated, or the disease has spread on board from person to person, the vessel will be quarantined, the sick removed, and those who have been exposed to the infection detained under observation.

119. Vessels in bad sanitary condition, on which the disease has appeared, will be quarantined until thoroughly cleansed and disinfected throughout; the sick will be cared for at isolated hospitals, and those exposed to the infection detained under observation.

120. The baggage and effects of passengers and crew that have been exposed to the infection must be disinfected.

121. Living compartments and their contents, or any other parts of the vessel exposed to the infection must be disinfected.

SPECIAL REGULATIONS ON ACCOUNT OF LEPROSY.

122. Vessels arriving at quarantine with leprosy on board shall not be granted pratique until the leper with his or her baggage has been removed from the vessel to the quarantine station.

123. No alien leper shall be landed.

124. If the leper is an alien passenger and the vessel is from a foreign port, action will be taken as provided by the immigration laws and regulations of the United States. And to this end the case shall be certified as a leper and reported to the nearest commissioner of immigration.

125. If the leper is an alien and a member of the crew and the vessel is from a foreign port, said leper shall be detained at the quarantine at the vessel's expense until taken aboard by the same vessel when outward bound. Such case of leprosy should be promptly reported to the collector of customs at the port of arrival of the vessel, and the collector shall exact a bond from the vessel for the reshipment of the said alien leper upon the departure of the vessel.

SPECIAL REGULATIONS ON ACCOUNT OF PLAGUE.

126. For the purpose of these regulations seven days shall be considered as the period of incubation of plague.

127. In those actually exposed to the infection of plague the administration of antipest serum is regarded as a valuable prophylactic measure; for the prevention of the introduction of plague into a community liable to the introduction of plague through commercial intercourse, immunization by Haffkine's prophylactic is to be recommended.

128. Vessels infected with plague, or suspected of such infection, should be anchored at a sufficient distance from the shore or other vessels, to prevent the escape of rats by swimming.

129. In inspecting vessels from plague-infected ports, or vessels with plague on board at port of departure, en route or on arrival, the personnel of the vessel should be examined with special reference to the glandular regions, cervical, axillary, and inguinal, and for such examination as much clothing should be removed as may interfere with the thoroughness of the process. When possible, females should be examined by female inspectors.¹

¹ The examination herein provided being an exceedingly delicate matter, the greatest possible care is to be used by the quarantine officer to avoid any grounds for complaint of indecent exposure, and more particularly with regard to females.

QUARANTINE LAWS OF THE UNITED STATES. 481

130. In the inspection of vessels for plague, special attention must be directed to the discovery of cases of a mild type or of the pneumonic form of the disease. Suspected or doubtful cases should be subjected to bacteriologic examination before the vessel is released.

131. On all plague-infected vessels, any of the personnel of such vessels who, in the opinion of the quarantine officer, are infected or have been exposed to infection, shall be bathed and body clothing and hand baggage disinfected.

132. Nothing shall be thrown overboard from the vessel, not even deck sweepings. Such material shall be burned in the furnaces of a steamer, or in a place specially designated, but not in the galley.

133. Special precautions must be taken against rats, mice, ants, flies, fleas, and other animals, on account of the danger of the infection of the disease being spread through their agency.

134. As soon as practicable, there shall be a preliminary disinfection with sulphur dioxid for the purpose of killing rats and vermin, before further disinfecting processes are applied to the vessel and her cargo. The killing of any escaping rats shall be provided for by a water guard in small boats, and no person with abrasions or open sores should be employed in the handling of the vessel or her cargo.

135. The vessel shall be submitted to a simultaneous disinfection in all parts with sulphur dioxid to insure the destruction of rats and vermin. The rats shall be subsequently gathered and burned, due precautions being taken not to touch them with the bare hands, and the places where found disinfected with a germicidal solution; and the quarantine officer shall assure himself that the vessel is free of rats and vermin before granting free pratique.

136. Disinfection of vessels for plague shall be as follows:

With cargo: After twelve hours' exposure to sulphur dioxid, the upper 4- to 6-foot layer of cargo may be removed and placed on lighters exposed to the sun. This process of disinfection by night, and removal of successive layers of cargo by day, to be continued until hold is empty.

137. Vessels without cargo shall be disinfected by sulphur dioxid followed by germicidal solutions, in accordance with the general regulations for disinfection, paragraphs 156 to 185.

CANADIAN AND MEXICAN FRONTIERS.

138. When practicable, alien immigrants arriving at Canadian or Mexican ports destined for the United States, shall be inspected at the Canadian or Mexican port of arrival by the United States consular or medical officer, and be subjected to the same sanitary restrictions as are called for by the rules and regulations governing United States ports.

139. Inspection cards will be issued by the consular or United

States medical officer at the Canadian or Mexican port of arrival to all such alien immigrants, and labels affixed to their baggage, as is required at foreign ports in the case of those coming direct to any port of the United States.

140. If any person be found suffering from a quarantinable disease, or be presumably infected, he shall be denied entry or shall be kept under quarantine observation so long as danger of conveying the infection exists.

141. Any baggage or other effects believed to be infected shall be refused entry unless disinfected in accordance with these regulations.

142. Persons coming from localities where cholera is prevailing shall not be allowed entry until after five days have elapsed since last presumable exposure to infection, and their baggage disinfected.

143. During the quarantine season persons not positively identified as immune to yellow fever, coming from places where yellow fever prevails, will not be permitted to enter until they have been away from said localities five full days.

144. Persons coming from localities where small-pox is prevailing shall not be allowed entry without vaccination, unless they are protected by a previous attack of the disease or a recent successful vaccination. The baggage of persons from such localities shall be disinfected.

145. Persons coming from localities where typhus fever prevails in epidemic form shall not be allowed entry until twelve days have elapsed since their last possible exposure to infection and the disinfection of their baggage.

146. Persons coming from localities where plague is prevailing shall not be allowed entry until seven days have elapsed since their last possible exposure to infection and the disinfection of their baggage.

147. No common carrier which is infected, or suspected of being infected, shall be allowed to enter the United States until after such measures have been taken as will render it safe.

148. Articles of merchandise, personal effects, etc., which are presumably infected, shall not be allowed entry into the United States until after disinfection.

149. Rags gathered and baled in Canada, accompanied by affidavits that the ports or places where collected or handled were free from quarantinable disease for thirty days prior to shipment, may be admitted to entry; but rags from foreign ports shipped through Canada shall not be admitted to entry unless they are accompanied by a certificate of a United States consul or medical officer of the United States that they have been disinfected, or until after they have been unbaled and disinfected at the port of arrival.

150. Where not otherwise specifically stated, the rules and regulations for maritime quarantine shall be applied at stations on

QUARANTINE LAWS OF THE UNITED STATES. 483

the Canadian and Mexican frontiers ; and the methods of disinfections shall be those prescribed in these regulations.

SPECIAL REGULATIONS RELATING TO NAVAL VESSELS.

151. Vessels of the U. S. Navy may be granted the hereinafter stated exemptions from quarantine regulations, but are subject to quarantine inspection upon arrival at a port of the United States.

152. The certificates of the medical officers of the U. S. Navy as to the sanitary history and condition of the vessel and its personnel may be accepted for naval vessels by the quarantine officer boarding the vessel in lieu of an actual inspection.

153. Vessels of the U. S. Navy having entered the harbors of infected ports, but having held no communication which is liable to convey infection, may be exempted from the disinfection and detention imposed on merchant vessels from such ports.

INSPECTION OF STATE AND LOCAL QUARANTINES.

154. In the performance of the duties imposed upon him by the act of February 15, 1893, the Surgeon-General of the Public Health and Marine-Hospital Service shall, from time to time, personally or through a duly detailed officer of the Public Health and Marine-Hospital Service, inspect the maritime quarantines of the United States, State and local, as well as national, for the purpose of ascertaining whether the quarantine regulations prescribed by the Secretary of the Treasury have been or are being complied with. The Surgeon-General, or the officer detailed by him as inspector, shall, at his discretion, visit any incoming vessel or any vessel detained in quarantine, and all portions of the quarantine establishment, for the above-named purpose, and with a view to certifying, if need be, that the regulations have been or are being enforced.

155. The Surgeon-General of the Public Health and Marine-Hospital Service is authorized, when in his discretion such action is necessary in the interest of the Public Health, to remand, by direction of the Secretary of the Treasury, any vessel to the nearest national, State, or local quarantine station provided with proper facilities for handling infected vessels.

Disinfectants Authorized by these Regulations and the Proper Methods of Generating and Using Same.

PHYSICAL DISINFECTANTS.

156. Burning. Of unquestioned efficiency, but seldom required.

157. Boiling. Very efficient and of wide range of applicability. The articles must be wholly immersed for not less than thirty minutes in water actually boiling (100° C.). The addition

of 1 per cent. of carbonate of soda renders the process applicable to polished steel, cutting instruments or tools.

158. Steam.

(a) Flowing steam (not under pressure). Flowing steam (not under pressure) when applied under suitable conditions is an efficient disinfecting agent. The exposure must be continued thirty minutes after the temperature has reached 100°C .

(b) Steam under pressure without vacuum. Steam under pressure will sterilize, provided that the process is continued twenty minutes after the pressure reaches 15 pounds per square inch. The air must be expelled from the apparatus at the beginning of the process. If impracticable to obtain the designated pressure, a longer exposure will accomplish the same result.

(c) Steam under pressure with vacuum. Steam in a special apparatus with vacuum attachment is the best method of applying steam under pressure, the object of the vacuum apparatus being to expel the air and to promote the penetration of the steam. The process is to be continued for twenty minutes after the pressure reaches 10 pounds to the square inch.

GASEOUS DISINFECTANTS.

159. Sulphur dioxid. Sulphur dioxid is efficient, but requires the presence of moisture. It is only a surface disinfectant, and is lacking in penetrating properties. An atmosphere containing 4.5 per cent. can be obtained by burning 5 pounds of sulphur per 1000 cubic feet of space. This amount would require the evaporation or volatilization of about 1 pint of water. Under these conditions the time of exposure should be not less than twenty-four hours for bacterial infections. A shorter time will suffice for fumigation necessary to kill mosquitoes and other vermin.

160. The sulphur may be burned in shallow iron pots (Dutch ovens) containing not more than 30 pounds of sulphur for each pot, and the pots should stand in vessels of water. The sulphur pots should be elevated from the bottom of the compartment to be disinfected, in order to obtain the maximum possible percentage of combustion of sulphur. The sulphur should be in a state of fine division, and ignition is best accomplished by alcohol; special care to be taken with this method to prevent damage to cargo of vessel by fire; or the sulphur may be burned in a special furnace, the sulphur dioxid being distributed by a power fan. This method is peculiarly applicable to cargo vessels.

161. Liquefied sulphur dioxid may be used for disinfection in place of sulphur dioxid generated as above, it being borne in mind that this process will require 2 pounds of the liquefied gas for each pound of sulphur as indicated in the above paragraphs.

162. Sulphur dioxid is especially applicable to the holds of vessels, or to freight cars and apartments that may be tightly closed and which do not contain objects injured by the gas. Sulphur

dioxid bleaches fabrics or materials dyed with vegetable or anilin dyes. It destroys linen or cotton goods by rotting the fiber through the agency of the acids formed. It injures most metals. It is promptly destructive to all forms of animal life. This property renders it a valuable agent for the extermination of rats, insects, and other vermin.

FORMALDEHYD GAS.

163. Formaldehyd gas is effective if applied by one of the methods given below. Formaldehyd gas has the advantage as a disinfectant that it does not injure fabrics or most colors. It is not poisonous to the higher forms of animal life. It fails to kill vermin, such as rats, mice, roaches, bedbugs, etc. The method is not applicable to the holds of large vessels. Formaldehyd is applicable to the disinfection of rooms, clothing, and fabrics, but should not be depended upon for bedding, upholstered furniture, and the like, when deep penetration is required.¹

164. Many formaldehyd solutions do not contain 40 per cent. of formaldehyd, and all are apt to deteriorate with time. It is therefore necessary to use a quantity in excess of the amount prescribed in these regulations, unless the solution has been recently analyzed.

165. The following methods of evolving the gas may be used :

(a) Autoclave under pressure, three to twelve hours' exposure.

(b) Lamp or generator, six to eighteen hours' exposure.

(c) Spraying, twelve to twenty-four hours' exposure.

(d) Formaldehyd and dry heat in partial vacuum, one hour's exposure.

166. The minimum number of hours' exposure as given above applies to empty rooms of tight construction containing smooth, hard surfaces; the maximum number of hours' exposure applying in all cases to textiles and other articles of a similar kind requiring more or less penetration.

167. Autoclave under pressure. This method has considerable penetrating power when applied as detailed below. Rooms or apartments need no special preparation beyond the ordinary closing of doors and windows. Pasting, caulking, or chinking of ordinary cracks and crevices is not necessary. The doors of lockers and closets and the drawers of bureaus should be opened. In this apparatus use formalin (40 per cent.), with the addition of a neutral salt, such as calcium chlorid (20 per cent.). The gas must be evolved under a pressure not less than 45 pounds. After the gas is separated from its watery solution the pressure may be allowed to fall and steam projected into the compartment to supply the necessary moisture. Use not less than 10 ounces of formalin per 1000 cubic feet, and keep the room closed for three to twelve hours after the completion of the process. For large

¹ It should be noted that formaldehyd disinfection is more efficient in warm, moist, or still weather than in cold, dry, or windy weather.

rooms the gas must be introduced at several points as far apart as possible. It is applicable to the disinfection of clothing and fabrics suspended loosely in such a manner that every article is freely accessible to the gas from all directions.

168. Lamp or generator. This method requires an apparatus producing formaldehyd by a partial oxidation of wood alcohol, and in using it the room or apartment should be rendered tight as practicable. Oxidize 24 ounces of wood alcohol per 1000 cubic feet, and keep the room closed for six to eighteen hours, in accordance with the provisions of paragraph 165. This method leaves little or no odor. When applied to clothing and textiles, the articles should be suspended in a tight room and so disposed as to permit free access of the gas. (See also Par. 166.) The wood alcohol should be of 95 per cent. strength, and should not contain more than 5 per cent. of acetone.

169. Spraying. The formalin (40 per cent.) should be sprayed on sheets suspended in the room in such a manner that the solution remains in small drops on the sheet. Spray not less than 10 ounces of formalin (40 per cent.) for each 1000 cubic feet. Used in this way a sheet will hold about 5 ounces without dripping or the drops running together. The room must be very tightly sealed in disinfecting with this process, and kept closed not less than twelve hours. The method is limited to rooms or apartments not exceeding 2000 cubic feet. The formalin may also be sprayed upon the walls, floors, and objects in the rooms.

170. Formaldehyd with dry heat in partial vacuum. This method has superior penetrating powers, and is specially applicable to clothing and baggage. The requirements of this method are (1) dry heat of 60° C. sustained for one hour; (2) a vacuum of 15 inches; (3) formaldehyd evolved from a mixture of formalin with a neutral salt, in an autoclave under pressure, using not less than 30 ounces of formalin (40 per cent.) for 1000 cubic feet; and (4) a total exposure, under these combined conditions, of one hour.

171. The stated times of exposure to sulphur dioxid and formaldehyd are sufficient to destroy bacterial infection due to non-spore-bearing organisms, providing that the infection is present on the surface. If the room is of peculiar construction, so as to impede the diffusion of the gas, or if the room is a dirty one, or if on account of any other condition rendering the germicidal action of the gas more difficult, the time of exposure should be proportionately increased, or supplanted by other methods.

CHEMIC SOLUTIONS.

172. Bichlorid of mercury. Bichlorid of mercury is a disinfectant of undoubted potency and wide range of applicability. It cannot be depended upon to penetrate substances in the presence of albuminous matter. It should be used in solutions of 1 : 1000. The solubility of bichlorid of mercury may be increased

by using sea-water for the solution, or by adding 2 parts per 1000 of sodium or ammonium chlorid to the water employed.

173. Carbolic acid. Carbolic acid in the strength of 5 per cent. (see par. 51) may be substituted for the bichlorid of mercury, and should be employed in the disinfection of the cabins and living apartments of ships to obviate injurious action on polished metals, bright work, etc.

174. Formalin. Formalin containing 40 per cent. of formaldehyd may be used in a 5 per cent. solution as a substitute for bichlorid of mercury or carbolic acid, and is useful for the disinfection of surfaces, dejecta, fabrics, and a great variety of objects, owing to its non-injurious character.

Application of Disinfectants in Quarantine Work.

175. Holds of iron vessels, empty, shall be disinfected by either:
(a) Sulphur dioxid generated by burning sulphur 5 pounds per 1000 cubic feet of air-space, or liberated from 10 pounds of liquid sulphur dioxid, sufficient moisture being present in both cases; time of exposure, twenty-four hours. (See par. 159.)

(b) Washing with a solution of bichlorid of mercury, 1 : 1000.

176. Holds of wooden vessels, empty, shall be disinfected by:

(a) Sulphur dioxid in the manner prescribed above, followed by

(b) Washing with a solution of bichlorid of mercury.

177. In the case of all vessels, both iron and wooden, when treated for yellow fever or plague infection, the first process shall be a preliminary fumigation by sulphur dioxid in the manner previously stated in paragraphs 159, 160, in order to insure the destruction of mosquitoes, rats, and other vermin.

178. Holds of cargo vessels, when cargo cannot be removed, shall be disinfected in so far as possible by sulphur dioxid not less than 4 per cent. per volume strength, and where possible this should be generated from a furnace to minimize danger of fire in cargo.

179. Living apartments, cabins, and forecastles of vessels shall be disinfected by one or more of the following methods:

(a) Sulphur dioxid, the destructive action of the gas on property being borne in mind.

(b) Formaldehyd gas.

(c) Washing with solution of bichlorid of mercury, 1 : 1000 or 5 per cent. solution of formalin, or 5 per cent. solution of carbolic acid, preference being given to carbolic acid for application to polished woods, bright metals, and other objects injured by metallic salts.

The forecastle, steerage, and other living apartments in bad sanitary condition must be disinfected by method (a), followed by method (c).

180. Mattresses, pillows, and heavy fabrics are to be disinfected by:

- (a) Boiling.
- (b) Flowing steam—*i. e.*, steam not under pressure.
- (c) Steam under pressure.
- (d) Steam in a special apparatus with vacuum attachment.

181. Clothing, fabrics, textiles, curtains, hangings, etc., may be treated by either of the above methods from (a) to (d) inclusive, as circumstances may demand, or by formaldehyd gas or sulphur dioxid where the article is of a character which will not be damaged by sulphur dioxid.

182. Articles injured by steam, such as leather, furs, skins, rubber, trunks, valises, hats and caps, bound books, silks, and fine woollens should not be disinfected by steam. Such articles should be disinfected by formaldehyd gas or by any of the agents allowed in these regulations which may be applicable thereto. Those which will be injured by wetting should be disinfected by a gaseous agent.

183. Clothing, textiles, and baggage, clean and in good condition, but suspected of infection, can be efficiently and least injuriously disinfected by formaldehyd gas, generated by one of the methods prescribed in paragraph 165—(a), (b), or (d).

184. Textiles which are soiled with the discharges of the sick or presumably are deeply infected, must be disinfected by:

- (a) Boiling.
- (b) Steam.
- (c) Immersion in one of the germicidal solutions.

185. Cooking and eating utensils are always to be disinfected by immersion in boiling water or by steam.

SPECIAL QUARANTINE REGULATIONS FOR FRUIT VESSELS.

[1907, Department Circular No. 27. Bureau of P. H. and M. H. S.]

TREASURY DEPARTMENT, Office of the Secretary,
Washington, April 15, 1907.

To United States Consular Officers, Master and Owners of Vessels, Collectors of Customs, National, State, and Local Quarantine Officers, and others:

To permit vessels from foreign ports with perishable cargoes of fruit to enter southern ports in the United States, without detention, the following special regulations are promulgated, as provided in the general quarantine regulations of April, 1903, and will be enforced at the ports of departure and on arrival.

These regulations are a concession to vessels engaged in the fruit trade and contain provisions for the conduct of such trade with safety without injurious detention of the fruit at domestic quarantine stations. While the regulations are more stringent when yellow fever is reported at a fruit port, they do not impose

an embargo on the fruit traffic. The success of the regulations, however, depends upon reliable information as to health conditions and prompt knowledge of the first appearance and subsequent cases of yellow fever at any port. Therefore, the Department reserves the right, when satisfied that information is being denied or withheld, to recall from the port the medical officer detailed thereto by authority of the President. In this event the issue of the special certificate required by these regulations would be impossible, and fruit vessels from a port from which the medical officer has been recalled will be subject to the general quarantine regulations requiring disinfection at the domestic station and detention of personnel six days thereafter.

REGULATIONS TO BE ENFORCED AT FOREIGN PORTS SUSPECTED
OF BEING INFECTED WITH YELLOW FEVER.

1. None of the crew shall be allowed to go on land except the captain or his representative, or both when absolutely necessary, who shall go only to enter and clear the vessel, and only in the day time.
2. No one from the shore shall visit the vessel except the quarantine officers, custom officers, and agent of the ship.
3. All laborers who may be taken on the ship for loading purposes must have no intercourse with the shore subsequent to their entry upon the vessel until their final discharge therefrom.
4. No intercourse is to be allowed with persons on shore, except as provided in the preceding paragraphs. All fruit intended for shipment on vessels lying at docks shall be graded and payment made for the same on shore or dock ; such operations should not await the arrival of the fruit on shipboard. Fruit brought alongside by small boats or lighters shall be graded and necessary payment made over ship's side.
5. All passengers must embark from the regular ports and must have been under the observation of the sanitary inspector of the United States for at least three days prior to the departure of the ship, and be provided with his certificate to that effect. Where passengers come from elevated and noninfectible points in the interior to coast towns for embarkation, they should not be required to pass the three-day period of observation in the latter places because of possible danger of developing malarial or other tropical fevers. They should be required to bring a certificate from the United States consul, or a reliable physician, and the sanitary inspector shall satisfy himself that they have been at such elevated and noninfectible interior points for three days immediately preceding their arrival at coast towns.
6. Special attention should be paid to the sanitary condition and history of passengers arriving, directly or indirectly, from the Pacific coast towns of Central America.
7. All outgoing vessels must be provided with a bill of health

in accordance with the law, and, in addition thereto, certificates in duplicate, signed by the medical officer attached to the consulate, giving the name of the ship, her master, the number of crew, a list of passengers, their sanitary condition, their ultimate destination in the United States, and stating the health condition of the port and surrounding country, of the ship and her crew, with any other pertinent information; also certifying that the vessel has complied with all the requirements of this circular for the port of departure. This certificate shall be attached to the bill of health and the duplicate to the duplicate bill of health, and shall be the evidence of compliance with the above requirements on which the vessel, arriving with a good sanitary history and in good sanitary condition, may be admitted to entry, without the usual disinfection and detention in quarantine. Holds of such vessels should be disinfected with sulphur, after discharge of cargo, when deemed necessary.

REGULATIONS TO BE ENFORCED AT FOREIGN PORTS INFECTED
WITH YELLOW FEVER.

8. The foregoing rules and regulations shall apply also to vessels engaged in the fruit trade between foreign ports infected with yellow fever, or where yellow fever prevails, and ports of the United States, and are the special regulations provided for in paragraph 69, Exception B, of the quarantine regulations for domestic ports, April 1, 1903. Attention is called to the further requirement that these vessels shall carry no passengers, and also to the general regulations to be observed at all foreign ports where yellow fever prevails with regard to vessels leaving for the United States or its dependencies.

9. The vessel shall not lie where her crew will be exposed to the danger of contracting yellow fever, and at ports where the vessels lie at wharves the vessel must be moved into the stream or at least 200 meters from the wharf before sunset, and not returned to the wharf before sunrise the following day, except at ports where previous permission has been obtained from the Bureau.

10. Water tanks, water buckets, and other collections of water about the vessel must be guarded in such manner that they shall not become breeding places for mosquitoes. The destruction of mosquitoes aboard must be insured as far as possible by the simultaneous fumigation—2 pounds of sulphur per 1000 cubic feet, all openings closed for two hours—of all compartments which can be so treated without injury to the cargo. Pyrethrum powder, taking care to sweep up and destroy the mosquitoes, may be substituted in the engine room at the option of the medical officer.

11. The vessel should sail immediately after this fumigation is completed.

12. All baggage should be rigidly inspected and the exclusion of mosquitoes assured.

SPECIAL QUARANTINE REGULATIONS. 491

NOTE.—While the foregoing are specific regulations for fruit vessels, it should be borne in mind that they relate only to yellow fever, and that in the event of an outbreak of any other quarantinable disease at the port of departure, the general quarantine regulations for diseases other than yellow fever, approved April 1, 1903, should be enforced on these fruit vessels.

REGULATIONS TO BE ENFORCED AT SOUTHERN PORTS OF THE UNITED STATES.

13. Fruit vessels plying between United States ports and *fruit ports* where yellow fever is *known* to exist, will not be given pratique under the provisions of these special regulations until they have been not less than six days from the port of departure.

14. Whenever the master or agent of the vessel so desires, the following alternative to paragraph 13 is offered:

a. Fruit vessels from ports where yellow fever is known to exist will be permitted to enter as soon as the crew, except the master, first mate, and chief engineer, shall have been removed from the vessel and placed in quarantine at the station and the living quarters of the vessel thoroughly fumigated. The quarantine officer shall certify the number of the crew removed, and shall compare and verify the same with the bill of health of the vessel. The vessel may then be released and either towed to the city docks or a new crew will be permitted to be placed on board.

b. The new crew may either leave the ship at the dock or return with the vessel to the quarantine station, but if for any sanitary reason their detention on the vessel at the dock or return on the same vessel to the quarantine station should be deemed necessary by the quarantine officer or the Service representative in the city, such detention or return shall be required.

c. The crew detained at the quarantine station may be released at the expiration of six days from the infected port or six days from their last possible exposure to infection. If for any reason the quarantine officer deems it necessary to detain them longer, this may be done. After release the crew may be permitted to proceed to the city to rejoin their vessel, or rejoin the vessel at the station on her outward trip.

d. Immediately after unloading at the dock all parts of the vessel shall be simultaneously fumigated for the destruction of mosquitoes with 2 pounds of sulphur per 1000 cubic feet of space. After such fumigation lading for outgoing cargo may commence.

e. If the vessel departs without cargo, the vessel may be fumigated en route to quarantine.

f. Two sets of quarters must be maintained at the quarantine station, one for the crews of incoming vessels, and the other for such relief crews as may be employed by the companies, and both quarters shall be fumigated immediately after being vacated.

g. The requirements of these provisions, and each step and detail thereof, shall be certified by the proper quarantine officer before clearance papers are granted.

15. Fruit vessels without certificates of the United States sani-

tary inspectors at foreign ports shall be subject to the general quarantine regulations of the United States.

16. Persons exposed to infection in unloading cargo onto lighters shall be detained, after such exposure, as provided for other persons exposed to yellow fever.

17. Any officer of a fruit vessel detected in evading or violating these special regulations shall forfeit, for any vessel upon which he may subsequently be found, or be engaged, any participation in the special privileges accorded by these regulations.

18. Fruit vessels trading with any ports infected with yellow fever must carry a competent, qualified physician.

19. *Fruit vessels arriving with yellow fever on board, or having had yellow fever on board during the voyage*, shall be placed in quarantine. The personnel shall be removed, with the exception of the master, first mate, and engineer, the living apartments thoroughly disinfected, the vessel provided with a new crew sufficient to care for her, and towed, or proceed under her own steam, to the docks for discharge of cargo. All officers and crew shall be detained on board, under guard, until the completion of the discharge of cargo, while the vessel is at the dock and until the return of the vessel to the quarantine station. Immediately upon the completion of the discharge of cargo, the holds shall be fumigated with sulphur and the vessel shall be returned to the quarantine station and permitted to take on her crew before proceeding to sea.

20. This circular supersedes all previous Department circulars relating to special quarantine regulations for fruit vessels.

GEORGE B. CORTELYOU,
Secretary.

INTERSTATE QUARANTINE.

All interstate quarantine powers of the United States have also been conferred upon the Supervising Surgeon-General of the Marine-Hospital Service. The following is a transcript of the act of Congress conferring these powers and the interstate quarantine regulations:

[Act of March 27, 1890.]

An Act to prevent the introduction of contagious diseases from one State to another, and for the punishment of certain offences.

Be it enacted by the Senate and House of Representatives of the United States of America in Congress assembled, That whenever it shall be made to appear to the satisfaction of the President that cholera, yellow fever, small-pox, or plague exists in any State or territory, or in the District of Columbia, and that there is danger of the spread of such disease into other States, territories, or the District of Columbia, he is hereby authorized to cause the Secre-

INTERSTATE QUARANTINE REGULATIONS. 493

tary of the Treasury to promulgate such rules and regulations as in his judgment may be necessary to prevent the spread of such disease from one State or territory into another, or from any State or territory into the District of Columbia, or from the District of Columbia into any State or territory, and to employ such regulations to prevent the spread of such disease. The said rules and regulations shall be prepared by the Supervising Surgeon-General of the Marine-Hospital Service, under the direction of the Secretary of the Treasury. And any person who shall wilfully violate any rule or regulation so made and promulgated shall be deemed guilty of a misdemeanor, and upon conviction shall be punished by a fine of not more than five hundred dollars, or imprisonment for not more than two years, or both, in the discretion of the court.

SEC. 2. That any officer, or person acting as an officer, or agent of the United States at any quarantine station, or other person employed to aid in preventing the spread of such disease, who shall wilfully violate any of the quarantine laws of the United States, or any of the rules and regulations made and promulgated by the Secretary of the Treasury, as provided for in Section 1 of this act, or any lawful order of his superior officer or officers, shall be deemed guilty of a misdemeanor, and upon conviction shall be punished by a fine of not more than three hundred dollars, or imprisonment for not more than one year, or both, in the discretion of the court.

SEC. 3. That when a common carrier, or officer, agent, or employé of any common carrier, shall wilfully violate any of the quarantine laws of the United States, or the rules and regulations made and promulgated as provided for in Section 1 of this act, such common carrier, officer, agent, or employé shall be deemed guilty of a misdemeanor, and shall, on conviction, be punished by a fine of not more than five hundred dollars, or imprisonment for not more than two years, or both, in the discretion of the court.

INTERSTATE QUARANTINE REGULATIONS.

ARTICLE I.

QUARANTINABLE DISEASES.

(1) For the purposes of these regulations the quarantinable diseases are cholera (cholerae), yellow fever, small-pox, typhus fever, leprosy, and plague.

ARTICLE II.

NOTIFICATION.

(1) State and municipal health officers should immediately notify the Supervising Surgeon-General of the U. S. Marine-Hos-

pital Service by telegraph or by letter of the existence of any of the above-mentioned quarantinable diseases in their respective States or localities.

ARTICLE III.

GENERAL REGULATIONS.

(1) Persons suffering from a quarantinable disease shall be isolated until no longer capable of transmitting the disease to others. Persons exposed to the infection of a quarantinable disease shall be isolated, under observation, for such a period of time as may be necessary to demonstrate their freedom from the disease.

All articles pertaining to such persons, liable to convey infection, shall be disinfected as hereinafter provided.

(2) The apartments occupied by persons suffering from quarantinable disease, and adjoining apartments when deemed infected, together with articles therein, shall be disinfected upon the termination of the disease.

(3) Communication shall not be held with the above-named persons and apartments, except under the direction of a duly qualified officer.

(4) All cases of quarantinable disease, and all cases suspected of belonging to this class, shall be at once reported by the physician in attendance to the proper authorities.

(5) No common carrier shall accept for transportation any person suffering with a quarantinable disease, nor any infected article of clothing, bedding, or personal property.

The body of any person who has died of a quarantinable disease shall not be transported save in hermetically sealed coffins, and by the order of the State or local health officer.

(6) In the event of the prevalence of small-pox, all persons exposed to the infection, who are not protected by vaccination or a previous attack of the disease, shall be at once vaccinated or isolated for a period of fourteen days.

(7) During the prevalence of cholera all the dejecta of cholera patients shall be at once disinfected as hereinafter provided, to prevent possible contamination of the food- and water-supply.

ARTICLE IV.

YELLOW FEVER.

In addition to the foregoing regulations contained in Article III. the following special provisions are made with regard to the prevention of the introduction and spread of yellow fever:

(1) Localities infected with yellow fever, and localities contiguous thereto, should be depopulated as rapidly and as completely as possible, so far as the same can be safely done; persons from non-infected localities and who have not been exposed to infection being allowed to leave without detention. Those who have been exposed, or who come from infected localities, shall be re-

INTERSTATE QUARANTINE REGULATIONS. 495

quired to undergo a period of detention and observation of ten days from the date of last exposure in a camp of probation or other designated place.

Clothing and other articles capable of conveying infection shall not be transported to non-infected localities without disinfection.

(2) Persons who have been exposed may be permitted to proceed without detention to localities incapable of becoming infected and whose authorities are willing to receive them and after arrangements have been perfected, to the satisfaction of the proper health officer, for their detention in said localities for a period of ten days.

(3) The suspects who are isolated under the provisions of paragraph 1, Article III., shall be kept free from all possibility of infection.

(4) So far as possible, the sick should be removed to a central location for treatment.

(5) Buildings in which yellow fever has occurred, and localities believed to be infected with said disease, must be disinfected as thoroughly as possible.

(6) As soon as the disease becomes epidemic the railroad trains carrying persons allowed to depart from a city or place infected with yellow fever shall be under medical supervision.

(7) Common carriers from the infected districts, or believed to be carrying persons and effects capable of conveying infection, shall be subject to a sanitary inspection, and such persons and effects shall not be allowed to proceed, except as provided for by paragraph 2.

(8) At the close of an epidemic the houses where sickness has occurred, and the contents of the same, and houses and contents that are presumably infected, shall be disinfected as hereinafter prescribed.

ARTICLE V.

DISINFECTION.

FOR CHOLERA.

(1) The dejecta and vomited matters of cholera patients shall be received into vessels containing an acid solution of bichlorid of mercury (bichlorid of mercury, 1 part; hydrochloric acid, 2 parts; water, 1000 parts) or other efficient germicidal agent.

(2) All bedding, clothing, and wearing apparel soiled by the discharges of cholera patients shall be disinfected by one or more of the following methods:

(a) By complete immersion for thirty minutes in one of the above-named disinfecting solutions.

(b) By boiling for fifteen minutes; all articles to be completely submerged.

(c) By exposure to steam at a temperature of 100° to 102° C. for thirty minutes after such temperature is reached.

(3) Any woodwork or furniture contaminated by cholera discharges shall be disinfected by thorough washing with a germicidal solution, as provided in paragraph 1, Article III.

FOR YELLOW FEVER.

(4) Apartments infected by occupancy of patients sick with yellow fever shall be disinfected by one or more of the following methods:

(a) By thorough washing with one of the above-named germicidal solutions. If apprehension is felt as to the poisonous effects of the mercury, the surfaces may, after two hours, be washed with clear water.

(b) Thorough washing with a 5 per cent. solution of pure carbolic acid.

(c) By sulphur dioxid, twenty-four to forty-eight hours' exposure, the apartments to be rendered as air-tight as possible.

(5) Bedding, wearing apparel, carpets, hangings, and draperies infected by yellow fever shall be disinfected by one of the following methods:

(a) By exposure to steam at a temperature of 100° to 102° C. for thirty minutes after such temperature is reached.

(b) By boiling for fifteen minutes; all articles to be completely submerged.

(c) By thorough saturation in a solution of bichlorid of mercury 1 : 1000, the articles being allowed to dry before washing.

Articles injured by steam (rubber, leather, containers, etc.), to the disinfection of which steam is inapplicable, shall be disinfected by thoroughly wetting all surfaces with (a) a solution of bichlorid of mercury 1 : 800, or (b) a 5 per cent. solution of carbolic acid, the articles being allowed to dry in the open air prior to being washed with water, or (c) by exposure to sulphur fumigation in an apartment air-tight, or as nearly so as possible.

FOR SMALL-POX.

(6) Apartments infected by small-pox shall be disinfected by one or both of the following methods:

(a) Exposure to sulphur dioxid for twenty-four to forty-eight hours.

(b) Washing with a solution of bichlorid of mercury, 1 : 1000, or a 5 per cent. solution of pure carbolic acid.

(7) Clothing, bedding, and articles of furniture exposed to the infection of small-pox shall be disinfected by one or more of the following methods:

(a) Exposure to sulphur dioxid for twenty-four to forty-eight hours.

(b) Immersion in a solution of bichlorid of mercury, 1 : 1000, or 5 per cent. solution of pure carbolic acid.

INTERSTATE QUARANTINE REGULATIONS. 497

(c) Exposure to steam at a temperature of 100° to 102° C. for thirty minutes after such temperature is reached.

(d) Boiling for fifteen minutes; the articles to be completely submerged.

FOR TYPHUS FEVER.

(8) Apartments infected by typhus fever shall be disinfected by one or both of the following methods:

(a) Exposure to sulphur dioxide for twenty-four to forty-eight hours.

(b) Washing with a solution of bichlorid of mercury, 1:1000, or a 5 per cent. solution of pure carbolic acid.

(9) Clothing, bedding, and articles of furniture exposed to the infection of typhus fever shall be disinfected by one or more of the following methods:

(a) Exposure to sulphur dioxide for twenty-four to forty-eight hours.

(b) Immersion in a solution of bichlorid of mercury, 1:1000, or a 5 per cent. solution of pure carbolic acid.

(c) Exposure to steam at a temperature of 100° to 102° C. for thirty minutes after such temperature is reached.

(d) Boiling for fifteen minutes; the articles to be completely submerged.

INTERSTATE QUARANTINE REGULATIONS TO PREVENT THE SPREAD OF PLAGUE IN THE UNITED STATES.

In accordance with the provisions of the act of March 27, 1890, the following regulations, additional to existing interstate quarantine regulations, are hereby promulgated to prevent the introduction of plague into any one State or territory or the District of Columbia, from another State or territory or the District of Columbia:

1. During the existence of plague at any point in the United States the Surgeon-General of the Marine-Hospital Service is authorized to forbid the sale or donation of transportation by common carrier to Asiatics or other races particularly liable to the disease.

2. No common carrier shall accept for transportation any person suffering with plague or any article infected therewith, nor shall common carriers accept for transportation any class of persons who may be designated by the Surgeon-General of the Marine-Hospital Service as being likely to convey the risk of plague contagion to other communities, and said common carriers shall be subject to inspection.

3. The body of any person who has died of plague shall not be transported except in an hermetically sealed coffin and by consent of the local health office, in addition to the local representatives of the Marine-Hospital Service. Wherever possible, such bodies should be cremated.

STATE QUARANTINE REGULATIONS.

Many of the seaboard States of the Union have quarantine boards and stations in addition to those of the national government. In 1893 the legislature of Pennsylvania passed a law establishing the State Quarantine Board for the Port of Philadelphia.

As early as 1708, "An act to prevent sickly vessels coming into this government" was passed by the colonial assembly, prohibiting every unhealthy or sickly ship from an unhealthy or sickly place from coming nearer than one mile to any of the towns or ports of the province or territories without clean bills of health. This act remained in force until January 22, 1744. About the year 1742 a quarantine station was located at Fisher's Island, subsequently called Province, and State Island. In 1749 the trustees of Province Island were directed to build an hospital or pest-house for the reception of strangers imported into the province. During the period of the revolutionary war commerce had so dwindled that there was very little necessity for a quarantine station. The hospital, however, was used for the care of sick persons sent from army boats.

The invasion of yellow fever was instrumental in causing an order to be given for the repairment of the hospital upon State Island for the admission of patients and the appointment of a resident physician. A resident physician was appointed at the hospital, and vessels coming up the river were ordered to anchor for a visit.

In 1799 the quarantine station was located at Tinicum Island, and the removal took place in 1801, at which place it was maintained until 1895, when it was removed to Marcus Hook, its present location. The service at State station, because of the two national quarantine stations (Cape Henlopen and Reedy Island), is, for the present, one of observation or inspection only, there being no provision for detention or disinfection. If sickness of a communicable nature is discovered on a

vessel, or if circumstances lead to the suspicion that the vessel herself is infected, she is simply remanded to the Federal quarantine station.

The right to quarantine resides with the individual States, though the Federal government has the right to control in such matters through its right to regulate interstate commerce. It should have control of the matter of inland quarantine to the extent of directing and superintending the measures adopted, in order to prevent the confusion arising from conflicting regulations of the authorities of adjacent localities. In order to secure more uniformity in the measures adopted, Congress has been petitioned time and again to pass a law providing for the organization of a National Board of Health.

The regulations of the various State boards of health are directed toward the prevention of the introduction of infectious individuals and materials from other States or countries and toward the control of infection within the borders of the State.

Notwithstanding the fact that the national government has taken over a number of the State quarantine stations along the seaboard, several of the States still maintain inspection and quarantine stations at ports of entry, namely: California, Connecticut, Delaware, Georgia, Indiana, Kentucky, Maine, Maryland, Massachusetts, Michigan, New Hampshire, New Jersey, New York, Ohio, Oregon, Pennsylvania, and Texas.

The institution of quarantine by one State against a neighboring State is specifically provided for in the laws of California, Connecticut, Georgia, Indiana, Illinois, Kansas, Kentucky, Louisiana, Maine, Maryland, Massachusetts, Michigan, Minnesota, Mississippi, Missouri, Nebraska, New Hampshire, New Jersey, New Mexico, North Carolina, Ohio, Oklahoma, Oregon, Pennsylvania, Tennessee, Virginia, West Virginia, and Wyoming.

In recent years these interstate quarantine laws have rarely been required to control any infectious disease,

because, in most States, the local quarantine regulations have been sufficient to keep infectious diseases under control.

House Quarantine.—The diseases against which house quarantine is directed differ in different State laws, some requiring modified quarantine in some diseases and in others simply a reporting of the diseases and placarding of the houses. Strict quarantine is maintained by all the States against small-pox, scarlet fever, and diphtheria. Many of the States include in this list Asiatic cholera, yellow fever, typhus fever, and bubonic plague.

With regard to many of the other communicable diseases, practices differ very much. The following diseases are reportable in most of the States: Measles, typhoid fever, epidemic cerebrospinal meningitis, tuberculosis, and leprosy. In the following diseases placarding is usually required, or a modified quarantine is instituted, namely: Whooping-cough, mumps, chicken-pox, and German measles. In addition, the following diseases are reportable in some of the States: Epidemic dysentery, dengue, anthrax, glanders, pneumonia, tetanus and relapsing fever, and puerperal fever. In the regulations of many of the States membranous croup is classified under diphtheria, and the regulations that pertain to diphtheria are applied to cases of so-called membranous croup. Likewise, in Pennsylvania and California, Cuban or Manila itch are reportable. In addition to this, actinomycosis is reportable in Pennsylvania, hydrophobia in Louisiana, ophthalmia neonatorum in Nebraska and New York, uncinariasis in California, and erysipelas in Pennsylvania. All of the States require the reporting of anterior poliomyelitis.

House quarantine differs considerably in different States and cities. The statutes of New York define as quarantinable "yellow fever, measles, cholera, typhus fever, small-pox, scarlet fever, diphtheria, relapsing fever, and any disease of a contagious, infectious, or pestilential

character, which shall be considered by the health officer dangerous to the public health."

In New York City every case of contagious disease reported to the health department is regularly inspected by the medical inspector assigned to the district in which it occurs. When consent can be obtained, the cases are removed to the department hospitals. In the tenement-house districts an effort is always made to induce patients suffering from such diseases to enter the hospitals, and, if the conditions are such as to require it, removal to the hospitals is enforced. After completion of the illness or transfer of the patient, thorough disinfection is made of the house or apartment, and all infected materials are removed to the disinfecting station for destruction or disinfection by steam, when they are returned to the owner. No charge is made for these services, and disinfection is compulsory in every case. The practice in Philadelphia and other large cities is quite similar to that in New York.

The infectious diseases in which notification is compulsory in Philadelphia are: Cholera, small-pox, diphtheria, diphtheritic croup, membranous croup, scarlet fever, typhoid fever, typhus fever, epidemic cerebrospinal fever, relapsing fever, and leprosy. Knowledge of cases of diphtheria reaches the department of health through the forwarding of a culture to the bacteriologic laboratory for examination, as well as by notification by the physician. If, on examination, the culture is found to contain diphtheria bacilli, the case is at once reported to the medical inspector, at the same time that a report is forwarded to the attending physician. In this manner doubtful cases are diagnosed early, and no hardships are entailed upon the suspect or the family, while the community is protected by prompt isolation of all such cases. The contagious character of tuberculosis in all its forms is becoming more and more generally recognized. Nevertheless there is strenuous opposition from many sources to the notification of cases of tuberculosis. In New

York and Philadelphia such notification is now required, not with the idea of quarantining the cases, but in order to keep informed as to their location, and to make it possible to direct approved prophylactic measures against the spread of the disease from the sick to the well. No general disinfection of the premises occupied by cases of tuberculosis in the tenement district is attempted. On the other hand, all such premises are thoroughly renovated after the removal or death of the tubercular patient. In this manner the danger from infection through infective dust is greatly lessened. The work of the department is hampered, however, because of the absence of sufficient hospital accommodations for consumptive poor. Most beneficial effects have, however, already resulted from the various measures instituted for the prevention of tuberculosis, as shown in the very material decline in the number of deaths occurring from it.

The investigations of Anders and of Flick, of Philadelphia, and those of Biggs, of New York, show that tuberculosis is not uniformly diffused through a community, not even in those localities where it occurs most frequently, but is confined largely within narrow boundaries, as in certain streets and within the walls of certain houses. These investigations have shown that when a house is once infected, repeated cases are developed in it from the new tenants occupying such a house. These infected houses are most frequently found in the narrower streets, in courts, and in alleys. Though there is some danger of infection from the inhalation of dust in the open air in crowded parts of the city, it seems probable that a more prolonged exposure to a concentrated atmosphere of infection, as found in these infected houses, is the most frequent mode of contracting the disease. The dust in street-cars and various public places is often infected, and may lead to contraction of the disease. The prohibition of spitting on the floor of cars, ferry-boats, and other public conveyances should, therefore, be strictly enforced as a wise sanitary measure.

CHAPTER XX.

VITAL STATISTICS.

VITAL statistics includes the records of all circumstances affecting the production and duration of human life, and corresponds to the term "démographie" employed by French writers. The registration of vital statistics includes the obtaining of records of births, deaths, marriages, and disease. The comparison of these records with each other, and with the statistics of the living population, comprises vital statistics proper.

The systems of registration employed by different States and cities differ as to details. They include a periodical report of the births, with date and place of birth, sex, color, and nationality of the child, and the names, residence, birthplace, age, and occupation of the parents. These reports are usually made monthly by the physician to the health bureau of the city. Deaths are reported through the physician and undertaker to the health authorities, who issue a burial permit. The information furnished on the death certificate includes the age, sex, color, nationality, and conjugal condition of the deceased, as well as the immediate and remote causes of death. In the United States the physician acts in a judicial capacity in reporting a death. Upon this fact is based the right of legislation regulating the education and qualification of medical men and the laws regulating the practice of medicine. He is a State officer in relation to his knowledge of the cause of death.

The cases of infectious diseases are reported at once by the physician when the diagnosis has established the nature of the disease. Up to the present time only a few States have had an accurate system of registration. With the beginning of the twentieth century a number

of States and cities, as well as a large number of other countries, will adopt a uniform system of classification of the causes of death, known as the Bertillon system. This system has been adopted generally after repeated conferences extending over a number of years. Dr. Bertillon presented his system of classification to the International Statistical Institute at Chicago in 1893. It has since received the endorsement of the American Public Health Association, the International Conference of State and Provincial Boards of Health of North America, and received its first International Decennial Revision at Paris in 1900. By the use of this uniform system of classification the vital statistics of different countries will be readily comparable. It is safe to presume that the general adoption of such a uniform system of classification, with decennial revisions of the same by those using it, will lead to more efficient registration methods wherever the system is employed. Full information as to the details of the Bertillon system of classification may be found in the publications of the American Public Health Association, of the Michigan Division of Vital Statistics, and the United States Marine-Hospital Service. Requiring a permit for burial is the only reliable means of obtaining the desired information. This is necessary to secure a proper inheritance of property. It also aids in detecting crime.

By means of an accurate system of registration a community is able to keep informed as to the condition of the public health, the efficiency of quarantine measures, the purity of the water-supply, and the death-rate from all diseases. The value of estimates made from vital statistics as reported to the health authorities is dependent upon a knowledge of the living population. In most countries this is determined decennially by means of a national census. Some cities have an additional census taken midway between the decennial censuses. In the absence of such special censuses the calculations are based on the results of the decennial censuses. The

Registrar-General of Scotland employs the following method for calculating the population for the inter-census years: He assumes that the rate of increase as ascertained from the two enumerations immediately preceding continues the same during the course of the next ten years. The sanitary department of Glasgow ascertains the number of houses inhabited by the census population, the average population per house, and then in each succeeding inter-census year applies this average as a multiplier to the inhabited houses for the year, as entered upon the rolls of the assessor. Neither of these methods gives accurate results. Since population increases in geometric proportion, the arithmetical mean may be taken between two censuses. The result will generally be less than normal, but will not vary more than 1 per 1000 in the death-rate as calculated from these data as compared with the results obtained from actual enumerations.

The Census as a Basis for Calculation.—It is essential, therefore, that an accurate census of the population be taken at stated intervals to form the basis of calculation of the results obtained from registrations of births, deaths, marriages, and disease. The density of population, or the number of persons occupying a definite area, is also of value, and this is obtained by dividing the population by the area in square meters, square miles, or in acres.

Standards of Age-distribution.—In order to make it possible to secure fair comparisons of the death-rates of different places, a uniform standard should be adopted to which all populations may be referred, or with which they may be compared. The committee on nomenclature of the American Public Health Association, in its report for 1895, states that, other things being equal, a city in which the persons living under one year of age, and those who are more than fifty years of age, constitute together more than 15 per cent. of the population, will have a higher death-rate than another city under similar conditions in which the persons of these ages constitute

less than 10 per cent. of the population, since the death-rate at these age-periods is invariably much higher than that of the remaining population, constituted as it is of children who have passed the first and most critical year of infancy, together with the vigorous population of early adult life. For example, in the comparatively new populations of such States or territories as Arizona, Nevada, Idaho, and the older state of Iowa, the ratios of persons of the two age-groups, under one year and all over fifty, were as follows, by the census of 1880:

PER CENT. OF PERSONS UNDER ONE AND OVER FIFTY YEARS TO THE
TOTAL POPULATION.

| | |
|-------------------|----------------|
| Arizona | 8.90 per cent. |
| Idaho | 12.64 " |
| Nevada | 10.52 " |
| Iowa | 13.99 " |

On the other hand, the per cent. of persons living at these age-periods in the two older States of Delaware and Vermont was as follows:

| | |
|--------------------|-----------------|
| Delaware | 15.92 per cent. |
| Vermont | 21.85 " |

Now, since the death-rate of children under one year is usually from eight to ten times as great as that of the total population, and that of persons over fifty is usually not far from twice as large, it follows that, other things being equal, we may expect to find a general death-rate in these older States correspondingly greater than that of the newer communities."

The committee advocated the adoption of the method recommended by Körösi, of Budapesth, as being the most simple, the least cumbrous, and the one that is sufficiently accurate for the purposes for which it is designed. Körösi's method comprises a division into four age-groups, as follows: Under one year, one to twenty years, twenty to fifty years, all over fifty years.

Körösi also recommends that the age-distribution of

only one country, for example, that of Sweden, be employed as standard. The distribution of Sweden by the census of 1880 was as follows:

| Age-period. | Per cent. |
|---------------------------------|-----------|
| Under one year | 2.65 |
| One to twenty years | 39.81 |
| Twenty to fifty years | 38.62 |
| All over fifty | 18.92 |

The method of application is as follows, as applied to Massachusetts:

| Age-groups. | Standard distribution, Sweden, 1880. | Death-rate, Massachusetts, 1880. | Mortality index. |
|-------------|--------------------------------------|----------------------------------|------------------|
| 0-1 | 2.65 | 19.13 per cent. | 5.07 |
| 1-20 | 39.81 | 1.28 " " | 5.09 |
| 20-50 | 38.62 | 1.03 " " | 3.98 |
| all over 50 | 18.92 | 3.90 " " | 7.38 |
| | 100.00 | | 21.52 |

In Dr. Ogle's standard, which is in use in England, the population is divided into twelve age-groups. These groups, and the annual rate of mortality in England per 1000 persons living, are shown in the following table from the Registrar-General's report for 1880:

| | All ages. | 0 to 5 | 5 to 10 | 10 to 15 | 15 to 20 | 20 to 25 | 25 to 35 | 35 to 45 | 45 to 55 | 55 to 65 | 65 to 75 | 75 to 85 | 85 and upward. |
|---|-----------|--------|---------|----------|----------|----------|----------|----------|----------|----------|----------|----------|----------------|
| England, average annual rate in twenty-five yrs. 1848-72. | 22.4 | 67.9 | 8.3 | 4.8 | 6.7 | 8.8 | 9.9 | 12.7 | 17.0 | 30.1 | 62.0 | 139.6 | 294.2 |
| England, 1880 . . . | 20.5 | 64.4 | 6.3 | 3.3 | 4.8 | 6.1 | 7.7 | 11.5 | 16.0 | 30.4 | 61.2 | 132.3 | 257.9 |

The rate at each age-group is corrected to the proportion of the population at that age. The division into twelve age-groups, instead of four, increases the labor of computation threefold.

Calculation of the Birth-rate and Death-rate.—The birth-rate and the death-rate are both calculated at

an annual rate per 1000 of population. The births may be divided into several groups according to sex, race, or as regards legitimate and illegitimate births. Death-rates are of special value when calculated for different occupations, different diseases, and different age-groups. This information is of value because it indicates the occupations most injurious to health, and also the ages at which most deaths occur. Death-rates from the various exanthemata are also of special importance, because the course of an epidemic can be traced by this means; its relative severity can be compared with preceding epidemics; and especially the value of compulsory vaccination can be ascertained from the statistics of small-pox. The following formula is readily remembered, and will facilitate the calculation of death-rates: $M = \frac{1000 D}{P}$ ex-

pressed in thousands, where M = the mortality, D = the number of deaths, and P = the population.

Example.—In a population of 2000 there are 30 deaths, hence the death-rate is $\frac{1000 \times 30}{2000} = 15$ per 1000 of pop-

ulation. The death-rate from a particular disease is expressed as so many per 10,000 of population, and the fatality of a disease is expressed in per cent. of the number of cases. The death-rate of a place is also influenced by other than the sanitary conditions of a place, such as the prevailing diseases of the locality, the nature of the occupations, the relative ages of the population, etc.

Rate of Infant Mortality.—The rate of infant mortality is measured by the proportion of deaths of infants under one year of age, to the number of births registered, and is expressed as so many per 1000 births. Stillbirths are excluded. The infant-mortality is considered to be one of the best tests of the sanitary condition of a locality, though this cannot apply to newly settled localities, where the infant population is necessarily quite small.

Death-rate of Persons Engaged in Various Occu-

pations.—The influence of occupation can be definitely determined only by studies of the death-rate of persons following those occupations, and this is done by determining the ratio of deaths at each age to those living during a certain time and engaged in the same occupation.

Mortality in Relation to Seasons.—The influence of the weather in favoring the production of certain diseases is shown in the death-rate from those diseases at certain seasons of the year; thus in winter there are a greater prevalence and a higher death-rate from diseases of the respiratory system, while in summer there are a greater prevalence and a higher death-rate from diseases of the gastro-intestinal tract. As a rule, the mortality is highest during the winter months, though where there is a large infant population the death-rate is frequently highest in summer because of the prevalence of infantile diarrhea.

Mean Age at Death.—The mean age at death of a population is the sum of the ages divided by the number of deaths. Due corrections must be made for age and sex distribution if these are not in accord with those of the general population. A large infant population will reduce the mean age at death though the health of the adult population is extremely good. De Chaumont gives the following formula for the approximate calculation of the mean duration of life: $\left(\frac{2}{3} \times \frac{1}{D}\right) + \left(\frac{1}{3} \times \frac{1}{B}\right) = x$, where B = the birth-rate, D = the death-rate per unit of population (*i. e.*, 35 per 1000 = 0.035 per unit).

Example.—In England between 1871 and 1880 B = 35.35 per 1000 = 0.03535 per unit of population. D, for the same period, = 21.4 per 1000 = 0.0214 per unit of population, then $x = \left(\frac{2}{3} \times \frac{1}{0.0214}\right) + \left(\frac{1}{3} \times \frac{1}{0.03535}\right) = 40.58$ years = the expectation of life at birth.

Mean Duration of Life.—The mean duration of life is the expectation of life at birth, and at any other age it

is expectation of life at that age, as taken from life tables, added to the age.

Probable Duration of Life.—The probable duration of life is the age at which a given number of children born at the same time will be reduced to half the number.

Expectation of Life.—The expectation of life is the average length of time a person of any age may be expected to live. This is computed from life tables. The following life table gives the results of computations from the mortality returns in England and America, and the results of the experiences of life insurance companies:

| Age. | Dr. Ogle's life table, England, 1871-80. | | Humphrey's approximate English life tables. | | Thirty American life insurance companies. | | Massachusetts five years (1878-82). | | Jews, United States, five years (1885-89). | |
|--------|--|----------|---|----------|---|----------|-------------------------------------|----------|--|----------|
| | Males. | Females. | Males. | Females. | Males. | Females. | Males. | Females. | Males. | Females. |
| 0 yr. | 41.35 | 44.62 | 41.02 | 45.25 | | | 41.74 | 43.50 | 63.51 | 59.63 |
| 1 " | 48.05 | 50.14 | 48.64 | 50.75 | | | 49.84 | 50.24 | 68.33 | 63.57 |
| 2 yrs. | 50.14 | 52.22 | 50.73 | 52.81 | | | 51.17 | 52.35 | 69.58 | 64.74 |
| 3 " | 50.86 | 52.99 | 51.45 | 53.57 | | | 52.70 | 52.89 | 69.78 | 64.07 |
| 4 " | 51.01 | 53.20 | 51.61 | 53.77 | | | 52.93 | 53.00 | 69.72 | 63.73 |
| 5 " | 50.87 | 53.08 | 51.47 | 53.05 | | | 52.78 | 52.88 | 69.36 | 63.20 |
| 10 " | 47.60 | 49.76 | 48.16 | 50.32 | 49.99 | 48.05 | 49.92 | 50.04 | 65.99 | 59.84 |
| 15 " | | | 43.94 | 46.15 | 46.57 | 44.19 | 45.86 | 46.08 | 61.75 | 55.39 |
| 20 " | 39.40 | 41.66 | 39.86 | 42.10 | 43.07 | 40.82 | 42.17 | 42.78 | 57.44 | 50.93 |
| 25 " | | | 36.05 | 38.36 | 39.49 | 37.80 | 39.04 | 39.78 | 53.24 | 46.65 |
| 30 " | 32.10 | 34.41 | 32.47 | 34.75 | 35.85 | 34.89 | 35.68 | 36.70 | 49.22 | 42.62 |
| 35 " | | | 28.88 | 31.12 | 32.17 | 31.78 | 32.32 | 33.63 | 44.74 | 38.47 |
| 40 " | 25.30 | 27.46 | 25.59 | 27.68 | 28.48 | 28.48 | 28.86 | 30.29 | 40.30 | 34.31 |
| 45 " | | | 22.34 | 24.21 | 24.82 | 25.02 | 25.41 | 26.95 | 35.83 | 30.43 |
| 50 " | 18.93 | 20.68 | 19.14 | 20.80 | 21.24 | 21.33 | 22.02 | 23.50 | 31.10 | 26.30 |
| 55 " | | | 16.09 | 17.37 | 17.80 | 17.73 | 18.63 | 20.05 | 26.74 | 22.30 |
| 60 " | 13.14 | 14.24 | 13.31 | 14.32 | 14.56 | 14.37 | 15.60 | 16.91 | 25.52 | 18.45 |
| 65 " | | | 10.79 | 11.55 | 11.60 | 11.31 | 12.57 | 13.77 | 18.93 | 15.23 |
| 70 " | 8.27 | 8.95 | 8.44 | 9.08 | 8.17 | 8.12 | 10.32 | 11.30 | 15.25 | 12.82 |
| 75 " | | | 6.52 | 7.04 | 6.72 | 6.34 | 8.08 | 8.83 | 12.61 | 11.07 |
| 80 " | 4.79 | 5.20 | 4.96 | 5.38 | 4.87 | 4.49 | 6.86 | 7.37 | 10.35 | 9.07 |
| 85 " | | | 3.78 | 4.15 | 3.40 | 3.08 | 5.63 | 5.92 | 7.50 | 7.50 |
| 90 " | 2.84 | 2.90 | 2.88 | 3.16 | 2.17 | 2.05 | | | | |
| 95 " | 2.17 | 2.17 | 2.20 | 2.40 | 1.34 | 1.34 | | | | |
| 100 " | 1.68 | 1.76 | 1.72 | 1.84 | | | | | | |

In order to construct such a table, we must know the number of persons living, their ages, the number of deaths, and the ages at death, and changes in population caused by unusual birth-rate, by emigration, immigration, and other causes.

The expectation of life of females is greater than that of males according to the results obtained in England and in Massachusetts. The reverse is the case with the Jews of the United States. In the experience of the thirty life insurance companies of America the expectation of life of males is greater than that of females. This most interesting result obtained from the selected lives of the insured is difficult to explain. The relatively greater number of males insured may explain this difference in the result.

The results obtained in England and Massachusetts indicate that the female mortality is lower than the male mortality, and it is evident, therefore, that the dangers connected with childbearing do not prevent the general female mortality at childbearing ages from being lower than that of males.

The causes of the higher mortality among males are largely connected with the greater hardships and dangers connected with their occupations. In spite of the dangers of childbirth, married women have a much lower mortality than spinsters or widows. Widows of twenty to twenty-five years of age have a higher mortality than bachelors and married men of the same age.

The expectation of life after the first year increases up to the fourth year, and remains higher than at the first year up to about the seventeenth year. Willich gives the following formula for the approximate calculation of the expectation of life at any age: Expectation of life = $\frac{2}{3}(80 - a) = x$, where a = the present age, and x = the expectation of life. Thus at forty years, $\frac{2}{3} \times (80 - 40) = 26.66$ years.

Relation of Density of Population to the Death-rate.—The relation of the density of the population to the death-rate is most important. Dr. Farr found that the mortality increases with the density of the population, but not in direct proportion to the density, but as its sixth root. Thus if D and D' = density of the population in two places, and M and M' the mortality, then

$\frac{M'}{M} = \sqrt{\frac{D'}{D}}$ The death-rate in each locality is, however, influenced by other factors than the mere fact of the existence of a certain number of persons in a specified area. The most important factors which influence the death-rate under all conditions are the proportion which the infant population bears to the whole, or, in other words, the average age of the population, the nature of the occupation of the people, and, above all, the general sanitary conditions of the surroundings.

Necessity of System of Notification.—Vital statistics cannot be obtained without some system of notification. Various objections have been raised against the notification of infectious diseases. The objection is frequently made that the friends of the patient wish to keep the matter secret, and that notification is a betrayal of confidence. There is usually delay in calling a physician, and this gives opportunity for the spread of the disease. The physician must be held responsible for reporting infectious diseases, otherwise the certainty of prompt notification is limited. The physician should be compensated for this extra work, though this is rarely done, and physicians should feel it a privilege to make the notifications, because it is the right of only those who are authorized to practise in a locality. It is, therefore, one mode of protecting the registered physicians against the invasion of those who are not qualified.

The notification of infectious diseases frequently causes great discomfort and pecuniary loss to those who are isolated in the infected area. It interferes with the liberty and comfort of a large number of people, though this discomfort is insignificant to the general discomfort and loss entailed by general epidemics.

Dr. Biddle, in a paper read before the Seventh International Congress of Hygiene, on "Should Compulsory Notification be made General?" gives the mean death-rates per 1000 living in twenty towns of England:

| | 1871-75. | 1876-80. | 1881-85. | 1886-90. |
|------------------------------|----------|----------|----------|----------|
| All causes | 24.81 | 23.26 | 21.84 | 21.19 |
| Total zymotic | 4.79 | 3.84 | 3.27 | 2.91 |
| Notifiable zymotic | 2.17 | 1.47 | 1.13 | 0.78 |

Notification has been in force since the adoption of the Public Health Act of 1875. While there was a decline in the death-rate from all causes from 1871-75 to 1886-90 of only 14.5 per cent., there was a decline of 39.2 per cent. in the death-rate from the total zymotic diseases, and a decline of 64 per cent. in the death-rate from the notifiable diseases during the same period, showing the great value of notification in infectious diseases.

Hospital for Infectious Diseases.—Where satisfactory isolation is impracticable the city should provide special hospitals for infectious diseases. This arrangement lessens the hardships of isolation, and may be instrumental, under proper regulations, in favoring the system of notification.

The special need of pay hospitals for infectious diseases has long been felt. Even where the patient could be satisfactorily isolated and treated in the home, there is a feeling that the pecuniary loss and inconvenience of house quarantine are much greater than the expense of hospital treatment. Consequently those that are able and willing to pay for hospital treatment cannot be accommodated anywhere except at the municipal hospital, and there is frequently objection to going to a public institution. It is safe to state that the time is not far distant when every large city will have pay hospitals for the reception of cases of infectious diseases. Such hospital treatment would overcome the obnoxious house quarantine practised to-day, at least as far as those are concerned whose time is most valuable from their business associations.

APPENDIX.

Rules for interchange of different expressions of results of analysis :

To convert parts per 100,000 into grains per gallon (= parts per 70,000), multiply by 0.7.

To convert grains per gallon into parts per 100,000, multiply by 1.425.

To convert parts per million, or milligrams per liter, into grains per gallon, multiply by 0.07.

To convert grains per gallon into parts per million, or milligrams per liter, multiply by 0.142.

To convert nitrogen as nitrates into nitric anhydrid, multiply by 3.857.

To convert nitric anhydrid into nitrogen as nitrates, multiply by 0.2592.

To convert nitrogen as nitrites into nitrous anhydrid, multiply by 2.714.

To convert nitrous anhydrid into nitrogen as nitrites, multiply by 0.368.

To convert free or albuminoid ammonia into parts of nitrogen as ammonia, multiply by 0.824.

To convert nitrogen as ammonia into free or albuminoid ammonia, multiply by 1.214.

Rules for the conversion of degrees of one thermometer scale into those of another :

Centigrade into Fahrenheit, multiply by 9, divide by 5, and add 32.

Fahrenheit into centigrade, deduct 32, multiply by 5, and divide by 9.

Fahrenheit into Réaumur, deduct 32, multiply by 4, and divide by 9.

Réaumur into Fahrenheit, multiply by 9, divide by 4, and add 32.

Centigrade into Réaumur, divide by 5 and multiply by 4.

Réaumur into centigrade, divide by 4 and multiply by 5.

Rules for conversion of kilogram-meters into foot-pounds and foot-tons, and vice versa :

To convert kilogram-meters into foot-pounds, multiply by 7.233.

To convert foot-pounds into kilogram-meters, multiply by 0.1382.

To convert kilogram-meters into foot-tons, multiply by 0.003229.

To convert foot-tons into kilogram-meters, multiply by 309.7.

Values of terms employed in connection with fuel-value of food :

1 calorie = the amount of heat required to warm 1 gram of water

1 degree centigrade = small calorie.

1 kilogram-calorie = the amount of heat required to warm 1 kilogram of water 1 degree centigrade = large calorie.

The mechanical equivalent of 1 calorie = 3100 foot-pounds.

Comparison of Metric and English Weights and Measures :

LENGTH.

| | |
|--------------|--|
| 1 meter | = 39.37 inches = 3.28 feet. |
| 1 decimeter | = 3.94 " = 4 inches, nearly. |
| 1 centimeter | = 0.394 inch = $\frac{1}{25}$ inch. |
| 1 millimeter | = 0.0394 " = $\frac{1}{25}$ " nearly. |
| 1 kilometer | = 1000 meters = 1094 yards = $\frac{1}{2}$ mile, nearly. |
| 1 mile | = 1609 " or 1.609 kilometers. |
| 1 yard | = 0.9144 meter. |
| 1 foot | = 0.3048 " = 3.048 decimeters. |
| 1 inch | = 25.4 millimeters. |

APPENDIX.

CAPACITY.

- 1 liter = 1000 cubic centimeters = 61 cubic inches = 35.3
 ounces = 2.182 pints = 0.264 gallon.
 1 cubic centimeter = 0.061 cubic inch.
 1,000,000 cubic centimeters = 1000 liters = 1 cubic meter
 = 35.3 cubic feet.
 1 cubic meter = 265.78 gallons.
 1 cubic inch = 16.4 cubic centimeters.
 1 fluidounce = 28.3 cubic centimeters = 1.806 cubic inches.
 1 cubic foot = 7.48 gallons = 1000 fluidounces = 28.32 liters.
 1 cubic yard = 0.7645 cubic meter.
 1 gallon = 3785.4 cubic centimeters = 3.7854 liters.
 1,000,000 gallons = 3785.4 cubic meters.

WEIGHT.

- 1 cubic centimeter of water at 4° C. (39.2° F.) weighs 1 gram.
 1 gram = 15.432 grains = 0.035 ounce.
 1 decigram = 1.5432 " = 1½ grains, nearly.
 1 centigram = 0.15432 grain = $\frac{1}{3}$ grain "
 1 milligram = 0.015 " = $\frac{1}{85}$ " "
 1 kilogram = 1000 grams = 15,432 grains = 2.2046 lb. *avoir.*
 = 35.3 ounces.
 1 grain = 65 milligrams, nearly.
 1 ounce = 28.35 grams.
 1 lb. *avoir.* = 453.6 " = 0.4536 kilogram.
 1 ton *avoir.* (2240 lbs.) = 1016 kilograms.

AREA.

- 1 sq. meter = 10.76 sq. feet = 1550 sq. inches.
 1 sq. centimeter = 0.155 sq. inch = $\frac{1}{3}$ sq. inch, nearly.
 1 sq. millimeter = 0.00155 " = $\frac{1}{645}$ " "
 100 sq. meters = 1 are = 119.7 sq. yards = 3.954 sq. rods.
 100 ares (hektar) = 11,967 sq. yards = 2.47 acres.
 1 sq. kilometer = 1,000,000 sq. meters = 247 acres = 0.386
 sq. mile.
 1 sq. inch = 6.452 sq. centimeters = 645 sq. millimeters.
 1 sq. foot = 0.0929 sq. meter = 9.29 sq. decimeters.
 1 sq. yard = 0.8361 "
 1 acre = 40.5 are, nearly = 0.405 hektar.

INDEX.

- ABLUTION**, amount of water required for, 111
- Absolute humidity**, 40
- Acclimation**, 50
- Acid**, carbolic, 428
carbonic, 147
hydrocyanic, 427
sulphuric, 147
- Actinomycosis**, 416
- Action of wind**, 69
- Adulterations of food**, 234
- Adults**, subsistence diet for, 239
- Age**, 19
at death, mean, 509
diet for old, 240
- Age-distribution**, standards for, 505
- Agents**, physical, for disinfection, 430
- Air**, 31
amount required, 64
respired, 64
bacteria in expired, 54
carbon dioxide in, 58
chemical analysis of, 57
diseases produced by impure, 60
dust in, 56
effects of solid impurities in, 63
examination of, by senses, 57
ground, 50, 329
hot, heating with, 93
humidity of, estimation, 59
impure, diseases produced by, 60
impurities in, 51
sources of, 52
of dwellings, impurities in, 56
of factories, impurities in, 55
of workshops, impurities in, 55
organic matter in, estimation of, 59
propeller, 80
sewer, 51
temperature of, 33
vitiating, effects of, 60
- Alcoholic beverages**, 333
use of, in tropics, 48
- Alimentary principles of food**, 200
- Alkalinity of water**, 146
- Ammonia**, free and albuminoid, 145
- Amoeba coli**, 402
- Amount of air required**, 64
respired, 64
of exercise that should be taken, 247
of food, excessive, 282
of nutrients furnished for twenty-five cents, 195
of water required daily, 110
- Analysis of air**, chemical, 57
of water and sewage, 139
chemical, 142
alkalinity, 146
carbonic acid, 147
chlorin, 144
dissolved oxygen, 147
evaporation residue, 144
hardness, 146
iron, 147
nitrogen as ammonia, 145
as nitrates, 146
as nitrites, 145
oxygen consumed, 146
collection of samples, 139
microscopic examination, 142
physical examination, 141
quantitative bacterial examination, 148
- Anemometer**, portable, 78
- Anilin dyes**, effects of, 274
- Animal foods**, 202
parasites, 401
prevention of infection with, 414
- Animals**, domestic, composition of flesh of, 313
- Anopheles**, 384
- Antimeningococcus serum**, 365
- Antistreptococcal serum**, 363
- Antitoxic sera**, 360
- Antitoxin**, diphtheria, 360
tetanus, 360
- Antituberculosis serum of Marmorek**, 365
- Antityphoid vaccination in army**, 315, 371
- Appendix**, 514
- Approximate composition of water**, 110
- Aqueous vapor**, 52

- Arrangement in natural ventilation,
70
of interior of house, 336
Artesian wells, 115
Artificial ventilation, 78
comparison of methods, 83, 84
extraction method, 83
propulsion method, 83
Asiatic cholera, 107
detention of passengers on ac-
count of, 476
disinfection for, 476, 495
Atmosphere, humidity of, 37
movements of, 41
nature and composition of, 31
pressure of, 34
distribution of, 36
Attitude, mental, 261
- BACILLUS**, tubercle, action of sunlight
on, 420
Bacteria, 106
action of sunlight on, 420
in clothing, 256
in expired air, 54
or contact-bed system, 169
pathogenic, in dead bodies, 383
persistence in dead bodies, 383
in soil, 330
Bacterial examination of water, 148
Bacteriolytic sera, 361
Baking powders, 229
Barometer, 34
Barracks, 312
Basis for calculation of vital statistics,
505
Bedding, disinfection of, 487
infected, 256
Beef, lean, 212
Berkefeld filter, 132
Besredka method of protection, 369
Beverages, alcoholic, 233
use of, in tropics, 48
non-alcoholic, 233
Bills of health, 460
Biologic aids to diagnosis, 377
Birth-rate, calculation of, 507
Blackboards, position of, 286
Board of health, regulations of, 499
Bodies, dead, pathogenic bacteria in,
383
of water, self-purification of, 117
Body, chemical composition of, 185
Boiler-purposes, suitability of water,
138
Boiling water, 133
Bovophilus bovis and Texas fever, 393,
398
- Bowels, regular attention to, 259
Bread, 229
Buildings, defects in, 292
loss of heat from, 86
Butter, 225
adulteration of, 235
- CABINS**, disinfection of, 483
Cameron septic tank, 164
Camp, diseases in, 315
location of, 309
sanitary policing of, 310
Camps, 309
Cancer, 110
etiology of, 417
Canned vegetables, adulteration of,
236
Capacity, drainage of soil, 281
Carbolic acid, 428
Carbon dioxide, 52, 60
in air, estimation of, 58
monoxid, 60
Carbonic acid, 147
Card, inspection, 468
Cargo, disinfection of, 483, 488
inspection of, 465, 472
Cattle, protective vaccination of,
against tuberculosis, 372
Causes of disease, 17
exciting, 19
immediate, 17
predisposing, 19
remote, 18
vital, 346
Census, basis for calculation, 505
Cereals, composition of, 228
Cheese, 228
Chemical analysis of air, 57
of sewage, 142
of water, 142
composition of air, 31
of body, 185
of water, 96
treatment of sewage, 159
Childhood, diet in, 238
Chlorin, 144
Chlorinated lime, 429
Cholera, Asiatic, 107
disinfection for, 476, 480
protective inoculation against, 370
quarantine regulations on account
of, 476
Cholera-infected vessels, treatment of,
476
Circulation, effect of exercise on, 244
City, destruction of mosquitoes in, 389
Cleaning house, 344
Cleanliness in relation to clothing, 255

- Cleanliness of mouth and teeth, 259
 Cleansing the vessel, 321
 Climate, 43
 influence upon health, 45
 upon mortality, 49
 Cloak-rooms, 286
 Closet, water-, 151, 289
 amount of water required for, 111
 Clothing, 250
 cleanliness in relation to, 255
 infected, 256
 injurious effects of, 254
 of the soldier, 305
 Clouds, 42
 Coal filters, Garfield, 170
 Cocoa, adulteration of, 236
 Coffee, adulteration of, 236
 Cold, protection against, 250
 Collection and removal of garbage, 181
 of samples of water, 130
 Combination systems of heating, 93
 Combustion, effects of air vitiated by, 62
 impurities due to, 55
 Commercial value of sewage, 178
 Comparative mortality, 266, 268
 Comparison of methods of ventilation, 83, 84
 of natural waters, 99
 Complement, 358
 Composition of cereals, 228
 of different kinds of meat, 213
 of drinking-water, 96, 110
 of flesh of domestic animals, 213
 of food materials, 196, 199
 of leguminosæ, 228
 of meat, 212
 of the atmosphere, 31
 Condiments, 232, 234
 Conditions of environment, hygienic, 25
 Configuration of soil, 332
 Conjugal conditions, 25
 Connate conditions, 23
 Consumption of fluids, 234
 Contact-bed system, 169
 Control of sale of milk, municipal, 221
 Conveyances, public disinfection of, 436
 Cooking, amount of water required for, 110
 Cooling devices, 340
 Correct soles, 252
 Corridors, 286
 Corrosive sublimate, 427
 Cost of food, 195
 Covering of floors, 338
 of walls, 338
 Cows, care of, 222
 milk, 214
 Creolin, 438
 Crew, inspection of, 467
 Cubic space, 66, 282
 relation to window space, 284
 Culex, 385
 DAILY amount of water required, 110
 diet, minimum standard of, 193
 Dairy rules, 222
 Dampness, protection against, 251
 Damp soil, improvement of, 332
 Dark meat, effect of, 211
 Dead bodies, pathogenic bacteria in, 383
 Death, mean age at, 509
 Death-rate, calculation of, 507
 in different occupations, 508
 relation to population, 511
 Deehan's test in typhoid fever, 378
 Defects in school-buildings, 292
 Deformed feet, 253
 Degree of warmth, 86
 Dengue and animal parasites, 407
 Density of population, relation to death-rate, 511
 Dermacentor occidentalis, 398
 Desks, 290
 Destruction of mosquitoes in the city, 389
 of vermin, 391
 Detection of meat preservatives, 209
 Detention period, 446
 of passengers, 467
 Diagnosis, biologic aids to, 377
 Diarrhea, 108
 hill, 104
 infantile, 109
 Diet for old age, 240
 in childhood, 238
 in infancy, 238
 subsistence, for adults, 239
 Dietaries, 238
 Dietary, standard, 193
 Dieting, 185
 Difference in temperature, 69
 Different varieties of food, 202
 Diffusion, 69
 of gases, 64
 Digestibility of food, 197
 Dilution, 117
 Diphtheria antitoxin, 360
 isolation and disinfection in, 443
 Direct heating, 87
 radiation, 89, 90
 Direct-indirect radiation, 90
 Disease, 17

- Disease among marines, 327**
 conveyed through milk, 215
 exciting causes of, 19
 immediate causes of, 17
 in camp, 315
 infectious, disinfection in, 434
 hospitals for, 513
 preventive measures for, 380
 insects and, 393
 interstate notification of, 493
 intestinal, disinfection in, 433
 predisposing causes of, 19
 produced by diseased meat, 203
 by impure air, 60
 quarantinable, 460, 493
 remote causes of, 18
 respiratory, disinfection in, 433
 vital causes of, 346
- Disinfectants in common use, 419**
 authorized by quarantine laws, 483
- Disinfecting plant, steam, 421**
- Disinfection, 418**
 and isolation, value of, 442
 for cholera, 476, 495
 for leprosy, 480
 for plague, 480
 for small-pox, 479, 496
 for typhus fever, 479, 497
 for yellow fever, 476, 496
 in quarantine, 497
 of barber-shops, 438
 of excreta, 431
 of habitations, 434
 of infective materials, 431
 of libraries, 438
 of patient, 435
 of public conveyances, 436
 of sick-room, 432
 in exanthemata, 432
 in intestinal diseases, 433
 in other infectious diseases, 434
 in respiratory diseases, 433
 of vessels, 483, 487
 cabins, 483, 487
 cargo, 487
 forecastle, 487
 holds, 487
 steerage, 487
 of water with ultra-violet light,
 138
 on large scale, 420
- Disposal of garbage, 180, 182**
 of sewage, 151, 158, 289
- Dissemination, modes of, 348**
- Dissolved impurities in water, 105**
 oxygen, 147
- Distillation of water, 132**
- Distribution of atmospheric pressure, 36**
- Domestic animals, composition of**
 flesh of, 213
 filter, 131
 ports, quarantine regulations for,
 471
 water-still, 133
- Drainage, 342**
 capacity of the soil, 281
- Drinking-water, amount required, 110**
 composition of, 110
- Dry-earth closet, 157**
- Dry heat, 430**
- Duration of life, mean, 509**
 probable, 510
- Dust in air, 56**
 removal of, 83
- Dwellings, air of, 56**
- Dysentery, 108**
- EFFECT of exercise on the circulation,**
 244
 on the elimination of nitrogen,
 246
 on the lungs, 242
 on the muscles, 245
 on the nervous system, 246
 on the nitrogen elimination, 246
- Effects, injurious, of clothing, 254**
 of impurities in water, 104
 of light and dark meat, 211
 of solid impurities in air, 63
 of vitiated air, 60, 61
 of wind upon health, 42
- Eggs as food, 226**
- Ehrlich's hypothesis, 354**
- Elastic force of vapor, 40**
- Electricity, heating with, 94**
- Elimination of nitrogen, effect of exercise on, 246**
- Energy derivable from food, 189**
 potential, in food, 187
- Entrance, avenues of, 380**
- Environment, hygienic condition of, 25**
- Epidemics, nature of, 349**
- Establishments, industrial, lighting of, 278**
- Etiologic factor in infectious diseases, 380**
- Evaporation residue, 144**
- Examination of air by senses, 57**
 of water, bacterial, 148
 chemical, 142
 microscopic, 142
 physical, 141
- Exanthemata, disinfection in, 432**
- Excessive amounts of food, influence of, 241**

- Exciting causes of disease, 19
 Excreta, disinfection of, 431
 Exercise, 242
 amount that should be taken, 247
 effect on the circulation, 244
 on the elimination of nitrogen, 246
 on the lungs, 242
 on the muscles, 245
 on the nervous system, 246
 on the nitrogen elimination, 246
 Exhaust steam-heating, 92
 Expectation of life, 510
 Expired air, bacteria in, 54
 Extermination of rats, 392
 Extraction and propulsion method of ventilation, 83
- FACTORIES**, impurities in air of, 55
 Fans, 70
 Fatigue, 245
 Feet, deformed, 253
 normal, 253
 Fever, scarlet, isolation and disinfection in, 444
 typhoid, 106
 typhus, disinfection in, 497
 yellow, 496
 Fifty dairy rules, 222
 Filaria and mosquitoes, 397, 410
 Filter, Berkefeld, 132
 construction, 131
 domestic, 131
 mechanical, 125
 plant, specifications for, 127
 sand, 119
 Filtering medium, 131
 Filters, Garfield coal, 170
 household, 131
 sand, 119
 sprinkling, 175
 Filtration, 118
 intermittent, 119
 mechanical, 125
 purification without, 132
 sand, 119
 through coarse broken stone, 164
 Fire as a disinfectant, 430
 Fireplaces, open, 90
 Fish, 214
 Flask method of estimating carbon dioxide in air, 58
 Fleas and disease, 495
 remedies for, 398
 Flesh of domestic animals, composition, 213
 Flies and disease, 394
 protection from, 345
- Floor space, 282, 284
 Floors and floor covering, 338
 Fluids, consumption of, 234
 Food, adulterations of, 234
 alimentary principles of, 200
 and dieting, 185
 animal, 202
 composition of, 199
 digestibility of, 199
 eggs, 226
 energy derivable from, 189
 influence of excessive amounts, 241
 of insufficient amounts, 241
 materials, composition of, 196
 mineral, 232
 nutritive value and cost, 195
 nuts as, 237
 potential energy of, 187
 preservatives, 231
 water as, 201
 Food-poisoning, 206
 Food-supply, 322
 Foods, adulteration of, 234
 animal, 202
 vegetable, 227
 preserved, 330
 Foot inspection, 316
 Forbes water sterilizer, 134
 army type, 311
 Force of vapor, elastic, 40
 Forecastle, disinfection of, 487
 Foreign ports, quarantine regulations at, 460
 Formaldehyd, 422
 disinfection with, 485
 generation of, 423
 Formaldehyd-spraying liquid, 426
 Foundation of house, 335
 Fresh air, amount required, 64
 respired, 64
 Friction, 78
 Frontiers, quarantine regulations at, 481
 Fruit vessels, special quarantine for, 488
- GAME**, 214
 Garbage, 180
 collection and removal, 181
 disposal, 180, 182
 Garfield coal filters, 170
 Garments, outer, 306
 Gas, formaldehyd, disinfection with, 485
 generation of, 485
 heating by means of, 95
Gaseous impurities in water, 104

- Cases, diffusion of, 64
 General regulations, quarantine, 493
 requirements at quarantine, 475
 rules for ventilation, 68
 Generation of formaldehyd gas, 423
 Glanders, reaction in, 378
 Goiter, 109
 Ground-air, 50, 329
 Ground-water, 330
 supplies, 114
- HABITATIONS**, 260, 334
 disinfection of, 434
Haffkine fluids, 368
 method of protection, 368
Hard water, softening of, 135
Hardness of water, 146
Health, 17
 bills of, 460
 effects of wind upon, 42
 influence of climate upon, 45
 of humidity upon, 41
 of laborers, 276
 State board regulations of, 499
Heat, 78
 dry, 430
 emitted by radiation, 88
 loss of, from buildings, 86
 moist, 430
 protection against, 251
 supplied by radiating surfaces, 87
Heating, 86, 288, 339
 by means of electricity, 94
 of exhaust steam, 92
 of gas, 95
 of hot air, 93
 water, 92
 of open fireplaces, 89
 of petroleum, 95
 of steam, 91
 of stoves, 90
 combination systems of, 93
 direct, 87
 indirect, 87, 93
 of the vessel, 321
 systems of, 89
Helminthiasis, 410
Heredity, 22
Hill diarrheas, 104
Holds, disinfection of, 487
Hook-worm disease, 413
Hospitals for infectious diseases, 513
Hot air, heating with, 93
Hot-water radiators, 91
House, foundation of, 335
 position of, 334
 quarantine, 442, 500
 roof of, 335
- House**, walls of, 335
House-cleaning, 344
Household filters, 131
Houses for the poor, 342
Houston's sewage streptococcus, 102
Humidity of the atmosphere, 37
 absolute, 40
 estimation of, 57
 influence on health, 41
 relative, 40
Hydrocyanic acid, 427
Hydrogen sulphid, 60
Hygiene, 27
 definition of, 17
 development of, 28
 industrial, 262
 military, 299
 naval, 318
 personal, 258
 school, 281
Hygienic conditions of environment, 25
Hygrometer, 38, 59
Hygrometry, 38
- IMMEDIATE causes of disease**, 17
Immune body, 358
 sera, typhoid, 361
Immunity, 350
 active, 352
 prevention of infection by in-
 ducing, 367
 against malaria, 386
 Ehrlich's hypothesis of, 354
 passive, 352
Improvement of a damp soil, 332
Impure air, diseases produced by, 60
Impurities in air, 51
 of dwellings, 56
 of factories, 55
 of workshops, 55
 solid, 63
 source of, 52
 due to combustion, 55
 to perspiration, 55
 to respiration, 52
 in water, 100
 effects of, 104
 gaseous, 104
 inorganic, 105
 organic, 106
Indirect heating, 89, 93
Industrial establishments, hygiene,
 262
 lighting of, 278
Infancy, diet in, 238
Infant mortality, rate of, 478
Infantile diarrhea, 109

- Infected clothes and bedding**, 256
 compartments, disinfection of, 487
 ports, regulations at, 474
 vessels, treatment of, 487
Infection by means of animal parasites, prevention of, 414
 physicians as carriers of, 379
 prevention of, by active immunity, 367
 sources of, 380, 381
Infectious diseases, hospitals for, 513
 serum therapy and serum prophylaxis in, 366
Infective materials, disinfection of, 431
Influence of climate on health, 45
 on mortality, 49
 of excessive amounts of food, 241
 of humidity on health, 41
 of insufficient food, 241
 of length of working-day, 276
Injurious effects of clothing, 254
Injury, protection against, 252
Inland quarantine, 441
Inoculation, protective, against
 cholera, 370
 against plague, 370
 against typhoid fever, 371
Insects, relation to spread of disease, 393
Inspection, body, 317
 foot, 316
 meat, 203
 method of, 204
 of quarantines, 483
 local, 483
 State, 483
 of schools, medical, 294
 of vessels, 463, 472
 card, 468
Insufficient food, influence of, 241
Interior arrangement of house, 336
Intermittent filtration, 119
Interstate notification of diseases, 493
 quarantine, 492
 general regulations of, 493
Intestinal diseases, disinfection in, 433
Iron in water, 147
 sulphate of, 429
Irrigation, subsurface, 164
Isolation, 442
 period of, 446
 value of, 442
- JETS**, 80
- LABORERS**, health of, 276
Lake-water, 99
Lake-water supplies, 113
Lard, adulteration of, 236
Latrines, 280, 312
Laundry, amount of water required for, 111
Law, milk, of Philadelphia, 221
Laws, quarantine, 448
Lean beef, 212
Length of working-day, influence of, 276
Leprosy, quarantine regulations, 491
Life, expectation of, 510
 mean duration of, 509
 probable duration of, 510
Light meat, effect of, 211
 ultra-violet, disinfection of water with, 138
Lighting, 285, 321
 of industrial establishments, 278
 of the vessel, 321
Lime, chlorinated, 429
 milk of, 429
 preparations of, 429
Liquid air, cooling by, 341
 formaldehyd-spraying, 426
Local quarantines, inspection of, 483
Location of camps, 309
Loss of heat from buildings, 86
Lungs, effect of exercise on, 242
- MALARIA**, immunity against, 386
 mosquitoes and, 384, 396
 prevention of, 384
Malt liquors, adulteration of, 236
Marches, 314
Marines, diseases among, 327
 selection of, 323
Maritime quarantine, 440, 447
Marmorek's antituberculosis serum, 365
Materials, infective, disinfection of, 431
Matter, organic, 53
Mean age at death, 509
 duration of life, 509
Means, mechanical, of ventilation, 79
Meat, 202
 composition of, 212
 effects of light and dark, 211
 inspection of, 203
 method of, 204
 preservation of, 208
 detection of preservatives, 209
 putrefactive changes in, 206
 relative composition of, 213
Mechanical filter, 125
 filtration, 125
 means of ventilation, 79

- Medical inspection of schools, 294
 Mental attitude, 261
 Method of protection, Haffkine, 368
 Methods of piping, 92
 of sewage purification, 161
 Garfield coal filters, 170
 sand filters, 161
 septic tank, 164
 subsurface irrigation, 164
 of ventilation, 68
 extraction and propulsion, 83
 natural and artificial, 84
 of water and sewage analysis, 139
 chemical analysis, 142
 collection of samples, 139
 microscopic examination, 142
 physical examination, 141
 purification, 117
 sand filtration, 119
 self-purification, 117
 Microscopic examination of water, 142
 Microsporion furfur, 416
 Military hygiene, 299
 Milk, adulteration of, 235
 and milk products, 214
 care of, 224
 cows', 214
 diseases conveyed by, 215
 law of Philadelphia, 221
 municipal control of, 221
 of lime, 429
 Milking, 223
 Mineral food, 232
 Minimum standard of daily diet, 193
 Modes of dissemination of disease, 348, 380
 Moist heat, 430
 Moisture, precipitation of, 42
 Moral training of the recruit, 303
 Mortality, comparative, 266, 267, 268
 infant, rate of, 508
 influence of climate upon, 49
 in relation to season, 509
 Moser's serum, 365
 Mosquitoes and filaria, 397
 and malaria, 384, 396
 and yellow fever, 386, 396
 Anopheles culex, 384, 385
 destruction of, 389
 protection from, 345
 Mouth, cleanliness of, 259
 Movements of the atmosphere, 41
 Muscles, effect of exercise on, 245
 Mustard, adulteration of, 236
 Mutton, 213

 NATURAL ventilation, 68
 arrangements in, 70

 Natural ventilation, comparison of, 84
 waters, comparison of, 99
 Nature of epidemics, 349
 of the atmosphere, 31
 Naval hygiene, 318
 vessels, regulations relating to, 483
 Necessity of system of notification, 512
 Nervous system, effect of exercise on, 246
 Nevo, 341
 Nitrate of silver, 429
 Nitrobenzine and compounds, effects of, 274
 Nitrogen as free and albuminoid ammonia, 145
 as nitrates, 146
 as nitrites, 145
 elimination, effect of exercise on, 246
 Nitrogenous matter, conversion of, in sewage purification, 171
 Non-alcoholic beverages, 233
 Normal feet, 253
 temperature and rainfall, 44
 Notification, interstate, of diseases, 493
 system of, 512
 Nutrition, influence of climate on, 46
 Nutritive value and cost of food, 186
 Nuts as food, 231

 OCCUPATION, nature of, 260
 Occupations, death-rate in, 508
 Oidiomycosis, 417
 Oidium albicans, 417
 Old age, diet for, 240
 Open fireplaces, 90
 Ophthalmologic-diagnostic test in typhoid fever, 378
 Oponins, 353
 Organic impurities in water, 106
 matter, 53
 in air, estimation of, 59
 Ornithodoris moubata, 398
 Outer garments, 306
 Oxidation, 117
 Oxygen consumed, 146
 dissolved, 147

 PARASITES, animal, 401
 prevention of infection by, 414
 vegetable, 416
 Paratyphoid fever, 207
 Particles, solid, in water, 104
 Passengers, 467

- Passengers, detention of, 467
 Passions, regulation of, 259
 Pathogenic bacteria in soil, 332
 persistence of, 383
 Patients, disinfection of, 435
 Pepper, adulteration of, 236
 Period of detention, 446
 of isolation, 446
 Persistence of bacteria in dead bodies, 383
 Personal hygiene, 258
 prophylaxis, 379
 Perspiration, impurities due to, 55, 60
 Petroleum, heating by means of, 95
 Philadelphia, milk law of, 221
 Physical agents in disinfection, 430
 examination of water, 141
 properties of water, 96
 training of the recruit, 302
 Physicians as carriers of infection, 379
 Piping, methods of, 92
 systems of, 91
 Piroplasma of dengue, 408
 Piroplasmoses, 405
 Plague-infected vessels, treatment of, 480
 Plague, prevention of spread of, in
 United States, 497
 protective inoculation against, 369
 regulations at ports, 480
 Plant, steam-disinfecting, 421
 Plasmodium of malaria, 403
 Plumbing, 342
 Poisoning, food-, 206
 Policing, sanitary, of camps, 310
 Pond-water supplies, 113
 Poor, houses for the, 342
 Population, density of, relation to
 death-rate, 511
 Pork, 213
 Ports, domestic, quarantine regula-
 tions for, 471
 foreign, quarantine regulations at,
 460
 infected with plague, regulations at,
 480
 of the United States, regulations for,
 471
 Position of blackboards, 286
 of the house, 334
 Potential energy in food, 187
 Poultry, 214
 Powders, baking, 229
 Precipitation, 117
 mean annual, 44
 of moisture, 42
 Predisposing causes of disease, 19
 Preparations of lime, 420
 Preservation of meat, 208
 Preservation of meat, detection of, 209
 Preservatives, food, 230
 Preserved vegetable foods, 231
 Pressure of the atmosphere, 34
 distribution of, 36
 Prevention of infection by animal
 parasites, 414
 of infection by active immunity, 367
 of malaria, 384
 of yellow fever, 386
 Preventive measures in infectious dis-
 eases, 380
 Probable duration of life, 510
 Proper soles, 253
 Properties, chemical, of water, 96
 Prophylaxis, personal, 379
 Propulsion method of ventilation, 83
 Protection against cold, 250
 against dampness, 251
 against heat, 251
 against injury, 252
 against small-pox, 373
 from flies and mosquitoes, 345
 Haffkine method of, 368
 Protozoan parasites, 402
 Psychrometer, 38
 Public conveyances, disinfection of,
 436
 Pumps, 80
 Purification of sewage, methods of, 161
 Cameron septic tank, 164
 Garfield coal filters, 170
 sand filters, 162
 subsurface irrigation, 164
 of water, 116
 methods of, 117
 filtration, 118
 without filtration, 132
 boiling, 133
 chemicals, 135
 distillation, 132
 sterilization, 133
 Purity, standard of, 65
 Putrefactive changes in meat, 206

 QUANTITATIVE bacterial examination
 of water, 148
 Quarantinable diseases, 460, 493
 Quarantine, 440
 disinfection in, 487
 general requirements at, 475
 house, 442, 500
 inland, 441
 interstate, 492
 general regulations, 493
 laws, 448
 local, 483
 maritime, 440, 447

- Quarantine regulations at domestic ports, 471
 at foreign ports, 460
 at ports of the United States, 471
 at sea, 470
 on frontiers, 481
 reservation, trespassing on, 458
 special, for fruit vessels, 488
 State, inspection of, 483
 regulations, 498
 treatment of vessels in, 460, 474
- RACE, 24
- Radiating surfaces, heat supplied by, 87
- Radiation, direct, 80, 90
 heat emitted by, 88
 indirect, 80, 93
- Radiators, steam, 90
 and hot water, 99
- Rainfall, normal, 44
- Rain-water, 97
 supplies, 112
- Ration, new, 305
- Rats, extermination of, 392
- Receptors, 356
- Records of inspections, 469
- Recruit, the, 299
 training of the, 302
 moral, 303
 physical, 302
- Regulations, quarantine, 493
 at domestic ports, 471
 at foreign ports, 460
- Relation of mortality to season, 509
- Relative humidity, 40
- Remote causes of disease, 18
- Removal and disposal of garbage, 181
 of sewage, 151
 Liernur system, 177
 of dust, 83
- Remsen's method of estimating organic matter in air, 60
- Reports of inspections, 469
- Requirements, sanitary, with regard to vessels, 464
 at sea, 470
- Residue on evaporation, 144
- Respiration, impurities due to, 52, 60
- Respiratory diseases, disinfection in, 433
- Ridge ventilation, 313
- River-water, 98
- Roaches and disease, 394
- Roast-beef hash, 305
- Roof, 335
- Room, disinfection of, 434
- Rooms, size of, 336
- Rules, fifty dairy, 222
 general, for ventilation, 68
- SAND filters, intermittent, 119
 filtration, 119
- Sanitary policing of camps, 310
 science, 27
- Scarlet fever, isolation and disinfection in, 444
- School-buildings, defects in, 292
- School hygiene, 281
- Schools, medical inspection of, 294
- Science, sanitary, 27
- Sea, quarantine requirements at, 470
- Season, influence upon mortality, 49
 relation of mortality to, 509
- Seats, 289
- Sea-water, 99
- Sedimentation, 117
- Selection of marines, 323
- Senses, examination of air by, 57
- Septic tank, 165
 sludge in, 169
- Serum, antimeningococcus, 365
 antistreptococcus, 363
 antitoxic, 360
 antituberculosis, of Marmorek, 365
 antityphoid, in army, 315
 bacteriolytic, 361
 diagnostic test for syphilis, 378
 Moser's, 365
 prophylaxis in acute infectious diseases, 366
 therapy in acute infectious diseases, 366
 typhoid immune, 361
- Sewage analysis, methods of, 139
 chemical, 142
 collection of samples, 139
 microscopic examination, 142
 physical examination, 141
 quantitative bacterial examination, 148
 chemical treatment of, 159
 commercial value of, 178
 purification, methods of, 161
 Cameron septic tank, 164
 conversion of nitrogenous matter, 171
 Garfield coal filters, 170
 sand filters, 162
 subsurface irrigation, 164
 removal and disposal, 151
 disposal, 151, 158, 289
 dry method, 157
 removal, 151
 Liernur system, 177
 streptococcus, of Houston, 102

- Sewer-air, 51
 Sex, 22
 Shoemaker's soles, 252, 253
 Sickness, sleeping, 403
 Sick-room, disinfection of, 432
 Side chains, 355
 Silver, nitrate of, 429
 Site, 281
 Size of rooms, 336
 Sleeping sickness, 404
 Sleeping-rooms, 337
 Sludge in septic tanks, 169
 Small-pox, animal parasites and, 407
 disinfection in, 406
 protection against, 373
 quarantine regulations, 479
 Soda, washing, 429
 Softening of hard water, 135
 Soil, 329
 covering, 332
 damp, improvement of, 332
 drainage, capacity of, 281
 pathogenic bacteria in, 332
 pipe, 155
 Soldier, clothing of, 305
 new ration for, 305
 Sole, correct, 252, 253
 shoemaker's, 252, 253
 Solid impurities in air, effects of, 63
 particles in water, 104
 Sources of impurities in air, 52
 of infection in infectious diseases, 380
 of water-supplies, 111
 ground-water, 114
 lake and pond, 113
 river, 113
 surface water, 111
 Space, cubic, 66, 282
 floor, 284
 window, 284
 Special regulations relating to naval vessels, 483
 Specifications for mechanical filter, 127
 purification required, 128
 regulation, 129
 tests, 129
 waste, 129
 Spotted fever of Rocky Mountains, 406, 408
 Spring-water, 97
 Sprinkling filters, 175
 Stable, 222
 Standard of age-distribution, 505
 of purity, 65
 State quarantines, 498
 inspection of, 483
 regulations, 498
 Statistics, vital, 503
 Steam disinfecting plant, 421
 disinfection by, 130
 heating by, 91
 radiators, 90, 93
 Steerage, disinfection of, 487
 Stegomyia fasciata, 387
 Sterilization of water by chemicals, 136
 Sterilizer, water, 134, 135, 306
 Storage of water, 116
 Stoves, 90
 Streptococcus sewage of Houston, 102
 Structure of walls, 282
 Sublimate, corrosive, 427
 Subsistence diet for adults, 239
 Subsurface irrigation, 164
 Sulphate of iron, 429
 Sulphur dioxide, 426, 484
 Sulphuric acid, 147
 Sunlight, action of, on bacteria, 420
 as a disinfectant, 431
 Supplies, water, from ground, 114
 from lake, 113
 from pond, 113
 from rain, 97
 from river, 113
 from spring, 97, 115
 from surface, 111
 from well, 98, 115
 Surface, configuration of, 332
 water, 111
 Surfaces, radiating, 87
 Susceptibility, 350
 Syphilis, serum diagnostic test for, 378
 System, contact-bed, 169
 Liernur, 177
 nervous, effect of exercise on, 246
 Systems of heating, 89, 93
 of notification, necessity for, 512
 of piping, 91
 TANKS, septic sludge in, 169
 Tea, adulteration of, 235
 Teeth, cleanliness of, 259
 Temperature of the air, 33
 difference in, 69
 normal, 44
 Tents, 309
 Tetanus antitoxin, 360
 Texas cattle fever, 406
 and *Boophilus bovis*, 393, 398
 Theatres, cooling of, 341
 Training of the recruit, moral, 303
 physical, 302
 Traps, 154
 anti-D trap, 155

- Traps, bell-trap, 154
 Mason's trap, 155
 S-trap, 154
 Treatment of infected vessels, 483
 in cholera, 476
 in yellow fever, 481
 of sewage, chemical, 159
 Trenner-Lea formaldehyd generator, 424
 Trichinosis, 414
 Trichophyton fungus, 416
 Trikresol, 428
 Tropical climate, influence on body, 46
 influence on nutrition, 47
 Trypanosomiasis, 403
 Tubercle bacillus, action of sunlight on, 420
 Tuberculosis, diagnosis, in children, 377
 protective vaccination of cattle against, 372
 Typhoid fever, 106
 ophthalgo-diagnostic test in, 378
 protective inoculation against, 371
 vaccination in army, 315, 371
 immune serum, 361
 Typhus fever, animal parasites and, 408
 disinfection in, 497
 quarantine regulations, 479
- ULTRA-VIOLET light, disinfection of water with, 138
 Uncinariasis, 413
 Underclothing, 306
 United States ports, quarantine regulations for, 471
 Utensils, milk, 225
- VACCINATED persons, quarantine regulations for, 468
 Vaccination, antityphoid, in army, 315, 371
 as protective against small-pox, 373
 against tuberculosis in cattle, 372
 precautions in, 376
 Value of isolation and disinfection, 442
 of sewage, commercial, 178
 Vapor, aqueous, 52
 clastic force of, 40
 Vcal, 212
 Vegetable foods, 227
 canned, adulteration of, 236
 preserved, 230
 parasites, 416
 Ventilation, 64, 287, 319, 339
 artificial, 78
 comparison of methods, 83, 84
 extraction methods, 83
 general rules for, 68
 natural, 68
 arrangements in, 70
 propulsion methods, 83
 ridge, 313
 Vermin, destruction of, 391
 Vessel, cleaning of, 321
 heating of, 321
 lighting of, 321
 Vessels, cholera-infected, treatment of, 476
 disinfection of, 483, 487
 cabin, 483, 487
 cargo, 487
 forecastle, 487
 holds, 487
 living compartments, 487
 state-rooms, 487
 steerage, 487
 fruit, special quarantine for, 488
 inspection of, 463
 naval, special regulations for, 483
 plague-infected, treatment of, 480
 requirements with regard to, 464
 in quarantine, 474
 water-supply of, 321
 yellow-fever infected, treatment of, 477
 Vinegar, adulteration of, 236
 Vital causes of disease, 346
 statistics, 503
 Vitiated air, effects of, 62
 Vitiating by respiration and perspiration, 60
 Von Pettenkofer method of estimating carbon dioxid in air, 58
- WALL-COVERING, 338
 Walls of house, 335
 structure of, 282
 Wardrobes, 286
 Warmth, degree of, 86
 Washing soda, 429
 Water analysis, method of, 139
 chemical, 142
 alkalinity, 146
 carbonic acid, 147
 chlorin, 144
 hardness, 146
 iron, 147
 nitrogen as ammonia, 145
 as nitrates, 146
 as nitrites, 145
 oxygen consumed, 146
 residue on evaporation, 144

- Water analysis, chemical, sulphuric acid,** 147
 collection of samples, 130
 microscopic, 142
 physical, 141
 quantitative bacterial, 148
and water-supply, 96, 289, 310, 321
 amount required, 111
as food, 201
 chemical composition of, 96
 disinfection of, with ultra-violet light, 138
 gaseous, 104
 ground-, 99, 114, 330
 impurities in, 100
 effects of, 104
 inorganic, 105
 organic, 106
 solid, 105
 lake-, 99
 physical properties of, 96
 pond-, 113
 purification of, 116
 methods of, 117
 filtration, 118
 self-purification, 117
 without filtration, 132
 by boiling, 133
 by chemicals, 135
 by distillation, 132
 by sterilization, 133
 rain-, 97
 river-, 98
 sea-, 99
 softening of, 135
- Water, spring-,** 97
 sterilization of, 136
 sterilizer, 134, 311
 storage of, 116
 suitability for boiler purposes, 138
 waste-preventer, 153
 well-, 98
Water-closet, 151, 280
 amount of water required for, 111
 hopper, 152
 pan, 152
 wash-down, 153
 wash-out, 153
Water-supplies, sources of, 111
 ground-water, 114
 lakes and ponds, 113
 rivers, 113
 surface water, 111
Waters, natural, comparison of, 99
Wells, artesian, 115
Well-water, 98
Wind, action of, 60
 effects upon health, 42
Window space, 284
Wooden vessels, disinfection of, 487
Working-day, influence of length of, 276
Work-rooms, air of, 55
Worms, parasitic, 410
- YELLOW fever, disinfection in,** 406
 of vessels in, 480
 mosquitoes and, 386, 390
 prevention of, 386
 quarantine regulations, 477, 494

SAUNDERS' BOOKS

— on —

SURGERY

and

ANATOMY

W. B. SAUNDERS COMPANY
925 WALNUT STREET PHILADELPHIA
9, HENRIETTA STREET COVENT GARDEN, LONDON

SAUNDERS' REMARKABLE SUCCESS

WE are often asked to account for our extraordinary success. We can but point to modern business methods, carefully perfected business machinery, and unrivalled facilities for distribution of books. Every department is so organized that the greatest possible amount of work is produced with the least waste of energy. The representatives of the firm are men with life-long experience in the sale of medical books. Then, too, we must not overlook that major force in the modern business world—**advertising**. We have a special department devoted entirely to the planning, writing, and placing of advertising matter; and we might mention that the money annually spent in advertising now far exceeds the entire annual receipts of the House during its earlier years. These extraordinary facilities for disposing of large editions enable us to devote a large amount of money to the perfecting of every detail in the manufacture of books.

A Complete Catalogue of our Publications will be Sent upon Request

Keen's Surgery

AN UNABRIDGED TREATISE FOR THE SURGEON AND
THE GENERAL PRACTITIONER

Surgery: ITS PRINCIPLES AND PRACTICE. Written by 56 eminent specialists. Edited by W. W. KEEN, M.D., LL.D., HON. F.R.C.S., ENG. AND EDIN., Emeritus Professor of the Principles of Surgery and of Clinical Surgery at the Jefferson Medical College. Five octavos of 1000 pages each, containing 2588 original illustrations, 136 in colors. Per volume: Cloth, \$7.00 net; Half Morocco, \$8.00 net.

IN FIVE VOLUMES—2588 ILLUSTRATIONS, 136 IN COLORS

THE EMINENT CONTRIBUTORS

| | | |
|----------------------------|-----------------------------|-----------------------------------|
| Robert Abbe, M.D. | D. N. Eisendrath, M.D. | E. E. Montgomery, M.D. |
| J. G. Adami, M.D. | Wm. L. Estes, M.D. | B. G. A. Moynihan, F.R.C.S. |
| E. Wyllys Andrews, M.D. | J. M. T. Finney, M.D. | J. G. Mumford, M.D. |
| G. E. Armstrong, M.D. | John M. Fisher, M.D. | John C. Munro, M.D. |
| A. D. Bevan, M.D. | John A. Fordyce, M.D. | John B. Murphy, M.D. |
| Warren S. Bickham, M.D. | Chas. H. Frazier, M.D. | E. H. Nichols, M.D. |
| John F. Binnie, M.D. | Leonard Freeman, M.D. | A. J. Ochsner, M.D. |
| P. Brooke Bland, M.D. | Frederick H. Gerrish, M.D. | Surg.-Gen. R. M. O'Reilly, U.S.A. |
| George E. Brewer, M.D. | John H. Gibbon, M.D. | Edmund Owen, F.R.C.S. |
| J. Bland-Sutton, F.R.C.S. | Georg Gottstein, M.D. | Jos. Ransohoff, M.D., F.R.C.S. |
| A. T. Cabot, M.D. | Hobart A. Hare, M.D. | Surg.-Gen. P. M. Rixey, U.S.N. |
| Hampton L. Carson, Esq. | Ludvig Hektoen, M.D. | John B. Roberts, M.D. |
| E. A. Codman, M.D. | Orville Horwitz, M.D. | A. W. Mayo Robson, F.R.C.S. |
| Wm. B. Coley, M.D. | Allen B. Kanavel, M.D. | W. L. Rodman, M.D. |
| W. M. L. Coplin, M.D. | Albert Kocher, M.D. | Eugene A. Smith, M.D. |
| George W. Crile, M.D. | Karl Gustav Lennander, M.D. | Harmon Smith, M.D. |
| Harvey Cushing, M.D. | Bransford Lewis, M.D. | Wm. G. Spiller, M.D. |
| J. Chalmers DaCosta, M.D. | R. W. Lovett, M.D. | Weller Van Hook, M.D. |
| John C. DaCosta, Jr., M.D. | Edward Martin, M.D. | J. P. Warbasse, M.D. |
| E. B. Dench, M.D. | Rudolph Matas, M.D. | F. C. Wood, M.D. |
| F. X. Dercum, M.D. | Chas. A. Mayo, M.D. | George Woolsey, M.D. |
| G. E. deSchweinitz, M.D. | Wm. J. Mayo, M.D. | Hugh H. Young, M.D. |
| David L. Edsall, M.D. | Maj. Walter D. McCaw, M.D. | Fredrik Zachrisson, M.D. |

Crandon and Ehrenfried's Surgical After-treatment

Surgical After-treatment. A Manual of the Conduct of Surgical Convalescence. By L. R. G. CRANDON, M. D., Assistant in Surgery, and ALBERT EHRENFRIED, M. D., Assistant in Anatomy, Harvard Medical School. Octavo of 831 pages, with 265 original illustrations. Cloth, \$6.00 net; Half Morocco, \$7.50 net.

JUST READY—NEW (2d) EDITION, PRACTICALLY REWRITTEN

This work tells how best to manage all problems and emergencies of surgical convalescence from recovery-room to discharge. It gives *all the details* completely, definitely, yet concisely, and does not refer the reader to some other work perhaps not then available. The post-operative conduct of all operations is given, arranged alphabetically by regions. A special feature is the elaborate chapter on *Vaccine Therapy, Immunization by Inoculation and Specific Sera*, by Dr. George P. Sanborn, a disciple of Sir A. E. Wright. The text is illustrated.

The Therapeutic Gazette

"The book is one which can be read with much profit by the active surgeon and will be generally commended by him."

Collected Papers by the Staff of St. Mary's Hospital, Mayo Clinic

Collected Papers by the Staff of St. Mary's Hospital, Mayo Clinic. By WILLIAM J. MAYO, M.D., CHARLES H. MAYO, M.D., and their ASSOCIATES at St. Mary's Hospital, Rochester, Minn. 1905-1909 papers: Octavo of 668 pages, with 226 illustrations. Cloth, \$5.50 net. 1910 papers: Octavo of 635 pages, with 308 illustrations. Cloth, \$5.50 net.

PAPERS 1905-1909; PAPERS 1910; PAPERS 1911 (Just Ready)

Many of these papers have been read before medical societies and all of them have been published in current medical literature. The chief reason for bringing them together in the present form is for convenience of reference. The original plan was to have the papers printed for private distribution only, but at the instance of numerous members of the medical profession, the authors have consented to having the book placed on the market. The text is profusely illustrated with original illustrations.

Bulletin Medical and Chirurgical Faculty of Maryland

"Much of the work done at the Mayo Clinic and recorded in these papers has been epoch-making in character. * * * Represents a most substantial block of modern surgical progress."

Cotton's Dislocations and Joint Fractures

Dislocations and Joint Fractures. By FREDERIC JAY COTTON, M. D., First Assistant Surgeon to the Boston City Hospital. Octavo of 654 pages, with 1201 original illustrations. Cloth, \$6.00 net; Half Morocco, \$7.50 net.

TWO PRINTINGS IN EIGHT MONTHS

Dr. Cotton's clinical and teaching experience in this field has especially fitted him to write a practical work on this subject. He has written a book clear and definite in style, systematic in presentation, and accurate in statement. The illustrations possess the feature of showing just those points the author wishes to emphasize. This is made possible because the author is himself the artist.

Boston Medical and Surgical Journal

"The work is delightful, spirited, scholarly, and original, and is not only a book of reference, but a book for casual reading. It brings the subject up to date, a feat long neglected."

Murphy's Famous Clinics

Surgical Clinics of John B. Murphy, M. D., at Mercy Hospital, Chicago. Issued serially, one number every other month (six numbers a year). Each issue about 150 octavo pages, illustrated. Per year: \$8.00; Cloth, \$12.00. Sold only by the year.

DOWN-TO-THE-MINUTE SURGERY

This is just the work you have been waiting for—a permanent record of the teachings of this great surgeon. These are *not* students' clinics, but delivered at Mercy Hospital, Chicago, *for physicians only*. They are *postgraduate clinics*. These CLINICS are published *just as delivered* by Dr. Murphy, an expert stenographer taking down everything Dr. Murphy says and does. In this way these CLINICS retain all that individual force and charm so characteristic of the clinical teaching of this distinguished surgeon. But the most vital point about *these* CLINICS is that they are *absolutely fresh*. They are surgery—practical, *applied* surgery—right down to the minute, published practically as soon as delivered. There is no stale matter. Everything is *new, never having appeared in print before*. It is all *live* clinical material.

Kelly & Noble's Gynecology and Abdominal Surgery

Gynecology and Abdominal Surgery. Edited by HOWARD A. KELLY, M.D., Professor of Gynecology in Johns Hopkins University; and CHARLES P. NOBLE, M.D., formerly Clinical Professor of Gynecology in the Woman's Medical College, Philadelphia. Two imperial octavo volumes of 950 pages each, containing 880 original illustrations, some in colors. Per volume: Cloth, \$8.00 net; Half Morocco, \$9.50 net.

WITH 880 ILLUSTRATIONS—TRANSLATED INTO SPANISH

This work possesses a number of valuable features not to be found in any other publication covering the same fields. It contains a chapter upon the bacteriology and one upon the pathology of gynecology, and a large chapter devoted entirely to *medical gynecology*, written especially for the physician engaged in general practice. *Abdominal surgery* proper, as distinct from gynecology, is fully treated, embracing operations upon the stomach, intestines, liver, bile-ducts, pancreas, spleen, kidneys, ureter, bladder, and peritoneum.

American Journal of Medical Sciences

"It is needless to say that the work has been thoroughly done; the names of the authors and editors would guarantee this, but much may be said in praise of the method of presentation, and attention may be called to the inclusion of matter not to be found elsewhere."

Bickham's Operative Surgery

A Text-Book of Operative Surgery. By WARREN STONE BICKHAM, M.D., of New York. Octavo of 1200 pages, with 854 original illustrations. Cloth, \$6.50 net; Half Morocco, \$8.00 net.

THE NEW (3d) EDITION

This work completely covers the surgical anatomy and operative technic involved in the operations of general surgery. The practicability of the work is particularly emphasized in the 854 magnificent illustrations.

Boston Medical and Surgical Journal

"The book is a valuable contribution to the literature of operative surgery. It represents a vast amount of careful work and technical knowledge on the part of the author. For the surgeon in active practice or the instructor of surgery it is an unusually good review of the subject."

Mumford's Practice of Surgery

The Practice of Surgery. By JAMES G. MUMFORD, M. D., Instructor in Surgery, Harvard Medical School. Octavo of 1015 pages, with 682 illustrations. Cloth, \$7.00 net; Half Morocco, \$8.50 net.

DIFFERENT FROM OTHER SURGERIES.

This, as its title implies, is a work on the *clinical* side of surgery—surgery as it is seen at the bedside, in the accident ward, and in the operating room. It expresses the matured outgrowth of twenty years of active hospital and private surgical practice, together with the experience gained from clinical teaching, classroom discussions, and lectures.

John B. Murphy, M.D., *Professor of Surgery, Northwestern Medical School, Chicago.*

"This work truly represents Dr. Mumford's intellectual capacity and scope, and presents in a terse, forceful, yet pleasing manner, the live surgical topics of the day. It is in every particular up to date, and shows that rare quality of accentuating the essential and omitting the unnecessary."

DaCosta's Modern Surgery

Modern Surgery—GENERAL AND OPERATIVE. By JOHN CHALMERS DACOSTA, M. D., Samuel D. Gross Professor of Surgery, Jefferson Medical College, Philadelphia. Octavo of 1502 pages, with 966 illustrations. Cloth, \$5.50 net; Half Morocco, \$7.00 net.

NEW (6th) EDITION—INCREASED TO 1500 PAGES

A surgery, to be of the maximum value, must be up to date, must be complete, must have behind its statements the sure authority of experience, must be so arranged that it can be consulted quickly; in a word, it must be practical and dependable. Such a surgery is DaCosta's. Always an excellent work, for this edition it has been very materially improved by the addition of new matter to the extent of over 200 pages and by a most thorough revision of the old matter. Many old cuts have been replaced by new ones, and nearly 100 additional illustrations have been added. Notwithstanding this large addition of matter, the *price has not been increased.*

Rudolph Matas, M. D., *Professor of Surgery, Tulane University of Louisiana.*

"This edition is destined to rank as high as its predecessors, which have placed the learned author in the fore of text-book writers. The more I scrutinize its pages the more I admire the marvelous capacity of the author to compress so much knowledge in so small a space."

Scudder's Treatment of Fractures

WITH NOTES ON DISLOCATIONS

The Treatment of Fractures: with Notes on a few Common Dislocations. By CHARLES L. SCUDDER, M. D., Surgeon to the Massachusetts General Hospital, Boston. Octavo of 708 pages, with 994 original illustrations. Polished Buckram, \$6.00 net; Half Morocco, \$7.50 net.

JUST READY—THE NEW (7th) EDITION
OVER 33,500 COPIES

The fact that this work has attained a seventh edition indicates its practical value. In this edition Dr. Scudder has made numerous additions throughout the text, and has added many new illustrations, greatly enhancing the value of the work. In every way this new edition reflects the very latest advances in the treatment of fractures.

J. F. Binnie, M.D., University of Kansas

"Scudder's Fractures is the most successful book on the subject that has ever been published. I keep it at hand regularly."

Scudder's Tumors of the Jaws

Tumors of the Jaws. By CHARLES L. SCUDDER, M. D., Surgeon to the Massachusetts General Hospital, Boston. Octavo of 395 pages, with 353 illustrations, 6 in colors. Cloth, \$6.00 net; Half Morocco, \$7.50 net.

JUST READY—NEW ILLUSTRATIONS

Dr. Scudder in this book tells you how to determine in each case the *form* of new growth present and then points out the best treatment. As the tendency of malignant disease of the jaws is to grow into the accessory sinuses and toward the base of the skull, an intimate knowledge of the anatomy of these sinuses is essential. Dr. Scudder has included, therefore, sufficient anatomy and a number of illustrations of an anatomic nature. Whether general practitioner or surgeon, you need this new book because it gives you just the information you want.

Sisson's Veterinary Anatomy

Text-Book of Veterinary Anatomy. By SEPTIMUS SISSON, S. B., V. S., Professor of Comparative Anatomy in Ohio State University. Octavo volume of 826 pages, with 588 illustrations, mostly original and many in colors. Cloth, \$7.00 net; Half Morocco, \$8.50 net.

WITH SUPERB ILLUSTRATIONS

This is a clear and concise statement of the essential facts regarding the structure of the principal domesticated animals, containing many hitherto unpublished data resulting from the detailed study of formalin-hardened subjects and frozen sections. Nearly all of the illustrations are original, the majority being reproduced from photographs, and colors frequently used. The terminology has been carefully revised with reference to the B. N. A. and the nomenclature adopted by European comparative anatomists.

Boston Medical and Surgical Journal

"It is not amiss to say that the work ranks with the best. A marked advance in English veterinary literature, upon which student and practitioner may well congratulate themselves and no medical school can afford to be without. It is an exhaustive gross anatomy of the horse, ox, pig, and dog, including the splanchnology of the sheep."

Gant on Constipation and Intestinal Obstruction

Constipation and Intestinal Obstruction. By SAMUEL G. GANT, M. D., Professor of Diseases of the Rectum and Anus, New York Post-Graduate Medical School and Hospital. Octavo of 559 pages, with 250 original illustrations. Cloth, \$6.00 net; Half Morocco, \$7.50 net.

INCLUDING RECTUM AND ANUS

In this work the consideration given to the medical treatment of constipation is unusually extensive. The practitioner will find of great assistance the chapter devoted to formulas. The descriptions of the operative procedures are concise, yet fully explicit.

The Proctologist

"Were the profession better posted on the contents of this book there would be less suffering from the ill effects of constipation. We congratulate the author on this most complete book."

Moynihan's Duodenal Ulcer

Duodenal Ulcer. By B. G. A. MOYNIHAN, M.S. (LONDON), F.R.C.S., Leeds, England. Octavo of 486 pages, illustrated. Cloth, \$5.00 net; Half Morocco, \$6.50 net.

JUST READY—NEW (2d) EDITION

For this edition the work has been entirely reset and brought up to date. All the cases operated upon since the appearance of the first edition have been included and a new chapter added on Jejunal and Gastro-jejunal Ulcers.

Moynihan's Abdominal Operations

Abdominal Operations. By B. G. A. MOYNIHAN, M. S. (LONDON), F. R. C. S., Leeds, England. Octavo, beautifully illustrated.

THE NEW (3d) EDITION—PREPARING

Edward Martin, M. D., *University of Pennsylvania.*

"It is a wonderfully good book. He has achieved complete success in illustrating, both by words and pictures, the best technic of the abdominal operations now commonly performed."

Moynihan on Gall-stones

Gall-Stones and Their Surgical Treatment.—By B. G. A. MOYNIHAN, M. S. (LONDON), F. R. C. S., Leeds, England. Octavo of 458 pages, illustrated. Cloth, \$5.00 net; Half Morocco, \$6.50 net.

THE NEW (2d) EDITION

Mr. Moynihan, in revising his book, has made many additions to the text, so as to include the most recent advances. Especial attention has been given to a detailed description of the early symptoms in cholelithiasis, enabling a diagnosis to be made in the stage in which surgical treatment can be most safely adopted.

British Medical Journal

"He expresses his views with admirable clearness, and he supports them by a large number of clinical examples, which will be much prized by those who know the difficult problems and tasks which gall-stone surgery not infrequently presents."

Dannreuther's Minor and Emergency Surgery

Minor and Emergency Surgery. By WALTER T. DANNREUTHER, M. D., Surgeon to St. Elizabeth's Hospital and to St. Bartholomew's Clinic, New York City. 12mo of 225 pages, illustrated. Cloth, \$1.25 net.

JUST ISSUED

Dr. Dannreuther emphasizes just those points most necessary in emergency work, giving numerous hints and suggestions that cannot help but be of great value to you in emergency work and in minor operations.

Eisendrath's Surgical Diagnosis

A Text-Book of Surgical Diagnosis. By DANIEL N. EISENDRATH, M.D., Professor of Surgery in the College of Physicians and Surgeons, Chicago. Octavo of 885 pages, with 574 entirely new and original text-illustrations and some colored plates. Cloth, \$6.50 net; Half Morocco, \$8.00 net.

THE NEW (2d) EDITION

Of first importance in every surgical condition is a correct diagnosis, for upon this depends the treatment to be pursued; and the two—diagnosis and treatment—constitute the most practical part of practical surgery. Dr. Eisendrath takes up each disease and injury amenable to surgical treatment, and sets forth the means of correct diagnosis in a systematic and comprehensive way. Definite directions as to methods of examination are presented clearly and concisely, providing for all contingencies that might arise in any given case. Each illustration indicates precisely how to diagnose the condition considered.

Surgery, Gynecology, and Obstetrics

"The book is one which is well adapted to the uses of the practising surgeon who desires information concisely and accurately given. . . . Nothing of diagnostic importance is omitted, yet the author does not run into endless detail."

Eisendrath's Clinical Anatomy

A Text-Book of Clinical Anatomy. By DANIEL N. EISENDRATH, A.B., M.D., Professor of Surgery in the College of Physicians and Surgeons, Chicago. Octavo of 535 pages, illustrated. Cloth, \$5.00 net; Half Morocco, \$6.50 net.

THE NEW (2d) EDITION

This new anatomy discusses the subject from the clinical standpoint. A portion of each chapter is devoted to the examination of the living through palpation and marking of surface outlines of landmarks, vessels, nerves, thoracic and abdominal viscera. The illustrations are from new and original drawings and photographs. This edition has been carefully revised.

Medical Record, New York

"A special recommendation for the figures is that they are mostly original and were made for the purpose in view. The sections of joints and trunks are those of formalized cadavers and are unimpeachable in accuracy."

Fenger Memorial Volumes

Fenger Memorial Volumes. Edited by LUDVIG HEKTOEN, M. D., Professor of Pathology, Rush Medical College, Chicago. Two octavos of 525 pages each. Per set: Cloth, \$15.00 net; Half Morocco, \$18.00 net.

JUST READY—LIMITED EDITION

These handsome volumes consist of all the important papers written by the late Christian Fenger, for many years professor of surgery at Rush Medical College, Chicago. Not only the papers published in English are included, but also those which originally appeared in Danish, German, and French.

The name of Christian Fenger typifies thoroughness, extreme care, deep research, and sound judgment. His contributions to the advancement of the world's surgical knowledge are indeed as valuable and interesting reading to-day as at the time of their original publication. They are pregnant with suggestions. Fenger's literary prolificacy may be judged from this memorial volume—over 1000 pages.

Sobotta and McMurrich's Human Anatomy

Atlas and Text-Book of Human Anatomy. In Three Volumes. By J. SOBOTTA, M.D., of Würzburg. Edited, with additions, by J. PLAYFAIR McMURRICH, A. M., Ph. D., Professor of Anatomy, University of Toronto, Canada. Three large quartos, each containing about 250 pages of text and over 300 illustrations, mostly in colors. Per volume: Cloth, \$6.00 net; Half Morocco, \$7.50 net.

VOLUME III NOW READY—COMPLETING THE WORK

The great advantage of this over other similar works lies in the large number of magnificent lithographic plates which it contains, without question the best that have ever been produced in this field. They are accurate and beautiful reproductions of the various anatomic parts represented.

Edward Martin, M.D., *Professor of Clinical Surgery, University of Pennsylvania.*

"This is a piece of bookmaking which is truly admirable, with plates and text so well chosen and so clear that the work is most useful to the practising surgeon."

Morris' Dawn of the Fourth Era in Surgery

DAWN OF THE FOURTH ERA IN SURGERY AND OTHER ARTICLES. By ROBERT T. MORRIS, M. D., Professor of Surgery, New York Post-Graduate Medical School and Hospital. 12mo of 145 pages, illustrated. \$1.25 net.

Bier's Hyperemic Treatment

By **WILLY MEYER, M. D.,** and **Prof. V. SCHMIEDEN**

Bier's Hyperemic Treatment in Surgery, Medicine, and the Specialties: A Manual of its Practical Application. By **WILLY MEYER, M. D.,** Professor of Surgery at the New York Post-Graduate Medical School and Hospital; and **PROF. DR. VICTOR SCHMIEDEN,** Assistant to Prof. Bier, University of Berlin, Germany. Octavo of 280 pages, with original illustrations. Cloth, \$3.00 net.

NEW (2d) EDITION—FOR THE PRACTITIONER

For the *practitioner* this work has a particular value, because it gives special attention to the hyperemic treatment of those conditions with which he comes in daily contact. Yet the needs of the *surgeon* and the *specialist* have not, by any means, been neglected. The work is not a translation, but an entirely original book, by Dr. Willy Meyer, who has practised the treatment for the past fifteen years, and Prof. Schmieden, Professor Bier's assistant at Berlin University. In the first part the three methods of inducing hyperemia are described; in the second, are taken up the details of application.

New York State Journal of Medicine

"We commend this work to all those who are interested in the treatment of infections, either acute or chronic, for it is the only authoritative treatise we have in the English language."

Campbell's Surgical Anatomy

A Text-Book of Surgical Anatomy. By **WILLIAM FRANCIS CAMPBELL, M. D.,** Professor of Anatomy, Long Island College Hospital. Octavo of 675 pages, with 319 original illustrations. Cloth, \$5.00 net; Half Morocco, \$6.50 net.

THE NEW (2d) EDITION

The first aim in the preparation of this original work was to emphasize the practical. It is in the fullest sense an applied anatomy—an anatomy that will be of inestimable value to the surgeon because only those facts are discussed and only those structures and regions emphasized that have a peculiar interest to him. Dr. Campbell has treated his subject in a very systematic way. The magnificent original illustrations will be found extremely practical.

Boston Medical and Surgical Journal

"The author has an excellent command of his subject, and treats it with the freedom and conviction of the experienced anatomist. He is also an admirable clinician."

Schultze and Stewart's Topographic Anatomy

Atlas and Text-Book of Topographic and Applied Anatomy. By PROF. DR. O. SCHULTZE, of Würzburg. Edited, with additions, by GEORGE D. STEWART, M.D., Professor of Anatomy and Clinical Surgery, University and Bellevue Hospital Medical College, N. Y. Large quarto of 189 pages, with 25 colored figures on 22 colored lithographic plates, and 89 text-cuts, 60 in colors. Cloth, \$5.50 net.

"I regard Schultze and Stewart's Topographic and Applied Anatomy as a very admirable work, for students especially, and I find the plates and the text excellent."—*Arthur Dean Bevan, M.D., Professor of Surgery in Rush Medical College, Chicago.*

Griffith's Hand-Book of Surgery

A Manual of Surgery. By FREDERIC R. GRIFFITH, M. D., Surgeon to the Bellevue Dispensary, New York City. 12mo of 579 pages, with 417 illustrations. Flexible leather, \$2.00 net.

"Well adapted to the needs of the student and to the busy practitioner for a hasty review of important points in surgery."—*American Medicine.*

Keen's Addresses and Other Papers

Addresses and Other Papers. Delivered by WILLIAM W. KEEN, M. D., LL.D., F. R. C. S. (Hon.), Professor of the Principles of Surgery and of Clinical Surgery, Jefferson Medical College, Philadelphia. Octavo volume of 441 pages, illustrated. Cloth, \$3.75 net.

Keen on the Surgery of Typhoid

The Surgical Complications and Sequels of Typhoid Fever. By WM. W. KEEN, M.D., LL.D., F.R.C.S. (Hon.), Professor of the Principles of Surgery and of Clinical Surgery, Jefferson Medical College, Philadelphia, etc. Octavo volume of 386 pages, illustrated. Cloth, \$3.00 net.

"Every surgical incident which can occur during or after typhoid fever is amply discussed and fully illustrated by cases. . . . The book will be useful both to the surgeon and physician."—*The Practitioner, London.*

Gould's Operations on Intestines and Stomach

The Technic of Operations Upon the Intestines and Stomach. By ALFRED H. GOULD, M. D., of Boston. Large octavo, with 190 original illustrations, some in colors. Cloth, \$5.00 net; Half Morocco, \$6.50 net.

"The illustrations are so good that one scarcely needs the text to elucidate the steps of the operations described. The work represents the best surgical knowledge and skill."—*New York State Journal of Medicine.*

Haynes' Anatomy

A Manual of Anatomy. By IRVING S. HAYNES, M.D., Professor of Practical Anatomy, Cornell University Medical College. Octavo, 680 pages, with 42 diagrams and 134 full-page half-tones. Cloth, \$2.50 net.

American Pocket Dictionary

New (7th) Edition

The American Pocket Medical Dictionary. Edited by W. A. NEWMAN DORLAND, A. M., M. D., Editor "American Illustrated Medical Dictionary." 610 pages. Full leather, limp, with gold edges, \$1.00 net; with patent thumb index, \$1.25 net.

McClellan's Art Anatomy

Anatomy in its Relation to Art. By GEORGE MCCLELLAN, M. D., Professor of Anatomy, Pennsylvania Academy of the Fine Arts. Quarto volume, 9 by 12½ inches, with 338 original drawings and photographs, and 260 pages of text. Dark blue vellum, \$10.00 net; Half Russia, \$12.50 net.

Fowler's Surgery

In Two Volumes

A Treatise on Surgery. By GEORGE R. FOWLER, M. D., Emeritus Professor of Surgery, New York Polyclinic. Two imperial octavos of 725 pages each, with 888 original text-illustrations and 4 colored plates. Per set: Cloth, \$15.00 net; Half Morocco, \$18.00 net.

International Text-Book of Surgery

Second Edition

The International Text-Book of Surgery. In two volumes. By American and British authors. Edited by J. COLLINS WARREN, M. D., LL. D., F. R. C. S. (Hon.), Professor of Surgery, Harvard Medical School; and A. PEARCE GOULD, M. S., F. R. C. S., of London, England. Vol. I.: *General and Operative Surgery*. Royal octavo, 975 pages, 461 illustrations, 9 full-page colored plates. Vol. II.: *Special or Regional Surgery*. Royal octavo, 1122 pages, 499 illustrations, and 8 full-page colored plates. Per volume: Cloth, \$5.00 net; Half Morocco, \$6.50 net.

American Text-Book of Surgery

Fourth Edition

American Text-Book of Surgery. Edited by W. W. KEEN, M. D., LL. D., HON. F. R. C. S., ENG. and EDIN., and J. WILLIAM WHITE, M. D., PH. D. Octavo, 1363 pages, 551 text-cuts and 39 colored and half-tone plates. Cloth, \$7.00 net; Half Morocco, \$8.50 net.

Robson and Cammidge on the Pancreas

The Pancreas: Its Surgery and Pathology. By A. W. MAYO ROBSON, F. R. C. S., of London, England; and P. J. CAMMIDGE, F. R. C. S., of London, England. Octavo of 546 pages, illustrated. Cloth, \$5.00 net; Half Morocco, \$6.50 net.

American Illustrated Dictionary**The New (6th) Edition**

The American Illustrated Medical Dictionary. With tables of Arteries, Muscles, Nerves, Veins, etc.; of Bacilli, Bacteria, etc.; Eponymic Tables of Diseases, Operations, Stains, Tests, etc. By W. A. NEWMAN DORLAND, M.D. Large octavo, 935 pages. Flexible leather, \$4.50 net; with thumb index, \$5.00 net.

Howard A. Kelly, M.D., *Professor of Gynecology, Johns Hopkins University, Baltimore.*

"Dr. Dorland's dictionary is admirable. It is so well gotten up and of such convenient size. No errors have been found in my use of it."

Golebiewski and Bailey's Accident Diseases

Atlas and Epitome of Diseases Caused by Accidents. By DR. ED. GOLEBIEWSKI, of Berlin. Edited, with additions, by PEARCE BAILEY, M.D. Consulting Neurologist to St. Luke's Hospital, New York City. With 71 colored figures on 40 plates, 143 text-cuts, and 549 pages of text. Cloth, \$4.00 net. *In Saunders' Hand-Atlas Series.*

Helferich and Bloodgood on Fractures

Atlas and Epitome of Traumatic Fractures and Dislocations By PROF. DR. H. HELFERICH, of Greifswald, Prussia. Edited, with additions, by JOSEPH C. BLOODGOOD, M. D., Associate in Surgery, Johns Hopkins University, Baltimore. 216 colored figures on 64 lithographic plates, 190 text-cuts, and 353 pages of text. Cloth, \$3.00 net. *In Saunders' Atlas Series.*

Sultan and Coley on Abdominal Hernias

Atlas and Epitome of Abdominal Hernias. By PR. DR. G. SULTAN, of Gottingen. Edited, with additions, by WM. B. COLEY, M. D., Clinical Lecturer and Instructor in Surgery, Columbia University, New York. 119 illustrations, 36 in colors, and 277 pages of text. Cloth, \$3.00 net. *In Saunders' Hand-Atlas Series.*

Warren's Surgical Pathology**Second Edition**

Surgical Pathology and Therapeutics. By J. COLLINS WARREN, M.D., LL.D., F.R.C.S. (HON.), Professor of Surgery, Harvard Medical School. Octavo, 873 pages; 136 illustrations, 33 in colors. Cloth, \$5.00 net; Half Morocco, \$6.50 net.

Zuckerkindl and DaCosta's Surgery**Second Edition**

Atlas and Epitome of Operative Surgery. By DR. O. ZUCKERKANDL, of Vienna. Edited, with additions, by J. CHALMERS DACOSTA, M.D., Samuel D. Gross Professor of Surgery, Jefferson Medical College, Philadelphia. 40 colored plates, 278 text-cuts, and 410 pages of text. Cloth, \$3.50 net. *In Saunders' Atlas Series.*

Moore's Orthopedic Surgery

A Manual of Orthopedic Surgery. By JAMES E. MOORE, M.D., Professor of Clinical Surgery, University of Minnesota, College of Medicine and Surgery Octavo of 356 pages, handsomely illustrated. Cloth, \$2.50 net

"The book is eminently practical. It is a safe guide in the understanding and treatment of orthopedic cases. Should be owned by every surgeon and practitioner."—*Annals of Surgery*

Fowler's Operating Room

New (2d) Edition

The Operating Room and the Patient. By RUSSELL S. FOWLER, M. D. Surgeon to the German Hospital, Brooklyn, New York. Octavo of 28 pages, illustrated. Cloth, \$2.00 net

Dr. Fowler has written his book for surgeons, nurses assisting at an operation, internes and all others whose duties bring them into the operating room. It contains explicit directions for the preparation of material, instruments needed, position of patient, etc. all beautifully illustrated.

Nancrede's Principles of Surgery

New (2d) Edition

Lectures on the Principles of Surgery. By CHAS. B. NANCREDE, M. D., LL. D., Professor of Surgery and of Clinical Surgery, University of Michigan, Ann Arbor. Octavo, 407 pages, illustrated. Cloth, \$2.50 net.

"We can strongly recommend this book to all students and those who would see something of the scientific foundation upon which the art of surgery is built."—*Quarterly Medical Journal Sheffield, England.*

Nancrede's Essentials of Anatomy.

Seventh Edition

Essentials of Anatomy, including the Anatomy of the Viscera. By CHAS. B. NANCREDE, M. D., Professor of Surgery and of Clinical Surgery, University of Michigan, Ann Arbor. Crown octavo, 388 pages; 180 cuts. With an Appendix containing over 60 illustrations of the osteology of the body. Based on *Gray's Anatomy*. Cloth, \$1.00 net. *In Saunders' Question Compend.*

"The questions have been wisely selected, and the answers accurately and concisely given."—*University Medical Magazine.*

Martin's Essentials of Surgery.

Seventh Edition
Revised

Essentials of Surgery. Containing also Venereal Diseases, Surgical Landmarks, Minor and Operative Surgery, and a complete description, with illustrations, of the Handkerchief and Roller Bandages. By EDWARD MARTIN, A. M., M. D., Professor of Clinical Surgery, University of Pennsylvania, etc. Crown octavo, 338 pages, illustrated. With an Appendix on Antiseptic Surgery, etc. Cloth, \$1.00 net. *In Saunders' Question Compend.*

"Written to assist the student, it will be of undoubted value to the practitioner, containing as it does the essence of surgical work."—*Boston Medical and Surgical Journal.*

Martin's Essentials of Minor Surgery, Bandaging, and Venereal Diseases.

Second Revised
Edition

Essentials of Minor Surgery, Bandaging, and Venereal Diseases. By EDWARD MARTIN, A. M., M. D., Professor of Clinical Surgery, University of Pennsylvania, etc. Crown octavo, 166 pages, with 78 illustrations.

Cloth, \$1.00 net. *In Saunders' Question Compend.*

"The best condensation of the subjects of which it treats yet placed before the profession."—*The Medical News, Philadelphia.*





LANE MEDICAL LIBRARY

To avoid fine, this book should be returned on
or before the date last stamped below.

| | | |
|--|--|--|
| | | |
|--|--|--|

