



J. B. Witman
"B."

*Carpenter, William B.
Principles of human
physiology
1847*



0 0301 0047308 8

[Handwritten scribble]

DR. CARPENTER'S PHYSIOLOGICAL WORKS.

A MANUAL, OR ELEMENTS OF PHYSIOLOGY,
INCLUDING PHYSIOLOGICAL ANATOMY,
FOR THE USE OF THE MEDICAL STUDENT.

With one Hundred and Eighty Illustrations. In one octavo volume of 566 pages. Elegantly printed to match his "Principles of Human Physiology."

A POPULAR TREATISE ON VEGETABLE PHYSIOLOGY.

With numerous Illustrations on Wood. In one neat duodecimo volume.

(Preparing.)

PRINCIPLES OF GENERAL AND COMPARATIVE
PHYSIOLOGY,

INTENDED AS AN INTRODUCTION TO THE STUDY OF HUMAN PHYSIOLOGY, AND
AS A GUIDE TO THE PHILOSOPHICAL PURSUIT OF NATURAL HISTORY.

With numerous Illustrations on Wood. From the Third London Edition.

(Preparing.)

PRINCIPLES OF ANIMAL PHYSIOLOGY.

With about Three Hundred beautiful Illustrations on Wood.

LEA AND BLANCHARD.

PRINCIPLES
OF
HUMAN PHYSIOLOGY,

WITH THEIR CHIEF APPLICATIONS TO PATHOLOGY, HYGIÈNE, AND
FORENSIC MEDICINE.

BY

WILLIAM B. CARPENTER, M.D., F.R.S.,

FULLERIAN PROFESSOR OF PHYSIOLOGY IN THE ROYAL INSTITUTION OF GREAT BRITAIN, CORRESPONDING
MEMBER OF THE AMERICAN PHILOSOPHICAL SOCIETY, AND OF THE
NATIONAL INSTITUTE OF THE UNITED STATES;
LECTURER ON PHYSIOLOGY AT THE LONDON HOSPITAL MEDICAL SCHOOL,
ETC. ETC.

Third American, from the last London Edition.

WITH NOTES AND ADDITIONS,

BY

MEREDITH CLYMER, M.D.,

CONSULTING PHYSICIAN TO THE PHILADELPHIA HOSPITAL;
LATE PROFESSOR OF THE PRINCIPLES AND PRACTICE OF MEDICINE, AND CLINICAL MEDICINE, IN THE
FRANKLIN MEDICAL COLLEGE, PHILADELPHIA; FELLOW OF THE
COLLEGE OF PHYSICIANS, ETC. ETC. ETC.

WITH

THREE HUNDRED AND SEVENTEEN WOOD-CUT AND OTHER ILLUSTRATIONS.

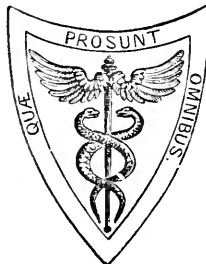

PHILADELPHIA:
LEA AND BLANCHARD.
1847.

Entered according to Act of Congress, in the year 1845, by

LEA AND BLANCHARD,

in the Office of the Clerk of the District Court for the Eastern District of Pennsylvania.

PHILADELPHIA :

T. K. AND P. G. COLLINS, PRINTERS.

TO
WILLIAM PULTENEY ALISON,

M. D., F. R. S. E., &c. &c.

PROFESSOR OF THE PRACTICE OF MEDICINE OF THE UNIVERSITY OF EDINBURGH.

MY DEAR SIR,

I take the liberty of inscribing the following Work to you, as an expression of my grateful remembrance of the value of your instructions, of my respect for those intellectual faculties which render you pre-eminent amongst the Medical Philosophers of our time, and of my admiration for those moral excellencies which call forth the warm regard of all who are acquainted with your character.

In many parts of this Treatise, you will find that doctrines, which you have long upheld in opposition to almost the whole Physiological world, are defended with such resources as I could command; and that, in many instances, such convincing evidence of their truth has been afforded by recent observations, that further opposition to them would now seem vain. And if I have presumed to differ from you on some points, it has been in the spirit of that independence which you have uniformly encouraged in your pupils; yet with a distrust of my own judgment, wherever it came into collision with yours.

That you may long be spared to be the ornament of your University, and the honour of your City, is the earnest wish of,

Dear Sir,

Your obliged Pupil,

WILLIAM B. CARPENTER.

EDITOR'S PREFACE.

THE character of the present Work is too well known and established to need any commendation. Within a period of four years, it has passed through three editions both in this country and Great Britain. It will be seen, upon referring to the Author's Preface, that the present edition has been essentially modified and improved; and, besides attentive revision, has undergone material alteration in the arrangement.

Many of the Notes of the American Editor to former editions have been incorporated by the Author in the text of the present; others remain; whilst such additions have been made, as the progress of the science required.

By the liberality of the Publishers, the Editor has been enabled to add numerous additional illustrations; which, accompanied by copious references, will, he trusts, be found to enhance the value of this edition, and to peculiarly adapt it to the Student of Physiology. There are one hundred and fifteen more wood-cuts in this than in the third English edition, and one hundred and one more than in the last American.

The new matter added by the American Editor is in smaller type, and is distinguished thus [—M. C.] The new cuts are included between brackets [].

M. C.

230, *Spruce Street, Philadelphia,*
September, 1847.

P R E F A C E

TO

T H E T H I R D L O N D O N E D I T I O N .

THE Author gladly avails himself of the opportunity afforded him by the call for a Third Edition of the following work, to express his grateful acknowledgments for the kind reception it has experienced, both in this country and in the United States. The rapid sale of two large impressions on each side of the Atlantic, has been the most satisfactory proof that he had not been in error when he supposed that an opening existed for an additional Treatise on Physiology, notwithstanding the large number of those already before the public; and that he has not been altogether unsuccessful in supplying the deficiency.

The present Edition has not only undergone a very careful revision; but has in many parts received large additions, and has been in many others entirely remodelled. By an increase in the size of the page, and in the proportion of small type, the quantity of matter has been augmented by an amount equivalent to the addition of fully a hundred pages. A considerable number of new wood engravings, of first rate execution, have also been introduced. Many of these are from original drawings by Mr. Leonard.

Among the principal additions will be found a Chapter on the Varieties of the Human Race; intended to convey to those, who have not time or opportunity to peruse Dr. Prichard's elaborate treatises, a general view of his arguments and conclusions. The account of the Primary Tissues, also, which was formerly included in the Chapter on Nutrition, has been extended in a degree commensurate with the Author's estimate of its importance, and has been made to form a distinct Chapter nearer the commencement of the work. Other additions and changes, which constitute, when taken collectively, no inconsiderable proportion of the entire Treatise, are scattered through the volume. The materials of these have been drawn from the numerous contributions to Physiological Science, which have been made within the last two years, and from

among which the Author has endeavoured to select the most important and the most stable;—not rashly introducing changes inconsistent with usually-received views;—nor, on the other hand, showing an unwillingness to reject the statements of those who have taken much pains to arrive at accurate conclusions. He trusts that he may be found to have generally exercised a sound discretion, both as to what he has admitted, and what he has rejected; and that his work will appear to exhibit on the whole, a faithful reflection of the present aspect of Physiological Science. He cannot venture to expect, however, that he has succeeded in every instance, so that each of his readers will be in constant agreement with him; since it is impossible that they should all survey the subject from the same point of view.

Many, however, of the additions and alterations scattered through the work, are the result of the Author's own investigations. He has particularly directed his attention to the settlement of points, which appeared to him to be left doubtful by others; and hence will sometimes be found to have expressed his views with a degree of confidence, which the evidence adduced by them may scarcely appear to warrant.

The Author feels called upon to express his particular obligations to the valuable Reports on the Progress of Anatomy and Physiology, contributed by Mr. Paget, to the British and Foreign Medical Review; and also to those contained in the Half-Yearly Abstract, edited by Dr. Ranking. He has made a point, however, of consulting the original sources of information referred to in these Reports, in every instance in which he could gain access to them. He has derived much assistance, also, from Dr. Day's Reports on the Progress of Chemistry, published in the second of the works just named; as well as from the translation of Simon's Animal Chemistry, edited by the same gentleman.

He would be doing injustice to his own feelings, if he did not specially refer to the admirable "Anatomical and Pathological Observations" of Messrs. Goodsir, as one of the most valuable contributions to Physiological Science which has been made since the date of his former Edition.

The subjoined Extracts from the First Edition will explain the plan and scope of his Treatise to those who may now examine it for the first time.

Stoke Newington,
October, 1846.

FROM THE
P R E F A C E
TO
THE FIRST EDITION.

THE composition of such a Treatise as the following was a part of the original plan of the Author when he first came before the Public as a writer on Physiology. Being desirous, however, of making his first essay in the path which had been previously the most incompletely explored, he deemed it better to await the verdict upon this before proceeding further; and he was not without hope, that some Writer, more fully competent to the task, might in the meantime take up the subject of Human Physiology in such a way as to leave nothing for the Student to desire. This, however, has not been accomplished. The previously existing Treatises upon it, which have been every year becoming more antiquated, have not been replaced by any works, that can be considered as at the same time sufficiently elevated in their character, to represent the present condition of Physiological Science,—sufficiently compendious in their bulk for the limited time at the disposal of most Students,—and sufficiently practical in their tendency to lead their readers to the useful applications of the facts and principles they place before them. This is not the opinion of the Author alone, but that of numerous experienced Teachers throughout the country; and he has been led to regard the present as a good time for carrying his purpose into execution.

The plan and objects of his Treatise may be gathered from the preceding statement of the reasons which have occasioned its production. In this, as in his previous work, it has been his object to place the Reader in the possession of the highest principles, that can be regarded as firmly established, in each department of the Science; and to explain and illustrate these, by the introduction of as many important facts as could be included within moderate limits. In every instance, he has endeavoured to make his statements clear and precise without being formal or dogmatical; and definite enough to admit of practical applica-

tion without appearing to be unimprovable by further inquiry. Physiology is essentially a science of progress; and it must happen that much of what is now regarded as established truth, will need great modification to be brought into accordance with the results of new inquiries. It is very desirable, therefore, that the Student should not be made to think so confidently of his acquirements, as to be indisposed to receive new information, even though it should tend to diminish their value.

The present Treatise is to be regarded as complete in itself, and as quite independent of the Author's "Principles of General and Comparative Physiology." That it may be so he has inserted an introductory chapter on the "Place of Man in the Scale of Being," and numerous references to the Comparative Physiology of the lower Animals. Still he does not hesitate to express the opinion that, the greater the amount of the Student's previous general knowledge of the Science, the better will he be prepared to enter upon any department of it, especially that peculiarly complex and difficult branch, the Physiology of Man. On every topic, it has been the author's aim to present the latest and most satisfactory information within his reach; and he believes that the Volume contains much that will be new to the Physiologist, whose reading has not been tolerably extensive. Its materials have been but little derived from other Systematic Treatises on the subject; and it will not be found to bear, as a whole, any considerable resemblance to those already before the public. The author has rather endeavoured to bring together the valuable facts and principles, scattered through the best of the numerous Monographs, that have been recently published on special divisions of Physiology and Medicine; and to reduce these *disjecta membra* to that systematic form, which they can only be rightly made to assume, when brought into relation with each other, and shown to be subservient to principles of still higher generality. In regard to this, as to his former Treatise, the Author believes that he may claim a somewhat higher character than that of the mere Compiler; and that even the well-read Physiologist will find in it many facts and deductions, which have not been previously brought before him in the same form.

In apportioning the amount of space to be devoted to each division of the subject, the Author has had in view its practical relations, much more than its merely scientific interest; and he has on this account bestowed a much larger share on the organs of Animal life than some may think just when compared with the narrow limits within which other important topics are discussed. But he has endeavoured to keep always in view, that he is writing for the guidance of the Student who is to become a Practitioner, rather than for him who makes the pursuit of Science his professed object; and that much that is of the highest interest to the

latter is comparatively valueless to the former. Hence many topics of great scientific interest are entirely passed over; and it is hoped that such omissions will not be accounted as faults in the estimation of those, who dread lest the attention of the Student should be too much drawn off by the seducing novelties of Science, from his less attractive, but more important objects.

For a large part of his illustrations, the Author is indebted to the valuable and beautiful *Icones Physiologicæ* of Prof. Wagner. He has indicated the sources of all which are not original.

In conclusion, the Author would repeat what he has already had occasion to state;—that in a work involving many details, it is not to be expected that no error should have crept in; but that he has endeavoured to secure correctness, by relying only upon such authorities as appeared to him competent, and by comparing their statements with such general principles as he considers well established. For the truth of those principles, he holds himself responsible; for the correctness of the details, he must appeal to those from whom they are derived, and to whom he has generally referred. He hopes that he will not be found unwilling to modify either, when they have been proved to be erroneous; nor indisposed to profit by criticism, when administered in a friendly spirit.

Bristol, Feb. 1, 1842.

TABLE OF CONTENTS.

INTRODUCTION.

	PAGE
NATURE AND OBJECTS OF PHYSIOLOGICAL SCIENCE - - - - -	38

CHAPTER I.

ON THE PLACE OF MAN IN THE SCALE OF BEING.

1. Distinction between Animals and Plants - - - - -	39
2. General sub-divisions of the Animal Kingdom - - - - -	41
3. General characters of Radiata - - - - -	42
4. General characters of Mollusca - - - - -	45
5. General characters of Articulata - - - - -	48
6. General characters of Vertebrata - - - - -	50
7. General characters of Fishes - - - - -	54
8. General characters of Reptiles - - - - -	55
9. General characters of Birds - - - - -	58
10. General characters of Mammalia - - - - -	62
11. Chief sub-divisions of Mammalia - - - - -	65
12. Characteristics of Man - - - - -	67

CHAPTER II.

OF THE MUTUAL RELATIONS OF THE DIFFERENT BRANCHES OF THE HUMAN FAMILY.

1. General Considerations - - - - -	76
2. On the Discrimination of Species - - - - -	77
3. On the possible Extent of Variation within the limits of Species - - - - -	79
4. On the Extremes of Variation among the Races of Men - - - - -	81
5. On the value of Physiological and Psychological peculiarities as specific distinctions - - - - -	82
6. On the Comparative Peculiarities of the different Races of Mankind - - - - -	83
7. Of the Principal Branches of the Human Family - - - - -	91

CHAPTER III.

OF THE ELEMENTARY PARTS OF THE HUMAN FABRIC.

1. On Organized Structures in General - - - - -	99
2. On the Original Components of the Animal Fabric [®] - - - - -	102
3. Of the Elementary Parts of Organized Tissues;—Cells, Membrane, and Fibre - - - - -	108
4. Of the Simple Fibrous Tissues - - - - -	120

	PAGE
5. Of simple Cells, floating in the Animal Fluids - - - - -	124
6. Of Cells developed upon Free Surfaces - - - - -	137
7. Of the Compound Membrano-Fibrous Tissues - - - - -	147
8. Of Simple Isolated Cells, forming Solid Tissues by their aggregation - - - - -	150
9. Of Tissues consolidated by Earthy deposit.—Bones and Teeth - - - - -	161
10. Of Simple Tubular Tissues.—Capillary Blood-vessels - - - - -	188
11. Of Compound Tubular Tissues.—Muscle and Nerve - - - - -	192

CHAPTER IV.

GENERAL VIEW OF THE FUNCTIONS.

1. Of Vital Actions, and their mutual dependence - - - - -	216
2. Functions of Vegetative Life - - - - -	224
3. Functions of Animal Life - - - - -	232

CHAPTER V.

FUNCTIONS OF THE NERVOUS SYSTEM.

1. General Summary - - - - -	236
2. Comparative Anatomy and Physiology of the Nervous System in Invertebrata	247
3. Nervous System of Vertebrata - - - - -	265
4. Functions of the Spinal Cord and its Nerves.—Reflex Action - - - - -	285
Respiratory Movements - - - - -	292
Deglutition and Defecation - - - - -	297
Movements of the Genital Organs - - - - -	305
Protecting Agency of the Spinal Cord - - - - -	305
Movements of Locomotion - - - - -	307
Influence on Muscular Tension - - - - -	307
Pathological Phenomena - - - - -	308
Nerves of the Spinal System - - - - -	310
5. Of the Sensory Ganglia and their Functions.—Consensual Movements - - - - -	326
Emotional Actions - - - - -	335
Nerves connected with the Sensory Ganglia - - - - -	339
Consensual Movements of the Eye - - - - -	344
6. Functions of the Cerebellum - - - - -	349
7. Functions of the Cerebrum - - - - -	357
8. General Recapitulation, and Pathological Applications - - - - -	376

CHAPTER VI.

OF SENSATION, AND THE ORGANS OF THE SENSES.

1. Of Sensation in General - - - - -	385
2. Sense of Touch - - - - -	395
3. Sense of Taste - - - - -	399
4. Sense of Smell - - - - -	404
5. Sense of Vision - - - - -	407
6. Sense of Hearing - - - - -	422

CHAPTER VII.

OF MUSCULAR CONTRACTILITY.

1. Of Contractility in General - - - - -	438
--	-----

	PAGE
2. Of Muscular Irritability - - - - -	439
3. Of Muscular Tonicity - - - - -	449
4. Energy and Rapidity of Muscular Contraction - - - - -	452

CHAPTER VIII.

OF THE VOICE AND SPEECH.

1. The Larynx, and its Actions - - - - -	455
2. Of Articulate Sounds - - - - -	464

CHAPTER IX.

INFLUENCE OF THE NERVOUS SYSTEM ON THE ORGANIC FUNCTIONS. 470

CHAPTER X.

OF FOOD AND THE DIGESTIVE PROCESS.

1. Sources of the Demand for Aliment.—Hunger and Thirst - - - - -	477
2. Nature and Destination of the Food of Animals - - - - -	483
3. Of the Passage of Food along the Alimentary Canal - - - - -	492
Mastication and Deglutition - - - - -	494
Action of the Stomach - - - - -	496
Action of the Intestinal Tube - - - - -	501
Act of Defecation - - - - -	502
4. Nature of Chymification and Chylification - - - - -	503

CHAPTER XI.

OF ABSORPTION AND SANGUIFICATION.

1. Absorption from the Digestive Cavity - - - - -	509
2. Absorption from the Body in general - - - - -	512
3. Of the Elaboration of the Nutrient Materials - - - - -	517
4. Composition and Properties of the Chyle and Lymph - - - - -	523
5. Physical and Vital Properties of the Blood - - - - -	527
6. Pathological Changes in the Blood - - - - -	535

CHAPTER XII.

OF THE CIRCULATION OF BLOOD.

1. Of the Circulation in General - - - - -	540
2. Action of the Heart - - - - -	546
3. Movement of the Blood in the Arteries and Capillaries - - - - -	556
4. Of the Venous Circulation - - - - -	566
5. Peculiarities of the Circulation in different Parts - - - - -	568

CHAPTER XIII.

OF RESPIRATION.

1. Nature of the Function; and Provisions for its Performance - - - - -	570
2. Effects of Respiration on the Air - - - - -	582

	PAGE
3. Effects of Respiration on the Blood - - - - -	586
Exhalation and Absorption by the Lungs - - - - -	589
4. Effects of Suspension of the Respiratory Process - - - - -	591

CHAPTER XIV.

OF NUTRITION.

1. General Considerations.—Selective Power of Individual Parts - - - - -	593
2. Varying Activity of the Nutritive Processes - - - - -	596
Reparative Operations - - - - -	599
3. Abnormal Forms of the Nutritive Process - - - - -	604
4. Varying Duration of Different Parts of the Organism - - - - -	609
5. Of Death, or Cessation of Nutrition - - - - -	612

CHAPTER XV.

OF SECRETION.

1. Of Secretion in General - - - - -	614
2. The Liver.—Secretion of Bile - - - - -	618
3. The Kidneys.—Secretion of Urine - - - - -	632
4. Mammary Gland.—Secretion of Milk - - - - -	647
5. Salivary Glands and Pancreas - - - - -	655
6. Lachrymal Gland - - - - -	657
7. The Testis.—Spermatie Fluid - - - - -	657
8. Cutaneous and Mucous Follicles - - - - -	661

CHAPTER XVI.

GENERAL REVIEW OF THE NUTRITIVE PROCESSES.—ANIMAL HEAT.

1. Review of the Nutritive Processes, with Practical Applications - - - - -	671
2. Animal Heat - - - - -	676

CHAPTER XVII.

OF REPRODUCTION.

1. General Character of the Function - - - - -	687
2. Action of the Male - - - - -	689
3. Action of the Female - - - - -	692
4. Development of the Embryo - - - - -	713

APPENDIX.

I. ON PHRENOLOGY - - - - -	731
II. ON ARTIFICIAL SOMNAMBULISM AND MESMERISM - - - - -	733

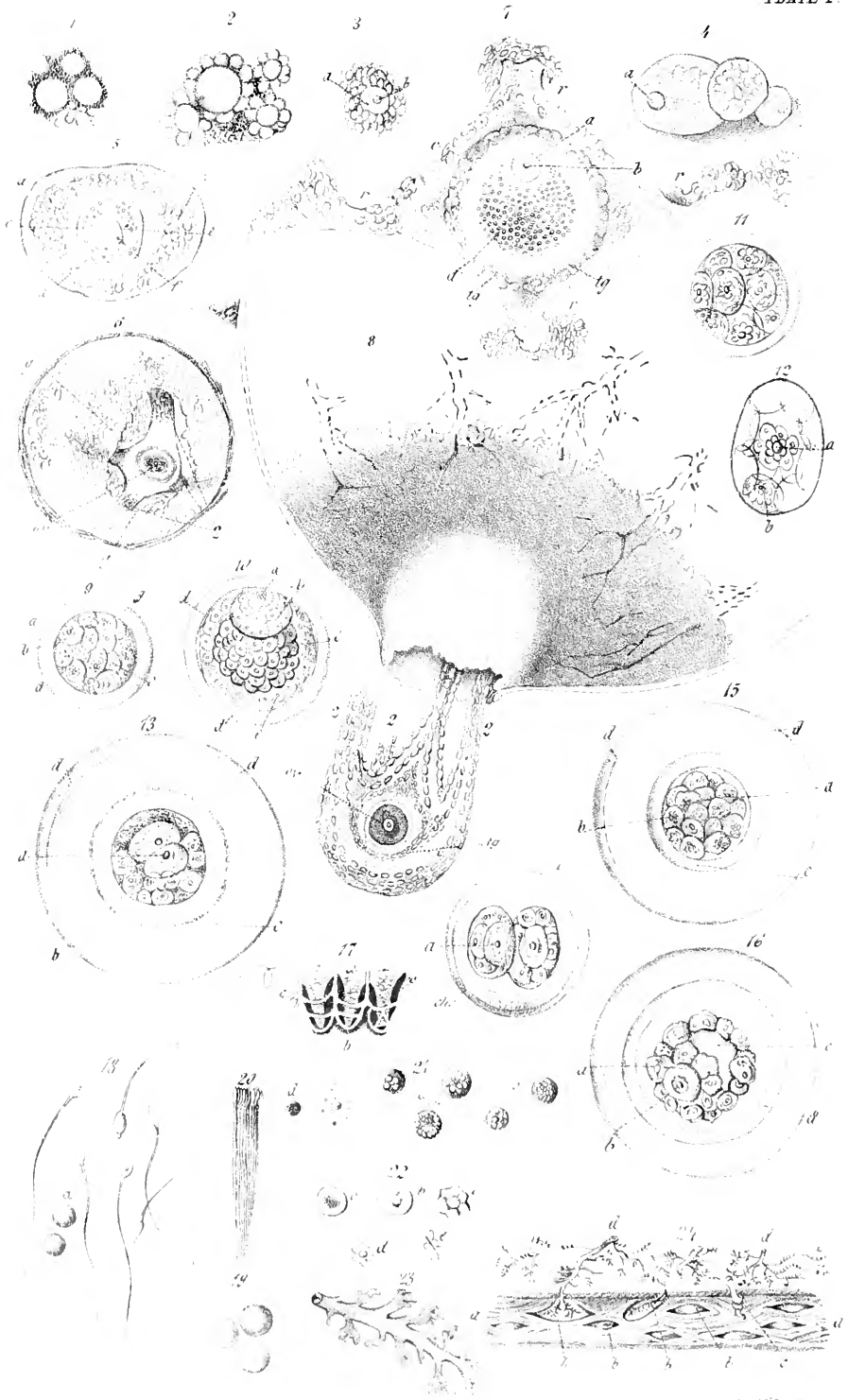

EXPLANATION OF PLATES.

PLATE I.

The first 16 Figures in this Plate are from Dr. Barry's Embryological Researches in the Philosophical Transactions for 1837, 1839 and 1840.

FIG.

1. A very early stage of the formation of the Ovum; the vesicles, the largest of which measures only 1-1125th of an inch, are seen in the midst of dark granules or globules (§ 906).
2. A stage somewhat more advanced; the vesicles are surrounded by envelopes of smaller vesicles, amongst which the granules are still seen (§ 906).
3. A still later stage; a central vesicle *a*, is seen, with a spot, *b*, upon its walls, and surrounded with numerous granules; this has now evidently become the Germinal Vesicle (§ 906).
4. Ovisacs from Human Ovum, 1-200th of an inch and upwards, in diameter; the largest exhibits the Germinal Vesicle, *a*, very distinctly (§ 906).
5. Ovisac from Cat, showing its contents when near maturity; *a*, ovisac; *b*, its contained granules; *c*, zona pellucida; *d*, granules of the yolk; *e*, germinal vesicle; *f*, germinal spot; magnified 440 diameters (§ 905).
6. Ovum of Rabbit at the periphery of the Graafian follicle, with part of the membrana granulosa removed; *g, g*, membrana granulosa; *ov*, ovulum; *r, r*, retinacula (§§ 906, 912).
7. Ovum with its tunica granulosa and retinacula, removed from the Graafian follicle; *a*, germinal vesicle; *b*, germinal spot; *c*, zona pellucida; *d*, globules of the yolk; *r, r*, retinacula; *t, g*, tunica granulosa (§ 906).
8. Graafian follicle discharging its Ovum, *ov*, to which the tunica granulosa, *tg*, and retinacula, *r, r*, remain attached (§ 912).
9. Ovarium Ovum in preparation for fecundation: *a*, germinal spot beginning to resolve itself into cells at its margin; *b*, germinal vesicle; *c*, elliptical cells in the place of the yolk; *d*, zona pellucida. 100 Diameters (§§ 915, 916).
10. Ovum nearly ready for fecundation: *a*, germinal spot more fully developed into cells, of which concentric layers occupy the germinal vesicle *b*; *c*, elliptical discs or cells; *d*, zona pellucida; *e*, outer layer of cells of yolk (§§ 130, 915, 916).
11. Fecundated Ovum of nine hours; the germinal vesicle, having returned to the centre of the ovum, is concealed by the large elliptical discs, which fill the cavity of the zona pellucida (§ 916).
12. Plan of one of these discs or cells: its nucleus, *a*, has developed itself into concentric rings of cells: and in the most fully developed of these, the nucleus, *b*, is seen to be commencing the same kind of evolution. In the centre of the original nucleus, a pellucid spot, the nucleolus of Schwann and Schleiden, is observed (§§ 130, 916).

FIG.

13. Ovum from the Uterus, measuring about 1-68th of an inch in diameter: *a*, pair of cells now occupying the greater part of the germinal vesicle *b*; *c*, zona pellucida; *d*, chorion, a new envelope, separated from the last by the fluid it has absorbed (§§ 130, 917).
14. Ovum, of which the essential part, *a*, the pair of cells occupying the germinal vesicle, has advanced further than in the last case; the other contents of the germinal vesicle have undergone liquefaction. The chorion is here incipient; and the remains of the cells of which it is composed are seen at *cho* (§§ 130, 918).
15. More advanced ovum; the cavity of the germinal vesicle filled with cells, *a*, that have originated in the two represented in the last figure; these cells have nuclei, *b*, which are undergoing a corresponding process of evolution into secondary cells; *c* and *d* as in Fig. 13 (§§ 130, 935).
16. Ovum in a state rather more advanced; *a*, central cell of the germinal mass, now come to the surface, and showing the nucleus *b* with a pellucid centre, from which most of the embryonic structures are developed; *c*, cavity in the germinal mass, caused by the approach of its peripheral cells to the enclosing membrane, *d* (§§ 935, 936).
17. Formation of the Membrana Decidua; *a, a, a*, interfollicular substance of the mucous membrane of the uterus; *b*, cavities of the follicles; *c*, uterine vessels prolonged into the decidua and forming loops. After Baer (§ 919).
18. Human Spermatozoa; *a*, seminal granules. After Wagner (§ 902).
19. Cyst of evolution. After Wagner (§ 902).
20. Capsular bundle of Spermatozoa, just previous to their separation. After Wagner (§ 902).
21. Globules from the Chyle; *a*, ordinary globules; *b*, a globule (cytoblast?) surrounding itself with an envelope (a forming cell?); *c*, minute molecules of chyle; *d*, a colourless corpuscle from the blood. After Wagner (§§ 692, 693).
22. Particles of Blood undergoing multiplication: *a, b, c, d, c*, successive stages. After Barry (§ 148).
23. Extremity of one of the tufts of fetal vessels forming the Placenta; this includes (like a branchial tuft) an artery and vein. After Reid (§ 922).
24. Plan of the structure of the Placenta, according to Dr. J. Reid's view of it; *a, a*, portion of substance of uterus; *b, b, b, b*, section of uterine sinuses, some of them opening on the inner surface into the cavity of the placenta; *c*, curling artery of uterus; *d, d*, ramifications of fetal vessels, some of them sending down prolonged tufts which dip into the uterine sinuses (§ 923).

PLATE II.

25. Uterine Ovum of Rabbit, showing the Area Pellucida, with the annular nucleus of the embryonic cell (Fig. 14, *b*) now elongated. In the clear space enclosed by this is a well-marked dark groove, occupying the position in which the nervous centres are subsequently to be developed. The cephalic extremity of this is already rounded and the caudal extremity pointed. After Bischoff (§ 937).
26. More advanced ovum, showing the incipient formation of the Vertebral column; and the dilatation of the primitive groove at its anterior extremity. After Bischoff (§ 937).

Fig 25

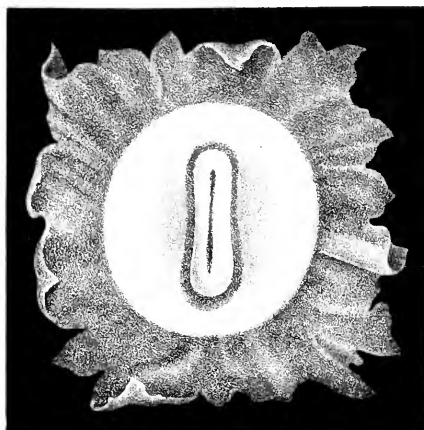

Fig 26

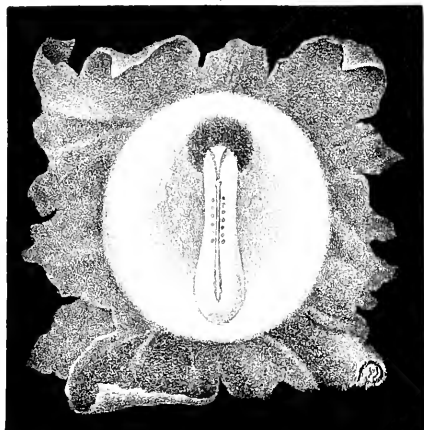

Fig 27

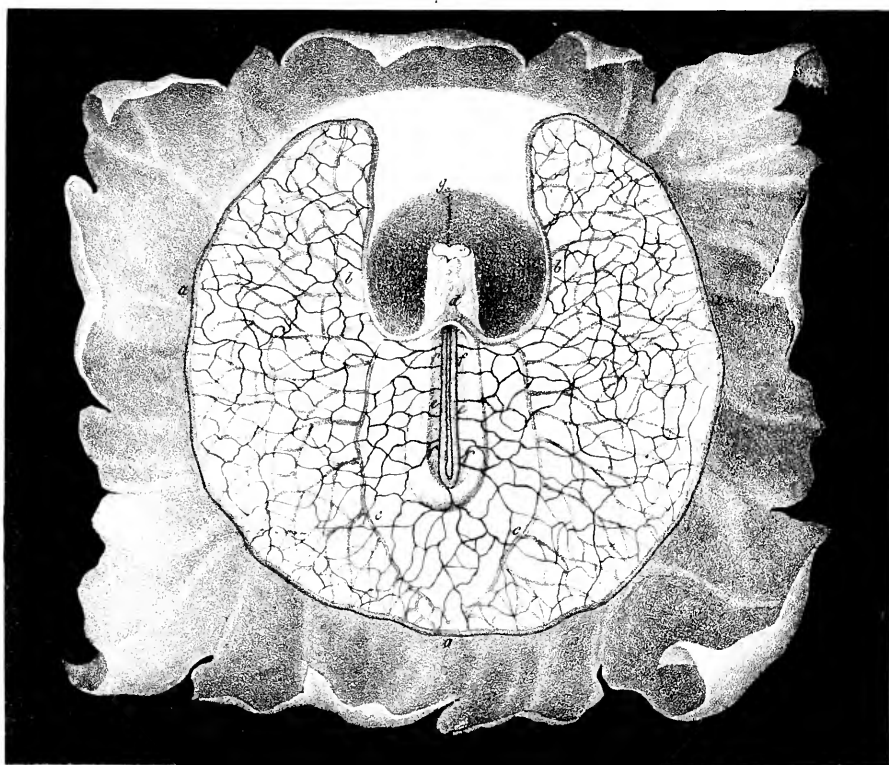

FIG.

27. More advanced embryo, seen on its ventral side, and showing the first development of the Circulating apparatus. Around the Vascular Area is shown the terminal sinus, *a, a, a*. The blood returns from this by two superior branches, *b, b*, and two inferior, *c, c*, of the omphalo-meseraic veins, to the heart, *d*; which is, at this period, a tube curved on itself, and presenting the first indication of a division into cavities. The two aortic trunks appear, in the abdominal region, as the inferior vertebral arteries, *e, e*; from which are given off the omphalo-meseraic arteries, *f, f*, which form a network that distributes the blood over the vascular area. In the cephalic region are seen the anterior cerebral vesicles, with the two ocular vesicles, *g*. After Bischoff (§ 938).

LIST OF WOOD-ENGRAVINGS.

FIG.	PAGE
1. Structure of the Star-fish, after Tiedemann - - - - -	43
2. External aspect of Aplysia, after Rang - - - - -	46
3. Structure of Aplysia, after Cuvier - - - - -	47
4. Section of Cockchafer, after Strauss-Durckheim - - - - -	50
5. Comparative view of base of Skull of Man, and of Orang-Outan, after Owen -	68
6. Comparative view of the Skeletons of Man and the Orang, after Owen -	71
7. Views of Prognathous Skull, after Prichard - - - - -	86
8. Views of Pyramidal Skull, after Prichard - - - - -	87
9. View of Oval Skull, after Prichard - - - - -	88
10. Fibrous structure of Exudation-membrane, after Gerber - - - - -	107
11. Fibrous membrane from the Egg-shell - - - - -	107
12. Simple Isolated Cells, containing reproductive Molecules - - - - -	110
13. Cells of Zygnema, showing spiral arrangement of nuclear particles, after Hassall	110
14. Cells of Pelargonium, showing stellate prolongations of nuclei - - - - -	111
15. Hæmatococcus binalis, in various stages of development, after Hassall -	111
16. Coccochloris cystifera, in various stages of development, after Hassall -	111
17. Hæmatococcus sanguineus, in various stages of development, after Hassall	112
18. Nostoc macrosporum, in two states, after Hassall - - - - -	113
19. Section of branchial Cartilage of young Tadpole, after Schwann - - - - -	114
20. Endogenous cell-growth in cells of a meliceritous tumor, after Goodsir -	115
21. Colorless cells with active molecules and fibres of fibrine, after Addison	118
22. Arrangement of Fibres in Arcolar Tissue - - - - -	120
23. White Fibrous Tissue, from Ligament - - - - -	122
24. Yellow Fibrous tissue, from Ligamentum nuchæ of Calf - - - - -	122
25. Elements of Areolar Tissue, after Todd and Bowman - - - - -	122
26. Development of Areolar Tissue, after Schwann - - - - -	122
27. Red Corpuscles of Human Blood, after Donné - - - - -	124
28. Red Corpuscles of Frog's Blood, after Wagner - - - - -	125
29. Production of Red Corpuscles in Chick, after Wagner - - - - -	129
30. Small Venous Trunk, from web of Frog's foot, after Wagner - - - - -	132
31. Vertical Section of Epidermis, after Wilson - - - - -	137
32. Choroid Epithelium, with pigment cells, after Todd and Bowman - - - - -	139
33. Cells of Pigmentum Nigrum - - - - -	139
34. Section of the nail and its matrix, after Todd and Bowman - - - - -	140
35. Hairs of Sable and Musk-Deer - - - - -	141
36. Hair and hair follicles seen in section, after Todd and Bowman - - - - -	141
37. Structure of Human Hair, after Wilson - - - - -	142
38. Pavement-Epithelium-cells - - - - -	144
39. Ciliated Epithelium - - - - -	144
40. Examples of Cilia, after Todd and Bowman - - - - -	145
41. Secreting Follicles from the Liver of Crab - - - - -	146
42. Capillary Network of Skin, after Berres - - - - -	148
43. Capillary Network of Intestinal Villi, after Berres - - - - -	148
44. Capillary Network of Mucous Membrane, after Berres - - - - -	148
45. Diagram of the Structure of Mucous Membrane, after Todd - - - - -	149
46. Extremity of Intestinal Villi, after Goodsir - - - - -	151
47. Secreting Cells of Human Liver, after Bowman - - - - -	152
48. Shape of Fat Vesicles in close pressure, after Todd and Bowman - - - - -	152
49. Cells of Adipose Tissue - - - - -	153
50. Blood Vessels of Fat, after Todd and Bowman - - - - -	153

FIG.	PAGE
51. Fat Vesicles from an emaciated subject, after Todd and Bowman	154
52. Section of Branchial Cartilage of Tadpole, after Schwann	155
53. Section of Fibro-Cartilage	155
54. Ampullary Loops of Vessels of Cartilage, after Toynee	157
55. Nutrient Vessels of Cartilage, after Toynee	157
56. Nutrient vessels of the Cornea, after Toynee	158
57. Vertical section of Sclerotica and Cornea, after Todd and Bowman	158
58. Tubes of the Cornea of an Ox, injected, after Todd and Bowman	159
59. Calcified Areolar Structure from shell of Echinus	161
60. Cellular Membrane from Shell of Pinna	161
61. Section of Bone	162
62. Transverse section of a long Bone, after Todd and Bowman	163
63. Transverse section of a Tibia, after Tomes	163
64. Lacunæ of Osseous Substance	163
65. Haversian canals in a long Bone, after Todd and Bowman	164
66. Section of Cartilage at Seat of Ossification, after Wilson	168
67. Vertical section of Cartilage, after Todd and Bowman	168
68. Scapula of a Fœtus, showing the process of ossification, after Tomes	170
69. Longitudinal section of an Incisor and Molar Tooth	174
70. Vertical section of an adult Bicuspid	174
71. Vertical Section of an imperfectly developed Incisor	174
72. Hexagonal terminations of Fibres of Enamel, after Retzius	174
73. Fibres of Enamel viewed sideways, after Retzius	175
74. Vertical section of Bicuspid highly magnified	175
75. Most interior portion of Main Tubes of Dental Bone	175
76. Ramifications of the Main Tubes of Dental Bone	175
77. Transverse section of Crown of Bicuspid, highly magnified	176
78. Position of the Main Tubes near the Root of Bicuspid	176
79. Sections of a Human Incisor, highly magnified, after Todd and Bowman	176
80. Transverse sections of Tubules of Dentine, after Todd and Bowman	177
81. Oblique Section of Dentine, after Owen	177
82. Vessels of Dental Papilla, after Berres	180
83. Diagram of development of Dentine, after Owen	180
84. Inner surface of cap of dentine, after Owen	181
85. Formation of Enamel, after Owen	182
86. Formation of the Cementum, after Owen	182
87. First stage of Formation of Teeth, after Goodsir	183
88. Diagram illustrating subsequent stages of formation of Teeth, after Goodsir	183
89. Do. do. do. after Goodsir	184
90. Capillary network in Frog's foot, after Wagner	189
91. Capillary vessels from pia mater, after Henle	190
92. Formation of capillaries in germinal membrane, after Wagner	191
93. Fasciculus of fibres of Voluntary Muscles, after Baly	193
94. Portion of Human Muscular Fibre, separating into disks, after Bowman	193
95. Cleavage of Striped Elementary Fibres	194
96. Muscular Fibre broken across, showing Myolemma, after Bowman	194
97. Transverse Section of Muscular Fibres of Teal, after Bowman	196
98. Fragment of Muscular Fibre from Heart of Ox, after Bowman	197
99. Structure of ultimate fibrillæ of striated Muscular Fibre	197
100. Muscular fibre of Dytiscus, contracted in the centre, after Bowman	198
101. Muscular fibre of Skate, in different stages of contraction, after Bowman	199
102. Attachment of Tendon to Muscular Fibre in Skate, after Bowman	200
103. Non-striated Muscular Fibre, after Bowman	200
104. Do. showing nodosities, after Wilson	200
105. Muscular Fibres from Fœtus, after Bowman	202
106. Do. treated with tartaric acid, after Wilson	202
107. Capillary network of Muscles, after Berres	204
108. Terminating loops of Nerves in Muscles, after Bardach	204
109. Structure of Sympathetic Ganglion, after Valentin	205
110. Diagram of Tubular Fibre of a Spinal Nerve, after Todd and Bowman	206
111. Structure of Nerve-tubes, after Wagner	207
112. Primitive fibres and ganglionic globules of human brain, after Purkinje	208
113. Nerve-vesicles from the Gasserian ganglion, after Todd and Bowman	209
114. Caudate nerve-vesicles from the cerebellum and cord, after Todd and Bowman	210

FIG.	PAGE
115. View of piece of Otic ganglion of sheep, after Valentin	210
116. Two views of the vesicular and fibrous matter of the cerebellum, after Todd and Bowman	211
117. Vesicular and fibrous matter in the Gasserian ganglion, after Todd and Bowman	211
118. Primitive Fibres and ganglionic globules, after Wagner	211
119. Distribution of tactile nerves in skin, after Gerber	212
120. Terminal loops of nerve in the pulp of a tooth, after Valentin	213
121. Capillary network of nervous centres, after Berres	214
122. Capillary loops in skin of finger, after Berres	214
123. Stages of the development of nerve, after Schwann	215
124. Nervous system of Solen, after Blanchard	251
125. Nervous system of Aplysia, after Cuvier	254
126. Nervous system of larva of Sphinx ligustri, after Newport	256
127. Portion of ganglionic tract of Polydesmus, after Newport	257
128. Parts of Nervous System of Articulata, after Newport	259
129. Stomato-gastric system of Gryllotalpa vulgaris, after Brandt	261
130. A View of the Great Sympathetic Nerve	267
131. Roots of a dorsal Spinal Nerve, after Todd and Bowman	268
132. Nervous centres in Frog, after Leuret	270
133. Transverse sections of Spinal Cord at different points, after Solly	271
134. Structure of the Spinal Cord, after Stilling	272
135. Connection of nerve-roots with the Spinal Cord, after Stilling	275
136. A posterior superior view of the Pons Varolii, Cerebellum, &c.	275
137. An anterior view of the Medulla Oblongata, after Todd and Bowman	275
138. A posterior view of the Medulla Oblongata, after Todd and Bowman	275
139. Transverse section of the Medulla Oblongata, after Stilling	276
140. Course of the Motor tract, after Sir C. Bell	277
141. Course of the Sensory tract, after Sir C. Bell	278
142. Analytical diagram of the Encephalon, after Mayo	279
143. Brains of Fox-shark, Cod, and Pike, after Leuret	281
144. Human Embryo of 6th week, showing rudiments of Brain, after Wagner	282
145. Brain of Turtle, after Solly	283
146. Brain of Buzzard, after Leuret	283
147. Brain of Human Embryo at 12th week, after Tiedemann	284
148. Brain of Squirrel laid open, after Solly	284
149. Upper and under surface of Brain of Rabbit, after Leuret	285
150. Diagram of the distribution of the Fifth Pair	311
151. A view of the distribution of the Trifacial nerves	312
152. A view of the Third, Fourth, and Sixth Pairs of nerves	313
153. Diagram of the distribution of the Seventh Pair	314
154. Diagram of the distribution of the Eighth Pair	315
155. A view of the distribution of the Glosso-Pharyngeal, Pneumogastric and Spinal Accessory Nerves, or Eighth Pair	316
156. A view of the course and distribution of the Hypoglossal, or Ninth Pair	324
157. Base of the Cerebrum and Cerebellum with their nerves	327
158. A view of the Optic nerve and the origins of seven other pairs	340
159. Plan of the optic tracts and nerves, after Todd and Bowman	342
160. Course of Fibres in the Chiasma, after Todd and Bowman	342
161. Origin and distribution of the Portio Mollis of the Seventh Pair, or Auditory Nerve	343
162. Capillary network at margin of lips, after Berres	396
163. Dorsal surface of the Tongue, from Sæmmerring	399
164. Simple papillæ near the base of the tongue, after Todd and Bowman	400
165. Vertical section of one of the circumvallate papillæ, after Todd and Bowman	400
166. Compound and simple papillæ of Foramen Cœcum, after Todd and Bowman	400
167. Capillary network of fungiform papilla of tongue, after Berres	401
168. Fungiform papilla with its simple papillæ and vessels, after Todd and Bowman	401
169. Forms of the conical or filiform papillæ, after Todd and Bowman	401
170. { A. Section of filiform and fungiform papillæ B. Structure of filiform papillæ } after Todd and Bowman	402
171. Nerves of the papillæ of the tongue, after Todd and Bowman	403
172. Distribution of Olfactory nerve on Septum Nasi	405
173. Longitudinal section of globe of the eye	408
174. Horizontal section of the eyeball	409

FIG.	PAGE
175. Outer surface of retina of Frog, after Treviranus	412
176. Capillary network of retina, after Berres	412
177. A portion of the retina of an Infant, magnified	412
178. Vertical section of the Human retina and Hyaloid membrane, after Todd and Bowman	413
179. Membrane of Jacob, after Jacob	413
180. General section of the Ear, after Scarpa	423
181. Diagram of the Inner wall of Tympanum, after Todd and Bowman	424
182. Axis of Cochlea and Lamina Spiralis	425
183. Cochlea of a new-born Infant, after Arnold	425
184. Section of the Cochlea, after Breschet	426
185. Papilla of Auditory nerve on spiral lamina of cochlea of young mouse	426
186. Auditory nerve taken out of the cochlea	426
187. Magnified view of the Lamina Spiralis	427
188. Plexiform arrangement of cochlear nerves, after Todd and Bowman	427
189. Soft parts of the Vestibule	428
190. Ampulla of the External Semicircular Membranous Canal	428
191. Labyrinth laid open, after Breschet	433
192. Labyrinth of the Left Side	434
193. Left Ear in its natural state	435
194. Anterior view of the External Ear, Meatus Auditorius, &c.	435
195. External and Sectional views of the Larynx, after Willis	456
196. Bird's-eye view of Larynx from above, after Willis	457
197. Diagram of the direction of the muscular forces of the Larynx, after Willis	458
198. Artificial Glottis, after Willis	461
199. View of the Organs of Digestion in their whole length	493
200. Muscles of the Tongue, Palate, Larynx and Pharynx	495
201. Front view of the Stomach distended	499
202. Interior of the Stomach	499
203. Interior of the Stomach and Duodenum	500
204. Commencement of Lacteal in Villus, after Krause	510
205. Vessels of Intestinal Villus of Hare, after Döllinger	511
206. Do. Do. of Man, after Krause	511
207. Diagram of Lymphatic Gland, after Goodsir	517
208. Portion of intra-glandular Lymphatic, after Goodsir	517
209. Section showing the anatomy of the Thymus gland, after Cooper	521
210. Microscopic appearance of Inflammatory Blood, after Addison	534
211. Web of Frog's foot, slightly magnified, after Wagner	541
212. The anatomy of the Heart	551
213. Hæmadynamometer of Poisseuille	555
214. Gill-tuft of Doris, after Alder and Hancock	573
215. Lung of Triton, slightly magnified, after Wagner	574
216. Portion of the same more highly magnified, after Wagner	574
217. Capillary Circulation in lung of living Triton, after Wagner	575
218. The Larynx, Trachea and Bronchia	576
219. Bronchia and Blood-vessels of the Lungs	577
220. Development of Lungs, after Rathké	578
221. Arrangement of Capillaries in Human Lung	579
222. Mammary Gland of Ornithorhynchus, after Müller	616
223. Exterior of lobule of liver of Squilla, after Müller	619
224. Interior of do. do. do.	619
225. Inferior Surface of the Liver	620
226. Three Coats of the Gall Bladder	620
227. Gall bladder distended, with vessels injected	621
228. Nucleated Cells of Parenchyma of Liver	621
229. Lobules of Liver, with branches of Hepatic vein, after Kiernan	622
230. Horizontal section of lobules, showing arrangement of their blood-vessels, after Kiernan	622
231. Horizontal section of lobules, showing arrangement of their bile-ducts, after Kiernan	622
232. Nucleated Cells forming Parenchyma of Liver, after Bowman	624
233. Origin of Liver in Chick, after Müller	624
234. Lobules in a state of Anæmia, after Kiernan	625
235. Do. in first stage of hepatic-venous congestion, after Kiernan	625

FIG.	PAGE
236. Lobules in second stage of hepatic-venous congestion, after Kiernan - - -	625
237. Do. in a state of portal-venous congestion, after Kiernan - - -	625
238. Hepatic cells loaded with Fat, after Bowman - - -	627
239. Right Kidney, with Renal Capsule - - -	632
240. Section of Kidney after Wilson - - -	632
241. Half a Kidney, divided vertically - - -	633
242. Kidney divided vertically, with Arteries injected - - -	633
243. Section of Kidney, after Wagner - - -	634
244. Portion of Tubulus Uriniferus, after Wagner - - -	634
245. Section of a Pyramid of Malpighi - - -	635
246. Magnified view of small portion of the Kidney, after Wagner - - -	636
247. Structure of Malpighian Body, after Bowman - - -	637
248. Diagram of Circulation in the Kidney, after Bowman - - -	637
249. Corpora Wolffiana, after Müller - - -	637
250. Mammary Gland - - -	647
251. Vertical section of Mammary Gland - - -	647
252. Distribution of Milk-ducts in Mammary Gland, after Sir A. Cooper - - -	648
253. Termination of portion of milk-duct in a cluster of follicles, after Sir A. Cooper - - -	648
254. Mammary follicles, with contained cells, after Lebert - - -	648
255. Lobule of Parotid Gland, after Wagner - - -	656
256. Capillary Network of Glandular follicles, after Berres - - -	656
257. Rudimentary Pancreas of Cod, after Müller - - -	656
258. The Testicle injected with Mercury - - -	658
259. Minute structure of the Testis - - -	658
260. Human Testis, injected with Mercury, after Lauth - - -	659
261. Diagram of the structure of the same - - -	659
262. Sudoriferous Gland, after Wagner - - -	661
263. Layer of Sweat-glands of the Axilla, after Todd and Bowman - - -	662
264. Sweat-gland and its blood-vessels, after Todd and Bowman - - -	662
265. Cuticular portion of a Sweat-duct of the Heel, after Todd and Bowman - - -	662
266. Three views of Sebaceous glands and hair-follicles, after Todd and Bowman - - -	664
267. Cutaneous glands of external Meatus Auditorius, after Wagner - - -	665
268. Cutaneous follicles of the Axilla, after Horner - - -	665
269. Gastric glands in Human Stomach, after Wagner - - -	666
270. Horizontal section of a Stomach-cell and tubes, after Todd and Bowman - - -	666
271. Vertical sections of mucons membrane of Stomach, after Todd and Bowman - - -	667
272. Entrances to secreting follicles, after Boyd - - -	667
273. Stomach-cells and Epithelium, after Todd and Bowman - - -	667
274. Villi and follicles of Lieberkühn on surface of Ileum - - -	668
275. One of the Glandulæ solitariae of Peyer, after Boehm - - -	668
276. Mucous coat of Small Intestine, as altered in Fever, after Boehm - - -	668
277. Glands of Peyer on Small Intestine - - -	669
278. Conglomerate gland of Brunner, after Boehm - - -	669
279. Patch of agminated Peyerian glands, after Boehm - - -	670
280. Extremity of Placental Villus, after Goodsir - - -	705
281. External membrane and cells of Placental villus, after Goodsir - - -	705
282. Diagram of the arrangement of the Placental Decidua, after Goodsir - - -	706
283. Plan of early Uterine Ovum, after Wagner - - -	715
284. Diagram of Ovum, showing formation of digestive cavity and of amnion, after Wagner - - -	715
285. Do. do. still more advanced, the allantois beginning to appear, after Wagner - - -	717
286. Diagram of Ovum in the second month, showing incipient formation of Placenta, after Wagner - - -	717
287. Section of Uterus, showing ovum, membranes, &c., at the time of formation of Placenta, after Wagner - - -	718
288. Diagram illustrating the Fœtal Circulation - - -	721
289. Curve representing the relative Viability of Human Male and Female at different ages, after Quetelet - - -	727
290. Do. do. do. Heights and Weights of the Human Male and Female at different ages, after Quetelet - - -	728

ALSO,

Two Lithographic Plates, with 27 figures.

INTRODUCTION.

THE object of the science of Physiology is to bring together, in a systematic form, the phenomena which normally present themselves during the existence of living beings; and to classify and compare these, in such a manner as to deduce from them the general *laws* or *principles*, according to which they take place.

The term Law having been frequently applied to physical and physiological phenomena, in a manner very different from that which sound philosophy sanctions, it is desirable to explain the acceptation (believed by the author to be the *only* legitimate one) in which it is here employed. The so-called *Laws of Nature* are nothing else than general expressions of the conditions, under which certain assemblages of phenomena occur; so far as those conditions are known to us. Thus the law of Gravitation, in General Physics (the most universal in its action of any with which we are acquainted), is nothing else than a simple expression of the fact, that, under all circumstances, two masses of matter will attract each other with forces directly proportional to their respective bulks, and inversely as their distances. So, again, the law of Cell-growth, which seems to hold the same rank in Physiology with that of Gravitation in Physics, embodies these two general facts,—that all organised beings originate in cells,—and that the various functions of life are carried on, even in the adult condition, by the continued growth and development of cells.

In no case can natural phenomena be correctly said to be *governed* by laws; since the laws themselves are nothing else than manifestations of the Will of the governing Power. But they may be properly said to take place *according to* certain laws; these laws being framed by Man as expressions or descriptions of the slight glimpses he possesses, of the *plan* according to which the Creator sees fit to operate in the natural world. Thus understood, the use of the term Law can be in no way supposed to imply, that the Deity stands in any other relation to the phenomena of the Universe than as their direct and constantly-operating Cause.

In order to determine the true laws, or most general principles, of Physiological Science, a very extensive comparison is requisite. Principles, which might seem of paramount importance in regard to one group of living beings, are often found, on a more general review, to be quite subordinate. For example, the predominance of the Nervous System in the higher classes of Animals, and its evidently close connection with many of the functions of life, has led several Physiologists to the opinion, that its influence is *essential* to the performance of the functions of Nutrition, Secretion, &c.; but, on turning our attention to the Vegetable kingdom, in which nothing analogous to a nervous system can be proved to exist, we find these functions going on with even greater activity than in animals. It is clear, therefore, they *may* be performed without it; and, on a closer examination of the phenomena

presented by Animals, it is seen that these may be explained better, on the principle that the nervous system has a powerful influence on such actions, than on the idea that it affords a condition essential to them. Recent inquiries have shown that the agents *immediately* concerned in these operations are of the same nature in both kingdoms; the separation of the nutrient materials from the circulating fluids, or the elimination of substances which are to be withdrawn from it, being performed in the animal, as in the plant, by *cells*, in the manner to be explained hereafter.—This is only one out of many instances, which it would be easy to adduce, in proof of the necessity of bringing together *all* the phenomena of the same kind, in whatever class of living beings they may be presented, before we attempt to erect any general principles in Physiology.

The object of the present treatise, however, is not to follow out such an investigation; but to show the detailed application of the principles of which Physiological science may now be said to consist, to the phenomena exhibited by the Human being during the continuance of *health or normal life*. These phenomena, when they occur in a disturbed or irregular manner, constitute *disease or abnormal life*; and become the subjects of the science of Pathology. It is impossible to draw a precise line of demarcation, between the states of health and disease; since many variations may occur, which do not pass the limits of what must be called in some individuals the normal state, but which must be regarded as decidedly abnormal actions in others. The sciences of Physiology and Pathology, therefore, are very closely related to each other; and neither can be pursued with the highest prospect of success, except in connection with the other.

Equally close is the relation between Hygiène,—or the *art* of preserving the body in health, which is founded on the science of Physiology,—and Therapeutics, which is the *art* of curing disease, founded upon the science of Pathology. In proportion as the science of Physiology is perfected, will the simplicity and certainty of its practical applications increase; and although we may not anticipate a return of patriarchal longevity, yet the experience of the last century has amply shown, that every general increase of attention to its simple and universally-acknowledged truths is attended with a prolongation of life, and contributes to that not less important object, its emancipation from disease. In like manner, with every advance in Pathological science, will the art of Therapeutics lose its merely *empirical* character, and become more and more *rational*; that is, the rules laid down for the treatment of disease will be less and less founded upon the results of a limited experience as to the efficacy of particular remedies in removing certain abnormal phenomena; and will have reference more and more to the nature of the morbid action, which is indicated by the symptoms. Thus, when the urine presents a particular sediment, our inquiries are directed, not so much to the condition of the kidney itself, as to the constitutional state which causes an undue amount of the substance in question to be carried off by the urinary excretion, or which prevents it from being (as usual) dissolved in the fluid.

In proportion as our treatment of disease thus loses its empirical character, and is founded on scientific principles, must it increase in perfection and success; and in like proportion will the Medical Profession acquire that dignity to which the nobility of its objects entitles it, and that general estimation which will result from the enlightened pursuit of them.

CHAPTER I.

ON THE PLACE OF MAN IN THE SCALE OF BEING.

1. *Distinction between Animals and Plants.*

1. IN entering upon the general survey of the Animal Kingdom, which it is desirable to take before we consider in detail any particular member of it, the question naturally arises,—how is the Animal distinguished from the Vegetable? There is no difficulty in replying to this, if we keep in view merely the higher tribes of each division; no one, for example, would be in any danger of confounding a Whale with a Palm, or an Elephant with an Oak. It is when we descend to the opposite extremity of the scale, that we encounter the greatest difficulty; from the circumstance that the distinguishing characters of each kingdom disappear, one after another, until we are reduced to those which seem common to both. So completely is this the case, that there are many tribes which cannot, in the present state of our knowledge, be referred with certainty to either one division or the other. We are accustomed to think of Animals as beings, which not only grow and reproduce themselves, but which also possess the power of *spontaneously* moving from place to place, and which are *conscious* of impressions made upon them: and we usually regard Plants as beings which are entirely destitute of sensibility and of the power of spontaneous motion,—going through all their processes of growth, reproduction and decay, alike unconscious of pleasure and of pain, and devoid of all power of voluntarily changing their condition. Such a definition is probably the most correct that we can employ; but great difficulties lie in the way of its application. There are many tribes which possess a general structure more allied to that of beings known to be Animals, than to that of any Plants; and which yet present no decided indications, either of sensibility or of voluntary power. Such is the *Sponge*, the fabric of which closely corresponds with that of many Aleyonian Polypes, whose animality is undoubted; whilst there are no known Vegetables to which it presents any near resemblance: and yet neither observation nor experiment has ever succeeded in proving that the *Sponge* feels or spontaneously moves. On the other hand, many Vegetables perform evident movements, which, at first sight, appear to be spontaneous, as if they indicated sensibility on the part of the being that executes them. Such movements, however, can in some instances (as in that of the Sensitive-Plant, or of the Venus's Fly-trap), be referred to a sort of mechanism, the action of which does not involve sensibility, and which may be compared with the many movements (such as that of the heart) that are constantly taking place in the bodies of the highest animals, without their consciousness; and in other cases (as in the *Oscillatoria*) they are so *rhythmical*, as to impress the observer with the idea that they are rather the result of some physical, than of any mental, influence. In this respect they correspond with the motions of the constantly-vibrating *cilia*; which cover the surface of the mucous membranes of Animals; and which have been recently detected in the reproductive particles of certain among the lower tribes of aquatic Plants.

2. However difficult it may be for us, owing to our imperfect knowledge, to draw the line in individual cases, it cannot be doubted that a boundary *does* exist; and, in general, a very simple mark will suffice to establish the distinction. This mark is the presence or absence of a Stomach, or internal cavity for the reception of food. The possession of a stomach cannot be regarded, however, as in itself an essential distinction between the two kingdoms (as some have represented it); for its presence is merely a *result*, so to speak, of the nature of the food of Animals, and of the mode in which it is obtained. Vegetables are dependent for their support, upon those materials only, which they obtain from the surrounding elements; carbonic acid, water and ammonia, duly supplied to them, with a small quantity of certain mineral ingredients, affording all the conditions they require for the production of the most massive fabrics, and the greatest variety of secretions. But these same elements, if supplied to Animals, could not be converted by them into the materials of organized structures; for *they* can only employ them as food, after they have been united into certain peculiar organic compounds; and Animals are consequently dependent, either directly or indirectly, upon the Vegetable kingdom for their means of support. Now they cannot incorporate any alimentary substance into their own tissues, until it has been reduced to the fluid form; hence they need the means of effecting this reduction, which are supplied by the stomach. Again, they cannot be always in immediate relation with their food; they have to go in search of it, and need a store-room in which it may be deposited during the intervals; this purpose also is supplied by the stomach. It is evident, moreover, that the powers of voluntary locomotion and sensation, which Animals enjoy, are connected with the peculiar nature of the food they require; for if they were fixed in the ground, like Plants, they would not be able to obtain that which they require for their support. It is true that there are some, which seem almost rooted to one spot; but these have the power of bringing their food within their reach, though they cannot go in search of it. Such is the case with many Polypes, which use their outspread tentacula for this purpose; and with the lower Mollusca, which can create currents by means of ciliary action.

3. A distinction might probably be erected, between the Animal and Vegetable kingdoms, upon the mode in which the first development of the germ takes place. The seed of the Plant, at the time of fertilisation, principally consists of a store of nourishment prepared by the parent for the supply of the germ, which is introduced into the midst of it. The same may be said of the egg of the Animal. In both instances, the first development of the germ is into a membranous expansion, which absorbs the alimentary materials with which it is in contact; and it prepares these by assimilation, for the nourishment of the embryonic structure, the most important parts of which—the only permanent parts in the higher classes of Animals and in Phanerogamic Plants—are in its centre. Now in Plants, this membranous expansion (the single or double cotyledon) absorbs by its *outer* surface, which is applied to the albumen of the seed, and takes it more or less completely into its own substance. In Animals, this expansion is developed in such a manner, that it surrounds the albumen, inclosing it in a sac, of which the *inner* surface only is concerned in absorption. This sac is, then, the temporary *stomach* of the embryonic structure; it becomes the permanent stomach of the Radiata; but in the higher classes, only a portion of it is retained in the fabric of the adult,—the remainder being cast off, like the cotyledon of Plants, as soon as it has performed its function. Thus, then, the first *nisus* of Animal development is towards the formation of a stomach, for the internal reception and digestion of food; whilst the first processes of Vegetable evolution tend to the production of a leaf-like membrane, which, like the permanent frond of

the lower classes of Plants, absorbs nourishment by its expanded surface only.

4. Some Physiologists have asserted that the nature of the respiratory process affords a ground of distinction between Animals and Plants;—oxygen being absorbed, and carbonic acid evolved, by the former,—and a converse change being effected in the surrounding air by the latter. It is not correct, however, to designate this converse change as a consequence of the respiratory process; for in Plants, as in Animals, there is a continual absorption of oxygen and evolution of carbonic acid, which constitute the true function of *respiration*; but the effects of this change are masked (as it were), in Plants, by those of the fixation of carbon from the atmosphere, which only takes place under the influence of sun-light, and which is much more analogous to the *digestion* of Animals. The most valid distinction, in doubtful cases, seems likely to be founded on the chemical constitution of the tissues themselves. In the plant, the whole of the organized structure, when freed from the products of secretion which are deposited in it, (many of these containing the same proportion of nitrogen as exists in animal flesh,) is found to have the same composition with starch; being formed of oxygen, hydrogen, and carbon only. In the animal, on the other hand, the organised tissues all contain azote as part of their proper substance; non-azotised compounds, such as fatty matter, being merely deposited in these, as products of secretion. Hence if the chemical composition of the organised tissues themselves can be correctly determined, the Vegetable or Animal nature of a doubtful body may be ascertained. By this test, the long-disputed question of the nature of the true *Corallines* has been set at rest; their tissue, when freed from the lime deposited in it, being found to have the composition of that of Plants: and upon evidence of the same kind, (the presence of *starch* in their interior,) a large number of tribes, which have been described by Ehrenberg as *Animalcules*, are now generally referred to the Vegetable kingdom.

2. *General Subdivisions of the Animal Kingdom.*

5. The animal kingdom was formerly divided into two primary groups,—the *Vertebrated* and the *Invertebrated*; the former comprising those which are distinguished by the possession of a jointed spinal column, consisting of a number of internal bones, termed *vertebræ*; and the latter including all those animals which are destitute of this support. It was pointed out by Cuvier, however, that among the *Invertebrata* there are three types of organization, as distinct from each other as any of them are from the *Vertebrata*; and he accordingly distributed the whole under four primary divisions or sub-kingdoms: of these, the *VERTEBRATA* rank highest; next, the *ARTICULATA* and the *MOLLUSCA*, which may be said to form two parallel series, both of them inferior in degree of organization to the *Vertebrata*, but superior to the lowest group; and lastly, the *RADIATA*, which include those animals that border most closely, both in external aspect, and in general character, upon the Vegetable kingdom. The members of these groups are readily separated from each other by the structure of their skeletons, or organs of support and protection; as well as by many other characters. In the *Vertebrata*, the skeleton consists of a number of internal jointed bones, which are clothed by the muscles that are attached to them and move them; these bones are traversed by blood-vessels, and are to be regarded as in all respects analogous to the other living tissues of the body. In the *Articulata*, the soft parts are supported by a hard external envelope, which is of corresponding form on the two sides of the median line, and which is divided into several pieces, jointed or articulated together by a membrane, in such a manner as still to allow of free motion;

and the muscles, which are numerous and complex, are attached to the interior of these. In the Mollusca, the whole body is quite soft; and many species exist, in which it has no external protection; in a large proportion of the group, however, the surface has the power of producing shelly matter, so as to form a protective habitation, within which the animal can withdraw its body, but which does not exhibit any very definite type of form. In the Radiata, all the parts are arranged in a circular manner, the mouth being in the centre; some of them are protected by firmly-jointed external skeletons, like those of the Articulata; whilst others deposit calcareous matter in the centre of their soft fleshy structures, as if sketching out the internal skeleton of the Vertebrata. The skeletons of most of the Invertebrata differ, however, from those of Vertebrate animals, in this important character,—that they are not permeated by vessels, and are formed only by superficial deposition. Hence they are termed extra-vascular: and it is an obvious result of an arrangement of this kind, that parts once formed are never changed, except by the ordinary processes of decay, and that they can only be extended by addition to their exterior; whilst in Vertebrata, the bones are subject to alterations of any kind, whether of removal or addition, throughout their entire substance. It is not correct to regard them, however, as mere exudations, or as being destitute of vitality; since they consist, in all instances, of a regularly-organized tissue, in which the mineral matter, where such exists, is deposited; and in several cases they are traversed by tubes, which seem to convey a fluid destined for their nutrition, if not actual blood. Fabrics of this kind are on the same footing with the *dentine* and *enamel* of the teeth of Vertebrata (§§ 209, 210); to which they sometimes bear a very strong resemblance.—A more detailed account of the general structure of these sub-kingdoms will now be given, beginning with the lowest.

3. *General characters of Radiata.*

6. The RADIATA possess many points of affinity with the Vegetable kingdom; and of these, the circular arrangement of their parts is one of the most evident. Many species of Sea-Anemone, for instance, present an appearance so much resembling that of various composite blossoms, as to have been commonly termed Animal-flowers,—a designation to which they further seem entitled, from the small amount of sensibility they manifest, and the evident influence of light upon their opening and closing. But it is in the tendency to the production of compound fabrics,—each containing a number of individuals, which have the power of existing independently, but which are to a certain degree connected with one another,—that we recognise the greatest affinity in structure, between this group and the Vegetable kingdom. Every tree is made up of a large number of buds, which are composed of leaves arranged round a common axis; each bud has the power of preserving its own life, and of reproducing the original structure, when removed from the parent stem, if placed in circumstances favourable to its growth; and yet all are connected in the growing tree, by a system of vessels, which forms a communication between them. This is precisely the nature of the structures formed by the animals of that class, which may be regarded as the most characteristic of the Radiate group. Every mass of Coral is the skeleton of a compound animal, consisting of a number of polypes, connected together by a soft flesh, in which vessels are channelled out; these polypes are capable of existing separately, since each one, when removed from the rest, can in time produce a massive compound fabric, like that of its parent; but they all contribute to the maintenance of the composite structure, so long as they are in connection with it. In some instances the skeleton is stony, and is formed by the deposition of

calcareous matter—either in the centre of each fleshy column, so as to form a solid stem,—or on its exterior, so as to form a tube. In other cases it is horny; and then it may be a flexible axis, or a delicate tube. Both the stony and horny Corals frequently possess the form of plants or trees: and as their skeletons are often found with no obvious traces of the animals to which they belonged, they have been accounted Vegetable growths. There is not the least doubt, however, as to the Animal origin of the greater part of these plant-like structures.

7. The affinity between the lowest Radiata and Plants, in regard to the vital phenomena they exhibit, is still more close than that manifested by their structure. Although, in the higher groups, movements may be constantly witnessed, which evidently indicate consciousness and voluntary power, this is far from being the case in the lower. There are many tribes, whose reception of food, growth, and reproduction, are not known to be accompanied by any phenomena which distinctly indicate their animal character. The most violent lacerations produce no signs of sensibility; and the movements occasionally exhibited by them have not so much of a spontaneous aspect as those which are performed by many plants. This is the case, for example, with the *Sponge* tribe; and also with a number of microscopic species. So

Fig. 1.

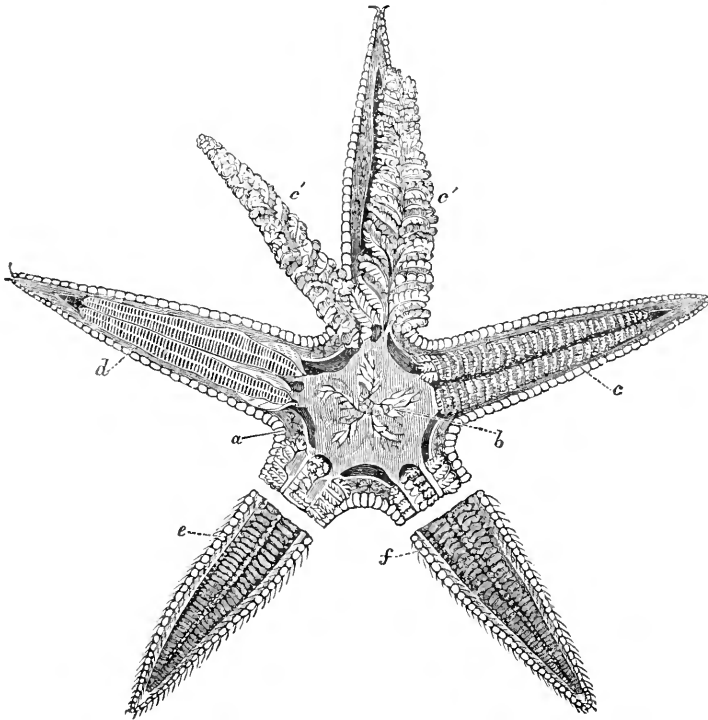

Asterias aurantiaca, with the upper side of the hard envelope removed; *a*, central stomach; *b*, caeca upon its upper surface, probably answering to the liver; *c, c*, caecal prolongations of stomach into rays; *c', c'*, the same empty; *d*, the same opened; *e*, under surface, showing vesicles of feet; *f*, vesicles contracted, showing skeleton between them.

doubtful is the nature of these beings, that their Animal or Vegetable character is rather to be decided by their affinity with species known to belong to one or the other kingdom, and by the chemical composition of their tissues, than in any other way.

8. It is very different, however, in regard to the higher Radiata. Even among the Zoophytes (as the plant-like animals just alluded to are commonly termed), there are some species which are unattached during the whole period of their lives, and which have a power of voluntarily moving from place to place, such as is never possessed by plants. And in the highest class, the Echinodermata, including the Star-fish, Sea Urchin, &c., we meet with a considerable degree of complexity of structure, and a corresponding variety of actions. Still, except in those species which connect this group with others, the same character of radial or *circular* symmetry is maintained throughout; and in no animal is it more remarkable than in the common Star-fish. It is exhibited alike in its internal conformation and in its external aspect. The mouth, placed in the centre of the disk, leads to a stomach which occupies the greatest part of the cavity of the body; and this sends prolongations into the arms, which are exactly alike in form, and which occupy a precisely similar position in every one. Each arm is furnished, on its under side, with a curious apparatus for locomotion, consisting of a series of short elastic tubes, which are prolonged through apertures in the hard envelope, from a series of vesicles placed along the floor (as it may be termed) of the ray. The system of vessels for absorbing nutriment and conveying it through the system, is also disposed upon the same plan; and the same may be said of the nervous system, and of the only organs of special sensation which this animal appears to possess—the rudimentary eyes, of which one is found at the extremity of each ray.

9. Amongst other results of the repetition of similar organs, so remarkable in the Radiated group, is this,—that one or more of them may be removed without permanent injury to the whole structure, and may even develope themselves into an entire fabric. Thus in the Star-fish, instances are known of the loss of one, two, three, and even four rays, which have been gradually reproduced; the whole process appearing to be attended with little inconvenience to the animal. In some species of isolated Polypifera, such as the common Sea-Anemone, and Hydra (Fresh-water Polype), this power of reproduction is much greater. The Hydra may be cut into a large number of pieces (it is said as many as 40) of which every one shall be capable of developing itself in time into a perfect polype. The Sea-Anemone, when divided either transversely or vertically, still lives; and each half produces the other, so as to reform the perfect animal. This is another character which shows the affinity of the Radiata to the Vegetable kingdom; and there is yet another, derived from their mode of reproduction. In many Polypifera, we observe a propagation by *buds*, in all respects conformable to that which plants effect, and quite different from the regular multiplication by distinct germs. This gemmarous reproduction, as it is called, takes place, not only in the *compound* Polypifera, whose plant-like structures are extended by it, but also in some isolated species, such as the Hydra; from the body of which one or more young polypes bud forth at the same time; and these buds may themselves put forth another generation, previously to their separation from their parent. This kind of reproduction is not seen anywhere else in the whole Animal kingdom, except in a few of the lowest Mollusca and Articulata, which border most closely on the Radiata.

10. In the lowest animals of this group, such as the simplest forms of Polypes, we find the whole body to consist of nothing else than a stomach, fur-

nished with tentacula for drawing food to its orifice.* The nutrient materials are imbibed by the walls of the stomach, and are transmitted by them to the tentacula, without any regular circulation; and the exposure of the whole of the soft surface of the body to the surrounding liquid, affords all the aeration which is requisite. In the Medusæ, or Jelly-fish, we often find the stomach extending itself into a ramified system of tubes, which convey its contents to the thin border of the umbrella-shaped disk, for more effectual aeration; but there is still no separate circulating system, except in a few instances. In the class of Echinodermata, however, which includes the highest forms of Radiated animals (such as the Asterias or Star-fish, Echinus or Sea-Urchin, and Holothuria or Sea-Cucumber), we find the digestive cavity restricted within much narrower limits; and there is here a distinct system of vessels, adapted to absorb the nutrient fluid from the digestive cavity, and to convey it to the remoter parts of the system for their nutrition, as well as to effect its aeration, by exposing it to the influence of the air contained in the surrounding liquid, in organs especially adapted for that purpose.

4. *General characters of Mollusca.*

11. The range of Animal forms comprehended in the Sub-Kingdom MOLLUSCA is so great, that it would be difficult to include them in any positive definition which should be applicable to all. They present few traces of the circular disposition of organs around the mouth, which is characteristic of the Radiated classes; and we seldom meet with any marked approach to the elongation of the body,—still seldomer with any indication of that division into segments,—which are the chief peculiarities of the Articulata. It is by the absence of these, and of any trace of the Vertebrated structure, that the Mollusca are most readily defined. The variety of form which they present, is less surprising, when it is considered that the bulk of their bodies is almost entirely made up by organs of nutrition; the organs of sensation and locomotion, which they possess, being chiefly subservient to the supply of these. We find, in the lowest tribes of this group, living beings which are fixed to one spot during all but the earliest period of their lives; and which scarcely possess within themselves so much power of movement, as that enjoyed by the individual Polypes in a compound polypidum; and yet these exhibit a complex and powerful digestive apparatus, a regular circulation of blood, and an active respiration. We never find, throughout the whole Animal kingdom, that the apparatus of organic life is arranged on any definite plan of its own; its confirmation being adapted to the type which predominates in the structure of each group, and which is principally manifested in the disposition of the locomotive organs. Thus, the stomach of the Star-fish is circular, and sends a prolongation into each ray; whilst the digestive cavity of the Articulata is prolonged into a tube. In the Mollusca, there is no such definite type, the apparatus of nutrition having the predominance over that of locomotion; and the form of the body is, therefore, extremely variable. The relative places, even of the most important organs (such as the gills), are found to undergo complete changes, as we pass from one tribe to another; although their general structure is but little altered.

12. The lower Mollusca may be characterised as consisting merely of a

* It is usual to speak of the orifice of the stomach, in the Polypes, as the *mouth*; and to regard the tentacula as prolonged *lips*. It appears to the author much more reasonable, however, to consider this aperture as the *cardiac orifice* of the stomach; and to regard the tentacula in the light of *pharyngeal constrictors*, their office being to grasp the food and convey it to the stomach. This view is borne out by the conformation of the superadded parts in the Ciliobrachiata Polypes and Ascidian Molluscs.

bag of viscera; they have not even any prominence for the mouth, nor any organs of special sense, such as would distinguish a *head*; and they are entirely destitute of *symmetry*,—the *radiated* arrangements of parts seen in Zoophytes being absent, as well as the *bi-lateral* correspondence which is characteristic of the higher sub-kingdoms. In the more elevated Mollusca, however, which possess not merely sensitive tentacula, but eyes and even organs of smell and hearing, we find these disposed in a symmetrical manner; so that the head, which is the part concerned peculiarly in animal life, does present a bi-lateral equality of parts, even when the remainder of the body wants it. Further, in the more active among the higher classes, we find this bi-lateral symmetry showing itself in the exterior of the whole body; evidently bearing a pretty close relation to its degree of locomotive power. It is most evident and complete in the Cephalopoda (*Cuttle-fish* tribe); many of which are adapted to lead the life of Fishes, and resemble them in the general form of the body, as also in the structure of many of the individual organs. It is also manifested in many of the shell-less Gasteropoda, such as the Slug, or the *Aplysia* (Sea-Hare); as will be seen by the accompanying representation of a species of the latter. But this symmetry does not extend

Fig. 2.

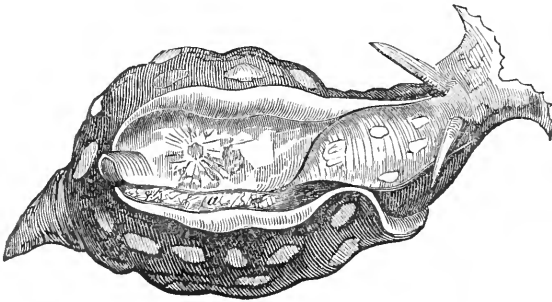
*Aplysia depilans*; a, branchiæ or gills.

to the arrangement of the *internal* organs; and appears to be only designed to adapt the body for more convenient locomotion.

13. As a group, however, the Mollusca are to be characterised rather by the *absence*, than by the possession, of any definite form; and there is a corresponding absence of any regular organs of support, by which such a form could be maintained. The name they have received designates them as *soft* animals; and this they are pre-eminently, as every one knows, who has taken a Slug between his fingers. The shell, where it exists, is to be regarded rather in the light of an appendage, designed for the mere protection of the body, and deriving its shape from the latter, than as a skeleton, giving attachment to muscles, and regulating the form of the whole structure. It is in no instance a fixed point for the muscles of locomotion; and it is only, indeed, where the body is uncovered by a shell, or where a locomotive organ may be projected beyond it, that any active movements can be executed. This locomotive organ,—the *foot*, as it is commonly termed—is nothing else than a fleshy mass, formed by the increased development of the muscular portion of one part of the general envelope of the body, termed the *mantle*, in which the visceral mass is loosely included. The *mantle* is not essentially different from the *skin* of other animals; but it is usually thicker, possessing a considerable amount of muscular fibre interwoven with it, and its

surface having frequently a glandular character. This general muscular envelope is the only locomotive organ possessed by a large portion of the Mollusca; but its contractile properties are usually greatest at some particular spot, where it is thickened into a sort of disk, by the alternate contraction and extension of which the animal can slowly propel itself; this is well seen, by causing a Snail or Slug to crawl over a piece of glass, so that the under surface of the disk may be seen whilst it is in operation. The general character of their locomotion, however, is well expressed by the term *sluggish*; and there are scarcely any among the typical Mollusca, whose activity is such as to demand for them any higher appellation.

14. The general development of their organs of Nutrition, however, is

Fig. 3.

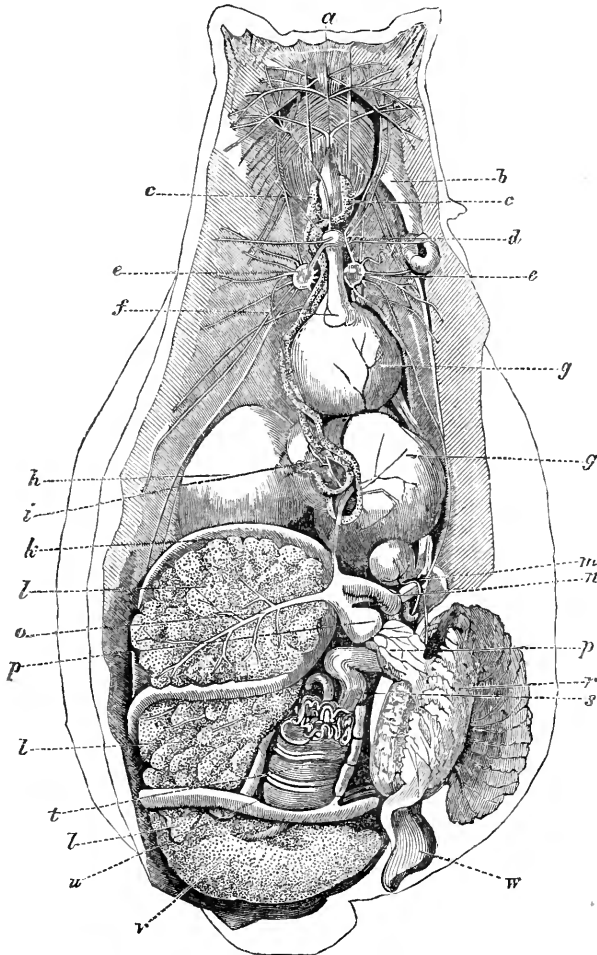

Aplysia cut open, showing the viscera; *a*, the upper part of œsophagus; *b*, penis; *c, c*, salivary glands; *d*, superior or cephalic ganglion; *e, e'*, inferior or subœsophageal ganglia; *f*, termination of œsophagus; *g, g*, first stomach; *h*, third stomach; *i*, second stomach; *k*, intestine; *l, l, l*, liver; *m*, posterior ganglion; *n*, aorta; *o*, hepatic artery; *p*, ventricle of heart; *q*, auricle; *r, s*, branchiæ; *t*, testis; *u*, lower part of intestine; *v*, ovary; *w*, anus.

much higher than is met with among the Articulata; and, in proportion to that of the organs of Locomotion, it is much greater than will be elsewhere observed throughout the Animal kingdom. The justice of this statement will be made evident by a slight examination of the preceding figure, in which the interior structure of the *Aplysia*, showing the general character of that of the group, is displayed. The only distinct set of muscles, possessed by this animal, is that connected with the mouth; which it is able to push forwards or to draw back, and which possesses considerable powers of mastication, and is furnished with large salivary glands. The nervous centres (of which more will be said hereafter) are seen to be principally disposed around the œsophagus. The whole digestive apparatus is observed to be very complex and highly developed; the liver alone occupying a considerable part of the cavity. The heart has distinct muscular walls, and is divided into a separate auricle and ventricle; and a large respiratory organ is developed for the aeration of the blood. The position of the gills, which are external to the cavity, but which are concealed in part by a fold of the mantle, and in part by the rudimentary shell, is seen at *a*, Fig. 2. The generative apparatus, also, is highly developed. Yet with all this complex organization, the locomotive power of the animal is not much greater than that of the Slug; no other means being provided for the purpose than the contractility of the general envelope, which is greatest in the thickened portion on the under side of the body.

15. The blood of the Mollusca is white, and the number of corpuscles in it is small. Their temperature is low, being seldom more than one or two degrees above that of the surrounding medium; but many of them are capable of being subjected to extreme variations of heat and cold, without their vitality being thereby destroyed. Their respiration is for the most part aquatic; and is performed by means of gills, over which a current of water is constantly being propelled, by the vibration of the cilia that cover their surface. Many of them are dependent on the same current for their supplies of food; part of the water so introduced being taken into the stomach; and a part flowing over the respiratory surface. The higher tribes, however, go in search of their food, and have instruments of mastication for reducing it; but in these, as in the former, the anal orifice of the intestine opens into the passage through which the current that has passed over the respiratory organs finds egress; so that the fecal matter from the former, and the fluid that has served the purpose of the latter, are discharged together. Although very voracious when supplies of food come in their way, most of the Mollusca are capable of fasting for long intervals, where none offer themselves,—a fact which is readily explained by that general inertness of their vital processes, which has been stated to be characteristic of the group.

5. *General characters of Articulata.*

16. The members of the sub-kingdom, ARTICULATA, are distinguished, for the most part, by characters which are exactly opposed to those just enumerated. Their characteristic form is easily defined; and in no instance is there any wide departure from it. The body is more or less elongated, and presents throughout a most exact bi-lateral symmetry. It is completely inclosed in an integument of greater density than the rest of the structure, which is divided into distinct rings or segments; these, being held together by a flexible membrane, allow considerable freedom of motion, whilst they firmly protect the soft parts, and afford attachment to numerous muscles. It is in the Centipede, and other such animals, that this division into segments is most distinctly and regularly marked. In the lower Articulata, such as the Leech and the Earth-

worm, the integument is altogether so soft, that the intervals of the articulations are not very distinct from the rings themselves; and in the highest Crustacea and Arachnida, the segments are so closely united together, as to be in some instances scarcely recognizable. In the former, the movements of the body are entirely effected by its own flexion; whilst in the latter, they are committed to members developed for that special purpose. These members also have an articulated external skeleton. The bulk of the body in the Articulata is made up of the muscles, by which the several segments and their various appendages are put in motion; these muscles have their fixed points on the interior of the hard envelope, just as they are attached in Vertebrated animals to the exterior of the bones; and they form a system of great complexity.

17. The development of the organs of nutrition in Articulata, would seem to be altogether subservient to that of the Locomotive apparatus,—their function being chiefly to supply the nerves and muscles with the aliment necessary to maintain their vigour. The power of the muscles is so great in proportion to the size of the animals, that in energy and rapidity of movement, some of the Articulated tribes surpass all other beings. Their movements are directed by organs of sensation, which, although not developed on so high a plan as those of some Mollusca, are evidently very acute in their powers. There are very few instances of Articulated animals being in any way restrained as to freedom of locomotion; and these are found in a single group, the *Cirrhopoda* or Barnacle tribe, which connects this sub-kingdom with the last. In general, they roam freely abroad in search of food, and are supplied with prehensile organs for capturing their prey, and with a complex masticating apparatus for reducing it. Their actions are evidently directed almost solely by *instinctive* propensities, which are adapted to meet every ordinary contingency, being of similar character in each individual of the same species, and presenting but little appearance of ever being modified by intelligence. Hence these animals seem like machines, contrived to execute a certain set of operations; many of them producing immediate results, which even Man, by the highest efforts of his reason, has found it difficult to attain.

18. All the Articulata, save a few of the very lowest species, possess a distinct head at one end of the body, furnished with organs of special sensation, and with lateral jaws for the prehension and reduction of food; and their movements, being principally guided by the special senses, take place in this direction. The bi-lateral symmetry of the body is not confined to its exterior; for it prevails most completely in the whole muscular apparatus; and even the organs of nutrition present more distinct traces of it than are to be seen elsewhere. The compact heart of the Mollusca, for instance, is here replaced by a long tube, the *dorsal vessel*, placed on the median line; and the respiratory organs, which are usually diffused through the whole system, are uniform on the two sides. Even the intestinal canal partakes of this symmetry; in some species it runs straight from end to end of the body; and even where it is otherwise disposed, its appendages are nearly equal on the two sides. The respiration of this group is for the most part aerial; and the apparatus for the purpose consists of a series of chambers or tubes, which are dispersed or extended through the whole body, and which are expanded at certain points, in insects possessing considerable powers of flight, into large air-sacs. By this means, the air, the blood, and the tissue to be nourished, are all brought into contact at the same points; and a much less vigorous circulation is required than would otherwise be needed; whilst, at the same time, the specific gravity of the body is diminished, and flight thereby rendered more easy. The whole apparatus of nutrition is comprised within a comparatively small part of the body; and the bulk of the organs which compose

it, is never at all comparable with that which we ordinarily find in the Mollusca. Thus, the liver, which in the Oyster forms a large part of the whole substance, is often scarcely recognizable as such in the Insect; and the intestinal tube seldom makes many convolutions in its course from one extremity to the other. The blood is usually white, as in the other Invertebrated classes; but it contains a larger number of corpuscles than are seen in that of most of the Mollusca. The temperature varies to a certain degree with that of the atmosphere; but many Insects have the power of generating a large amount of independent heat, which is strictly proportionable to the quantity of oxygen converted by them into carbonic acid in the respiratory process. All the actions of the Articulata are performed with great energy; and, at the time of the most rapid increase of the body, the demand for food is so great, that a short suspension of the supply of aliment is fatal. Many of them are capable, however, of being submitted to the influence of very extreme temperatures, with little permanent injury.

19. The adjoining figure, which displays the muscular apparatus of the interior of the body of a Cock-chaffer, will give an idea of its complexity and variety, and of the large portion of the trunk which is occupied by it; and will also show the division of the skeleton into segments, the number of which in Insects is limited to thirteen. These are nearly equal and similar to each other in the Larva; but, in the perfect Insect, the three behind the head are united into the thorax, to which the legs and wings are attached; and the remainder form the abdomen, which has little concern in locomotion.

Fig. 4.

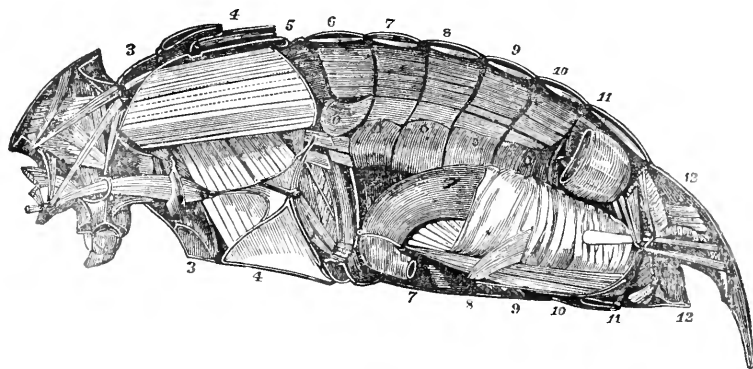

Section of the trunk of *Melolontha vulgaris*. (after Strauss-Durckheim.) showing the complexity of the Muscular system. The first segment of the thorax (2) is chiefly occupied by the muscles of the head, and by those of the first pair of legs. The second and third segments (3 and 4) contain the very large muscles of the wings, and those of the other two pairs of legs. The chief muscles of the abdomen are the long dorsal and abdominal recti, which move the several segments one upon the other.

6. General characters of Vertebrata.

20. In none of the three preceding divisions of the Animal kingdom, does the Nervous System attain such a degree of development, as to give it that predominance in the whole fabric which it evidently possesses in VERTEBRATA. In the Radiata and Mollusca, its functions are obviously restricted to the maintenance of the nutritive operations; and to the guidance of the animal, by means of its sensory endowments, in the choice of food, as well as (in some instances) in the search for an individual of the opposite sex: in the

Articulata, its purpose appears similar, but is carried into effect in a different manner, the locomotive organs being the parts chiefly supplied by it. In the Vertebrata, on the other hand, the development of all the other organs appears to be subordinate to that of the Nervous System; *their* object being solely to give to *it* the means of the exercise of its powers. This statement is not, of course, as applicable to the lower Vertebrata, as it is to the higher; but it is intended to express the *general* character of the group. The predominance of the nervous system is manifested, not only in the increased size of its centres, but also in the special provision which we here find, for the protection of these from injury. In the Invertebrated classes, wherever the nervous system is inclosed in any protective envelope, that envelope serves equally for the protection of the whole body. This is the case, for example, in regard to the spiny integument of the Star-fish, the shell of the Mollusca, and the firm jointed rings of the Insect. The only exceptions occur in a few tribes, in which the nervous system is much concentrated; and in which the general organization approaches that of the Vertebrata.* In Vertebrated animals, we find that the skeleton essentially consists of a series of parts, which are destined to inclose the nervous centres, and to give attachment on their exterior to the muscles by which the body is moved; hence it may be termed the *neuro-skeleton*; in contradistinction to the *dermo-skeleton*, which envelops the whole body in many Invertebrata, being formed on the basis of their integument. The tissues, bone and cartilage, of which the former is composed, are more closely connected with the vascular system, than are the hard parts of Invertebrata; and are consequently more capable of undergoing interstitial change.

21. In considering the essential character of the skeleton of Vertebrata, we should look at its simplest forms,—those in which it has the least number of superadded parts. We find these in the Serpent tribe, among Reptiles, and in the Eel and its allies among Fish. If we examine their skeletons, we perceive that the Spinal Column, with the Cranium at its anterior extremity, constitutes the essential part of the vertebrated frame-work; and that the development of members is secondary to this. The Spinal Column usually consists of a number of distinct bones, the Vertebræ; each of which is perforated by a large aperture, in such a manner that, when the whole is united, a continuous tube is formed for the lodgment of the spinal cord. The Cranium, which it bears at its upper end, is in reality formed of the same elements as the vertebræ, instead of differing from them completely in structure, as we might be led to suppose by examination of its most developed forms only. The object of this enlargement is to inclose the brain, or mass of cephalic ganglia, which attains a greatly-increased size in the Vertebrata; and also to afford support and protection to the organs of special sense, which are far more highly developed among them than they are in the lower classes. The true nature of the cranium is best seen in those animals, in which the brain bears but a small proportion to the spinal cord, such as the lower Reptiles and Fishes; and an examination of its structure in these satisfactorily proves the reality of this view, which is further borne out by the history of its development, and of that of its contained parts, in the higher Vertebrata.

22. The Vertebral column at its opposite extremity, is usually contracted instead of being dilated,—forming a tail, or a rudiment of one, from which the nervous centres are entirely withdrawn; the development of the tail is

* Thus, in the highest Crustacea, there is an internal projection from the shell, on each side of the median line, which forms a sort of arch inclosing the ventral cord; and in the naked Cephalopoda, the nervous centres are supported, and in part protected, by cartilaginous plates, which are evidently the rudiments of the internal skeleton of the Vertebrata.

commonly seen to be in an inverse proportion to that of the cranium. To this column, the ribs and extremities are merely appendages, which we find more or less developed in the various tribes, and often entirely absent; whilst the vertebral column is never wanting, although reduced in some species to a very rudimentary state. It is interesting to compare its various conditions, with those which have been noticed in the external skeleton of the Articulata. In the lowest animals of the group, locomotion is principally or even entirely performed by flexion of the body itself; and here, as in the worm tribe, we find the skeleton extremely flexible, the whole being comparatively soft, and its divisions indistinct. This is the case, for example, in the Lamprey and other Cyclostome fishes: in which there is no distinct division into vertebræ, the spinal column scarcely possessing even the density of cartilage. In proportion, however, as distinct members are developed, and the power of locomotion is committed to them, we find the firmness of the spinal column increasing, and its flexibility diminishing; and in Birds,—in which, as in Insects, the movements of the body through the air are effected by muscles that must have very firm points of support,—the vertebral column is much consolidated by the union of its different parts, so as to form a solid frame-work. As a general rule, then, the mobility of the extremities, and the firmness of the vertebral column, vary in a like proportion. The number of these extremities in Vertebrata never exceeds *four*; and two of them are not unfrequently absent. The power of locomotion is not developed to nearly the same proportional extent, as in the Articulata; the swiftest bird, for example, not passing through nearly so many times its own length in the same period, as a large proportion of the Insect tribes: but it is far greater than that, which is characteristic of the Mollusca; and there is no species that is fixed to one spot, without the power of changing its place. On the other hand, the highest Mollusca approach them very nearly in the development of organs of special sense, of which Vertebrata almost invariably possess all four kinds—sight, hearing, smell, and taste.

23. The perfection of the Articulate structure has been shown to consist in the development of those powers which enable the animal to perform actions denoting the highest *instinctive* faculties. That of the Vertebrata evidently tends to remove the animal from the dominion of undiscerning, uncontrollable, instinct; and to place all its operations under the dominion of an *intelligent* will. We no longer witness in these operations that uniformity, which has been mentioned as so remarkable a characteristic of instinctive actions. There is evidently, among the higher Vertebrata especially, a power of choice and of determination, guided by a perception of the nature of the object to be attained, and of the means to be employed, constituting the simplest form of the reasoning faculty; and the amount of this bears so close a relation with the development of the cerebrum, that it is scarcely possible to regard the two as unconnected. In Man, whose cerebrum is far larger in proportion to his size, as well as more complex in its structure, than that of any other animal, the reasoning faculties attain the highest perfection that we know to be anywhere manifested by them in connection with a material instrument; the instinctive propensities are placed under their subjection; and all his acts, excepting those immediately required for the maintenance of his organic functions, are put under their control. It is to Man, therefore, that what was just now stated, of the predominance of the nervous system in Vertebrata, particularly applies; but the same may be noticed, though in a less striking degree, throughout the group. Not only is the influence of the nervous system to be traced, in the sensible movements which they perform; but also in various modifications of the organic functions, which take place under the influence of particular states of mind, and the occurrence of which there is no reason

to suspect in the lower tribes of animals. These are even much more striking in Man, than in the lower Vertebrata; indeed the comparative slowness of the influence of the mind upon the body, is one of the causes which render the lower Mammalia more able than Man is to recover from the effects of severe injuries. The Mollusca seem to grow like plants; their massive organs increasing by their own separate vitality, and being but little dependent upon each other. Even the act of respiration, which is in most animals performed by a series of distinct muscular contractions, is there principally effected through the medium of the cilia which clothe the respiratory surface. But in the Vertebrata, the nervous system possesses a distinct and independent rank; its offices are those which more particularly constitute the active life of the animal; the organic functions have for their chief object, the maintenance of the nervous and muscular apparatus in the condition requisite for their activity; and in consequence, all these different kinds of apparatus are so interwoven together, that their mutual dependence is very close.

24. The foregoing remarks will be found to have an important bearing on the details subsequently to be given respecting the functions of the Nervous system in Man; and it is desirable to set out with clear ideas on this subject, since there is no department of Physiology, regarding which more error is prevalent. There is no valid reason for believing that the Organic functions in Animals, any more than the corresponding changes in Plants, are *dependent* on the nervous system for their performance; but common observation shows, that they are much influenced by it in the higher animals; and from such a comparison as that which has been just now briefly made, it would appear that, the higher the general development of the nervous system, the closer is their relation with it.

25. This general character of the Vertebrata harmonises well with what may be observed, on a cursory glance at the structure of their bodies, as to the proportion between the organs of Nutrition and those of Animal life. The former, contained in the cavities of the trunk, are highly developed; but, as in the Mollusca, they are for the most part unsymmetrically disposed. Of the latter, the nervous system and organs of the senses occupy the head; whilst the muscles of locomotion are principally connected with the extremities: both are symmetrical, as in the Articulata; but, whilst that part of the nervous centres, which is the instrument of reason, is very largely developed, the portion which is specially destined to locomotion, together with the muscular system itself, bears much the same proportion to the whole bulk of the body, as it does in the Articulated series. Hence we observe that the Vertebrata unite the unsymmetrical apparatus of nutrition, characteristic of the Mollusca, with the symmetrical system of nerves and muscles of locomotion, which is the prominent characteristic of the Articulata; both, however, being rendered subordinate to the great purpose to be attained in their fabric,—the development of an organ, through which *intelligence* peculiarly manifests itself. — For the operations of this, a degree of *general* perfection is required, which is not met with elsewhere. The higher Vertebrata have a power of constantly keeping the temperature of the body up to a point, which it can only attain occasionally, and under peculiar circumstances, in the Articulata, and which it never reaches in the Mollusca. This involves an energetic performance of the functions of respiration and circulation; and these again require considerable activity of digestion. All the Vertebrata have red blood, which is propelled through the system by a distinct muscular heart; and the number of red corpuscles, which any given amount of the fluid contains, bears a nearly constant proportion to the ordinary temperature of the animal. They are further distinguished from Articulata by a character which seems of little importance, but which is very constant in each group. Whilst the mouth of the

latter is furnished with two or three pairs of jaws which open *sideways*, that of the former has never more than one pair of jaws, which are placed one *above* or *before* the other; and these jaws are usually armed with teeth, which are very analogous in their structure to bone.

7. *General characters of Fishes.*

26. The Vertebrata are subdivided into classes, principally according to their mode of performing the functions of respiration and reproduction. Thus, FISHES are at once separated from all other groups, by the circumstances of their being adapted, like the aquatic Invertebrata, to aerate their blood by gills; and being hence enabled to inhabit water during their whole lives, without the necessity of coming to the surface to breathe. The low amount of their respiration prevents their bodies from ever attaining a temperature much above that of the surrounding medium; hence they are spoken of as cold-blooded. Further, they are oviparous; an ovum or egg being deposited by the parent, from which, in due time, the young makes its way; or if, as sometimes happens, the ovum is retained within the body of the parent until it is hatched, the young animal, though produced alive, is not subsequently dependent upon its parent for support. In many respects, the organization of Fishes is not much advanced beyond that of the higher Mollusca. Their respiratory apparatus has the same character; and the organs by which the blood is depurated of its superfluous azote, rather correspond with the temporary Corpora Wolffiana of higher animals, than with their true Kidneys (СНАР. XV. 3). The vertebral column itself is often very imperfectly developed; in a large proportion of the group, the skeleton is cartilaginous only; and in the lowest species, it does not even manifest a trace of division into vertebræ. Living habitually in an element, which is nearly of the same specific gravity with their own bodies, Fishes have no weight to support, and have only to propel themselves through the water. Accordingly we find their structure adapted rather for great freedom of motion, than for firmness and solidity; and as progressive motion is chiefly effected by the lateral action of the spine, the vertebræ are so united, as to move very readily upon one another. Instead of being articulated together by surfaces nearly flat, as in Mammalia, or by ball-and-socket joints, as in Serpents, they have both their surfaces concave: and these glide over a bag of fluid (the representative of the intervertebral substance in the higher animals), which is interposed between each pair. The tail is flattened vertically; so as, by its lateral stroke, to propel the Fish through the water. By this character, true Fishes are distinguished from those aquatic Mammalia, which are adapted to inhabit their element, and which commonly receive the same designation; for the latter, being air-breathing Animals, are obliged to come frequently to the surface to respire; and their tail is flattened horizontally, to enable them to do this with facility. The lateral surface of the body of Fish is further extended above, by the projection of the dorsal fin, which is supported on the spinous processes of the vertebræ; and below, by the abdominal fin, which also is placed on the median line; these will, of course, increase the power of the lateral stroke of the body, and can only be moved with the spine. The pectoral and ventral fins, on the other hand,—the former of which answer to the superior extremities, and the latter to the inferior extremities, of Man,—serve, by their independent movements, rather as steering than as propelling organs; and they also assist in raising and depressing the animal through the water. The scales with which the bodies of all Fishes are covered, are frequently of a bony hardness, and sometimes form a firmly-jointed casing, in which the trunk is completely inclosed; this is especially the case, when the internal

skeleton is imperfectly developed; so that here we have an approach to the character of the Invertebrata.

27. The swimming-bladder, as it is commonly termed, of the Fish, is not an organ *sui generis*; but is ascertained, by comparison with the pulmonary sacs of the lower Reptiles, to be a rudimentary lung. It does not, however, give any assistance in the aeration of the blood, except in a few instances; but seems to be in general subservient to the elevation and depression of the body in its element. The heart of the Fish is extremely simple in its construction, containing two cavities only; and the course of the circulation is equally simple. The blood which returns from the body in a venous condition, is received into the single auricle or recipient cavity; and from this it passes into the ventricle or propellent cavity. The latter forces it into a large trunk, which subdivides into branches that are distributed to the branchial arches on each side; and in these it undergoes aeration. Being collected from the gills by returning vessels, the blood, now become arterial in its character, is transmitted to the large systemic trunk, the aorta, by which it is distributed through the system,—returning again to the heart, when it has passed through the organs and tissues of the body. Hence it is evident that the whole of the blood passes through the gills, before it goes a second time to the system; by which the imperfection of the aerating process itself is in some degree compensated. There is a special provision, too, for renewing by muscular power the stratum of water in contact with the gills; continual currents being sent over them from the pharynx, with which their cavity communicates. It is worth noticing, that whilst, in the Osseous Fishes, there is a single large external-gill opening on either side, with a valve-like operculum or gill-cover, there are, in the Cartilaginous Fishes, several slits on each side of the neck, one corresponding with each branchial arch. Similar apertures in the neck may be seen in the embryo of Man and of other Mammalia, as well as of Birds and Reptiles, at the time that the circulation is in the condition of that of the Fish,—the heart possessing only two cavities, and the blood being first propelled through a series of branchial arches.

8. *General characters of Reptiles.*

28. The class of REPTILES is oviparous and cold-blooded, like that of Fishes; but the animals belonging to it are formed to breathe air, and to inhabit the surface of the earth,—the few which are adapted to make the water their dwelling, being obliged to come to the surface to breathe. Although they breathe air, however, their respiration is not usually so energetic as that of Fishes, and their general activity is much less. The mechanism for the inflation of their lungs is very imperfect. Being destitute of a diaphragm, they are obliged to force air into the chest, by a process resembling deglutition or swallowing; so that, strange as it may seem, a Reptile may be suffocated by holding its mouth open. The heart possesses three cavities, one of which receives the blood from the lungs, and another from the general system; the arterial and the venous blood, contained in these two auricles respectively, are transmitted to the third or propelling cavity, the ventricle, where they are mixed; and the half-arterialised fluid is then transmitted to the system at large, a part being sent to the lungs. Thus only a portion of the blood expelled from the heart is exposed to the influence of the air; and that which is transmitted to the body is very imperfectly arterialised. In some of the higher Reptiles, as the Crocodile, the ventricle is double, as in the superior Vertebrata; and the course of the circulation is so arranged, that pure arterial blood shall go to the head, where it is most required, whilst a mixed fluid is sent to the rest of the body. This plan exactly corresponds

with the one, which is adopted in the circulation of the Human fœtus, from the time of the formation of the four cavities in its heart, and of the permanent system of vessels, up to the period of birth. The imperfect arterialisation of the blood in Reptiles, causes a great degree of general inertness in their functions. Their motions are principally confined to crawling and swimming; their general habits are sluggish, and their sensations are obtuse; and their nutritive functions are very slowly performed. Hence they can exist for a long time, with a very feeble exercise of these functions, under circumstances that would be fatal to animals, in which they are performed with greater activity. In cold and temperate climes, they pass the whole winter in a state of torpidity; and at other seasons, they may be kept during a long time from their due supplies of food and air, without appearing to suffer much inconvenience.

29. In regard to the structure of their skeleton, and the external form of the body, there is a considerable variation among the several orders of Reptiles. Thus, *Tortoises*, *Lizards*, and *Serpents*, differ from each other so widely, that a common observer would separate them completely; and yet they not only agree in all the foregoing characters, but pass into one another by links of transition so gradual, that it is even difficult to classify them. They differ, however, more in the configuration of the accessory parts, than in the structure of the essential portion of the skeleton,—the spinal column. This is characterised by the ball-and-socket articulation of the vertebræ, each vertebra having one surface convex and the other concave,—a structure which is more strongly marked in *Serpents*, whose movements are performed chiefly by the flexion of the spinal column itself, than it is in the other tribes. The chief characteristic of the *Tortoise* tribe, is the *shell* or case in which the body is contained. The upper arch of this shell, termed the carapace, is formed by a bony expansion from the edges of the ribs, which is covered by a set of horny plates, that are to be regarded (like smaller scales) as epidermic appendages. The under portion, termed the plastron, is composed of the sternum, which is in like manner extended laterally. In the Land-tortoises, this usually forms a complete floor; but in the aquatic species, a part is commonly absent, the interval being filled up by cartilage and membrane. The skeleton of the *Lizards* is formed more upon the general plan of that of *Mammalia*, but may be readily distinguished from it. The sternum is usually prolonged over the front of the abdomen, and the ribs are continued through a much larger part of the spinal column; of these abdominal ribs, the white lines across the recti muscles in the higher Vertebrata, are evidently the rudiments. In the higher *Lizards*, the power of locomotion is almost entirely delegated to the extremities; but in the less typical species, the body and tail are much prolonged, so as to present a serpentiform aspect; and first one pair of feet, and then the other, disappear, until the form is altogether that of the *Serpent*. Even in *Serpents*, however, rudiments of extremities are frequently to be found; but their mode of progression is very different, and these rudiments are of no assistance to them. The most remarkable feature in the *Serpent's* skeleton, besides the absence of legs, and the large number of ribs and vertebræ, is the deficiency of a sternum; through the absence of this, the extremities of the ribs are free, and they become in fact the fixed points, on which the animal crawls, when advancing slowly forwards, in a manner which bears a strong resemblance to the progression of the Centipede.

30. Although the configuration of the cranium varies much in the different orders of Reptiles, yet there is a remarkable agreement in certain general characters, and in the general *degree* of development. It consists of a much larger number of parts, than are to be found in the cranium of adult *Birds* or *Mammalia*; each principal bone being subdivided, as it were, into smaller ones.

This condition exactly corresponds with that, which may be observed during the process of ossification in higher Vertebrata; for each of the larger bones of the cranium is formed from several centres of ossification; so that, if the cranium of a fœtus or young infant be macerated, it will fall into a number of pieces nearly corresponding with those of the Reptile's skull. The different orders of Reptiles have a close agreement in various other points; especially in the degree of development of their several organs of nutrition. Thus, in all of them, the lungs, though commonly of large size, are so little subdivided, as really to expose but a small extent of surface. The glandular structures, too, are formed upon a much more simple type, than is characteristic of the warm-blooded Vertebrata. They all agree, moreover, in having the body covered with scales; which, though generally small, are sometimes large flattened plates.

31. Between Fishes and true Reptiles, there is a group that remarkably combines the characters of both; being composed of animals which come forth from the egg in the condition of Fishes, but which afterwards attain a form and structure closely corresponding with that of true Reptiles. This group, consisting of the Frog and its allies, is sometimes associated as an order (*Batrachia*) of the class of Reptiles; though it should probably take rank as a distinct class, the AMPHIBIA. The Tadpole or larva of the Frog is in every essential respect a Fish. Its respiration and circulation, its digestion and nutrition, its locomotion and sensation, are entirely accordant with those of Fishes. The body is destitute of members for progression, but is propelled through the water by the lateral undulations of the spinal column, which is articulated in the same manner as that of Fishes. At a certain period, a metamorphosis commences in which almost every organ in the body undergoes an essential change. Lungs are developed, which take the place (in regard to their function) of the gills; and the latter are atrophied. The auricle of the heart is divided into two; and the circulation is performed on the plan of that of the true Reptile. Two pairs of members are usually formed, to which, when they are fully developed, the power of progression is committed,—the tail disappearing; in some species, however, the tail remains, and the extremities are small. The digestive system undergoes a remarkable alteration; the intestinal canal, which was previously of enormous length in proportion to the body, being now considerably shortened, in accordance with the different kind of food on which the animal has to subsist. The mode of articulation of the spinal column also, undergoes a change, which brings it to the type of that of Reptiles. The most obvious point of difference in external characters, between the higher Amphibia and true Reptiles, is the absence of scales or plates on the skin of the former. In this manner, the common *Salamander* or Water-Newt may be recognised as belonging to the *Batrachia* though its form would otherwise lead us to place it among the Lizards; and the *Cæcilia*, which has the form of the Serpent, is in like manner known to be really allied to the Frog. An acquaintance with the history of these animals confirms such an arrangement, by showing that the Salamander and the *Cæcilia* undergo a metamorphosis; breathing by gills, and having the general structure of Fishes, in the early part of their lives.

32. Besides those animals, however, which attain the condition of perfect Reptiles, this group contains several, whose development is arrested, as it were, in an intermediate or transition state; their adult form presenting a remarkable mixture of the characters of the two classes, which they thus connect. This is the case in the *Proteus*, *Siren*, and other less known species, which retain their gills through the whole of their lives, whilst their lungs are at the same time developed; so that, as they can respire in either air or water, they are the only true *amphibious* animals. In their general organization,

they correspond with the Tadpole of the Frog at an advanced period of its metamorphosis ; and it is a most interesting fact (which has been established by the experiments of Dr. W. F. Edwards) that, if Tadpoles be kept in such a manner, as to be amply supplied with food, and exposed to a constantly-renewed current of water, but be secluded from light and from the direct influence of the solar heat, they will continue to grow as Tadpoles ; their metamorphosis being checked. The metamorphosis of the Batrachia closely corresponds with that of Insects ; the young animal, in each case, at the time of its emersion from the egg, having a resemblance, in all essential particulars, to a class below that to which it is ultimately to belong. This kind of metamorphosis is by no means confined to them, however ; for the gradual extension of our knowledge of the early history of the different tribes of animals, is constantly bringing to light new facts of the same kind. The Polypes and lower Mollusca, for instance, come forth from the egg, and swim about for some time, in a condition which can scarcely be termed *animal* ; for there is not even a mouth leading to a digestive cavity ; nor are there any other organs of locomotion than the cilia, the action of which is involuntary. And, in tracing the development of the Human embryo, we shall find that it undergoes a series of progressive changes equally remarkable ;—the principal difference being, that these changes are not so arranged in harmony with each other, as to cause the embryo to present, at any one time, the *combination* of characters which belong to the Fish, Reptile, &c., or to enable it to sustain an independent existence.

9. *General characters of Birds.*

33. From Reptiles to BIRDS, the transition would seem rather abrupt ; since the latter class is, in almost every respect, the opposite of the former. Nevertheless, it would seem to have been effected by the now-extinct *Pterodactylus*, which combined, in a most remarkable degree, the characters of the two groups. Birds are, like Fishes and Reptiles, *oviparous* Vertebrata ; but they differ essentially from both, in being warm-blooded, and in affording assistance by their own heat in the development of the ovum. Birds correspond with Mammalia, in possessing a heart with four cavities, and a complete double circulation ; by which the whole of the blood that has circulated through the body, is exposed to the influence of the air before being again transmitted to the system. This high amount of oxygenation of the blood is accompanied by great activity and energy of all the organic functions, acuteness of the senses, and rapid and powerful locomotion ; as well as by the evolution of a degree of heat, superior to that which we ordinarily meet with among the Mammalia. The temperature of Birds ranges from about 104° to 112°. The lowest is in the aquatic species, whose general activity is much less than that of the tribes which spend most of their time in the air ; the highest is among those distinguished for the rapidity and energy of their flight, such as the Swallow.

34. Birds have been denominated, and not inappropriately, the Insects of the Vertebrated series ; as in the animals of that class, we find the whole structure peculiarly adapted to motion, not in water, nor upon solid ground, but in the elastic and yielding air. It is impossible to conceive any more beautiful series of adaptations of structure to conditions of existence, than that which is exhibited in the conformation of the Bird, with reference to its intended mode of life. In order to adapt the Vertebrated animal to its aerial residence, its body must be rendered of as low specific gravity as possible. It is further necessary that the surface should be capable of being greatly extended ; and this by some kind of appendage that should be extremely light,

and at the same time possessed of considerable resistance. The degree of muscular power required for support and propulsion in the air, involves the necessity of a very high amount of respiration (§ 275), for which it has been seen that an express provision exists in Insects; and as the general activity of the vital processes depends greatly upon the high temperature, which this energetic respiration keeps up, a provision is required for keeping in this heat, and not allowing it to be carried away by the atmosphere, through which the Bird is rapidly flying.

35. The first and third of these objects,—the lightening of the body, and the extension of the respiratory surface,—are beautifully fulfilled in a mode, which will be found to correspond with the plan adopted for the same purpose in Insects. The air which enters the body, is not restricted to a single pair of air-sacs or lungs placed near the throat; but is transmitted from the true lungs, to a series of large air-cells, disposed in the abdomen and in various other parts of the body. Even the interior of the bones is made subservient to the same purpose; being hollow, and lined with a delicate membrane, over which the blood-vessels are minutely distributed. In this manner, the respiratory surface is greatly extended; whilst, by the large quantity of air introduced into the mass, its specific gravity is diminished. The subservience of the cavities in the bones to the respiratory function, is curiously shown by the fact, which has been ascertained both accidentally and by a designed experiment, that, if the trachea of a Bird be tied, and an aperture be made in one of the long bones, it will respire through this.

36. The other two objects,—the extension of the surface, and the retention of the heat within the body,—are also accomplished in combination, by a most beautiful and refined contrivance, the covering of feathers. Like hair or scales, feathers are to be regarded as appendages to the cutis; the stem is formed from it by an apparatus, which may be likened to a hair-bulb on a very large scale; but there are some additional parts for the production of the laminae, which form the vane of the feather, and which are joined to the stem during its development. These laminae, when perfectly formed, are connected by minute barbs at their edges, which hook into one another, and thus give the necessary means of resistance to the air. The substance of which feathers consists, is a very bad conductor of heat; and when they are lying one over the other, small quantities of air are included, which still further obstruct its transmission by their non-conducting power. Thus the two chief objects are fulfilled;—power of resistance and slow-conducting properties being obtained, in combination with lightness and elasticity. At the two extremes of the class, however, we meet with remarkable modifications in the typical structure of feathers. In the Penguin, those which cover the surface of the wings have a strong resemblance to scales; and the wings are not employed to raise this Bird in the air, but only to propel it through water (as fins would do) by their action on the liquid. On the other hand, in the Ostrich tribe, the laminae of the feathers are separated from each other, so as no longer to form a continuous surface; the feathers more resembling branching hairs. Here the wings are almost or completely absent; the birds of this tribe being constantly upon the ground, propelling themselves by running, and approaching the Mammalia in many points of their conformation.

37. The bony frame-work of Birds presents many remarkable adaptations to the same purposes. In the first place it is to be remarked, that the faculty of locomotion is here entirely delegated to the extremities; and that the skeleton of the trunk must be consolidated, in proportion to the power with which they are to be endowed, in order to afford their muscles a firm attachment (§ 22). Just as the segments of the external skeleton of the Articulata, therefore, are consolidated in Insects, do we find that the vertebral column

and its appendages are firmly knit together, in the upper part of the trunk of Birds. The vertebræ are closely united to each other; and the ribs are connected with the sternum by bony prolongations of the latter, instead of by cartilages. This union is so arranged, that the state of expansion is natural to the thorax, whilst that of contraction is forced. The diaphragm is absent among birds, as among Reptiles; except in a few species, which most nearly approach the Mammalia. But its deficiency is compensated by this contrivance, which keeps the lungs and air-sacs always full,—except when the Bird by a muscular effort, expels the air from them, in order that they may be re-filled by a fresh supply. By this means, also, the specific gravity of the body is more constantly kept down, than it could have been, if the lungs had been subjected to the constantly-alternating contractions and expansions, which they perform in Mammalia. It is worthy of remark, that the air which enters the bones and the air-sacs, passes through the lungs, both on its entrance and return; so as to yield to their capillaries all the oxygen which they can take from it, and of which the blood that it has elsewhere met with has not deprived it. It is only in the lungs, that it meets with purely venous blood; for they alone receive the branches of the pulmonary artery; the vessels which are distributed upon the respiratory surface of the air-sacs and bones, being a part of the systematic circulating apparatus. Hence we may regard this curious provision, as being partly designed for the aeration of the blood in its course through the system (this, it will be remembered, being the sole mode in which the function is performed in Insects), and partly for supplying the lungs with air, as from a reservoir, during the violent actions of flight.

38. The articulation of the anterior extremity with the trunk exhibits a peculiar provision for strength and power, which we find in no other Vertebrata. The two clavicles are united together on the central line, forming the *furcula* or merry-thought; and the use of this is to keep the shoulders apart, notwithstanding the opposing force exerted by the pectoral muscles in the action of flight. It is generally firm, and its angle open, in proportion to the power of the wings. Besides this bone, there is another connecting the sternum with the scapula on each side; this is the *coracoid* bone, which in Man and most other Mammalia is scarcely developed, being merely a short process which does not reach the sternum. The sternum of Birds usually exhibits a very remarkable development on the median line; an elevated keel or ridge being seen on it, which serves for the attachment of the powerful muscles that depress the wings. In the great development of the sternum, Birds have some analogy with the Turtle tribe: which they also resemble in the deficiency of teeth, and in the development of a horny covering to the jaws: but in these, the *lateral* elements of the sternum are the parts most developed; whilst in Birds it is the *central* portion which exhibits the peculiarity. From the depth of the keel of the sternum, a judgment may be formed of the thickness of the pectoral muscles, and thence of the powers of flight; in the Ostrich tribe, where the wings are not sufficiently developed to raise the bird off the ground, the sternum is quite flat, as in the Mammalia. The want of flexibility in the trunk is counterbalanced by the length and flexibility of the neck; the number of cervical vertebræ is very considerable, varying from 12 to 23,—the highest number being present in the Swan tribe. They are so articulated that the head can be turned completely round, or moved in any direction. The anterior extremities of Birds being solely adapted to sustain them in flight, the posterior are necessarily modified for their support on the ground. They are usually placed rather far back; but the spine has a position more inclined than horizontal, so that the weight may not be altogether thrown forwards. The trunk is supported on the thighs by powerful muscles; and there is another series, which passes from the lower part of the spine

continuously to the toes, turning over the knee and heel, in such a manner that the flexion of these joints shall tighten the tendons ; by this contrivance, the simple weight of the body flexes the toes ; and Birds are thus enabled to maintain their position, by grasping their perch, during sleep, without any active muscular effort.

39. Not only do Birds resemble Insects in their general structure and mode of life, but also in the peculiar development of the *instinctive* powers. Under the direction of these, the place for their nests appears to be selected ; their materials collected ; the nest themselves built, and the young reared in them ; the migrations are performed ; and many curious stratagems are employed to obtain food. It is sufficient to indicate these in general terms ; since it is well known that the habits of Birds have peculiarities restricted to each species ; and that in all the individuals of each species ; they are as precisely alike as their circumstances will admit. Nevertheless, there are observed in Birds a degree and kind of adaptation to varying conditions, which Insects do not possess, and which display an amount of *intelligence* far superior to what is found in that class (§ 17). This is evinced also in their *educability* ; for no animal can be taught to perform actions which are not natural to it, unless it possesses in a considerable degree the powers of memory and association, at least, if not some of the higher mental faculties, such as the power of perceiving and comparing the relations of ideas. Moreover, in the *domesticability* of many tribes of Birds, we see this educability combined with a degree of that higher form of attachment to Man, which is so strikingly exhibited by certain species of Mammalia. The development of the senses of Birds varies in different tribes, according to the mode in which they are adapted to obtain their prey. The sight is almost always extremely acute, and is their chief means of seeking food ; and where this would be of comparatively little service, as in the nocturnal rapacious birds, it is compensated by a much higher development of the faculty of hearing, than is common amongst other tribes. The senses of smell, taste, and touch, do not seem to be usually very acute in Birds ; but there are particular tribes, in which each of these is more developed than in the rest.

40. As might be expected from the analogy of Birds with Insects, the development of their organs of nutrition (excepting that of the respiratory organs) is much less striking than is that of the locomotive apparatus. The whole cavity of the trunk, especially in Birds distinguished for their powers of flight, is small in comparison with that of the body ; but what is wanting in the size of the organs, is made up in their energy of function. Hence the demand for food is more active in them than in any other class of animals. It is interesting to observe, that there is more bi-lateral symmetry in the arrangement of the viscera, than we usually find in the class above. This is evidently connected with their active locomotive powers ; as it is obviously necessary, that the two sides of the body should be balanced with perfect equality, and that their energy should be exactly correspondent. The lungs and air-sacs are precisely similar in size and situation on the two sides ; consequently the heart is placed on the median line ; and the mode of origin, from the aorta, of the trunks supplying the head and upper extremities, is alike on the two sides. The liver, also, is less asymmetrical than we usually find it in the Mammalia.

41. It has been remarked, that the assistance afforded by the parent, in the development of the young, is greater in Birds than in the lower Vertebrata ; but is less than in Mammalia. Whilst Reptiles and Fishes show little or no concern for their eggs after they have deposited them, Birds sedulously tend them, affording them not only protection but warmth, by means of their powerful heat-producing apparatus. The yolk-bag of the Bird's egg is so

suspended in the midst of the white albumen, that, when the egg is laid upon its side, it will always rise to the highest part of it; and the relative weight of the several parts is further adjusted in such a manner, that the *cicatricula* or germ-spot shall always be at the point nearest the shell, so as to come into the closest proximity with the source of heat, and also to be in the most immediate relation with the surrounding air. There are some Birds, inhabiting the equatorial region, which do not always incubate their eggs, trusting to the solar heat for their maturation. It is said that the Ostriches of the intertropical deserts are content with covering their eggs with a thin layer of sand, so as to admit the action of the sun by day, and to keep them warm at night; but that those living under a less constantly elevated temperature, sit upon their eggs—if not constantly, at any rate when the solar heat is not sufficient. This statement has been disputed; but its truth seems to be confirmed by a curious observation made by Mr. Knight, that a Fly-catcher, which built for several years in one of his hot-houses, sat upon its eggs when the temperature was below 72°, but left them when it rose above that standard. Certain Birds inhabiting New Holland, deposit their eggs in a sort of hot-bed, composed of decaying vegetable matter; a number associating together for the construction of this artificial incubating apparatus, although they live separately at other times. The degree of assistance afforded by the parent Birds to their young, after their emersion from the shell, varies much in different tribes; in general it may be remarked, however, that it is most prolonged in those which ultimately attain the highest development, and especially in those whose intelligence becomes the greatest. Thus the Chicken and the Duckling, when just hatched, are able to shift for themselves; but among the Raptorial and Insesorial Birds, which rank far higher in the scale, the young is for a long time dependent upon the parent for food; and in the Parrot tribe, which unquestionably surpasses all others in intelligence, the parent not only supplies its young with food which it has obtained for them, but partly nourishes them by a milky secretion from the interior of the craw; impregnating with this the aliment which it swallows, and which it afterwards disgorges for its offspring.

10. *General characters of Mammalia.*

42. The MAMMALIA are universally regarded as the highest group in the Animal kingdom; not only from being that to which Man belongs (so far, at least, as his bodily structure is concerned), but also as possessing the most complex organization, adapted to perform the greatest number and variety of actions, and to execute these with the greatest intelligence. The contrast is here extremely strong between the *reasoning* and the *instinctive* powers; even when we put Man out of view. When we compare, for example, the sagacity of a Dog, Monkey, or Elephant, and the great variety of circumstances in which they will display an intelligent adaptation of means to ends, with the limited operations of Insects, over which the judgment and will seem to have no control, we cannot help being struck with the difference. The former are *educable* in the highest degree next to Man; the latter could not be made to change their habits, in any essential degree, by the most prolonged course of discipline. Man is actuated, like the lower animals, by instinctive propensities, which have an immediate bearing on his corporeal wants; whilst they have, like him, the power of adapting their actions to gain certain ends, of which they are conscious. A Dog or an Elephant may show more real wisdom, in controlling for a time its instinctive propensities, from the desire to accomplish some particular object, than is displayed by many Men, who give free scope to the exercise of their sensual passions, although warned by their reason of the injurious consequences of such indulgence.

43. This high development of the intelligence in Mammalia, is evidently connected with the greatly-prolonged connection between the parent and the offspring, which we find to be a characteristic of this class. Mammalia are, like Birds, warm-blooded Vertebrata, possessing a complete double circulation; and some of them are adapted to lead the life of Birds, passing a large part of their time in darting through the air on wings, in pursuit of Insect prey. But they differ from Birds in this essential particular, that they are not oviparous, but viviparous; producing their young *alive*,—that is, in a condition in which they can perform spontaneous movements, and can appropriate nourishment supplied to them from without. But they are not distinguished from all other animals by this character alone; for there are some species among Reptiles, Fishes, and even Insects, which produce their young alive,—the egg being retained within the oviduct and hatched there. The real distinction lies partly in that, which the name of the class imports,—the subsequent nourishment of the young by suckling; and partly in the mode in which the embryo is nourished before its birth. In Mammals, the yolk-bag is very small in proportion to its size in Birds; and the contents of the ovum, instead of furnishing (as in that class) the materials necessary for the development of the young animal, up to the time when it can ingest food for itself, only serve for the earliest set of changes in which this process consists. In the latter stages of the evolution of the embryo, it is supplied with nutriment directly imbibed from its parent. This is at first accomplished by means of a series of root-like tufts, which are prolonged from the surface of the ovum, and insinuate themselves among the maternal vessels, without, however, uniting with them. These tufts absorb, from the maternal fluid, the ingredients necessary for the support of the embryo; and also convey back to the parent its effete particles, which are received back into her blood, and are then cast out of her system, by the process of secretion, respiration, &c.

44. The Mammalia may be divided into two sub-classes; in one of which the structure just described is the greatest advance ever made, in the apparatus by which the fœtus is nourished; whilst in the other a more concentrated form is subsequently assumed by it. The ovum of the latter is delayed for a longer period, in a cavity formed by the union of the two oviducts, termed the *uterus*; which can be scarcely said to be developed in the Marsupialia and Monotremata, the two orders constituting the first sub-class. The vascular tufts proceeding from the chorion become especially developed at one point, and the vessels of the uterus are extremely enlarged in a corresponding situation; the tufts dip down, as it were, into a chamber formed by an extension of the inner lining of these vessels, and serve the combined purpose of the roots of plants and of the branchiæ of aquatic animals,—absorbing from the maternal blood the materials required for the nourishment of the embryo, and aerating the blood of the fœtus, by exposing it to the influence of that of the parent. The peculiar organ thus formed is termed the *placenta*; and the two sub-classes of the Mammalia have thence received the appellations of *placental* and *non-placental*. The animals belonging to the latter present many points of affinity to Birds, in the structure of their internal organs. That of the brain is very nearly allied in these two groups; and their amount of intelligence seems, as far as can be determined, to bear a close correspondence. The *Ornithorhyncus* in particular, has so many marks of alliance to oviparous animals, and its osteology, as well as in its horny bill and in less important particulars, that Naturalists have much debated whether it could really be termed a Mammiferous animal. No *positive* evidence has yet been obtained that its young are born alive; but on the other hand, there is a strong reason to believe that they come into the world uninclosed in the ovum, al-

though in a very imperfect condition. Moreover, it has been satisfactorily ascertained that the young are nourished, for some time after their birth, by a mammary secretion, which the organization of their mouth at that period enables them to obtain from the parent. In the Marsupialia, there is a remarkable compensation for the abrupt termination of the period of uterine gestation,—the young being received into a pouch or marsupium, within which the nipple is situated; this is extremely prolonged, and the mouth of the fœtus (for so the being must still be regarded) is adapted to receive and hold on by it; so that the little creature, which looks at first more like an earth-worm than a Mammiferous animal, is thus suspended within the protective pouch, until its development is so far advanced, that it can shift for itself in the same degree as other new-born animals can do.

45. The period of gestation in the higher sub-class of Mammalia, is usually prolonged, until the fœtus is able, on its entrance into the world, to execute regular movements; some of these being merely indicative of its desire for food, and others evidently designed for the acquirement of it. In many species, the young animal seems to be from the first in the full possession of its senses, and has considerable power of active locomotion; in general, however, it is very dependent upon its parent; only being able to obtain food when this is placed within its immediate grasp. Such is the case with the Human infant, which is closely dependent upon its parent, during a larger proportion of its existence, than is the young of any other animal. Here again, therefore, we perceive the application of the general law, that, the higher the grade of development a being is ultimately to assume, the more does it require to be assisted during the early stages of its progress. In the case of Man, the prolongation of this period has a most important and evident influence upon the social condition of the race; being, in fact, one of the chief means, by which the solitary are bound together in families.

46. The class Mammalia, taken as a whole, is not characterized so much by the possession of any one particular faculty,—like that which has been seen in Birds,—as by the perfect combination of the different powers, which renders the animals belonging to it susceptible of a much greater variety of actions, than any others can perform. There are none that can compete with Birds in acuteness of sight; but there are few that do not possess the senses of smell, taste, and touch in a more elevated degree. There are none which can rival Birds in rapidity of locomotion; but there are few which cannot perform several kinds of progression. Several of their movements require a considerable amount of flexibility in the spine; hence the vertebral column, and the bony framework of the trunk, are never so much consolidated as they are in Birds. On the other hand, the neck is much less movable; it never consists of more than seven vertebræ, and these are always present; so that they are sometimes of great length, as in the Giraffe, and sometimes extremely short, as in the Whale, which seems to have no neck at all. In the greatest number of Mammalia, the body is supported upon all the four extremities, as in Reptiles; being adapted for progression along the surface of the earth. There are some species, however, in which the typical structure has undergone a metamorphosis, by which it is made to resemble that of a Bird; whilst in others it is modified, so as to conform to the character of the Fish. In the Bats, the power of motion is almost entirely delegated to the wings, which are composed of skin, stretched over a bony framework formed of the widely-extended hand; and the sternum has a projecting keel for the attachment of the pectoral muscles, as in Birds. And in the Whale tribe, the power of locomotion is almost completely taken from the extremities, and given back to the trunk, as in Fishes; for the posterior extremities are entirely absent, and the anterior serve only for guidance: there is this important differ-

ence, however, that the tail, which is flattened vertically in Fishes, is flattened horizontally in the Cetacea, which require the power of frequently coming to the surface to breathe.

47. The inferior energy of muscular movement in the Mammalia, is accompanied by an inferior amount of respiration; the type of the respiratory apparatus, however, is higher than in Birds, a large extent of surface being comprised within a smaller space. The lungs are confined to the cavity of the thorax; and there is a provision for the regular renewal of the air received into them, by the action of the diaphragm, which here completely separates that cavity from the abdomen. The diminished amount of respiration, again, involves the production of a lower degree of animal heat; so that the temperature of this class seldom rises above 104° . There is, therefore, less need of means for effectually confining the caloric,—especially, too, as their greater average size causes their radiating surface to be much less, in proportion to their bulk, than is that of Birds; and accordingly, we find them provided only with a covering of hair or fur, which is much less warm than that of feathers, and which is thin and scanty in Mammals inhabiting tropical climates. The chief exception to the last rule is in the case of the Sloths and of some Monkeys, which inhabit situations exposed to the most powerful rays of the sun, and which are covered with a long but thin and coarse hair; the purpose of this is evidently the protection of their skin from the external heat. The inferior energy of the respiration and circulation, involves a diminished activity of the other functions of nutrition, as compared with those of Birds; and the demand for food appears to be somewhat less constant. Their various organs, however, are developed upon a higher plan; as we have already observed in regard to those of respiration.

11. Chief Sub-divisions of Mammalia.

48. In sub-dividing the truly Viviparous division of the class, so as to separate Man from the tribes with which he is associated in it, we may be advantageously guided, in the first place, by the conformation of the extremities; since upon the perfection of the organs of touch, will depend much of the address of an animal in executing the actions to which it is prompted by its intelligence. The degree of this perfection is estimated by the number and mobility of the fingers, and by the degree in which their extremities are enveloped by the nail, claw, or hoof, that terminates them. When the fingers are partly absent, or are consolidated together, and a hoof envelopes all that portion which touches the ground, it is obvious that the sensibility must be blunted, whilst, at the same time, the member becomes incapacitated for prehension. The opposite extreme is where (as in Man) a thin nail covers only one side of the extremity of the finger, leaving the other possessed of all its delicacy;—where several such fingers exist, of which one can be opposed to the rest, so as to render prehension more perfect, and to perform a great variety of actions:—and where the plane of the whole hand can be turned in any position, by the nature of its attachment to the fore-arm. Between these there are many intermediate gradations. By these characters, the viviparous Mammalia may be divided into the *Unguiculated*, which have separate fingers, terminated by distinct nails or claws; and the *Ungulated*, in which the fingers are more or less consolidated, and inclosed at their extremity in a hard hoof. Hoofed animals are necessarily Herbivorous, inasmuch as the conformation of their feet precludes the possibility of their seizing a living prey; and they have flat-crowned grinding teeth for triturating their food. The summits of these teeth are usually not covered by a smooth coat of enamel, but present a series of elevations and depressions; these are occasioned by

the peculiar structure of the teeth, which consist of alternating plates of enamel, ivory or dentine, and cementum or *crusta petrosa*,—substances of three different degrees of hardness ; and, as the softer portions will of course wear down first, the harder remain as projecting ridges. In order to give effect to these, there is usually a considerable power of lateral motion possessed by the lower jaw ; so that a regular grinding action may be performed, which is favourable to the complete reduction of the tough vegetable substances that serve as their food.

49. Animals with Unguiculated fingers are capable of more variety in the character of their food. In some it is almost exclusively vegetable, as in the *Rodentia* ; and here the power of prehension possessed by the extremities is small, the fore-arm not being so constructed as to be capable of the motions of pronation and supination. In this order, the mouth is remarkably adapted for grinding down hard vegetable substances ; the molar teeth being furnished with transverse ridges of enamel ; and the jaws having a powerful movement backwards and forwards.* In other orders, again, there is an almost exclusive adaptation to animal food. The toes are furnished with long and sharp claws ; and the fore-feet may be placed in a variety of positions, by the rotation of the two bones composing the lower part of the leg. The grinding teeth are very narrow, and are formed with sharp points and edges, so as to be adapted for dividing animal flesh ; these are firmly set in short strong jaws, which are fitted together like the blades of a pair of scissors, having no action but a vertical one ; and the constant friction of the edges of the molar teeth against each other, keeps them sharp.† In the *Carnivorous* group, too, we find the greatest development of the canine teeth, which are commonly absent or but slightly developed among herbivorous quadrupeds ; these are instruments of great power, serving both for the first attack of their prey, and for subsequently tearing it in pieces. It is evident that the whole structure of the body must undergo modification, in conformity with the nature of the food. The simple stomach and intestinal canal of the *Carnivorous* animal, adapted only to the digestion of aliment consisting of materials similar to those of its own body, would be totally useless to an animal prevented by its general organization from obtaining any other than vegetable food ; and, on the other hand, the teeth and hoofs of the *Herbivorous* quadruped would be of little assistance to an animal, whose instincts and general conformation adapted it for the pursuit of animal prey. It will be presently seen that, in regard to his organization, Man holds an intermediate place between the purely *Herbivorous* and the purely *Carnivorous* tribes ; being capable of subsisting exclusively upon either kind of diet, but being obviously intended by Nature to employ both in combination.

50. The classification of the *Mammalia* by Linnæus, although not strictly natural, affords us the readiest means of separating Man, zoologically, from all other animals. He arranged under his order *Primates*, all the unguiculated *Mammalia* which have four incisor teeth and two canines in each jaw ; and thus Man, with the *Monkeys* and the *Bats*, was distinguished from the re-

* The action of trituration is chiefly performed by the external pteregoid muscles. When these are in operation together, they draw the whole of the lower jaw forwards, so as to make the lower teeth project beyond the upper ; and the jaw being drawn back again by the digastric muscles, a rapid alternate movement may be thus effected, such as is seen in the *Rodentia*. When only the muscle of one side acts, the condyle of that side is thrown forwards ; and by the alternating operation of the two, aided by other muscles, that rotatory motion is given which we see especially in *Ruminating Quadrupeds*.

† In *Carnivorous* animals, the muscles which elevate the lower jaw attain a very high degree of development. This is very remarkably seen in the internal pteregoid, which in Man is of subordinate size and importance, but which is a very powerful muscle in the *Lion*, *Tiger*, &c.

mainder of those Quadrupeds which have separate fingers with distinct nails or claws. This group is now sub-divided into three orders, corresponding with the Linnæan genera, *Homo*, *Simia*, and *Vespertilio*. The last of these orders, named *Cheiroptera*, consists of the Bat tribe, which is easily separated from all others by the peculiar conformation of the anterior extremities, from which its name is derived. The second, termed *Quadrumana*, comprehends the Apes, Monkeys, and Baboons, which exhibit a regular series; the highest approaching Man in general conformation; and the lowest having much more of the general organization of the inferior carnivorous quadrupeds. They are distinguished from other viviparous Mammalia, by possessing an opposable thumb on all four extremities (whence they are termed four-handed),—a character which is only found elsewhere in the Opossums. Although some of the higher members of this group are capable of maintaining the erect position without difficulty for some time, even whilst walking, it is certainly not that which is natural to them. The posterior extremity,—being formed on the plan of a hand, for prehension rather than for direct support,—is destitute of the *heel*, which is characteristic of Man; and although Apes can climb trees with facility, they cannot plant the foot firmly on the ground, so as to resist attempts to overthrow them; since the foot rests rather upon the outer side than upon its sole, and the narrowness of the pelvis is unfavourable to an equilibrium. There are many points of striking resemblance to Man, however, in the details of the conformation of the Quadrumana, especially among the most elevated species; the order being distinguished by the same characters from most others. The structure of their alimentary canal differs extremely little from his. The eyes are directed forwards, when the trunk is erect; and the orbit is completely separated from the temporal fossæ, by a bony partition. The mammæ are situated on the thorax; and the penis is pendent. The coitus, however, is reverse, as in the lower Mammalia. The form of the brain in the higher species corresponds with that of Man in this remarkable character,—that it is divided into three lobes, of which the posterior is prolonged backwards so as to cover the cerebellum; this is not the case in the highest of the other Mammalia.

12. Characteristics of Man.

51. We shall now review, somewhat in detail, the distinctive characters that separate Man from those animals which present the nearest approach to him in general structure and aspect. These may be advantageously classified according to their obvious purposes; and the first series we shall notice consists of those by which Man is peculiarly adapted to the erect attitude. On examining his cranium we remark that the condyles, by which it is articulated with the spinal column, are so placed that a perpendicular dropped from the centre of gravity of the head would nearly fall between them, so as to be within the base on which it rests. The foramen magnum is not placed in the centre of the base of the skull, but just behind it; in order to compensate for the greater specific gravity of the posterior part of the head, which is entirely filled with solid matter, whilst the anterior part contains many cavities. There is, indeed, a little over-compensation, which gives a slight preponderance to the front of the head; so that it drops forwards and downwards when all the muscles are relaxed. But the muscles which are attached to the back of the head are far larger and more numerous than those in front of the condyles; so that they are evidently intended to counteract this disposition; and we find, accordingly, that we can keep up the head for the whole day, with so slight and involuntary an effort that no fatigue is produced by it. Moreover, the surfaces of the condyles have a horizontal direction when the head is

upright; and thus the weight of the skull is laid vertically by them upon the top of the vertebral column. If these arrangements be compared with the position and direction of the occipital condyles in other Mammalia, it will be found that these are placed in the latter much nearer to the back of the head, and that their plane is more oblique. Thus, whilst the foramen magnum is situated, in Man, just behind the centre of the base of the skull, it is found in the Chimpanzee and Orang Outan to occupy the middle of the posterior third; and, as we descend through the scale of Mammalia, we observe that it gradually approaches the *back* of the skull, and at last comes nearly into the line of its longest diameter, as we see in the Horse. The obliquity of the condyles differs in a similar degree. In all Mammalia except Man their plane is oblique; so that, even if the head were equally balanced upon them, the force of gravity would tend to carry it forwards and downwards. In Man, the angle which they make with the horizontal is very small; in the Orang Outan it is as much as 37° ; and in the Horse their plane is vertical, making the angle 90° . If, therefore, the natural posture of Man were horizontal, he would in this respect be circumstanced like the Horse; for the plane of his condyles, which is nearly horizontal in the erect position, would then be vertical: and the head, instead of being nearly balanced in the erect position, would hang at the end of the neck, so that its whole weight would have to be supported by some external and constantly-acting power. But for this there is neither in the skeleton, nor in the muscular system of Man, any adequate provision. In other Mammalia the head is maintained in such a position by a strong and thick ligament (the ligamentum nuchæ), which passes from the spines of the cervical and dorsal vertebræ to the most prominent part of the occiput; but of this there is scarcely any

Fig. 5.

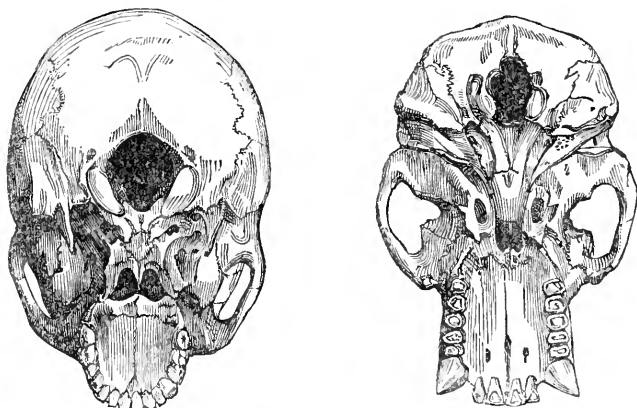

View of the base of skull of Man, compared with that of the Orang Outan.

trace in Man. In the horizontal position, therefore, he would have the heaviest head, with the least power of supporting it.

52. The position of the face immediately beneath the brain, so that its front is nearly in the same plane as the forehead, is peculiarly characteristic of Man; for the crania of the Chimpanzee and Orang, which approach nearest to that of Man, are entirely posterior to, and not above, the face. It should be remarked that in the *young* Ape there is a much greater resemblance to Man in this respect than there is in the adult. For at the time of the second dentition the muzzle of the Ape undergoes a great elongation, so

that it projects much more beyond the forehead; this is seen in Fig. 5. The whole cast of the features is altered at the same time, so that it approaches much more to that of the lower *Quadrumana* than would be supposed from observation of the young animal only.* This increased projection of the muzzle is an evidence of want of perfect adaptation to the erect posture: whilst the absence of it in Man shows that no other position is natural to him. Supposing that, with a head formed as at present, he were to move on all fours, so that his face would be brought into a plane parallel with the ground,—as painful an effort would be required to examine with the eyes an object placed in front of the body, as is now necessary to keep the eyes fixed on the zenith; the nose would be unable to perceive any other odours than those which proceeded from the earth or from the body itself; and the mouth could not touch the ground without bringing the forehead and chin also into contact with it. The oblique position of the condyles in the *Quadrumana* enables them, without much difficulty, to adapt the inclination of their heads to the horizontal or to the erect position of the body; but the natural position, in the highest among them, is unquestionably one in which the spinal column is inclined, the body being partially thrown forwards, so as to rest upon the anterior extremities; and in this position the face is directed forwards without any effort, owing to the mode in which the head is articulated with the spine.

53. The vertebral column in Man, though not absolutely straight, has its curves so arranged, that, when the body is in an erect posture, a vertical line from its summit would fall exactly on the centre of its base. It increases considerably in size in the lumbar region, so as to be altogether somewhat pyramidal in form. The lumbar portion, in the Chimpanzee and Orang, is not of the same proportional strength; and contains but four vertebræ instead of five. The processes for the attachment of the muscles of the back to this part, are peculiarly large and strong in Man; and this arrangement is obviously adapted to overcome the tendency, which the weight of the viscera in front of the column would have, to draw it forwards and downwards. On the other hand, the spinous processes of the cervical and dorsal vertebræ, which are in other Mammalia large and strong, for the attachment of the ligamentum nuchæ to support the head, have in Man but little prominence, his head being nearly balanced on the top of the column. The base of the human vertebral column is placed on a sacrum of greater proportional breadth, than that of any other animal; this sacrum is fixed between two widely expanded ilia; and the whole pelvis is thus peculiarly broad. In this manner, the femoral articulations are thrown very far apart, so as to give a wide basis of support; and by the oblique direction of the whole pelvis, the weight of the body is transmitted almost vertically, from the top of the sacrum to the upper part of the thigh bones. The pelvis of every other species of the class is very differently constructed; as will be seen in the adjoining Figure (6), in which the skeleton of the Orang is placed in proximity with that of Man. It is much longer and narrower, having a far smaller space between the iliac bones and the lowest ribs; the sacrum is lengthened and reduced in width; the alæ of the ilia are much less expanded; and the whole pelvis is brought nearly into a line with the vertebral column. The position of the human femur, in which it is most securely fixed in its deep acetabulum, is that which it has when supporting the body in the erect attitude. In the Chimpanzee and Orang, its analogous position is at an oblique angle to the long axis of the pelvis, with the body supported obliquely in front of it; in many Mammalia, as in the

* None but young specimens of the Chimpanzee and Orang Outan have ever been brought alive to this country; and they have never survived the period of their second dentition.

Elephant, it forms nearly a right angle; and in several others, as the Horse, Ox, &c., it forms an acute angle with the axis of the pelvis and spinal column.

54. The lower extremities of Man are remarkable for their length; which is proportionably greater than that which we find in any other Mammalia, except the Kangaroo tribe. It is evident that there could be no greater obstacle to his progression in the horizontal posture, than this length of what would then be his hind legs. Either Man would be obliged to rest on his knees, with his thighs so bent towards the trunk, that the attempt to advance them would be inconvenient, his legs and feet being entirely useless; or he must elevate his trunk upon the extremities of his toes, throwing his head downwards, and exerting himself violently at every attempt to bring forward the thighs by a rotatory motion at the hip-joint. In either case, the only useful joint would be that at the hip; and the legs would be scarcely superior to wooden or other rigid supports. The chief difference in their proportional length, between Man and the semi-erect Apes, is seen in the thigh; and from the comparative shortness of his arms, his hands only reach the middle of the thighs; whilst in the Chimpanzee they hang on a level with the knees, and in the Orang they descend to the ancles. The human femur is distinguished by its form and position as well as by its length. The obliquity and length of its neck still further increase the breadth of the hips; whilst they cause the lower extremities of these bones to be somewhat obliquely directed towards each other, so that the knees are brought more into the line of the axis of the body. This position is obviously of great use in walking, when the whole weight has to be alternately supported on each limb; for if the knees had been further apart, the whole body must have been swung from side to side at each step, so as to bring the centre of gravity over the top of each tibia; and, as a matter of fact, it is noticed that the walk of women, in whom the pelvis is broader and the knees more separated, is less steady than that of men.

55. There is a very marked contrast between the knee-joint of Man, and that even of the highest Apes. In the former, the opposed extremities of the femur and the tibia are expanded, so as to present a very broad articulating surface; and the internal condyle of the femur is lengthened, so that the two are in the same horizontal plane, in the usual oblique position of the femur. In this manner, the whole weight of the body, in its erect posture, falls vertically on the top of the tibia, when the joint is in the firmest position in which it can be placed: and a comparison of the knee-joint of the Orang with that of Man, will make it at once evident, that the former is not intended to serve as more than a partial support. The weight of the body is transmitted through the tibia, to the upper convex surface of the astragalus, and thence to the other bones of the foot. The Human foot is, in proportion to the size of the whole body, larger, broader, and stronger, than that of any other Mammal save the Kangaroo. The sole of the foot is concave, so that the weight of the body falls on the summit of an arch, of which the os calcis and the metatarsal bones form the two points of support. This arched form of the foot, and the natural contact of the os calcis with the ground, are peculiar to Man alone. All the Apes have the os calcis small, straight, and more or less raised from the ground; which they touch when standing erect, with the outer side only of the foot: whilst in animals more remote from Man, the os calcis is brought still more into the line of the tibia; and the foot being more elongated and narrowed, only the extremities of the toes come in contact with the ground. Hence Man is the only species of Mammal, which can stand upon one leg.— If we look at the structure of the upper extremity of Man, we observe similar proofs that it is not intended as an organ of support; being destitute of all these adaptations; and having a conformation obviously designed for other

Fig. 6.

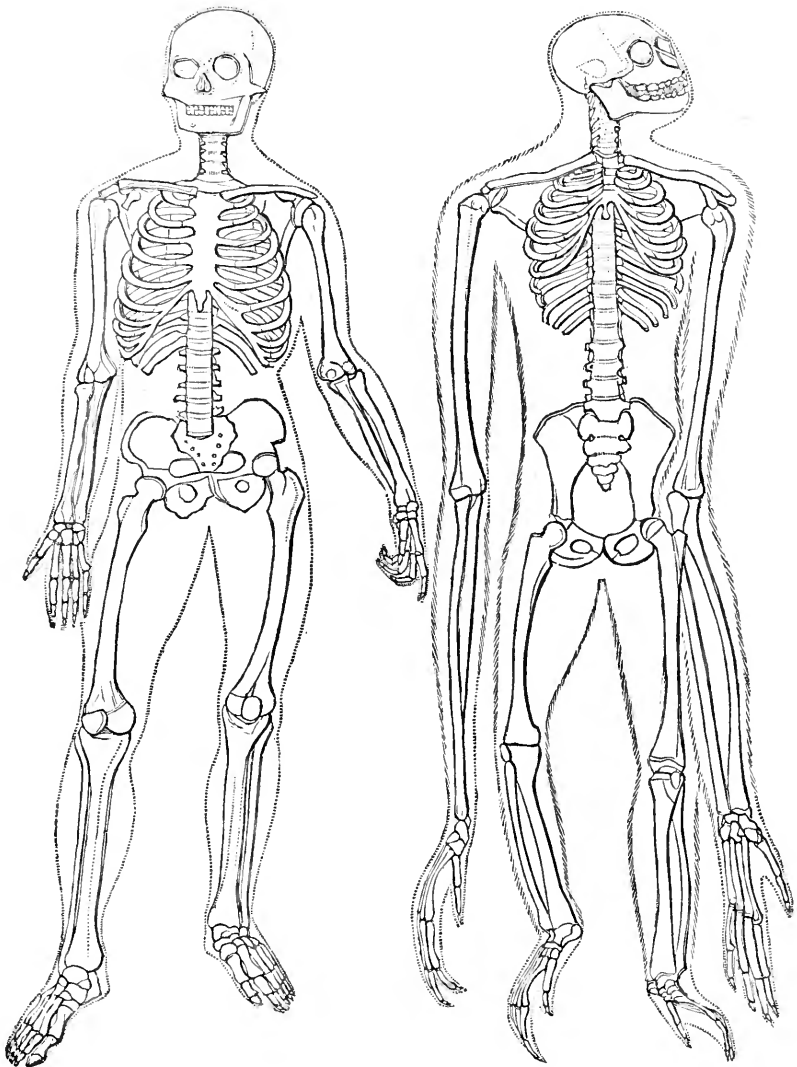

Comparative view of the Skeleton of Man and that of the Orang Outan.

purposes, which could not be possibly answered, if it were not completely relieved from the necessity of bearing the weight of the body. This peculiar conformation will be subsequently considered.

56. The other parts of the Human body concerned in locomotion are exactly adapted to the peculiar construction of the skeleton. The tibia is kept erect upon the foot by the very powerful muscles which are attached to the heel and form the calf of the leg,—a prominence observed in no other animal in nearly the same degree. The flexor longus pollicis pedis, which is attached in the Chimpanzee and Orang to the three middle toes, proceeds in man exclusively to the great toe, on which the weight of the body is often supported. The extensors of the leg upon the thigh are much more powerful than the flexors, an arrangement seen in no other animal. The glutæi, by which the pelvis is kept erect upon the thigh, are of far greater size than is elsewhere seen. The superior power of the muscles tending to draw the head and spine backwards, has been already referred to. In the general form of the trunk, there is a considerable difference between Man and most other Mammalia. His chest is large, but is flattened in front, and expanded laterally, so that its transverse diameter is greater than its antero-posterior;—a peculiarity in which only the most Man-like monkeys partake. His sternum is short and broad; and there is a considerable distance between the lower ribs and the ilia, in consequence of the small number of ribs, and the length of the lumbar portion of the vertebral column. The viscera in this space, which in the horizontal position would be but insufficiently held up by the abdominal muscles, are, in the erect attitude, securely supported by the expanded pelvis.—From all these facts, it is an indisputable conclusion, that the erect attitude and biped progression are natural to Man; and we must regard as in great degree fabulous, all those histories of supposed wild men, who, it has been said, were found in woods, dumb, hairy, and crawling on all-fours. The most elaborate investigation* of the structure of the anthropoid Apes, and the fullest acquaintance with their habits, concur in proving, that their movements are not easy or agile, unless they employ all their limbs for the support of their bodies.

57. The name *Bimana* is the most appropriate that could be found, for an order constituted by the Human species only; since Man alone is *two-handed*. “That,” says Cuvier, “which constitutes the *hand*, properly so called, is the faculty of opposing the thumb to the other fingers, so as to seize the most minute objects,—a faculty which is carried to its highest degree of perfection in Man, in whom the whole anterior extremity is free, and can be employed in prehension.” Some naturalists refuse the term *hand* to the extremities of the monkey tribe, preferring to call them *graspers*; for it is certainly true, that, although usually possessing an opposable thumb, they are destitute of the power of performing many of those actions which we regard as most characteristic of the hand. Such actions are chiefly dependent on the size and power of the thumb; which is much more developed in Man than it is even in the highest Apes. The thumb of the Human hand can be brought into exact opposition to the extremities of all the fingers, whether singly or in combination; whilst in those *Quadrumana* which most nearly approach Man, the thumb is so short and weak, and the fingers so long and slender, that their tips can scarcely be brought into opposition, and can never be opposed in near contact with each other, with any degree of force. Hence, although admirably adapted for clinging round bodies of a certain size, such as the small branches of trees, &c., the extremities of the *Quadrumana* can

* See especially Mr. Owen's paper on the Chimpanzee and the Orang Outan in the Zoological Transactions, vol. i.

neither seize very minute objects with such precision, nor support large ones with such firmness, as are essential to the dexterous performance of a variety of operations for which the hand of Man is admirably adapted. Hence the possession of "four hands" is not, as might be supposed, a character which raises the animals that exhibit it above two-handed Man; for none of these four hands are adapted to the same variety of actions of prehension of which his are capable; and all of them are in some degree required for support. In this respect their character approaches much nearer to that of the extremities of the lower Mammalia; and there are several among them in which, the opposable power of the thumb being deficient, there is no very marked distinction between the so-called hand, and the foot of some Carnivora. There is much truth, then, in Sir C. Bell's remark, that "We ought to define the hand as belonging exclusively to Man." There is in him, what we observe in none of the Mammalia that approach him in other respects, a complete distinction in the functional character of the anterior and posterior extremities; the former being adapted for prehension alone, and the latter for support alone. Thus each function is performed with a much higher degree of perfection than it can be where two such opposite purposes have to be united. The arm of the Ape has as wide a range of motion as in Man, so far as its articulations are concerned; but it is only when the animal is in the erect attitude, that its arm can have free play. Thus the structure of the whole frame must conform to that of the hand, and must act with reference to it. But it cannot be said with truth (as some have maintained) that Man owes his superiority to his hand alone; for without the directing mind, the hand would be comparatively valueless. His elevated position is due to his mind and its instruments conjointly; for if destitute of either, mankind would be speedily extinguished altogether, or reduced to a very subordinate grade of existence.

58. Thus, then, although the order Bimana cannot be separated from the order Quadrumana by any single obvious structural distinction, like that which characterises the Cetacea or the Cheiroptera, it is really as far removed by the minuter, but not less important, modifications which have been detailed. A few other distinctive characters will now be noticed. With one exception (the fossil genus *Anoplotherium*, which is allied to the Tapir tribe), Man is distinguished from all other animals, by the equality in the length of all his teeth, and by the equally close approximation of them all in each jaw. Even the anthropoid Apes have the canine teeth longer than the others, and an interval in the line of teeth in each side of the jaw, to receive the canine teeth of the opposite jaw. This is more evident in the adult than in the young animal. The vertical position of the Human teeth, on which one of the most characteristic features of the Human face—the prominent chin—depends, is also quite peculiar; and is intimately connected both with his erect attitude, and with the perfection of the hands, by which the food is divided and conveyed to the mouth. He has no occasion for that protrusion of the muzzle and lips, which, in animals that seize their food with the mouth only, is required to prevent the face from coming into general contact with it.—The absence of any weapons of offence, and of direct means of defence, are remarkable characteristics of Man, and distinguish him from other animals. On those to whom Nature has denied weapons of attack, she has bestowed the means either of passive defence, of concealment, or of flight. Yet Man, by his superior reason, has not only been enabled to resist the attacks of other animals, but even to bring them under subjection to himself. His intellect can scarcely suggest the mechanism, which his hands cannot frame; and he has devised and constructed arms more powerful than those which any other creature wields, and defences so secure as to defy the assaults of all but his

fellow-men.—We find, on comparing the brain of Man with that of the lower Mammalia, that, as might have been anticipated, its proportional dimensions are much greater, and its structure more complex. The former part of this statement is easily verified by an examination of the cranium alone, comparing the size of its cavity with that of the face. The amount of the facial angle; taken after the manner of Camper, affords a tolerably correct indication of the relative sizes of these parts. In Man, the facial angle is, in the average of Europeans, 80° ; in Negroes, it is about 70° . In the adult Chimpanzee (which approaches in this respect nearest to Man), the facial angle is only 35° ; and in the Orang, it is no more than 30° . In other animals it is still less, except when it is increased by the prominence of large frontal sinuses, or by the comparative shortness of the jaws. In regard to the structure of the brain, we shall here only remark generally, that the Encephalon of Man far exceeds that of the highest Quadrumana, in the size of the cerebral hemispheres, in the complexity and development of its internal parts, and in the depth and number of its convolutions.

59. Man cannot be regarded as distinguished from other Mammalia, however, either by acuteness of sensibility, or by muscular power. His swiftness in running, and agility in leaping, are inferior to that of other animals of his size,—the full-grown Orang for example. The smallness of his face, compared with that of the cranium, shows that the portion of the nervous system distributed to the organs of sense, is less developed in him than it is in most other animals; and the small proportional size of the ganglionic centres, with which these organs are immediately connected, is another indication of the same fact. Accordingly, he is surpassed by many in acuteness of sensibility to light, sound, &c.; but he stands pre-eminent in the power of comparing sensations, and of drawing conclusions from them. Moreover, although none of his senses are very acute in his natural state, they are all moderately so, which is not the case in other animals; and they are capable (as is also his swiftness of foot) of being much improved by practice, especially when circumstances strongly call for their exercise. This power of adaptation to varieties in external conditions, which makes him to a great extent independent of them, is manifested in other features of his structure and economy. He is capable of sustaining the lowest, as well as the highest, extremes of temperature and of atmospheric pressure. In the former of these particulars, he is strikingly contrasted with the anthropoid Apes, such as the Chimpanzee, which is restricted to a few of the hottest parts of Africa, and the Orang-Outan, which is only found in Borneo and Sumatra: these cannot be kept alive in temperate climates, without the assistance of artificial heat; and even when this is afforded, they speedily become diseased and die. His diet is naturally of a mixed kind; but he can support himself in health and strength, on either animal or vegetable food exclusively. It is by the demands which his peculiar condition makes upon the exercise of his ingenuity, that his mental powers are first called into active operation; but, when once aroused, their development has no assignable limit. The slow growth of Man, and the length of time during which he remains in a state of dependence upon his parents, have been already mentioned as peculiarities, by which he is distinguished from all other animals. He is unable to seek his own food, during at least the three first years of his life; and he does not attain to his full stature, until he is more than twenty years of age. In proportion to his size, too, the whole sum of his life is greater than that of other Mammalia. The greatest age of the Horse, for example, which is an animal of much superior bulk, is between thirty and forty years. That of the Orang, which, when full grown, surpasses Man in stature, is about the same, so far as it can be ascertained. The age to which the life of Man is frequently prolonged, is well

known to be above a hundred years; and instances of such longevity are to be found in all nations.

60. Still, however widely Man may be distinguished from other animals, by these and other peculiarities of his structure and economy, he is yet more distinguished by those mental endowments, and the habitudes of life and action thence resulting, which must be regarded as the essential characteristics of humanity. In the highest among brutes, the mere instinctive propensities (as already defined, §§ 17, 23), are the frequent springs of action; and although the intelligent will is called into exercise to a certain extent, the character never rises beyond that of the child. In fact, the correspondence between the psychical endowments of the Chimpanzee, and those of the Human infant before it begins to speak, is very close. In Man, however, the instinctive propensities only manifest themselves strongly, whilst the intellect is undeveloped; and nearly all the actions of adult life are performed under the direction of the intelligent will. From the intelligence of Man results his mental improvability; and his improved condition impresses itself upon his organization. This capability of improvement in the bodily as well as the mental constitution of Man, is the cause of the comforts now enjoyed by civilised races, and of the means which they possess of still further elevation. In the processes by which these are attained, we observe a remarkable difference between the character of Man, and that of other animals. The arts of which these last are capable, are limited, and peculiar to each species; and there seems to be no *general* power of adapting these to any great variety of purposes, or of profiting by the experience of others. Where a particular adaptation of means to ends, of actions to circumstances, is made by an individual (as is frequently the case, when some amount of intelligence or rationality exists), the rest do not seem to profit by it; so that there is no proof that any species or race among the lower animals ever makes a voluntary advance towards an improvement or alteration in its condition. That modifications in structure and instincts may be induced by circumstances, in some of the most improvable species, such as the Dog, has been shown by abundant evidence; and these modifications, if connected with the original habits and instincts of the species, may be hereditarily transmitted. There is ample proof that the same is the case, in regard both to the corporeal structure and the psychical endowments of Man. Under the influence of education, physical and mental, continued through successive generations, the capabilities of his whole nature, and especially those of his brain, are called out; so that the general character of the race is greatly improved. On the other hand, under the influence of a degraded condition, there is an equally certain retrogression; so that, to bring up the New Holland Savage, or the African Bushman, to the level of the European, would probably require centuries of civilisation. One of the most important aids to the use and development of the human mind, is the power of producing articulate sounds, or language; of which, as far as we know, Man is the only animal in possession. There is no doubt, that many other species have certain powers of communication between individuals; but these are probably very limited, and of a kind very different from a verbal language.

61. Although, as we have stated, there is nothing in Man's present condition, which removes him from the pale of the Animal kingdom, and although his reasoning powers differ rather in degree than in kind from those of the inferior animals, he seems distinguished by one innate tendency; to which we have no reason to suppose that anything analogous elsewhere exists; and which we might term an instinct, were it not that this designation is generally applied to propensities of a much lower character. The tendency here referred to, is that which seems universal in Man, to believe in some unseen

Existence. This may take various forms, but is never entirely absent from any race or nation, although (like other innate tendencies) it may be defective in individuals. Attempts have been made by some travellers to prove, that particular nations are destitute of it; but such assertions have been based only upon a limited acquaintance with their habits of thought, and with their outward observances. For there are probably none, that do not possess the idea of some invisible Power external to themselves; whose favour they seek, and whose anger they deprecate, by sacrifice and other religious observances. It requires a higher mental cultivation than is always to be met with, to conceive of this Power as having a Spiritual existence; but wherever the idea of spirituality can be defined, it seems connected with it. The vulgar readiness to believe in demons, ghosts, &c., is only an irregular or depraved manifestation of the same tendency. Closely connected with it, is the desire to share in this spiritual existence; which has been implanted by the Creator in the mind of Man; and which, developed as it is by the mental cultivation that is almost necessary for the formation of the idea, has been regarded by philosophers in all ages, as one of the chief *natural* arguments for the immortality of the soul. By this Immortal Soul, the existence of which is thus guessed by Man, but of whose presence within him he derives the strongest assurance from Revelation, Man is connected with beings of a higher order, amongst whom Intelligence exists, unrestrained in its exercise by the imperfections of that corporeal mechanism, through which it here operates; and to this state,—a state of more intimate communion of mind with mind, and of creatures with their Creator,—he is encouraged to aspire, as the reward of his improvement of the talents here committed to his charge.

CHAPTER II.

OF THE MUTUAL RELATIONS OF THE DIFFERENT BRANCHES OF THE HUMAN FAMILY.

1. *General Considerations.*

62. AMONGST the various tribes of Men, which people the surface of the globe, and which are separated from all other animals by the foregoing characters, there are differences of a very striking and important nature. They are distinguishable from each other, not merely by their language, dress, manners and customs, religious belief, and other acquired peculiarities, but in the physical conformation of their bodies; and the difference lies, not merely in the colour of the skin, the nature of the hair, the form of the soft parts (such as the nose, lips, &c.) but in the shape of the skull, and of other parts of the bony skeleton, which might be supposed to be less liable to variation. It is a question of great scientific interest, as well as one that considerably affects the mode in which we treat the races that differ from our own,—whether they are all of *one species*, that is, descended from the *same* or from *similar* parentage,—or whether they are to be regarded as *distinct species*, the first parents of the several races having had the same differences among themselves, as those now exhibited by their descendants.

63. It has been a favourite idea, among those who wished to excuse the horrors of slavery, or the extirpation of savage tribes, that the races thus

treated might be considered as inferior species, incapable of being raised by any treatment to our own elevation; and as thus falling legitimately under the domination of the superior races, just as the lower animals have been placed by the Creator in subservience to Man. This doctrine, which has had its origin in the desire to justify as expedient what could not be defended as morally right, finds no support from scientific inquiries conducted in an enlarged spirit. In order to arrive at a just conclusion on the subject, it is necessary to take a very extensive survey of the evidence furnished by a number of different lines of inquiry. Thus, in the first place, it is right to investigate what are the discriminating structural marks, by which *species* are distinguished among the lower tribes of animals.—Secondly, it should be ascertained to what extent *variation* may proceed among races, which are historically known to have a common parentage; and what are the circumstances which most favour such variations.—Thirdly, the extreme variations, which present themselves among the different races of men, should be compared with those which occur among tribes of animals known to be of the same parentage; and it should be questioned, at the same time, whether the circumstances which favour the production of varieties in the latter case, are in operation in the former.—Fourthly, where it is impossible to trace back distinct races to their origin, it is to be inquired how far agreement in physiological and psychological peculiarities may be regarded as indicating specific identity, even where a considerable difference exists in bodily conformation; and this test, if it can be determined on, has to be applied to Man. Fifthly, it must be attempted, by a detailed examination of the varieties of the human race themselves, to ascertain whether their differences in conformation are constant; or whether there are not occasional manifestations, in each race, of a tendency to assume the characters of others; so as to prevent a definite line being drawn between the several tribes, which together make up the (supposed) distinct species.*

2. On the Discrimination of Species.

64. The *first* of the foregoing questions is a fertile source of perplexity to the Naturalist; owing to the tendency that exists in certain races of Plants and Animals, to exhibit variations of form much greater than those which are relied upon in other instances as characterizing distinct species. In our ignorance as to the history of the origin of the greater part of the dissimilar forms or races of organized beings, with which the globe is peopled, we are accustomed to regard two races of Plants or animals as of the *same species*,—that is, as having had the same or similar progenitors,—when they are not distinguished from one another by any peculiarities, but such as the one may be supposed to have *gained*, or the other to have *lost*, by the influence of external circumstances during a long period of time. On the other hand, two races are regarded as constituting *distinct species*,—that is, are believed to have descended from dissimilar parents,—when a constant well-marked difference exists between them, such as exhibits no tendency to variation in the individuals of either race (being equally characteristic of every one), and is not affected by the lapse of time or by change in external conditions.

65. Thus, if we compare together the different breeds of Dogs, we find

* This investigation has been most elaborately, and in the Author's opinion most successfully, worked out by Dr Prichard, in his profound and philosophical Treatise on the Physical History of Man. The sketch of the argument given above does little more than exhibit the conclusions at which he has arrived; and for the grounds on which these are based, reference must be made to that work, or to the abridgment of it published by Dr. Prichard, under the title of the Natural History of Man.

that, although they are distinguished by very marked peculiarities, yet that these peculiarities are by no means constant. There is historical evidence of the great change, which may take place in their conformation and habits, under the influence of a change in their external circumstances; in the case, for example, of the blood-hounds, introduced into the West Indies by the Spaniards, which have now degenerated into a wild race of very different form, and have lost all the distinctive characters of the breed. And there is not that close agreement in the distinctive characters of the several breeds, among the individuals respectively composing them, which is requisite for the establishment of a definite specific distinction; the characters being shaded off, as it were in individuals, so as to cause a near approximation between the less decided forms of the different races.—On the other hand, in spite of the varieties of conformation exhibited by the several races of Dog, (which even affect the *number* of vertebræ in the tail, as well as the shape and proportions of the bones, we never see any which present so strong a resemblance to the Fox, as to be at all in danger of being mistaken for that animal; and they may always be distinguished by this obvious character,—that the pupil of the eye of the Dog is always *round*, whilst that of the Fox is *oval* when contracted. This difference may appear a very trifling one, in comparison with the important variations presented in the structure of the different breeds of Dogs; but it is *constant*; and it may therefore be assumed to have existed in the progenitors of each race, as it exists at present in all their descendants.

66. There are many instances of an opposite character, in which the tendency to variation is extremely small; and in which the Naturalist feels justified in assuming a specific difference, from variations in size or colour, which in themselves are very trifling, but which are important in classification, because they are constant. Thus, among the several species of the genus *Felis* (or Cat tribe), there is scarcely any perceptible osteological variation, except in point of size; so that even Cuvier was unable to find out a positive means of distinguishing the skull of the Lion from that of the Tiger; and the skeleton of a Wild Cat is a reduced copy of that of the largest Felines. There are certain species, which are distinguished by no other external indications, than the markings upon their skins;—characters, which are in *other* cases subject to extreme uncertainty; but which are *here* so constant, as to present scarcely the slightest variation amongst the individuals of each race. Thus, if a certain patch or stripe be repeated from generation to generation, in a wild feline race, the Naturalist is inclined to regard this as a sufficient proof of the specific difference of that race from another which is differently marked. The Domestic Cat is the only one of the group, which is liable to any considerable variation; and in this species, as every one knows, the markings characteristic of the several breeds or races are *not* thus constantly repeated, and therefore cannot be indicative of original difference. Now it is precisely in this species that we should look for such variations; since it is the only one which can be domesticated; and the capability of domestication implies a power in the original constitution of the animal, to adapt itself to a change of circumstances, and thus to exhibit various departures from its original type.

67. This striking contrast, between *variable* and *invariable* groups of animals nearly allied to each other, is found through the whole kingdom; every division of it appearing to contain *some* species, which do not change their forms or other characteristics under any circumstances, but which cease to exist if a change takes place in their conditions, incompatible with the regular performance of their functions; whilst it also includes others, in whose physical and psychical constitutions there is such a susceptibility of modification, that new forms and new instincts may arise, adapted to a great variety of external conditions, and thus new and very different races may be originated.

Thus, the Feline races, with a few exceptions, are fitted to maintain life only in tropical climates, and very speedily die in colder countries (unless kept warm by artificial means), in consequence of their deficiency of heat-producing power, and the want of a close downy fur adapted to retain the caloric generated in their bodies. On the other hand, the Dog is enabled to accompany Man, in the coldest as well as the hottest regions of the globe; his power of generating heat being capable of variation, in accordance with the external temperature; and his entire organization undergoing modifications, which adapt it to the change in the conditions of its existence. It appears, then, that it is quite impossible to fix upon any difference of structural peculiarities, as indications of the distinctness of species; until it has been ascertained by observation, whether they are constant and invariable,—the races neither exhibiting any tendency to change in successive generations,—nor showing any disposition to mutual approximation, by the occasional modification of the distinctive characters in the individuals composing them.

3. *On the possible Extent of Variation within the Limits of Species.*

68. We now come to the *second* point of our inquiry,—namely, the amount of variation which may take place in races, historically known to have had a common parentage. There is considerable difficulty in obtaining the most complete evidence upon this subject; owing to the want of accurate observation in the more remote historical periods, when it is probable that most of the varieties or breeds of our domesticated animals were first originated. Still there is an adequate amount of proof, that these races may undergo very considerable modifications, in the course of a few generations; and that new races or breeds, distinguished by marked peculiarities, may originate even at the present time. Our most satisfactory information is derived from the changes, which have taken place in the races of domesticated animals, introduced into the West Indies and South America, by the Spaniards, three centuries since. Many of these races have multiplied exceedingly, on a soil and under a climate congenial to their nature; and several of them have run wild in the vast forests of America, and have lost all the most obvious appearances of domestication. The wild tribes are found to differ physically from the domesticated breeds, from which they are known to have originated; and there is good reason to regard this change, as a partial restoration of the primitive characteristics of the wild stocks, from which the tamed animals originally descended. Thus we find that the Hog, where it has returned to its wild state, nearly resembles the Wild Boar, which has never been in a state of domestication. The colour loses the variety found in the domestic breeds; the Wild Hogs of the American forests being uniformly black. The thin covering of hair and scattered bristles is replaced by a thick fur, often somewhat crisp; beneath which is found, in those which inhabit the colder regions, a species of wool. The head, too, becomes much larger in these wild races, as in the original Boar; and the differences in the conformation of the cranium, between these and the domesticated breeds, are fully equal to anything that is seen in the human race.—The variations which present themselves in other races of domesticated animals introduced into South America at the same period,—such as the horse, ass, ox, sheep, goat, dog, cat, and gallinaceous birds,—are not less striking.—Still more remarkable variations are seen in certain domesticated breeds, which must without doubt have sprung from the same stock with the ordinary ones, although their origin cannot be traced historically; thus, in some localities we find swine with solid hoofs; in others, the hoof is cleft into five parts; and in others, again, the toes are developed to a monstrous length.

69. Although the numerous examples furnished by the Vegetable Kingdom may seem to have but a remote bearing on the question, it would still be wrong to pass them by without notice; since the general principles already noticed are recognized by Botanists, as serving for the discrimination or identification of species of Plants; to which they apply equally with Animals. We have abundant evidence, in the case of our cultivated fruits and flowers, of the origination of new and well-marked varieties from stocks originally the same; the differences between these races being such, as would undoubtedly have led to their being ranked as distinct species, if their common parentage were not known. Thus, of the numerous widely-different varieties of Apple, Pear, Strawberry, Plum, &c., many have been produced in our own time; and there is no doubt, that all the forms of each fruit are descended from wild stocks, extremely unlike any one of them. So the Cowslip, Primrose, Oxslip, and Polyanthus, which were formerly regarded as constituting at least two distinct species, have been shown to be all producible from the seeds of one parent. And a single plant of the Orchideous tribe has borne flowers and pseudo-bulbs, which were formerly considered as characteristic of three distinct *genera*.

70. Of the origination of entirely new races of animals, distinguished by physical peculiarities, and disposed to become permanent under circumstances favourable to their perpetuation, we have frequent examples at the present time. It is not uncommon to meet with individuals among our domesticated animals, which differ from others of their kind, in some marked feature of their conformation. If this be of a nature which impairs the value of the animal, care is taken that it shall *not* propagate its race; but, on the other hand, if it afford a prospect of utility, the skill of the breeder is employed to perpetuate it. One of the most remarkable examples of this kind, is to be found in the origin of the *Ancon* or *Otter* breed of Sheep, now common in New England. In the year 1791, one of the ewes on the farm of Seth Wright, in the State of Massachusetts, produced a male lamb, remarkable for the singular length of its body, the shortness of its limbs, and the crookedness of its fore-legs. This physical conformation, incapacitating the animal from leaping fences, appeared to the farmers around so desirable, that they wished it continued. Wright consequently determined on breeding from this ram; but the first year he obtained only two with the same peculiarities. In the following years, he obtained greater numbers; and when they became capable of breeding with one another, the new race became permanent,—the offspring invariably having the *Ancon* conformation, when *both* the parents belonged to that breed. In the Human race, it is not uncommon to find particular families distinguished by the possession of six fingers on each hand, and six toes on each foot. If such were to intermarry exclusively with one another, there can be no reasonable doubt that the children would invariably exhibit the same peculiarity; and the six-fingered race, which now tends, whenever it is originated, to merge in the more general form, would then become permanent. When it is remembered that the influence of a scanty population, in the early ages of the world, would have been precisely the same as that which is now exercised by the breeders of animals, we can understand why the varieties, which *then* arose, should have had a much greater tendency to become permanent, than most of those which *now* present themselves. At the present time, any peculiarity which may occasionally arise, speedily merges by intermixture with the mass, and returns to the common standard; but when population was scanty, any peculiarities existing in one family would be perpetuated, by the intermixture of its members, rendered necessary by their isolation from others; and thus a new race would originate.

71. For the *cause* of these occasional variations from the common type,

we must look in part to the original constitution of the species, and in part to the influence of external conditions. As already mentioned, there is a marked difference among various species of animals (even those nearly allied, such as the Domestic Cat and the Tiger), in regard to their respective *capacities for variation*. And among the peculiarities of conformation which occasionally present themselves in the Human and other most variable species, there are several, which cannot be in any way attributed to the modifying influence of external conditions;—such, for example, as the development of additional fingers or toes, the alteration in the number of the vertebrae in the tail, the unusual consolidation or separation of the toes, &c. But it cannot be doubted, when the known history of the domesticated races is fairly considered, that a change of external circumstances is capable of exerting a very decided influence upon the physical form, upon the habits and instincts, and upon various functions of life. The variations thus induced, extend to considerable modifications in the external aspect, such as the colour, the texture, and the thickness of the external covering; to the structure of limbs, and the proportional size of parts; to the relative development of the organs of the senses and of the psychical powers, involving changes in the form of the cranium; and to acquired propensities, which, within certain limits (depending, it would appear, on their connection with the natural habits of the species), may become hereditary.

4. *On the Extremes of Variation among the Races of Men.*

72. We have now to inquire, in the *third* place, how far the same influences might be expected to operate in the Human race; and whether the extreme varieties, which we encounter among Mankind, are really greater than those, which we meet with in the races of domesticated animals, known to have had a common ancestry. It must be admitted by every one, that *both* of the conditions just noticed as favouring the origination of peculiarities, operate to their fullest extent in Man. There is no other species of animals, in which an equal tendency to variation exists. The different individuals of the same breed of Dogs, for example, resemble each other far more closely in physical and mental characters, than the individual men of one nation; and there is no species of animals, which possesses an equal power of maintaining life in the remote extremes of climate, atmospheric pressure, &c., which are encountered at different parts of the earth's surface, and at different elevations above it. Again, we should expect to find these varieties in external circumstances, together with the change of habits induced by civilization (which is far greater than any change effected by domestication in the condition of the lower animals), producing still more important alterations in the physical form and constitution of the Human body, than those effected in brutes by a minor degree of alteration. And it may be reasonably anticipated, that, as just now explained, there would be a greater tendency to the perpetuation of these varieties, in other words, to the origination of distinct races, during the earlier ages of the history of the race, than at the present time, when, in fact, by the increasing admixture of races which have long been isolated, there is a tendency to the *fusion* of all these varieties, and to a return to a common type. Now, when the *extreme* varieties which are presented by the different races of Man are carefully compared together, it is found that their differences are all of the same *kind* as those, which present themselves among the breeds of domesticated animals; and do not by any means exceed them (perhaps not even equalling them in *degree*. This will be shown in detail hereafter.

73. It appears, then, that the analogical argument derived from the pheno-

mena presented by the domesticated species among the lower animals, is decidedly in favour of the *specific unity* of the Human race; the differences which have sprung up, in course of time, amongst the inhabitants of different parts of the world, being such as we have a fair right to attribute—according to the recognized principles of Zoology—to the modifying influence of external conditions, acting upon a constitution peculiarly disposed to yield to it.

5. *On the Value of Physiological and Psychological Peculiarities, as Specific Distinctions.*

74. We have now to inquire, in the *fourth* place, what other arguments in favour of this position may be drawn from agreement or difference in Physiological and Psychological peculiarities. A comparison of the *physiological* history of two races, is often found to afford a better criterion of their specific difference or identity, than the comparison of their *structural* characters. Now, in every important point of physiological history, there is a wonderful agreement amongst the different races of Men; the variations not being greater than are those with which we meet among the different individuals of any one race. Thus, we not only find the average duration of life to be everywhere the same, (making allowance for circumstances which are likely to induce disease), but the various epochs of life have a close correspondence,—such as the times of the first and second dentition, the period of puberty, the duration of pregnancy, the intervals of the catamenia, and the time of their final cessation. And the different races of Man are all subject to the same diseases, both sporadic, contagious, and epidemic; whilst there are no two really-distinct species among the lower animals, which have more than a very slight conformity in this respect.

75. The most important physiological test of specific unity or diversity, is derived from the phenomena attending the Reproductive process. It is well known that, in Plants, the stigma of the flower of one species may be fertilized with the pollen of an allied species; and that, from the seeds produced, plants of an intermediate character may be raised. These *hybrid* plants, however, will not perpetuate the new race; for, although they may ripen their seed for one or two generations, they will not continue to reproduce themselves beyond the third or fourth. But, if the intervention of one of the parent species be employed,—its stigma being fertilized by the pollen of the hybrid, or *vice versa*,—a mixed race may be kept up for some time longer; but it will then have a manifest tendency to return to the form of the parent whose intervention has been employed. Where, on the other hand, the parents themselves were only *varieties*, the hybrid forms but another variety, and its powers of reproduction are rather increased than diminished; so that it may continue to propagate its own race, or may be used for the production of other varieties, almost *ad infinitum*. In this way, many beautiful new varieties of garden flowers have been obtained; especially among such species as have a natural tendency to change their aspect. Amongst Animals, the limits of hybridity are much more narrow, since the hybrid is totally unable to continue its race with one of its own kind;* and although it may be fertile with one of its parent species, the progeny will of course approach in character to the pure breed, and the race will ultimately merge into it. On the other hand, in Animals, as among Plants, the mixed offsprings originating from different races within the limits of the same species, generally exceed in vi-

* One or two instances have been stated to occur, in which a Mule has produced offspring from union with a similar animal; but this is certainly the extreme limit, since no one has ever maintained that the race can be continued further than the second generation, without admixture with one of the parent species.

gour, and in the tendency to multiply, the parent races from which they are produced, so as to gain ground upon the older varieties, and gradually to supersede them. In this manner, by the *crossing* of the breeds of our domesticated animals, many new and superior varieties have been produced. The general principle is, then, that beings of distinct *species*, or descendants from stocks originally different, cannot produce a mixed race, which shall possess the capability of perpetuating itself; whilst the union of *varieties* has a tendency to produce a race superior in energy and fertility to its parents.

76. The application of this principle (if it be admitted as such) to the Human races, leaves no doubt with respect to their specific unity; for, as is well known, not only do all the races of Men breed freely with each other, but the mixed race is generally superior in physical development, and in tendency to rapid multiplication, to either of the parent stocks; so that there is much reason to believe that, in many countries, the mixed race between the Aborigines and European colonizers will ultimately become the dominant power in the community. This is especially the case in India and South America.

77. Not less conclusive is the result of the test, furnished by agreement or difference in *psychological* characters. Among the lower animals, we find every species characterised by the possession of instincts and propensities peculiar to itself; and these instincts often differ remarkably in species, which present the closest structural alliance. On the other hand, in the several varieties of domesticated animals, notwithstanding their strongly-marked diversities of physical structure, we may recognize instincts which are fundamentally the same, although they have been modified by the continued influence of Man, and by the new circumstances in which the animals are placed. Now from an impartial survey of the psychological characters of the different races of Men, so far as our present knowledge extends, the following conclusion may be drawn. "We contemplate, among all the diversified tribes, who are endowed with reason and speech, the same internal feelings, appetencies, and aversions; the same inward convictions, the same sentiments of subjection to invisible powers, and (more or less fully developed) of accountability or responsibility to unseen avengers of wrong and agents of retributive justice, from whose tribunal men cannot even by death escape. We find everywhere the same susceptibility, though not always in the same degree of forwardness or ripeness of improvement, of admitting the cultivation of those universal endowments, of opening the eyes of the mind to the more clear and luminous views which Christianity unfolds, of becoming moulded to the institutions of religion and of civilised life: in a word, the same inward and mental nature is to be recognized in all the races of men.*

6. *On the Comparative Peculiarities of the Different Races of Mankind.*

78. We have now to inquire, *fifthly* and lastly, whether it is possible, after a detailed and careful examination of the *ensemble* of the characters of the different races of Men, to make any division of them into distinct groups, capable of being defined by such constant and well-marked features, as shall entitle them to be regarded in the light of distinct species. The general results, only, of this inquiry, can here be given; and this in a very summary manner. They will be almost entirely drawn from the profound and laborious investigations of Dr. Prichard.

79. The characters which are most relied on for the discrimination of the several races of Mankind, are the colour of the skin, the nature of the hair, and the conformation of the skull and other parts of the skeleton. The *Co-*

* Prichard's Natural History of Man, p. 546.

colour of the skin exists in the epidermis only; and it depends upon the admixture of certain peculiar cells, termed *pigment-cells*, with the ordinary epidermic cells. These pigment-cells, as will be shown hereafter (§ 163), are distinguished by their power of generating or secreting colouring-matter of various hues; and all the varied shades of colour, presented by the different races of men, are due to the relative amount of these cells, and to the particular tint of the pigment which they form. It would be easy, by selecting well-marked specimens of each race, to make it appear that colour affords sufficient distinctive marks for their separation: thus, for example, the fair and ruddy Saxon, the jet-black Negro, the olive Mongolian, and the copper-coloured North American, would seem positively separated from each other by this character, propagated, as it seems to be, with little or no perceptible change, from generation to generation. But although such might appear to be the clear and obvious result of a comparison of this kind, yet a more profound and comprehensive survey tends to break down the barrier that would be thus established. For, on tracing this character through the entire family of Man, we find the isolated specimens just noticed to be connected by such a series of links, and the transition from one to the other to be so very gradual that it is impossible to say where the line is to be drawn. There is nothing here, then, which at all approaches to the fixed and definite marks, which have been noticed as serving—though equally trivial in themselves—to establish specific distinctions among other tribes of animals.

80. But further, there is abundant evidence that these distinctions are far from being constantly maintained, even in any one race. For among all the principal subdivisions, *albinism*, or the absence of pigment-cells, occasionally presents itself; so that the fair skin of the European may present itself in the offspring of the Negro or of the Red Man. On the other hand, instances are by no means rare, of the unusual development of pigment-cells in individuals of the fair-skinned races; so that parts of the body are of a dark red or brown hue, or are even quite black. Such modifications may seem of little importance to the argument; since they are confined to individuals, and may be put aside as accidental. But there is ample evidence, that analogous changes may take place in the course of time, which tend to produce a great variety of shades of colour, in the descendants of any one stock. Thus, in the great Indo-Atlantic family, which may be unquestionably regarded as having had a common origin, we find races with fair complexion, yellow hair, and blue eyes,—others presenting the xanthous or olive hue,—and others decidedly black. A similar diversity may be seen among the American races, which are equally referrible to one common stock; and it exists to nearly the same extent among the African nations, which are similarly related to each other. It may be freely admitted that, among European colonists settled in hot climates, such changes do not present themselves within a few generations; but in many well-known instances of earlier colonization they are very clearly manifested. Thus the wide dispersion of the Jewish nation, and their remarkable isolation (maintained by their religious observances) from the people among whom they live, render them peculiarly appropriate subjects for such observations; and we accordingly find, that the brunette complexion and dark hair, which are usually regarded as characteristic of the race, are frequently superseded, in the Jews of Northern Europe, by red or brown hair and fair complexion; whilst the Jews who settled in India some centuries ago, have become as dark as the Hindoos around them.

81. The relation of the complexions of the different races of Men to the climates they respectively inhabit, is clearly established by an extended comparative survey of both. From such a survey the conclusion is inevitable, that the intertropical region of the earth is the principal seat of the black races

of Men; whilst the region remote from the tropics is that of the white races; and that the climates approaching the tropics are generally inhabited by nations, which are of an intermediate complexion. To this observation it may be added, that high mountains, and countries of great elevation, are generally inhabited by people of a lighter colour, than are those of which the level is low, such as swampy or sandy plains upon the sea-coast. These distinctions are particularly well seen in Africa, where the tropics almost exactly mark out the limits of the black complexion of the inhabitants; and where the deepest hue is to be seen among the Negroes of the Guinea Coast, whose residence unites both the conditions just mentioned.

82. The nature of the *Hair* is, perhaps, one of the most permanent characteristics of different races. In regard to its colour, the same statements apply, as those just made with respect to the colour of the skin; the variety of hue being given by pigment-cells, which may be more or less developed under different circumstances. But it has been thought that its *texture* afforded a more valid ground of distinction; and it is commonly said that the substance which grows on the head of the African races, and of some other dark-coloured tribes (chiefly inhabiting tropical climates), is *wool*, and not hair. This, however, is altogether a mistake: for microscopic examination clearly demonstrates, that the hair of the Negro has exactly the same structure with that of the European; and that it does not bear any resemblance to wool, save in its crispness and tendency to curl. Moreover, even this character is far from being a constant one; for, whilst Europeans are not unfrequently to be met with, whose hair is as crisp as that of the Negro, there is a great variety amongst the Negro races themselves, which present every gradation from a completely crisp (or what is termed woolly) hair, to merely curled or even flowing locks. A similar observation holds good in regard to the natives of the islands of the great Southern Ocean, where some individuals possess crisp hair, whilst others, of the same race, have it merely curled. It is evident, then, that no characters can be drawn from the colour or texture of the hair in Man, sufficiently fixed and definite to serve for the distinction of races: and this view is borne out by the evident influence of climate, in producing changes in the hairy covering of almost every race of domestic animals;—the change often manifesting itself in the very individuals that are transported from one country to another, and showing itself yet more distinctly in succeeding generations.

83. It has been supposed, that varieties in the configuration of the Skeleton would afford characters for the separation of the Human races, more fixed and definite than these derived from differences in the form, colour, and texture of the soft parts which clothe it. And attention has been particularly directed to the *skull* and the *pelvis*, as affording such characters. It has been generally laid down as a fundamental principle, that all those notions which are found to resemble each other in the shape of their heads, must needs be more nearly related to each other, than they are to tribes of Men who differ from them in this particular. But if this principle be rigorously carried out, it will tend to bring together races, which inhabit parts of the globe very remote from each other, and which have no other mark of affinity whatever: whilst, on the other hand, it will often tend to separate races, which every other character would lead us to bring together. It is to be remembered, moreover, that the varieties in the conformation of the skeleton, presented by the breeds of domesticated animals, are at least equal to those which are manifested in the conformation and colour of their soft parts; and we might reasonably expect, therefore, to meet with similar variations among the Human races. It is probable, however, that climate has not so much influence in producing such changes in the configuration of the body, as is exerted by the

peculiar habits and mode of life of the different races; and Dr. Prichard has pointed out a very remarkable relation of this kind, in regard to the three principal types of form presented by the skull.

84. Among the rudest tribes of Men, hunters and savage inhabitants of forests, dependent for their supply of food on the accidental produce of the soil or on the chase,—among whom are the most degraded of the African nations, and the Australian savages,—a form of head is prevalent, which is most aptly distinguished by the term *prognathous*, indicating a prolongation or forward-

Fig. 7.

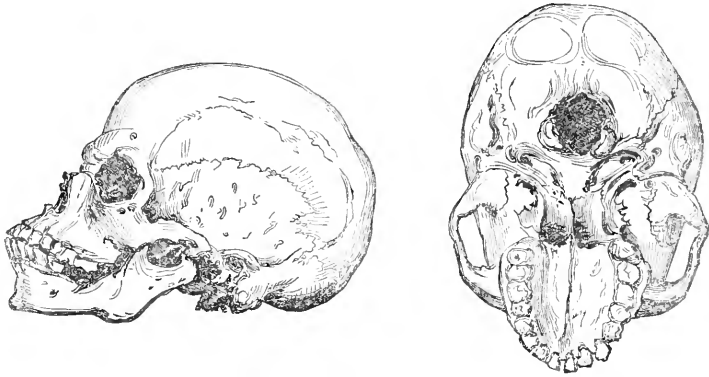

Profile and basal views of the prognathous skull of a Negro.

extension of the jaws. This character is most strongly marked in the Negroes of the Gold Coast, whose skulls are usually so formed, as to give the idea of lateral compression. The temporal muscles have a great extent, rising high on the parietal bones; the cheek-bones project forward, and not outward; the upper jaw is lengthened and projects forwards, giving a similar projection to the alveolar ridge and to the teeth; and the lower jaw has somewhat of the same oblique projection, so that the upper and lower incisor teeth are set at an obtuse angle to each other, instead of being nearly in parallel planes, as in the European. From the shape of the upper jaw alone, would result a marked diminution in the facial angle, measured according to the method of Camper; but this diminution is far from being sufficient to approximate the Ethiopian races to the higher Apes, as some have supposed it to be. For, whilst the average facial angle of the European may be stated at 80° , and that of the Negro at 70° , that of the *adult* Chimpanzee is only 35° , and that of the adult Orang only 30° .* Independently of the diminution of the facial angle, resulting from the projection of the upper jaw, it is quite certain that, in the typical prognathous skull, there is a want of elevation of the forehead; but it does not appear that there is a corresponding diminution in the capacity of the cranial cavity, the retreating form of the forehead being partly due to the general elongation of the skull in the antero-posterior direction. Nor is it true, as stated by some, that the position of the foramen magnum in the Negro is decidedly behind that, which it holds in the European,—in this respect approaching that of the Apes (§ 51): since, if due allowance

* The different statements made by some writers, who have estimated the facial angle of the higher Apes at from 60° to 64° , are due to the measurements having been made upon *young* skulls; the projection of the jaws, in these animals, undergoing an extraordinary increase at the time of the second dentition.

be made for the projection of the upper jaw, this aperture is found to have the same position in the prognathous skull as in the oval one, namely, exactly behind the transverse line bisecting the antero-posterior diameter of the base of the cranium. The prognathous skull is further remarkable for the large development of the parts connected with the organs of sense, especially those of smell and hearing. The aperture of the nostrils is very wide; and the internal space allowed for the expansion of the Schneiderian membrane, and for the distribution of the olfactory nerve, is much larger than in most European heads. The posterior openings of the nasal cavity are not less remarkable for their width than the anterior. The external auditory meatus is also peculiarly wide and spacious; and the orbital cavities have been thought to be of more than ordinary capacity,—but this last is by no means a constant character.

85. A second shape of the head, very different from the preceding, belongs

Fig 8.

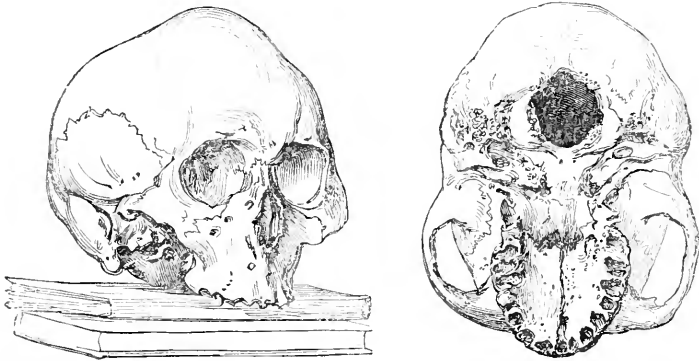

Front and basal views of the pyramidal skull of an Esquimaux.

principally to the nomadic races, who wander with their herds and flocks over vast plains; and to the tribes who creep along the shores of the Icy Sea, and live partly by fishing, and in part on the flesh of their reindeer. This form, designated by Dr. Prichard as the *pyramidal*, is typically exhibited by various nations of Northern and Central Asia; and is seen in an exaggerated degree, in the Esquimaux. Its most striking character is the lateral or outward projection of the zygoma, which is due to the form of the malar bones. These do not project forwards and downwards under the eyes, as in the prognathous skull; but take a direction laterally or outwards, forming, with the zygomatic process of the temporal bone, a large rounded sweep or segment of a circle. From this, in connection with the narrowness of the forehead, it results, that lines drawn from the zygomatic arches, touching the temples on either side, instead of being parallel (as in Europeans), meet over the forehead, so as to form with the basis a triangular figure. The upper part of the face being remarkably flat, the nose also being flat, and the nasal bones, as well as the space between the eyebrows, being nearly on the same plane with the cheek-bones, the triangular space bounded by these lines may be compared to one of the faces of a pyramid. The orbits are large and deep; and the peculiar conformation of the bones which surround it, gives to the aperture of the lids an appearance of obliquity,—the inner angle seeming to be directed downwards. The whole face, instead of presenting an oval form, as in most Europeans and Africans, is of a lozenge-shape. The greater relative develop-

ment of the zygomatic bones, and of the bones of the face altogether, when compared with the capacity of the cranium, indicates in the pyramidal skull a more ample extension of the organs subservient to sensation; the same effect being thus produced by lateral expansion, as by the forward extension of the facial bones in the prognathous skulls.

86. The most civilized races,—those which live by agriculture and the arts of cultivated life,—all the most intellectually-improved nations of Europe and Asia, have a shape of the head, which differs from both the preceding forms,

Fig. 9.

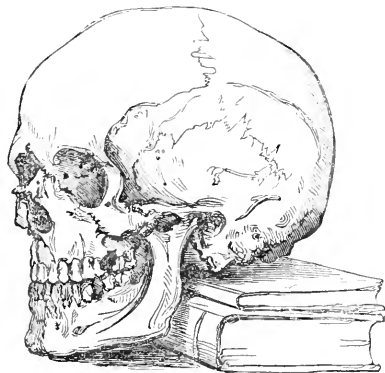

Oval skull of a European.

and which may be termed *oval* or *elliptical*. This at once approves itself as a more symmetrical form; no part having an excessive prominence; whilst on the other hand, there is nowhere an appearance of undue flattening or compression. The head is altogether of a rounder shape than in other varieties; and the forehead is more expanded; while the maxillary bones and the zygomatic arches are so formed, as to give the face an oval shape, nearly on a plane with the forehead and cheek-bones, and not projecting towards the lower part. Owing to the more perpendicular direction of the alveolar processes, the front teeth are fixed in planes, which

are nearly or quite parallel to each other. The principal features in this form of cranium are thus of a negative character; the chief positive distinction is the large development of the cranial cavity, and especially the fullness and elevation of the forehead, in proportion to the size of the face;—indicating the predominance of the intellectual powers over those merely instinctive propensities, which are more directly connected with sensations. Among European nations, the Greeks have probably displayed the greatest symmetry and perfection in the form of the head; but various departures may be traced, towards the preceding forms, when we compare the crania of different races, and even of individuals, belonging to the same stock,—some approaching the pyramidal form of the Northern Asiatics, whilst others approximate to the prognathous type of the Negro.

87. The influence of habits of life, continued from generation to generation, upon the form of the head, is remarkably evinced by the transition from one type to another, which may be observed in nations that have undergone a change in their manners, and customs, and have made an advance in civilization. Thus, to mention but one instance, the Turks at present inhabiting the Ottoman and Persian empires, are undoubtedly descended from the same stock with the nomadic races, which are still spread through Central Asia. The former, however, having conquered the countries which they now inhabit, eight centuries since, have gradually settled down to the fixed and regular habits of the Indo-European race, and have made corresponding advances in civilization; whilst the latter have continued their wandering mode of life, and can scarcely be said to have made any decided advance during the same interval. Now, the long-since civilized Turks have undergone a complete transformation into the likeness of Europeans; whilst their nomadic relatives retain the pyramidal configuration of the skull in a very marked degree. Some have attributed this change in the physical structure of the Turkish race, to the introduction of Circassian slaves into the harems of the Turks; but this

could only affect the opulent and powerful amongst the race; and the great mass of the Turkish population have always intermarried among themselves. The difference of religion and manners must have kept them separate from those Greeks whom they subdued in the new Ottoman countries; and in Persia, the Tajiks, or real Persians, still remain quite distinct from their Turkish rulers, belonging to a different sect among the Mussulmans, and commonly living apart from them. In like manner, even the Negro head and face may become assimilated to the European, by long subjection to similar influences; thus, in some of our older West Indian Colonies, it is not uncommon to meet with Negroes,—the descendants of those first introduced there,—who exhibit a very European physiognomy; and it has even been asserted that a Negro belonging to the Dutch portion of Guiana, may be distinguished from another belonging to the British settlements, by the similarity of his features and expression to those which peculiarly characterize his masters. The effect could not be here produced by the intermixture of bloods, since this would be made apparent by alteration of colour.

88. Next to the characters derived from the form of the head, those which are founded upon the form of the *pelvis* seem entitled to rank. These have been particularly examined by Professors Vrolik and Weber. The former concluded from his examinations of this part of the skeleton, that the pelvis of the Negress, and still more that of the female Hottentot, approximates to that of the Simiæ in its general configuration; especially in its length and narrowness,—the iliac bones having a more vertical position, so that the anterior spines approach one another much more closely than they do in the European; and the sacrum also being longer and narrower. On the other hand, Prof. Weber concludes, from a more comprehensive survey, that no particular figure is a permanent characteristic of any one race. He groups the principal varieties which he has met with, according to the form of the upper opening,—whether oval, round, four-sided, or wedge-shaped. The first of these is most frequent in the European races; the second, among the American races; the third, most common among the Mongolian nations, corresponds remarkably with the form of their heads; whilst the last chiefly occurs among the races of Africa, and is in like manner conformable with the oblong compressed form usually presented by their cranium. But though there are particular shapes which are most prevalent in each race, yet there are numerous individual deviations; of such a nature, that every variety of form presents itself occasionally in any given race.

89. Other variations have been observed by anatomists, in the relative length of the bones, and in the shape of the limbs, between the different races of Man; but these also seem to have reference to the degree of civilization, and to the regularity of the supply of wholesome nutriment. It is generally to be observed, that the races least improved by civilization, like the uncultivated breeds of animals, have slender, lean, and elongated limbs; this may be especially remarked in the natives of Australia. In nearly all the less civilized races of Men, the limbs are more crooked and badly formed than the average of those of Europeans; and this is particularly the case in the Negro, the bones of whose legs bow outwards, and whose feet are remarkably flat. It has been generally believed, that the length of the forearm in the Negro is so much greater than in the European, as to constitute a real character of approximation to the Apes. The difference, however, is in reality extremely slight; and is not at all comparable with that which exists between the most uncultivated races of Men and the highest Apes (§ 54). And in regard to all the peculiarities here alluded to, it is to be observed, that they can only be discovered by the comparison of large numbers of one race with corresponding numbers of another; for individuals are found in every tribe, possessing

the characters which distinguish the majority of the other race. Any such peculiarities, therefore, are totally useless as the foundation of *specific* characters; being simply variations from the ordinary type, resulting from causes which might affect the entire race, as well as individuals.

90. The connection between the general form of the body, on the one hand, and the degree of civilization (involving the regular supply of nutriment) on the other, is made apparent, not merely by the improvement which we perceive in the form, development, and vigour of the frame, as we advance from the lowest to the most cultivated of the Human races; but also by the degradation which is occasionally to be met with in particular groups of the higher tribes, which have been subjected for several generations to the influence of depressing causes. Of this class of facts, the following is a very interesting example:—"On the plantation of Ulster, and afterwards on the successes of the British against the rebels of 1641 and 1689, great multitudes of the native Irish were driven from Armagh and the south of Down, into the mountainous tract extending from the barony of Flews eastward to the sea:—on the other side of the kingdom, the same race were expelled into Leitrim, Sligo and Mayo. Here they have been almost ever since, exposed to the worst effects of hunger and ignorance, the two great brutalizers of the human race. The descendants of these exiles are still readily distinguishable from their kindred in Meath, and in other districts where they are not in a state of physical degradation; being remarkable for open projecting mouths, with prominent teeth and exposed gums; their advancing cheek-bones and depressed noses bearing barbarism on their very front. In Sligo and northern Mayo, the consequences of two centuries of degradation and hardship exhibit themselves in the whole physical condition of the people; affecting not only the features, but the frame, and giving such an example of human deterioration from known causes, as almost compensates, by its value to future ages, for the suffering and debasement which past generations have endured in perfecting its appalling lesson. Five feet two inches upon an average, pot-bellied, bow-legged, abortively-featured, their clothing a wisp of rags,—these spectres of a people, that were once well-grown, able-bodied, and comely, stalk abroad into the daylight of civilization, the annual apparitions of Irish ugliness and Irish want. In other parts of the island, where the population has never undergone the influence of the same causes of physical degradation, it is well known that the same race furnishes the most perfect specimens of human beauty and vigour, both mental and bodily."*

91. From the foregoing survey of the phenomena, bearing upon the question of the *specific* unity or diversity of the Human races, the following conclusions may be drawn:—

I. That the physical constitution of Man is peculiarly disposed, like that of the domesticated animals, to undergo variations; some of which can be traced to the influence of external causes; whilst others are not so explicable, and must be termed spontaneous.

II. That the extreme variations which present themselves, between the races apparently the most removed from one another, are not greater in *degree* than those which exist between the different breeds of domesticated animals, which are known to have descended from a common stock; and that they are of the same *kind* with the variations which present themselves in any one race of Mankind,—the difference of *degree* being clearly attributable, in the majority of cases, to the respective conditions under which each race exists.

III. That none of the variations, which have been pointed out as existing

* See Dublin University Magazine, No. XLVIII.

between the different races of mankind, have the least claim to be regarded as valid specific distinctions; being entirely destitute of that fixity, which is requisite to entitle them to such a rank; and exhibiting, in certain groups of each race, a tendency to pass into the characters of some other.

IV. That, in the absence of any valid specific distinctions, we are required, by the universally-received principles of zoological science, to regard all the races of Mankind as belonging to the same species, or (in other words) as having had either an *identical* or *similar* parentage; and that this conclusion is supported by the positive evidence, afforded by the agreement of all the races in the physiological and psychological characters, that most distinguish them from other species, and especially by the ready propagation of mixed breeds or hybrid races.

7. *Principal Branches of the Human Family.*

92. The above conclusions are found to be in entire accordance with those derived from an examination of the relative affinities of the different races of Men at present existing; as far as these are deducible from the analogies of their language, from their correspondence in peculiar habits and observances, and from traditional or other evidence in regard to their original sources. For it appears, from such investigations, that very great difference in colour, texture of the hair, form of the skull, and other important physical characters, exist among nations, which may be referred with great confidence to a common source; whilst on the other hand, we find traits of physical resemblance, in tribes which exist under corresponding circumstances in remote parts of the world, and which seem to have nothing else in common. It has been attempted by Blumenbach and Cuvier to arrange the different races of Men under five principal varieties; the Caucasian, Mongolian, Ethiopian, Malay, and American. But, for the reason just given, it is impossible to establish any constant distinguishing characters, which shall serve to mark these clearly out; and it moreover appears that several additional groups must be created, for the reception of tribes, that differ as much from the preceding as these do from each other. In the following brief enumeration, the views of Dr. Prichard will be adopted.

93. The *Caucasian* variety of Blumenbach and Cuvier was so named from the idea, that the Caucasian range of mountains might be regarded as the centre or focus of the races belonging to it; and that the Caucasian people present the typical conformation of the variety in the most perfect degree. Neither of these ideas are correct, however; and some other designation might very properly be substituted for that which conveys them. In this variety are presented all the characters of highest physical perfection of the race, such as were, perhaps, most pre-eminently combined among the Ancient Greeks; as well as those of intellectual and moral elevation. No uniformity exists, however, as to colour; for this character presents every intermediate gradation, from the fair and florid hue of the Northern Europeans, to the jet black of many tribes in North Africa and Hindustan. The hair is generally long and flexible; but departures from the ordinary type present themselves in this respect, also, both among individuals and among whole tribes. Although there is general agreement in these characters among the nations of South-Western Asia, Northern Africa, and nearly the whole of Europe, yet we are required by the evidence of ancient history, as well as by the characters derived from language, to separate these nations into two groups; which appeared to have been distinct from each other at the earliest period of which we have any traces; and which we must regard, therefore, as alike entitled to rank as primary branches of the human family. These are the Syro-Arabian, and the Indo-European groups of nations.

94. The *Syro-Arabian* nations, distinguished from all others by their very peculiar idiom, originally inhabited the region of Asia intermediate between the countries of the Indo-European and of the Egyptian races; having as its centre the region watered by the great rivers of Mesopotamia. Several of the nations originally constituting this group have become extinct, or nearly so; and the Arabs, which originally formed but one subdivision of it, have now become the dominant race, not only throughout the ancient domain of the Syro-Arabian nations, but also in Northern Africa. In the opinion of Baron Larrey, who had ample opportunities for observation, the skulls of the Arabian race furnish, at present, the most complete type of the human head; and he considered the remainder of the physical frame as equally distinguished by its superiority to that of other races of men. The different tribes of Arabs present very great diversities of colour, which are generally found to coincide with variations in climate. Thus the Shegya Arabs, and others living on the low countries bordering on the Nile, are of a dark-brown or even black hue; but even when quite jetty, they are distinguished from the Negro races by the brightness of their complexions, by the length and straightness of their hair, and by the regularity of their features. The same may be said of the wandering Arabs of Northern Africa; but the influence of climate and circumstances is still more strongly marked in some of the tribes long settled in that region, whose descent may be traced to a distinct branch of the Syro-Arabian stock, namely, the *Berber*, to which belong the Kabyles of Algiers and Tunis, the Tuaryks of Sahara, and the Guanches or ancient population of the Canary Isles. Amongst these tribes, whose affinity is indisputably traceable through their very remarkable language, every gradation may be seen, from the intense blackness of the Negro skin, to the more swarthy hue of the inhabitants of the South of Europe. It is remarkable that some of the Tuaryk inhabitants of particular Oases in the great desert, who are almost as insulated from communication with other races as are the inhabitants of islands in a wide ocean, have hair and features that approach those of the Negroes; although they speak the Berber language with such purity, as to forbid the idea of the introduction of these characters by an intermixture of races. The Jews, who are the only remnants now existing of the once powerful Phœnician tribe, and who are now dispersed through nearly every country on the face of the earth, present a similar diversity; having gradually assimilated in physical characters to the nations among which they have so long resided (§ 80).

95. The affinity of the *Indo-European* nations, now spread from the mouth of the Ganges to the British Islands and the Northern extremity of Scandinavia, is in like manner proved by the cognate character of their languages; in spite of the differences in colour and other traits, which present themselves among the inhabitants of that vast tract. The type of physical configuration, however, is the same; and the differences of colour are such, as may readily be traced to external agencies. Thus among the Hindoo races we find that the distinction of castes (perpetuating the same mode of life in particular families from generation to generation), the marked differences of climate (as between the mountainous regions of Kashmir and Kafiristan, and the plains bordering the great rivers of India), and other circumstances, are accompanied, as in the case of the Arabian race, with diversities in physical conformation, which are now established as belonging to different sections of the people. In many instances, the origin of these varieties can be clearly traced by historical evidence, as well as by affinities of language and conformation; and it cannot be questioned, that Hindoos as black as Negroes, others of a copper-colour, others little darker than the inhabitants of Southern Europe, and others of fair complexion with blue eyes and auburn or even red

hair, have all had a common parentage; some having become darker, and others lighter than their ancestors, generally in accordance with changes in their residence and habits. This group seems to have been early divisible into two primary branches; the northern or *Median*; and the southern or *Indian*. Between the original languages of these races, a marked resemblance can be traced; and the traditions of both races point to contiguous regions as their original seat,—the earliest records of the Persians indicating that they migrated westwards from a spot in the ancient Bactria, not far from Balkh, to the westward of the Indus; whilst the traditions of the Brahmans refer the origin of the Hindoos to the north-western part of the country lying between the Himalaya and the Vindhya mountains, whence they afterwards moved eastwards and southwards into the Peninsula. Both these races appear to have migrated in a north-westerly direction, at a period long preceding our earliest knowledge of European history; for the European languages present indications of affinity to the ancient languages of both Medians and Indians. The classical languages of Greece and Italy appear more referrible to the *Sanskrit* or ancient Indian, than to the *Zend* or ancient Median; whilst, on the other hand, the Germanic languages would seem to have originated rather in the latter. Of all the extant European dialects, the Lettish and Lithuanian approach most nearly to the ancient type.

a. It may be well to notice here, the nature of the evidence on which statements of this kind are grounded. The extensive and profound inquiries which have been in progress for many years, have enabled Philologists to distinguish, usually with little difficulty, between the *intermixture* of languages, which may arise from the intercourse of any two nations that happen to be connected by local proximity, commercial intercourse, &c.; and that fundamental correspondence, which indicates *original affinity*. The latter is to be sought rather in the analogies of grammatical structure, and in the laws of combination, or the mechanism of speech, than in the vocabulary; and it sometimes happens that a relationship may thus be traced between languages, which have scarcely a single word in common. The most satisfactory evidence, however, is derived from resemblance in those parts of the vocabulary, which serve to represent the ideas of a people in the most simple state of existence;—such as terms expressive of family relations; names for the most striking objects of the visible universe; terms distinguishing different parts of the body; nouns of number, up to 5, 10, or 20; verbs descriptive of the most common sensations and bodily acts, such as seeing, hearing, eating, drinking, and sleeping. As no nation was ever found destitute of similar expressions; and as we know by the observation of facts, in addition to abstract probability, that tribes however rude, do not exchange their own stock of primitive words for those of a foreign idiom; it may be inferred that dialects, which correspond in those parts of their vocabulary, were originally one speech, or the language of one people.

b. It has been fully demonstrated, that *both* these indications of affinity or family relationship exist between the languages of the several races, from which the great mass of the population of Europe is derived; and, further, that this affinity not only unites them with each other, but connects them all with the common Eastern stock.

96. The second primary division of the human family, according to the usual arrangement, is that commonly termed *Mongolian*. The real Mongoles, however, constitute but a single and not very considerable member of the group of nations associated under this designation; which is, therefore, by no means an appropriate one. The original seat of these races appears to have been the great central elevated plain of Asia, in which all the great rivers of that continent have their sources, whatever may be their subsequent direction. Taken as a whole, this division of the human family is characterized by the pyramidal form of the skull, and by a xanthous or olive complexion; but these characters are only exhibited, in a prominent degree, in the more typical members of the group, and may become so greatly modified as to cease altogether to be recognizable. This has been remarkably the case with regard to the Turkish people, now so extensively distributed. All the most learned writers on Asiatic history are agreed in opinion, that the Turkish

racés are of one common stock ; although at present they vary in physical characters, to such a degree that, in some, the original type has been altogether changed. Those which still inhabit the ancient abodes of the race, and preserve their pastoral nomadic life, present the physiognomy and general characteristics which appear to have belonged to the original Turkomans ; and these are decidedly referrible to the so-called Mongolian type. Before the Mohammedan era, however, the Western Turks or Osmanlis had adopted more settled habits, and had made considerable progress in civilization ; and their adoption of the religion of Islam incited them to still wider extension, and developed that spirit of conquest, which, during the middle ages, displayed itself with such remarkable vigour. The branches of the race, which, from their long settlement in Europe, have made the greatest progress in civilization, now exhibit in all essential particulars the physical characters of the European model ; and these are particularly apparent in the conformation of the skull.—In like manner we find that the Ugorian division, which migrated towards the northwest at a very early period, planted a colony in Europe, which still tenants the Northern Baltic countries, forming the races of Fins and Lappes. In the time of Tacitus, the Fins were as savage as the Lappes ; but the former, during the succeeding ages, became so far civilized, as to exchange a nomadic life for one of agricultural pursuits, and have gradually assimilated with the surrounding people ; whilst the Lappes, like the Siberian tribes of the same race, have ever since continued to be barbarous nomades, and have undergone no elevation in physical characters. The same division gave origin to the Magyars or Hungarians ; a warlike and energetic people, unlike their kindred in the North ; in whom a long abode in the centre of Europe has, in like manner, developed the more elevated characters, physical and mental, of the European nations. The nations inhabiting the south-eastern portion of Asia, also, appear to have had their origin in the Mongolian or Central Asiatic stock ; although their features and form of skull by no means exhibit its characteristic marks, but present such departures from it as are elsewhere observable in races that are making advances in civilization. Even the great peninsula of Hindostan appears to have been peopled, long previously to the settlement of the present Hindoo race, by tribes of the Central Asiatic stock, so distinguished by its migratory propensities ; and remains of these aborigines are still found in the hilly parts of Northern India, in the Dekhan, and in Ceylon, constituting numerous tribes, which are now for the most part isolated from each other, and which exhibit very different degrees of civilization.

97. According to the usual mode of dividing the Human family, the *Ethiopian* or *Negro* stock is made to include all the nations of Africa, to the southward of the Atlas range. But there is good reason for separating the Hottentots and Bushmen as a distinct race ; and for restricting the designation of Negroes to the nations inhabiting the region southward of the Great Desert, as far as the Hottentot country,—the inhabitants of the oases of the desert itself being mostly, as already pointed out, of Syro-Arabian origin, although assimilating closely to the Negro race in physical characters. The nations thus in geographical proximity with each other, are found to have sufficient affinities of language, to justify the belief in their common origin ; and they all present, in a more or less evident degree, the physical peculiarities of the Negro race. But these are far from constituting a sufficient ground for regarding the African nations as a distinct race, separated from all other families of men by a broad and definite line of demarcation. Our idea of the Negro character is principally founded upon that division of the people which inhabits the low countries of the Western part of Central Africa, and in which the Negro peculiarities are most strongly marked. There are very few nations

which present in a high degree *all* the characters that are commonly regarded as typical of the Negro; these being generally distributed among different nations in various ways; and being combined, in each instance, with more or fewer of the characters belonging to the European or Asiatic. Thus the race of Jolofs near the Senegal, and the Guber in the interior of Sudan, have woolly hair and deep black complexions, but fine forms and regular features of a European cast; and nearly the same may be said of the darkest of the Kafirs of Southern Africa. The Bechuna Kafirs present a still nearer approach to the European type; the complexion being of a light brown, the hair often not woolly but merely curled, or even in long flowing ringlets, and the figure and features having much of the European character. The nations of the northeast of Africa, also, present similar departures from the typical characters of the Negro.

98. There is no group which presents a more constant correspondence between external conditions and physical conformation, than that composed of the African nations. As we find the complexion becoming gradually darker, in passing from northern to southern Europe, thence to North Africa, thence to the borders of the Great Desert, and thence to the intertropical region where alone the dullest black is to be met with,—so do we find, on passing southwards from this, that the hue becomes gradually lighter in proportion as we proceed further from the equator, until we meet with races of comparatively fair complexions among the nations of Southern Africa. Even in the intertropical region, high elevations of the surface have the same effect, as we have seen them produce elsewhere, in lightening the complexion. Thus, the high parts of Senegambia, where the temperature is moderate and even cool at times, are inhabited by Fulahs of a light copper colour; whilst the nations inhabiting the lower regions around them, are of true Negro blackness; and nearly on the same parallel, but at the opposite side of Africa, are the high planes of Enarea and Kaffa, where the inhabitants are said to be fairer than the natives of Southern Europe. Again, those races which have the Negro character in an exaggerated degree, and which may be said to approach to deformity in persons,—the ugliest blacks, with depressed forehead, flat noses, and crooked legs,—are in most instances inhabitants of low countries, often of swampy tracts near the sea-coast, where many of them have scarcely any other means of subsistence than shell-fish and the accidental gifts of the sea. Such tribes are uniformly in the lowest stage of society, being either ferocious savages, or stupid, sensual, and indolent. Such are most of the tribes along the Slave Coast. On the other hand, wherever we hear of a Negro state, the inhabitants of which have attained any considerable degree of improvement in their social condition, we constantly find that their physical characters deviate considerably from the strongly-marked or exaggerated type of the Negro. Such are the Ashanti, the Sulima, and the Dahomans of Western Africa; also the Guber of Central Sudan, among which a considerable degree of civilization has long existed, which are perhaps the finest race of genuine Negroes on the whole continent, and which present in their language distinct traces of original relationship to the Syro-Arabian nations, not to be accounted for by any subsequent intermixture of races.

99. The highest civilization, and the greatest improvement in physical characters, are to be found in those nations, which have adopted the Mohammedan religion; this was introduced, three or four centuries since, into the eastern portion of Central Africa; and it appears that the same people, which were then existing in the savage condition still exhibited by the pagan nations further south, have now adopted many of the arts and institutions of civilized society, subjecting themselves to governments, practising agriculture, and dwelling in towns of considerable extent, many of which contain 10,000, and

some even 30,000 inhabitants; a circumstance which implies a considerable advancement in industry, and in the resources of subsistence. This last fact affords most striking evidence of the *improvability* of the Negro races; and, taken in connexion with the many instances that have presented themselves, of the advance of individuals, under favourable circumstances, to at least the average degree of mental development among the European nations, it affords clear proof that the line of demarcation, which has been supposed to separate them intellectually and morally from the races that have attained the greatest elevation, has no more *real* existence than that, which has been supposed to be justified by a difference in physical characters, and of which the fallacy has been demonstrated.

100. The *Bushmen* or *Bojesmen* of South Africa are generally regarded as presenting the most degraded and miserable condition, of which the human race is capable: and they have been supposed to present resemblances in physical characters to the higher Quadrumana. Yet there is distinct evidence, that this degraded race is but a branch or subdivision of the once extensive nation of *Hottentots*; and that its present condition is in great part due to the hardships, to which it has been subjected in consequence of European colonization. This race differs from all other South African nations, both in language and in physical conformation. The language cannot be shown to possess affinities with those of any other stock; but in bodily structure there is a remarkable admixture of the characters of the Mongolian with those of the Negro. Thus the face presents the very wide and high cheek-bones, with the oblique eyes and flat nose, of the Northern Asiatics; at the same time that, in the somewhat prominent muzzle and thick lips, it resembles the countenance of the Negro. The complexion is of a tawny buff or fawn colour, like that of the Negroes diluted with the olive of the Mongoles. The hair is woolly like that of the Negroes, but it grows in small tufts, scattered over the surface of the scalp, instead of covering it uniformly, resembling in its comparative scantiness that of the Northern Asiatics. It is most interesting to observe this remarkable resemblance in physical characters, between the *Hottentots* and the Mongolian races; in connexion with the similarity that exists between the circumstances under which they respectively live. No two countries can be more similar, than the vast steppes of Central Asia, and the karroos of Southern Africa. And the inhabitants of each were nomadic races, wandering through deserts remarkable for the wide expansion of their surface, their scanty herbage, and the dryness of their atmosphere, and feeding upon the milk and flesh of their horses and cattle. Of the original pastoral *Hottentots*, however, very few now remain. They have been gradually driven, by the encroachments of European colonists and by internal wars with each other, to seek refuge among the inaccessible rocks and deserts of the interior; and they have thus been converted from a mild unenterprising race of shepherds, into wandering hordes of fierce, suspicious, and vindictive savages, treated as wild beasts by their fellow-men, until they become really assimilated to wild beasts in their habits and dispositions. This transformation has taken place under the observation of eye-witnesses, in the *Koranas*, a tribe of *Hottentots* well known to have been previously the most advanced in all the improvements which belong to pastoral life. Having been plundered by their neighbours and driven out into the wilderness to subsist upon fruits, they have adopted the habits of the *Bushmen*, and have become assimilated in every essential particular to that miserable tribe.

101. The *American* nations, taken collectively, form a group which appears to have existed as a separate family of nations from a very early period in the world's history. They do not form, however, so distinct a variety, in regard to physical characters, as some anatomists have endeavoured to prove;

for, although certain peculiarities have been stated to exist in the skulls of the aboriginal Americans, yet it is found, on a more extensive examination, that these peculiarities are very limited in their extent,—the several nations spread over this vast continent differing from each other in physical peculiarities, as much as they do from those of the Old World, so that no typical form can be made out among them. In regard to complexion, again, it may be remarked, that although the native Americans have been commonly characterized as “red men,” they are by no means invariably of a red or coppery hue, some being as fair as many European nations, others being yellow or brown, and others nearly, if not quite, as black as the Negroes of Africa; whilst, on the other hand, there are tribes equally red, and perhaps more deserving that epithet in Africa and Polynesia.—In spite of all this diversity of conformation, it is believed that the structure of their languages affords a decided and clearly-marked evidence of relationship between them. The words, and even the roots, may differ entirely in the different groups of American nations; but there is a remarkable similarity in grammatical construction amongst them all, which is of a kind not only to demonstrate their mutual affinity, but to separate them completely from all known languages of the old continent. Notwithstanding also their diversities in mode of life, there are peculiarities of mental character, as well as a number of ideas and customs derived from tradition, which seem to be common to them all, and which for the most part indicate a former elevation in the scale of civilization, that has left its traces among them even in their present degraded condition, and that still distinguishes them from the sensual, volatile, and almost animalized savages, that are to be met with in many parts of the Old Continent.—The Esquimaux constitute an exception to all general accounts of the physical characters of the American nations; for in the configuration of their skulls, in their complexion, and in their general physiognomy, they conform to the Mongolian type, even presenting it in an exaggerated degree. Their wide extension along the whole northern coast of America, and the near proximity of this coast to Kamschatka, certainly lend weight to the idea, that they derive their origin from the Northern Asiatic stock; but, on the other hand, they have a marked affinity, in regard to language, to the other American nations. The Athapascan Indians, various tribes of which inhabit the country south of the Esquimaux country, seem intermediate in physical characters, as they are in geographical position, between the Esquimaux and the ordinary Americans. They have a tradition which seems to indicate, that they are derived from the North-Eastern Asiatics, with whom they have many points of accordance in dress and manners.

102. It now remains for us to notice the *Oceanic* races, which inhabit the vast series of islands scattered through the great ocean, that stretches from Madagascar to Easter Island. There is no part of the world, which affords a greater variety of local conditions than this, or which more evidently exhibits the effects of physical agencies on the organization of the human body. Moreover, it affords a case for the recognition of affinities by means of language, that possesses unusual stability; since the insulated position of the various tribes, that people the remote spots of this extensive tract, prevents them from exercising that influence upon each others' forms of speech, which is to be observed in the case of nations united by local proximity or by frequent intercourse. Tried by this test, it is found that the different groups of people, inhabiting the greater part of these insular tracts, are more nearly connected together, although so widely scattered, and so diverse in physical characters, than most of the families of men, occupying continuous tracts of land on the great continents of the globe. The inhabitants of Oceanica seem divisible into three groups, which are probably to be regarded as having con-

stituted distinct races from a very early period; these are the Malayo-Polynesian race, the Pelagian Negroes (commonly termed Papuas), and the Alforas or Alfourous.

103. The *Malayo-Polynesian* group is by far the most extensive of the three, and comprehends the inhabitants of the greater part of the Indian and Polynesian Archipelagoes, with the peninsula of Malacca (which is the centre of the Malays proper), and the inhabitants of Madagascar. These are all closely united by affinities of language. The proper Malays bear a strong general resemblance to the Mongolian races, and this resemblance is shared, in a greater or less degree, by most of the inhabitants of the Indian Archipelago. They are of a darker complexion, as might be expected from their proximity to the equator; but in this complexion, yellow is still a large ingredient. The Polynesian branch of the group presents a much wider diversity; and if it were not for the community of language, it might be thought to consist of several races, as distinct from each other as from the Malayan branch. Thus the Tahitians and Marquesans are tall and well-made; their figures combine grace and vigour: their skulls are usually remarkably symmetrical; and their physiognomy presents much of the European cast, with a very slight admixture of the features of the Negro. The complexion, especially in the females of the higher classes, who are sheltered from the wind and sun, is of a clear olive or brunette, such as is common among the natives of Central and Southern Europe; and the hair, though generally black, is sometimes brown or auburn, or even red or flaxen. Among other tribes, as the New Zealanders, and the Tonga, and Friendly Islanders, there are greater diversities of conformation and hue; some being finely proportioned and vigorous, others comparatively small and feeble; some being of a copper-brown colour, others nearly black, others olive, and others almost white. In fact, if we once admit a strongly-marked difference in complexion, features, hair, and general configuration, as establishing a claim to original distinctness of origin, we must admit the application of this hypothesis to almost every group of islands in the Pacific;—an idea of which the essential community of language seems to afford a sufficient refutation. Among the inhabitants of Madagascar, too, all of which speak dialects of the same language, some bear a strong resemblance to the Malayan type, whilst others present approaches to that of the Negro.

104. The *Pelagian-Negro* races must be regarded as a group altogether distinct from the preceding; having a marked diversity of language; and presenting more decidedly than any of the Malayo-Polynesians, the characters of the Negro type. They form the predominating population of New Britain, New Ireland, the Louisiade and Solomon Isles, of several of the New Hebrides, and of New Caledonia; and they seem to extend westwards into the mountainous interior of the Malayan Peninsula, and into the Andaman Islands, in the Bay of Bengal. The Tasmanians, or aborigines of Van Dieman's Land, which are now almost completely exterminated, undoubtedly belonged to this group. Very little is known of them, except through the reports of the people of Malayo-Polynesian race inhabiting the same islands; but it appears that, generally speaking, they have a very inferior physical development, and lead a savage and degraded life. There is considerable diversity of physical characters among them; some approximating closely in hair, complexion, and features, to the Guinea-Coast Negroes; whilst others are of yellower tint, straight hair, and better general development. The *Papuas*, who inhabit the northern coast of New-Guinea, and some adjacent islands, and who are remarkable for their large bushy masses of half-woolly hair, have been supposed to constitute a distinct race; but there is little doubt that they are of hybrid descent, between the Malays and the Pelagian Negroes.

105. Still less is known of the *Alfourous*, or *Alforian* race, which are considered by some to be the earliest inhabitants of the greater part of the Malayan Archipelago, and to have been supplanted by the more powerful people of the two preceding races, who have either extirpated them altogether, or have driven them from the coasts into the mountainous and desert parts of the interior. They are yet to be found in the central parts of the Moluccas and Philippines; and they seem to occupy most of the interior and southern portion of New Guinea, where they are termed Endamenes. They are of very dark complexion; but their hair, though black and thick, is lank. They have a peculiar repulsive physiognomy; the nose is flattened, so as to give the nostrils an almost transverse position; the cheek-bones project; the eyes are large, the teeth prominent, the lips thick, and the mouth wide. The limbs are long, slender and misshapen. From the close resemblance in physical characters, between the Endamenes of New Guinea, and the aborigines of New Holland, and from the proximity between the adjacent coasts of these two large islands, it may be surmised that the latter belong to the Alforian race; but too little is known of the language of either, to give this inference a sufficient stability. In the degradation of their condition and manner of life the savages of New Holland fully equal the Bushmen of South Africa; and it is scarcely possible to imagine human beings, existing in a condition more nearly resembling that of brutes. But there is reason to believe, that the tribes in closest contact with European settlers are more miserable and savage than those of the interior; and even with respect to these, increasing acquaintance with their language, and a consequent improved insight into their modes of thought, tend to raise the very low estimate which had been formed and long maintained, in regard to their extreme mental degradation. The latest and most authentic statements enable us to recognize among them the same principles of a moral and intellectual nature, which, in more cultivated tribes, constitute the highest endowments of humanity, and thus to show that they are not separated, by any impassable barrier, from the most civilized and cultivated nations of the globe.

CHAPTER III.

OF THE ELEMENTARY PARTS OF THE HUMAN FABRIC.

1. *On Organized Structures in General.*

106. THE Human body, in common with the bodies of all the higher Animals, is composed of an immense number of parts, whose structure and whose actions are alike dissimilar; but which are yet so arranged, as to make up a fabric distinguished by its perfect adaptation to a great variety of purposes, whilst their actions, though in a great degree independent of each other, concur in effecting one common object,—the maintenance of the integrity of the entire organism. In the lowest and simplest forms of living being, such as we meet with among the humblest Cellular Plants, we find a single cell making up the whole fabric. This cell grows from its germ, absorbs and assimilates nutriment, converts a part of this into the substance of its own cell-wall, secretes another portion into its cavity, and produces from a third the reproductive germs that are to continue the race; and having reached its own

term of life, and completed the preparation of these germs, it bursts and sets them free,—every one of these being capable, in its turn, of going through the same set of operations. In the highest forms of Vegetable life, we find but a multiplication of similar cells; amongst which these operations are distributed, as it were, by a division of labour; so that, by the concurrent labours of all, a more complete and permanent effect may be produced. If we analyze the structure of a forest tree, for example, we find that all the soft and growing parts are composed of similar cells; whose office it is, to absorb and prepare the nutriment, which is afterwards to be applied to the extension of the solid internal skeleton of the trunk and branches. This latter part is not concerned in the functions of vegetation, in any other way than as supporting and connecting the different groups of cells, which form the operative-part of the fabric; and it is composed of two forms of tissue,—woody-fibre, and vascular tissue.—each of which may be regarded as originating in the metamorphosis of cells (§ 120).

107. At the extremities of the roots of all the more perfect Plants, we find a set of soft cells, making up those succulent bodies which are known as the *spongioles*; these are specially destined to perform the *Absorption* of nutritious fluid. This fluid, being conveyed by the vessels of the stem and branches to the leaves, is there subjected to the action of the cells which make up the parenchyma of those organs. The crude watery ascending sap is thus converted, by a variety of chemical and vital operations, into the thick glutinous latex; which, like the blood of animals, contains the materials for the production of new tissue, and also the elements of the various secretions. This process of conversion includes the *Exhalation* of superfluous liquid; and also that interchange of gaseous ingredients between the sap and the air, which may be termed *Aerution*; but it involves, beside these obvious chemical alterations, a new molecular arrangement of the particles of the sap, by which a variety of new products are generated,—some of them possessing such a tendency to pass into the form of solid organized tissue, as to present a sort of sketch of this, by a process of coagulation, when withdrawn from the living vessels. To this peculiar converting process, which is such an important step towards the production of perfect living tissue from the crude aliments, the term *Assimilation* is applied. As the elaborated sap or latex descends in its proper vessels through the stem, it yields up to the growing parts the nutrient materials they respectively require. These growing parts may be either the ordinary tissues, of which the chief part of the fabric is composed, and which are destined to a comparative permanency of duration; and in the growth and extension of these, the process of *Nutrition* is commonly regarded as consisting. On the other hand, certain groups of cells have for their office the separation of peculiar products from the sap, such as oil (fixed or essential), starch, resin, &c.; which they store up against the time when they may be demanded; and these are said to perform the act of *Secretion*. In both cases, however, the act is essentially the same; for the process of *Secretion*, like that of *Nutrition*, consists in the growth of a cellular tissue, and the difference consists only in the destination of the contents of the cells; which, in the one case, are adapted merely to give firmness and solidity to their walls; whilst, in the other, they are set apart for some other purpose, to be given up again when required.

108. It is very important to remark, in regard to all the cells thus actively concerned in the Vegetative functions, by which the development and extension of the permanent fabric is provided for, that they have but a very transitory life as individuals. The Absorbent cells at the extremities of the rootlets are continually being renewed; some of the old ones dying and decaying away, whilst others are converted into the solid texture of the root, and thus

contribute to its progressive elongation. Of the transitory duration of the Assimilating cells, we have an obvious proof in the "fall of the leaf;" which takes place at intervals (alike in evergreen and deciduous species), to be followed by the production of a new set of cells, having similar functions. And the Secreting cells have usually a like transitory duration; being destined to give up their contents by the rupture or liquefaction of their walls, whenever called upon to do so, by the demand set up in the growing parts of their neighbourhood, for the peculiar products they have set apart.

109. Not only are the proper organic functions of all Plants thus dependent upon the agency of cells; but their *Reproduction* is likewise. In the lowest tribes of the Cryptogamia, where each cell is an independent individual, every one has the power of preparing within itself the reproductive germs, from which new generations may arise. In the higher tribes, on the other hand, the general principle of the division of labour, which separates the absorbing, assimilating and secreting cells, involves also the setting apart of a distinct set of cells for the preparation of the reproductive germs; these cells are known in the Cryptogamia as *spores*, and in the Phanerogamia as *pollen-grains*. In the higher Plants we find a complex apparatus superadded; for the purpose of aiding the early development of these germs, by supplying them with nutriment previously elaborated by the parent; yet still this operation is of a purely *accessory* kind, and the *essential* part of the process remains the same.

110. Now we shall find that, although the fabric of Animals appears to be formed on a plan entirely different from that of Plants, and although the objects to be attained are so dissimilar, there is a much greater accordance amongst their elementary parts, than might have been anticipated. The starting-point of both is the same; for the embryo of the Animal, up to a certain grade of its development, consists, like that of the Plant, of nothing else than an aggregation of cells (Plate I., Fig. 15). And amongst the lowest tribes of animals, as well as among certain of the highest tribes that retain many embryonic peculiarities, even in the adult condition, (such as the curious *Amphioxus* or Lancelot.) we find a great proportion of the complete fabric to be possessed of a similar constitution. In most of the higher animals, however, we find that a large proportion of the fabric consists of tissues in which no distinct trace of a cellular origin is apparent; and it has been only since improved powers of observation have been brought to bear upon their analysis, and more especially since they have been examined, not only in their complete state, but in the course of their development, that they have been reduced to the same category with the tissues of Plants and of the lower Animals. Other tissues, which are peculiar to Animals, cannot be referred to the same origin; but these will be found to have a grade of organization even lower than that of simple isolated cells, and to be referrible to the solidification of the plastic or organizable fluid prepared by the assimilating cells, and set free by their rupture. We shall find, however, that (as in Plants) all the tissues most actively concerned in the Vital operations, retain their original cellular form; and we shall be able to refer to distinct groups of cells in the bodies of Animals, not merely the functions of Absorption, Assimilation, Respiration, Secretion, and Reproduction, which are common to them with Plants, but also those of Muscular Contraction, and Nervous Action, which they alone perform. Before proceeding to this investigation, however, it will be desirable to examine into the nature of the original components at the expense of which the Animal fabric is built up. Our knowledge of these is principally derived from the researches which have been made into their character in Man and the higher Animals; but there can be little doubt that they are common, with trifling modifications, perhaps, to the entire kingdom.

2. On the Original Components of the Animal Fabric.

111. Putting aside, for the present, the inorganic or mineral matters which enter into the composition of the Animal body, and which are left in the form of an ash, when the organic compounds are decomposed and dissipated by heat, we shall confine our attention to the peculiar characters of the latter. As already stated (§ 4), the organized tissues of Plants are found, when entirely freed from the contents of their cells, to have a very uniform composition; being entirely made up of Carbon united with the elements of Water in a very simple proportion,—that of 8 of the former to 7 of each of the latter; and this simplicity in their chemical character partly accounts for their comparative durability. There are various compounds found in the cells of Plants, and elaborated by them for the purpose of affording food to Animals, which do not undergo organization, so long as they are contained in the Vegetable fabric; but these very products, when transferred to the bodies of Animals, form the components of *their* solid tissues. These substances are distinguished by the presence of Azote or Nitrogen, in considerable amount; and also by the large number of atoms of the four components, which are united in each of them,—giving them a much more complex composition, and a much greater tendency to decay, this being brought about by the disposition of the components to enter into new compounds of a simpler and more permanent nature. A considerable variety of such substances exists in the different parts of the Human body; but the nature and composition of these may be better studied, when their structure and actions are being described; and at present we shall confine ourselves to the fundamental or original components, of which all the others may be regarded as modifications.

112. When we examine the Egg of an Oviparous animal, we find that, putting aside the fatty matter of the yolk (which is destined, not to be converted into tissue, but to be stored up in cells), the sole organic constituent is that which is known to Chemists as *Albumen*. By the wonderful processes of chemical and vital transformation, which take place during the period of incubation, and which are effected by the germ-cell and its descendants, this Albumen is metamorphosed into nerve, muscle, tendon, ligament, membrane, areolar tissue, horny substance, feathers, the organic basis of bone, &c. The same metamorphosis is continually taking place in the adult animal; for every substance of similar composition, that is employed as food, is reduced to the form of Albumen in the digestive process; so that this becomes the *essential* constituent of whatever fluid is absorbed for the nutrition of the tissues. It is true that Gelatine, taken in as food, may be absorbed and carried into the current of the circulation; but there is little doubt, that it is incapable of being applied to the reconstruction of any but the gelatinous tissues; and in these it exists in the very lowest form of organization, if organization it can be called. Moreover, as it is clear, from what has been just stated, that the gelatinous tissues *may* be formed at the expense of Albumen, we are justified in regarding the latter substance as the common *pabulum* for all. Hence Albumen seems to hold very much the same position in the Animal economy, with Gum in the Vegetable.

113. The properties of Albumen may be studied in the White of Egg, or in the Serum of Blood; from both of which situations it may be obtained in a pure state by very simple means. In the Animal Fluids it exists in a *soluble* state; and even when it has been dried (at a temperature of 126°), it is readily dissolved again in water, forming a glairy, colourless, and nearly tasteless fluid. In this condition it is always combined with a small quantity of free soda; to the separation of which (whether by the agency of heat or acids), its coagulation is thought by many Chemists to be due. On this

view, pure Albumen is not soluble in water; its solution being only accomplished by union with an alkali.—When dissolved in water, it *coagulates* at 158°; a very dilute solution, however, does not become turbid until it is boiled. When the coagulation of Albumen takes place rapidly, a coherent mass is formed, which shows no trace whatever of organization; but, when the process is more gradual, minute granules present themselves, which do not, however, exhibit any tendency towards a higher form of structure. It is thrown down from its solution, in a coagulated state, by Alcohol, Creosote, and by most Acids (particularly nitric) with the exception of the acetic. These precipitates are definite compounds of the Acids with the Albumen, which here acts the part of a base. On the other hand, coagulated Albumen dissolves in caustic Alkalies, and neutralizes them; so that it must here act as an acid. A solution of Albumen in water is precipitated by acetate of lead, and by many other metallic solutions: and insoluble compounds are formed, of which one—the albuminate of the chloride of mercury—is of much interest, as being that which is produced by the mixture of a solution of albumen with one of corrosive sublimate. Albumen, both in its soluble and insoluble state, always contains a small amount of Sulphur, which blackens metallic silver; and also a minute quantity of Phosphorus. Soluble albumen dissolves Phosphate of Lime; and about two per cent. of this salt may be separated from it in its coagulated state.

114. So long as Albumen remains in the state regarded by Chemists as characteristic of it, no tendency to become organized can be discerned in it; but subsequently to its introduction into the living Animal body, it undergoes a transformation into a compound, termed *Fibrine*, which is distinguished from it by new and peculiar properties. It appears from the analyses of Mulder and Scherer, that there is no essential difference in the ultimate composition of these two substances; the relative proportions of the constituents of each being, according to them, as follow:—

	MULDER.		SCHERER.	
	Albumen.	Fibrine.	Albumen.	Fibrine.
Carbon	54·84	54·56	53·850	53·671
Hydrogen	7·09	6·90	6·983	6·878
Nitrogen	15·83	15·72	15·673	15·763
Oxygen	21·23	22·13	} 23·494	} 23·688
Phosphorus	·33	·33		
Sulphur	·68	·36		
	100·00	100·00	100·000	100·000

The wide difference in their properties must be referred, on this view, solely to a change in the molecular arrangement of their ultimate particles. According to Dumas, however, there is a marked difference in composition, between Fibrine and the various forms of Albumen;—the former having less Carbon, and more Nitrogen, than the latter. The following are the results of his analyses:—

	ALBUMEN.		FIBRINE.
	From serum.	From eggs.	
Carbon	53·32	53·37	52·78
Hydrogen	7·29	7·10	6·96
Nitrogen	15·70	15·77	16·78
Oxygen	} 23·69	} 23·76	} 23·48
Sulphur			
Phosphorus			
	100·00	100·00	100·00

It is not, perhaps, of any great moment whether this difference has a real existence or not; for the conversion of Albumen into Fibrine is unquestionably a process much more of *vital* than of *chemical* transformation. We shall presently see, that Fibrine may be regarded as Albumen, in which the process of Organization has begun; its molecules being ready to assume the peculiar arrangement that is so designated: this arrangement takes place most completely, when the fibrinous mass is in contact with a living tissue, and is therefore to a certain degree under its influence. Fibrine, like Albumen, may exist in a *soluble* or in a *coagulated* state; its soluble form only occurs, however, in certain *living* animal fluids,—the Chyle, Lymph, and Blood;—and it seems to be the intermediate condition between the soluble albumen, and the solid organized substances which are formed from it. When withdrawn from the blood-vessels, the Blood soon coagulates, as do also the Chyle and Lymph, when they contain sufficient fibrine; and this coagulation is entirely due to a change in the condition of the Fibrine, the particles of which have a tendency to aggregation in a definite manner. The Fibrine may be obtained in a separate form, by stirring fresh-drawn blood with a stick, to which it adheres in threads; these contain some fatty matter, which is to be washed out with alcohol. In this condition it possesses the softness and elasticity which characterize the flesh of animals; and contains about three-fourths of its weight of water. It may be deprived of this water in dry air, and then becomes a hard and brittle substance; but, like flesh, it imbibes water again when moistened, and recovers its original softness and elasticity. When burned, it always leaves, like albumen, a portion of phosphate of lime. Fibrine is insoluble in alcohol and ether, and also, under ordinary circumstances, in water; but when long boiled in water, especially under pressure, its nature is altered, and it becomes soluble. This change, which may be effected also in coagulated Albumen, is attributed by Mulder to the oxidation of the Proteine, which is its principal constituent (§ 116, *a*). When Fibrine is treated with strong acetic acid, it imbibes the acid, and swells up into a transparent colourless jelly, which is soluble in hot water; this solution is precipitated by the addition of another acid.

115. Fibrine, like Albumen, unites with acids as a base, forming definite compounds; and with bases as an acid. Its correspondence with Albumen is further indicated by the fact (first stated by M. Denis), that it may be entirely dissolved in a solution of nitrate of potash; and that this solution is coagulated by heat, and greatly resembles a solution of Albumen. This is only true, however, of the ordinary Fibrine of venous blood; for that which is obtained from arterial blood or from the buffy coat, or which has been exposed for some time to the air, is not thus soluble. This is an important and interesting circumstance. The difference appears to depend upon the larger quantity of oxygen contained in the latter; for a solution of Venous Fibrine in nitre, contained in a deep cylindrical jar, allows a precipitate in fine flocks to fall gradually, provided the air have access to the surface, but not if it be prevented from coming in contact with the fluid; this precipitate is insoluble in the solution of nitre, and possesses the properties of arterial fibrine. Hence it may be inferred, that the Fibrine of Venous blood most nearly resembles Albumen; whilst that of Arterial blood, and of the Buffy coat, contains more oxygen, and is more highly animalized.—When decomposition commences in a coagulum of Fibrine withdrawn from the body (and even in the greatly-debilitated living body, in which the Fibrine appears to be imperfectly formed), a granular mode of aggregation is evident in the particles of the mass,—thus showing its affinity to Albumen, when its peculiar vital characters have departed, or are possessed by it in an inferior degree.

116. The close chemical relation existing between Albumen and Fibrine

is further shown by the fact, that from both of them (as well as from various substances used as food, which are furnished by the Vegetable kingdom, § 111) an identical substance may be obtained by a simple process. If boiled albumen be dissolved in a weak solution of caustic alkali, and the liquid be neutralized by an acid, a precipitate falls down in grayish-white flocks; this, being collected and washed, is gelatinous, of a grayish colour, and semi-transparent; and, when dried, it is yellowish, hard, easily pulverized, tasteless, insoluble in water and alcohol, and decomposed by heat without fusing. This substance has been termed *Proteine*, from an idea that it is the fundamental proximate principle of which Albumen, Fibrine, &c., are modifications. It contains the same proportions of Carbon, Hydrogen, Nitrogen and Oxygen, with Albumen and Fibrine; but it has been commonly regarded as destitute of their Sulphur and Phosphorus; the most recent investigations of Liebig, however, render it doubtful whether this is the case. According to Mulder (its discoverer), its composition may be represented by the formula 40 C, 31 H, 5 N, 12 O; whilst by Liebig it is represented by the formula 48 C, 36 H, 6 N, 14 O. Either of these correctly represents the *relative proportions* of the elements, as deduced from analysis; but the formula of Mulder is asserted by him to represent more accurately the *combining equivalent* of the entire substance, as deduced from the compounds it forms with others.

a. According to Mulder, Proteine unites with Oxygen in definite proportions, so as to form a *binoxide* and a *tritoxide*. These are both produced when Fibrine is boiled in water for some time; the latter being then found in solution, whilst the former remains insoluble. The *tritoxide* may also be formed by boiling Albumen for some time in water, when it is in like manner taken up in solution; but the insoluble residue is still albumen. It is further attainable by decomposing the chlorite of proteine with ammonia. In its properties it somewhat resembles *Gelatine*, and has been mistaken for that substance. There is reason to think that this compound really exists as such in the blood; a small quantity of it being formed every time that the blood passes through the lungs, and given out again when it returns to the system; and a much larger quantity being generated during the inflammatory process, so that it may be easily obtained from the buffy coat by boiling. It is also said to be contained in pus. The *binoxide* is quite insoluble in water, but dissolves in dilute acids. It may be obtained by dissolving Hair in potash, adding a little acid to throw down the proteine, and then adding a large excess of acid, which precipitates the binoxide. According to Mulder, this compound also is produced in small quantity at every respiration; and it enters into the normal composition of several of the animal tissues.—These views, however, must still be received with some hesitation. They are liable to the fundamental objection, advanced against them by Liebig; that the binoxide and tritoxide, like proteine itself, contain the sulphur of albumen and fibrine. Still, the production of new and peculiar compounds, by the processes indicated, is an important fact which cannot be overthrown; whatever may prove to be the case in regard to the ultimate composition of these substances.

b. One of the most characteristic and important properties of Proteine, is the facility with which it undergoes decomposition, when acted on by other chemical substances, especially by alkalis. If a proteine-compound be brought into contact with an alkali, ammonia is immediately disengaged; indeed the alkaline solution can hardly be made weak enough to prevent the disengagement of ammonia. This is a property, which must be continually acting in the living body; since the blood has a decidedly alkaline reaction. If either albumen, or any other proteine compound, be boiled with potash, it is completely decomposed; not, however, being resolved at once into its ultimate constituents, or altogether into simple combinations of them; but in great part into three other organic compounds,—Leucin, Protid, and Erythroprotid. *Leucin* is a crystalline substance, which forms colourless scales, destitute of taste and odour; it is soluble in water and alcohol, and sublimes unchanged. It consists of 12 Carbon, 12 Hydrogen, 1 Nitrogen, and 4 Oxygen. There is not at present any evidence, that it is produced in the living body; but considerable interest attaches to it from the fact, that it may be procured from *Gelatine*, as well as from *Proteine*; a near relationship between these two substances being thus indicated. The other two compounds, *Protid* and *Erythroprotid*, are uncrystalline substances; the former of a straw-yellow, the latter of a reddish-brown colour; they belong to the class of bodies which were formerly included under the vague general term of *extractive matter*; and they bear a strong resemblance to *Gelatine*, not only in their solubility in water, but also in their chemical composition, as is shown by the following comparison of their formulæ:—

	C.	H.	N.	O.
Protid	13	9	1	4
Erythroprotid	13	8	1	5
Gelatine	13	10	2	5

Besides these substances and Ammonia, Formic and Carbonic Acids are produced by the decomposition of Proteine with potash; the acids unite with the potash, whilst the ammonia is set free.

117. It is very important, however, to bear in mind, that however close may be the *chemical* approximation between Albumen and Fibrine, there is a wide difference between them, as regards their relations to living organized structures: and this difference is one of which chemistry takes no cognizance. To use a rather homely illustration, the relation between Albumen, Fibrine, and Organized Tissue is somewhat of the same nature as that which exists between the raw cotton, the spun yarn, and the woven fabric. Albumen shows no tendency to coagulate, except under the influence of purely chemical agents, and its coagulum is entirely destitute of structure, being a mere homogeneous aggregation of particles. On the other hand, Fibrine exhibits a constant tendency to pass into the form of a solid tissue; and it seems only restrained from doing so by certain influences, whose nature is not understood, to which it is subjected whilst contained in the vessels of the living body. The conversion of Albumen into Fibrine, therefore, is the first great step in the process of Nutrition, by which the materials supplied by the food are made to form part of the living tissues of the body; and it is the one to which the term *Assimilation* may be most appropriately applied. As already mentioned, Albumen is always the starting-point; since the fibrinous elements of organized tissues are reduced, by the solvent power of the gastric fluid, to the same form with the unorganized coagulum of the albumen of the egg. The first appearance of Fibrine is in the Chyle, or fluid of the Lacteals; and when this is examined in the neighbourhood of the part where it has been absorbed, the traces of Fibrine which it presents are very slight. As the Chyle flows along the lacteals, however, the proportion of Fibrine increases; and it reaches its maximum at the point where the Chyle is delivered into the current of the circulating Blood. The proportion of Fibrine in the Blood, as indicated by the firmness of the coagulum which it forms, is much greater than that contained in the Chyle, notwithstanding that there is a constant withdrawal of this element for the purpose of nutrition. And in certain disordered states of the system, in which the formative powers of the Blood are so exalted, as to produce a tendency to the formation of tissue in abnormal situations, the proportion of Fibrine is found to be increased to twice, thrice, or even four times its usual amount. And even where there is no such general increase, a local increase is made evident in the large proportion of fibrine, which exists in the *exudations* poured forth for the reparation of injuries; these exudations, when possessed of a high formative property (that is, a readiness to produce an organized tissue), are said to be composed of *plastic*, or *coagulable lymph*; but this is nothing more than the Liquor Sanguinis, or fluid portion of the Blood, holding in solution an unusual quantity of Fibrine. It is evident, from these facts, that some peculiar agency must exist within the vessels, by which the elaboration of the Fibrine from the Albumen is effected; and we shall hereafter endeavour to bring together certain facts, which seem to indicate its nature.

118. The tissue that is produced by the apposition of the particles of Fibrine, when left to themselves, and solely influenced by their own mutual attraction, is of a very simple character, being composed of fibres interlaced with each other in various directions. This arrangement can be seen in the ordinary Crassamentum, or clot of healthy Blood, by examining thin slices

under the microscope; especially after the clot has been hardened by boiling. A number of fibres, more or less distinct, may be seen to cross one another; forming by their interlacement a tolerably regular network, in the meshes of which the red corpuscles are entangled. This fact was known to Haller; but it has been generally overlooked by subsequent Physiologists, until attention was drawn to it by the inquiries of Messrs. Addison, Gulliver, and others. It is in the Buffy Coat, however, that the fibrous arrangement is best seen; on account, as it would appear, of the stronger attraction which the particles of fibrine have for one another, when its vitality has been raised by the increased elaboration to which it has been subjected. That there are varieties of *plasticity* in the substance, which, on account of its power of spontaneously coagulating, we must still call *fibrine*, appears from this fact among

others,—that, in tuberculous subjects, the *quantity* of fibrine in the blood is higher than usual (Andral and Gavarret), although its plasticity is certainly below par. It is as easy to understand, that its plasticity may be increased, as that it may be diminished; and this either in the general mass of the blood, or in a local deposit. In fact, the *adhesions* which are formed by the consolidation of coagulable lymph,—or in other words, of the fluid portion of the blood, whose plasticity has been heightened by the vital actions that take place within the capillaries of the part on which it has been effused,—often acquire very considerable firmness, before any vessels

have penetrated them; and this firmness must depend upon that mutual attraction of the particles for one another, which in *aplastic* deposits is altogether wanting, and which in *cacoplastic* deposits is deficient.—A very interesting example of a structure entirely composed of matted fibres, and evidently originating in the simple consolidation of Fibrine, is found in the membrane adherent to the interior of the Egg-shell (*Membrana putaminis*); and also in that which forms the basis of the Egg-shell itself. Between the two, there is no essential difference; as may be seen by examining “an egg without shell,” as it is commonly termed, (or rather one in which the shell-membrane has been unconsolidated by the deposition of calcareous matter); or by treating the egg-shell with dilute acid, so as to remove the particles of carbonate of lime, which are deposited in the interstices of the network. The place of the shell is then found to be occupied by a membrane of considerable firmness, closely resembling that which lines the shell and surrounds the albumen of the egg, but thicker and more spongy. After maceration for a few days, either of these membranes may be separated into a number of laminæ, each of which (if sufficiently thin) will show a beautiful arrangement of reticulated fibres. It is impossible to refuse to such a structure the designation of an *organized tissue*, although it contains no vessels, and must be formed by the simple consolidation of Fibrine, poured out from the lining membrane of the oviduct of

Fig. 10.

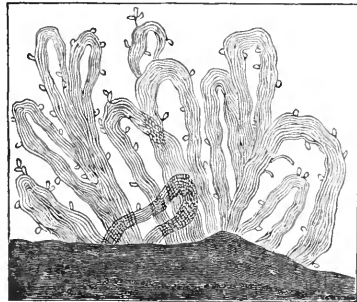

Fibrous structure of inflammatory exudation from peritoneum.

Fig. 11.

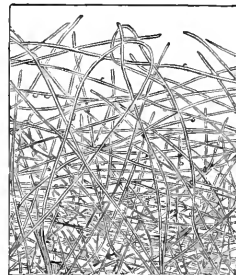

Fibrous membrane from the Egg-shell.

the bird. It is probably in the same manner, that the Chorion of the Mammiferous animal originates; since this is a new envelope, formed around the ovum, during its passage along the Fallopian tube. In the latter, for an ulterior purpose, vessels are afterwards developed, by extension from the contained ovum; and by the nutrition they supply, its size is increased, and changes take place in its texture. But in the Egg-membrane of the Bird, there is no need of vessels; because no subsequent change in its texture is required, and its duration is sufficient for the purpose it has to answer.

119. The completeness of the transformation of Fibrine into simple Fibrous Tissue, appears to depend upon two circumstances in particular;—the perfect elaboration of the Fibrine itself; and the vitality of the surface upon which the concretion takes place. When the Fibrine is highly elaborated, it will coagulate in the form of a definite network of minute fibrillæ, even upon a dead surface, as a slip of glass; this is the case, for instance, with the Fibrine of the buffy coat of the Blood, or with that of the Liquor Sanguinis (coagulable lymph) poured out for the reparation of an injured part. But in the ordinary Fibrine of the blood, the fibrillation is less distinct when the concretion takes place upon a dead surface. When it occurs in contact with a living surface, however, the coagulation takes place more gradually; and it seems as if the particles, having more time to arrange themselves, become aggregated into more definite forms, so that a more regular *tissue* is produced—just as crystals are most perfectly formed when the crystalline action takes place slowly. It was formerly imagined that the Muscular tissue is the only one produced at the expense of the *Fibrine* of the blood; the other tissues being formed from its *Albumen*. This, however, is unquestionably erroneous. There is no proof whatever that Albumen, as long as it remains in that condition, ever becomes organized; whilst, on the other hand, there is abundant evidence, that the *plasticity* of any fluid deposit—that is, its capability of being metamorphosed into organized tissue—is in direct relation with the quantity of Fibrine which it contains. Thus the Liquor Sanguinis, or Coagulable Lymph, thrown out for the reparation of injuries, contains a large amount of Fibrine; and this substance is converted, not at first into muscular fibre, but (whatever may be the tissue to be ultimately produced in its place) into a fibrous network, which fills up the breach and holds together the surrounding structure. This may be regarded as a simple form of *areolar* tissue; which gradually becomes more perfectly organized by the extension of vessels and nerves into its substance; and in which other forms of tissue may subsequently make their appearance. This process will be more particularly described hereafter; it is at present noticed here as an illustration of the general fact, that *fibrine* is to be regarded as the *plastic* element of the nutritive fluids.

3. *Of the Elementary Parts of Organized Tissues;—Cells, Membrane, and Fibre.*

120. The *cells*, which have been spoken of as making up the chief part of the Vegetable Organism, are minute closed sacs; whose walls are composed in the first instance of a delicate membrane, frequently strengthened, at a period long subsequent to their first formation, by some internal deposit. The form of these cells is extremely variable; and depends chiefly upon the degree and direction of the pressure, to which they may have been subjected at the period of their origin, and subsequently to it. Sometimes they are spheroidal; sometimes cubical or prismatic; sometimes cylindrical; and sometimes very much prolonged. These cells may undergo various transformations.—One of the most common, is the conversion of several into a continuous tube or Duct. This is principally seen in the vessels, through which the sap ascends the stem;

these appear to have been formed by the breaking-down of the transverse partitions, between a regular series of cylindrical cells laid end to end; and the remains of such partitions may frequently be seen in them. The ducts which convey the *ascending* sap, do not inosculate with each other; their purpose being merely to carry it direct to the leaves; but the vessels, through which the *descending* or elaborated sap flows, are of very different character; for their purpose is to distribute the nutritious fluid through the tissues; and they anastomose very freely, just as do the capillaries of Animals. The network which they form, however, can be as clearly traced to an origin in cells, whose cavities were originally distinct, as can the bundles of straight non-communicating ducts.—Another important transformation of the original cells, is that by which the Woody Fibres, which compose nearly all the fibrous textures of Vegetables, are produced. These fibres are still cells, but their form is very much elongated; they have a fusiform or spindle shape, being tubes drawn to a point at each end; at first they are quite pervious, like ordinary cells; but in the older wood, their cavity is filled up by interior deposit.

121. Such deposits may take place in cells of the ordinary form; and they present many variations in their character, which give corresponding peculiarities to the cells which contain them. In many instances, they consist merely of concentric layers, one within the other, each layer completely lining the one which preceded it; and the cavity of the cells being thus gradually but uniformly contracted in every dimension. In other cases, certain points of the original external cell-membrane are left uncovered by the secondary deposits; and thus, the same vacuities being left in the successive layers, passages are formed, which stretch out from the central cavity to certain spots of the periphery of the cell. Cells of this character are found in certain parts of plants, which are required to possess unusual firmness, without losing the power of transmitting fluid, the former endowment being conferred by the secondary deposits; whilst the latter is retained by the peculiar system of passages just described,—the thin or uncovered parts of the wall of one cell being in contact with corresponding spots on the walls of adjacent cells, as we see in the tissue of the stones of fruit, the central gritty matter of the pear, &c.—Lastly, the new deposit may present the form of a more or less regular spiral fibre, winding within the cell from end to end; and this may present itself alike in cells of the ordinary shapes, or in fusiform cells (constituting the proper *spiral vessels*), or in cells that have coalesced into continuous tubes or ducts. The spiral may break up into rings or irregular pieces; and these may be united again by additional deposits of a still more irregular character, so as completely to obscure their original spiral form. This spiral fibre is very completely generated, in some instances, when the cell-wall itself has not acquired any greater tenacity than that of mucus, very easily dissolved; which (as we shall presently see) is a stage in the production of cells in general. Such spiral fibres spring out from the external coats of many seeds, when they are moistened with fluids.

122. So far as is yet known, *all* Cells originate in germs, that have been prepared by some previously-existing cell; and these germs may either be developed within the parent-cell, or may be set free by its rupture, and may be developed quite independently. The latter case, being the simplest, will be first considered; we have numerous examples of it among the lower Cellular Plants. In the first place, the germ, from which the cell originates, is a minute granule, only to be seen with a good microscope, and apparently quite homogeneous. It has the power of drawing to itself the nutrient elements around, and of combining these into the proximate principles, that may serve as the materials for its development. By the incorporation of these with its own substance, it gradually increases in size, and a distinction becomes ap-

parent, between its transparent exterior and its coloured interior. Thus we have the first indications of the *cell-wall*, and the *cavity*. As the enlargement proceeds, the distinction becomes more obvious; the cell-wall is seen to be of extreme tenuity, perfectly transparent, and apparently homogeneous in its texture; whilst the contents of the cavity are distinguished by their colour, which (in the species here alluded to) is commonly either green or bright red. At first they, too, seem to be homogeneous; but a finely-granular appearance is then perceptible amongst them; and a change gradually takes place, which

Fig. 12.

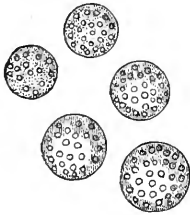

Simple isolated cells containing productive molecules.

seems to consist in the aggregation of the minuter molecules into granules of more distinguishable size and form. These granules, which are the germs of new cells, seem to be at first attached to the inner wall of the parent-cell; afterwards they separate from it, and move about in its cavity; and at a later period, the parent-cell bursts and sets them free. Now this is the termination of the life of the parent-cell; but the commencement of the life of a new generation: since every one of these germs may develop itself into a cell, after precisely the foregoing manner; and will then, in turn, propagate its kind by a similar process.

123. The development of new cells within the parent,—or what may be termed the *endogenous* mode of cell-growth,—takes place in many instances on a plan which differs in no respect from the preceding, except that the parent-cell does not rupture. The granules it contains derive their nutriment from the surrounding fluid, which is included within the cell; by their progressive increase in size, they gradually fill up the whole cavity of the parent-cell; and by a further increase, they distend its wall, which becomes thinner and thinner, and at last ceases to be visible around the newly-formed cluster.

124. In other instances, however, we find that the development of new

Fig. 13.



Cells of *Zygnema*. showing spiral arrangement of the nuclear particles.

cells proceeds, not from granules scattered through the whole interior of the cell, but from a determinate spot or *nucleus*, which is seen upon its wall. This nucleus is frequently formed very early, by the aggregation of molecules around the original granule or cell-germ, even previously to the first appearance of the distinct cell-membrane; and by Schleiden, who first observed this process, it was thought that the body thus produced was essential to the development of the new cell, whence he gave it the name of *cytoblast*. It appears, however, from more extended inquiries, that this is not the case; and that the nucleus is rather concerned with the subsequent operations which the cell performs, than with its original development. Frequently the nucleus does not make its appearance, until the cell itself has been completely formed. It is chiefly in the higher tribes of Plants, that we find these *nucleated* cells; the nucleus in the cells of the lower Cryptogamia being usually more or less expanded or diffused (as it were), through the entire cavity. The destination of the several forms of cells which make up the complex structure of the higher plants, is very different; and their office seems in great measure to depend upon the peculiar powers of the nucleus. In some instances, this body seems to be the centre which attracts new deposits; even the spiral filament being probably formed by its agency. We have, in some of the lowest Cellular Plants, a curious fore-shadowing of the spiral vessels of the most perfect; the green

particles (or diffused nucleus?) of the cells, in the genus *Zygnema*, presenting a regular spiral arrangement at one period of their growth (Fig. 13). And in other instances, as in the cells of the petal of the common Geranium (*Pelargonium*), we find the nucleus sending out curious stellate or radiating prolongations (Fig. 14.) These facts are of much interest, as illustrating some of the more obscure changes which are believed to take place in animal tissues.

125. But the nucleus may also be the source from which the new cells arise, that are developed within the cavity of the parent. Several varieties in the mode in which this process takes place, are presented to our observation in the simplest of the Cellular Plants, belonging to the group of the Fresh-water Algae; the growth of which may be studied with peculiar facility. In some of these the cell is destitute of a nucleus, but is filled with a very finely-divided granular matter, the *endochrome*; and the process of cell-multiplication is effected by the subdivision of this matter into two distinct masses, around each of which a pellucid cell-membrane subsequently makes its appearance, thus forming two new cells within the parent. By a repetition of the same process, each of these new cells may again produce two new ones; and thus the multiplication may be rapidly effected.

Fig. 14.

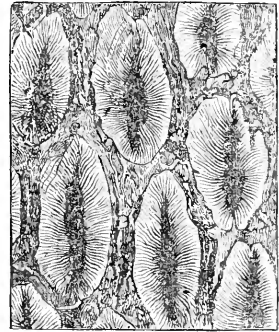

Cells from the petal of *Pelargonium* showing stellate prolongations of the nuclei.

Fig. 15.



Hematococcus binalis, in various stages of development; *a*, *a*, simple rounded cells; *b*, elongated cell, the endochrome preparing to divide; *c*, *c*, cells in which the division has taken place; *d*, large parent cell, in which the process has been repeated a second time, so as to form a cluster of four secondary cells, such as is often seen in Cartilage.

Fig. 16.

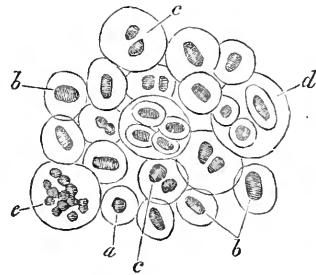

Coccochloris cystifera, showing various stages of development:—*a*, simple globular cells, surrounded by a well-defined mucous envelope; *b*, elongated cell about to divide; *c*, cell doubled by division, both the new cells still enclosed in original mucous envelope; *d*, further stage of the same process, one of the secondary cells having again divided, whilst the other has not yet undergone this change, but is about to do so; *e*, group of cells formed by the same process, and still retained within the original mucous envelope.

This form of cell-development is best seen in some of the simplest Algae, which consist of isolated cells, and in which the individuals composing the successive generations are quite independent of one another; and we have a good illustration of it in the *Hematococcus binalis*, whose various stages of cell-multiplication are shown in Fig. 15. In many other instances, the cells of successive generations, without losing their individuality, are held together

by a consistent mucous envelope ; so that we may find two, three, four, or a larger number, clustered together within a well-defined investment, which has tenacity enough to prevent them from separating. Of this we have a good example in *Coccochloris cystifera* (Fig. 16) ; and a yet more remarkable one in *Hematococcus sanguineus* (Fig. 17). The cells forming such masses of vegetation may be likened to those of Cartilage, which are similarly enveloped by an intercellular substance, and which present the same binary method of multiplication (§ 129). In the *Confervæ* we find the cells, which are successively produced in this manner, remaining in connection with each other, so as to form articulated filaments. The terminal cell of each filament is continually undergoing subdivision in the manner just described, and thus the filament is elongated ; whilst other cells produce regular reproductive granules, which are set free by an opening that forms in the cell-wall, and which develop themselves into new individuals without any further aid from the parent structure, in the manner already described. The difference between these two modes of propagation seems to have reference to the age and degree of development of the cell ; the binary division being characteristic of cells which are in a growing state, and being destined to extend the original structure ; whilst the formation and emission of a number of reproductive granules is the function of the mature cell, and is destined to give origin to new individuals. These processes are analogous in the higher plants, the first to the development of leaf-buds, the second to the production of seeds. In the *Nostoc* we find the moniliform filaments, which are composed of a linear series of cells, invested by dense gelatinous sheaths of definite extent, looking almost like

Fig. 17.

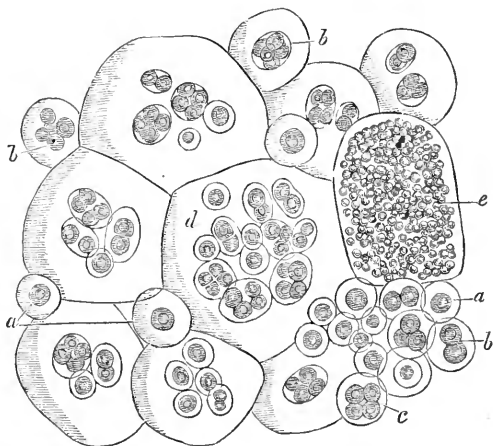

Hematococcus sanguineus in various stages of development, — *a*, a single cell, enclosed in its mucous envelope ; *b*, *c*, clusters formed by division of parent-cell ; *d*, more numerous cluster, its component cells in various stages of division ; *e*, large mass of young cells, formed by continuance of the same process, and enclosed within common gelatinous envelope.

large parent-cells (Fig. 18, *b*) ; and the extension of the filaments may so distend their sheaths as to give them the appearance of capacious globular cells (Fig. 18, *A*). There is reason to believe that the long convoluted filaments then separate into a cluster of shorter ones, each having its own share of the mucous envelope.

126. The history of the Animal cell, in its simplest form, is precisely that of the Vegetable cell of the lowest kind. It lives *for* itself and *by* itself, and

is dependent upon nothing but a due supply of nutriment and a proper temperature for the continuance of its growth, and for the due performance of its functions, until its term of life is expired. It originates from a reproductive granule, previously formed by some other cell; this granule attracts to itself, assimilates, and organizes, the particles of the nutrient fluid in its neighbourhood; and converts some of them into the substance of the cell-wall, whilst it draws others into the cavity of the cell. In this manner the cell gradually

Fig. 18.

A.

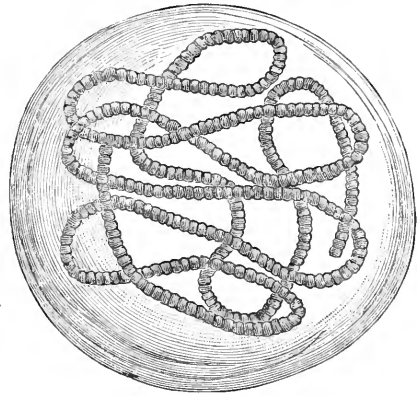

B.

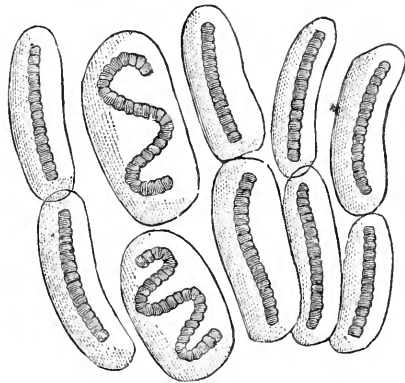

Nostoc macrosporum.—A, a long convoluted filament, composed of linear series of minute cells, enclosed in general mucous envelope; B, group of shorter filaments, each with its own gelatinous envelope, probably formed by the division of the preceding.

It is in the nature of the *contents* of the cell (as among the cells of Plants), that the greatest diversity exists; and we shall find that the *purposes* of the different groups of cells, in the general economy of the Animal, depend upon the nature of the products they secrete, and upon the length of time during which these products are retained by them.

127. Of the general account just given, the development of certain cells, which float in the Chyle, Lymph, and Blood, may be adduced as an example; these, which are known as the Chyle and Lymph corpuscles, and as the

Colourless corpuscles of the Blood, have no single nucleus, but contain several scattered particles, each of which seems to be a reproductive granule; and they emit these by the bursting or liquefaction of their wall,—a change which may be effected in them at any time, by the application of chemical reagents. The granules thus set free appear to float in the current of fluid, and to be in their turn developed into cells at the expense of the materials it affords. The exudations of the plastic or organizable matter of the blood, which are thrown out upon inflamed or wounded surfaces, appear to contain some of these granules; for similar cells are speedily developed in these exudations, giving rise, in their turn, to new generations, when their own term of life is ended.

128. In general, however, we find the cells of Animal tissues furnished with a *nucleus*; and this may be formed, as in Plants, either at an early stage of the development of the cell, by the aggregation of minute *moleculæ* around the original granular germ (which germ seems to be the *nucleolus* of some authors); or after the cell has attained its full size. The nucleus, where it exists, appears to be the chief instrument in the functions of the cell; the cell-membrane probably having little else, than the mechanical office of bounding or limiting the contents of the cell. In some cells the function is restricted to the attraction of certain constituents, by which the cavity of the cell is filled. These constituents may be of a nature to give solidity and permanence to the texture; thus, the cells of the Epidermis are strengthened by a deposit of horny matter, those of Shell by the deposit of carbonate of lime; those of Bones and Teeth by a mixture of mineral and earthy matter, &c. Or they may be of a fluid nature, readily passing into decomposition, and destined to be retained only for a short time; being given up again by the rupture or liquefaction of the cell-wall, as in the case with the cells of Glandular structures in general. Now such cells do not usually reproduce themselves, but successive crops of them are generated as fast as required from other sources; and the function of their nuclei appears to be limited to their chemical agency upon the materials which they select. It would seem,

in fact, as if the direction of the *visus* or power of the cell to this object, prevented the exercise of its reproductive powers; and where we find these last most strongly manifested, it is usually observable that the cell performs little or no other duty.

129. In the *endogenous* development of Animal cells, the nucleus seems always to perform an important part, where it has a distinct existence. In many cases, the multiplication can be clearly perceived to take place, by the division of the nucleus into two or more portions; each part giving origin to a new cell. This seems to be the case, for example, in the ordinary production of Cartilage-cells; for on examining sections of cartilage that is undergoing rapid extension, we find groups of cells, in all respects corresponding with those of the simple cellular plants, which can be seen to increase in the same way. Thus in

Fig. 19.

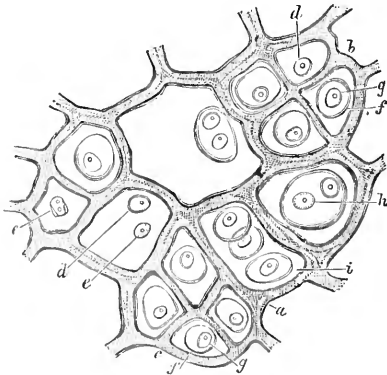

Section of branchial Cartilage of young Tadpole; *a, b, c*, intercellular substance; *d*, single nucleus; *e*, nucleus dividing into two; *d', e'*, two nuclei in one cell, formed by division of single nucleus; *f*, secondary cell, forming around nucleus *g*; *h*, two nuclei within single secondary cell; *i*, three secondary cells, within one primary cell.

Fig. 19, which represents a section of one of the branchial cartilages of the

Tadpole, we observe, within the large parent-cells that are held together by intercellular substance, *a, b, c*, secondary cells in various stages of development: at *d*, the nucleus is single; at *e* it is dividing into two; in the adjoining cell, the division into two nuclei, *d'* and *e'*, is complete; at *h*, two such nuclei are inclosed within a common cell-membrane; at *i*, we see three new cells (one of them elongated, and itself probably about to subdivide) within the parent; and in each of the two groups at the top and bottom of the figure, we have four small cells, now separated by partitions of intercellular substance, but having manifestly originated from one parent cell. (See also Fig. 43.)

130. In other cases, the granular nucleus subdivides into a greater number of parts, so as to give origin to a cluster of young cells, which may completely fill the parent-cell; various stages of this process are seen in Fig. 20. This process seems to be adopted, where rapid multiplication is needed, and where the new or secondary cells are not destined to possess any great duration. The same nuclei or "germinal centres," continually drawing new materials from the blood, may thus develop many successive crops of new cells, when an opening in the wall of the parent-cell permits them to be discharged as fast as they are formed; and this we shall find to be the way in which the cells of the secreting structures are developed within the glandular follicles. According to Dr. Barry, it is not uncommon for several *annuli* of young cells to be generated from the periphery of the nucleus, and to attain a certain degree of development within the parent cell, the first-formed being the largest, as shown in Plate I., Fig. 10, *a, b*; some of these, moreover, having distinct nuclei of their own, from which a third generation is being developed on the same plan (Fig. 12, *b*); and yet for all these to disappear by liquefaction, leaving the cavity of the parent-cell unoccupied, except by a pair of cells originating in the central part of the nucleus (Fig. 13). If this account be correct, it is probable that these temporary cells perform the office of preparing the contents of the parent-cell for the nutrition of the offspring which is to succeed it; and each of these twin cells, in its turn, going through the same series of changes (Fig. 14), gives origin to a new pair; the continuance of which process generates a cluster. This is the mode, according to Dr. Barry, in which the first cells of the embryo are developed into the "mulberry mass" (Fig. 15), by whose subsequent development and metamorphoses, the tissues and organs of the fœtus are progressively evolved.

131. Notwithstanding the numerous varieties that exist, in the particular modes in which the cells are developed, it seems to be well established as a simple general principle, that all cells take their origin in germs prepared by a previously-existing cell; and that these germs may be developed, either

Fig. 20.

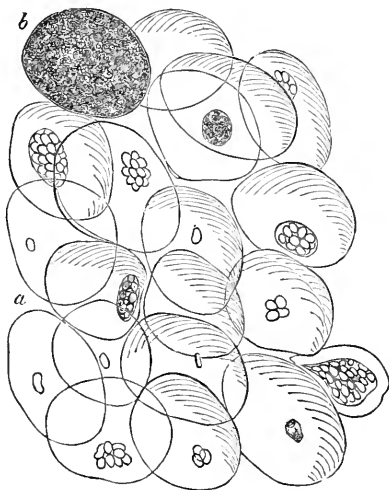

Endogenous cell-growth in cells of a meliceritous tumour; *a*, cells presenting nuclei in various stages of development into a new generation; *b*, parent-cell filled with a new generation of young cells, which have originated from the granules of the nucleus.

within the parent-cell, or when set free by its rupture. The difference observable in the several cases that have been enumerated, and in others that might be mentioned, seems to have reference chiefly to the degree of preparation that is effected in the nutriment with which the young cells are supplied;—some drawing it directly from the blood; whilst others receive it through the medium of the parent-cell, which probably exerts a certain degree of preparing influence upon it;—and others, again, requiring a further preparation to be effected, by the elaborating or assimilating influence of a group of temporary cells, expressly developed for this purpose.

132. We shall find, as we proceed, that all the tissues most actively concerned in the maintenance of the Vital functions of the Human body,—both those of a Vegetative nature, and those which are peculiarly Animal, are composed of Cells which have undergone no considerable metamorphosis, and of which one generation is produced after another with a rapidity that is proportioned to the activity of the function. But there are other structures of an accessory character, in which a departure from the original type is to be traced, sometimes so complete, as to prevent their real nature from being understood, except by a very careful scrutiny into their history. This departure is the result of various kinds of metamorphosis of the cells and of their nuclei; of which the following are the principal. The cells, originally spheroidal, oval, or polygonal, may become elongated to such a degree, as to assume the spindle or fusiform shape; thus resembling woody fibres. They may at the same time lose their nuclei; and their cavities may be occupied by internal deposits, so that they may be mistaken for solid fibres. Such fusiform cells are often found in exudation-membranes.—Again, the cells may shoot out prolongations, either in a radiating manner, so that they assume a stellate form; or in no definite direction, so that their shape becomes altogether irregular. Such forms are seen amongst the pigment-cells of the Batrachia and Fishes, and among the vesicles of the gray matter of the nervous system. Further, the original boundaries of the cells may be altogether lost, by their coalescence with each other. This is the case with many membranes that seem to have originated in a layer of flat cells; the situation of which is rather to be traced by their nuclei, than by their former boundaries, which have altogether disappeared. It is often the case, too, with the horny cells, of which the nails, hoof, &c., are made up; and still more with the cells of shell, bone, tooth, &c., which have been consolidated by the deposition of a calcifying deposit.—Lastly, the character of the original cell may be completely altered by a solution in the continuity of its wall, in one or more spots, so that its cavity is laid open, and coalesces with some other. In this manner, by the disappearance of the partitions between cells laid in apposition, end to end, may be formed a tube; and this tube may coalesce with others, in like manner, so as to form a capillary network for the circulation of the blood. Or the tube may form a simple straight fibre; and the nuclei of its component cells may give origin to a new deposit, either in an amorphous condition, as in the fibrous portion of nervous tissue, or in the form of an aggregation of new cells, as in the most perfect kind of muscular fibre. In these cases, also, the original composition of the tubes may be frequently traced by the nuclei that remain in their interior. In the follicles of glands, the solution of continuity takes place at one point only, which establishes a communication between the cavity of the parent-cell, and some canal by which its contents may be discharged; and the nucleus situated at the blind or closed extremity of the follicle, may then continue to form successive generations of secondary cells, which are discharged by this outlet.

133. The metamorphoses of the nucleus are not less important, though not as numerous. In some instances we find it sending out radiating prolonga-

tions, so that it assumes a stellate form, like that of the cells of the *Geranium-petal*; this seems to be the case in regard to the nuclei of the *Bone-cells*.—In other instances it appears to resolve itself into a fasciculus of fibres; and this is stated by *Henlé* to be the origin of the yellow fibrous tissue.—Further, it may separate into a number of distinct fibres, each composed (like those of the *Nostoc*, Fig. 18.) of a linear aggregation of granules; it seems to be in this manner, that the tubuli of the *Dental* structure are formed.—Lastly, it may disperse itself still more completely into its component granules; by the reunion of which, certain peculiar vibrating filaments (the so-called *Spermatozoa*) may be formed, possessing motor powers analogous to those of the *Oscillatoriæ* and other corresponding filamentous products of humble *Cryptogamic* vegetation, but destined to perform most important offices in the function of *Reproduction*.

134. We have seen that, in the *Vegetable* structure, the component cells, tubes, woody fibres (or elongated cells), &c., are held together by simple adhesion; a gummy intercellular substance, which answers the purpose of a cement, being often interposed, sometimes in considerable quantity. But in the *Animal* body, of which the several parts are destined to move with greater or less freedom upon one another, the aggregations of cells that make up its chief part, either in their original or in their metamorphic form, could not be held together in their constantly-varying relative positions, without some intervening substance of an altogether different character. It must be capable of resisting tension with considerable firmness and elasticity; it must admit free movement of the several parts upon one another; and it must still hold them sufficiently close together to resist any injurious strain upon the delicate vessels, nerves, &c., which pass from one to another, as well as to prevent any permanent displacement. Now all these offices are performed in a remarkably complete degree, by the *Areolar Tissue* (§ 138); the reason of whose restriction to the *Animal* kingdom is thus evident. And as necessity arises, in certain parts, for tissues which shall exercise a still greater power of resistance to tension, and which shall thus communicate motion (as in the case of *Tendons*), or shall bind together organs that require to be united (as in the case of *Ligaments* and *Fibrous Membranes*), so do we find peculiar tissues developed that shall serve these purposes in the most effectual manner. Hence these tissues also, although not endowed with any properties that are peculiarly *animal*, are nevertheless restricted to the *Animal Kingdom*,—as completely as are the *Muscular* and *Nervous Tissues*, which make up the essential parts of the apparatus of *Animal Life*.

135. That *all* the *Animal* tissues are in the first instance developed from *Cells*, was the doctrine put forth by *Schwann*, who first attempted to generalize on this subject. By subsequent research, however, it has been shown that this statement was too hasty; and that, although many tissues retain their origin cellular type, through the whole of life, and many more are evidently generated from *Cells* and are subsequently metamorphosed, there are some, in which no other cell-agency can be traced, than that concerned in the preparation of the plastic material.—This would appear to be the case, in certain forms of the very delicate structureless lamella of membrane, now known under the name of *Basement* or *Primary Membrane*, which is found beneath the *Epidermis* or *Epithelium*, on all the free surfaces of the body. In many specimens of this membrane, no vestige of cell-structure can be seen; and it would rather appear to resemble that, of which the walls of the cells are themselves constituted.* In some instances, it presents a somewhat granular ap-

* See a Paper by the Author, on the Microscopic Structure of Shells, &c., in the *Annals of Natural History*, Dec. 1843. The inner layer of the Shells of *Mollusca*, after treatment

pearance; and it is then supposed by Henlé to consist of the coalesced nuclei of cells, whose development has been arrested: or, in other words, such Basement-Membrane is formed by the consolidation of a layer of the plastic element, that includes a large number of the granules, which may serve for the development of new cells. Other forms of the Basement-Membrane can be distinctly seen to consist of flattened polygonal cells, closely adherent by their edges; every one having its own granular nucleus.*—It seems to be from these granular germs, sometimes scattered through the membrane, and in other instances collected into certain spots, that the cells of the superjacent Epithelium or Epidermis take their origin; and if this be the case, we must regard the Basement-Membrane as a *transitional* rather than as a permanent structure,—continually disintegrating, and yielding up its contained cell-germs on its free surface, and as constantly being renewed from the blood beneath. For the epidermic structures appear to constitute an exception to the general rule, that the Tissues reproduce themselves; since they are cast off, without leaving their germs behind them; and the cells which replace them must be derived from new germs, more directly supplied from the blood than is elsewhere the case. In the case of the other tissues, whose disintegration takes place *interstitially* (so to speak), it would seem probable that, in the very act of the dissolution of the parent-structure, the germs of the new structures destined to replace it are set free; as happens in the reproduction of the simple Cellular Plants.

136. It would seem doubtful, also, in regard to the simple *Fibrous* tissues, whether they are generated by a metamorphosis of Cells, in the same manner as the Osseous, Muscular and Nervous; or whether they are not produced, like the Basement-Membrane, by the consolidation of a plastic fluid, which has been elaborated by cells. The latter view is the one which the Author has been led to regard as most probable, from the results of his own observations, coupled with those of Messrs. Addison and Gulliver previously adverted to. The Membrane of the Egg-shell, whose structure has been already described (§ 118), appears to him to have essentially the same character with the simple Fibrous tissues, which it resembles also in its tenacity (compare Fig. 11 with Fig. 22); whilst its origin can scarcely be supposed to be different from that of the fibrous network in the buffy coat of the Blood, or in the

bands formed by the coagulation of Lymph upon an inflamed surface. The occasional vestiges of cells, which the purely Fibrous tissues display (§ 138), and which have been adduced in support of their cellular origin, are not inconsistent with this view. For in the reticulated structures just adverted to, certain bodies are seen, which appear to be nuclei or imperfectly-formed cells (originating probably in germs set free by the rupture of the colourless corpuscles of the blood), and which closely correspond with the nuclear corpuscles that may be brought into view in the Fibrous tissue. Mr. Addison's observation, too,—that the fibres formed in the Liquor Sanguinis, and in plastic exudations, during coagulation, often seem to radiate from the remains of the white corpuscles that have ruptured, or from the little aggregations of granules they contained,—

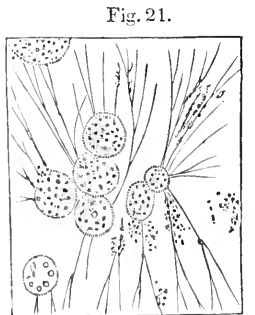

Fig. 21.
Colourless cells, with active molecules, and fibres, of fibrine, from Herpes labialis.

gives the explanation of several of the appearances, which have led to the

with a dilute acid, yields specimens of Basement-Membrane, in a form well adapted for examination.

* See J. Goodsir, in "Anatomical and Pathological Observations," Chap. I.

belief in the production of the Areolar and other fibrous tissues by Cell-transformation.—An additional argument in favour of this view, may be found in the appearances presented by the *semi-fibrous* Cartilages. In the Cartilages of the ribs, for instance, a more or less distinct fibrous appearance may often be seen in the intercellular substance, which is elsewhere quite homogeneous; this appearance is sometimes so faint, that it might be considered as an illusion, occasioned by the manipulation to which the section has been subjected; but it is often so well defined, as to present the aspect of true fibrous tissue. No indication of the direct operation of cells, in the development of these fibres, has ever been witnessed; and we can scarcely do otherwise than regard them as produced by the regular arrangement and consolidation of the particles of the intercellular substance, in virtue of its own inherent powers.

137. The following arrangement of the Human Tissues will be here adopted as expressing their respective relations to the fundamental elements which have been now described; namely, simple *Membrane, Fibres, and Cells*.

a. Simple Membranous Tissues.—Of these there are scarcely any examples in the Human body, except in the posterior layer of the cornea and the capsule of the crystalline lens. The membranous element is largely found, however, in the compound Membrano-fibrous tissues.

b. Simple Fibrous Tissues.—Under this head may be classed the White and Yellow Fibrous Tissues, and Areolar Tissue.

c. Simple Cells floating separately and freely in the fluids. Such are the Corpuscles of the Blood, Chyle, and Lymph.

d. Simple Cells developed on the free surfaces of the body. Such are the Epidermis and Epithelium.

e. Compound Membrano-Fibrous Tissues, composed of a layer of simple membrane, developing Cells on its free surface, and united on the other to a fibrous or areolar structure.—Of this kind are the Skin, the Mucous Membranes, the Serous and Synovial membranes, the lining membranes of the Blood-vessels, &c.

f. Simple Isolated Cells, forming solid tissues by their aggregation.—Under this head we may rank the Fat-cells, the Vesicles of Gray Nervous matter,* the Absorbent cells at the extremities of the Intestinal villi, and the cellular parenchyma of the Spleen and similar bodies: the cells being held together, in all these cases, by the blood-vessels and areolar tissue which pass in amongst them. In Cartilage, and certain tissues allied to it in structure, the cells are united by intercellular substance, which may be quite homogeneous, or may have a fibrous character.

g. Sclerous or Hard Tissues, in which the cells have been consolidated by internal deposit, and have more or less completely coalesced with each other.—Such is the case with the substance of Hair, Nails, &c., which may be more properly ranked under the Epidemic Tissues; but the result is most characteristically seen in Bones and Teeth.

h. Simple Tubular Tissues, formed by the coalescence of the cavities of cells, without secondary internal deposit.—The Capillary blood-vessels, and probably also the smallest Lymphatics and Lacteals, seem to be formed in this manner.

i. Compound Tubular Tissues; in which, subsequently to the coalescence of the original cells, a new deposit has taken place within their cavities.—In the tubuli of the White or Medullary Nervous matter, and in those of the least

* As it is undesirable to separate from each other the descriptions of the two elementary forms of Nervous structure, on account of their close functional connection, the gray or vesicular nervous matter will be described together with the white or tubular, in the last section of this chapter.

perfect form of Muscular Fibre, the secondary deposit has only a granular or amorphous character; but in the striated Muscular fibre, it is composed of minute cells.

As it is not requisite here to say anything further of simple Elementary Membrane, we shall at once pass on to the second group of Tissues; one of great extent and importance in the bodies of all the higher Animals.

4. Of the Simple Fibrous Tissues.

138. A very large proportion of the body, in the higher Animals, is composed of a tissue, to which the name of "Cellular" was formerly given. This term, however, is so much more applicable to those structures, which are composed of a congeries of distinct Cells, and the use of it for both purposes is likely to engender so much confusion, that it is to be wished that its application to this purpose should be altogether discontinued.—The tissue in question, now generally designated the *Areolar*, is found, when examined under the Microscope, to consist of a network of minute fibres and bands, interwoven in every direction, so as to leave innumerable interstices, which communicate with each other. The two kinds of Fibrous tissue, which elsewhere exist separately,—the *white*, and the *yellow*,—may be detected in Areolar tissue; as was first pointed out by Messrs. Todd and Bowman. The *White* presents itself in the form of inelastic bands of variable size, the largest 1-500th of an inch in breadth, somewhat wavy in their direction, and marked longitudinally by numerous streaks (Fig. 23); these streaks are rather the indications of a longitudinal creasing, than a true separation into component fibres; for it is impossible by any art to tear up the band into filaments of a determinate size, although it manifests a decided tendency to tear lengthways. Sometimes,

Fig. 22.

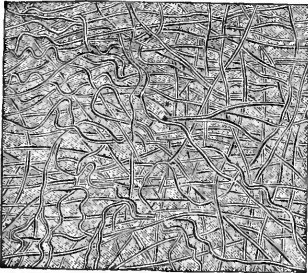

Arrangement of Fibres in Areolar Tissue.
Magnified 135 diameters.

however, distinct fibres may be traced, whose diameter varies from about 1-15,000th to 1-20,000th of an inch. The *Yellow* fibrous element exists in the form of long, single, elastic, branched filaments, with a dark decided border, and disposed to curl when not put on the stretch (Fig. 24). These interlace with the others, but appear to have no continuity of substance with them. They are for the most part between 1-5000th and 1-10,000 of an inch in thickness; but they are often met with both larger and smaller. The proportion of this element varies greatly in different parts; being greatest in those situations, in which the greatest elasticity is required. Sometimes we find elastic fibres passing round the fasciculi of the white tissue, constricting them with distinct rings, or with a continuous spiral; such are termed by Henlé *nucleus-filaments*, from his idea of their origin (§ 133). This remarkable disposition of the yellow fibres is best seen in the areolar tissue, that accompanies the arteries at the base of the brain.—The effect of Acetic acid upon these two elements is very different; the *white* immediately swells up, and becomes transparent; whilst the *yellow* remains unchanged. This agent frequently brings into view certain oval corpuscles, which lie in the midst of the bands and threads, and which sometimes appear to have delicate prolongations among them. These are usually supposed to be the persistent nuclei of the cells, from which the tissue was developed; but, as already pointed out, it is doubtful whether the fibres of this tissue are ever formed by the me-

tamorphosis of cells,—their origin being rather, it seems more probable, in the fluid blastema (§ 136).—The interstices of Areolar tissue are filled during life with a fluid, which resembles a very dilute Serum of the blood; it consists chiefly of water, but contains a sensible quantity of common salt and albumen, and (when concentrated) a trace of alkali sufficient to affect test-paper. The presence of this fluid seems to result from an act of simple physical *transudation*; for it has been found that, when the serum of the blood is made to percolate through thin animal membranes, the water charged with saline matter passes through them much more readily than the albumen, a part of which is kept back.

139. The great use of Areolar tissue appears to be, to connect together organs and parts of organs, which require a certain degree of motion upon one another: and to envelope, fix, and protect, the blood-vessels, nerves, and lymphatics with which these organs are to be supplied. It can scarcely be said to enjoy any *vital* powers, and is connected solely with physical actions (§ 134). It is extensible in all directions, and very elastic, in virtue of the physical arrangement of its elements; and it possesses no contractility, beyond that of the vessels which are distributed through it. It cannot be said to be endowed with sensibility; for the nerves which it contains seem to be merely *en route* to other organs, and not to be distributed to its own elements. And its asserted powers of absorption and secretion appertain rather to the walls of the capillary blood-vessels, than to the threads and bands of which it is composed. It is regenerated more readily than any other tissue, save the Epithelium; being produced, it would appear, by the simple consolidation of the blastema, that is poured out (in the form of organizable lymph) in situations where there has been a breach of substance. It is also formed in the effusions of a similar fluid, which are deposited on the surfaces, or in the substance, of inflamed tissues.—Areolar tissue yields Gelatine by boiling; but this is derived from the White Fibrous element only; the Yellow not being affected by the process.

140. The *White Fibrous* tissue exists alone in Ligaments, Tendons, Fibrous Membranes, Aponeuroses, &c.; where it presents the same characters as those just described,—except that the bands are less wavy, and frequently quite straight, so that it is inextensible. It receives very few blood-vessels, and still fewer nerves; indeed it would seem that, in many structures (as tendons), it is totally insensible. It seems entirely destitute of any vital property; and its chemical nature is such, that it needs very little interstitial change to maintain its normal composition. If dried, it has not the least tendency to putrefy; and when moist, it resists the putrefactive process more strongly than almost any of the softer textures. The peculiar and important property of this tissue, is its capability of resisting extension; and we find it in situations, where a firm resistance is to be made to traction. If the traction be applicable in one direction only, as in Tendons and most Ligaments, we find the bundles of fibres or bands arranged side by side; but if it be exerted in various directions, the fasciculi cross one another, as in Fibrous Membranes. The reparation of this tissue is effected by the interposition of a new substance, every way similar to the original, except that it wants its peculiar glistening aspect, and is more bulky and transparent.—The *Yellow Fibrous* tissue exists separately in the middle coat of the Arteries, the Chordæ Vocales, the Ligamentum Nuchæ (of quadrupeds) and the Ligamenta subflava; and it enters largely into the composition of some other parts. It differs remarkably from the white, in the possession of a high degree of elasticity; so that the tissues, which are composed of it alone, are among the most elastic of all known substances. It is, however, much more brittle than the white; and its fibres usually exhibit a marked tendency to curl at their broken ends. Their size

varies from about 1-4000th, to 1-24,000th of an inch; in the ligamenta subflava, it is usually about 1-7500th. There is less tendency to spontaneous

Fig. 23.

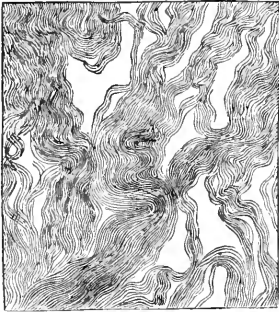

White Fibrous Tissue, from Ligament.
Magnified 65 diameters.

Fig. 24.



Yellow Fibrous Tissue, from Ligamentum
Nuchæ of Calf. Magnified 65 diameters.

[Fig. 25.



The two elements of Areolar tissue, in their natural relations to one another; 1, the white fibrous element, with cell-nuclei, 9, sparingly visible in it; 2, the yellow fibrous element, showing the branching or anastomosing character of its fibrillæ; 3, fibrillæ of the yellow element, far finer than the rest, but having a similar curly character, 8 nucleolated cell-nuclei, often seen apparently loose.—From the areolar tissue under the pectoral muscle, magnified 320 diameters.]

[Fig. 26.

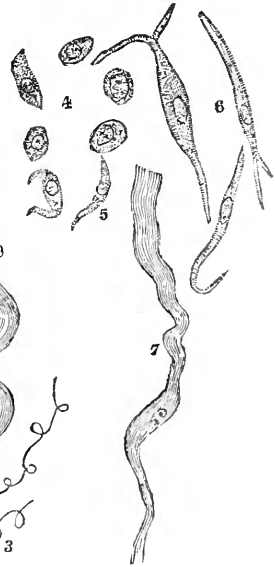

Development of the Areolar tissue, (white fibrous element): 4, nucleated cells, of a rounded form; 5, 6, 7, the same, elongated in different degrees, and branching. At 7, the elongated extremities have joined others, and are already assuming a distinctly fibrous character. (After Schwann.)]

decomposition in this tissue, than in almost any other part of the fabric,—at least, of its soft and moist portions; it requires but little renovation, therefore, in the living body; and is but very sparingly supplied with blood-vessels.

141. The composition of the *White* fibrous tissues is very different from that of most others; for they yield to boiling water the substance called *Gelatine*, which does not seem capable of the same degree of organization with the Proteine-compounds. This may be obtained by boiling portions of Skin, Areolar tissue, Serous membrane, Tendon, Ligament, &c., in water, for some time; after which the decoction is allowed to cool, when it solidifies into a jelly of greater or less thickness. Some tissues dissolve readily in this manner, and little residual substance is left; this is especially the case with areolar tissue, serous membranes, and (in a less degree) with skin. Others require a long boiling for the extraction of any *Gelatine*; and even then it is obtained in but small quantity; of this kind are the Elastic fibrous tissue, and some forms of Cartilage. A peculiar modification of this principle exists in most of the permanent cartilages; and has received the name of *Chondrine*. *Gelatine* is not found in the blood, nor in any of the healthy fluids; and some Chemists are of opinion, that it is rather a product of the operation practised to separate it, than a real constituent of the living solids. This idea seems inconsistent, however, with the fact, that the gelatinous tissues will exhibit, without any preparation, the best marked of the chemical properties which are regarded as characteristic of *Gelatine*,—that, namely, of forming a peculiar insoluble compound with Tannin; and the Tanno-*Gelatine*, which may be obtained by precipitating *Gelatine* from a solution, and that which results from the action of Tannin on Animal membrane, appear to be precisely analogous in every respect,—save in the presence of structure in the latter, which is absent in the former. Moreover, the Gelatinous tissues are found, when submitted to ultimate analysis, to possess exactly the same composition with *Gelatine* itself. Still it seems probable, that the arrangement of the component particles is in some degree altered by the process of boiling; for it is found that, the more distinct the fibrous structure of the tissue, the less it is affected by the prolonged action of cold water, and the longer it must be boiled, before it is resolved into *Gelatine*.

a. *Gelatine* is very sparingly soluble in cold water; by contact with which, however, it is caused to swell up and soften. It is readily dissolved by hot water; and forms so strong a jelly on cooling, that 1 part in 100 of water becomes a consistent solid. Its reaction with Tannic acid is so distinct, that 1 part in 5000 of water is at once detected by infusion of Galls. The following are the results of four analyses of *Gelatine* by Scherer and Mulder.

	SCHERER.		MULDER.	
Carbon . . .	50.557	50.774	50.048	50.048
Hydrogen . . .	6.903	7.152	6.477	6.643
Nitrogen . . .	18.790	18.520	18.350	18.388
Oxygen . . .	23.750	23.754	25.125	24.921

The formula deduced by Mulder from this composition, and from the combinations of *Gelatine* with Tannic and Chlorous acids, is 13 C, 10 H, 2 N, 5 O.—When *Gelatine* is boiled for some time, it loses its power of forming a jelly on cooling; and it is stated by Mulder, that this is due to its union with an additional amount of water, a true Hydrate of *Gelatine* being formed by the combination of 4 Equiv. of *Gelatine*, with 1 Equiv. of Water. The same product is obtained by adding Ammonia to the Chlorite of *Gelatine*, and removing by Alcohol the Sal Ammoniac thus formed.

b. It is not yet known how *Gelatine* is produced in the Animal body. There cannot be a doubt that it may be elaborated from Albumen; since we find a very large amount of it in the tissues of young animals, which are entirely formed from albuminous matter; and also in the tissues of herbivorous animals, which cannot receive it in their food, since Plants yield no substance resembling *Gelatine* in composition. It has been suggested by Mulder, that *Gelatine* may be formed by the decomposition of Proteine, which has been already mentioned as taking place from the agency of weak alkaline solutions (§ 116 b), and which must probably, therefore, be continually occurring in the Blood. For, if to each atom of Protid and Erythroptid, we add one of the atoms of Ammonia which are given off in that

decomposition, we have compounds, of which the former differs from Gelatine only by the presence of two additional atoms of hydrogen and the deficiency of one of oxygen, whilst the only difference in the latter consists in the presence of one additional atom of hydrogen. Thus the ammoniated Erythroprotid, when exposed to oxygenation in the lungs, may have its one superfluous atom of hydrogen carried off in the form of water, and will then have the composition of Gelatine; and the same result will be attained from the ammoniated Protid, by the addition of three atoms of oxygen, which will convert it into Gelatine with two atoms of water. According to this formula, the substances produced from the decomposition of the proteine in blood, merely through the action of the alkali in the serum, and the oxydizing influence of the atmosphere, are—carbonic acid, water, gelatinous tissue, and leucin. The carbonic acid passes off through the lungs; and the water, either by the kidneys, or by exhalation from the lungs or skin. The Gelatine only requires *form*, to become Fibrous tissue. Leucin, however, has not yet been found in the body; and until it shall have been discovered, or the products of its decomposition shall have been detected, any such attempt to explain the formation of Gelatine, must be regarded as altogether theoretical.*

c. The relation of Gelatine to the Proteine-compounds is further shown by the fact, that Leucin may be produced from the former, as well as from the latter. When Gelatine is boiled, either with alkalis or with dilute sulphuric acid, Leucin is formed; together with extractive matters, and a peculiar sugar termed *Glycicoll*. This substance crystallizes in large colourless prisms, which have a sweet taste, and feel gritty between the teeth; it is soluble in $4\frac{1}{2}$ parts of water, and is taken up in small quantity by Alcohol. This fact is one of much interest in regard to certain Pathological relations of Gelatine.

142. The *Yellow* Fibrous tissue, on the contrary, undergoes scarcely any change by long boiling; a very small quantity of Gelatine being alone yielded by it; and this being probably derived from the Areolar tissue, by which it is penetrated. It is unaffected by the weaker acids, and undergoes no solution in the gastric fluid; and it preserves its elasticity for an almost unlimited period. According to Scherer, the yellow fibrous tissue from the middle coat of the Arteries consists of 48 C, 38 H, 6 N, 16 O; which (taking Liebig's formula for Proteine) may be regarded as 1 Proteine + 2 Water. When burned, it leaves 1.7 per cent. of ash.

5. Of Simple Cells, floating in the Animal Fluids.

143. The red colour, which is characteristic of the Blood of Vertebrated animals, is entirely due to the presence, in that fluid, of a very large number of floating cells, which have the power of forming a secretion in their interior, that is distinguished by its peculiar chemical nature, as well as by its hue. The red Blood-corpuscles (commonly, but erroneously termed *globules*) are

flattened Discs, which, in Man and most of the Mammalia, have a distinctly circular outline. In the discs of Human blood, when examined in its natural condition, the sides are somewhat concave; and there is a bright spot in the centre, which has been regarded by many as indicating the existence of a nucleus; though it is really nothing else than an effect of refraction, and may be exchanged for a dark one by slightly altering the focus of the Microscope. The form of the disc is very much altered by various reagents: for the membrane which composes its exterior or cell-wall, is readily permeable by liquids; so as to admit a passage of liquid, according to the laws of Endo-

Fig. 27.

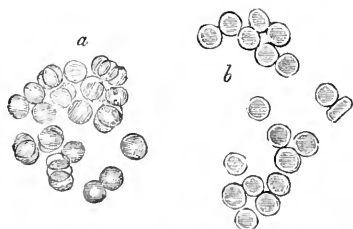

Red Corpuscles of Human Blood, represented at *a*, as they are seen when rather *beyond* the focus of the microscope; and at *b* as they appear when *within* the focus. Magnified 400 diameters.

smose, either inwards or outwards, as the relative density of the contents of

* See Mulder's Chemistry, p. 326.

the cell and of the surrounding fluids may direct. Thus, if the Red corpuscles be treated with water, there is a passage of that liquid into the cell; the disc becomes first flat, and then double-convex, so that the central spot disappears; and by a continuance of the same process, at last becomes globular, and finally bursts, the cell-wall giving way, and allowing the diffusion of the contents through the surrounding liquid. On the other hand, when the Red corpuscles are treated with a thick syrup or solution of albumen, they will be more or less completely emptied, and caused to assume a shrunken appearance; the first effect of the process being to increase the concavity, and to render the central spot more distinct. It is probable that the Blood-corpuscles, even whilst they are circulating in the living vessels, are liable to alterations of this kind, from variations in the density of the fluid in which they float; and that such alterations may be constantly connected with certain disordered states of the system.* We hence see the necessity, in examining the Blood microscopically, for employing a fluid for its dilution, that shall be as nearly as possible of the same character with ordinary liquor sanguinis.†

144. Microscopic observers have been much divided upon the question, whether or not the Red corpuscles of the Blood of Man and other Mammalia contain a nucleus. There seems every probability from analogy, that a nucleus exists in them, as it does in the red corpuscles of all other animals; but it cannot be brought into view by any of the ordinary methods, which render it distinctly visible in the oval blood-discs of Oviparous Vertebrata; and of late the general opinion has been, that nothing resembling *their* nuclei could be present in the blood-discs of Man and Mammalia. Dr. G. O. Rees states, however, that, by carefully examining the ruptured cell-walls, which fall to the bottom of the water when red corpuscles have been diffused through it, he could distinguish appearances on them, that indicated the existence of nuclei; although they escape observation when within the corpuscles themselves, on account of their high refractive power. He describes them as being circular and flattened, like the Red corpuscles themselves; and as about two-thirds of their diameter.

145. In all Oviparous Vertebrata, without any known exception, the red corpuscles are oval,—the proportion between their long and short diameters, however, being much subject to variation; and their nuclei may always be brought into view, by treatment with acetic acid, when not at first visible. In the red particles of the Frog, which are far larger than those of Man, a nucleus can be observed to project somewhat from the central portion of the oval, even during their circulation; and it is rendered extremely distinct by the action of acetic acid; this renders the remainder of the particle extremely transparent, whilst it gives increased opacity to the nucleus, which is then seen to consist of a granular substance.

In the still larger blood-disc of the Proteus and Siren, this appearance is yet

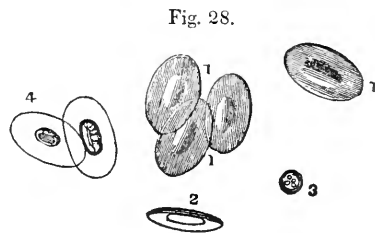

Particles of *Frog's* blood; 1, 1, their flattened face; 2, particle turned nearly edgeways; 3, lymph-globule; 4, blood-corpuscles altered by dilute acetic acid. Magnified 500 diameters.

* See Dr. G. O. Rees' *Gulstonian Lectures*, for 1845.

† By Wagner, the filtered serum of frog's blood is recommended for this purpose. Weak solutions of salt or sugar, and urine, answer tolerably well; but Mr. Gulliver remarks that all addition must be avoided, when it is intended to measure the corpuscles, or to ascertain their true forms; as the serum of one Mammal reacts injuriously on the blood of another. See *Philos. Magaz.*, Jan. and Feb. 1840.

more distinct; the structure of the nucleus being so evident without the addition of acetic acid, that its granules can be counted.*

146. The *form* of the Red Corpuscles is not unfrequently seen to change during their circulation; but this is generally in consequence of pressure: from the effects of which, however, they quickly recover themselves. In the narrow capillary vessels, they sometimes become suddenly elongated, twisted, or bent, through a narrowing of the channel; and this may take place to such a degree, as to enable the disc to pass through an aperture, which appears very minute in proportion to its diameter. When undergoing spontaneous decomposition, the blood-discs become granulated, and sometimes (as long ago noticed by Hewson) even mulberry-shaped; and particles in which these changes appear to be commencing, may be found in the blood at all times. It has been ascertained that bile and urea exert a peculiar solvent power on the blood-corpuscles; and hence we can understand one of the modes in which a retention of these substances in the circulating fluid (Chap. XV., Sect. 1) proves so injurious.—The *size* of the blood-discs is liable to considerable variation, even in the same individual; some being met with as much as one-third larger, whilst others are one-third smaller, than the average. The diameter of the corpuscles bears no constant relation to the size of the animal, even within the limits of the same class; thus, although those of the Elephant are the largest among Mammalia (as far as is hitherto known), those of the Mouse tribe are far from being the smallest, being in fact more than three times the diameter of those of the Musk Deer. There is, however, a more uniform relation between the size of the animal and that of its blood-discs, when the comparison is made within the limits of the same order. In Man, the diameter varies from about 1-4000th to 1-2800th of an inch; the average diameter is probably about 1-3200th.

a. The following measurements of the blood-discs of various animals are chiefly given on the authority of Mr. Gulliver.—The diameter of the corpuscles in the *Quadrupedia* is generally about the same with that of the Human blood-discs; there is, however, a slight diminution among the Lemurs, and there is more variation among them, than among the Monkeys. Among the *Cheiroptera*, the diameter of the corpuscles is somewhat less than in the preceding order, the average being about 1-4300th of an inch. Passing to the *Insectivora*, we find the blood-discs of the Mole to be still smaller, averaging only the 1-4747th of an inch; those of the Hedgehog, however, are larger, being about 1-4085th. In the corpuscles of the different families of the *Carnivora*, there is such a well-marked diversity in the size of the corpuscles, that the fact may be used as a help to classification.† In the Seals,

* As Professor Owen's interesting account of the blood-discs of the Siren may not be generally accessible (Penny Cyclopædia, Art. *Siren*), the leading facts in it will be here stated. This animal agrees with the Proteus and other species in being perennibranchiate (§ 32); and, as in all its congeners yet examined, the blood-discs are of very large dimensions. They are usually of an oval form, the long diameter being nearly twice the short; and the nucleus projects slightly from each of the flattened surfaces. Considerable variety in the form of the disc presents itself, some of the corpuscles being much less oval than others; but the nuclei do not partake of these variations in nearly the same degree. The nucleus is clearly seen to consist of a number of moderately-bright spherical granules, of which from 20 to 30 could be seen in one plane or focus, the total number being of course much greater. When removed from the capsule, the nuclei are colourless, and the component granules have a high refracting power. Viewed *in situ*, they present a tinge of colour lighter than that of the surrounding fluid, and dependent upon the thin layer of that fluid interposed between the nucleus and the capsule. As the fluid contents of the blood-disc in part evaporate during the process of desiccation, the capsule falls into folds in the interspace between the nucleus and the outer margin; these folds generally take the direction of straight lines, three to seven in number, radiating from the nucleus.

† Two facts of much interest in Zoology have been brought to light by Mr. Gulliver's examination of the diameter of the blood-corpuscles of this tribe. The difference between those of the Dog and the Wolf is not greater than that which exists among the varieties of the Dog; whilst the discs of the Fox are much smaller. The discs of the *Hyæna* are far more approximate to those of the *Canidæ*, than they are to those of the *Felidæ*.

the diameter averages 1-3280th of an inch; in the Dog, 1-3540th; in the Bear, about 1-3700th; in the Weasel, 1-4200th; in the Cat, 1-4400th; and in the Viverræ, 1-5365th. In two species only of the *Cetacea*, have the blood-discs been yet examined; the Dolphin, in which their diameter averages 1-3829th of an inch; and the great Rorqual (the largest known Mammal), in which they are only 1-3100th of an inch, or scarcely larger than those of Man. Among the *Pachydermata*, the average excluding the Elephant (the diameter of whose blood-discs is about 1-2745th of an inch), and the Rhinoceros (in which they are about 1-3765th), may be stated at about 1-4200th; and there is less variation than might have been expected, from the different size and conformation of the several species examined. Among the *Ruminantia*, the corpuscles are for the most part smaller than in other orders; and there is more relation between their diameter and the size of the animal, than is elsewhere observable. Excluding the Camelidæ (which are zoologically intermediate between the Ruminantia and Pachydermata), we find a range of sizes extending from the 1-3777th to the 1-12,325th of an inch; the former is the diameter in one of the larger Deer; the latter in the Musk Deer, which is the smallest in the whole order. In the Camel tribe, the average of the long diameter of the corpuscles is about 1-3300th of an inch, whilst that of the short diameter is 1-6300th; and this is nowhere widely departed from: the length of the discs is, therefore, not quite twice their breadth. Among the *Rodentia*, the discs are rather large, especially considering the small size of most of the species. In the Capybara, which is the largest animal of the order, they average 1-3190th; and in the Mouse family (the smallest of Mammalia), they are as much as 1-3814th. In the Squirrels, the diameter is rather less; but in scarcely any of the whole order is it under 1-4000th. Among the *Edentata*, the Two-toed Sloth has been found to have corpuscles of the unusually large diameter of 1-2865th of an inch; whilst in the Armadilloes they average about 1-3400th. In the *Marsupialia* the range is nearly the same as among the *Rodentia*.

b. In *BIRDS*, according to the observations of Mr. Gulliver, the long and short diameters of the corpuscles usually bear to each other the proportion of $1\frac{1}{2}$ or 2, to 1; and this is the general relation among Oviparous Vertebrata, with the exception of some of the Crocodile tribe, in which the length is sometimes three times the breadth. The size of the corpuscles of Birds has generally more relation to that of the species, than it has in Mammalia. No instance has yet been detected, of the occurrence of comparatively small corpuscles in the larger species, and of large corpuscles among smaller animals, which has been seen to be common among the former class; the blood of the Humming-birds, however, has not yet been examined. The largest discs are found among the *Cursores*; those of the Ostrich have an average long diameter of 1-1649th of an inch, and a short diameter of 1-3000th; and among the larger *Raptors*, *Gallatores*, and *Natatores*, the dimensions are but little inferior. The least dimensions hitherto observed are among the small *Passerine* birds; in which the corpuscles have a long diameter of about 1-2400th of an inch, and a transverse diameter of from 1-3800th to 1-4800th. Circular discs may be occasionally observed in some species, agreeing with the others in every particular but their form; and every gradation may be noticed between these and the regular oval corpuscles.

c. The large size of the blood-discs in *REPTILES*, especially in *Batrachia*, and above all, in the *Perennibranchiate* species of the latter, has been of great service to the Physiologist; by enabling him to ascertain many particulars regarding their structure, which could not have been otherwise determined with certainty. Among other facilities which this occasions, is that of procuring their separation from the other constituents of the blood; for they are too large to pass through the pores of ordinary filtering-paper, and are therefore retained upon it, after the liquor sanguinis has flowed through. The blood-discs of the warm-blooded Vertebrata cannot be thus separated. The oval corpuscles of the *Frog* have a long diameter of about 1-1108th, and a transverse diameter of about 1-1800th of an inch; those of the *Salamander* or *Water-newt* are still larger. The long diameter of the corpuscles of the *Proteus* is stated by Wagner to be 1-337th of an inch; that of the *Siren* is about 1-435th, the short diameter being about 1-800th of an inch; the extremes of variation, however, are very wide. The long diameter of the nuclei is about 1-1000th or 1-1100th, and the short diameter about 1-2000th; hence it is about three times as long, and nearly twice as broad, as the entire Human blood-disc, thus having six times its superficies; its thickness is about 1-3800th of an inch.

d. The number of *FISHES*, in which the diameters of the blood-discs have been examined, is still inconsiderable. In the common Perch, they average 1-2100th by 1-2824; in the Carp, they are 1-2142nd of an inch by 1-3429th; in the Gold-Fish, though of the same genus and of much smaller size, they are as much as 1-1777th by 1-2824th; in the Pike, 1-2000th by 1-3555th; and in the Eel, 1-1745th by 1-2842nd.*

* A summary of Mr. Gulliver's numerous and valuable observations is contained in the Proceedings of the Zoological Society, No. CLII.

147. In speaking of the Chemical constitution of the Red Corpuscles of Blood, it is necessary to distinguish the substance of their walls and nuclei from their fluid contents. These may be separated by treating them with water; which, as already mentioned, occasions the rupture of the cells, the walls of which sink to the bottom, whilst their contents are diffused through the liquid. The substance obtained from the former has been termed *Globuline*; but it does not seem to differ in any essential character from other substances, that result from the organization of the proteine-compounds. The compound which forms the contents of the red corpuscles, however, and which gives them their characteristic hue, is very different both in its sensible properties, and in its composition; and has received the designation of *Hæmatine*. When separated from albuminous matter, it is of a dark-brown hue, and is tasteless and insoluble in water, alcohol, and ether; but it is readily soluble in water or alcohol, that contains alkalies or acids; whence it may be supposed to unite with these, like albumen, as an acid or a base. In composition, however, it differs considerably from that of the proteine-compounds; its formula being 44 C, 22 H, 3 N, 6 O, with a single proportional of iron. When burned, it yields a notable quantity of peroxide of iron; and one atom of this is considered to be present in combination with each equivalent of the animal compound. The red colour is not due, however, as formerly supposed, to the presence of this peroxide; for M. Scherer has proved, that the metal may be entirely dissolved away by the agency of acids, and that the animal matter, afterwards boiled in alcohol, colours the spirit intensely red. On the other hand, the iron is most certainly united firmly with the constituents of the *Hæmatine*, as contained in the red corpuscles; for this substance may be digested in dilute sulphuric or muriatic acid for several days, without the least diminution in the quantity of iron, the usual amount of which may be obtained by combustion from the *Hæmatine* that has been subjected to this treatment. When diffused through water, in the manner just described, the *Hæmatine* exhibits the same changes of colour under the influence of oxygen, acids, saline matter, &c., as the Blood undergoes in similar circumstances.

148. The question of the *origin* of the red Blood-corpuscles is a very interesting one, and cannot yet be regarded as completely determined. That they are to be regarded as nucleated cells,—conformable in general character with the isolated cells, which constitute the whole of the simplest Plants (§ 125), and having each an independent life of its own, the duration of which is limited,—there can now be no reasonable doubt. From this we should infer that they have the power of reproducing themselves; and the recent observations of Dr. Barry and other Microscopists seem to confirm the statement long ago made to that effect by Leeuwenhoek. The first change said to take place, is the appearance of delicate radiating lines between the nucleus and the periphery; dividing the disc into several segments, usually six in number (Plate I, Fig. 22.) The margin is soon observed to become cretated, by indentations at corresponding points; and these indentations become deeper, until a complete separation takes place, setting free six young cells or discs (*a, b, c, d, e*), which seem to have been formed around the margin of the nucleus of the parent cell. Between the small newly-generated disc, and the full-sized corpuscle, we should expect to find every intermediate size; and this is affirmed by these observers to be the case.—It has been lately asserted by Dr. G. O. Rees, that, when examining a portion of Blood maintained at about its natural temperature, he observed some of the corpuscles to assume an hour-glass form, by a contraction across their middle; and that, by the increase of this contraction, producing the complete division of the corpuscles, two unequal-sized circular bodies were eventually produced from each; which, when treated

with a strong saline solution, were emptied of their contents, like ordinary blood-discs.—It is not at all improbable, that *both* these methods of multiplication may be followed; and it can scarcely be doubted that, by one or both, a continual succession of Red corpuscles is kept up. That the corpuscles may be generated with great rapidity under peculiar circumstances, will hereafter appear (Chap. XI., Sect. 6); and their amount may undergo a rapid diminution also, without any evident abstraction of them from the circulating fluid. This diminution seems to be traceable in some instances to a too low specific gravity of the serum; which will cause the Red corpuscles to rupture by endosmose, just as when they are treated with water.—Appearances have been seen by Wagner, Gulliver, and others, in the blood of *Batrachia*, which might seem to indicate that the Colourless corpuscles (§ 151) serve as the nuclei of cells, which, when fully developed, may become Red blood-discs; but in the *Mammalia*, it is scarcely possible to imagine that this can occur; since the diameter of the colourless corpuscles is very constant; whilst that of the Red blood-discs is so variable, that the former, though sometimes the smaller, are in other instances far larger than the latter. If it be admitted that the Red corpuscles have the power of reproduction, like other isolated cells, it does not seem necessary to seek elsewhere for the source of their constant renewal; and various facts, hereafter to be stated, appear to the Author strongly indicative of the entire functional as well as structural difference, between the *red* and the *colourless* corpuscles of the blood of *Vertebrata*.

149. That the Red blood-discs, when first formed in the embryo, have an origin common to that of all other tissues, cannot be doubted. They are produced, in the embryo of the Bird, in the portion of the germinal membrane which afterwards becomes the *area vasculosa*; this consists of delicate cells very uniformly disposed: and whilst capillary vessels are being formed by the union of the cavities of these, blood-discs seem to be developed from

Fig. 29.



Production of blood-corpuscles in Chick, on the fourth day of incubation; *a*, particles fully formed; *b*, particles in progress of formation; *c*, similar particles altered by dilute acetic acid, so as to display their nuclei.

the granules or cell-germs they contain. These changes take place about the second or third day of incubation; but it is not until some days afterwards, that the discs assume their characteristic form.

a. Mr. Macleod gives the following history of the development of the blood-corpuscles in the Chick. In blood withdrawn from the heart, on the third day, and diluted with serum, or from the germinal membrane or allantois, and diluted with fluid albumen,—“a number of small granules are seen floating about the field: these enlarge and become clearer in the centre; this enlargement goes on very rapidly, and when they have gained to about twice their original size, the central clear part becomes dull. This dullness slightly increases, and in a short time it is seen to be distinctly granular; whilst the borders are observed to be well-defined, smooth, and clearer than the central part. The enlargement of these bodies, with the granular appearance of their centre, seems *not* to depend on the aggregation of granules round a centre one, but on a property which they have *in* themselves of enlarging and presenting that figure. During all this time they are quite spherical and of good consistence, as they do not lose their form by considerable pressure. In the *second stage*, the central portion gradually becomes less opaque, and ceases to appear granular, the external

portion at the same time separating in some degree from the central part. The blood-corpuscle, in this stage of development, has the appearance of a slightly flattened round cell, formed of a somewhat delicate but elastic membrane, with a nucleus in the centre. At this time a number of these bodies, being close together in the field, presents a yellowish colour. The cell is disc-like, rather concave, but the nucleus convex. In the *third stage*, one side of the corpuscle gradually elongates, giving it a pear-shaped appearance; the opposite side then elongates itself in a similar manner, and to the same degree. The concavity between the nucleus and border disappears, and the whole becomes slightly convex. The hue at the same time gradually becomes redder.*

The corpuscles are generally larger in the embryo than in the adult, especially soon after the period of their first formation; it was remarked by M. Prevost, that in the foetal goat they were at first twice the size of those of the mother. Mr. Gulliver has observed, however, that at a later period of uterogestation they are sometimes smaller than the average dimension of the adult; but perhaps all such observations are to be received with hesitation, owing to the fact mentioned by him, that the variety in the magnitude of the foetal corpuscles is much greater than in the full-grown animal.

150. In regard to the *uses* of the Red corpuscles of the Blood, in the Animal economy, it appears to the Author that a definite conclusion may be now arrived at. Their existence in the circulating fluid is nearly confined to the Vertebrated classes; the corpuscles which are seen in the blood of the Invertebrated, being mostly analogous rather to the Colourless corpuscles, presently to be described as present in the blood of the higher animals. Among the lower Invertebrata, indeed, the Red corpuscles seem to be altogether wanting; and the same may be said of the embryos of the highest animals, at an early period of their development; as well as of the early state of parts that are being newly formed, at any period of their lives. Hence the inference appears highly probable, that they are not essentially necessary to the production of the organizable elements of the blood, or of the organized tissues; in other words, to the simple acts of growth and nutrition. The Red corpuscles are most abundant in those classes among Vertebrata, which maintain the highest temperature; thus, they are somewhat more numerous, in proportion to the whole bulk of the Blood, in Birds than in Mammalia; and far more in the latter, than in Reptiles and Fishes. As it is evident that they undergo very important changes in the pulmonary and systemic capillaries,—their colour being changed from purple to red in the former, and from red to purple in the latter,—it seems highly probable that they have as their principal office, the introduction of oxygen into the blood that circulates through the systemic capillaries, and the removal of the carbonic acid set free there; serving, in fact, as the medium for bringing the tissues into relation with the air, the influence of which is necessary for the maintenance of their vital activity. In the Invertebrata generally, whose respiration is very feeble, this end will be sufficiently answered by the fluid plasma of the blood; the alterations in which, under the influence of the air, have been already noticed (§§ 115, 116 *a*). And in Insects,—the only class whose respiration is at all active, we find the air *directly* conveyed into the tissues; the circulating fluid not being employed as its carrier (§ 18). We shall hereafter find, that the influence of oxygen upon the Nervous and Muscular systems is essential to their vital activity; and it seems to be by their agency in bringing these into relation, that the Red corpuscles possess that intimate connection with the Animal functions, which we find them to possess. The animals whose temperature is the highest, are also those whose senses are most acute, and whose movements are most energetic: whilst, on the other hand, if there be any unusual diminution in the

* London and Edinburgh Monthly Journal, September, 1842.

proportion of Red corpuscles, it is invariably accompanied by muscular debility and deficient nervous power.

a. By Liebig it is supposed, that the *iron* in the red corpuscles is the real agent in the respiratory process: for if its original state be the protoxide, it may become the peroxide by uniting with an additional atom of oxygen, or the protocarbonate by the addition of an atom of carbonic acid. The former change is supposed by him to take place in the lungs, to which the blood comes charged with carbonic acid; the carbonic acid is given up by the iron, and replaced by an equivalent of oxygen taken in from the air: whilst in the systemic capillaries, the converse change takes place,—the oxygen being imparted to the tissues, and being replaced by carbonic acid which is given up by them to be conveyed out of the system. It is stated by Liebig that there is far more than sufficient iron in the whole mass of the blood, to convey in this manner all the oxygen and carbonic acid, which are interchanged between the pulmonary and systemic capillaries. The speculation is certainly an ingenious one; but it can scarcely be yet received as a physiological fact.

151. Besides the *red* particles of the Blood, there are others which possess no colour, and which seem to have a function altogether different; these are known as the *White* or *Colourless* corpuscles. Their existence has long been recognized in the blood of the lower Vertebrata, where, from being much smaller than the red corpuscles, they could readily be distinguished. But it is only of late,—chiefly through the researches of Gulliver, Addison,* and others, that they have been recognized in the blood of Man and other Mammalia; their size being nearly the same with that of the red corpuscles; and the general appearance of the two (owing to the circular form of the latter, and the absence of a proper nucleus,) being less distinct. It is remarkable that, notwithstanding the great variations in the size of the *red* corpuscles in the different classes of Vertebrata, the dimensions of the *colourless* corpuscles are extremely constant throughout; their diameter seldom being much greater or less than 1-3000th of an inch. This has been observed even in those animals,—the Musk-deer, and the Proteus,—which present the widest departure from the general standard in the size of their red corpuscles: so that the colourless corpuscle is as much as four times the diameter of the red, in one instance; whilst it is not one-eighth of the long diameter of the red, in the other. Hence it would seem very improbable, that the red can never be converted into the white, or the white into the red.—The aspect of the two, under the Microscope, is very different. Instead of presenting a distinct central nucleus, like the red corpuscles of the Oviparous Vertebrata,—or being entirely destitute of granular contents, as are those of Mammalia when unaffected by reagents, the colourless corpuscles are studded with minute granules, which may be occasionally seen in active motion within them, and which are discharged when the corpuscles are treated with liquor potassæ. They possess, moreover, a higher refracting power than the red corpuscles; and are further distinguished from them, by their greater firmness, and by the absence of any disposition to adhere to each other; so that, when a drop of recent blood is placed between two strips of glass, and these are gently moved over one another, the white corpuscles may be at once recognized by their solitariness, in the midst of the rows and irregular masses formed by the aggregation of the red. This is still better seen in inflamed blood; in which the Red corpuscles have a peculiar tendency to adhere to one another, whilst the White are present in unusual number.

152. The Colourless corpuscles may be readily distinguished in the circulating Blood, in the capillaries of the Frog's foot; and it is then observable, that they occupy the exterior of the current, where the motion of the fluid is slow, whilst the *red* corpuscles move rapidly through the centre of the tube.

* Transactions of the Provincial Medical Association, 1842 and 1843.

The Colourless corpuscles, indeed, often show a disposition to adhere to the walls of the vessels; which is manifestly increased on the application of an irritant. Hence the idea naturally arises, that (to use the words of Mr. Wharton Jones) “there is some reciprocal relation between the colourless corpuscles, and the parts outside the vessels, in the process of nutrition.” What that relation is, we shall now proceed to inquire.

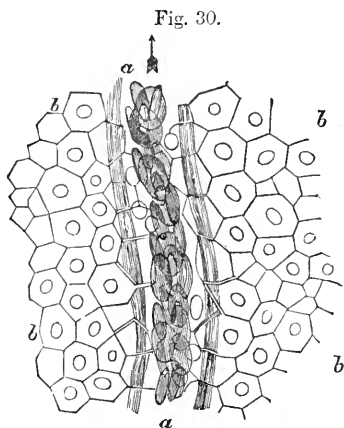

A small venous trunk, *a*, from the Web of the Frog's foot, magnified 350 Diam; *b*, cells of the pavement-epithelium, containing nuclei. In the space between the current of oval blood-corpuscles, and the walls of the vessel, the round transparent white corpuscles are seen.

then disappearing, apparently without having performed any particular function. In the albumen of the Seed, for instance, this often takes place to a remarkable extent. In the Yolk of the Egg, there is a similar transitory development of cells, of which several generations succeed each other, without any permanent structure being the result; and we have seen that, according to Dr. Barry,† a process of the same nature takes place within the germinal vesicle, and in the primary embryonic cells and their descendants (§ 130). It can scarcely be imagined by the well-judging Physiologist, that all this *cell-life* comes into existence without some decided purpose; and if we can assign to it an object, the fulfilment of which is consistent with the facts supplied by analogy elsewhere, this may be reasonably considered as having a fair claim to be received as a physiological induction.—In all these instances, and in many more which might be quoted, the crude alimentary materials are being prepared to undergo conversion into permanent and regularly-organized structures. We have seen that the very first union of the inorganic elements, into the simplest proximate principles, is effected by the *cell-life* of Plants. The change of these principles into the peculiar compounds, which form the characteristic secretions of Plants, is another result of their *cell-life*. And there seems equal ground for the belief that the change of these proximate principles into the peculiar glutinous sap, which is found wherever a formation of new tissue is taking place, is equally dependent upon the agency of cells. Thus, the starchy fluid, which is contained in the ovule previously to its fecundation, is probably not in the state in which it can be immediately rendered subservient to the nutrition of the embryo; and the development of successive generations of cells, which exert upon it their vitalizing influence,

153. In regard to the purpose of the Colourless corpuscles in the Animal economy, a view has been brought forward by the Author,* which increased consideration has only served to strengthen; and which he advances here, with some degree of confidence that it will be found, on attentive examination, warranted by a large number of physiological analogies, though not capable of being directly proved. That it may be rightly understood, a general sketch of certain known operations of cells in Plants and Animals will be first given.—It is not difficult, on taking a comprehensive survey of the Assimilating processes, to find a number of examples, in which *cells* are developed in a temporary manner; growing, arriving at maturity, and

* Report on Cells, in British and Foreign Medical Review, Jan. 1843.

† Embryological Researches. Third Series.

may be reasonably regarded as the means, by which the requisite change is effected. Exactly the same may be said of the Albuminous matter contained in the Yolk of the Egg, which is certainly not in a condition in which it can be immediately applied to the purposes of nutrition; and its conversion may be regarded as commencing with the development of transitory cells within its own substance, and as being completed by means of the cells forming the inner layer of the germinal membrane, by which it is subsequently taken up and introduced into the current of blood flowing through the vascular area (§ 149). A similar purpose is probably answered by the transitory cells developed within the germinal vesicle; and by those which appear at a similar period, in the evolution of the descendants of the "twin cells" produced in it.—Many similar examples have been elsewhere adduced.

a. There are probably cases, however, in which cells are very rapidly called into existence, without that preparatory elaboration of their nutrient materials, which we regard as due to the vital operations of a preceding generation. Thus the *Bovista giganteum*, a large fungus of the Puff-ball tribe, has been known to increase, in a single night, from a mere point to the size of a huge gourd, estimated to contain 47,000,000,000 cellules. In such a case it is difficult to suppose that any but the most rapid mode of generating cells can have been in operation; and the idea that these could not have been developed by any such elaborate process as that just alluded to, is borne out by the fact of their extremely transitory character,—the decay of such a structure being almost as rapid as its production. The same may be remarked of those *fungous* growths in the Animal body, which sprout forth most rapidly. Hence the apparent exception assists in proving the rule.

154. We have thus a class of facts, which indicates that the conversion of the Chemical compound into the organizable principle—the *aplastic* into the *plastic* material—is effected, in the particular situations where it is most wanted, by the vital agency of transitory cell-life; that is, by the production of cells, which are not themselves destined to form an integral part of any permanent structure, but which, after attaining a certain maturity, reproduce themselves and disappear: successive generations thus following one another, until the object is accomplished, after which they altogether vanish. We shall now consider another class of facts, which seem to indicate that a change of this kind is being continually effected in the nutritious fluids of Animals, during their circulation through the body: by Cells, which are either carried about with them, or which are developed for the purpose in particular situations, as in Plants. The former is the more common occurrence; since the conditions of Animal life, usually involving a general movement of the body, require also a constant *general* reparation of its parts, and therefore an adaptation of the circulating fluid to the wants of the whole fabric.

155. It is not in the Blood alone, that floating cells are met with; for Cells, which seem identical with the Colourless corpuscles of the blood, are found in the Chyle and Lymph—fluids in which, as in the Blood, the elaboration of plastic Fibrine from unorganizable Albumen is continually taking place, to make up for the constant withdrawal of the former substance by the nutrient processes. Hence there would seem reason for attributing this important function to these floating cells; the number of which present in the fluids, seems to bear a very close relation with the energy of the elaborating process. It is a fact of great physiological interest and importance, that, whilst the *colourless* corpuscles are to be met with in the nutritious fluids of *all* Animals which possess a distinct circulation, the *red* corpuscles are nearly restricted to the blood of Vertebrata. This observation, which was first put forth by Wagner,* has been confirmed by the Author, who had been previously struck with the very close analogy between the floating cells carried along in the

* [Elements of Physiology, translated by R. Willis.]

current of the circulation in some of the very transparent aquatic larvæ (especially those of the Culicidæ), and the lymph-corpuscles of the Frog. Now it is evident from this fact, that, as the *Blood* of Vertebrata is distinguished from their *Chyle* chiefly by the presence of red corpuscles in the former, and by the absence of those bodies in the latter, the nutritious fluid of Invertebrated animals is rather analogous (as Wagner has remarked) to the *Chyle* and *Lymph*, than to the *Blood* of Vertebrata. Or, to put the same idea in another form, the presence of the *colourless* corpuscles in the nutritious fluid appears to be the *most general* fact in regard to its character throughout the whole Animal scale; whilst the presence of *red* corpuscles in that fluid is *limited* to the Vertebrated classes and the higher Invertebrata. Hence it would not be wrong to infer, that the *function* of the colourless corpuscles must be of a *general* character, and intimately connected with the nutritious properties of the circulating fluid; whilst the function of the red corpuscles must be of a *limited* character, being only required in one portion of the animal kingdom.

156. Further, it has been noticed by Mr. Gulliver, that in the very young embryo of the Mammalia, the white globules are nearly as numerous as the red particles: this, Mr. Gulliver has frequently observed in fetal deer of about $1\frac{1}{2}$ inch long. In a still smaller fœtus, the blood was pale, from the preponderance of the white corpuscles. It is, therefore, a fact of much interest, that, even in the Mammiferous embryo, at the period when growth is most rapid, the circulating fluid has a strong analogy to that of the Invertebrata. It then, too, bears in other respects the most striking analogy to *Chyle*; since it consists of the fluid elaborated from the organizable matter supplied by the parent, and *directly* introduced into the current of the circulation. The function of the placental vessels may be regarded as double: for they are at the same time the channel, through which the alimentary materials supplied by the parent are introduced into the circulating system of the fœtus; and the medium of aerating the fluid, which has traversed the fœtal system. Hence the placenta may be regarded as at once the *digestive* and the *respiratory* apparatus of the fœtus; and the fluid circulating through the cord, as at once *chyle* and *blood*. It is not until the pulmonary and lacteal vessels of the embryo have commenced their independent operation, that the distinction between the *blood* and the *chyle* of the fœtus becomes evident; and we should expect, therefore, to find that the circulating fluid, up to the time of birth, contains a large proportion of white corpuscles,—which is actually the case. There is a gradual decrease, however, in their proportional number, from the earlier to the later stages of embryonic life; in accordance with the diminishing energy of the formative processes. The recent observations of Mr. Newport upon the *Blood* of Insects,* present a remarkable correspondence with the foregoing. He finds in the circulating fluid of the Larva, a number of “oat-shaped” corpuscles or floating cells; which he regards as analogous to the Colourless corpuscles of Vertebrata. These are most numerous at the period immediately preceding each change of skin; at which time the blood is extremely coagulable, and evidently possesses the greatest formative power. The smallest number are met with soon after the change of skin; when the nutrient matter of the blood has been exhausted in the production of new epidermic tissue. In the Pupa state, the greatest number are found at about the third or fourth day subsequent to the change; when preparations appear to be most actively going on, for the development of the new parts that are to appear in the perfect Insect. After this, there is a gradual diminution; the plastic element being progressively withdrawn by the formative processes;

* Philosophical Magazine, May 1845.

until, in the perfect Insect, very few remain. When the wings are being expanded, however, and are still soft, a few oat-shaped corpuscles circulate through their vessels; but as the wings become consolidated, these corpuscles appear to be arrested and to break down in the circulating passages; supplying, as Mr. N. thinks, the nutrient material for the completion of these structures, which subsequently undergo no change. In the perfect Insect, a different set of corpuscles makes its appearance; which is rather analogous to the red corpuscles of Vertebrata. This last fact completely harmonizes with the views already expressed; since the formative processes are now reduced to their lowest condition in the Insect; whilst the respiration attains its highest grade.

157. Even in adult animals, however, variations in formative power may be detected; which correspond with variations in the number of the Colourless corpuscles. Thus it has been observed by Wagner,* that the number of these corpuscles is always remarkably great, in the blood of well-fed Frogs just caught in the summer season; whilst it is very small in those which have been long kept without food, or which are examined during the winter. In the reparation of injuries, too, which is effected in cold-blooded animals by a process of simple growth without inflammation, it would seem that the Colourless corpuscles perform an important part; as they are observed in great numbers, and in a nearly stationary condition, in the vessels surrounding the spot where the new tissue is being formed; apparently having the same action as in the first development of parts altogether new, such as the toes of the larva of the Water-Newt.

158. A remarkable confirmation of this view of the connection between the generation of Colourless corpuscles in the Blood, and the production of Fibrine, is derived from the phenomena of Inflammation. A decided increase in the normal proportion of Fibrine in the Blood (from $2\frac{1}{2}$ to $3\frac{1}{2}$ parts in 1000), may probably be looked upon as the essential indication of the existence of the Inflammatory condition. That this production of Fibrine is due to a *local* change, can scarcely be doubted; since it is frequently observed to commence, before any *constitutional* symptoms manifest themselves: and it may be regarded, in fact, as one cause of these symptoms. Now the microscopic observations of Mr. Addison† and Dr. Williams,‡ made independently of each other, have established the important fact, that a great accumulation of Colourless corpuscles takes place in the vessels of an inflamed part: this seems to be caused at first, by a determination of those already existing in the circulating fluid, towards the affected spot; but partly by an actual increase or generation of these bodies, which appear to have the power of very rapidly multiplying themselves. The accumulation of Colourless corpuscles may be easily seen, by applying irritants to the web of a Frog's foot. Mr. Addison has noticed it in the Human subject, in blood drawn by the prick of a needle from an inflamed pimple, the base of a boil, the skin in scarlatina, &c. And the Author, without any knowledge of these observations, had remarked a very obvious difference between the proportions of Colourless corpuscles, in blood drawn from a wound in the skin of a Frog immediately upon the incision being made, and in that drawn a few minutes after; and had been led, like the observers just quoted, to refer this difference to a determination of Colourless corpuscles to a part irritated. The absolute increase, sometimes to a very considerable amount, in the quantity of Colourless corpuscles in the blood of an inflamed subject, has been verified by Mr. Gulliver and several

* [Elements of Physiology, translated by R. Willis.]

† Medical Gazette, Dec. 1840; Jan. and March, 1841.

‡ Medical Gazette, July, 1841; and Principles of Medicine, [Am. Ed., by Dr. Clymer, pp. 214, 215.]

other observers. These facts, therefore, afford strong ground for the belief, that the production of Fibrine in the blood is closely connected with the development of the Colourless corpuscles; and when we consider them in connection with the facts previously urged, there scarcely appears to be a reasonable doubt that the elaboration of Fibrine is a consequence of this form of cell-life, and is, in fact, its express object.

159. This view derives further confirmation from the following recent experiment of Mr. Addison's.* "Provide six or eight slips of glass, such as are usually employed for mounting microscopical objects; and as many smaller pieces. Having drawn blood from a person with rheumatic fever, or any other inflammatory disease, place a drop of the colourless liquor sanguinis, before it fibrillates, on each of the large slips of glass; cover one *immediately* with one of the smaller slips, and the others one after another *at intervals of thirty or forty seconds*: then, on examining them by the microscope, *the first* will exhibit colourless blood-corpuscles in various conditions, and numerous white molecules distributed through a more or less copious fibrous network; and *the last* will be a tough, coherent, and very elastic membrane, which cannot be broken to pieces nor resolved into smaller fragments, however roughly or strongly the two pieces of glass be made to rub against each other. This is a 'glaring instance' of a compact, tough, elastic, colourless, and fibrous tissue, forming from the colourless elements of the blood; and the several stages of its formation may be actually seen and determined. Numerous corpuscles may be observed, in all these preparations, to have resolved themselves, or to have fallen down into a number of minute molecules, which are spread out over a somewhat larger area than that occupied by the entire corpuscles; and although still retaining a more or less perfectly circular outline, yet refracting the light at their edges, in a manner very different from that in which the corpuscles themselves are seen to do. It is from these and various other larger and more irregular masses of molecules or disintegrated corpuscles, that the fibrinous filaments shoot out on all sides, as from so many centres; or frequently the filaments are more copious in two opposite directions."

a. A different view of the cause of the production of Fibrine, however, has been entertained by some eminent Physiologists; and it does not seem right to allow the opinions of Wagner, Henle, and Wharton Jones to pass without notice, even though they appear to the Author to be easily set aside. By these observers, the elaboration of Fibrine has been attributed to the *red* corpuscles, and has been regarded as one, at least, of their special functions. Nearly all the arguments, however, which have led us to assign this duty to the Colourless corpuscles, tell equally *against* the doctrine now under consideration.—In the first place, the contents of the Red corpuscles have no resemblance whatever to liquid Fibrine; but are characterized by the presence of a substance altogether different: whilst, as shown above, the Colourless corpuscles emit, on bursting, a fibrillating matter. If, then, Fibrine be elaborated by the Red corpuscles, it must be by forming part of their walls: a method altogether unusual.—Again, the entire absence of Red corpuscles in the blood of the lower Invertebrata, and in that of the larva and pupa of the Insect, the small proportion in which they are present in the blood of *any* Invertebrata, and their occurrence to any large amount in the blood of Vertebrata only, seem to show that they cannot be concerned in a function so constant and essential as the elaboration of the plastic element. The number of the Red corpuscles, as stated above, bears a regular proportion to the amount of oxygen introduced into the system, and thus to the heat developed, and to the *activity of the Animal functions*; but it does *not* bear the same relation to the activity of the *formative processes*, which take place most energetically in a state of functional quiescence.—Further, although the quantity of Fibrine is so remarkably increased in Inflammation, the number of Red corpuscles undergoes no decided change. Such an augmentation is even compatible with a Chlorotic state of the blood; the peculiar characteristic of which is a great *diminution* in the proportion of Red corpuscles. By such alterations, the normal proportion between the Fibrine and the Red corpuscles, which may be stated as *a : b*, may be so much altered as to become, in Inflan-

* Transactions of the Provincial Medical Association, 1843.

mation. 4 A : B ; or, in Chlorosis, A : $\frac{1}{2}$ B. In Fever, the characteristic alteration in the condition of the blood, appears to be an increase in the amount of Red corpuscles, with a diminution in the quantity of Fibrine ; yet if a local inflammation should establish itself during the course of a fever, the proportion of fibrine will rise ; and this without any change in the amount of corpuscles.—Lastly, the effect of Loss of Blood has been shown by Andral's investigations, to be a marked diminution in the number of Red corpuscles, with no decided reduction in the quantity of Fibrine, even when this is much above its normal standard ; and in this condition of the blood, it has been observed by Remak that the Colourless corpuscles are very numerous.

6. Of Cells developed upon Free Surfaces.

160. Next in independence to the cells or corpuscles floating in the animal fluids, are those which cover the free membranous surfaces of the body, and which form the *Epidermis* and *Epithelium*. Between these two structures there is no essential difference, either in regard to their origin, their mode of development, their situation, or their individual history ; but there is an important difference in the purposes which they respectively serve in the economy. They both consist of cells, which are developed from germs furnished by the subjacent membrane, which are nourished by its vessels, and which are after a time cast off from its free surface to be replaced by a succeeding generation ; but the contents of the cells vary in different situations, and give peculiar characters to the tissue. The differences, however, are not more striking between the *Epidermis*, or cellular covering of the external surface, and the *Epithelium*, or cellular lining of the internal cavities, than those which exist between the different portions of the *Epithelium* itself. For although the *Epidermis* is distinguished by its comparatively hard, dry, horny character, whilst the *Epithelium* is soft, moist, and deficient in tenacity ; yet we shall hereafter find that, as all the Secretions of the body are elaborated by the agency of the cells of the latter, there must be as many varieties of endowment, in these important bodies, as there are differences in the results of their action.

161. The *Epidermis*,—which usually forms a thin semi-transparent pellicle, in close apposition with the surface of the true Skin, but occasionally presents a great increase in thickness,—consists of a series of flattened scale-like cells ; which, when first formed, are spherical ; but which gradually dry up, their nucleus usually remaining visible. These form several layers ; of which the deeper can be seen very distinctly to possess the cellular character, whilst the external layers are scaly ; and between these, all stages of transformation may be traced. The outer layers are continually being thrown off by desquamation ; and new ones are as constantly being formed below. They would seem to originate in germs supplied by the basement-membrane, on whose surface they make their first appearance ; and their continued development takes place at the expense of nutriment, which they draw through that membrane, from the subjacent vessels. The *Epidermis* is not itself traversed by vessels or nerves ; but it is pierced by the excretory ducts of the sebaceous and sweat glands, and also by the shafts of the hairs ; being, however, at the same

Fig. 31.

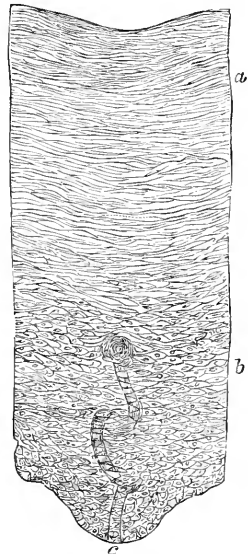

Vertical section of *Epidermis*. from palm of the hand ; a, outer portion, composed of flattened scales ; b, inner portion, consisting of nucleated cells ; c, tortuous perspiratory tube, cut across by the section higher up. Magnified 155 diameters.

time continuous with the epithelial linings of these. The soft layer which lies in immediate contact with the true skin, was formerly supposed to be a substance of distinct nature, and was described under the name of *rete mucosum*; it has been proved by microscopic examination, however, to consist of the same elements with the ordinary epidermis, in an early stage of their development; and, so far from being the exclusive seat of the colour of the skin, as was formerly supposed, it only participates with the fully-formed epidermis in the possession of pigment-cells (§ 163). The thickness of the Epidermis, and consequently the number of layers of which it is composed, vary greatly in different parts; being usually found to be greatest, where there is most pressure or friction,—as on the palms of the hands of the labouring man, and on the soles of the feet, particularly at the heel, and the ball of the great toe. It would seem as if the irritation of the true skin produced an augmented determination of blood to the part, and consequently an increased development of epidermic cells. The Epidermis covers the whole exterior of the body, not excepting the Cornea and the Conjunctival membrane; on the latter, however, it has more the character of an Epithelium. This continuity is well seen in the cast skin or *slough* of the Snake; in which the covering of the front of the eye is found to be as perfectly exuviated as that of any part of the body.

162. The Epidermis appears solely destined for the *protection* of the true Skin, from the mechanical injury and the pain occasioned by the slightest abrasion, and from the irritating influence of exposure to air and of changes of temperature. We perceive the value of this protection, when the Epidermis has been accidentally removed. It is very speedily replaced, however; the increased determination of blood to the Skin, which is the consequence of the irritation, being favourable to the rapid production of Epidermic cells from its surface. The peculiar character of the tissue appears to depend upon the property possessed by its cells, of secreting horny matter into their cavity; and this process seems to take place at a period subsequent to the first formation of the cells. For if a thin vertical section of the Epidermis be treated with Acetic acid, or with a strong solution of Potass, it is found that the inner newly-formed layers are dissolved by the re-agent, whilst the outer or scaly ones are unaffected. Recent analysis has shown, that the dense Epidermis from the sole of the foot, and the compact Horny matter of which Nails, Hoofs, Horns, Hair, and Wool, are composed, have the same composition: the formula of all of them being 48 Carbon, 39 Hydrogen, 7 Nitrogen, and 17 Oxygen. It is probable that, here as elsewhere, if we could isolate the *wall* of the cell from its *contents*, we should find the former to consist of a proteine-compound.

163. Mingled with the Epidermic cells, we find others which secrete Colouring-matter instead of Horn; these are termed *Pigment-cells*. They are not readily distinguishable in the Epidermis of the fair races of mankind, except in certain parts, such as the areola around the nipple, and in freckles, *navi*, &c. But they are very obvious, on account of their dark hue, in the newer layers of the Epidermis of the Negro and other coloured races; and, like true Epidermic cells, they dry up and become flattened scales in passing towards the surface, thus constantly remaining dispersed through its substance, and giving it a dark tint when it is separated and held up to the light. In all races of men, however, we find the most remarkable development of Pigment-cells on the inner surface of the Choroid coat of the eye: where they form several layers, known as the *Pigmentum nigrum*. When examined separately, these are found to have a polygonal form, and to have a distinct nucleus in their interior. The black colour is given by the accumulation, within the cell, of a number of flat, rounded or oval granules, measuring about 1-20,000th

of an inch in diameter, and a quarter as much in thickness; these, when separately viewed, are observed to be transparent, not black and opaque; and

[Fig. 32.

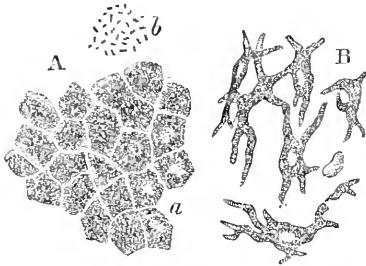

A. Choroid Epithelium, with the cells filled with pigment, except at *a*, where the nuclei are visible. The irregularity of the pigment-cells is seen. *b*. Grains of pigment.

B. Pigment-cells from the substance of the Choroid. A detached nucleus is seen. Magnified 320 diameters.]

Fig. 33.

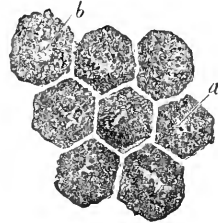

Cells from Pigmentum Nigrum; *a*, pigmentary granules concealing the nucleus; *b*, the nucleus distinct. Magnified 410 diameters.

they exhibit an active movement when set free from the cell, and even whilst inclosed within it.—The Pigment-cells are not always of a simple rounded or polygonal form; they sometimes present remarkable stellate prolongations, such as those seen in the skin of the Frog (Fig. 88); and occasionally, the cells being more nearly approximated to each other, these prolongations communicate, so as to form a kind of network.—The Chemical nature of the Black pigment has not yet been distinctly ascertained; it has been shown, however, to have a very close relation with that of the Cuttle-fish ink, or Sepia, which derives its colour from the pigment-cells of the ink-bag; and to include a larger proportion of carbon than most other organic substances,—every 100 parts containing $58\frac{1}{2}$ of that element.

164. It cannot be doubted that the development of the Pigment-cells of the skin is very much influenced by exposure to *light*; and in this respect there is a remarkable correspondence between Animals and Plants,—the coloration of the latter, as is well known, being entirely due to that agent. Thus, it is a matter of familiar experience, that the influence of light upon the skin of many individuals, causes it to become spotted with brown *freckles*; these freckles being aggregations of brown pigment-cells, which either owe their development to the stimulus of light, or are enabled by its agency to perform a decided chemical transformation, which they could not otherwise effect. In like manner, the swarthy hue, which many Europeans acquire beneath exposure to the sun in tropical climates, is due to a development of dark pigment-cells, and to this we usually find the greatest disposition in individuals or races, that are already of a somewhat dark complexion. The deep blackness of the Negro skin seems dependent upon nothing else than a similar cause, operating through successive generations (§ 80). It is well known that the new-born infants of the negro and other dark races, do not exhibit nearly the same depth of colour in their skins, as that which they present after the lapse of a few days, when light has had time to exert its influence upon their surface; and further, that in those individuals who keep themselves during life most secluded from its influence, we observe the lightest hue of the epidermis. Thus among the intertropical nations, the families of Chiefs, which are not exposed to the sun in the same degree with the com-

mon people, almost always present a lighter hue; and in some of the islands of the Polynesian Archipelago, bordering on the Equator, they are not darker than the inhabitants of Southern Europe.—An occasional development of dark pigment-cells takes place during pregnancy, in some females of the fair races; thus it is very common to meet with an extremely dark and broad areola round the nipple of pregnant women; and sometimes large patches of the cutaneous surface, on the lower part of the body especially, become almost as dark as the skin of a Negro.—On the other hand, individuals are occasionally seen with an entire deficiency of pigment-cells, or at least of their proper secretion; and this not merely in the skin, but in the eye; such are termed Albinos; and they are met with alike among the fair, and among the dark races. The absence of colour usually shows itself also in the hair; which is almost white.

165. The *Nails*, like Hoof, Horn, &c., may be regarded as nothing more than an altered form of Epidermis. When their newest and softest portions are examined, they are found to consist of nucleated particles, resembling those of the newer layers of Epidermis; in the more superficial laminæ, however, no distinct structure can be made out; but, when treated with acetic acid, some traces of nuclei may be detected in them. The Nail is produced from the surface of the true skin that lies beneath it, which is folded into a groove at its root; this surface is highly vascular.

The increase in length is effected by successive additions at the root, causing the whole nail to shift onwards; but as it moves, it receives additional layers from the subjacent skin, which increases its thickness. The nail is continuous with the true Epidermis at every part, except its free projecting edge; and in the fœtus, the continuity is maintained there also.

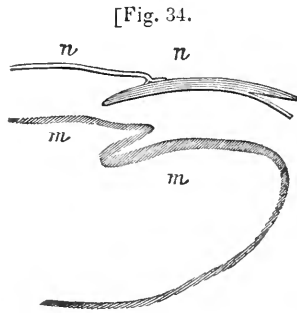

Section of the skin on the end of the finger:—The cuticle, and nail, *n*, detached from the cutis and matrix, *m*]

166. The *Hair*, as originally consisting of Epidermic cells, may be properly described here; although, when fully formed, it departs widely (in Man at least) from the cellular type. It has been imagined until recently, that the Hair, in common with the other Epidermic tissues, is a mere product of secretion; its material, which is chiefly horny matter of the same composition with that of the Epidermis and its appendages, being elaborated from the surface of the pulp at its base. It is not known, however, to contain a distinctly organized structure; and to be formed by the *conversion* of a cellular mass at its root. The Hair originates within a follicle, which is formed by a little depression of the Skin, and which is lined by a continuation of the Epidermis. From the bottom of this follicle, there rises up a cluster of cells, which may be regarded as an increased development of Epidermic cells: the exterior of this cluster, which is the densest part, is known as the *bulb*; whilst the softer interior is termed the *pulp*. The follicle itself is extremely vascular; and even the bulb is reddened by minute injection, though no distinct vessels can be traced into it.—Although the Hairs of different animals vary considerably in the appearances they present, we may generally distinguish in them two elementary parts;—a *cortical* or investing substance, of a fibrous horny texture; and a *medullary* or pith-like substance, occupying the interior. The fullest development of both substances is to be found in the spiny Hairs of the Hedgehog, and in the quills of the Porcupine; which are but hairs on a magnified scale. The cortical substance forms a dense horny tube, to which the firmness of the structure seems chiefly

due; whilst the medullary substance is composed of an aggregation of very large cells, which seem not to possess any fluid contents in the part of the hair which is completely formed. The structure of the feather of Birds is precisely analogous; the cortical horny tube existing alone in the quill; but being filled with a cellular medulla in the stem of the feather itself. In the hair of the Mouse and other small Rodents, we see the horny tube crossed at intervals by partitions, which are sometimes complete, sometimes only partial; these are the walls of the single or double line of cells, of which the medullary substance is made up. In the Sable, we sometimes meet with hairs, in which the medulla is made up of rounded cells: whilst the cortical substance is composed of imbricated Epidermic scales (Fig. 35, B). In some instances, however, there is scarcely any medulla to be traced; whilst in other animals, as the Musk-deer (Fig. 35, A), the entire hair seems to be made up of it.

Fig. 35.

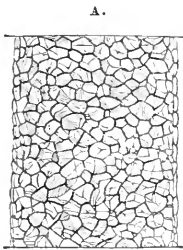

B.

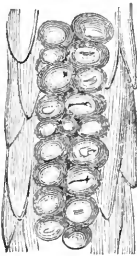

A, hair of Musk-Deer consisting almost entirely of polygonal cells; B, hair of Sable, showing large rounded cells in its interior, covered by imbricated scales, or flattened cells.

[Fig. 36.

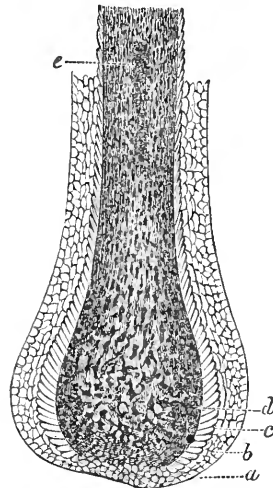

Bulb of a small black hair, from the scrotum, seen in section. *a*. Basement membrane of the follicle. *b*. Layer of epidermic cells resting upon it, and becoming more scaly as they approach *c*, a layer of imbricated cells, forming the outer lamina, or *cortex*, of the hair. These imbricated cells are seen more flattened and compressed, the higher they are traced on the bulb. Within the cortex is the proper substance of the hair, consisting at the base, where it rests on the basement membrane, of small angular cells scarcely larger than their nuclei. At *d*, these cells are more bulky, and the bulb consequently thicker; there is also pigment developed in many of them more or less abundantly. Above *d*, they assume a decidedly fibrous character, and become condensed. *e*. A mass of cells in the axis of the hair, much loaded with pigment.]

167. In the Human hair, the representation of the cortical sheath of the hair of other animals is found in a thin transparent horny film; which is composed of flattened cells or scales, arranged in an imbricated manner, their edges (Fig. 36) forming delicate lines upon the surface of the hair, which are sometimes transverse, sometimes oblique, and sometimes apparently spiral (Fig. 37, A). Within this, we find a cylinder of fibrous texture; which forms the

principal part of the shaft of the hair; whilst the centre is frequently more distinctly cellular. The constituent fibres of the shaft are marked out by delicate longitudinal striæ, which may be traced in vertical sections of the hair (Fig. 37, B); but they may be still more completely demonstrated by crushing the hair, after it has been macerated for some time in dilute acid. In dark hairs, pigmentary granules are frequently scattered between the fibres; but they are usually found in greater abundance in the central cells. The Hair of Man is commonly reputed to be tubular; but this is seldom if ever the case, as is shown by microscopical examination of thin transverse sections (Fig. 37, C). The mistake has arisen from a misinterpretation of the appearance of a dark band in the interior of the hair, when viewed by transmitted light; which is really due, partly to the presence of pigmentary matter in the central portion of the shaft, and partly to the refraction of light by the cylindrical surface.—The chemical composition of Hair, as already stated,

Fig. 37.

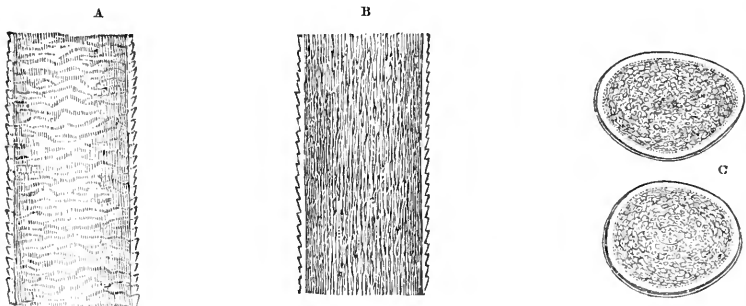

Structure of Human Hair; A, external surface of the shaft, showing the transverse striæ and jagged boundary, caused by the imbrications of the scaly cortex; B, longitudinal section of the shaft, showing the fibrous character of the medullary substance, and the arrangement of the pigmentary matter; C, transverse sections, showing the distinction between the cortical and medullary substance, and the central collection of pigmentary matter, sometimes found in the latter. Magnified 310 diameters.

is precisely the same with that of the horny Epidermis (§ 162). Its colouring matter seems related to Hæmatine; it is bleached by Chlorine; and its hue appears to be dependent in part upon the presence of iron, which is found in larger proportion in dark than in light hair.

168. The real nature of the different elements of the Hair is ascertained, by examining them at its base, where they become continuous with those of the bulb. It is then seen, that the fibres of the shaft are identical with the cells of the bulb; these undergoing elongation, as they are pushed upwards towards the mouth of the follicle, by the development of additional cells beneath; and being proportionably diminished in diameter. Hence the shaft of the hair is considerably narrower than the bulb. The central part of the hair which more distinctly exhibits the cellular character, is derived from the pulp or internal portion of the bulb; whose constituent cells undergo less change. And the imbricated layer of cells, that forms its fibrous envelope, may be said to be a prolongation of the ordinary Epidermis over the surface of the hair; being developed from the external portion of the bulb, where it is continuous with the epidermic lining of the follicle.—Thus we see that the whole tissue of the Hair is derived from Epidermic cells, developed in peculiar abundance from the base of the follicle; some of these cells, however, retaining their original form; whilst others are transformed into fibres, and others converted (like those of ordinary Epidermis) into flattened cells. They all have the power, however, of drawing horny matter into their cavities; and resist the

solvent power of chemical re-agents, except when these are employed in unusual strength.—The Hair is constantly undergoing elongation, by the addition of new substance at its base; and the part which has been once fully formed, and which has emerged from the follicle, usually undergoes no subsequent alteration. There is evidence, however, that it *may* be affected by changes at its base, the effect of which is propagated along its whole extent: thus, it is well known that cases are not unfrequent, in which, under the influence of strong mental emotion, the whole of the hair has been turned to gray, or even to a silvery white, in the course of a single night; a change which can scarcely be accounted for in any other way than by supposing that a fluid, capable of chemically affecting the colour, is secreted at the base of the hair, and transmitted by imbibition through the medullary substance to the opposite extremity. Another evidence of their retention of a degree of vitality, is found in the fact of Hairs having a tendency to become pointed, after having been cut short off. In the hairs of some animals (particularly the whiskers of the Seal and other Carnivora) the base is hollow, and contains a true papilla, or elevation of the cutis, furnished with nerves and blood-vessels; this is separated by a layer of basement-membrane from the proper tissue of the Hair. In such cases, there is bleeding from the stumps of the hairs, when they are shaved off close to the skin. There is an approach to this papillary structure in Man; and it may perhaps be an abnormal development of it, which occasions the hair to bleed in the disease termed *Plica Polonica*. The hair of individuals affected with it is further disposed to split into fibres, often at a considerable distance from the roots, and to exude a glutinous substance; these two causes unite in occasioning that peculiar *matting* of the hair, which has given origin to the name of the disease.

169. The layer of cells covering the internal free surfaces of the body, is known under the name of *Epithelium*. In some instances it appears to serve to the subjacent membranes, like the Epidermis to the Cutis, merely as a protection; whilst in other cases, as we shall presently find, it answers purposes of far greater importance. It has long been known that the epidermic layer might be traced continuously from the lips to the mucous membrane of the mouth, and thence down the œsophagus into the stomach; and that, in the strong muscular stomach or gizzard of the granivorous birds, it becomes quite a firm horny lining. But it has been only since the application of the Microscope to this investigation, that a continuous layer of cells has been traced, not merely along the whole surface of the mucous membrane lining the alimentary canal, but likewise along the free surfaces of all other Mucous Membranes, with their prolongations into follicles and glands; as well as on the Serous and Synovial membranes, and the lining membrane of the heart, blood-vessels, and absorbents.

170. The forms presented by the *Epithelium* cells are various. The two chief, however, are the *tesselated*, forming the *pavement-epithelium*; and the *cylindrical*, forming the *cylinder-epithelium*.—The Tesselated Epithelium covers the serous and synovial membranes, the lining membrane of the blood-vessels, and the ultimate follicles or tubuli of most glandular structures connected with the skin or mucous membranes, as also the mucous membranes themselves, where the cylinder-epithelium does not exist. The cells composing it are usually flattened and polygonal (Fig. 38, A.) so as to come into contact with each other at their edges, like the pieces of a tesselated pavement (Fig. 30); but they sometimes retain their rounded or oval form, and are separated from each other by considerable interstices. (Fig. 38, B.) This last form seems to be the commonest, where the cells are most actively renewed, so that they have not time (so to speak) to be developed into a continuous stratum. The number of layers is commonly small; and sometimes there is

only a single one.—The Cylinder-Epithelium is very differently constituted. Its component cells are cylinders, which are arranged side by side; one extre-

Fig. 38.

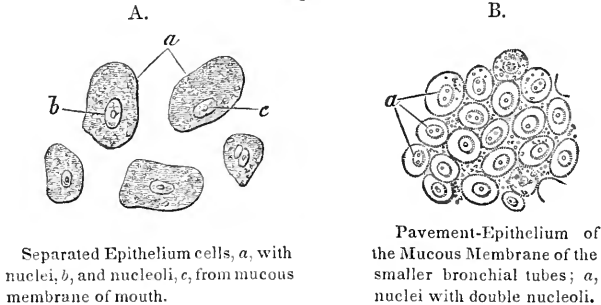

Separated Epithelium cells, *a*, with nuclei, *b*, and nucleoli, *c*, from mucous membrane of mouth.

Pavement-Epithelium of the Mucous Membrane of the smaller bronchial tubes; *a*, nuclei with double nucleoli.

mity of each cylinder resting upon the basement-membrane, whilst the other forms part of the free surface. The perfect cylindrical form is only shown, however, when the surface on which the cylinders rest is flat or nearly so. When it is *convex*, the lower ends or basements of the cells are of much smaller diameter than the upper or free extremities; and thus each has the form of a truncated cone, rather than of a cylinder; as is well seen on the cells covering the villi of the intestinal canal. (Fig. 45.) On the other hand, where the cylinder-epithelium lies upon a concave surface, the free extremities of the cells may be smaller than those which are attached. Sometimes each cylinder is formed from more than one cell, as is shown by its containing two or more nuclei; although its cavity seems to be continuous from end to end. And occasionally the cylinders arise by stalk-like prolongations, from a pavement-epithelium beneath. The two forms of Epithelium pass into one another at various points; and various transition-forms are then seen,—the tessellated scales appearing to rise more and more from the surface, until they project as long-stalked cells, truncated cones, or cylinders. The Cylinder-Epithelium covers the mucous membrane of the alimentary canal, from the cardiac orifice downwards; it is found also in the larger ducts of the glands which open into it, or upon the external surface—such as the ductus choledochus, the salivary ducts, those of the prostate and Cowper's glands, the vas deferens, and urethra. In all these situations, it comes into connection with the Tessellated Epithelium, which usually lines the more delicate canals of the glands, as well as their terminal follicles.

171. Both these principal forms of Epithelial cells are frequently observed to be fringed at their free margins with delicate filaments, which are termed *Cilio*; [from *cilium*, an eyelash,] and these, although of extreme minuteness, are organs of great importance in the animal economy, through the extraordinary motor power with which they are endowed. The form of the Ciliary

filaments is usually a little flattened, and tapering gradually from the base to the point. Their size is extremely variable; the largest that have been observed being about 1-500th of an inch in length, and the smallest about 1-13,000th. When in motion, each filament appears to bend from its root to its point, returning again to its original state, like the stalks of corn when depressed by the wind; and when a number are affected in succession with this motion, the appearance of progressive waves following one

Fig. 39.

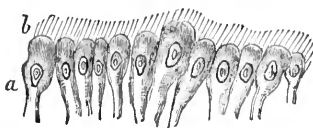

Vibratile or ciliated Epithelium; *a*, nucleated cells, resting on their smaller extremities; *b*, cilia.

another is produced, as when a corn-field is agitated by frequent gusts. When the Ciliary motion is taking place in full activity, however, nothing whatever can be distinguished, but the whirl of particles in the surrounding fluid; and it is only when the rate of movement slackens, that the shape and size of the Cilia, and the manner in which their stroke is made, can be clearly seen. The motion of the Cilia is not only quite independent (in all the higher animals at least) of the will of the animal, but is also independent even of the life of the rest of the body; being seen after the death of the animal; and proceeding with perfect regularity in parts separated from the body. The isolated epithelium cells have been seen to swim about actively in water, by the agency of their cilia, for some hours after they have been detached from the mucous surface of the nose; and the Ciliary movement has been seen fifteen days after death in the body of a Tortoise, in which putrefaction was far advanced. In the gills of the River-Mussel, which are among the best objects for the study of it, the movement endures with similar pertinacity.

172. The purpose of this Ciliary movement is obviously to propel fluids over the surface on which it takes place; and it is consequently limited in the higher animals to the internal surfaces of the body, and always takes place in the direction of the outlets, towards which it aids in propelling the various products of secretion. The case is different, however, among animals of the lower classes, especially those inhabiting the water. Thus the external surface of the gills of Fishes, Tadpoles, &c., is furnished with cilia; the continual movement of which renews the water in contact with them, and thus promotes the aeration of the blood. In the lower Mollusca, and in many Zoophytes, which pass their lives rooted to one spot, the motion of the Cilia serves not merely to produce currents for respiration, but likewise to draw into the mouth the minute particles that serve as food. [Fig. 107, 2, 5.]

And in the free-moving Animalcules, of various kinds, the Cilia are the sole instruments which they possess, not merely for producing those currents in the water, which may bring them the requisite supply of air and food, but also for propelling their own bodies through the liquid element. This is the case, too, with many larger animals of the class Aculepha (Jelly fish), which move through the water, sometimes with great activity, by the combined action of the vast numbers of cilia, that clothe the margins of their external surfaces. In these latter cases, it would seem as if the Ciliary movement were more under the control of the will of the animal, than where it is concerned only in the organic functions. In what way the will can influence it, however, it does not seem easy to say; since the ciliated epithelium-cells appear to be perfectly disconnected from the surface on which they lie, and cannot, therefore, receive any direct influence from their nerves. Of the cause of the movement of the Cilia themselves, no account can be given; they are usually far too small to contain even the minutest

[Fig. 40.]

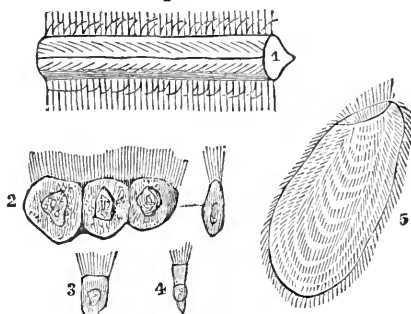

Examples of Cilia: 1. portion of a bar of the gill of the sea-mussel, *Mytilus edulis*, showing cilia at rest and in motion; 2. ciliated epithelium particles from the frog's mouth; 3. ciliated epithelium particles from inner surface of human membrana tympani; 4. ditto, from the human bronchial mucous membrane; 5, *Leucophrys patula*, a polygastric infusory animalcule; to show its surface covered with cilia, and the mouth surrounded by them]

fibrillæ, of muscle; and we must regard them as being, like those fibrillæ, organs *sui generis*, having their own peculiar endowment,—which is, in the higher animals at least, that of continuing in ceaseless vibration, during the whole term of the life of the cells to which they are attached.

[That this movement is truly molecular and independent of muscular influence and of both the vascular and nervous systems has been proved by experiment. For, besides continuing to manifest itself in a single particle for many hours after it has been isolated from the rest of the system, a ciliated surface continues unaffected in its movements though the supply of blood to the subjacent tissues be completely cut off. Neither do hydrocyanic acid, opium, strychnine, belladonna, substances which affect powerfully the nervous system, exert any influence on ciliary motion; this phenomenon continuing in the bodies of animals killed by these poisons. And lastly, shocks of electricity passed through the ciliated parts, even the removal of the brain and spinal marrow in frogs, extinguishing as it does muscular motion, do not destroy the action of cilia.—M. C.]

The length of time during which the Ciliary movement continues after the general death of the body, is much less in the warm-blooded than in the cold-blooded animals; and in this respect it corresponds with the degree of persistence of muscular irritability, and of other vital endowments.

173. A layer of Ciliated epithelium, of the Tesselated form, is found upon the delicate pia mater which lines the cerebral cavities, not even excepting the infundibulum and the aqueduct of Sylvius; and it is also found in the terminal ramifications of the bronchial tubes. A Cylindrical epithelium furnished with Cilia is found lining the nasal cavities, the frontal sinuses, the maxillary antra, the lachrymal ducts and sac, the posterior surface of the velum pendulum palati, and fauces, the Eustachian tube, the larynx, trachea, and bronchi to their finest divisions, the upper portion of the vagina, the uterus, and the Fallopian tubes. The function of the Cilia in all these cases appears to be the same; that of propelling the secretions, which would otherwise accumulate on these membranes, towards the exterior orifices, whence they may be carried off.

174. The Epithelium-cells, like the scales of the Epidermis, are continually being cast off and renewed from the subjacent surface; but the rapidity of this renewing process varies according to the particular function of the part. Thus we shall hereafter find it to be greater on the Mucous Membranes, which are actively engaged in the introduction of nutrient materials and in the separation of effete matter, than it is on the Serous surfaces, which are comparatively inert. The epithelial cells that cover the plane surfaces, seem to be developed from granular germs, scattered through the subjacent basement membrane; but it is different in regard to the cells of the glandular follicles, which usually seem to originate in a single "germinal spot," composed of a mass of granules, at the blind extremity of the follicles. In fact, each of these follicles may be regarded as a parent-cell, which was closed at an earlier period of its existence, and which, even after it has ruptured and given exit to its contents, goes on forming a succession of new generations from its nucleus.

The accompanying figure represents two follicles of the liver of the common Crab, which are seen to be filled with secreting cells; and it is evident, from a comparison of the sizes of the cells at different parts, that they originate at the blind extremity of the follicle, where there is a germinal spot; and that, as they recede from that point and approach the outlet of the follicle, they gradually increase in size and become filled with their characteristic secretion; being at the same time pushed onwards towards

Fig. 41.



Two follicles from the liver of *Carcinus manas* (Common Crab), with their contained secreting cells.

the outlet, by the continual new growth of cells at the germinal spot.*—It is by the continual growth and exuviation of the cells which line the glandular follicles, that the various products of Secretion are separated from the blood; and it is in cells occupying a similar position, that the Spermatozoa or Reproductive particles are developed (Plate I., Fig. 18). In each case, the growth of the cell, and the nature of its product, depend upon its own peculiar vital properties; and it is a curious fact that the seminal cells, in which the Spermatozoa are formed, are ejected from the gland in the Decapod Crustaceous animals, not only before they have burst and set free the Spermatozoa, but even long before the development of the Spermatozoa in their interior is completed,—the process being perfected, after the cells have been deposited in the generative passages of the female.†

7. Of the Compound Membrano-Fibrous Tissues.

175. Having now considered the Elementary components of the Tissues of the Human body,—namely, Membranes, Fibres, and Cells,—we proceed to notice certain structures, in which these elements are united in their simplest form; and, in the first place, those termed *Serous* and *Synovial* Membranes. When examined with the Microscope, their free surface is found to be covered with a single layer of Pavement-Epithelium, which lies on a continuous sheet of Basement-Membrane. Beneath this last is a layer of condensed Areolar tissue, which constitutes the chief thickness of the membrane, confers upon it its strength and elasticity; this gradually passes into that laxer variety, by which the membrane is attached to the parts it lines, and which is commonly known as the subserous tissue. The yellow fibrous element enters largely into the composition of the membrane itself; and its filaments interlace into a beautiful network, which confers upon it equal elasticity in every direction. The membrane is traversed by blood-vessels, nerves, and lymphatics, in varying proportions. The Serous and Synovial membranes form, as is well known, closed sacs, which contain a greater or less proportion of fluid. The liquid effused from the Serous membranes is nearly the same with the Serum of the blood; containing as much as 7 or 8 per cent. of albumen and salts; and being distinctly alkaline, from the presence of carbonate or albuminate of soda. There is no reason for regarding it in any other light, than as a simple product of *transudation*. The fluid contained in the Synovial capsules, and in the Bursæ Mucosæ, may be considered as serum with from 6 to 10 per cent. of additional albumen; it shows an alkaline reaction.‡ The fluid of Dropsy (at least in some forms of this disease) contains in addition urea, and cholesterine suspended in fine plates; also (according to Dr. Kane) stearine and elaine.

176. The general term *Mucous Membrane* may be applied to that great system of membranous expansions, which forms the external tegument, or Skin,—the lining of the internal cavities whose walls are continuous with it, or Mucous Membrane proper,—and the prolongations of this into the secreting organs, forming the tubes and follicles of the Glands. These all consist, as Mr. Bowman has justly remarked,§ “of certain elements, which the Anatomist may detect and discriminate; some of them being essential, others appended or superadded: and the broad characteristic distinctions between

* Goodsir, in *Anatomical and Pathological Observations*, Chap. v.

† Op. Cit. p. 39.

‡ This is probably a true *secretion*, formed by the agency of the epithelium-cells that cover certain delicate highly-vascular fringe-like projections, which hang down into the synovial capsules.

§ *Cyclopædia of Anatomy and Physiology*, vol. iii. p. 485.

these structures, appreciable to ordinary sense—as well as the innumerable gradations by which they everywhere blend insensibly with one another,—are solely due to various degrees and kinds of modification wrought in the form, quantity, and properties of these respective elementary parts.”—The Mucous Membrane may be said, like the Serous, to consist of three chief parts,—the epithelium or epidermis covering its free surface,—the subjacent basement-membrane,—and the areolar tissue, with its vessels, nerves, &c., which forms the thickness of the membrane, and connects it to the adjacent parts. Of the *Epithelium* and *Epidermis*, a general description has been given in the preceding Section. The *Basement-Membrane* may be frequently demonstrated with very little trouble, in the tubuli of the glands, especially the kidney; which are but very slightly adherent, by their external surface, to the surrounding tissue. Its existence on the Skin, and on many parts of the proper Mucous Membrane, has not yet been fully proved; but there can be no reasonable doubt of its continuity in these situations.—These two elements may be regarded as the essential constituents of Mucous membrane; which is thus found to be, strictly speaking, extra-vascular. Its difference from Serous Membrane must be considered, therefore, as depending rather upon its arrangement, and upon the peculiar secretion of its epithelium-cells, than upon any decided anatomical character.

177. The tissues appended to these elements, and less essential to the character of Mucous Membrane, are Capillary Blood-vessels, Absorbents,

Fig. 42.

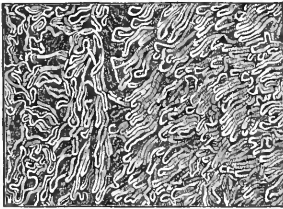

Distribution of Capillaries at the surface of the skin of the finger.

Fig. 43.

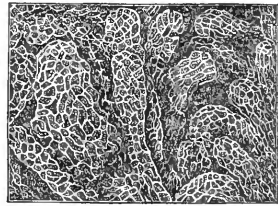

Distribution of Capillaries in the Villi of the Intestine.

Nerves, and Areolar tissue. The former are almost everywhere abundant; in the Skin they seem chiefly destined to supply the nervous papilla, and thus minister to its acute sensibility; whilst in the Mucous Membrane of the Alimentary canal, they seem more concerned in the functions of Absorption and Secretion; and in the Glandular organs, they supply the materials for the last-named process.

Fig. 44.

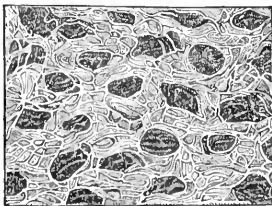

Distribution of Capillaries around follicles of Mucous Membrane.

The Absorbents are most abundant, as Lymphatics, in the Skin; and as Lacteals, in the Mucous Membrane of the first part of the Intestinal canal; but the Lymphatics are also largely distributed through some of the Glandular organs. The Skin is the only part of this system, which is largely supplied with Nerves; except the Conjunctival Membrane, and the Mucous Membrane of the Nose: hence the sensibility of this structure is usually low, although its importance in the organic functions is so great. The Areolar tissue of Mucous Membranes usually makes up the greatest part of their thickness; and is so distinct from the subjacent layers, as to be readily separable from them. It differs not, however,

in any important particular, from the same tissue elsewhere; and the white and the yellow fibrous elements may be detected in it, in varying proportions, in different parts,—the latter being especially abundant in the Skin and the Lungs, which owe to it their peculiar elasticity. Hence the Mucous Membranes for the most part yield Gelatine, on being boiled. There is some reason to believe, that the Skin also contains non-striated muscular fibres scattered through it.—The *regeneration* of all the forms of Mucous Membrane, after loss of substance by disease or injury, is very complete, and takes place with considerable rapidity.

178. The essential character of the Mucous Membranes, in regard alike to their offices and their arrangement, is altogether different from that of the Serous and Synovial membranes. For, whilst the latter form shut sacs, whose contents are destined to undergo little change, the former either cover the external surface of the body, or line tubes and cavities in its interior, which have free outward communications; and they thus constitute the medium, through which *all* the changes are effected, that take place between the living organism and the external world. Thus, in the gastro-intestinal mucous membrane, we find a provision for reducing the food, by means of a solvent fluid poured out from its follicles; whilst the villi, or root-like filaments, which are closely set upon the surface of that same membrane, are specially adapted to absorb the nutrient materials thus reduced to the liquid state. This same membrane, at its lower part, constitutes an outlet through which are cast out, not merely the indigestible residuum of the food, but also the excretions from numerous minute glandulæ in the intestinal wall, which result from the

Fig. 45.

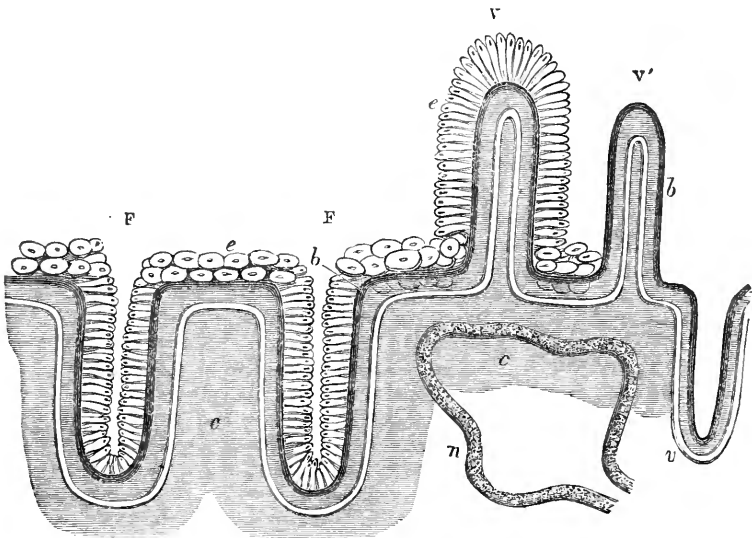

Diagram of the structure of an involuted Mucous Membrane, showing the continuation of its elements in the follicles and villi; F, F, two follicles; b, basement membrane; c, submucous tissue; e, epithelium; v, villus, covered with epithelium; v', villus whose epithelium has been shed.

decomposition of the tissues, and which must be separated and cast forth from them to prevent further decay. Again, the bronchio-pulmonary mucous membrane serves for the introduction of oxygen from the air, and for the exhalation of water and carbonic acid. The mucous membranes prolonged into the

interior of the various glands, are the instruments by which their respective products are eliminated from the blood. And lastly, the Skin is concerned in two great classes of changes; the excretion of various matters from its surface, and from the glandulæ in its substance; and the reception of impressions upon the nerves, with which it is so copiously supplied.

179. The character of the secretions formed by the Mucous Membranes, is different in almost every part; and is dependent, as will be shown hereafter, upon the properties of the Epithelium-cells which cover them. These cells, instead of forming a comparatively permanent stratum, like that which covers the surface of serous membranes, are in a state of continual change and renewal; the older layers falling off, whilst new ones are produced in immediate contact with the subjacent membrane,—and this, not merely on its simple plane surfaces, but on its prolongations, whether these form the coverings of villi, or the lining of follicles. The purpose of the cells which form the Epidermis, is simply to protect the sensitive surface of the true skin; and these cells have the power of drawing a horny matter into their interior. On the other hand, the Epithelium cells of the ultimate tubuli or vesicles of glands, contain the substances which characterize the secretions of those glands. It is chiefly on the bronchio-pulmonary and gastro-intestinal mucous membranes, that we meet with the peculiar secretion termed *Mucus*; which appears to be expressly formed to shield them from the irritation they would suffer through the contact of air, or of solids or liquids. This secretion is also found on the lining membrane of the larger excretory ducts of most of the glands; and it is mixed, in greater or less amount, with most of the secretions discharged by them. It is found also upon the lining membrane of the gall-bladder, and of the urinary bladder. When these membranes are in a state of unusual irritation, the amount of mucus which they discharge is very considerable; but it ordinarily forms an extremely thin layer. The characters of *Mucus*, obtained from various sources, are by no means invariable. In general, however, it may be described as a fluid of peculiar viscosity, either colourless or slightly yellow, transparent or nearly so, incapable of mixing with water, and sinking in it, except when buoyed up by bubbles entangled in its mass, which is commonly the case with the bronchial and nasal mucus. This fluid contains from $4\frac{1}{2}$ to $6\frac{1}{2}$ per cent. of solid matter, of which a small part consists of salts resembling those of the blood: whilst the chief organic constituent is a substance termed *Mucin*, to which the characteristic properties of the secretion are due. This appears to be an albuminous compound, altered by the action of an alkali; for as Dr. Babington has shown, any albuminous fluid may be made to present the peculiar viscosity of mucus, by treating it with liquor potassæ. That the mucin of *Mucus* is held in solution by an alkali, appears from this, that it is readily precipitated by acids, which neutralize the base; and that a sort of faint coagulation may be induced even by water, which withdraws the base from it. When *Mucus* is examined with the Microscope, it is found to contain numerous epithelium-scales (or flattened cells); together with round granular corpuscles, considerably larger than those of the blood, and closely resembling the nuclei of the epithelium-cells, which are commonly termed mucus-corpuscles. In the more opaque mucus, discharged from membranes in a state of irritation or inflammation, these corpuscles are present in greatly-increased amount; and cells are often developed around them.

8. *Of Simple Isolated Cells, forming Solid Tissues by their Aggregation.*

180. We now proceed to a class of Cells, which are equally independent of each other, which begin and end their lives as cells without undergoing any

transformation, but which form part of the substance of the fabric, instead of lying upon its free surfaces and being continually cast off from them. Still their individual history is much the same as that of the cells already noticed; and they differ chiefly in regard to the destination of their products. There are many animals, in which such aggregations of cells make up a much larger part of the fabric, than they do in Man; and this in consequence of their retaining more of the embryonic type of structure in their adult condition. Thus in the Myxinoid family of Fishes, there is no true Vertebral column; but its place is supplied by a gelatinous tube, termed the *chorda dorsalis*; which consists of nucleated cellular tissue, and which is precisely analogous to the structure occupying the same position in the early embryo of higher animals. In the Short Sunfish, a corresponding form of tissue forms a thick covering to the body, replacing the true skin. And in the Lancelot (a little Fish which is deficient in so many of the characters of the Vertebrated division, that many naturalists have doubted its right to a place in the class), a considerable portion of the fabric is made up of a like cellular parenchyma.

181. The first group of this class deserving a separate notice, is that which effects the introduction of aliment into the body;—of those kinds of aliment, at least, which are not received in solution by any more direct means. These cells (first pointed out by Mr. J. Goodsir) form a cluster at the extremity of each of the villi of the intestinal tube; the origin of the lacteal being lost in the midst of it. If examined whilst the absorbent process is going on, they are found to be turgid with a milky fluid, which is evidently the same with that of the lacteals; and to have a diameter of from 1-2000th to 1-1000th of an inch (Fig. 46, A). In the intervals of the digestive process, the extremities of the villi are comparatively flaccid: and instead of cells, they show merely

Fig. 46.

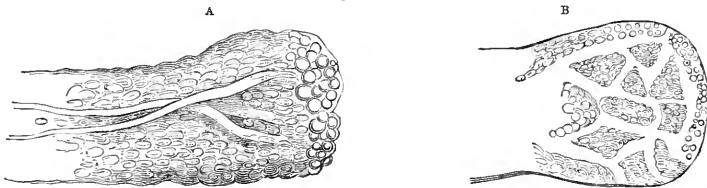

Extremity of intestinal villus; seen at A, during absorption, and showing absorbent cells and lacteal trunks, distended with chyle; at B, during interval of digestion, showing peripheral network of lacteals, with granular germs of absorbent cells, as yet undeveloped, lying between them.

a collection of granular germs (Fig. 46, b). These begin to develop themselves, as soon as the food has been dissolved in the stomach and transmitted to the intestine; and their development goes on so long as they are surrounded with nutrient matter. The cells grow, select, absorb, and prepare the nutritious matter, by making it a part of themselves; and, when their work is accomplished, they deliver it to the lacteals by their own rupture or deliquescence,—at the same time, it is probable, setting free the germs, from which a new generation may be developed, when the next supply of chyle is prepared.

182. Although the mucous membrane of the intestinal tube is the only channel, through which insoluble nutriment can be absorbed in the completely-formed Mammal, and the only situation, therefore, in which we meet with these absorbent cells, there are other situations, in which similar cells perform analogous duties in the embryo. Thus, the Chick derives its nutriment, whilst in the egg, from the substance of the yolk, by absorption through the blood-vessels, spread out in the vascular layer of the germinal membrane that surrounds it; which vessels answer to the blood-vessels and lacteals of the per-

manent digestive cavity, and are raised into folds or villi, as the contents of the yolk-bag are diminished. Now the ends of the vessels are separated from the fluid contents of the yolk-bag by a layer of cells, which is filled with matter of a yellow-colour; and which seems to have for its office, to select and prepare the materials supplied by the yolk, for being received into the absorbent vessels. In like manner, the embryo of the Mammal is nourished, up to the time of its birth, through the medium of its umbilical vessels; the ramifications of which form tufts, that dip down (as it were) into the maternal blood, and receive from it the materials destined for the nutrition of the fœtus; besides effecting the aeration of the blood of the latter, by exposing it to the more oxygenated blood of its mother. Now around the capillary loop of the fœtal tuft there is a layer of cells, closely resembling the absorbent cells of the villi; and these are inclosed in a cap of basement-membrane, which completes the fœtal portion of the tuft, and renders it comparable, in all essential respects, to the intestinal villus. It is again surrounded, however, by another layer of membrane and of cells, belonging to the maternal system; the derivation of which will be explained hereafter (Chap. XVII).

183. The cells which make up the parenchyma of the Liver in the higher animals, seem to be developed under conditions somewhat similar. In the Invertebrata, the Liver is constructed upon the type of the glands in general; its secreting cells being developed as an epithelium upon the inner wall of the hepatic ducts. This does not appear to be the case, however, in Man and the Mammalia: the substance of whose liver is made up of an aggregation of

Fig. 47.



Secreting Cells of Human Liver; a, nucleus; b, nucleus; c, oil-particles.

cells, which lie—so far as can be ascertained—upon the *outside* of the terminal ramifications of the hepatic ducts. That these cells are the efficient instruments in the secreting process, is evident from the nature of their contents, which consist of biliary matter with oil globules. Their diameter is usually from 1-1500th to 1-200th of an inch; and they generally contain a very distinct nucleus. Their connexion with the secreting process is further marked by the fact, that, in some instances in which the bile has not been eliminated, and death has been the result, Microscopic examination has proved that the hepatic cells were either very imperfectly formed or were almost entirely deficient.

Further, in cases of Fatty Liver, the cells have been found to contain an unusual amount of Adipose matter.

[Fig. 48.]

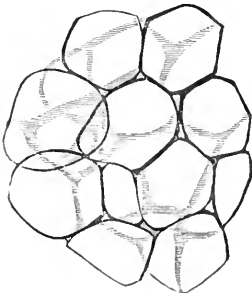

Fat vesicles, assuming the polyhedral form from pressure against one another. The capillary vessels are not represented.—From the omentum; magnified about 300 diameters.]

184. The *Fat-cells*, of which *Adipose* tissue is composed, also permanently exhibit the original type of structure in its simplest form. This tissue is usually diffused over the whole body, filling up interstices, and forming a kind of pad or cushion for the support of moveable parts. Even in cases of great emaciation, some Fat is always left; especially at the base of the heart, around the origin of the large vessels; in the orbit of the eye; in the neighbourhood of the kidney; in the interior of the bones; and within the spinal canal, between the periosteum and the dura mater. The Fat Cells are usually spherical or spheroidal; sometimes, however, when closely pressed together without the intervention of any intercellular substance, they become polyhedral. The nucleus is not always to be distinguished;—perhaps in consequence of its having passed to the interior of

the cell; it has been seen, however, in the fat-cells of the embryo. The diameter of the greater number of fat-cells, is between 1-300th and 1-600th of an inch; but larger and smaller sizes are frequently to be met with. These bodies frequently present themselves in an isolated condition, dispersed among the meshes of Areolar tissue; but when they are aggregated so as to form masses of fat, they are first collected into little lobular clusters, each of which has a delicate membranous investment; and these are again united into larger clusters, visible to the naked eye. The aggregation of these often forms masses of considerable size; the component parts being held together by Areolar tissue, and also by the blood-vessels which penetrate them, and which ramify minutely among them, forming a capillary network, not only upon the surface of the smallest lobules, but even (it would appear) between their contained fat-cells. In some forms of Adipose tissue, such as the marrow of bones, it would seem that very little areolar tissue exists, or that it is even entirely absent; and here the capillary plexus forms the principal bond of union between the fat-cells. No lymphatics have been detected in Adipose tissue; and it would seem to be equally destitute of nerves, excepting such as are passing through it on their way to other textures;—thus accounting for the known fact of its being insensible, except when those trunks are injured.

Fig. 49.

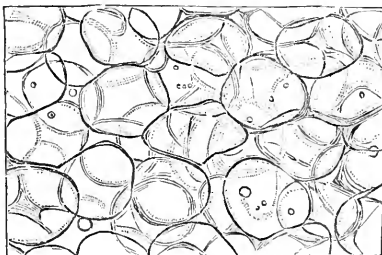

Cells of Adipose Tissue; magnified 135 diameters.

[Fig. 50.]

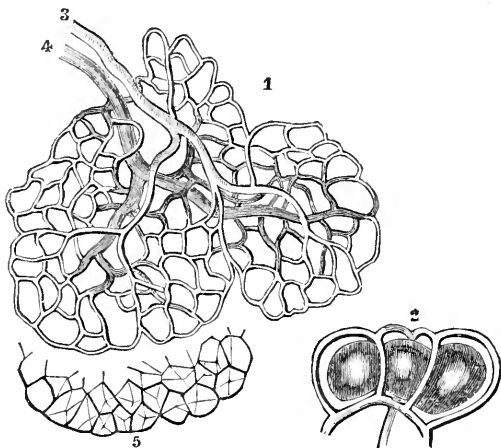

Blood-vessels of Fat; 1, minute flattened fat-lobule, in which the vessels only are represented; 3, the terminal artery; 4, the primitive vein; 5, the fat vesicles of one border of the lobule, separately represented.—magnified 100 diameters: 2, plan of the arrangement of the capillaries on the exterior of the vesicles.—more highly magnified.]

185. The consistency of the substance contained in the Fat-vesicles, varies in different animals, according to the proportions of the organic elements, that enter into its composition. These elements are known under the names of Stearine, Margarine, and Oleine: the two former, which are solid when sepa-

[Fig. 51.]

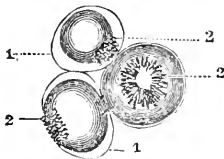

Fat vesicles from an emaciated subject; 1, 1, the cell-membrane; 2, 2, 2, the solid portion collected as a star-like mass; with the elaine in connection with it, but not filling the cell.]

rate, being dissolved in the latter, at the ordinary temperature of the body. That the thick oil thus formed does not escape from the fat-cells during life, may be attributed to the moistening of their walls by the aqueous fluid circulating through the vessels. In all fixed oils, which are fluid at common temperatures, a portion of the solid constituents of fat exists; these may be separated by exposure to cold, which congeals them, leaving the Oleine fluid. All these substances are regarded by chemists in the light of salts; being compounds of acids—the Stearic, Margarin, and Oleic—with a common base, to which, from its sweetish taste, the name of Glycerine has been given.

a. Stearine is the essential constituent of nearly all solid fats, and preponderates in proportion to their consistence. It exists largely in mutton-suet; from this it may be obtained by the action of ether, which takes up all the oily matter. It is crystalline, like spermaceti; it is not at all greasy between the fingers, and melts at about 130° . It is insoluble in water, and in cold alcohol and ether; but it dissolves in boiling alcohol or ether, crystallizing as it cools. Stearic acid (the substance of which the *stearine candles* are composed) may be separated, by causing it to combine with a stronger base, such as lime or potash, and then setting it free from this by a stronger acid. It crystallizes in milk-white needles; is soluble in its own weight of cold alcohol, and in all proportions at a boiling heat; and fuses at about 158° . Its acid powers are sufficient to decompose the alkaline carbonates.—*Margarine* exists in small quantity, along with Stearine, with most fats; but it is the principal solid constituent of Human fat, which in this respect resembles olive oil rather than the other animal fats. It corresponds with Stearine in many of its properties; but it is much more soluble in alcohol and ether; and it melts at 116° . Margarinic acid closely resembles stearic acid in most of its properties; but it is more soluble in cold alcohol; and has a lower melting-point, viz., 110° , or thereabouts. It may be procured from stearic acid, by subjecting the latter to a dry distillation.—*Oleine* exists in small quantity in the various solid fats; but it constitutes the great mass of the liquid fixed oils. The tendency of these to solidification by cold, depends upon the proportion of stearine or margarine they may contain; for oleine itself remains fluid at the zero of Fahrenheit's thermometer. It is soluble in cold ether, from which it can only be separated by the evaporation of the latter. Oleic acid much resembles oleine in physical characters, being colourless, lighter than water, and not prone to solidify; but it has a distinct acid reaction, and a sharp taste, and is miscible with cold alcohol in all proportions.—*Glycerine*, the base of all the fatty acids, may be obtained from any fatty matter, by saponifying it with an alkaline base, by which this compound is set free. It cannot be obtained in a solid form, but may be brought to the consistence of a thick syrup. It dissolves in water and alcohol; but is insoluble in ether. It has a sweetish taste, whence its name is derived; and it is remarkable for its solvent powers, which are scarcely inferior to those of water.—The following table shows the atomic composition of the fatty acids, and of their base.

Stearic Acid	68 Carbon, 66 Hydrogen, 5 Oxygen.
Margaric Acid	68 Carbon, 66 Hydrogen, 6 Oxygen.
Oleic Acid	44 Carbon, 39 Hydrogen, 4 Oxygen.
Glycerine	6 Carbon, 8 Hydrogen, 6 Oxygen.

The following results of the ultimate analysis of different kind of Fat, show the close correspondence in their composition; and at the same time make apparent the very large proportion of carbon which they all contain.

	Hog's Lard.	Mutton Fat.	Human Fat.
Carbon	79.098	78.996	79.000
Hydrogen	11.146	11.700	11.416
Oxygen	9.756	9.304	9.584
	100.000	100.000	100.000

186. Besides the support, combined with facility of movement, which Fat affords to the moving parts of the body, it answers the important purpose of assisting in the retention of the animal temperature, by its non-conducting power; and the still more important object, of serving as a kind of reservoir of combustible matter against the time of need. Herbivorous animals, whose

food is scanty during the winter, usually exhibit a strong tendency to such an accumulation, during the latter part of the summer, when their food is most rich and abundant; and the store thus laid up is consumed during the winter. This is particularly evident in the hibernating Mammalia, which take little or no food during their seclusion. Fat appears to be deposited, only where there is an excess, in the alimentary matter introduced into the body, of non-azoized compounds which may be converted into it. But the ingestion of a large quantity of these in the food, is by no means sufficient for the production of Fat; for they may not be absorbed into the vessels; and, if absorbed, there may be a want of power to generate Adipose tissue,—so that they would accumulate injuriously in the blood, if not drawn off by the Liver. Hence some persons never become fat, however large the quantity of oily matter ingested; and it is in such persons, that the tendency to disorder of the Liver from over-work is most readily manifested; hence they are obliged to abstain from the use of fat-producing articles of food.

187. In *Cartilage*, also, the simple *cellular* structure is very obviously retained, and frequently exists alone; although in some forms of this tissue, it is united with the fibrous, or partly replaced by it. In all, however, the early stage of formation appears to be the same. The structure originates in cells, analogous to those of which the rest of the fabric is composed; but between these cells, a larger quantity than usual of hyaline or intercellular substance is deposited; and the amount of this substance continues increasing, simultaneously with the bulk of the cells. The original cells are pushed farther and farther from one another; but new cells arise between them from germs which are contained in the hyaline substance. The first cells frequently produce two or more young cells from their nuclei; and thus it is very common to meet with

groups of such cells or corpuscles, consisting of two, three, or four.—The varieties in the permanent Cartilages principally depend upon the degree of organization, which subsequently takes place in the intercellular substance. If a mass of Fibres, analogous to those of the fibrous membranes (§ 138), should originate in it, the Cartilage presents a more or less fibrous aspect; in some instances the Fibrous structure is developed so much, at the expense of the Cells, that the latter disappear altogether, and the whole structure becomes fibrous. Sometimes the fibres which are developed, are rather analogous to those of the Elastic tissue (§ 140); these are disposed around the cells, forming a kind of network, in the areolæ of

Fig. 52.

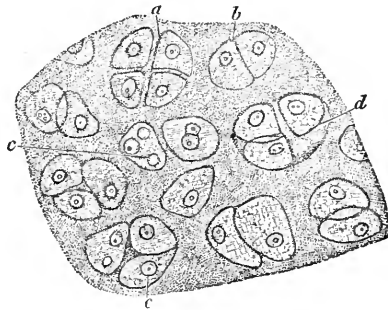

Section of the Branchial cartilage of Tadpole; *a*, group of four cells, separating from each other; *b*, pair of cells in apposition; *c*, *c*. nuclei of cartilage cells; *d*, cavity containing three cells.

consisting of two, three, or four.—The varieties in the permanent Cartilages principally depend upon the degree of

Fig. 53.

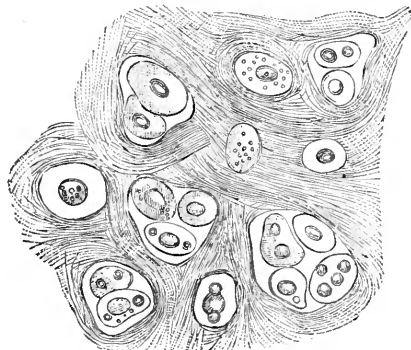

Section of Fibro-Cartilage; showing disposition of cartilage cells, in areolæ of fibrous tissue.

which they lie; and this kind of cartilage may be termed the elastic or reticular. The primitive *cellular* organization is for the most part retained in the ordinary articular cartilages,* the cartilaginous septum narium, the cartilages of the alæ and point of the nose, the semilunar cartilage of the eyelids, the cartilages of the larynx (with the exception of the epiglottis), the cartilage of the trachea and its branches, the cartilages of the ribs (in Man) and the ensiform cartilage of the sternum; and it is seen also in the temporary cartilages, or those which are destined to undergo ossification. The *fibrous* structure is seen in all those Cartilages, which unite the bones by synchondrosis; this is the case in the vertebral column and pelvis, the cartilages of which are destitute of corpuscles, except in and near their centres. In the lower Vertebrata, however, and in the early condition of the higher, the fibrous structure is confined to the exterior, and the whole interior is occupied by the ordinary cartilaginous corpuscles. The *reticular* structure is best seen in the epiglottis and in the concha auris: in the former of these, scarcely any trace of cartilage-cells remains; in the latter, the fibrous network disappears by degrees towards the extremity of the concha, and the structure gradually passes into the cellular form.†

a. The substance that gives to the Cellular Cartilages their peculiar character, has received the designation of *Chondrine*. It bears much resemblance to ordinary Gelatine, but requires longer boiling in water for its solution; the solution fixes on cooling, like that of gelatine; and when it becomes dry by evaporation, it has the appearance of solid glue. Chondrine is not precipitated, however, by tannic acid; on the other hand, it gives precipitates with acetic acid, alum, acetate of lead, and proto-sulphate of iron, which do not disturb a solution of Gelatine. That the Chondrine obtained by boiling Cartilage is an actual component of that tissue, and is not a product of the operation, appears from the agreement between its elementary composition and that of cartilage, when analyzed by combustion. According to Mulder, the proportions of the elements, as deduced from the definite compound which Chondrine forms with Chlorine, are 32 C, 26 H, 4N, 14 O, with 1-10th of an equivalent of Sulphur. Chondrine agrees much more nearly with the proteine-compounds, in its elementary composition, than does Gelatine; and may be considered as a sort of intermediate stage between the two. Chondrine is not obtainable from any of the Fibro-cartilages; these yield gelatine, on boiling, exactly similar to that of the tendons. The Elastic cartilages, after being boiled for several days, yield a small quantity of an extract, which does not form a jelly, but which has the other chemical properties of Chondrine. The cartilage of Bone, before ossification, yields only Chondrine; after ossification, however, it affords only Gelatine; and it is curious that, even when bony deposits take place in the permanent cartilages, the ossified portion contains ordinary Gelatine in the place of Chondrine. Many of the cartilages naturally contain a large proportion of mineral matter; in the costal cartilages, fractures in which are generally repaired by osseous substance, from 3 to 7 per cent. of ash is left by calcination. This contains a large proportion of the carbonate and sulphate of soda, together with carbonate of lime and a small proportion of phosphate; as age advances, the phosphate of lime predominates, and the soluble compounds diminish.

188. Cartilage (at least in its simplest form) is nourished, without coming into direct relation with the Blood through the medium of blood-vessels; the *cellular* Cartilages not being *penetrated* by vessels in the healthy state; although in certain diseased conditions they become distinctly vascular. They are, however, *surrounded* by Blood-vessels; which form large ampullæ or varicose dilatations at their edges or on their surfaces (Fig. 54): and from these the Cartilages derive their nourishment by imbibition; in exactly the same manner as the frond of a Sea-weed (the structure of which is alike cellular) draws into itself the requisite fluid from the surrounding medium. In the thicker masses of cartilaginous tissue, however, such as the cartilages of

* The articular cartilages, at the points where tendons are implanted into them, have all the characters of fibro-cartilage; the fibres of the tendon being spread through the intercellular substance of the cartilage, for some distance, and gradually coalescing with it.

† See Mr. Toynebee's Memoir on the Non-Vascular Tissues, Phil. Trans. 1841.

the ribs, we find canals excavated at wide distances from each other; which are lined by a continuation of the perichondrium or investing membrane of the cartilage, and which thus allow its vessels to come into nearer proximity with parts, that would be otherwise too far removed from them. The vessels, however, nowhere pass from the walls of these canals into the substance of the cartilage. Similar vascular canals are found in the temporary cartilages, near the points where the ossifying process is taking place; this is well seen in the long bones, towards their extremities. At an early period of fetal life, there is no distinction between the cartilage that is ultimately to become the Osseous Epiphysis, and that which is to remain as Articular Cartilage; both are alike cellular; and the vessels that supply them with nutrient materials penetrate no further than their surfaces. At a subsequent period, however, when the ossification of the epiphysal cartilage is about to commence, vessels are prolonged into it; and a distinct line of demarcation is seen betwixt the *vascular* portion, which is to be converted into Bone, and the *non-vascular* part, which is to remain as Cartilage. At this period, the Articular Cartilage is

Fig. 54.

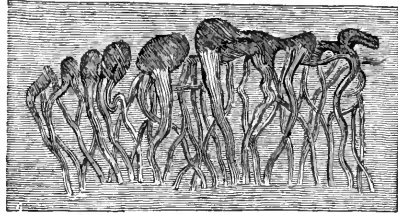

Vessels between the Articular Cartilage and attached Synovial Membrane. (After Toynbee.)

Fig. 55.

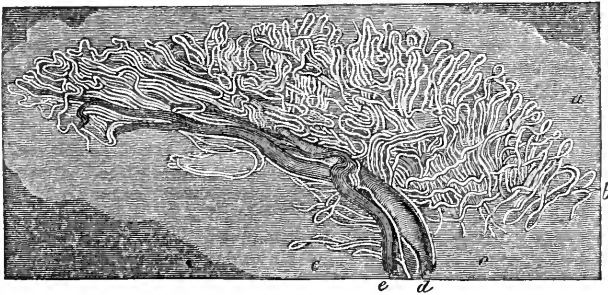

Vessels situated between the attached synovial membrane, and the articular cartilage, at the point where the ligamentum teres is inserted in the head of the os femoris of the human subject, between the third and fourth months of fetal life; *a*, the surface of the articular cartilage; *b*, the vessels between the articular cartilage and the synovial membrane; *c*, the surface to which the ligamentum teres was attached; *d*, the vein; *e*, the artery.

nourished by a plexus of vessels spread over its free surface, beneath its synovial membrane; as well as by the vessels, with which it comes in contact at its attached extremity. Towards the period of birth, however, the sub-synovial vessels gradually recede from the surface of the articular cartilage; and at adult age they have entirely left it, though they still form a band which surrounds its margin. The Fibrous cartilages are somewhat vascular; but the vessels do not extend to the cellular portions, where such exist.

189. No vessels can be traced (according to Mr. Toynbee) into the substance of the true Cornea; which, contrary to the statement of Müller, is a cellular rather than a fibrous cartilage. The cells are not so numerous as are those of the articular cartilages; and they are surrounded by a plexus of bright

Fig. 56.

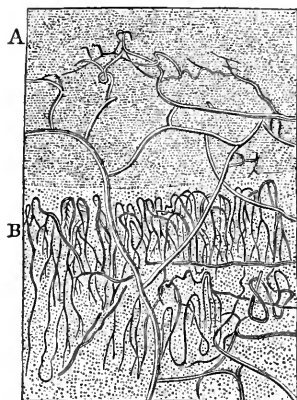

Nutrient Vessels of the cornea. A, superficial vessels belonging to the Conjunctival membrane, and continued over the margin of the Cornea; B, vessels of the Sclerotic, returning at the margin of the Cornea.

fibres, laxly connected together, so as to resemble areolar tissue. Two sets of vessels, a superficial and a deep-seated, surround the margin of the cornea. The arteries of the former are prolonged for a short distance upon the Conjunctival membrane, which forms the outer lamina of the cornea; but they terminate in veins at from $\frac{1}{8}$ to $\frac{1}{2}$ a line from its margin. The deep-seated vessels belong to the Cornea proper; but they do not enter it, the arteries terminating in veins just where the tissue of the Sclerotic becomes continuous with that of the Cornea. In diseased conditions of the Cornea (as of the articular cartilages), both sets of vessels extend themselves through it; the superficial not unfrequently form a dark band of considerable breadth round its margin; whilst the deep-seated are prolonged into its entire substance. Notwithstanding the absence of vessels in the healthy condition of this structure, incised wounds commonly heal very readily, as is well seen after the operation of extraction of Cataract; but the foregoing details make evident the importance of not carrying

the incision further round than is necessary; since the corneal tissue should not be cut off from the supply of nourishment, afforded by the vessels in its immediate proximity.

[This structure has been recently studied by Messrs. Todd and Bowman, and is described by them with great accuracy. We subjoin their description. "The cornea, though a beautifully transparent substance, and appearing at first sight as homogeneous as glass, is nevertheless full of elaborate structure. It is in fact composed of five coats or layers, clearly distinguishable from one another. These are, from before backwards, the *conjunctival layer of epithelium*, the *anterior elastic lamina*, the *cornea proper*, the *posterior elastic lamina*, and the *epithelium of the aqueous humour*, or *posterior epithelium*. The cornea, when uninflamed, contains no blood-vessels; those of the surrounding parts running back in loops, as they arrive at its border.

On the *cornea proper*, or *lamellated cornea*, the thickness and strength of the cornea mainly depend. It is a peculiar modification of the white fibrous tissue, continuous with that of the sclerotic. At their line of junction (fig. 57), the fibres, which in the sclerotic have been

Fig. 57.

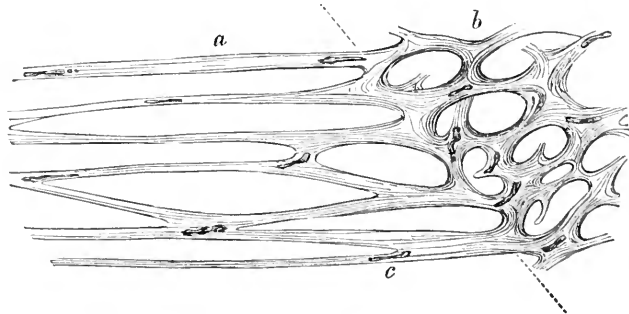

Vertical section of the Sclerotic and Cornea, showing the continuity of their tissue between the dotted lines.—a. Cornea. b. Sclerotic. In the cornea the tubular spaces are seen cut through, and in the sclerotic the irregular areolae. Cell-nuclei, as at c, are seen scattered throughout, rendered more plain by acetic acid. Magnified 320 diameters.

densely interlaced in various directions, and mingled with elastic fibrous tissue, flatten out into a membranous form, so as to follow in the main the curvatures of the surfaces of the cornea, and to constitute a series of more than sixty lamellæ, intimately united to one another by very numerous processes of similar structure, passing from one to the other, and making it impossible to trace any one lamella over even a small portion of the cornea. The resulting areolæ, which in the sclerotic are irregular, and on all sides open, are converted in the cornea into tubular spaces, which have a very singular arrangement, hitherto undescribed. They lie in superposed planes, the contiguous ones of the same plane being for the most part parallel, but crossing those of the neighbouring planes at an angle, and seldom communicating with them (fig. 58). The arrangement and size of these tubes can be shown by

Fig. 58.

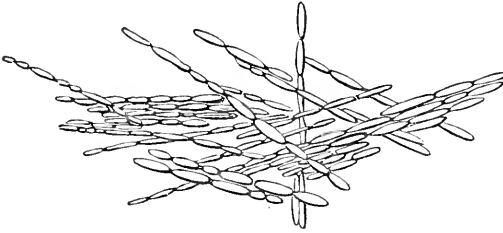

Tubes of the Cornea Proper, as shown in the eye of the Ox by mercurial injection. Slightly magnified.

driving mercury, or coloured size, or air, into a small puncture made in the cornea. They may also be shown under a high power by moistening a thin section of a dried cornea, and opening it out by needles. The tissue forming the parietes of these tubes is membranous rather than fibrous, though with the best glasses a fibrous striation may be frequently seen, both in the laminæ separating the different series of tubes, and in that dividing those of the same layer from each other. By acetic acid, also, the structure swells, and displays corpuscles resembling those apparent in the white fibrous tissue. Such is the lamellar structure of the cornea, which makes it so much easier to thrust an instrument horizontally than vertically into its substance. The tubes or elongated spaces of which we have spoken, are not distended with any fluid, but are merely moistened in the same way as the areolæ of ordinary areolar tissue. A perfectly fresh and transparent cornea is rendered opaque by pressure, but it regains its brilliance on the removal of the compressing force. Some have supposed this to result from the expulsion of fluid from between its laminæ; but that the opacity is owing simply to a derangement of the elementary parts of its structure is plain from the fact, that the same phenomena are exhibited by a section, however thin, immersed in water, and deranged by stretching.]

190. In connection with the cornea, it is natural to allude to the Crystalline lens and Vitreous humour, which have a structure essentially the same. The structure of the Crystalline lens has long been known to be fibrous; and Sir D. Brewster has shown, by the aid of polarized light, the very beautiful manner in which the fibres are arranged.* They are united into laminæ, by means of numerous teeth or sinuosities at their edges, which lock into one another. That these fibres originate in cells, has been clearly ascertained; but the nature of the metamorphosis has been differently stated by two eminent observers, Schwann and Barry. By the former, the fibres are considered to be prolonged cells: whilst the latter regards them as rather formed upon the plan of the tubes of muscular fibre (§ 235), several cells coalescing into one; in this he is supported by Mr. Toynee, who states that he has frequently seen the fibres, towards the margin of the lens, made up of such cells. After it is fully formed, however, it is not permeated by blood-vessels; these being confined to the capsule. During the early part of fetal life, and in inflammatory conditions of this membrane, both the anterior and posterior portions of the capsule are distinctly vascular; but at a later period, according to

* Philosophical Transactions, 1833.

Mr. Toynbee, the posterior half only of the capsule has vessels distributed over its surface; and these are derived from the *Arteria centralis retinae*. From optical experiments which have been suggested to him by this circumstance, he infers that "objects (radiating lines for instance), situated on the *anterior* surface of the crystalline lens, produce an indistinctness in the image which is formed upon the retina; whereas, when these lines exist upon the *posterior* surface of the lens, the image is clear." The substance of the Lens contains about 42 per cent. of animal matter, with 58 parts of water. Nearly the whole of the former may be dissolved in cold water by trituration; the solution is coagulated by heat, and forms a granular but not coherent mass; alcohol and acids produce the same effect. Hence it appears that the Lens chiefly consists of albumen in its soluble form; and this may be supposed to be contained in the cavities of the cells, as it is in those of the vitreous humour. From the latest analyses, it appears that the substance of the lens corresponds most with that modification of albumen, which forms the Globuline of the blood (§ 147).—In the Vitreous humour, we have an example of a very loose form of cellular tissue; strongly resembling that which constitutes the entire structure of *Acalephæ* (Jelly-fish). That the cells composing it have no open communication with each other, is evident from the fact that, when the general enveloping membrane is punctured in several places, it is long before the contained fluid entirely drains away. This fluid is analogous to that of the Aqueous humour; being little else than Water, holding a small quantity of Albumen and Saline water in solution. From Mr. Toynbee's inquiries it would appear, that the vessels which pass through the Vitreous humour do not send branches into its substance; but that it is nourished by the vessels, which are minutely distributed upon its general envelope. The Ciliary processes of the Choroid membrane are almost entirely composed of large, plexiform vessels, closely resembling those of synovial membrane (Fig. 54), which allow a great quantity of blood to circulate through them; and these have probably an important share in the nutrition of the Vitreous body.

191. Cartilage is perfectly insensible; and neither nerves nor lymphatics can be traced into its substance. Its functions are purely mechanical; the consolidation of its texture by internal deposit renders it little disposed to change by spontaneous decay; and it is protected by its toughness and elasticity from those injuries, to which softer or more brittle tissues are liable. These very circumstances, however, interfere with the activity of its nutrition. Cells which are choked up with interior deposit do not readily transmit fluid: it is doubtful whether any interstitial change can take place in the interior of a permanent Cartilage (except when it has become vascular by disease, or undergoes ossification), through the whole of life; and there seems ground to believe that, when it has been injured by disease or accident, the loss of substance is not repaired by real cartilaginous tissue. In the process of ulceration of Cartilage (as observed by Mr. J. Goodsir), it appears that the formation of depressions on the surface is due, not so much to any change originating in the substance of the cartilage, as to the eroding action of the cells of the false membrane, which is the product of inflammatory action upon its surface; and it is in this false membrane that the new vessels are formed, which dip down into nipple-like prolongations of the membrane, entering corresponding hollows excavated in the cartilage.—On the other hand, the softer tissues of the Eye are capable of complete regeneration. Every oculist is aware that a great loss of Vitreous humour may take place without permanent injury; and it has been found that even the Crystalline lens may be completely regenerated, after it has been entirely removed by extraction.

9. *Tissues consolidated by Earthy deposit.—Bones and Teeth.*

192. Both the *Fibres* and *Cells* of the Animal tissue, there is reason to believe, may be consolidated by mineral deposits; these being chemically united with the Gelatine of the *Fibres*; or secreted, either alone, or in combination with gelatine, into the cavities of the *Cells*, by their own inherent powers.

—We have an example of the formation of a skeleton by the consolidation of *fibres*, in the shell and other hard parts of the Echinodermata; the intimate structure of which, as shown by the Microscope, strongly reminds us of Areolar tissue that might have undergone the calcifying process. Again, we have an example of the formation of a skeleton by the deposit of mineral matter in the cavities of *cells*, in the shells of Mollusca; in many of which (especially among the Bivalves) the cellular character is permanently shown, —a consistent membrane being left,

after the Carbonate of Lime that consolidated the cell has been dissolved away by an acid. An arrangement precisely similar, as regards the animal constituent, is found in the Enamel of Teeth (§ 215); the only difference being in the consolidating material, which is chiefly the Phosphate of Lime, a mineral far harder than the Carbonate. It is not always, however, that the original cells preserve their character so distinctly; for it is very commonly found, that they have coalesced with each other, in such a manner as not to be distinguishable in the fully-formed tissue. We also frequently observe, in the skeletons of Vertebrata, that the

whole substance is not consolidated, but that cavities and channels are left in it; which seem destined to perform some office connected with the interstitial changes, that continue to take place in the tissues subsequently to their first formation. It has been already pointed out (§ 5), that the internal bony skeletons of Vertebrated animals are destined to undergo a degree of interstitial change (in order to adapt them to the progressive growths of the parts that cover them), which is not required in the external envelopes of Invertebrated animals; these being capable of sufficient enlargement by addition to their edges merely; or else being periodically thrown off, and renewed upon a larger scale. It is obvious that, if the whole substance be consolidated by calcareous deposit, there can be no permeation of nutritive fluid through it; but, on the other hand, if it be traversed by tubuli, commencing from the nearest vascular surface; or if a series of minute chambers, connected by still

Fig. 59.

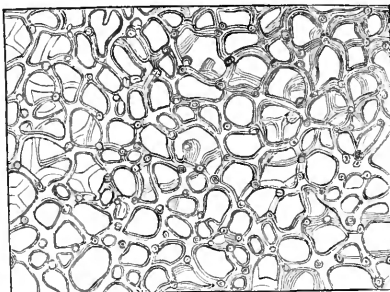

Calcified Areolar Structure, of which the Skeleton of the Echinodermata is composed; from the Spine of an Echinus. Magnified 150 diameters.

Fig. 60.

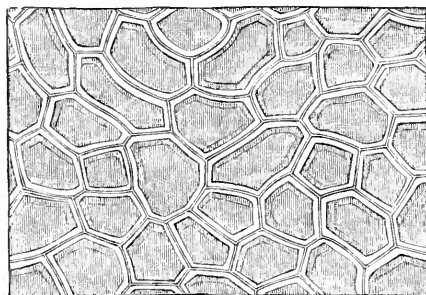

Cellular membrane, left after the removal of the Calcareous matter from the shell of Pinna. Magnified 155 diameters.

more minute passages, be excavated in its substance, it is evident that, even though blood cannot circulate through it, a nutritive fluid drawn from the blood, may be carried into its minutest parts. This is the kind of structure which we find in Bone, and in the principal substance of Teeth. The mode in which it is generated, will become the subject of inquiry hereafter.

193. When examined with the naked eye, it is seen that Bone possesses in some degree a laminated texture : in the long bones, the external and in-

Fig. 61.

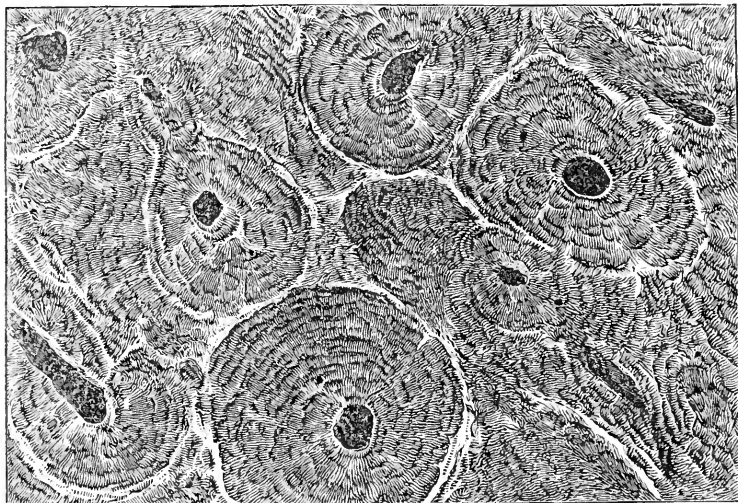

Portion of Transverse Section of Human Clavicle, showing the orifices of the Haversian canals, and the concentric arrangement of the laminae of bony matter, and of the lacunae, around them. Magnified 85 diameters.

ternal laminae are arranged concentrically round the medullary canal ; and in the flat bones, they are parallel to the surface. Towards the extremities of the long bones, and between the external plates of the flat bones, are a number of cancelli, or small hollows bounded by very thin plates of bone ; these communicate with the medullary canal where it exists ; having, like it, an extremely vascular lining membrane ; and their cavities being filled with a peculiar adipose matter. The hard substance of the bone also is traversed by canals, on which the name of Haversian has been bestowed, after their discoverer ; these canals run for the most part in the direction of the laminae ; but they have many transverse communications, both with each other and with the medullary cavity, so that they form a complete network, which is lined by a continuation of the membrane of the latter. Their diameter varies from 1-200th to 1-2000th of an inch ; the average being probably about 1-500. The smaller ones contain only a single capillary vessel ; but several such vessels seem to exist in the larger ones, together with adipose matter. When a thin transverse section of a long bone is made, and is highly magnified, it is seen that the bony matter of the greater part of its thickness is arranged in concentric circles round the orifices of the canals ; these circles are marked by a series of stellated points ; and when the latter are magnified still more highly, it is seen that they are cavities or *lacunae* of a peculiar form, which seems characteristic of Bone. They are usually oval or lenticular in form ; and are so placed, that one of their largest surfaces is turned *from*, and the

other *towards*, the Haversian canal. Their long diameter is commonly from

[Fig. 62.]

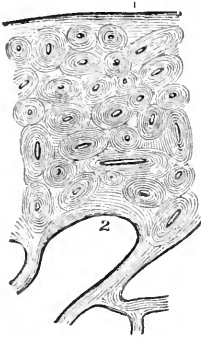

Transverse section of the compact tissue of a long Bone; showing 1, the periosteal layer; 2, the medullary layer, and the intermediate Haversian systems of lamellæ, each perforated by an Haversian canal. Magnified about 15 diameters.]

[Fig. 63.]

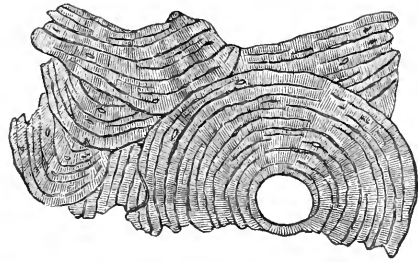

Transverse section of the compact tissue of a Tibia from an aged subject, treated with acid; showing the appearance of lamellæ surrounding the Haversian canals. Portions of several systems of lamellæ are seen. The appearance of the lacunæ, when their pores are filled with fluid, is also seen, as well as the radiation from the canals which then remain. From Mr. Tomes.]

1-2400th to 1-1600th of an inch; their short diameter is about one-third, and their thickness about one-sixth, of their length.

a. It has been lately shown by Mr. J. Quekett, that there are differences in the form and size of the lacunæ, in the several classes of animals, sufficiently characteristic to allow of the assignment of minute fragments of bone, with the aid of the microscope, to their proper class. The lacunæ of Reptiles are distinguishable by their large size, and long oval form; and those of Fish, by their angular form and the fewness of the radiating canaliculi. The osseous lacunæ of the Bird may be distinguished from those of the Mammal, partly by their smaller size, but chiefly by the remarkable tortuosity of their canaliculi, which wind backwards and forwards in such a manner, as frequently to destroy the concentric lamellar appearance. It is interesting to remark further, that the sizes of the lacunæ in the four classes of the Vertebrated animals, bear a close relation to the sizes of their blood-corpuscles. Here, as elsewhere, the dimensions of the ultimate parts of the tissue are tolerably constant in each group of animals, and show little variation in accordance with the size of the species; thus there is little or no perceptible difference in the size of the elements of the osseous tissue of the enormous extinct Iguanodon, and of the smallest Lizard now inhabiting the earth.

194. From all parts of these cavities, but especially from their two largest surfaces, proceed a large number of minute tubuli, which traverse the substance of the bone, and communicate irregularly with one another. Their direction, however, possesses a certain degree of determinateness; for those passing off from the inner surface converge towards the Haversian canal; whilst those passing off from the outer surface diverge in the contrary direction, so as to meet and inosculate with those proceeding inwards from the cavities of the next annulus. In this manner, a communication is kept up between the Haversian canal, and the most external of its concentric lamellæ

Fig. 64.

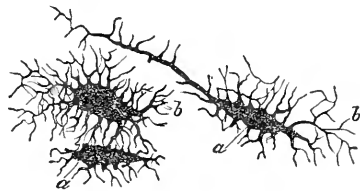

Lacunæ of Osseous Substance; magnified 500 diameters: *a*, central cavity; *b*, its ramifications.

of bone. It is not to be imagined, however, that *blood* can be conveyed by these tubuli, their size being far too small; for their diameter, at their largest part, is estimated at from 1-14,000th to 1-20,000th of an inch, whilst that of the smaller branches is from 1-40,000th to 1-60,000th of an inch; so that the blood-corpuscles could not possibly enter them. But it may be surmised that they draw fluid from the nearest blood-vessels, and thus keep up a sort of circulation through the osseous substance, which may contribute to its growth, and may keep it in a state fit for repairing itself, when injured by disease or violence. The *lacunæ*, however, do not seem to be unoccupied in the living bone; for each contains (according to Mr. J. Goodsir) a minute granular substance, which seems to be identical with the nucleus of the original bone-cell, and which probably serves as a "nutritive centre,"—attracting to itself, through its own system of canaliculi, the nutritive materials supplied by the blood-vessels of the nearest surface, and diffusing these through the surrounding substance.*

[Fig. 65.]

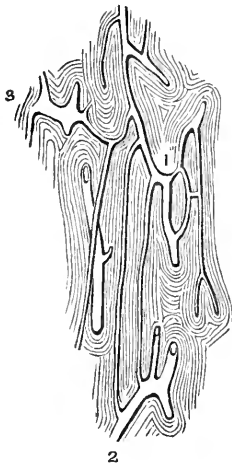

Haversian canals, seen on a longitudinal section of the compact tissue of the shaft of one of the long bones: 1, arterial canal; 2, venous canal; 3, dilatation of another venous canal.]

195. Although a large quantity of blood is sent to Bone, the vessels do not penetrate its minute parts; being confined to the Medullary cavity, and to the Haversian Canals, and Cancelli, which are prolongations of it. The substance of the Bone, therefore, is really as non-vascular as that of Cartilage; the only difference being, that it is channelled out by more numerous inflexions of the external surface, and that the vessels are thus brought into nearer proximity with its several parts. The delicate osseous lamellæ, which form the walls of the cancelli, and of the large cells excavated in some of the cranial bones, have a structure precisely analogous to that of the cylindrical laminæ surrounding the Haversian canals of the long bones; and derive their nourishment from the vascular membrane covering their surface, through the medium of a similar set of lacunæ and canaliculi. They do not themselves contain Haversian canals or cancelli; because no part of their substance is far removed from a vascular membrane. The cylindrical rods, that make up the hollow shaft of a long bone, are connected together by solid osseous substance, which is composed of lamellæ running parallel to the external surface of the bone; and these derive their nutriment either from the periosteum, or from the membrane lining the great central medullary cavity; according as they are nearest to one or to the other.—The membranous lining of the canals of Bone appears to be supplied with lymphatics, and also with nerves; but with both in a very limited amount. The periosteum seems to be scarcely (if at all) sensible in the state of health, although painfully so when inflamed; and the same may be said of the membrane lining the Haversian canals and cancelli. The membrane lining the central medullary cavity, however, is more

* The lacunæ and canaliculi of Bone were formerly supposed, on account of the black appearance they exhibit under the Microscope, to be filled with opaque matter; but this appearance is common to all cavities excavated in a highly-refracting substance (being shown by a bubble of air in water), and ceases when a very thin section of Bone is examined, especially if it have been placed in Canada Balsam. In the Bones of Mummies, they are found to be filled with a waxen material; and in those which have lain in bogs, they are rendered peculiarly distinct by the infiltration of some of the surrounding black matter: so that their power of imbibing liquids is clearly proved.

sensitive; since unequivocal signs of pain are manifested by an animal, when, a bone having been sawn across, a probe is passed up the cavity, or an acrid fluid is injected into it.

196. The ultimate substance of Bone, lying between the lacunæ and canaliculi, appears to be usually granular; the granules are stated by Mr. Tomes* to be often distinctly visible without any artificial preparation, in the substance of the delicate spicula of the cancelli, when they are viewed with a high power; and to be made very evident by prolonged boiling in a Papin's digester. They vary in diameter from 1-6000th to 1-14,000th of an inch; their shape is oval or oblong, often angular; and they cohere firmly together, possibly by the medium of some different material. Their own substance, however, appears to be perfectly homogeneous; but it is made up of several components, as appears from the following statements regarding the chemical composition of Bone.

a. When the Calcareous matter of Bone has been dissolved away by the action of an acid, the Animal substance which remains is almost entirely dissolved by a short boiling in water; yielding to it a large quantity of Gelatine. This, indeed, may be obtained by long boiling under pressure, from previously-unaltered Bone; and the calcareous matter is then left almost pure. The Lime of bones is, for the most part, in the state of Phosphate, especially among the higher animals; it is curious, however, that in callus and exostosis, there is a much larger proportion of Carbonate of lime, than in the sound bone; in which respect these formations correspond with the bones of the lower animals; but in caries, the quantity of the carbonate is much smaller than usual. The composition of the Phosphate of Lime in Bones is peculiar; S equiv. of the base being united with 3 of the acid. According to Prof. Graham, it is to be regarded as a compound of two tribasic phosphates; namely, 2 Ca, O, H O, P O₅ + 2 (3 Ca O, P O₅); with the addition of an equiv. of water, which is driven off by calcination. The following are the results of some of the most recent and careful analyses of Human Bone, by Marchand and Lehmann: those of the former were made on the compact substance of the femur of a man aged 30; and those of the latter on the long bones of the arm and leg of a man of 40 years of age.

	MARCHAND.	LEHMANN.
<i>Organic matter.</i>		
Cartilage insoluble in hydrochloric acid	27·23	} 32·56
Cartilage soluble in hydrochloric acid	5·02	
Vessels	1·01	
<i>Inorganic matter.</i>		
Phosphate of lime	52·26	} 54·61
Fluoride of calcium	1·00	
Carbonate of lime	10·21	9·41
Phosphate of magnesia	1·05	1·07
Soda	·92	1·11
Chloride of sodium	0·25	0·38
Oxide of iron and manganese, and loss	1·05	·86
	100·00	100·00

b. According to Dr. Stark,† the relative proportions of cartilaginous and earthy matter, in the bones of different animals, in the bones of the same animals at different ages, and in the different bones of the same body, never depart widely from the preceding standard; the amount of earthy matter being always found to be just double that of the cartilaginous basis, when the bones have been carefully freed from oily matter, and completely dried, previously to the analysis. The hardness of bone, he maintains, does not at all depend upon the presence of an unusually large proportion of earthy matter; nor does their increased flexibility and transparency indicate a deficiency of the mineral ingredients; for the transparent readily-cut bones of fish contain the same amount of earthy matter, in proportion to their gelatinous basis, as do the dense ivory-like leg-bones of the deer or sheep. The same holds good of the bones even of the so-called Cartilaginous Fish. The difference seems to depend upon the molecular arrangement of the ultimate particles; and especially, it seems likely, upon the relative amount of water which the bones contain.

* Todd and Bowman's Physiological Anatomy, p. 108, and Cyclopædia of Anatomy, art. *Osseous Tissue*.

† Edinburgh Med. and Surg. Journal, April 1845.

c. Probably the most exact and comprehensive analyses yet made of Bone, are those of Von Bibra;* whose laborious investigations may be said to have almost exhausted the subject. The following table shows the relative proportions of the principal ingredients in some of the principal bones of a woman aged 25 years.

	Femur.	Occipital bone.	Scapula.	Rib.	Os innominatum.	Vertebra.	Sternum.
<i>Organic matter.</i>							
Cartilage	29.54	29.87	32.90	33.06	38.26	43.44	46.57
Fat	1.82	1.40	1.73	2.37	1.77	2.31	2.00
<i>Inorganic matter.</i>							
Phosphate of lime } with a little fluo- ride of calcium. }	57.42	57.66	54.75	52.91	49.72	44.28	42.63
Carbonate of lime	8.92	8.75	8.58	8.66	8.08	8.00	7.19
Phosphate of magnesia	1.70	1.69	1.53	1.40	1.57	1.44	1.11
Soluble salts	0.60	0.63	0.51	0.60	0.60	0.53	0.50
	100.00	100.00	100.00	100.00	100.00	100.00	100.00

The analyses of the long bones of the arm and leg correspond closely with that of the femur; but we observe that the proportions of ingredients in the more spongy bones are widely different. It is difficult, however, to say how far this variation is due to a difference in the proportions of gelatine and earthy matter, in the actual osseous substance; or how far it may be accounted for by the presence of an increased proportion of membrane, forming the lining of the cancelli.—The same uncertainty must attend the explanation of the differences that present themselves at different ages; as shown in the following table, which gives the comparative analyses of the long bones (generally the femur) at different ages.

	Fœtus 6 months.	Fœtus 7 months.	Child 2 months.	Child 5 years.	Man 25 years.	Woman 62 years.
<i>Organic matter.</i>						
Cartilage	40.38	34.18	33.86	31.28	29.70	28.03
Fat	a trace	0.63	0.82	0.92	1.33	2.15
<i>Inorganic matter.</i>						
Phosphate of lime } with a little fluo- ride of calcium. }	53.46	57.63	57.54	59.96	59.63	63.17
Carbonate of lime	3.06	5.86	6.02	5.91	7.33	4.46
Phosphate of magnesia	2.10	1.10	1.03	1.24	1.32	1.29
Soluble salts	1.00	0.60	0.73	0.69	0.69	0.90
	100.00	100.00	100.00	100.00	100.00	100.00

From this it will be seen that there is a gradual diminution in the proportion of animal matter, through life; and a corresponding increase in the proportion of the earthy components. But this is not nearly so great as is usually supposed; and the greater solidity of the bones of old persons is doubtless owing chiefly to the fact, that their cavities are progressively contracted, by the addition of new bony matter (§ 201).

d. The following comparative analysis of the bones of different animals, are selected from the very extensive series given by Von Bibra; which contains 143 of Mammalia (independently of Man), 151 of Birds, 31 of Reptiles, and 23 of Fishes. They were mostly made upon the long bones; except in the case of Fishes, in which they were made upon the Vertebrae.

	Sheep.	Horse.	Wolf.	Thrush.	Frog.	Cod.	Salmon.
<i>Organic matter.</i>							
Cartilage	29.68	27.99	27.44	28.02	30.19	31.90	21.80
Fat	0.70	3.11	1.45	1.54	5.31	2.34	38.82
<i>Inorganic matter.</i>							
Phosphate of lime with a little fluoride of cal- cium. }	55.94	54.37	57.87	62.65	59.48	57.65	36.84
Carbonate of lime	12.18	12.00	11.09	6.05	2.25	4.81	1.01
Phosphate of magnesia	1.00	1.83	1.13	0.90	0.99	2.30	0.70
Soluble salts	0.50	0.70	1.02	0.84	1.78	1.00	0.83
	100.00	100.00	100.00	100.00	100.00	100.00	100.00

* Chemische Untersuchungen über die Knochen und Zähne des Menschen, und der Wirbeltiere.

It will be observed that, in all cases, the proportion between the cartilaginous basis and the earthy matter is very nearly the same; being almost exactly as 1 to 2, even where the composition of the bone is most altered, by the presence of an unusual quantity of fatty matter. Hence there is strong reason to believe, that a definite chemical compound is formed by the union of the Gelatine and Earthy salts; and this corresponds well with the fact already noticed, in regard to the homogeneity of the ultimate particles of bone.

197. The first Development of Bone may take place in the substance, either of *Membrane*, or of *Cartilage*.* The tabular bones forming the roof of the cranium afford a good example of the first, or *intramembranous* form of Ossification; for their place is but in part pre-occupied by cartilage; only a membrane being elsewhere interposed between the dura mater and the integuments. This membrane is chiefly composed of fibrous fasciculi, corresponding with those of the white fibrous tissues; but amongst these are seen numerous cells, some about the size of blood-discs, but others two or three times larger, containing granular matter; and a soft amorphous or faintly-granular matter is also found interposed amidst the fibres and cells. In certain parts, the fibres predominate; and in others, the cells. The process of ossification here seems at first to consist in the consolidation of the fibres by earthy matter; for the first bony deposit consists of an irregular reticulation, very loose and open towards its edges, and there frequently presenting itself in the form of distinct spicula, which are continuous with fasciculi of fibres in the surrounding membrane. The limits of the calcifying deposit may be traced by the opaque and granular character of the parts affected by it, and it gradually extends itself, involving more and more of the surrounding membrane, until the foundation is laid for the entire bone. Everywhere the part most recently formed consists of a very open reticulation of fibro-calcareous spicula; whilst the older part is rendered harder and more compact, by the increase in the number of these spicula, and perhaps also by the calcification of the intervening cells. As the process advances, and the plate of bone thickens, a series of grooves or furrows, radiating from the ossifying centre, are found upon its surface; and these by a further increase in thickness, occasioned by a deposit of ossific matter all around them, are gradually converted into closed canals (the Haversian), which contain blood-vessels, supported by processes of the investing membrane. Further deposits subsequently take place in the interior of these canals; which thus gradually produce a diminution of their calibre, and a consolidation of the bone; and in this manner its two surfaces acquire their peculiar density, whilst the intervening layer or diploe retains a character more resembling that of the original osseous reticulation.—The mode in which the peculiar lacunæ and canaliculi are formed, in the concentric layers around the Haversian canals, probably corresponds with that in which they are generated in the *intracartilaginous* form of ossification, to which we shall next proceed.

198. In a very large proportion of the skeleton, the appearance of the Bones is preceded by that of Cartilages; which present the same form, and which seem destined to afford a certain degree of support, to the surrounding soft parts, until the production of Bone has taken place. As already mentioned (§ 187), the *temporary* cartilages differ in no essential particular from the *permanent*. They present the same irregular scattering of cells through a homogeneous intercellular substance, and there is the same absence of any vascu-

* In recent times, the development of Bone from Cartilage has received almost exclusive attention; but the older opinion, that Bone is often developed in Membrane, has been lately brought again into notice by Dr. Sharpey (Introduction to Fifth Edition of Quain's Anatomy), who has demonstrated its truth by Microscopic research. The statements in the text, upon this part of the subject, are derived from Dr. Sharpey's observations, which the author has since confirmed.

larity in the Cartilaginous tissue itself. In all considerable masses, however, we find a coarse network of canals, lined by an extension of the perichondrium or investing membrane; and these canals, which may be regarded as so many involutions of the external surface, allow the vessels to come into nearer relation with the interior parts of the Cartilaginous structure, than they would otherwise do. They are especially developed at certain points,

Fig. 66.

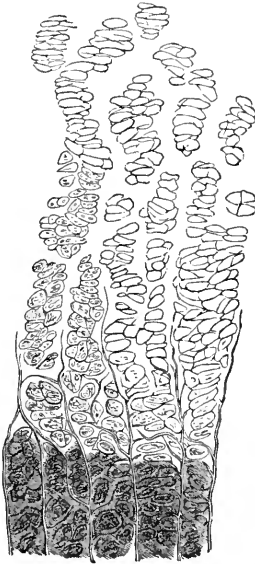

Section of Cartilage at the seat of ossification; the clusters of cells are arranged in columns; the intercellular spaces between the columns being 1-3250th of an inch in breadth. At the lower end of the figure, osseous fibres are seen occupying the intercellular spaces, at first bounding the clusters laterally, then splitting them longitudinally and encircling each separate cell. The greater opacity of this portion is due to a threefold cause; the increase of osseous fibres, the opacity of the contents of the cells, and the multiplication of oil-globules.

[Fig. 67.]

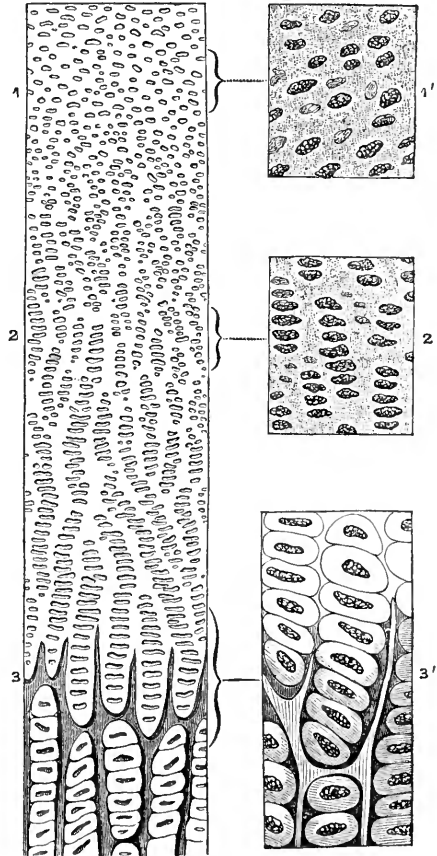

Vertical section of Cartilage near the surface of ossification; 1, ordinary appearance of the temporary cartilage; 1', portion of the same more highly magnified; 2, the cells beginning to assume the linear direction; 2', portion more magnified; opposite 3, the ossification is extending in the intercellular spaces, and the rows of cells are seen resting in the cavities so formed, the nuclei being more separated than above; 3', portion of the same more highly magnified. From a new-born rabbit which had been preserved in spirit.]

which are to be the centres of the ossifying process; and it is always observable, that the vascularity is greatest at the zone, in which the conversion of cartilage into bone is actually taking place. During the extension of the vascular canals into the Cartilaginous matrix, certain changes are taking place

in the substance of the latter, which are preparatory to its conversion into Bone. Instead of single isolated cells, or groups of two, three, or four, such as we have seen to be characteristic of ordinary Cartilage (Fig. 52), we find, as we approach the centre or line of ossification, clusters made up of a larger number arranged in a linear manner; which seem to be formed by a continuance of the same multiplying process as that formerly described (Fig. 66). And when we pass still nearer, we see that these clusters are composed of a yet greater number of cells, which are arranged in long rows, whose direction corresponds to the longitudinal axis of the bone; these clusters are still separated by intercellular substance; and it is in this, that the ossific matter is first deposited. If we separate the cartilaginous and the osseous substance at this stage of the process, we find that the ends of the rows of cartilage-cells are received into deep narrow cups of bone, formed by the calcification of the intercellular substance between them. Thus the Bone first formed in the cartilaginous matrix, is seen to consist of a series of lamellæ of a somewhat cylindrical form; inclosing oblong areolæ, or short tubular cavities, within which the piles of cartilage-cells yet lie: and it thus corresponds closely with the reticular structure, which first makes its appearance in the intra-membranous form of the process.—So far it would appear that the blood-vessels are not directly concerned in the operation; for although they advance to the near neighbourhood of the first ossific deposit, they do not make their way into its substance, or even into the intervening areolæ.

199. This state of things, however, speedily gives place to another. On examining the subjacent portion, in which the ossification has advanced further, it is found that the original closed cavities have coalesced to a certain extent (probably by the absorption of their walls), both laterally and longitudinally; and that they now receive numerous blood-vessels, prolonged into them from the previously-ossified portion. The groups of cartilage-cells, which originally occupied the cavities, are no longer seen; and their place is filled with a blastema, composed of cells, containing a granular matter, and closely resembling those seen in the intra-membranous ossification, with a few fibres scattered amongst them. It is by a change in this blastema, that the walls of the cavities are gradually consolidated; new deposits of ossific matter being formed in their interior, which occasion the gradual contraction of the cavities, and give an increasing density to the bone. The cancellated structure, which remains for a time in the interior of the long bones, and which continues to occupy their extremities, represents the early condition of the ossifying substance, with very little change; whilst the cavities, which have formed more regular communications with each other, and which have been gradually contracted by the subsequent deposit of concentric lamellæ, one within another, form the original Haversian canals. Thus we see that they all form one system in their origin; as they may be considered to do, notwithstanding the difference of their form, in the complete bone.

200. The original osseous lamellæ, formed by the consolidation of the cartilaginous substance, are entirely composed of granular matter; and exhibit none of the lacunæ and canaliculi, which are commonly regarded as characteristic of Bone. These excavations present themselves, however, in all the subsequent deposits; and into the origin of these, we have now to inquire. According to the views of some Microscopists, the cells of the blastema fill themselves with ossific matter, except at the points occupied by the nuclei; at the same time, they become flattened against the walls of the canals, and their nuclei send out radiating prolongations; so that, when the calcification of the cell has been completed, a stellate cavity is left in the hard deposit, which is occupied by the granular matter of the nucleus. The centre of this cavity forms the *lacuna*, in which the original granular matter may frequently

be found remaining, and presenting an appearance as if developed into a cluster of minute cells; whilst its prolongations form the *canaliculi*, from which the nuclear matter seems afterwards to disappear altogether. This view is supported by several considerations; amongst others, by the fact of the existence of such stellate nuclei in many Vegetable cells (Fig. 14); and by the corresponding appearances witnessed by Professor Owen in the formation of the Cement of Teeth, a structure identical with bone, and produced by the calcification of the capsule (§ 216).—Others, again, regard the lacunæ and their radiating prolongations as themselves constituting cells; and examples are not wanting of similar forms in bodies known to have this character, as the pigment-cells of the skin of Batrachia (Fig. 90, c).—Dr. Sharpey, on the other hand, states as the result of his observations, that the concentric layers within the Haversian canals are formed by a process analogous to the intramembranous ossification; namely, by the calcification of successive layers of fibres, generated in the blastema, and possibly derived from the granular cells. These fibres, being arranged in a reticular manner, may here and there include an entire cell or cell-nucleus, the presence of which may determine the position of a lacuna; whilst the canalicula may result from the apposition of the minute apertures, existing between the other reticulations of the decussating fibres. This view seems to derive confirmation from the appearances presented by very thin shreds of the gelatinous matrix, left after the removal of the calcareous matter by acid; for these, according to Dr. S., are plainly composed of transparent fibres, resembling those of the white fibrous tissues, intersecting one another at acute angles, and forming a network, in the meshes of which are minute perforations, that are nothing else than transverse sections of the canaliculi.

201. In the formation of a long bone, we usually find one centre of ossification in the shaft, and one in each of the epiphyses; in the flat bones, there is one in the middle of the surface, and one in each of the principal processes.

[Fig. 68.



Scapula of a Fœtus at the seventh month; showing the progress of ossification. Natural size. The light parts are epiphyses as yet cartilaginous.—From the Museum of King's College, London.]

The ossification usually proceeds to a considerable extent, however, in the main centre, before it commences in the extremities or processes; and these remain distinct from the principal mass of the bone, long after this has acquired solidity. During the spread of the ossifying process, the cartilaginous matrix continues to grow, like cartilage in other parts; but after the bony deposit has pervaded its entire substance, in the manner just described, a change takes place in the method adopted. The osseous laminae, that subdivide the whole texture, are removed by absorption from the interior of the shaft, so as to leave the great central medullary cavity; whilst, on the other hand, they receive progressive additions in the external portion, which is thus gradually consolidated into the dense bone, that forms the hollow cylinder of the shaft. This consolidation is effected by the deposit of a series of concentric laminae, one within another, on the lining of the Haversian canals.—The bone continues to increase in *diameter*, by the formation of new layers upon its exterior; and Dr. Sharpey has

pointed out that these layers are formed, not (as usually stated) in a cartilaginous matrix, but in the substance of a *membrane*, consisting of fibres and granular cells, and exactly resembling that in which the flat bones of the roof of the skull are developed. The Haversian canals, too, of these new layers

are formed in the same manner as those of the tabular bones of the skull; the osseous matter being not only laid on in strata parallel to the surface, but also being deposited around processes of the vascular membranous tissue, which extend obliquely from the surface into the substance of the shaft; the canals, in which these membranous processes lie, becoming narrowed by the deposition of concentric osseous laminae, and at last remaining as the Haversian canals. Whilst this new deposition is taking place on the exterior of the shaft, absorption of the inner and older layers goes on: so that the central cavity is proportionably enlarged.—The increase of the bone in *length* appears due to the growth of the cartilage between the shaft and the epiphyses, so long as this remains unconsolidated by ossific deposit; and this state continues, until the bone has acquired nearly its full dimensions. What further increase it gains, seems chiefly if not entirely due to the progressive ossification of the articular cartilage covering the extremities; which progressively diminishes in thickness during the whole of life, and which in old age sometimes appears to have been almost completely converted into bone.

202. It thus appears doubtful, whether there be anything like a proper *interstitial* growth in bone; that is, whether the part, through which the ossific process has made its way, is capable of any further extension than by addition to its surface. By the admirable system of prolongations, however, by which the vascular membrane is conveyed into its intimate substance, we find this method of superficial deposit adapted to the consolidation of parts, at first sketched out (as it were) by a slight osseous reticulation; whilst by the facility with which the bony matter is absorbed in the internal part of the shaft, whilst it is being deposited upon its exterior, the same effect is produced, as if the whole cylinder could enlarge uniformly by a proper interstitial growth, in the manner of the softer tissues.—Much of our information regarding the mode in which new bony matter is deposited, is derived from observations made upon the bones of animals that have been fed with madder; for this colouring-matter, having a strong affinity for bone-earth, tinges all those parts which are in close relation with the vascular surfaces. In very young animals, a single day serves to colour the entire substance of the bones; for there is in them no osseous matter far removed from a vascular surface. At a later period, however, the colouring matter is deposited less rapidly; and is found to be confined to the innermost of the concentric laminae of bone, surrounding each Haversian canal, showing that this is the last formed. When madder is given to a growing animal, the external portion of the bone is first reddened; showing that the new deposit takes place exclusively in that situation. And if, when time has been allowed for this part to become tinged, the administration of the madder be discontinued, and the animal be killed some weeks afterwards, the red stratum is surrounded by a colourless one of subsequent formation; whilst the colourless layer internal to the red one, and formed previously to it, is thinned by absorption from within. By alternately administering and withholding the madder, a succession of coloured and colourless cylinders may thus be formed in the shaft of a long bone; which present themselves as concentric rings in its transverse section.

203. The nature of the Ossifying process receives some additional light from the abnormal forms in which it occasionally presents itself in Cartilages that are usually permanent; as well as in various softer tissues, such as the coats of the arteries, fibrous and serous membranes, muscular substance, &c. In these cases, the ossific deposit may often be seen to take place, in the first instance, in the form of distinct granules, which gradually coalesce; or in the form of spicular fibres, to which additions are progressively made; until a solid mass is produced. This adventitious bone, however, almost invariably differs from true or normal bone, in the want of a regular Haversian system

with concentric laminae, and in the absence of the characteristic lacunæ and canaliculi. Irregular cavities, however, are scattered through them; which may in some degree answer the same purpose. The osseous plates not unfrequently found in the dura mater, are stated by Mr. Tomes to possess a structure more closely allied to that of true bone; which may be connected with the fact that, in some of the lower Mammalia, certain parts of this membrane (the falx and tentorium) are normally ossified.

204. The Regeneration of Bone, after loss of its substance by disease or injury, is extremely complete; in fact, there is no other structure of so complex a nature, which is capable of being so thoroughly repaired. Much discussion has taken place with respect to the degree in which the different membranous structures, that surround bone and penetrate its substance, contribute to its regeneration; but the fact seems to be, that any or *all* these membranes may contribute to the formation of new bone, in proportion to their vascularity,—the new structure, however, being most readily produced in continuity with the old. Thus, when a portion of the shaft of the bone is entirely removed, but the periosteum is left, the space is filled up with bony matter in the course of a few weeks; though, if the periosteum also be removed, the formation of new osseous matter will be confined to a small addition in a conical form to the two extremities, a large interspace being left between them. The production of new bony tissue, in this experiment, as in cases where the periosteum has been detached by disease and remains alive while the shaft dies, is in continuity with minute spicula of original bone, which still adhere to the membrane; and it is well known that, in comminuted fractures, every portion of the shattered bone, that remains connected with the vascular membranes, whether these be internal or external, becomes the centre of a new formation; the loss of substance being filled up the more rapidly, in proportion to the number of such centres.

205. The most extensive reparation is seen, when the shaft of a long bone is destroyed by disease. If violent inflammation occur in its tissue, the *death* of the fabric is frequently the consequence; apparently through the blocking-up of the canals with the products of inflammatory action, and the consequent cessation of the supply of nutriment. It is not often that the whole thickness of the bone becomes necrosed at once; more commonly this result is confined to its outer or to its inner layers. When this is the case, the new formation takes place from the part that remains sound; the external layers, which receive their vascular supply from the periosteum, and from the Haversian canals continued inwards from it, throwing out new matter on their interior, which is gradually converted into bone; whilst the internal layers, if *they* should be the parts remaining uninjured, do the same on their exterior, deriving their materials from the medullary membrane, and from its prolongations into their Haversian canals. But it sometimes happens that the whole shaft suffers necrosis; and as the medullary membrane and the entire Haversian system have lost their vitality, reparation can then only take place from the splinters of bone which may remain attached to the periosteum, and from the living bone at the two extremities. This is consequently a very slow process; more especially as the epiphyses, having been originally formed as distinct parts from the shaft, do not seem able to contribute much to the regeneration of the latter.

206. When the shaft of a long bone has been fractured through, and the extremities have been brought evenly together, it is found that the new matter first ossified is that which occupies the central portion of the deposit, and which thus connects the medullary cavities of the broken ends, forming a kind of plug that enters each. This was termed by Dupuytren, by whom it was first distinctly described, the *provisional callus*, and it is usually formed in

the course of five or six weeks, or less, in young persons. At that period, however, the contiguous surfaces of the bone itself are not cemented by bony union; and the formation of the permanent callus occupies some months; during which the provisional callus is gradually absorbed, and the continuity of the medullary canal is thus restored, in the manner in which it was first established. Mr. Gulliver has remarked that, when the broken portions of bone form an angle, there is quite a distinct centre of ossification in the new matter; from which that portion of it is ossified, that lies between the sides of the angle; thus forming what has been termed an *accidental callus*, and giving support to the two portions of the shaft, in a situation which is exactly that of the greatest mechanical advantage. Though for some time quite unconnected with the old bone, it soon becomes united to the regular callus. This instance proves, that continuity with previously-formed bone is not absolutely requisite for the production of new osseous structure; although the process is decidedly favoured thereby.

207. The reparation of Bone, after disease or injury, seems to take place upon a plan essentially the same as that of its first formation. A plastic or organizable exudation is first poured out from the neighbouring blood-vessels; and thus forms a sort of bed or matrix, in which the subsequent processes take place. The next stage, in young animals, is the formation of a true cartilaginous substance, exactly resembling their temporary cartilages; and this is gradually converted into bone, in the manner in which those cartilages are consolidated in the first instance. In older animals, however, the new structure appears to be rather of a membranous character; and the ossifying process would therefore correspond rather with that by which the normal increase of their bones is effected. Mr. Tomes states* that he has examined various cases of fracture of the neck or shaft of the femur, in which union had not been effected, in consequence of the patient's advanced age; and that he found in these no intervening cartilage, and but a scanty amount of condensed areolar tissue. In this latter, traces of an attempt at repair may be generally found, in the presence of osseous matter in granules or granular masses; but in these there is no arrangement of tubes or bone-cells of definite character; indeed, such osseous masses are generally small, and are deficient in density, owing to the want of union between the individual granules.

208. The *Teeth* are nearly allied to Bone in structure; and in some of the lower Vertebrata, there is an actual continuity between the bone of the jaw, and the teeth projecting from it, notwithstanding that the latter form part of the *dermal* skeleton, whilst the former belongs to the *neural* or internal. In Man and the higher animals, however, there is an obvious difference in their structure; as in their mode of development. These subjects have lately received much attention; and the practical importance of an acquaintance with them, renders it desirable that they should be here treated somewhat fully.—The Teeth of Man, and of most of the higher animals, are composed of three very different substances; *Dentine* (known as *ivory* in the tusk of the Elephant), *Enamel* and *Cementum* or *Crusta Petrosa*. These are disposed in various methods, according to the purpose which the Tooth is to serve: in Man, the whole of the crown of the tooth is covered with Enamel; its root or fang is covered with Cementum; whilst the substance or body of the tooth is composed of Dentine. In the molar Teeth of many Herbivorous animals, however, the Enamel and Cementum form vertical plates, which alternate with plates of Dentine, and present their edges at the grinding surface of the tooth; and the unequal wear of these substances,—the Enamel being the hardest, and the Cementum the softest,—occasions this surface to be always kept rough.

* Cyclopædia of Anatomy and Physiology, vol. iii, p. 557.

[Fig. 69.

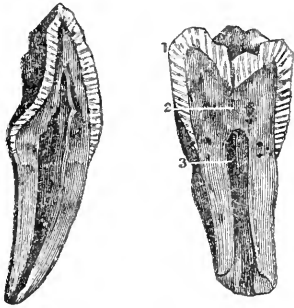

A view of an Incisor and of a Molar Tooth, given by a longitudinal section, and showing that the enamel is striated, and that the strice are all turned to the centre; the internal structure is also seen; 1, the enamel; 2, the ivory; 3, the cavitas pulpi.]

[Fig. 70.

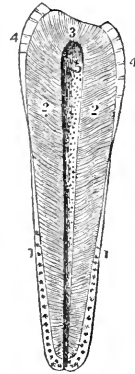

A vertical section of an adult Bicuspid, cut from without inwards—magnified 4 times; 1, 1, the cortical substance which surrounds the root up to the commencement of the enamel; 2, 2, the ivory of the tooth, in which are seen the greater parallel curvatures, as well as the position of the main tubes; 3, apex of the tooth, where the tubes are almost perpendicular; 4, 4, the enamel; 5, the cavity of the pulp, in which are seen, by means of the glass, the openings of the tubes of the dental bone.]

209. The *Enamel* is composed of solid prisms or fibres, about 1-5600th of an inch in diameter, arranged side by side, and closely adherent to each other;

[Fig. 71.

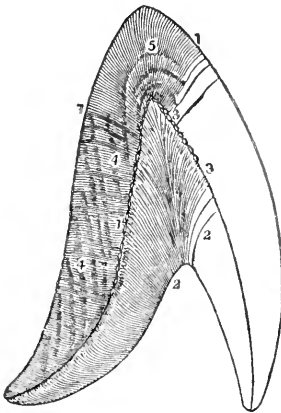

A vertical section of an imperfectly developed Incisor, taken from the follicle in which it was enclosed; this section is meant to show the position of the enamel fibres, and also that a part of the appearances which are seen in this substance under a less magnifying power, originate in parallel curvatures of the fibres; 1, 1, the enamel; 2, 2, the dental bone, or ivory; 3, 3, the minute indentations and points on the surface of the ivory, on which the enamel fibres rest; 4, 4, brown parallel fibres; 5, parallel flexions of the fibres of the dental bone in these stripes.]

[Fig. 72.

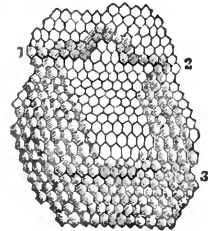

A portion of the surface of the Enamel on which the hexagonal terminations of the fibres are shown—highly magnified; 1, 2, 3, are more strongly marked dark crooked crevices,—running between the rows of the hexagonal fibres.]

their length corresponds with the thickness of the layer which they form; and the two surfaces of this layer present the ends of the prisms, which are usually more or less regularly hexagonal. The course of these prisms is generally wavy; but their curves are for the most part parallel to each other. In the perfect state, the Enamel contains but an extremely minute quantity of animal matter; but if a young tooth be examined, it is found that, after the

[Fig. 73.

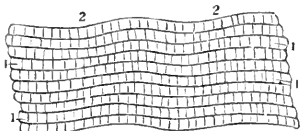

The Fibres of the Enamel viewed sideways under a magnifying power of 350 times; 1, 1, the enamel fibres; 2, 2, the transverse stripes upon them.]

[Fig. 74.

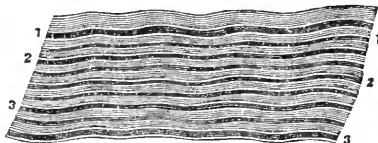

A small portion of fig. 70 covered with turpentine varnish, viewed under a magnifying power of 350 times; 1, 2, 3, are the tubes containing a powdery, lumpy substance. They are regular, and closely undulating; but the branches do not appear, because they are penetrated by the varnish.]

calcareous matter of the tooth has been dissolved away by an acid, there remains a set of distinct prismatic cells, which formed (as it were) the moulds in which the mineral substance was deposited.* The Enamel is the least constant of the dental tissues; being more frequently absent than present in the teeth of Fishes; being deficient in the whole order of Serpents; and forming no part of the teeth of the Edentate and Cetacean Mammals.

210. The *Dentine*† consists of a firm substance, in which mineral matter largely predominates, though to a less degree than in the enamel. It is tra-

[Fig. 75.

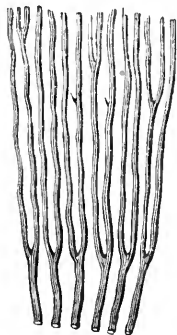

A view of the most interior portion of the main tubes of the dental bone in an incisor of a child two years old, close to their commencement in the cavitas pulpi, in order to show their first division.]

[Fig. 76.

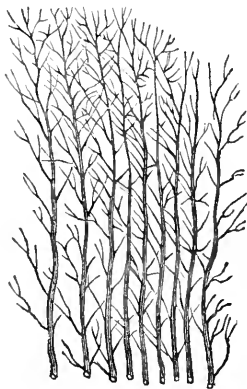

A view of the external portion of the tubes of the same tooth, exhibiting their more minute ramifications, which, for the most part, turn towards the crown.]

versed by a vast number of very fine cylindrical branching wavy tubuli; which

* The Author has discovered a structure precisely resembling this, in the shells of many Mollusca. See *Annals of Natural History*, December, 1843.

† A structure exactly resembling Dentine has been found by the Author in the shell of the Crab, especially at the tips of the claws; and a less regular structure of the same kind in the shells of many Mollusca. (*Loc. cit.*)

commence at the pulp-cavity (on whose wall their openings may be seen), and radiate towards the surface. In their course outwards, the tubuli occasionally divide dichotomously; and they frequently give off minute branches, which again send off smaller ones. In some animals, these tubuli may be traced at their extremities into cells exactly resembling the lacunæ of bone; and here the Ivory must be considered as presenting a form of transition into

[Fig. 77.]

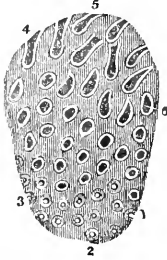

A view of a small portion of a transverse section of the crown of the Tooth seen in fig. 70, viewed under a magnifying power of 350 times; 1, 2, 3, are the round openings of the tubes, with parietes of a peculiar substance: 4, 5, 6, are the tubes cut more obliquely, in consequence of their more external position]

[Fig. 78.]

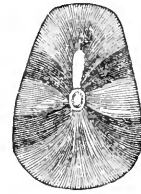

A view of the position of the same main tubes, in a transverse section near the root of a bicuspid, magnified 5 diameters. The dark patches in this figure mark the places in which the bone was especially white and less transparent than in the clear intermediate tracts.]

[Fig. 79.]

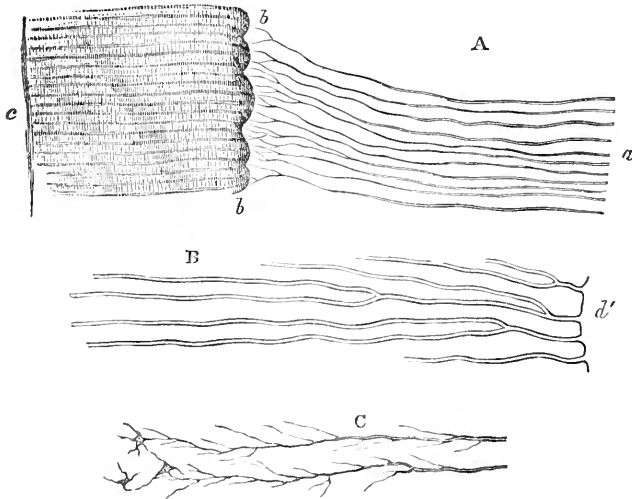

Sections of a human incisor, showing:—

A. Junction of dentine and enamel near the neck of the tooth. *a*. Tubes of the dentine, dividing and ending on *b b*, the cupped surface on which the enamel rods vertically rest. *c*. Free surface of the enamel. The enamel rods are crossed by transverse lines and also by oblique dark lines.

B. Bifurcation of the tubuli of the dentine, soon after their commencement on *d* the surface of the pulp-cavity.

C. Branching of the tubuli of the fang, and their termination in the small irregular lacunæ of the "granular layer."

In these longitudinal views of the tubuli, their cavities only, and not their walls, are visible. Magnified 300 diameters.]

the substance next to be described. The tubuli, in their radiating course, describe two, three, or more curvatures, appreciable by a low magnifying power; these are termed by Prof. Owen, the "primary curvatures." With a higher power, the tubes are seen to be bent, throughout the whole of their flexuous course, into minute and equal oblique undulations, of which 100 may be counted within the space of 1-10th of an inch; these are the "secondary curvatures" of Prof. Owen. Both the primary and the secondary curvatures of one tube are usually parallel with those of the contiguous tubes; and from the radiating course of the tubuli, the rows of curvatures have the appearance of lines running parallel with the external contour of the tooth.—The diameter of the tubuli in their largest part averages about 1-10,000th of an inch; their smallest branches are immeasurably fine. It is impossible that they can receive blood; but it may be surmised that, like the canaliculi of bone, they absorb matter from the vascular lining of the pulp-cavity, which aids in the nutrition of the tooth. Although, when once fully formed, the Tooth undergoes little or no change, there is evidence that it possesses a certain power of repairing the effects of disease;—a new layer of hard matter being sometimes thrown out on a surface, which has been laid bare by Caries. It has been found, too, that the Dentine is sometimes tinged by colouring matters contained in the blood. This is most evident, when a young animal is fed upon madder, during the period of the formation of the tooth; but even in an adult, some tinge will result from a prolonged use of this substance; and it has been noticed that the teeth of persons, who have long suffered from Jaun-

[Fig. 80.

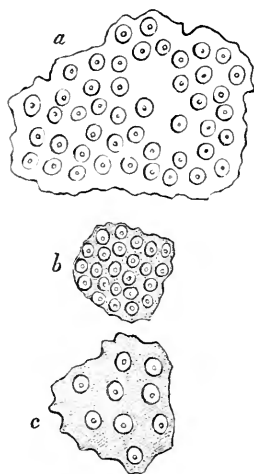

Transverse sections of tubules of dentine, showing their cavities, their walls, and the intertubular tissue.

a. Ordinary distance apart.

b. More crowded.

c. Another view.

Human molar.—Magnified 400 diameters.]

Fig. 81.

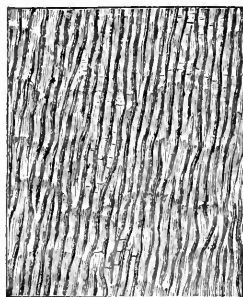

Oblique section of Dentine of human tooth, highly magnified, showing the calcigerous tubuli, and the outlines of the original cells.

dice, sometimes acquire a tinge of bile. Attention has been particularly directed by Prof. Owen, to appearances which he regards as indicating the

boundaries of the original cells of the dentinal pulp (§ 213) that have not been obliterated by the process of calcification.* These are particularly evident in the teeth of the Dugong, and of the extinct *Mylodon*; but they occasionally present themselves in the Dentine of Man (Fig. 81).—In certain Mammals and Reptiles, and in a large number of Fishes, the Dentine is traversed by canals, which are prolonged into it from the central pulp-cavity, and which are lined (like the pulp-cavity itself) by a highly-vascular membrane; and it is then distinguished as *Vascular Dentine*. These canals are obviously analogous to the medullary or Haversian canals of bone; and the tubuli usually radiate from them, rather than from the central cavity. In some instances, there is no central cavity whatever; but the whole tooth is traversed by an irregular network of these medullary canals, which become continuous with the Haversian canals of the subjacent bone.—A substance still more resembling bone, but formed from the dentinal pulp, is found in the interior of the teeth of certain Reptiles and Mammalia, and occasionally in the teeth of Man, especially at the later periods of life. This substance possesses not only vascular or medullary canals, but also the stellate lacunæ and radiating canaliculi of true bone. It sometimes occupies the whole of the cavity of the pulp, and is formed by the ossification of its cellular parenchyma; but in other cases, it forms merely a thin shell upon the interior of the ordinary Dentine.

211. The *Cementum* or *Crusta Petrosa* corresponds in all essential particulars with Bone; possessing its characteristic lacunæ; and being also traversed by vascular medullary canals, wherever it occurs of sufficient thickness.—as in the exterior of the tooth of the extinct *Megatherium*, and in the thick plates interposed within the islands of Enamel in the teeth of Ruminants, Rodents, &c. The varieties of microscopic structure presented by the *Cementum* in different classes of animals, correspond with the modifications of the osseous tissue, which exist in the skeletons of those animals respectively. The *Cementum* was formerly supposed to be restricted to the compound teeth of Herbivorous animals; and its presence in the simple teeth of Man and the Carnivora can be shown only by the application of the Microscope. In the latter it forms a layer, which invests the fang, and which decreases in thickness as it approaches the crown of the tooth; at the time of the first emersion of the tooth, it covers the crown with a very thin lamina; but this is speedily worn away by use; on the other hand, its thickness around the apex of the fang often undergoes a subsequent increase, especially when chronic inflammation and thickening take place in the membranous contents of the socket.

212. The following are the results of the most recent Chemical Analyses of the component structures of Human Teeth:—†

<i>Incisors of Adult Man.</i>			
	Dentine.	Enamel.	Cementum.
Organic matter	28.70	3.59	29.27
Earthy matter	71.30	96.41	70.73
	<hr style="width: 50%; margin: 0 auto;"/> 100.00	<hr style="width: 50%; margin: 0 auto;"/> 100.00	<hr style="width: 50%; margin: 0 auto;"/> 100.00

The proportion of these two components varies considerably in different species; thus the organic basis of the Elephant's tusk forms as much as 43 per cent. of the whole. It would seem even to vary considerably in different individuals of the same species; thus in the molar teeth of one man, Bibra found the organic matter to constitute as little as 21 per cent.,

* See Prof. Owen's *Odontography*, Introduction.

† Op. Cit.; and Bibra's "*Chemische Untersuchungen über die Knochen und Zähne.*"

whilst in another it was 28.—The following analyses afford a more particular view of the components of each substance:—

Molars of Adult Man.

	Dentine.	Enamel.
Phosphate of Lime, with traces of fluato of lime	66.72	89.82
Carbonate of Lime	3.36	4.37
Phosphate of Magnesia	1.08	1.34
Other Salts	0.83	0.88
Chondrine	27.61	3.39
Fat	0.40	0.20
	<hr/>	<hr/>
	100.00	100.00
	<hr/>	<hr/>

Incisors of Ox.

	Dentine.	Enamel.	Cement.
Phosphate of Lime, with trace of fluato of lime	59.57	81.86	58.73
Carbonate of Lime	7.00	9.33	7.22
Phosphate of Magnesia	0.99	1.20	0.99
Salts	0.91	0.93	0.82
Chondrine	30.71	6.66	31.31
Fat	0.82	0.02	0.93
	<hr/>	<hr/>	<hr/>
	100.00	100.00	100.00
	<hr/>	<hr/>	<hr/>

213. The Dentine and its modifications, the Enamel, and the Cementum, originate in three distinct structures; which may be termed respectively, the dentinal-pulp, the enamel-pulp, and the capsule or cemental-pulp; the whole forming the "matrix" from which the entire tooth is evolved.—The Dentinal pulp is always the first-developed part of the matrix; and it makes its appearance in the form of a papilla, budding out from the free surface of a fold or groove of the mucous membrane of the mouth. This may be converted into dentine, without ever becoming inclosed within a capsule; as we see in the Shark, whose dentition never advances beyond this *papillary* stage. The dentinal pulp consists of a mass of nucleated cells, imbedded in a semi-fluid granular blastema, and the whole inclosed in a dense structureless pellucid membrane. This substance is copiously supplied with blood-vessels, originating in a trunk that enters the base of each papilla; the branches ramify and diverge in their progress through the pulp; and at last they form a capillary network, which terminates in loops near the apex of the pulp (Fig. 82). These vessels are accompanied by nerves; which also have looped terminations.—The following is the substance of the account given by Prof. Owen, of the conversion of the dentinal pulp into dentine; based upon his observation of this process as it occurs in the fœtal Shark. The primary cells, which are smallest at the base of the pulp, and have large simple sub-granular nuclei, soon fall into linear series, directed towards the periphery of the pulp; and those which are nearest to the periphery become closely aggregated, increase in size, and present a series of important changes in their interior (Fig. 83, *a*). A pellucid point appears in the centre of the nucleus; and the latter increases in size, and becomes more opaque around it. A division of the nucleus in the course of its long axis is next observed (*b*); and in the larger and more elongated cells, still nearer the periphery of the pulp, a further subdivision of the nuclei is observed, in a transverse as well as a longitudinal direction (*c, c*), the subdivisions becoming elongated, with their long axes vertical, or nearly so, to the surface of the pulp. The subdivided and elongated nuclei become attached by their extremities to the corresponding nuclei of the cells in advance; and the attached extremities become confluent (*d*); so that lines or

Fig. 82.



Vessels of Dental Papilla.

files of nuclear matter are formed, which present an unbroken continuity from one primary cell to another. While these changes are proceeding, the calcareous salts furnished by the blood begin to be accumulated in the interior of the cells, and to be aggregated in a semi-transparent state around the central granular part of the elongated nuclei, which now present the character of rows of minute secondary cells; and the salts occupy, in a still clearer and more compact state, the cavity of the primary cell not occupied by the transformed nuclei. The rows of minute secondary cells (which appear scarcely to advance beyond the condition of simple granules) remain uncalcified in the midst of the solid calcareous substance; and thus constitute the *tubuli* of the dentine, in which a granular or bead-like aspect may generally be traced.

214. Around the tubes, in a transverse section, is a small circular space (Fig. 84, *b*), manifestly distinct from the intertubular substance; and this is regarded by Professor Owen as the indication of a membrane surrounding the elongated and coalesced secondary cells. The traces of the original boundary of the primary or parent-cells (Fig. 84, *a, a*), are generally lost; but, as already remarked (§ 210) they are sometimes preserved with sufficient distinctness to be quite recognizable. The "primary curvatures" observable in the tubuli are due to the arrangement of the original linear series

Fig. 83.

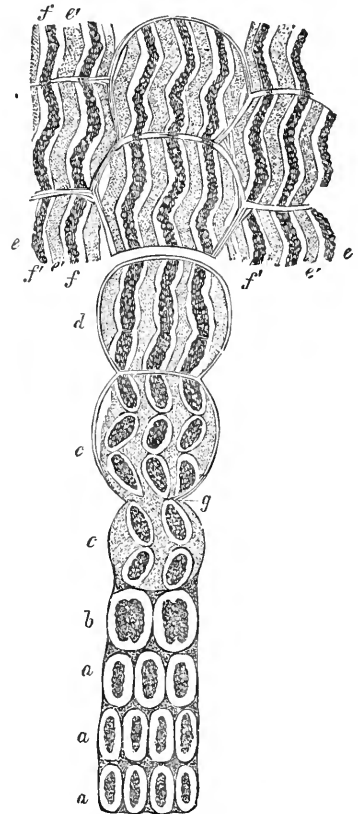
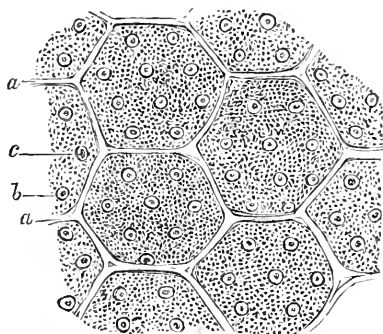

Diagram of development of Dentine : *a*, end of a linear series of primary dentinal cells; *b*, cells with nuclei dividing; *c*, subdivision and elongation of nuclear matter; *d*, elongated nuclei uniting to form the area of dentinal tubes; *e, e*, calcified cap of dentine, formed by the intussusception of the clear hardening salts into the walls and cavities of the cells and intercellular blastema *é, é*, and by their partial exclusion from the moniliform nuclear tracts *f, f'*; *g*, union of two peripheral nucleolar or secondary cells with one nearer the centre of the pulp.

of parent cells; whilst the "secondary curvatures" are accounted for by the fact, that the elongated nuclei usually unite with each other at obtuse angles, and not in perfectly straight lines, (Fig. 83, *d*).—Thus we are to regard the Dentine as composed of the original cells of the pulp, which have become consolidated by the calcifying process, in every part save that which is occupied by the rows of granules or incipient cells, developed from the metamorphosed nuclei. The calcareous matter appears to be chemically united, as in Bone, with an animal base; the cavity of each cell being pervaded by both; so that, when the whole of the calcareous matter is removed by dilute acid, a cartilaginous-looking mass remains, which preserves the form of the tooth. The calcifying process takes place first on the exterior of the pulp, and gradually extends inwards; and the capillary blood-vessels altogether retreat from the calcifying portion, and form their terminal loops upon the surface of the part which still remains unconsolidated. As the calcification extends inwards, the pulp, of course, progressively decreases; fewer nuclei are formed in the cells; and these do not acquire so large a size. Here and there it is seen, that the inner extremities of *two* of the granular tracts, in the part last calcified, converge, and connect themselves with *a single* tract in the layer nearer the centre of the pulp, (Fig. 83, *g*); in which we see the origin of the bifurcation of the tubuli. This bifurcation becomes more frequent, as the calcifying process approximates towards the centre and base of the pulp; and it is thus that the main tubes are formed. In some of the cells, at and near the central and basal part of the pulp, the nucleus undergoes no division; but it merely elongates, and sometimes becomes angular or radiated,—thus showing a form of transition to the stellate nucleus of the bone-cells. As already stated, we occasionally find modifications of the dentine in this situation, which closely resemble true bone in structure.

215. The Enamel-pulp is not formed until after the dental papilla has become inclosed in a capsule, by the process to be presently described (§ 217, *c*). It differs from the dentinal pulp, at its first formation, in the more fluid state of its blastema; and in containing fewer and more minute cells. The enamel-pulp is derived from the free inner surface of the capsule; of which we may regard its cells as the epithelium. The cells are largest and most numerous in that portion of the pulp which most nearly approaches the dental papilla; and many of them show a nuclear spot (Fig. 85, *h, h*). In the portion of the enamel-pulp most distant from the capsule, the cells, at first spherical, become impacted against one another, and are pressed into hexagonal or polygonal forms (*i, i*); the fluid blastema being now almost excluded from between them. In the part in closest contiguity with the surface of the dentinal pulp, the cells increase in length, either by the elongation of each individual cell, or by the coalescence of several (*j*); the nuclei (*k*) disappear; and the cells, now forming long prisms (*l*), absorb into themselves calcareous salts, which henceforth completely fill them, in a clear and crystalline form. These salts would not seem to be united, as in bone and dentine, with any organic matters; the small quantity of this existing in Enamel, being probably em-

Fig. 84.



Inner surface of portion of calcified dentinal pulp, forming cap of dentine; *a*, intervals and walls of primary dentinal cells; *b*, walls of dentinal tubes; *c*, nuclear matter, establishing areas of dentinal tubes. For clearer demonstration, the number of tubes in the area of each cell is made less than in nature.

Fig. 85.

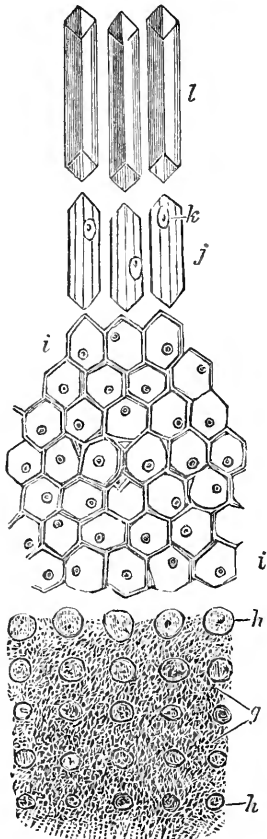

Formation of Enamel; *h*, primary cells suspended in fluid blastema *g*; *i*, the same more fully developed and become angular; *j*, the same becoming prismatic; *k*, the nucleus disappearing; *l*, the modified prismatic cells, filled with calcareous salts, forming the spicula and fibres of enamel.

of the cells with each other, and in the changes which take place coincidentally in their nuclei. These, which are at first large granular spots of a rounded form, send out radiating prolongations, which extend quite to the borders of the cell; and as the calcareous salts which penetrate the cell, are not deposited in the space occupied by the nuclei, the stellate cavities, or lacunæ and diverging canaliculi, are left, which are so analogous to those of bone, as to serve to identify the two tissues. In the cementum, as in Bone and Dentine, the consolidating substance appears to consist of mineral and organic matter in a state of chemical union. The boundaries of the original cells usually disappear in this, as in similar cases; so that nothing remains in the fully-formed cementum, to mark its cellular origin, save the stellate lacunæ which represent the positions of the formerly-existing nuclei.

Fig. 86.

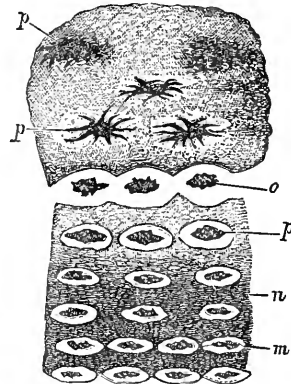

Formation of the Cementum; *m*, primary cells; *p*, their granular nuclei; *n*, more minutely granular blastema; *o*, the primary cell enlarged, and receiving the hardening salts; *n'*, calcified blastema; *p', p'*, stellate nuclei of fully-formed cemental cells.

ployed wholly in forming the walls of the prismatic cells. The disappearance of the nucleus, previously to the calcification of the cell, is evidently the reason of the absence of any permanent space or tube in its interior unoccupied by mineral matter. The islands of Enamel, which are found in the midst of the dentine, in the compound teeth of Herbivorous animals, are formed from extensions of the same enamel-pulp, with that which gives origin to the general envelope of the tooth (§ 217, *c*).

216. The "Cemental pulp," or matrix of the Crusta Petrosa, is in fact nothing else than the capsule itself; in which, at an early period, nucleated cells are found, distributed in the midst of a granular blastema, which is copiously supplied by vessels. The process of calcification begins in the portion nearest the dentine; and consists, as elsewhere, in the absorption of calcareous matter into the cavities of the cells, in the more close aggregation

217. As it is of much practical importance to understand the origin of the several kinds of Human Teeth, and the times of their appearance, some details upon these subjects will be given; those which relate to the mode of development being principally derived from the researches of Mr. J. Goodsir.*

a. At the *sixth* week of Fœtal life, a deep narrow groove may be perceived, in the upper jaw of the Human embryo, between the lip and the rudimentary palate; this is speedily divided into two by a ridge, which afterwards becomes the external alveolar process; and it is in the inner groove, that the germs of the teeth subsequently appear. Hence this may be termed the *primitive dental groove*. At about the *seventh* week, an ovoidal papilla, consisting of a granular substance, makes its appearance on the floor of the groove, near its posterior termination; this papilla is the germ of the Anterior superior Milk Molar tooth. About the *eighth* week, a similar papilla, which is the germ of the Canine tooth, arises in front of this; and during the *ninth* week the germs of the Incisors make their appearance under the same form. During the *tenth* week, processes from the sides of the dental groove, particularly the external one, approach each other, and finally meet before and behind the papilla of the anterior Molar; so as to inclose it in a follicle, through the mouth of which it may be seen. By a similar process, the other teeth are gradually inclosed in corresponding follicles. The germ of the Posterior milk Molar also appears during the tenth week, as a small papilla. By the *thirteenth* week, the follicle of the Posterior Molar is completed; and the several papillæ undergo a gradual change of form. Instead of remaining, as hitherto, simple, rounded, blunt masses of granular matter, each of them assumes a particular shape; the Incisors acquire in some degree the form of the future teeth; the Canines become simple cones; and the Molars become cones flattened transversely, somewhat similar to carnivorous molars. During this period, the papillæ grow faster than the follicles; so that the former protrude from the mouth of the latter. At this time, the mouths of the follicles undergo a change, consisting in the development of their edges, so as to form *Opercula*; which correspond in some measure with the shape of the crowns of the future teeth. There are two of these opercula in the Incisive follicles, three for the Canines, and

Fig. S7.

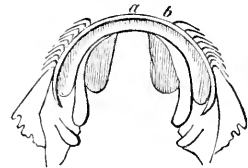

Upper jaw of human embryo at 6th week; showing b, the primitive Dental Groove, behind a, the Lip.

Fig. S8.

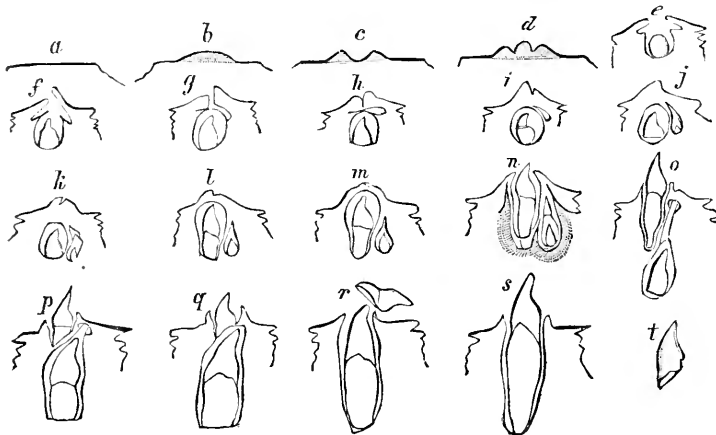

! Diagrams illustrative of the formation of a Temporary, and its corresponding Permanent Tooth, from a Mucous Membrane.

four or five for the Molars. At the *fourteenth* week, the inner lip of the dental groove has increased so much, as to meet and apply itself in a valvular manner to the outer lip or

* Edin. Med. and Surg. Journal, vol. li.

ridge, which has been also increasing. The follicles at this time grow faster than the papillæ, so that the latter recede into the former. The primitive dental groove then contains ten papillæ, inclosed in as many follicles; and thus all necessary provision is made for the production of the first set of teeth. (This series of changes is represented in Fig. 88, *a—g.*) The groove is now situated, however, on a higher level than at first; and it has undergone such a change by the closure of its edges, as to entitle it to the distinctive appellation of *secondary dental groove*. It is in this secondary groove that those structures originate, which are destined for the development of the Second or Permanent set of Teeth,—of those at least which replace the Milk Teeth. This is accomplished in the following manner.

b. At about the *fourteenth* or *fifteenth* week, a little crescentic depression may be observed, immediately behind the inner Opercula of each of the Milk-tooth follicles. This depression gradually becomes deeper, and constitutes what may be termed a *cavity of reserve*; adapted to furnish delicate mucous membrane, for the future formation of the sacs and pulps of the ten anterior Permanent teeth. These cavities of reserve are gradually separated from the secondary dental groove, by the adhesion of their edges; and they thus become minute compressed sacs, situated between the surface of the gum and the milk-sacs. They gradually recede, however, from the surface of the gum, so as to be posterior instead of inferior to the milk sacs; and at last they imbed themselves in the submucous cellular tissue, which has all along constituted the external layer of the milk-sac. The implantation of the Permanent tooth-sacs in the walls of the Temporary follicles, gives to the former the appearance of being produced by a gemmiparous process from the latter. This series of changes is represented in Fig. 88, *g—n.*

c. We now return to the Milk-teeth, the papillæ of which, from the time that their follicles close, become gradually moulded into their peculiarly Human shape. The Molar pulps begin to be perforated by three canals, which, proceeding from the surface towards the centre, gradually divide their primary bases into three secondary bases; and these become developed into the fangs of the future teeth. Whilst this is going on, the sacs grow more rapidly than the papillæ, so that there is an intervening space, which is filled with a gelatinous granular substance—the enamel blastema; this closely applies itself to the surface of the papilla, but does not adhere to it. The branch of the dental artery which proceeds to each sac, ramifies minutely in its proper membrane, but does not send the smallest twig into the granular substance. At this period, the tubercles and apices of the papillæ or pulps become converted into real *dentine* or tooth-substance, in the manner already stated (§ 213); and the granular matter is absorbed as fast as this appears; so that, when the process of conversion has reached the base of the pulp, the interior of the dental sac is left in the villous and vascular condition of a true Mucous membrane, having upon it a very thin layer of the granular substance, or enamel-pulp, which may be considered as a sort of Epithelium; and it is by the deposition of calcareous matter in the long prismatic cells of this, that the *enamel* is

Fig. 89.

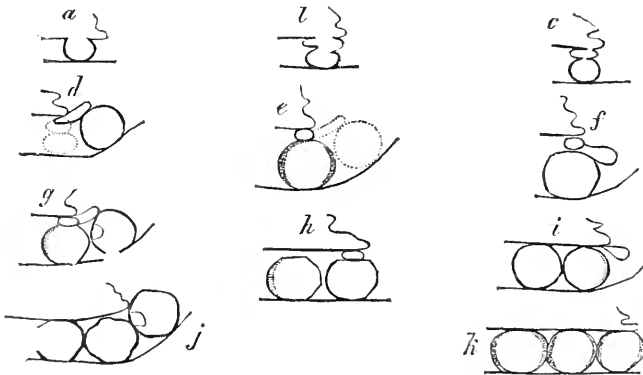

Diagrams illustrative of the formation of the three Permanent Molar teeth, from the non-adherent portion of the Dental Groove.

formed. The opercula, which close the mouth of the dental sac, attain a much greater development in the Molar teeth of Herbivorous animals; where they dip down into the midst of the dentinal pulp, and give origin to insulated spots both of enamel and cementum. It has been remarked by Mr. Lintott, that the lines along which the opercula meet, on the

crown of the Human molar teeth,—that is to say, the groove which separates their tubercles,—is by far the most frequent seat of incipient decay; probably from its tissue having been at the first less perfectly formed than that of the remainder.

d. Whilst these changes are going on, other important preparations are being made for the Permanent set. The general adhesion of the edges of the Primitive Dental Groove, (§ *a*) does not invade the portion which is situated behind the Posterior Milk follicle; this retains its original appearance for a fortnight or three weeks longer, and affords a nidus for the development of the papilla and follicle of the Anterior Permanent Molar tooth, which is developed in all respects on the same plan with the Milk teeth. After its follicle has closed, the edges of the dental groove meet over its mouth; but as the walls of the groove do not adhere, a considerable cavity is left between the sac of the tooth and the surface of the gum. The cavity is a reserve of delicate mucous membrane, to afford materials for the formation of the Second Permanent Molar, and of the Third Permanent Molar, or Wisdom-tooth. The process just described is represented in Fig. 89, *a—c*. It will be convenient here to continue the account of the development of these teeth, although it takes place at a much later period. Towards the end of fetal life, the increase of the bulk of the Milk-tooth sacs takes place so much more rapidly than the growth of the jaw, that the sac of the Anterior Permanent Molar is forced backwards and upwards, into the maxillary tuberosity; and thus it not only draws the surface of the gum in the same direction, but lengthens out the great cavity of reserve (Fig. 99, *d*). During the few months which succeed birth, however, the jaw is greatly lengthened; and when the infant is eight or nine months old, the Anterior Permanent Molar resumes its former position in the posterior part of the dental arch; and the great cavity of reserve returns to its original size and situation (*e*). This cavity, however, soon begins to bulge out at its posterior side, and projects itself, as a sac, into the maxillary tuberosity (*f*); a papilla or pulp appears in its fundus; and a process of contraction separates it from the remainder of the cavity of reserve. Thus the formation of the Second Permanent Molar from the first, takes place on precisely the same plan with the formation of the Permanent Bicuspid from the Temporary Molars. The new sac at first occupies the maxillary tuberosity (*g*); but the lengthening of the jaw gradually allows it to fall downwards and forwards, into the same line, and on a level, with the rest (*h*). Before it leaves the tuberosity altogether, the posterior extremity of the remainder of the cavity of reserve sends backwards and upwards its last offset—the sac and pulp of the Wisdom-tooth (*i*); this speedily occupies the tuberosity after the second molar has left it (*j*); and ultimately, when the jaw lengthens for the last time, at the age of nineteen or twenty, it takes its place at the posterior extremity of the range of the adult teeth (*k*). Thus, the Wisdom-teeth are the second products of the posterior or great cavities of reserve; and the final effects of development in the secondary dental groove. In the Elephant, in which there is a continual new production of molar teeth at the back of the jaw, it is probable that from each sac a cavity of reserve is formed, which produces the succeeding tooth; and thus the only essential difference between its dentition and that of Man, consists in the degree of continuance of this gemmiparous process; which ceases in Man, after being twice performed, but is repeated in the Elephant until nearly the close of its life.

e. We have thus sketched the history of the Development of the Teeth, up to the time when they prepare to make their way through the gum. The first stage of this development may be termed the *papillary*; and the second the *follicular*. The latter terminates when the papillæ are completely hidden by the closure of the mouths of the follicles, and of the groove itself. The succeeding stage, which has long been known as the *saccular*, is the one during which the whole formation of the Tooth-substance, and of the Enamel, takes place. It is during this period, also, that the ossification of the jaw is being effected; and that the bony sockets are formed for the teeth, by the consolidation of the anterior and posterior ridges bounding the alveolar groove (in which the dental groove was originally imbedded), and of the interfollicular septa, which are produced by the meeting of transverse projections from these ridges.—The history of development in the Lower Jaw is very nearly the same; the chief difference being in the origin and situation of the primitive dental groove.

f. We have now only to consider the fourth or *eruptive* stage,—that in which the Teeth make their way through the gum. This process chiefly results from the lengthening of the fang, by the addition of new bony matter; and the crown of the tooth is thus made to press against the closed mouth of the sac (Fig. 98, *m*). This at last gives way, so that the sac assumes its previous condition of an open follicle. When the edge of the tooth has once made its way through the gum, it advances more rapidly than can well be accounted for by the usual rate of lengthening of its fang; and this appears to be due to the separation of the bottom of the sac from the fundus of the alveolus; so that the whole tooth-apparatus is carried nearer to the surface, leaving a space at the bottom of the alveolar cavity, in which the further lengthening of the root can take place (*n*). The open portion of the sac remains as the narrow portion of the gum, which forms a vascular border and groove round the neck of the perfected tooth (*o*). The deeper portion of the sac adheres to the fang of the tooth,

and is converted by ossification into the *Cementum* or *Crusta Petrosa* (§ 216). What is commonly denominated the *Periosteum* of the *Tooth*, really belongs as much to the *Alveolus*. It is connected with the tooth by the submucous cellular tissue, which originally intervened between the tooth-sac and the walls of the osseous cavity. It appears from Mr. Nasmyth's researches, that the inner layer of the portion of the capsule which covered the crown of the tooth, remains adherent to it; forming a thin coating of *Crusta Petrosa* (most of which is, however, soon worn off) over the *Enamel*.—During the period that the *Milk-teeth* have been advancing, along with their sockets, to their perfect state and ultimate position, the *Permanent sacs* have been receding in an opposite direction, and have with their bony crypts been enlarging; and at last they occupy a position almost exactly below the former (*n* and *o*). They still retain a communication with the gum, however; the channel by which they descended not having completely closed up, and the neck of the sac being elongated into a cord which passes through this. The channels may afterwards serve as the *vincula dentium*, and the cords as *gubernacula*; but it is uncertain whether they really afford any assistance in directing the future rise of the tooth to the surface; the successive stages of which are represented in Fig. 98, *p—t*. The sacs of the permanent teeth derive their first vessels from the gums; ultimately they receive their proper dental vessels from the *Milk-sacs*; and, as they separate from the latter into their own cells, the newly-formed vessels, conjoining into common trunks, also retire into permanent dental canals, and gradually become the most direct channels for the blood transmitted through the jaw.

g. The following interesting generalizations respecting the development of the teeth, result from Mr. Goodsir's researches. 1. The *Milk-teeth* are formed on both sides of either jaw in three divisions,—a *Molar*, a *Canine*, and an *Incisive*; in each of which, dentition proceeds in an independent manner. 2. The dentition of the whole arch proceeds from behind forwards; the *Molar* division commencing before the *Canine*, and the *Canine* before the *Incisive*. 3. The dentition of each of the divisions proceeds in a contrary direction, the *Anterior Molar* appearing before the *Posterior*, the *Central Incisor* before the *Lateral*. 4. Two of the subordinate phenomena of nutrition also obey this inverse law;—the follicles closing by commencing at the median line and proceeding backwards; and the dental groove disappearing in the same direction. 5. Dentition commences in the *Upper Jaw*, and continues in advance during the most important period of its progress. The development of the *Superior Incisors*, however, is retarded by a peculiar cause; so that the *Inferior Incisors* have the priority in the time of their completion and appearance. 6. The germs of the *Permanent* teeth, with the exception of that of the *Anterior Molar*, appear in a direction from the median line backwards. 7. The *Milk-teeth* originate, or are developed, from mucous membrane. 8. The *Permanent* teeth, also originating from mucous membrane, are of independent origin, and have no connection with the *milk-teeth*. 9. A *tooth-pulp* and its sac must be referred to the same class of organs, as the combined *Papilla* and *Follicle* from which a hair or feather is developed.

h. The following is the usual order and period of appearance, of the several pairs of *Milk-teeth*. The *Four Central Incisors* first present themselves, usually about the *seventh* month after birth; but frequently much earlier or later: those of the *Lower Jaw* appear first. The *Lateral Incisors* next show themselves, those of the *Lower Jaw* coming through before those of the upper; they usually make their appearance between the *seventh* and *tenth* months. After a short interval, the *Anterior Molars* present themselves,—generally soon after the commencement of the *Second Year*; and these are followed by the *Canines*, which usually protrude themselves between the *fourteenth* and *twentieth* months. The *Posterior Molars* are the last, and the most uncertain in regard to their time of appearance; this varying from the *eighteenth* to the *thirty-sixth* month. In regard to all except the front teeth, there is no settled rule as to the priority of appearance of those in the *Upper* or *Under Jaw*; sometimes one precedes, and sometimes the other; but in general it may be stated, that, whenever one makes its appearance, the other cannot be far off. The same holds good in regard to the two sides, in which development does not always proceed exactly *pari passu*.—The period of *Dentition* is one of considerable risk to the *Infant's* life. The pressure upon the nerves of the gum, which necessarily precedes the opening of the sac and the eruption of the tooth, is a fruitful source of irritation; producing disorder of the whole system, especially of the *Digestive organs*, and not unfrequently giving origin to fatal *Convulsive affections*. These last have been particularly studied by Dr. M. Hall, who recommends the free use of the *gum-lancet*, as a most important means of prevention and cure. Even where *Dentition* proceeds quite naturally and is not itself a cause of diseased action, it induces an irritable state of the whole constitution, which aggravates the effects of other morbid causes. It is, therefore, of the greatest consequence that the infant should be withdrawn during this period, from all injurious influences; and that no irregularity of diet, or deficiency of fresh air and exercise, should operate to its disadvantage.

i. After the lapse of a few years, the further elongation of the jaw permits the appearance of the *First True Molar*; which, as already remarked, is really a *Milk-tooth*, so far as its formation is concerned. This commonly presents itself about the middle or end of the

Seventh Year; sometimes preceding, and sometimes following, the exchange of the Central Incisors, which takes place about the same time. When the Permanent Teeth have so much enlarged, that they can no longer be contained within their own alveoli, they press upon the anterior parietes of those cavities, and cause their absorption; so that each tooth is allowed to come forwards, in some degree, into the lower part of the socket of the corresponding Temporary tooth. The root of the temporary tooth now begins to be absorbed, generally at the part nearest its successor; and this absorption proceeds as the new tooth advances, until the root of the Milk-tooth is completely removed: when its crown falls off, leaving room for the permanent tooth to supply its place (Fig. 88, *p-t*). This absorption is usually regarded as due to the pressure of the Permanent tooth, but this does not appear to be the case; for it is mentioned by Mr. Bell, that it is not an uncommon occurrence for the root of the temporary tooth to be wholly absorbed, and for the crown to fall out spontaneously, long before the succeeding tooth has approached the vacant space. The same has been remarked by Mr. Bell, of the cavity in the jaw which is formed for the reception of the sac of the Permanent tooth, at the time that it buds off from that of the milk-tooth; the excavation being often seen to commence before the new sac is formed. Hence, although the two processes, growth, and absorption, are usually contemporaneous in each instance, they are by no means dependent on each other. Still it would seem that the existence, if not the pressure of the new Tooth is necessary to determine the absorption of the old; for cases are not infrequent, in which the Temporary teeth retain their situation in the mouth, with considerable firmness, until adult age,—the corresponding permanent ones not having been formed.

k. In the successive replacement of the Milk-teeth by the Permanent set, a very regular order is usually followed. The Middle Incisors are first shed and renewed, and then the Lateral Incisors. The Anterior Milk Molars next follow; and these are replaced by the Anterior Bicuspid teeth. About a year afterwards, the Posterior Milk Molars are shed, and are replaced in like manner by Bicuspid teeth. The Canines are the last of the Milk-teeth to be exchanged; the development of the new ones not taking place until the 12th year. In the succeeding year, the Second pair of the True Molars appears; the third pair, or *dentes sapientia*, are seldom developed until three or four years subsequently, and often much longer. It has been recently proposed* (and, from the evidence adduced in its favour, the proposition would seem entitled to considerable attention) to adopt the successive stages in the Second Dentition, as standards for estimating the physical capabilities of Children, especially in regard to those two periods which the Factory Laws render it of the greatest importance to determine, namely, the ages of *nine* and *thirteen* years. Previously to the former, a child is not permitted to work at all; and up to the latter, it may be only employed during 9 hours a day. The necessities or the cupidity of Parents are continually inducing them to misrepresent the ages of their children; and it has been found desirable, therefore, to seek for some test, by which the capability of the Child may be determined, without a knowledge of its age. A standard of Height has been adopted by the Legislature for this purpose; but upon grounds which, Physiologically considered, are very erroneous; since, as is well known, the tallest children are frequently the weakest. According to Mr. Saunders, the degree of advance of the Second Dentition may be regarded as a much more correct standard of the degree of general development of the organic frame, and of its physical powers; and it appears from his inquiries, that it may be relied on as a guide to the real age, in a large proportion of cases; whilst no serious or injurious mistake can ever arise from its use. It may happen that local or constitutional causes may have slightly retarded the development of the Teeth; in which case the age of the individual would rather be under-estimated, and no harm could ensue: on the other hand, instances of premature development of the Teeth very rarely, if ever, occur: so that there is no danger of imputing to a Child a capability for exertion which he does not possess, as the test of height is continually doing. Moreover, if such an advance in Dentition should occur, it might probably be regarded as indicative of a corresponding advance in the development of the whole organism; so that the real capability would be such as the teeth represent it.

l. The following is Mr. Saunders' statement of the Ages at which the Permanent teeth respectively appear. The first True Molars usually make their appearance towards the end of the 7th year. Occasionally one of them protrudes from the gum at 6, or more frequently at 6½ years of age; but the evolution of the whole of them may be regarded as an almost infallible sign of the Child's being 7 years old. In other instances, however, where the tooth on one side of the month is freely developed, it is fair to reckon the two as having emerged from their capsule; since the development of the other must be considered as retarded. This rule only holds good, however, in regard to teeth in the same row; for the development of the teeth in either jaw must not be inferred from that of the corresponding teeth in the other.

* "The Teeth a Test of Age, considered with reference to the Factory Children." By Edwin Saunders.

With this understanding, the results of the application of the following table will probably be very near the truth.

Central Incisors developed at	8 years.
Lateral Incisors	9 —
First Bicuspid	10 —
Second Bicuspid	11 —
Canines	12 to 12½
Second Molars	12½ to 14

The following are the results of the application of this test, in a large number of cases examined by Mr. Saunders. Of 708 children of *nine* years old, 530 would have been pronounced by it to be near the completion of their *ninth* year; having the central, and either three or four lateral, incisors fully developed. Out of the remaining 178, it would have indicated that 126 were 8½ years old, as they presented one or two of the Lateral Incisors; and the 52 others would have been pronounced 8 years old, all having three or four of the Central Incisors. So that the extreme deviation is only 12 months; and this in the considerable proportion (when compared with the results obtained by other means) of 52 in 708, or 7½ per cent. Again, out of 338 children of 13 years of age, 294 might have been pronounced with confidence to be of that age, having the Canines, Bicuspid, and Second Molars, either entirely developed, or with only the deficiency of one or two of either class. Of the 44 others, 36 would have been considered as in their 13th year, having one of the Posterior Molars developed; and 8 as near the completion of the 12th, having two of the Canines, and one or two of the Second Bicuspid. In all these instances, the error is on the favourable side,—that is, on the side on which it is calculated to prevent injury to the objects of the inquiry; in no instance did this test cause a Child to be estimated as older or more fit for labour than it really was.

m. The value of this test, as compared with that of Height, is manifested by a striking example adduced by Mr. Saunders. The height of one lad, J. J., aged 8 years and 4 months, was 4 feet and ¾ of an inch; that of another boy, aged 8 years and 7 months, was only 3 feet 7¼ inches. According to the standard of height adopted by the Factory Commissioners (namely, 3 feet 10 inches), the *taller* lad would have been judged fit for labour, whilst the *shorter* would have been rejected. The Dentition of the latter, however, was further advanced than that of the former; for he had two of the Lateral Incisors, whilst the former had only the Central; and the determination of their relative physical powers, which would have been thus formed, would have been in complete accordance with the truth. The elder boy, though shorter than the other by 5½ inches, possessed a much greater degree both of corporeal and mental energy, and his pulse was strong and regular; whilst that of the younger lad, who was evidently growing too fast, was small and frequent.—An instance even more striking has come under the Author's own observation.

10. Simple Tubular Tissues.

218. We have seen that all the Animal Tissues, whose structure has been yet considered, derive the materials of their growth and renovation from the nutrient fluid; which is brought into a more or less close relation with their elementary parts, by means of Capillary blood-vessels. These seem to have a claim to be regarded as among the elementary parts of the fabric; since they are formed quite independently of the larger trunks, and have little in common with them in their function. All those changes which take place between the blood and the surrounding parts, whether ministering to the functions of Nutrition, Secretion, or Respiration, occur during its movement through the Capillary vessels: and the function of the larger trunks is merely to bring to them a constant supply of fresh blood, regulated according to the demand created by the actions to which it is subservient; and to remove the fluid which has circulated through them. When we examine into the structure of the Circulating apparatus in Plants and in the lower Animals, we find that the canals, which convey the nutritive fluid, are of two kinds;—either simple excavations in the solid tissues or unfilled vacuities;—or tubes with definite membranous walls. The former are known, in Plants, under the name of *inter-cellular passages*; and, among the lower tribes in particular, they have a large share in the conveyance of the nutritious fluid from one part of the

structure to the other. Similar passages exist to a great extent among the Invertebrata; the venous circulation in particular being mainly carried on by them. We have an example of them, even in Man, in the Sinuses through which the venous blood is returned from the Brain; these sinuses being simple passages formed by the folds of the Dura Mater. In the higher Plants, however, the circulation of fluid is for the most part carried on through Ducts, having distinct membranous parietes; and these ducts may be either straight and simple tubes, as are those of the interior of the stem through which the sap ascends; or they may form a network by their mutual anastomosis, such as that by which the sap descends through the bark and newer wood. Both of these forms of ducts appear to be formed by the coalescence of cells; the straight cylindrical ducts being formed from cells, arranged in a simple linear manner; and the network of vessels for the descent of the elaborated sap, being produced by the junction, at various points, of cells of less regular form, which stretch out to meet each other.

219. In all the higher Animals,—in their adult condition at least,—the Capillary circulation is entirely carried on through tubes having distinct membranous parietes. These tubes commonly form a minutely-anastomosing network; into which the blood is brought by the ramifications of the arteries on one side, and from which it is returned by the radicles of the veins on the other. The walls of the tubes are composed of a delicate membrane, in which an appearance of transverse striation (as if produced by minute annular fibres) can sometimes be discerned. The diameter of the Capillaries varies in different animals, in accordance with that of their blood-corpuses; thus the

Fig. 90.

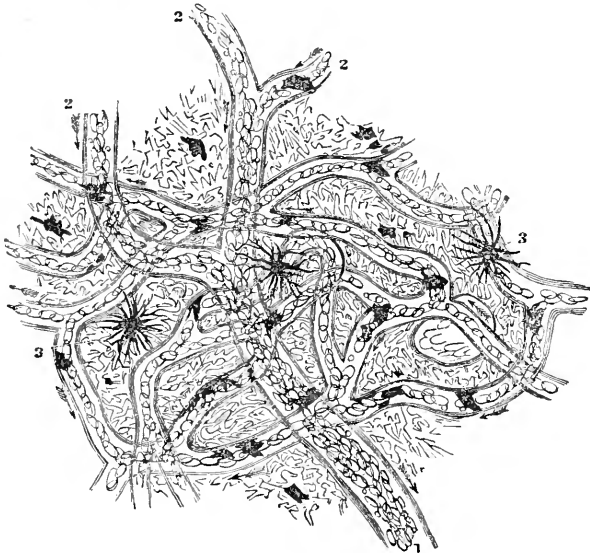

Capillary circulation in a portion of the web of a *Frog's* foot, magnified 110 diameters; 1, trunk of vein; 2, 2, its branches; 3, 3, pigment cells.

Capillaries of the *Frog* are of course much larger than those of *Man*. The diameter of the latter appears, from the measurements of *Weber*, *Müller*, and others, to vary from about the 1-3700th to the 1-2500th of an inch; but as they can only be examined after death, it is probable that these statements are

not altogether exact, particularly as tubes of the smallest of the above sizes would not admit ordinary blood-corpuscles. The dimensions of the individual vessels, indeed, are by no means constant; as may be seen by watching the Circulation in any transparent part, for some little time. Putting aside the general changes, in diameter, which result from circumstances affecting all the capillaries of a part, it may be observed that a single capillary will sometimes enlarge or contract by itself without any obvious cause. Thus, the stream of blood will sometimes be seen to run into passages, which were not before perceived; and it has hence been supposed that they were new excavations, formed by the retreating or removal of the solid tissue through which it passes. But a more attentive examination shows, that such passages are real capillaries, which did not, at the time of the first observation, admit the stream of blood-corpuscles, in consequence of the contraction of their calibre, or of some other local impediment; and that they are brought into view by the simple increase in their diameter. The compression of one of the small arteries will generally occasion an oscillation of the corpuscles of blood in the smallest capillaries, which will be followed by the disappearance of some of them; but when the obstruction is removed, the blood soon regains its former velocity and force, and flows exactly into the same passages as before.

220. The opinion was long entertained, that there are vessels adapted to supply the white or colourless tissues; carrying from the arteries the *Liquor Sanguinis*, or fluid portion of the blood; and leaving the *Corpuscles* behind, through inability to receive them. But such a supposition is altogether groundless. Some of the white tissues, as *Cartilage*, are altogether destitute of vessels; and in others, the supply of blood is so scanty, as not to communicate to them any decided hue. It is evident from what has been already stated, that the idea that *Nutrition* can *only* be carried on by means of *Capillary* vessels, is entirely gratuitous. There is no essential difference, in fact, between the nutrition of the non-vascular tissues, and that of the islets in the midst of the network of capillary vessels, which traverses the most vascular.

Fig. 91.

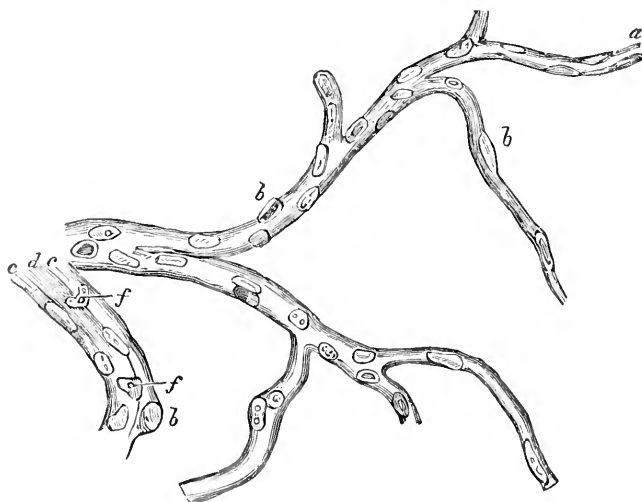

Capillary vessels from the pia mater; *a*, calibre of the tube, partly occupied by oval nuclei, alternately arranged lengthways, and epithelial in their character; *b, b, b*, nuclei projecting on the exterior of the tube; *c, c*, walls, and *d*, calibre, of a large branch; *f, f*, oval nuclei, arranged transversely. Magnified 410 diameters.

In both cases, the nutrient materials conveyed by the blood are absorbed by the cells or other elementary parts of the tissue immediately adjoining the vessels, and are imparted by them to others which are further removed; and the only variation which exists, is in the amount of the portion of tissue that has to be thus traversed. There is great variety in this respect, as we have seen, among the vascular tissues; and we are only required to extend our ideas, from the largest of the islets which we find in these, to the still more isolated structures, of which the non-vascular tissues are composed. The distribution of Capillaries through the vascular tissues, and the character of the reticulation which they form, vary so greatly in the different parts of the fabric, that it is possible to state with tolerable certainty the nature of the part from which any specimen has been detached,—whether a portion of skin, mucous membrane, serous membrane, muscle, nerve, fat, areolar tissue, gland, &c. But the arrangement of vessels peculiar to each evidently has reference only to the convenience of the distribution of blood among the elementary parts of the tissue, and varies with their form. It is not possible to imagine that it has any other relation than this to their function; since, as already shown, the function of each separate element of the organ, of which that of the entire organ is the aggregate, is due to its own inherent vital powers,—the supply of blood being only required as furnishing the material, on which these are to be exercised.

221. It has been rendered highly probable, by the observations of Schwann and other Physiologists, that the Capillaries of Animals originate in cells, like the straight and anastomosing Duets of Plants. Bodies having the appearance of cell-nuclei may frequently be seen in the walls of the capillaries of embryos and of tadpoles; and these are too wide apart to warrant the idea, that they are the nuclei of epithelial cells, such as those which line the larger vessels. Similar nuclei may be brought into view in the capillaries of adult animals, by treating them with acetic acid; and they are particularly well seen in the *Pia Mater*, which consists almost entirely of a congeries of blood-vessels (Fig. 91). The accompanying figure shows the contrast between the long oval nuclei *b, b*, imbedded at intervals in the walls of the true capillaries, and rather projecting on their exterior; and the nuclei of the epithelium-cells, *f, f*, lining the interior of a larger branch, which last are more numerous and of less regular form, and are sometimes placed transversely to the direction of the tube.

222. The first formation of the Capillary blood-vessels in the vascular area in the Bird's egg, is described by Schwann as being affected entirely by the coalescence of cells, which send off prolongations in various directions, in the manner of stellate pigment-cells, such as those seen at *c, c*, Fig. 90. By the junction of these prolongations, a network of tubes is formed, which is at first very irregular in its character; the greatest diameter of the tubes being in the situation of the centres or bodies of the original cells; whilst between these, at the points where their prolongations coalesced, they are much contracted. The calibre of the vessels, however, gradually becomes equalized (Fig. 92); and the network becomes connected with the larger trunks, and bears a part in the general circulation.—Appearances indicative of a similar process, have been seen in the tail of very young Tadpoles; so that it may probably be regarded as the general method, by which new capillaries are formed in the natural process of growth. Observations upon the history of the operations, which are performed for the

Fig. 92.

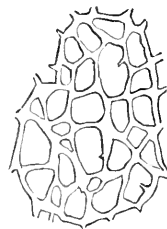

First appearance of blood-vessels in the vascular layer of the germinal membrane of a *Fowl* at the 36th hour of incubation.

repair of injuries, lead to precisely the same conclusions. The first appearance of the vascular network in the newly-forming tissue, is in the form of transparent arborescent streaks; which push out extensions on all sides; these encounter one another, and form a complete series of capillary reticulations, some of which come into connection with the vessels of the surrounding parts. According to the observations of Mr. Travers,* isolated corpuscles enter these newly-formed capillaries, and perform an oscillating movement in them for some hours, before any series of them passes into it; so that we cannot regard the new channel as burrowed out by a string or file of red corpuscles, pushed forth from the nearest capillary by *vis à tergo*, as some have maintained.

11. Compound Tubular Tissues.

223. There now remain to be described two elements of the Animal fabric, to which there is scarcely anything that bears the least analogy in the structure of Plants;—namely, the *Muscular* and *Nervous* tissues. We have seen that, putting aside the Simple Fibrous tissues, whose function is purely mechanical, the Animal fabric, so far as we have yet passed its elements under review, is constructed upon the very same type with that of Plants; all the parts actively concerned in the processes of nutrition, secretion, reproduction, &c., retaining their original *cellular* character; the vessels that serve for the conveyance of fluid, having their origin in cells, whose cavities have coalesced; whilst the more solid portions of the frame-work are made up of united cells, whose cavities are occupied by internal deposit.—Now the purpose of the Muscular and Nervous system is entirely different. The former is the one, by which all the sensible movements of the body are immediately effected; and it is only amongst a small number of Plants, that any such movements are exhibited. The latter serves as the instrument by which sensations are received; and by which the instincts, emotions, or volitions, excited by these sensations, act upon the muscles:—a class of functions which we have no reason whatever to regard as performed by Plants. In fact, as already pointed out (§ 1—4), the distinction between the two kingdoms is more properly founded upon the presence of these functions and of their instruments in the Animal, and upon their absence in the Plant, than upon any other structural character.

224. Now it might have not been unreasonable to expect, that tissues altogether so dissimilar in their properties, and in the purposes to which they are destined, should have a structure departing widely from the type of the simple Cell. Yet it does not appear that this is the case. That portion of the Nervous matter, by which its most active functional changes are effected, retains its original cellular character without alteration; and the so-called fibres, which constitute the Nerve-trunks, and which convey the influence of these changes, are in reality *tubes*, formed as it would seem by the coalescence of a linear series of cells, and chiefly distinguished by the peculiar nature of their internal deposit. In like manner, we shall find that the ultimate Muscular Fibre is also a tube, formed out of the same elements, and distinguished by the nature of its contents; which, in the most perfect form of the tissue, are composed of linear series of extremely minute secondary cells.

225. Muscular tissue exists under two forms; one in which the ultimate fibres are marked by transverse striæ; and the other in which they are plain or unstriped. The former is chiefly employed in performing the various movements, which are effected through the agency of the Nervous system, and which

* Physiology of Inflammation and the Healing Process.

are connected with the peculiarly Animal powers of the being. The latter is with difficulty called into action through the nervous system, but is much more readily excited by stimuli applied to itself; and this is employed to perform various movements, which are more immediately concerned in the Vegetative or organic functions.*

226. When we examine an ordinary Muscle (from one of the extremities, for example) with the naked eye, we observe that it presents a fibrous appearance; and that the fibres are arranged with great regularity, in the direction in which the muscle is to act. Upon further examination it is found, that these fibres are arranged in *fasciculi* or bundles of larger or smaller size, connected by means of areolar tissue; and when the Microscope is applied to the smallest fibre which can be seen with the naked eye, it is seen itself to consist of a fasciculus, composed of a number of cylindrical fibres lying in a parallel direction, and closely bound together. These primitive fibres present two sets of markings or *striæ*; one set *longitudinal*,—the other *transverse* or annular. By more closely examining these *fibres*, when separated from each other, it is frequently seen that each may be resolved into *fibrillæ*, by the splitting of its contents in a *longitudinal* direction, as shown in Fig. 93. These fibrillæ have a peculiar *beaded* appearance, which will be presently noticed more particularly.—It not unfrequently happens, however, that when a fibre is drawn apart, its contents separate in the direction of the *transverse* striæ; forming a series of *discs*, as shown in Figs. 94 and 95. This cleavage is just as natural as the former, though less frequent; and it leads us to a view of the composition of Muscular Fibre, somewhat different from the one commonly adopted. To use the

Fig. 93.

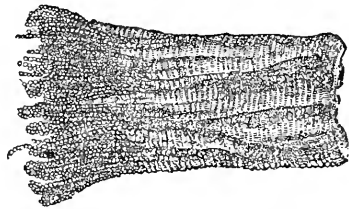

Fasciculus of Fibres of Voluntary Muscle; the fibres separated at one end, into brush-like bundles of fibrillæ.

Fig. 94.

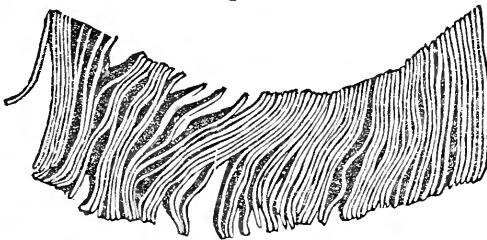

Portion of Human Muscular fibre, separating into discs, by cleavage in direction of transverse striæ.

words of Mr. Bowman,† it would be as proper to say, “that the fibre is a pile of *discs*, as that it is a bundle of *fibrillæ*; but in fact it is neither the one nor the other, but a mass in whose structure there is an intimation of the existence of both, and a tendency to cleave in the two directions. If there were a general disintegration along all the lines in both directions, there would result a

* By some, the two classes have been spoken of as those of Voluntary and Involuntary muscles; but this distinction is not correct; since every muscle ordinarily termed voluntary, may be called into action involuntarily.

† See Bowman on the Minute Structure and Movements of Voluntary Muscle; in Phil. Trans. 1840.

series of particles, which may be termed *primitive particles* or *sarcous elements*, the union of which constitutes the mass of the fibre. These elementary

[Fig. 95.

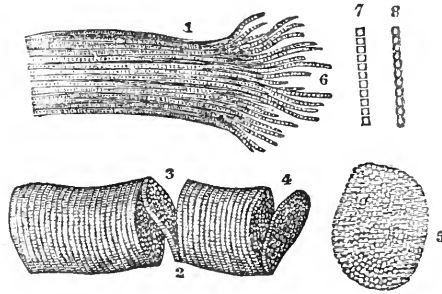

Fragments of Striped Elementary Fibres, showing a cleavage in opposite directions; magnified 300 diameters; 1, longitudinal cleavage; the longitudinal and transverse lines are both seen; some longitudinal lines are darker and wider than the rest, and are not continuous from end to end; this results from partial separation of the fibrillæ; 6, fibrillæ, separated from one another by violence at the broken end of the fibre, and marked by transverse lines equal in width to those on the fibre; 7, 8 represent two appearances commonly presented by the separated single fibrilla, (more highly magnified;) at 7 the borders and transverse lines are all perfectly rectilinear, and the included spaces perfectly rectangular; at 8 the borders are scalloped, the spaces bead-like; when most distinct and definite, the fibrilla presents the former of these appearances; 2, transverse cleavage; the longitudinal lines are scarcely visible; 3, incomplete fracture following the opposite surfaces of a disc, which stretches across the interval and retains the two fragments in connection; the edge and surface of this disc are seen to be minutely granular, the granules corresponding in size to the thickness of the disc, and to the distance between the faint longitudinal lines; 4, another disc nearly detached; 5, detached disc more highly magnified, showing the sarcous elements.]

particles are arranged and united together in the two directions. All the resulting discs, as well as fibrillæ, are equal to one another in size; and contain an equal number of particles. The same particles compose both. To detach an entire fibrilla, is to abstract a particle of every disc; and *vice versâ*."

227. The elements of Muscular Fibre are bound together, in the perfect condition of the fibre, by a very delicate tubular sheath. This cannot always be readily brought into view; but it is occasionally seen with great distinctness: thus, when the two ends of a fibre are drawn apart, its contents will

sometimes separate without the rupture of the sheath, which then becomes evident; and this, during the act of contraction, may sometimes be observed to rise up in wrinkles upon the surface of the fibre, as seen in Fig. 100. This sheath is quite distinct from the areolar tissue, which binds the fibres into fasciculi; and it has been termed, for the

Fig. 96.



Fibre of Human Muscle broken across; the fragments connected by the untorn Myolemma.

sake of distinction, the *Myolemma*.

Its existence may be demonstrated in any Muscular fibre, by subjecting it to the action of fluids, which occasion a swelling of its contents; this is especially the effect of acids and alkalies, and may be well produced by the citric and tartaric acids, and by potash. For a time, the Myolemma yields to the distention which takes place from within; but at last it bursts at particular points, and a sort of hernia of its contents takes place, making the existence of a perfect envelope in all other parts quite

evident. This membrane is itself perfectly transparent, and has nothing to do with the production of either the longitudinal or the transverse striæ. There is no reason to believe that it is perforated either by nerves or by capillary vessels; in fact it seems to be an effectual barrier between the real elements of Muscular structure, and the surrounding parts. That it has no share in the contraction of the fibre, is evident from the fact just mentioned, respecting the condition which it occasionally presents when the fibre is much shortened.

228. Muscular Fibres are commonly described as cylindrical; but there is reason to believe that they are rather of a polygonal form, their sides being flattened against those of adjoining fibres (Fig. 97). In some instances the angles are sharp and decided; in others they are rounded off, so as to leave spaces between the contiguous fibres for the passage of vessels. In Insects, the fibres often present the form of flattened bands. The average diameter of the fibres in Man may be stated at about 1-400th of an inch; being somewhat greater than this in the Male, and less in the Female. Their size varies considerably, however, in different classes of animals; and even in the same animal, and the same muscle. The following table gives illustrations of these varieties; the extremes are those met with by Mr. Bowman himself; but other observers speak of dimensions more widely separated.

		Fractions of an inch.	
MAMMALIA . . .	Human	{ Male	$\frac{5}{107}$ to $\frac{1}{132}$
		{ Female	$\frac{6}{15}$ to $\frac{1}{384}$
	Cat	$\frac{1}{1000}$ to $\frac{1}{400}$	
	Horse	$\frac{1}{1100}$ to $\frac{1}{308}$	
	Mole	$\frac{1}{775}$ to $\frac{1}{316}$	
BIRDS	Mouse	$\frac{1}{400}$ to $\frac{1}{600}$	
	Owl	$\frac{1}{1000}$ to $\frac{1}{700}$	
	Chaffinch	$\frac{1}{800}$ to $\frac{1}{310}$	
	Heron	$\frac{1}{1500}$ to $\frac{1}{300}$	
REPTILES	Frog	$\frac{1}{1000}$ to $\frac{1}{600}$	
	Lizard	$\frac{1}{600}$ to $\frac{1}{130}$	
FISH	Boa	$\frac{1}{600}$ to $\frac{1}{65}$	
	Skate	$\frac{1}{300}$ to $\frac{1}{60}$	
	Cod	$\frac{1}{236}$ to $\frac{1}{200}$	
INSECTS	Sprat	$\frac{1}{440}$ to $\frac{1}{310}$	
	Staghorn Beetle	$\frac{1}{443}$ to $\frac{1}{400}$	
	Blue-bottle Fly	$\frac{1}{755}$ to $\frac{1}{400}$	

It is interesting to remark, upon this table, that the Muscular Fibre of Reptiles and Fishes is upon the whole much larger than that of other Vertebrata, and that its dimensions present the greatest extremes of variation; whilst in Birds, it is much smaller than in all other Vertebrata, and its dimensions are also less variable. Further, the size of the fibres bears no proportion to that of the animal; for we observe that in the Chaffinch they are larger than in the Owl, in the Cat larger than in the Horse, and in the Frog often larger than in the Boa. Moreover in Insects, the diameter of the fibres is even greater than it is in Mammalia.—The *average* distance of the transverse striæ, in the muscular fibre of different animals, is very nearly uniform; as will be seen from the following table. Between the extremes, however, there is considerable variation; and this will be presently shown to depend upon the condition of the muscle, at the time of examination. The distance is not only often different in the same muscle and the same fasciculus, but even in the same fibre in different parts of its length. The figures indicate the number of striæ in 1-1000th of an inch. The extremes *in the same specimen*, however, are in no instance so widely apart, as the table indicates for the Class; the

greatest proportion between the maximum and minimum being, except in Insects, as 2 to 1.

	Maximum.	Minimum.	Mean.
Human	15.0	6.0	9.4
Other Mammalia	15.0	6.7	10.9
Birds	14.0	7.0	10.4
Reptiles	20.0	6.7	11.7
Fish	18.0	7.5	11.1
Insects	16.0	4.5	9.5

229. It has been maintained by some, that each Muscular Fibre is a hollow bundle of fibrillæ; but the appearance presented by transverse sections proves that this is not the case, the whole area of the tube being occupied by fibrillæ, without any trace of central cavity. The extremities of the cut fibrillæ, however, cannot always be distinguished in Mammalia, in consequence, as it would seem, of their close and intimate lateral union; but they are very evi-

Fig. 97.

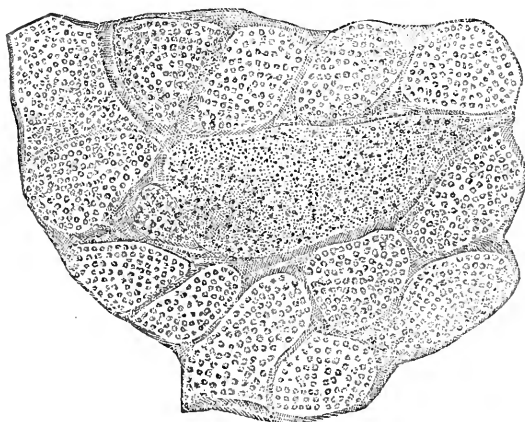

Transverse section of Muscular fibres from pectoral muscle of Teal; showing the irregular form of the fibres, and the aggregation of circular particles, with which they are completely filled.

dent in Birds, Reptiles, and Fishes (Fig. 97). The addition of an acid increases the distinctness of the fibrillæ, by widening the interstices between them.

230. When the fibrillæ are separately examined, they are found to present an alternation of dark and light spaces, corresponding with the transverse striæ of the fibre, and the lighter intervals between them. It is this alternation, which gives to the fibrillæ the beaded appearance they present, when their outline is not perfectly seen. When good specimens, however, are carefully examined under a sufficient magnifying and good defining power, it is seen that the border of the fibrillæ is straight or nearly so; so that the beaded appearance is an optical illusion. Moreover, each of the light spaces is seen to be crossed by a delicate but distinct line, separating it into two equal parts; and upon attentive examination it is seen, that a transparent border, equal in breadth to either of these parts, is seen at the *sides*, as well as between the *ends*, of the dark spaces. Thus each dark space is completely surrounded by this pellucid border; and it can scarcely be doubted that the whole constitutes a complete though minute *cell*, and that the entire fibrilla

is made up of a linear aggregation of such cells.* When the fibril is in a state of relaxation, as seen at *a*, the diameter of the cells is greatest in the

Fig. 98.



Fragment of Muscular fibre from macerated heart of Ox, showing formation of striæ by the aggregation of fibrillæ.

longitudinal direction; but when it is contracted, the fibril increases in diameter as it diminishes in length; so that the transverse diameter of each cell equals or even exceeds the longitudinal diameter, as seen at *b*. The difference between the two states is frequently much more striking than is represented in the figure. — Thus the act of Muscular contraction seems to consist in a change of

form in the cells of the ultimate fibrillæ, consequently upon an attraction between the walls of their two extremities, or perhaps between their nuclei; and it is interesting to observe how very closely it thus corresponds with the contraction of certain Vegetable tissues, of which the component cells change their form when irritated, and thus produce a movement (§ 1). The essential difference, therefore, between the striated muscular tissue of Animals, and the contractile tissues of Plants, consists in the subjection of the former to nervous influence. — The diameter of the ultimate fibrillæ, and the length of the component cells, will of course vary according to the contracted or relaxed condition of the fibre; but they otherwise seem to be tolerably uniform in different animals. The average diameter may be stated at about 1-10,000th of an inch; but it has been observed as high as 1-5000th, and as low as 1-20,000th, even when not put upon the stretch. The length of the component cells corresponds, of course, to the distance of the striæ on the entire fibre; and this also has been just shown to average about 1-10,000th of an inch.

231. The general opinion as to the disposition of the fibres during the contraction of Muscle, has been, until lately, that of Prevost and Dumas, who stated that they were thrown into a sinuous or zig-zag flexure. Recent observations, however, have fully demonstrated the incorrectness of this view; the improbability of which might have been suspected from the consideration,

Fig. 99.

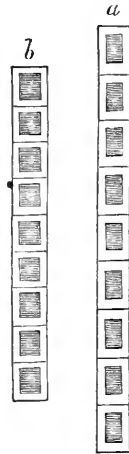

Structure of the ultimate fibrillæ of striated muscular fibre:—*a*, a fibril in a state of ordinary relaxation; *b*, a fibril in a state of partial contraction.

* This account of the ultimate structure of Muscular Fibre was first published simultaneously (March, 1846), by the Author of this Treatise, in his Manual of Physiology, and by Dr. Sharpey, in his new edition of Dr. Quain's Anatomy. Both of these statements, which were completely independent of each other, were founded upon the examination of the very beautiful preparations of Muscular Fibre, made by Mr. Lealand the Optician; who appears to have been the first to direct attention to the transverse line dividing the bright space, and to the bright border edging the dark spot. A similar delineation had previously been published, however, by Dr. Goodfellow (Physiological Journal, No. IV.); but his interpretation of the appearances was altogether different; for he considered the dark spaces as the "sarcous elements" of Mr. Bowman, and regarded them as separately inclosed within partitions formed by internal prolongations of the general investing Myolemma. By Mr. Erasmus Wilson, again, the appearances were described as leading to the belief that two kinds of cells exist in each fibrilla, a dark and a light; a pair of light cells, separated by the delicate transverse line just spoken of, being interposed between each pair of dark ones [System of Anatomy, 3d Am. Edit., p. 183]. The bright edging to the dark spots was overlooked by him. The view taken by Dr. Sharpey and the Author has the entire concurrence of several of the most eminent Microscopists in London and elsewhere; and it is confirmed by the remarkable similarity between the aspect of the Muscular fibrilla, and that of a minute *Conferva*, seen under the same magnifying power,—the cellular constitution of the latter being indubitable.

that fibres in this state of flexure could scarcely be imagined to be exerting any force of traction. Prof. Owen has noticed that, in the contracted state of the very transparent muscles of some Entozoa, each separate fibre, which may be seen with great distinctness, presents a knot or swelling in the middle, besides being generally thickened; but that it is simply shortened, without falling out of the straight line. Dr. A. Thomson remarked the same thing in the Frog; single fibres, whilst continuing in contraction, being simply shortened, without falling into zig-zag lines: and he was led to suspect, from this and other circumstances, that the zig-zag arrangement was not produced, until the act of contraction had ceased. The recent inquiries of Mr. Bowman have proved most satisfactorily, that, in the state of contraction, there is an approximation of the transverse striæ, and a general shortening of the fibre; and that its diameter is at the same time increased; but that it is never thrown out of the straight line, except when it has ceased to contract, and its two extremities are still held in proximity by the contraction of other fibres. The whole process may be distinctly seen under the Microscope, in a single fibre isolated from the rest: it is, of course, desirable to select the specimen from those animals, in which the contractility of the Muscle is retained for the longest period after death,—which is particularly the case in Reptiles among Vertebrata, and in most Invertebrata (Mr. Bowman particularly recommends the Crab and Lobster); but the change has been fully proved to differ in no essential degree, in the warm-blooded Vertebrata. The contraction usually commences at the extremities of the fibre; but it frequently occurs also at one or more intermediate points. The first appearance is a spot more opaque than the rest, caused by the approximation of a few of the dark points of some of the fibrillæ: this spot usually extends in a short time through the whole diameter of the fibre; and the shading, caused by the approximation of the transverse striæ, increases in intensity. The striæ are found to be two, three, or even four times as numerous, in the contracted, as in the uncontracted part; and are also proportionally narrower and more delicate. The line of demarcation between the contracted and uncontracted portions is well defined; but, as the process goes on, fresh striæ are absorbed (as it were) from the latter into the former. The contracted part augments in thickness; but not in a degree commensurate with its diminished length; so that its solid parts lie in smaller compass than before,—the fluid which previously intervened between them, being pressed out in bullæ under the myolemma (Fig. 100). The force with which the elements of the fibre thus tend to approximate is evidently considerable; for if the two extremities be held apart,

Fig. 100.

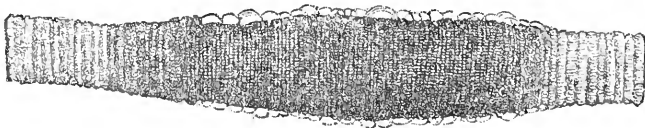

Muscular fibre of *Dytiscus*, contracted in the centre; the striæ approximated; the breadth of the fibre increased; and the sarcolemma raised in bullæ on its surface.

the fibre is not unfrequently ruptured. This corresponds with the appearances found in the muscles of persons who have died from tetanus; for in the ruptured fibres of those muscles, which have been the subjects of the spasmodic action, the striæ have been observed to approximate so closely, as to be scarcely distinguishable. When the contraction is not very decided, the dark and elevated spot appears to play like a wave along the fibre, before it involves the whole diameter in any part (Fig. 101, 2); and even when con-

siderable traction is being exercised, there is continual interchange in the elements by which it is effected,—the discs at one end of the contracted part receding from each other, whilst at the other end new discs are being received into it.

232. The foregoing description is chiefly derived from the appearances presented by muscular fibre, when spontaneously passing into that state of contraction, which is termed the *rigor mortis*; but there can be no reasonable doubt, that the phenomena of contraction, excited by the agency of the nerves, are precisely similar. Mr. Bowman has remarked, that stimuli of various kinds, directly applied to them, produce corresponding effects, although, in the case of galvanism, the change is too rapid for its steps to be followed; and that, from the appearances presented by muscles which have been affected with tetanic spasms, the contraction produced by nervous agency may be inferred to correspond in character.—It now remains, therefore, to inquire what is the cause of the zig-zag arrangement, which is often seen in the fibres. This may be easily produced, by approximating the ends of a fasciculus, after the irritability of its fibres has ceased; and it would not seem unlikely, that the passage of vessels or nerves should determine the points at which the flexures take place. Hence it appears, that the sinuous or zig-zag arrangement is that into which fibres are naturally thrown, if, on elongation following

contraction, they are not at once stretched by antagonist muscles.* Many facts support the opinion, which has long been held by several Physiologists, that, when an entire muscle is contracting, all its fasciculi are not in contraction at once; but that there is a continual interchange in the parts, by which the tension is effected; some relaxing, whilst others are shortening. When the ear is applied to a muscle in vigorous action, an exceedingly rapid faint silvery vibration is heard; which seems to be attributable to this constant movement in its substance. Now, on examining a muscle, of which some fasciculi present the zig-zag arrangement, others will be seen (if the two extremities have not been purposely approximated) to be quite straight, and in a state of contraction; and it thence appears, that the former appearance is presented by bundles of fibres, which have either not yet entered into contraction, or which have relaxed after undergoing it; but of which the extremities are still approximated, by the agency of other contracting fibres.—The result of various experiments made for the purpose, leads to the conclusion, that the total bulk of a muscle in contraction is not less than when it is in a relaxed state; or that the difference, if any exist, is extremely trifling.

233. Every Muscular Fibre, of the striated kind at least, is attached at its extremities to white fibrous tissue; through the medium of which it exerts its contractile power on the bone or other substance, which it is destined to move.

Fig. 101.

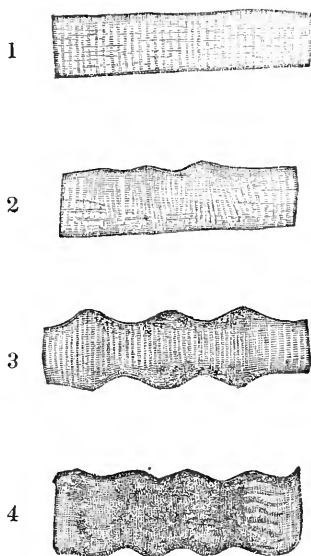

Muscular fibre of Skate, in a state of rest (1), and in three different stages of contraction (2, 3, 4).

* Mr. Bowman's conclusions have recently been confirmed by Prof. E. Weber. (Archives d'Anatomie Générale, Jan. 1846.)

The whole fasciculus of fibrillæ usually seems to end abruptly in a perfect disk; and the myolemma terminates there. The tendinous fibres are attached to the whole surface of the disk; and probably become continuous with the

Fig. 102.

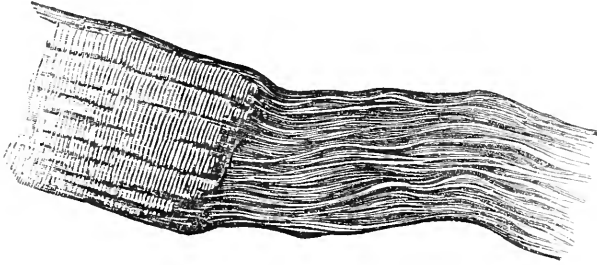

Attachment of Tendon to Muscular Fibre, in Skate.

myolemma. Thus the whole muscle is penetrated by minute fasciculi of tendinous fibres; and these collect at its extremities into a Tendon. Sometimes the muscular fibres are attached obliquely to the tendon, which forms a broad band that does not subdivide; this is seen in the legs of Insects and Crustacea, in which the muscular fibres have a *penniform* arrangement; being inserted into the tendon, on either side, like the laminæ of a feather into its stem.

234. The Muscular Fibre of Organic Life is very different from the preceding. It consists of a series of *tubes*, which do *not* present transverse

Fig. 103.

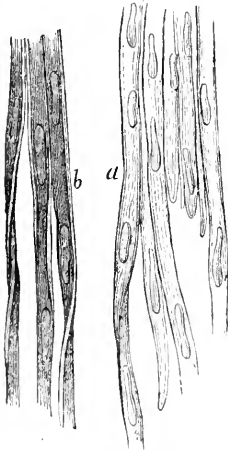

Non-striated Muscular Fibre; at *b*, in its natural state; at *a*, showing the nuclei after the action of acetic acid.

[Fig. 104.]



4. A muscular fibre of Organic Life with two of its nuclei; taken from the urinary bladder, and magnified 600 diameters; 5, muscular fibre of organic life from the stomach, magnified the same.]

striæ, and in which the longitudinal striæ are very faint; these tubes are usually much flattened, and cannot be shown to contain distinct fibrillæ.

Their size is usually much less than that of the fibres of Animal life; but, owing to the extreme variation in the flattening which they undergo, it is difficult to make a precise estimate of their dimensions. Those of the alimentary canal are stated by Dr. Baly to measure from about the 1-2500th to the 1-5600th of an inch; in the foot of the common Mussel, the Author has found them to be as much as the 1-1920th of an inch; whilst in the respiratory sac of a Phallusia (an Ascidian Mollusk), their diameter is no more than 1-8400th. They sometimes present markings, which indicate a granular arrangement in their interior; and these markings have occasionally a degree of regularity, which approaches that of the striæ on the striped Muscular fibres. They frequently present nodosities at intervals, which are the nuclei of their original component cells; and, where these nuclei are not otherwise visible, they may be brought into sight by acetic acid (Fig. 103, *a*). The plain or non-striated fibres, like those of the other muscles, are usually arranged in a parallel manner, into bands or fasciculi; but these fasciculi are generally interwoven into a net-work, not having any fixed points of attachment, but contracting against each other. It is of this kind of structure, that the muscular substance of the walls of the œsophagus, stomach, intestinal tube, bladder, and uterus, is composed; it occurs also in the bronchial tubes, in the ureters, and most of the larger gland-ducts, and in the iris. In the Heart, are found various forms of Muscular fibre; some being distinctly striated, others quite plain; and others of intermediate character. The average size of the fibres is less than that of the fibre, of which the voluntary muscles are composed; and the fasciculi, instead of being straight and parallel, are considerably interlaced. This intermediate character accords well, as we shall hereafter see, with the actions of the organ; which correspond in their energy and rapidity, with the contractions of voluntary muscles; whilst they agree with those of the non-striated kind, in being but little influenced by the nervous system. The middle coat of the Arteries contains a contractile tissue, very similar to that of unstriped muscle; and fibres of a similar nature are interwoven with other fibrous tissues in the Skin, and especially in the Dartos,—giving rise in the former to the state termed *cutis anserina*, under the influence of cold or of depressing emotions; and in the latter to the wrinkling of the scrotum. There are certain points, at which the one system of fibres comes into close connection with the other. This is the case, for example, in the œsophagus; the upper part of which contains striated fibres, and is thrown into contraction by nerves; whilst the muscular wall of the lower part seems entirely composed of non-striated fibres, and acts for the most part independently of the nerves. The point of transition varies in different animals (§ 386); and seems not to be constant among individuals of the human species.

235. The Myolemma of the Muscular Fibre appears to be the part first formed; being distinctly visible long before any traces of fibrillæ can be observed in it. This tube seems to take its origin, like the ducts of Plants, in cells laid end to end, the cavities of which coalesce, by the disappearance of the partitions, at a subsequent period; and the nuclei of these original cells may be distinctly seen, for some time after the appearance of the striæ, which indicate the formation of the fibrillæ in their interior. In an early stage of the development of the fibres, indeed, these bodies project considerably from their sides: in this respect, as well as in others, there is a close correspondence between the *temporary* character of the Muscular fibre of Animal life, and the *permanent* condition of that of Organic life. In the fully formed muscle of Animal life, they are not perceptible, except when a peculiar method has been adopted for bringing them into view. This method consists in treating the fibre with weak acids, which render the nuclei more opaque, whilst the surrounding structure becomes more transparent. They are usually

numerous in proportion to the size of the fibre. There is every probability that these nuclei continue to act, like the "germinal spots" of the glandular

Fig. 105.

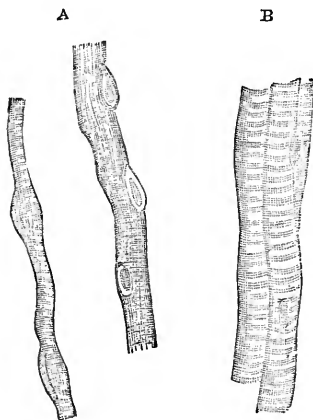

Muscular fibres from fetal pectoralis; A, from Calf at two months; B, from human fetus of nine months.

Fig. 106.

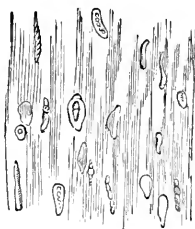

Mass of ultimate fibres from the pectoralis major of the human fetus, at nine months. These fibres have been immersed in a solution of tartaric acid; and their "numerous corpuscles, turned in various directions, some presenting nuclei," are shown.

follicles or parent-cells, as centres of nutrition; from which the minute secondary cells, that compose the fibrillæ, are developed as they are required. The diameter of the Muscular fibre of the fetus is not above one-third of that which it possesses in the adult; and as the *size* of their ultimate particles is the same in both cases, their *number* must be greatly multiplied during the growth of the structure. But we shall find reason to believe, that a decay is continually taking place in the component cells, with a rapidity proportional to the functional activity of the Muscle, and their generation, which occurs as constantly when the nutrient operations proceed in their regular course, is probably accomplished by a development from these centres, at the expense of the blood, with which the muscle is copiously supplied.

236. From the preceding history it appears, that there is no difference, at an early stage of development between the striated and non-striated forms of Muscular fibre. Both are simple tubes, containing a granular matter, in which no definite arrangement can be traced, and presenting enlargements occasioned by the presence of the nuclei. But whilst the striated fibre goes on in its development, until the fibrillæ, with their alternation of light and dark spaces, are fully produced, the non-striated fibre retains throughout life its original embryonic character.

237. Notwithstanding the energy of growth in Muscular Fibre, and the constant interstitial change which seems to take place in its contents, it is doubtful if it is ever regenerated, when there has been actual loss of substance. Wounds of muscles are united by Areolar tissue, which gradually becomes condensed; but its fibres never acquire any degree of contractility.

238. The Chemical Composition of Muscular Fibre seems to be very uniform, from whatever source it is obtained. It is impossible, however, to determine it with precision; on account of the difficulty of completely isolating the substance of the fibres from the areolar tissue, vessels, and nerves, that are blended with them. The proper muscular substance differs from the simple fibrous tissues, in not being resolvable into gelatine by the prolonged action of boiling water; and in being soluble in acetic acid, from which it is

precipitated by ferrocyanide of potassium, showing that it belongs to the proteine-compounds. The following analyses of Muscle by Berzelius corresponds very exactly with those since made by Braconnot, Schultz, Marchand, and other Chemists :

Fibrine (from the proper muscular substance)	15.80
Gelatine (from areolar tissues)	1.90
Albumen and hæmatine	2.20
Phosphate of lime, with albumen08
Alcoholic extract, with salts (lactates?)	1.80*
Watery extract, with salts	1.05
Water, and loss	77.17
	100.00

Thus something less than 23 per cent. of solid matter exists in ordinary meat; and in 100 parts of this solid matter, there are about $7\frac{1}{2}$ parts of fixed salts.

[*Kreatine* (from κρεατ, flesh), originally discovered by Chevreul, in 1835, has been proved by the recent investigations of Liebig to be a constant ingredient of the muscles of all the higher classes of animals. Schlossberger found it in the flesh of the alligator. Its crystals are colorless, perfectly transparent, and of great lustre. They form groups, the character of which is exactly similar to that of sugar of lead. Its formula is $C_8 N_3 H_{11} O_6$. It dissolves easily in boiling water, and a solution saturated at 212° forms on cooling a mass of small brilliant crystals, and is nearly insoluble in cold alcohol. It is neither acid nor basic. From the action of strong mineral acids, a new body of totally different chemical qualities, a true organic alkali is formed, which Liebig has called *Kreatinine*. It is easily obtained from the hydrochlorate or the sulphate. Kreatinine is more soluble both in cold and hot water than kreatine; it dissolves in boiling alcohol, and crystallizes on cooling. In its chemical character it is analogous to ammonia.—Its formula is $C_8 N_3 H_7 O_2$.—*Researches on the Chemistry of Food*, by J. Liebig.—London, 1847.—M. C.]

a. The exact correspondence in ultimate composition, between dried Muscle, and dried Blood, according to the analyses of Playfair and Böckmann, is not a little remarkable. The following are their results.

	PLAYFAIR.		BÖCKMANN.	
	Muscle.	Blood.	Muscle.	Blood.
Carbon	51.83	51.95	51.89	51.96
Hydrogen	7.57	7.17	7.59	7.33
Nitrogen	15.01	15.07	15.05	15.08
Oxygen	21.36	21.39	21.24	21.21
Ashes	4.23	4.42	4.23	4.42

It may be questioned, from these results, whether the amount of Hæmatine in Muscle is not greater than that which is represented by the previous analysis; since a tissue composed of Fibrine and Albumen alone, could not possess the same ultimate composition with one, in which Hæmatine is present in large proportion.

b. Some very interesting researches have lately been made by Helmholtz,† on the changes induced in the tissue by Muscular action. Powerful contractions were induced by electricity in the amputated leg of a Frog; and were kept up as long as the irritability was retained. The flesh of the two limbs was then analyzed; and it was found that, in every instance the water-extractive was diminished in the electrized muscle, to the extent of from 20 to 24 per cent.; whilst the alcoholic extract was increased to about the same amount.—Similar results were obtained from experiments on warm-blooded animals; the amount of change, however, being less, on account of the shorter duration of their muscular irritability.

239. Muscular tissue, properly so called, is as extra-vascular as cartilage or dentine; for its fibres are not penetrated by vessels; and the nutriment required for the growth of its contained matter must be drawn by absorption through the myolemma. But the substance of Muscle, as a whole, is ex-

* [The recent researches of Liebig make it exceedingly probable that lactic acid is a constituent of muscle. Its purpose in the animal organism will be alluded to hereafter.—M. C.]

† Müller's Archiv, 1845.

tremely vascular, the capillary vessels being distributed in parallel lines, united by transverse branches, in the minute inter-spaces between the fibres (Fig. 107); so that it is probable that there is no fibre, which is not in close relation with a capillary.

Fig. 107.

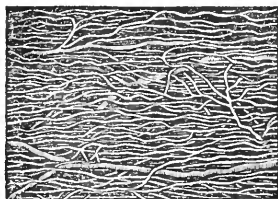

Capillary net-work of Muscle.

The number of blood-vessels in a given space will of course be greater, where the fibres and the capillaries are both small, as in Mammals and Birds, than where they are of larger diameter, as in Reptiles and Fishes; and the former condition will obviously be the one most favourable to the performance of active changes between the blood and the muscle. These changes consist, it would appear, not merely in the nutrition of the tissue; but in the supply of oxygen, which is a necessary condition of the excitement of its activity. We shall hereafter see, indeed, that every muscular contraction probably involves the disintegration of a certain amount of its substance, through the union of oxygen, supplied by arterial blood, with its elements; and that the great demand for nutrition, which is occasioned by muscular activity, is for the purpose of repairing this loss. The muscles of warm-blooded animals speedily lose their irritability, after the supply of arterial blood has been suspended, either through the cessation of the general circulation, or by deficient aeration of the fluid. But the muscles of cold-blooded animals, which are very inferior in the energy and rapidity of their action, preserve their properties for a much longer period, after the deprivation of their supply of arterial blood; in accordance with the general principle, that, the lower the usual amount of vital energy, the longer is its persistence, after the withdrawal of the conditions on which it is dependent. The very indisposition to a change of composition, on which the less ready action depends, produces a longer retention of the power of acting.

240. The Muscles of Animal life are, of all the tissues except the skin, those most copiously supplied with Nerves. These, like the blood-vessels, lie on the outside of the Myolemma of the several fibres; and their influence must consequently be excited through it. The general arrangement of these nerves is shown in Fig. 108. Their ultimate fibres or tubes cannot be said

Fig. 108.

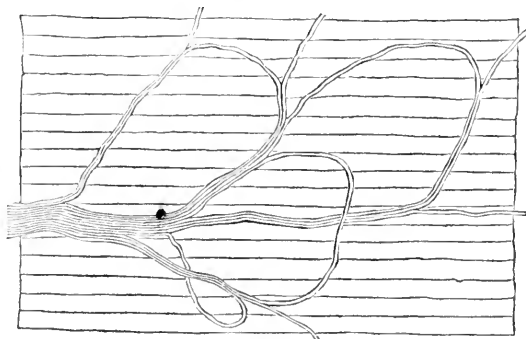

Form of the terminating loops of the nerves in the muscles.

to *terminate* anywhere in the Muscular substance; for after issuing from the trunks, they form a series of loops, which return either to the same trunk, or

to an adjacent one. The occasional appearance of a termination to a nervous fibril is caused by its dipping down between the muscular fibres, to pass towards another stratum. The nerves are almost exclusively of the motor kind; but a few sensory are blended with them. We see this most clearly in cases in which the motor and sensory trunks supplying the muscles are distinct; as in the muscles of the orbit.—The non-striated muscles are very sparingly supplied with nerves; and these are derived (for the most part, if not entirely), from the Sympathetic system, rather than from the Cerebro-Spinal.

241. We have, lastly, to consider the structure, composition, actions, and mode of growth and regeneration of the *Nervous Tissue*; the one which is most distinctive of the Animal fabric, and which serves as the instrument of the operations that are most peculiar to it. Wherever a distinct Nervous System can be made out (which has not yet been found possible in the lowest of those beings, that, from their general structure and habits of life, are unquestionably to be ranked in the Animal Kingdom), it consists of two very different forms of structure; the presence of both of which, therefore, is essential to our idea of it as a whole. We observe, in the first place, that it is formed of *trunks*, which are distributed to different parts of the body, and especially to the muscles and to the sensory surfaces; and of *ganglia*, or masses with which the central terminations of those trunks come into connexion. It is easily established by experiment, that the trunks themselves have no power of originating changes; and that they only serve to conduct or convey the influence of operations which take place at their central or peripheral extremities. For if a trunk be divided in any part of its course, all the parts to which the portion thus cast off from the ganglion is distributed, are completely paralyzed; that is, no impression made upon them is felt as a sensation; and no motion can be excited in them by any act of the mind. Or, if the substance of the ganglion be destroyed, all the parts which are exclusively supplied by nervous trunks proceeding from it, are in like manner paralyzed.—But if,

Fig. 109.

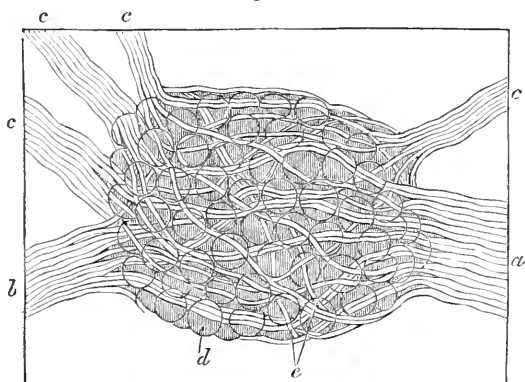

Dorsal ganglion of Sympathetic nerve of Mouse; *a, b*, cords of connection with adjacent sympathetic ganglia; *c, c, c, c*, branches to the viscera and spinal nerves; *d*, ganglionic globules or cells; *e*, nervous fibres traversing the ganglion.

when a trunk is divided, the portion still connected with the ganglion be pinched or otherwise irritated, sensations are felt which are referred to the points supplied by the separated portion of the trunk; which shows that the part remaining in connexion with the ganglion is still capable of conveying impres-

sions, and that the ganglion itself receives these impressions, and makes them felt as sensations. On the other hand, if the separated portion of the trunk be irritated, motions are excited in the muscles which it supplies; showing that it is still capable of conveying the motor influence, though cut off from the usual source of that influence.

242. In the ordinary Nerve-trunks, we find only one form of Nervous tissue;—that which may be designated as the *fibrous* or *tubular*. In the Ganglia, we find, in addition to this, a substance made up of peculiar cells or vesicles; which may be distinguished as the *vesicular* nervous matter. In fact, the character of a Ganglionic centre (which is frequently not otherwise clearly distinguished as such) is derived from the presence of this vesicular substance.

243. The ultimate Nerve-fibre, in its most complete form,—such as is presented to us in the ordinary spinal nerves,—is distinctly tubular; being composed of an external cylindrical membranous sheath, within which the peculiar nervous matter is contained. This membranous tube, like the Myolemma of muscular fibre, is extremely delicate and transparent; and is nearly or quite

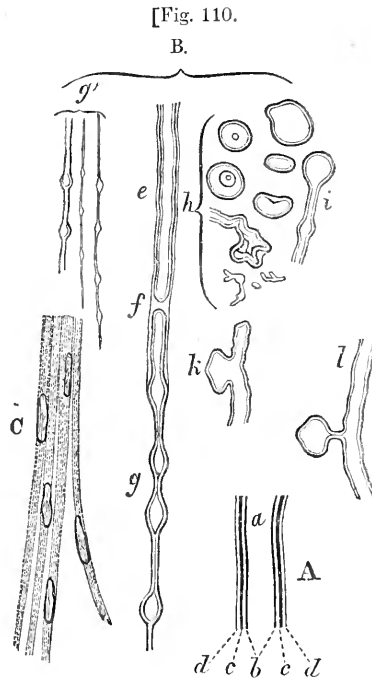

A. Diagram of tubular fibre of a spinal nerve;—*a*. Axis cylinder. *b*. Inner border of tubular membrane. *b*. Tubular fibres; *e*. in a natural state, showing the parts as in A. *f*. The white substance and axis cylinder interrupted by pressure, while the tubular membrane remains. *g*. The same, with varicosities. *h*. Various appearances of the tubular fibre, with the white substance closed over it. *i*. Broken end of a tubular fibre, with the white substance closed over it. *k*. Lateral bulging of white substance and axis cylinder, from pressure. *l*. The same more complete. *g'*. Varicose fibres of various sizes, from the cerebellum. *c*. Gelatinous fibres from the solar plexus, treated with acetic acid, to exhibit their cell-nuclei. *B* and *c* magnified 320 diameters.]

homogeneous. It is not penetrated by blood-vessels; nor is it ever seen to branch or anastomose with others; so that there is reason to regard it as form-

ing one continuous sheath, that isolates the contained matter from the surrounding tissue, along the whole course of the nerve-trunk, from its central to its peripheral extremity. When the nerve-fibres are examined in a very fresh state, their contents appear pellucid and homogeneous, and of a fluid consistence; so that each tube or fibre looks like a cylinder of clear glass, with simple, well-defined, dark edges. But a kind of coagulation soon takes place in the contained substance, making it easily distinguishable from the tube itself; for the latter is then marked by a *double* line, as shown in Fig. 111, A. The substance which is in immediate contact with the inner wall of the nerve-tube, is more opaque than that which occupies its centre, and of a different refracting power; and thus it forms a hollow cylinder, which surrounds the latter, and which is known under the name of the *White substance of Schwann*. The centre or axis of the tube is occupied by a substance that preserves its transparency; and this is the *axis-cylinder of Rosenthal and Purkinje*. It may be surmised that the *White substance of Schwann*, which exhibits much variety in thickness in different parts of the nervous system, chiefly serves, like the membranous investment, to isolate the interior matter; which last seems to be the essential constituent of the nervous fibre. The whole of the matter contained in the tubular sheath is extremely soft; yielding to very slight pressure, and readily escaping from the cut extremities of the tubes. The tubular sheath itself varies in density in different parts; being stronger in the nervous trunks than in the substance of the brain and spinal cord. In the former, it is not difficult to show that the regular form of the nerve-tube is a perfect cylinder; though a little disturbance will cause an alteration in this,—a small excess of pressure in one part forcing the contents of the tube towards another portion,

Fig. 111.

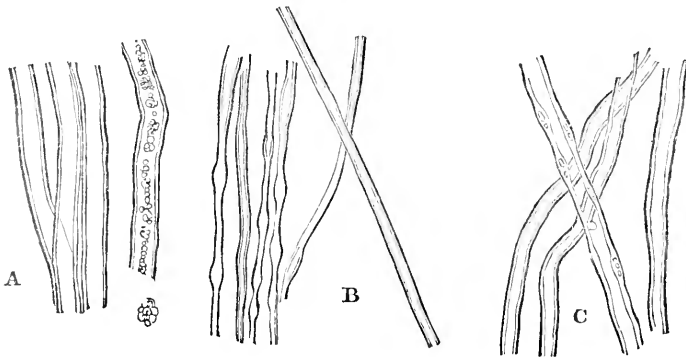

Structure of nerve-tubes, magnified 350 diameters. A, Cylindrical tubuli from nerve. B, Varicose tubuli from brain. C, Nerve-tubes, of which one exhibits the remains of nuclei in its walls.

where they are more free to distend it, and thus producing a swelling. The greater delicacy of the tubular sheath in the latter, causes this result to take place with yet more readiness; so that a very little manipulation exercised upon the fibres of the Brain or Spinal Cord, or on those of special sense, occasions them to assume a *varicose* or beaded appearance (Fig. 111, B), which, when first observed by Ehrenberg, was thought to be characteristic of them. When the fibres of these parts are examined, however, without any such preparation, they are found to be as cylindrical as the others.—The diameter of the tubular fibres of the cerebro-spinal nerve-trunks in Man, usually varies from about 1-2000th to 1-4000th of an inch, being sometimes as great, however, as 1-1500th of an inch; and sometimes much below the least of the above

dimensions. The fibres decrease in size as they approach the brain, either directly, or through the medium of the spinal cord; and in the brain itself they continue to diminish, as they pass through the medullary towards the cortical portion; so that they are very commonly found of no more than 1-7000th or 1-8000th of an inch in diameter, and sometimes as little as 1-14,000th. Like most other elementary structures, they are of considerably larger dimensions in Reptiles and Fishes; varying, according to Dr. Todd, from 1-1260th to 1-2280th of an inch in the Frog; being in the Eel as much as the 1-1040th of an inch; and in the optic nerve of the Cod, no less than 1-650th of an inch in diameter.*

244. Besides these proper *tubular* nerve-fibres,—of which, in combination with areolar and fibrous tissue, blood-vessels, &c., a large proportion of the cerebro-spinal nerve-trunks are made up,—there are certain other fibres, which are peculiarly abundant in the trunks of the Sympathetic system, and which are of different character from the preceding. They are chiefly distinguished by their small size, their diameter not being above half or one-third of that of the ordinary nervous tubuli. They are destitute of the *double* contour, which has been shown to result in the preceding case from the presence of two distinct substances within the tubular investment; and their contents appear to be homogeneous. And when they are aggregated in bundles, they possess a yellowish-grey colour.—Although these fine fibres exist in greater proportion in the Sympathetic system than in the Cerebro-spinal, yet they are present in great numbers in some of the nerves of the latter; and it is even question-

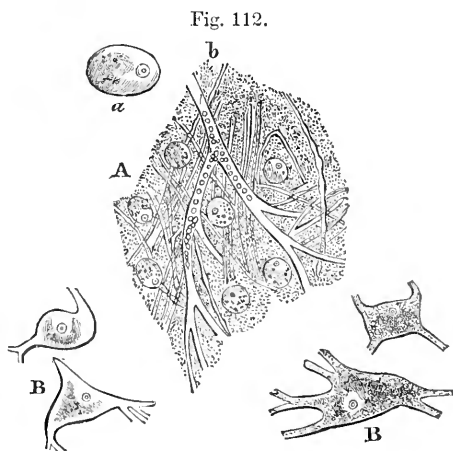

Primitive fibres and ganglionic vesicles of human brain, after Purkinje. A, ganglionic vesicles lying amongst nerve-tubes and blood-vessels, in substance of optic thalamus; a, vesicle more enlarged; b, vascular trunk. B, B, vesicles with variously-formed processes, from dark portion of crus cerebri. Magnified 350 diameters.

able, whether they may not be continuous with the ordinary tubular fibres. They may be traced into the ganglia of the Sympathetic, into the ganglia on the posterior roots of the Spinal nerves, and even to the ganglionic matter of the Brain and Spinal Cord.†

* Cyclopædia of Anatomy and Physiology, Vol. 111., p. 593.

† Much controversy has recently taken place in Germany, regarding the existence of a set of fibres peculiar to the Sympathetic system. The *grey* or *gelatinous* fibres, described by Remak, and (following him) by Müller and others, as essentially constituting the Organic system of Nerves, are now generally admitted not to be entitled to the designation of nerve-

245. The second primary element of the Nervous system, without which the fibrous portion would seem to be totally inoperative, is composed of nucleated cells, consisting of a finely granular substance, and lying somewhat loosely in the midst of a minute plexus of blood-vessels. Their original form may be regarded as globular; whence they have been called ganglion-globules. This, however, is liable to alteration; sometimes, perhaps, from external compression; but more commonly through their own irregular mode of growth. They frequently extend themselves into long processes, which may give them (according to the number thus projecting) a caudate or a stellate aspect, resembling that of the pigment-cells of the Batrachia. These processes are composed of a finely-granular substance, resembling that of the interior of the vesicle, with which they seem to be distinctly continuous. They are very liable to break off near the vesicle; but if traced to a distance, they are found

to divide and subdivide, and at last to give off some extremely fine transparent fibres; some of which seem to interlace with those of other stellate cells, whilst others become continuous with the axis-cylinders of the nerve-tubes. Such vesicles have been seen alike in the ganglionic masses of the Cerebro-spinal, and in those of the Sympathetic system.* Besides the finely-granular substance just mentioned, these cells usually contain a collection of pigment-granules, which especially cluster round the nuclei, and give them a reddish or yellowish-brown colour. This pigment seems to have some resemblance to the hæmatine of the blood; and it is usually, if not invariably, deficient among the Invertebrata, as well as less abundant in Reptiles and Fishes. The vesicles are sometimes covered with a layer of a soft granular substance, which adheres closely to their exterior and to their processes; this is the case in the outer part of the cortical substance of the human brain. In other instances, each cell is inclosed in a distinct envelope composed of smaller cells, closely adherent to each other, and to the contained cell; such an arrangement is common in the smaller ganglia, and in the inner portion of the cortical substance of the brain.—The diameter of the vesicles is extremely variable, owing to the changes of form above described; that of the globular ones is usually between 1-300th and 1-1250th of an inch.

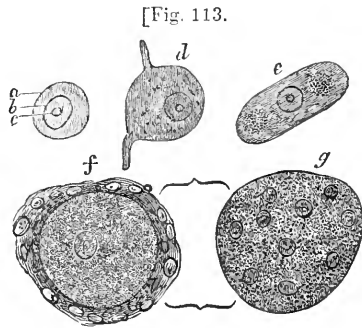

[Fig. 113.]
Nerve-vesicles from the Gasserian ganglion of the human subject:—*a*. A globular one with defined border; *b*, its nucleus; *c*, its nucleolus. *d*. Caudate vesicle. *e*. Elongated vesicle, with two groups of pigment particles. *f*. Vesicle surrounded by its sheath, or capsule, of nucleated particles. *g*. The same, the sheath only being in focus.—Magnified 300 diameters.]

246. In the central or ganglionic masses of the Nervous system, we find these vesicles aggregated together, and imbedded in a finely-granular matter; the whole being traversed by a minute plexus of capillary blood-vessels. The entire substance, made up of these distinct elements, is commonly known as the *cineritious* or *cortical* substance; being distinguished by its colour, in

fibres, but to be a form of simple fibrous tissue. The peculiar fibres described above, were first pointed out by Bidder and Volkmann; whose statements in regard to them have recently been confirmed by the laborious and impartial researches of Kölliker. (See his work "Die Selbständigkeit und Abhängigkeit des Sympathischen Nervensystems," 1844; and the abstract of his results in Mr. Paget's able Report, in Brit. and For. Med. Review, July, 1846, p. 271.)

* See Todd and Bowman's Physiological Anatomy, Vol. i., p. 214. See also Kölliker, *loc. cit.*; and Dr. Radclyffe Hall, in Edinburgh Med. & Surg. Journal, April, 1846.

[Fig. 114.

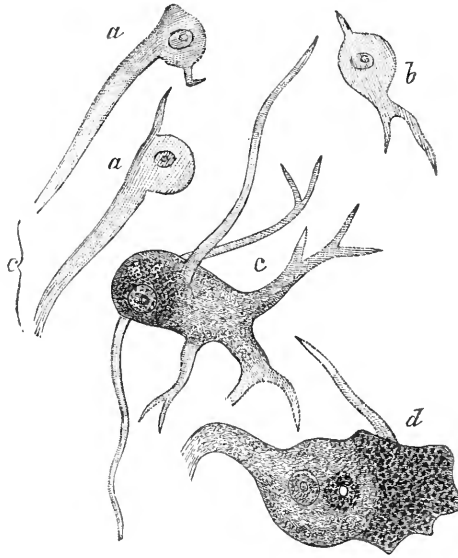

Ganglion globules, with their processes, nuclei, and nucleoli:—*a. a.* From the deeper part of the gray matter of the convolutions of the cerebellum. The larger processes are directed towards the surface of the organ. *b.* Another from the cerebellum. *c. d.* Others from the post. horn of gray matter of the dorsal region of the cord. These contain pigment, which surrounds the nucleus in *c.* In all these specimens the processes are more or less broken.—Magnified 200 diameters.]

Man and the higher animals at least, from the white substance composed of nerve-tubes, of which the trunks of the nerves, as well as a large part of the brain and spinal cord, are made up; and occupying in the brain a position external to the latter, which is often termed the medullary substance. This position, however, is quite an exceptional one; for in the spinal cord and in the scattered ganglia of Vertebrated animals, and in all the ganglionic centres of Invertebrata,—everywhere, in fact, except in the Brain,—the vesicular nerve substance occupies the centres of the ganglia; consequently the terms cortical and medullary, as applied to the vesicular and tubular substances respectively, are quite inappropriate. Nor are the designations that have reference to their colour, much more uniformly correct: for, as we have seen, the vesicular substance may be destitute of internal pigment-granules, and the blood in its capillary plexus may be pale or colourless, so that the reddish-grey hue, which is expressed by the term cineritious, may be entirely wanting; whilst, on the other hand, we have seen that certain of the nerve-fibres, making up what is commonly termed the white substance, are of a grey colour. Hence the only valid distinction between these two kinds of nervous matter, is that which has reference to their constitution;—as consisting of cells or vesicles on the one hand; or of tubes or fibres, on the other.

[Fig. 115.

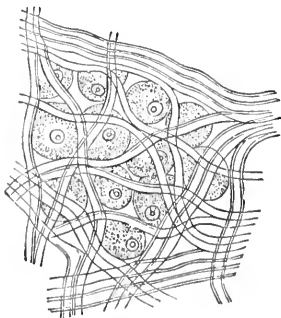

A small piece of the otic ganglion of the sheep, slightly compressed; showing the interlacement of the internal fibres, and the vesicular matter.—(After Valentin.)]

247. The connection between the fibrous and

vesicular nervous elements, in the nervous centres, has not yet been thoroughly elucidated. It seems certain, on the one hand, that *some* of the

[Fig. 116.

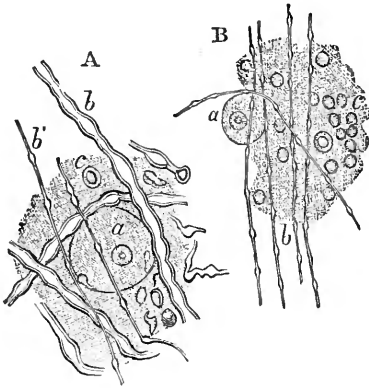

A. Blending of the vesicular and fibrous nervous matter in the dentate body of the cerebellum:—*a*, Ganglion globule, with its nucleus and nucleolus. *b*, Nerve-tube, slightly varicose, in close contact with the ganglion globule. *b'*, Smaller nerve-tubes. These parts all lie in a finely granular matrix interspersed with nuclei, *c*. B. Vesicular and fibrous matter of the laminae of the cerebellum. *a*, Ganglion globule. *b*, Very minute nerve-tubes traversing a finely granular matrix, in which are numerous rounded nuclei, *c*.]

[Fig. 117.

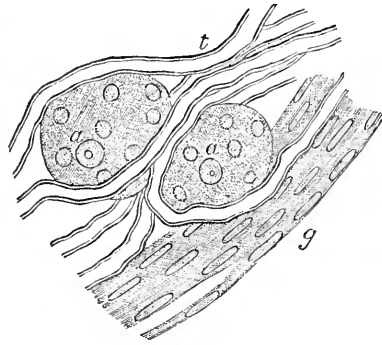

From the Gasserian ganglion of an adult:—*a*, *a*, Ganglion globules with their nucleus, nucleated capsule, and pigment. *t*, Tubular fibres, running among the globules in contact with their capsule. *g*, Gelatinous fibres also in contact with the ganglion globules.—Magnified 320 diameters.]

fibres come into direct continuity with caudate prolongations of the ganglionic corpuscles, and may thus be said to originate from them. This appears to

Fig. 118.

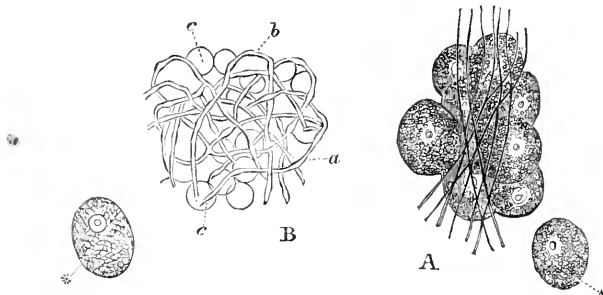

Primitive fibres and ganglionic vesicles. A, from sympathetic ganglion; * a separate vesicle, showing its pellucid nucleus and nucleolus. B, from grey substance of human cerebellum; *a*, *b*, plexus of primitive fibres; *c*, nucleated globules; * a separate globule from human Gasserian ganglion. Magnified 350 diameters.

be especially the case, with regard to the class of *fine* fibres (§ 244). On the

other hand, it seems equally certain that there are many nerve-tubes which simply enter the ganglionic masses, pass round and amongst the cells, and then emerge from them, without having undergone any distinct change, save that they present a soft and varicose appearance, whilst threading their way through the cells. And it is equally certain that there are many ganglionic corpuscles, which never acquire the caudate prolongations, and which appear specially destined to act upon this class of nerve fibres.—Some observations which have been made upon the nervous system of fœtuses, in which the brain and spinal cord were wanting, present a remarkable confirmation of this view.* The nervous cords were for the most part developed; and at their (so called) origins or central extremities, they were found to hang as loose threads in the cavities of the cranium and spine. On examining these threads, it was found that the nerve-tubes, of which they consisted, formed distinct loops; each of which was composed of a fibre that entered the cavity, and then returned from it. These loops were imbedded in granular matter, resembling that interposed between the vesicles in the cortical substance of the brain; and perhaps to be regarded as vesicular matter in an early stage of its formation. All that is known of the laws regulating the formation of such irregular productions, leads to the belief, that we may rightly consider this arrangement of the nerve-tubes as one which exists in the nervous centres, when they are normally developed. But it may not be the *only* one; for, as already pointed out, some of the nerve-fibres appear to originate from the filamentous prolongations of certain ganglionic cells. Additional information is much needed upon this point.

248. The arrangement of the nerve-fibres, at their peripheral extremities, seems to be essentially of the same character. It has been already shown that the motor fibres, which are distributed to the muscles, have no proper terminations; a series of loops, returning into themselves or joining others, being formed by the ultimate ramifications of the main trunks. The arrangement of the sensory fibres seems to be usually of the same nature. The principal trunks subdivide into numerous anastomosing branches, forming a sort of plexus in the substance of the skin; and from this, single filaments detach themselves at intervals, rising up into the papillary elevations of its surface, and then returning again into the plexus, after making a series of

Fig. 119.

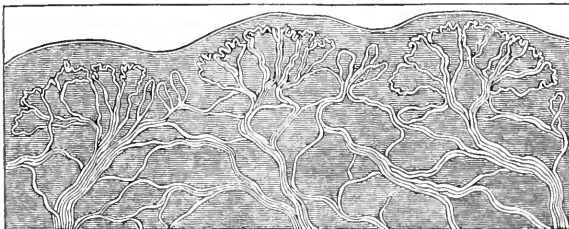

Distribution of the tactile nerves at the extremity of the human thumb, as seen in a thin perpendicular section of the skin.

loops, in which a sort of varicose enlargement of the fibre may often be noticed. Similar looped terminations have been traced in the nerves supply-

* Dr. Lonsdale, in *Edinb. Med. and Surg. Journal*, No. *CLVII.*; and Mr. Paget in *Brit. and For. Med. Rev.*, No. *XLIII.* p. 273.

ing the dental sacculi, in the expansions of the auditory nerve distributed upon the delicate membrane lining the cavities of the internal ear, and elsewhere. It would yet, however, be premature to say, that this arrangement is universal.—The peripheral extremities may be really considered as the *origins* of the sensory nerves; since it is in them that those changes are effected which it is the office of the trunks to conduct towards the centres; and it may be reasonably inquired, whether anything like the vesicular substance of the ganglia can be detected in them. In examining the *retina* microscopically, it is found to be almost entirely made up of a layer of ganglionic cells, very closely resembling those of the grey matter of the brain; and these are in apposition with the vascular layer; so that we have here precisely the same provision for exciting a change, that is to be conducted towards the centres, as we have in the brain for exciting a change, whose influence is to be conveyed towards the periphery. Something of the same kind has been seen in connection with the corresponding expansions of the olfactive and auditory nerves; and it is probable that similar elements exist in the papillæ

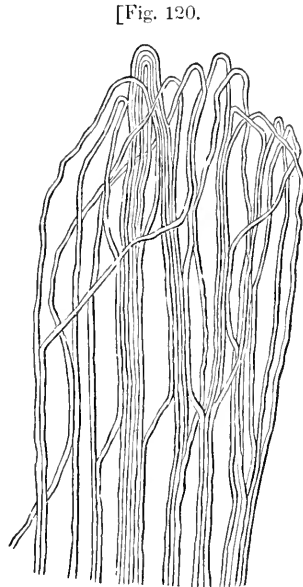

[Fig. 120.]

Terminal nerves on the sac of the second molar tooth of the lower jaw in the sheep, showing the arrangement in loops.—(After Valentin.)]

of taste and touch are distributed. In these papillæ we find loops of capillary vessels in close contiguity with the extremities of the nerve-tubes.—Hence we may state it as a general fact, that wherever a change is to be *originated*, we find some form of Vesicular matter, with capillary blood-vessels; whilst for the *conduction* of such a change to distant parts, the Fibrous structure is alone required.

249. The Chemical constitution of the Nervous matter is peculiar; and an acquaintance with its general features is of importance, in leading us to recognize in the excretions the results of its decomposition.

a. The following, according to L'Heritier, is the relative proportion of the different constituents in individuals of different classes:—

	Infants.	Youths.	Adults.	Aged Persons.	Idiots.
Water	82.79	74.26	72.51	73.85	70.93
Albumen	7.00	10.20	9.40	8.65	8.40
Fat	3.45	5.30	6.10	4.32	5.00
Osmazome (?) and Salts	5.96	8.59	10.19	12.18	14.82
Phosphorus	0.80	1.65	1.80	1.00	0.85

It appears from the researches of M. Fremy, that the Phosphorus is combined with part of the fatty matter; and forms with it two peculiar fatty acids, termed by him the Cerebic and Oleophosphoric.—Cerebic acid, when purified, is white, and presents itself in crystalline grains. It contains a small proportion of Phosphorus; and differs from the ordinary fatty matter, in being partly composed of Nitrogen. It consists of 66.7 per cent. of Carbon, 10.6 of Hydrogen, 2.3 of Nitrogen, 19.5 of Oxygen, and 0.9 of Phosphorus; and thus differs from ordinary fat, not only in containing Phosphorus and Nitrogen, but in possessing more than twice their proportion of Oxygen.*—Oleophosphoric acid is separated from the former by its

* It is probable that, in the above analysis of L'Heritier, the Cerebic acid, which is not soluble in ether, is included under the head of Osmazome; for the analyses of Demis and

solubility in ether: it is of a viscid consistence; but when boiled for a long time in water or alcohol, it gradually loses its viscidness, and resolves itself into a fluid oil, which is pure Oleine, whilst phosphoric acid remains in the liquor. The proportion of Phosphorus which this oil contains is about 2 per cent.—Cholesterine has also been extracted from the brain by M. Fremy in considerable quantity.—The proportion of Fixed Salts is small; not being above $3\frac{1}{2}$ parts in 100 of Dry Cerebral matter; which is less than half the proportion that exists in Muscle.—According to Lassaigne, the chemical composition of the Cortical and Medullary substances of the brain is essentially different; the former containing 85 per cent. of water, whilst the latter has only 73; the cortical substance having also 3.7 per cent. of a red fatty matter, of which the medullary has scarcely any; and being almost entirely destitute of the white fatty matter, which exists in large proportion in the latter.

The Albuminous matter in the above analyses, is probably that of which the *walls* of the nerve-cells and nerve-tubes, and of the capillary blood-vessels are composed. The *contents* of these cells and tubes are represented chiefly, if not entirely, by the phosphorized fats; and there are many reasons for regarding these as the active agents in the operations of the Nervous system. It will be remarked, that the amount of phosphorus is the greatest at the period of greatest mental vigour; and that in infancy, old age, and idiocy, the proportion is not above half that which is present during the adolescent and adult periods.

250. The Nervous System is very copiously supplied with blood-vessels; the arrangement of which varies according to the form of the elementary parts, in which they are distributed. Thus in the Vesicular substance of the nervous centres, the capillaries form a minute net-work, in the interstices of which the ganglionic cells are included. In the tubulo-fibrous substance, the capillaries are distributed much on the same plan as in Muscular tissue; the network being composed of straight vessels, which run along the course of the fibres, passing between the nerve-tubes, and which are connected at intervals by transverse branches. And at the sensory extremities of the

Fig. 121.

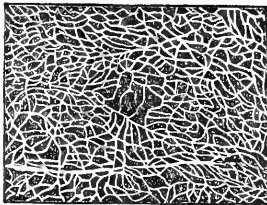

Capillary net-work of Nervous Centres.

Fig. 122.

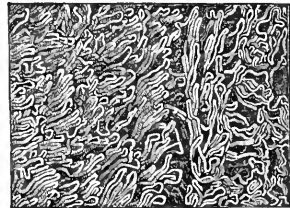

Distribution of Capillaries at the surface of the skin of the finger.

nerves we find loops of Capillaries arching over their terminal and probably looped filaments.—The Brain of Man, taken *en masse*, has been estimated to receive one-sixth of the whole amount of blood, although its weight is not usually more than a-fortieth part of that of the entire body. Whether or not this estimate be precisely correct, there can be no doubt that it receives far more blood, than any other part containing the same amount of solid matter. Now this copious supply of blood evidently has reference to two distinct objects; first, to supply the necessary conditions for the *action* of the Nervous system; and, secondly, to maintain its *nutrition*. Many circumstances lead to the conclusion that, in the Nervous as in the Muscular system, every vital operation is necessarily connected with a certain change of composition, so

other chemists give a much higher proportion to the phosphorized fat, and a much smaller one to the ill-defined compounds represented by the designation Osmazome.

that no manifestation of nervous power can take place, unless this change can be effected. There is strong reason to believe, further, that this change essentially consists in the union of oxygen conveyed by the arterial blood, with the elements of the proper nervous matter; and that this union consequently involves the death and disintegration of a certain amount of the nervous tissue,—the reproduction of which will be requisite, in order that the system may be maintained in a state fit for action. This reproduction is effected by the nutritive process, which takes place at the expense of other constituents of the blood; and it will proceed most vigorously in the intervals, when the active powers of the nervous system are not being called into operation (§§ 292—296).

251. The proofs of this continual waste and reproduction of the Nervous substance, will be partly found in the appearance of the products of its decomposition in the excretions, and in the demand which is set up for the materials for its reparation; these being found to accord in amount, as will be shown hereafter, with the degree of its functional activity. But evidence of another kind may be drawn from the microscopic appearances observable in the cortical substance of the Brain. It seems probable, from the observations of Henle, that there is as continual a succession of nerve-cells, as there is of epidermic cells; their development commencing at the surface, where they are most copiously supplied with blood-vessels from the pia mater; and proceeding as they are carried towards the inner layers, where they come into more immediate relation with the tubular portion of the nervous tissue. This change of place is probably due to the continual death and disintegration of the mature cells, where they are connected with the fibres, and the equally rapid production of new generations at the external surface;—the newly-formed epidermic cells being thus carried inwards, in precisely the same manner that the epidermic cells are carried outwards.

252. The first *development* of the *Nerve-tubes* appears to take place, like that of Muscular fibre, by the coalescence of a number of primary cells into a continuous tube; for although the primary nervous cell has not yet been made out with precision, the nuclei of what seem to be the original cells may frequently be seen in the fully-formed tube, lying between their membranous walls, and the white substance of Schwann (111, c). When first a nerve-fibre can be recognized as such, it has a strong resemblance to the gelatinous fibres of the sympathetic trunks; being a cord of small diameter, without any clear distinction between the tube and its contents, of granular consistence, and having nuclei at no great distance from each other. The substance of the fibre, at this period, seems to correspond with the axis-cylinder of the fully-formed nerve-tube; the white substance of Schwann is subsequently deposited around it, separating it from the membranous tubular envelope.—The first development of the *vesicular* substance appears to take place on the same plan with its subsequent renewal.

[Fig. 123.]

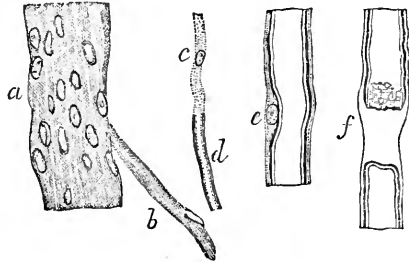

Various stages of the development of nerve;—*a*. Earliest stage. *b*. Detached fibre. *c*. Nucleated fibre in the lower part of which, *d*, the white substance of Schwann has begun to be deposited. *e*. Nucleus in a more fully-formed fibre between the white substance and tubular membrane. *f*. Displays the tubular membrane, the contained matter having given way.—(After Schwann.)]

253. The *regeneration* of Nervous tubuli that have been destroyed, takes place in continuity with that which has been left sound. This may be more easily proved by the return of the sensory and motor endowments of the part whose nerves have been separated, than by microscopic examination of the reunited trunks themselves, which is not always satisfactory. All our knowledge of the functions of the Nervous System leads to the belief, that *perfect continuity* of the nerve-tubes is requisite for the conduction of an impression of any kind, whether this be destined to produce motion or sensation; and various facts, well known to Surgeons, prove that such restoration may be complete. In the various operations which are practised for the restoration of lost parts, a portion of tissue removed from one spot, is grafted as it were upon another; its original attachments are more or less completely severed, frequently altogether destroyed, and new ones are formed. Now in such a part, so long as its original connections exist, and the new ones are not completely formed, the sensation is referred to the spot from which it was taken; thus, when a new nose is made, by partly detaching and bringing down a piece of skin from the forehead, the patient at first feels, when anything touches the tip of his nose, as if the contact were really with the upper part of his forehead. After time has been given, however, for the establishment of new connections with the parts into whose neighbourhood it has been brought, the old connections of the grafted portion are completely severed, and an interval ensues, during which it frequently loses all sensibility; but after a time its power of feeling is restored, and the sensations received through it are referred to the right spot.—A more familiar case is the regeneration of Skin, containing sensory nerves, which takes place in the well-managed healing of wounds involving loss of substance. Here there must obviously be, not merely a prolongation of the nerve-tubes from the subjacent and surrounding trunks, but also a formation of new sensory papillæ.—A still more striking example of the regeneration of Nervous tissue, however, is to be found in those cases (of which there are now several on record), in which portions of the extremities, that have been completely severed by accident, have been made to adhere to the stump, and have, in time, completely recovered their connection with the Nervous as with the other systems,—as indicated by the restoration of their motor and sensory endowments.

CHAPTER IV.

GENERAL VIEW OF THE FUNCTIONS.

1. *Of Vital Actions, their conditions, and their mutual dependence.*

254. THE idea of *Life*, in its simplest and most correct acceptance, is that of *Vital Action*: and obviously, therefore, involves that of *change*. We do not consider any being as *alive*, which is not undergoing some continual alteration, that may be rendered perceptible to the senses. This alteration may be evidenced only by the growth and extension of the organic structure, or the development of new parts; and it may take place so slowly as to be imperceptible, except by comparing observations made at long intervals. Thus the scaly Lichen, that forms the grey or yellow spots upon old walls, might be thought an inert substance, did we not know that a sufficiently-prolonged

acquaintance with its history would detect its progressive though tardy extension, and would ascertain that it multiplies its race by an humble yet effectual process of fructification.—Or the change may be rather evidenced, by the performance of some kind of movement, for which the ordinary physical laws of matter will not account; yet, for the detection of this, a close and careful scrutiny will be frequently required. Thus the Oyster that is lying motionless in its massive bed, or the *Ascidia* that clusters upon the faces of sea-beaten rocks, may seem totally destitute of activity; yet it would be found upon close examination, that their internal surfaces are covered with cilia which are in continual vibration,—that by this means water is drawn into the stomach and caused to traverse the respiratory organs, yielding to the former the animalcules it may contain, and to the latter the oxygen dissolved in it,—that the food thus introduced into the stomach undergoes digestion, and is converted into materials adapted to nourish the body, which are then conveyed to its different parts by a circulating apparatus,—that in due time embryos are produced, which are endowed with powers of active motion, and which swim forth from within the parent-envelopes and locate themselves elsewhere,—and that, apathetic as these creatures may seem, they may be excited by certain kinds of stimuli to movements which seem to evince sensation; the Oyster closing its shell, and the *Ascidia* contracting its muscular tunic, when it receives any kind of mechanical irritation; and the former, whilst lying undisturbed in its native haunts, drawing together its valves, if a shadow passes between itself and the sun.—From what has been already stated, regarding the nature of the actions of the Nervous and Muscular systems, by which the movements of Animals are chiefly effected, it would appear that these, in common with the Vegetative functions, involve a chemical alteration in the structure performing them; so that it may be stated as a general proposition, that *a change in Chemical composition is an essential condition of every Vital phenomenon.*

255. If change be essential to our idea of Life, it may be asked, what is the condition of a seed, which may remain unaltered during a period of many centuries; vegetating at last, when placed in favourable circumstances, as if it had only ripened the year before. Such a seed is not alive; for it is not performing any vital operations. But it is not dead, for it has undergone no decay; and it is still capable of being aroused into active life, when the proper stimuli are applied. And the most correct designation of its state seems to be that of *dormant vitality*.—The condition of an animal reduced to a state of complete torpidity and inaction, is precisely similar; into such a condition, the Frog may be brought by cold, and the Wheel-Animalcule by deprivation of moisture. And the condition of a Human being, during sleep, is precisely similar, so far as his psychical powers are concerned; he is not then a feeling, thinking Man; but he is capable of feeling and thinking, when his brain is restored to a state of activity, and its powers are called into operation by the impressions of external objects.

256. There can be no doubt whatever, that, of the many changes which take place during the *life*, or state of *vital activity*, of an Organised being, and which intervene between its first development and its final decay, a large proportion are effected by the direct agency of those forces which operate in the Inorganic world; and there is no necessity whatever for the supposition, that these forces have any other operation *in* the living body, than they would have *out* of it under similar circumstances.—But after every possible allowance has been made for the operation of Physical and Chemical forces in the living Organism, there still remain a large number of phenomena, which cannot be in the least explained by them; and which we can only investigate with success, when we regard them as resulting from the agency of forces, as distinct

from those of Physics and Chemistry, as *these* are from each other. It is to such phenomena, that the name of *Vital* is properly restricted; the forces from whose operation we assume them to result, are termed *vital forces*; and the properties, which we must attribute to the substances exerting those forces, are termed *vital properties*.—Thus we say that the contraction of Muscle is a Vital phenomenon; because its character and conditions appear to be totally distinct from those of Chemical or Physical phenomena. The act is the manifestation of a certain Force; the possession of which is peculiar to the muscular structure, and which is named the Contractile force. Further, that force may remain dormant (as it were) in the muscular structure; not manifesting itself for a great length of time, and yet resting capable of being called into operation at any moment. This dormant force is termed a Property; thus we regard it as the essential peculiarity of living muscular tissue, that it possesses the vital property of Contractility. Or, to reverse the order, the Muscle is said to possess the property of Contractility; the property, called into operation by the appropriate stimulus, gives rise to the Contractile force; and the force produces, if its operation be unopposed, the act of Contraction.

257. These distinctions, though apparently verbal only, are of importance in leading us to the correct method of investigating Vital Phenomena, and of comparing them with those of the Inorganic world. It is now almost universally admitted by intelligent Physiologists, that we gain nothing by the assumption of some general controlling agency, or Vital Principle, distinct from the organized structure itself; and that the Laws of Life are nothing else than general expressions of the conditions under which Vital operations take place,—expressions analogous to those which constitute the laws of Physics or Chemistry,—and to be arrived at in the same manner, namely, by the collection and comparison of phenomena. The difficulty of thus generalising in Physiology results merely from the complex nature of the phenomena, and the consequent difficulty of precisely determining their conditions. We have as much ground for believing in the fixity and constancy of Physiological phenomena, when the causes and conditions are the same, as we have in those of any other department of science; and the apparent uncertainty of the actions of the living body, results merely from the influence of differences in those conditions, so trivial in appearance as frequently to elude observation, and yet sufficiently powerful in reality to produce an entire change in the result.

258. All Vital phenomena are dependent upon at least two sets of conditions;—an Organized structure, possessed of peculiar properties;—and certain Stimuli, by which these properties are called into action. Thus, to revert to the example just cited, the Contraction of a Muscle is due to the inherent Contractility of the Muscular tissue, called into operation by the stimulus of innervation;—other conditions, as a certain elevated temperature, a supply of oxygen, &c., being at the same time requisite. The Microscopical and Chemical researches of recent years, have given increased stability to the position, that the peculiar properties, which we term Vital, are dependent upon those peculiar modes of combination and aggregation of the elementary particles, which are characteristic of Organized structures. We have no evidence of the existence of Vital properties in any other form of matter than that which we term Organized; whilst, on the other hand, we have no reason to believe that Organized matter can possess its normal constitution, and be placed in the requisite conditions, without exhibiting Vital Actions. The advance of Pathological science renders it every day more probable (indeed, the probability may now be said to amount almost to positive certainty), that derangement in *function*,—in other words, an imperfect or irregular *action*,—

always results, either from some change of structure or composition in the tissue itself, or from some corresponding change in the external conditions, under which the properties of the organ are called into action. Thus, when a Muscle has been long disused, it can scarcely be excited to contraction by the usual stimulus, or may even be altogether powerless; and minute examination of its structure shows it to have undergone a change, which is obvious to the Microscope (the fibres being as it were shrunken, and the fibrillæ indistinct), though it may not be perceptible to the naked eye, and which results from imperfect nutrition. Or, again, convulsive or irregular actions of the Nervous System may be produced, not by any change in its own structure or composition, but by the presence of various stimulating substances in the blood (such as urea or strychnine), although their quantity may be so small, that they cannot be detected without great difficulty. Further, whenever the peculiar properties of an Organized structure can no longer be excited by the requisite stimuli, we find that it has undergone some incipient change of composition, or that some of the other conditions are wanting. Thus, the departure of the contractility from the muscles of warm-blooded animals, at no long period after the cessation of the circulation, is due in part to the lowering of their temperature, and in part to the cessation of the supply of oxygen to the elementary parts of their substance; either of which would alone suffice to prevent their response to the stimuli, that would ordinarily produce energetic contractions.—Lastly, we find special properties constantly associated with distinct forms of organized tissue; thus we never find contractility existing in the fibres of Nerve; nor do we ever find the power of conducting impressions to exist in the fibres of Muscle. The details given in the preceding Chapter make it evident that each tissue, distinguished from others by its peculiar composition, and by the form of its elementary parts, has something peculiar in its properties; and this is true, as well of properties that are simply physical, as of those that belong to a different category: thus the Yellow Fibrous tissue is distinguished from the White as much by its elasticity, as by its peculiar composition; and it does not lose its elasticity, until it is in a state of evident decay.

259. By the study of the various forms of Elementary Tissue, of which the Human fabric (or any other of similar complexity) is made up, we are led to the very same conclusion, with that which we should derive from the observation of the simplest forms of organized being, or from the scrutiny into the earliest condition of the most complex;—namely, that *the simple Cell may be regarded as the type of Organization; and that its actions constitute the simplest idea of Life.* Between the humblest Confervoid Plant, and the highest Animal, there is originally no perceptible difference; they may be said to have a common starting-point; and the subsequent difference of their course consists essentially in this,—that the successive generations of cells, which are the descendants of the former, are all similar to it, each cell being capable of existing by itself, and therefore ranking as an independent individual; whilst the subsequent generations, which originate from the latter, undergo various departures from the primary type, and lose the power of independent existence, their several actions being mutually dependent upon each other, so that the integrity of the whole fabric is essential to the continued life of any individual cell. Every individual part, however, even in the most complex and highly-organized fabric, has its own power of development; and the properties which it possesses are the result of the exercise of that power. But instead of the power of cell-growth being exerted, as in the Plant, upon the inorganic elements around, it can only be put in action, in the Animal, upon certain peculiar compounds, having the same chemical composition with its own substance; and it is for the reception of these, for their

preparation, and for their maintenance in the requisite state of purity, that a large part of the fabric of the Animal is destined. But if we could imagine its several tissues to be supplied with nutriment in any other manner, and maintained in other respects in their normal circumstances (as regards warmth, air, &c.), we have every reason to believe that their independent vitality would manifest itself by their continued development, and by the regular exhibition of their ordinary properties. An approach to this condition is made, in the experiment of entirely detaching a limb from the body, but keeping up the circulation of blood through it, by means of tubes connecting its main artery and vein with those of the stump. Notwithstanding the prejudicial effect of such severe injuries, the increased duration of the muscular irritability in the separated part, is a sufficient proof of the continuance of the normal actions of nutrition, although of course in a diminished degree. And the occasional reunion of a member which has been entirely separated, when decomposing changes have not yet commenced in it, most clearly shows, that nothing but the restoration of its supply of nutriment is requisite for the preservation of its vitality, and that its powers of growth and renovation are inherent in itself, only requiring a due supply of the nutrient material, with certain other concurrent conditions.

260. In every living structure of a complex nature, therefore, we see a great variety of actions, resulting from the exercise of the different properties of its several component parts. If we take a general survey of them, with reference to their mutual relations to each other, we shall perceive that they may be associated into groups; each consisting of a set of actions, which, though different in themselves, concur in effecting some positive and determined purpose. These groups of actions are termed *Functions*. Thus, one of the most universal of all the changes necessary to the continued existence of a living being, is the exposure of its nutritious fluid to the air; by the action of which upon it, certain alterations are effected. For the performance of this aeration, simple as the change appears, many provisions are required. In the first place, there must be an aerating surface, consisting of a thin membrane, permeable to gases; on the one side of which the blood may be spread out, whilst the air is in contact with the other. Then there must be a provision for continually renewing the blood which is brought to this surface; in order that the whole mass of fluid may be equally benefited by the process. And, in like manner, the stratum of air must also be renewed, as frequently as its constituents have undergone any essential change. We include, therefore, in speaking of the Function of Respiration, not only the actual aerating process, but also the various changes which are necessary to carry this into effect, and which obviously have it for their ultimate purpose.

261. On further examining and comparing these Functions, we find that they are themselves capable of some degree of classification. Indeed the distinction between the groups into which they may be arranged, is one of essential importance in Animal Physiology. If we contemplate the history of the Life of a Plant, we perceive that it grows from a germ to a fabric of sometimes gigantic size,—generates a large quantity of organised structure, as well as many organic compounds, which form the products of secretion, but which do not undergo organization,—and multiplies its species, by the production of germs similar to that from which it originated;—but that it performs all these complex operations, without (so far as we can perceive) either feeling or thinking, without consciousness or will. All the functions of which its Life is composed, are, therefore, grouped together under the general designation of Functions of *Organic* or *Vegetative* life: and they are subdivided into those concerned in the maintenance of the structure of the individual, which are termed functions of *Nutrition*; and those to which the *Reproduction* of the species

is due.—The great feature of the Nutritive operations in the Plant, is their *constructive* character. They seem as if destined merely for the building-up and extension of the fabric; and to this extension there may be no definite limit. But it is very important to remark, that the growth of the more *permanent* parts of the structure is only attained by the continual development, decay, and renewal of parts, whose existence is *temporary*. No fact is better established in Vegetable Physiology, than the dependence of the formation of wood upon the action of the leaves. It is in their cells, that those important changes are effected in the sap, by which it is changed, from a crude watery fluid containing very little solid matter, to a viscid substance including a great variety of organic compounds, destined for the nutrition of the various tissues. The “fall of the leaf” results merely from the death and decay of its tissue; as is evident from the fact, that, for some time previously, its regular functions cease, and that, instead of a fixation of carbon from the atmosphere, there is a liberation of carbonic acid (a result of their decomposition) in large amount. The process takes place in evergreens equally with deciduous trees; the only difference being, that the leaves in the latter are all cast off and renewed together, whilst in the former they are continually being shed and replaced, a few at a time. It appears as if the nutritious fluid of the higher Plants can *only* be prepared by the agency of cells, whose duration is brief; for we have no instance, in which the tissue concerned in its elaboration possesses more than a very limited term of existence. But by its active vital operations, it produces a fluid adapted for the nutrition of parts which are of a much more solid and permanent character, and which undergo little change of any kind subsequently to their complete development;—the want of tendency to decay being the result of the very same peculiarity of constitution as that which renders them unfit to participate in the proper vital phenomena of the organism. Thus the final cause or purpose of all the Nutritive functions of the Plant, so far as the *individual* is concerned, is to produce an indefinite extension of the dense, woody, almost inert, and permanent portions of the fabric, by the continued development, decay, and renewal of the soft, active, and transitory cellular parenchyma.—The Nutritive functions, however, also supply the materials for the continuance of the *race*, by the generation of new individuals; since a new germ cannot be formed, any more than the parent structure can be extended, without organizable materials, prepared by the assimilating process, and supplied to the parts where active changes are going on.

262. On analyzing the operations which take place in the Animal body, we find that a large number of them are of essentially the same character with the foregoing, and differ only in the conditions under which they are performed; so that we may, in fact, readily separate the *Organic* functions, which are directly concerned in the development and maintenance of the fabric, from the *Animal* functions, which render the individual conscious of external impressions, and capable of executing spontaneous movements. The relative development of the organs destined to these two purposes, differs considerably in the several groups of Animals, as we have already in part seen (Chap. I.). The life of a Zoophyte is upon the whole much more vegetative than animal; and we perceive in it, not merely the very feeble development of those powers which are peculiar to the Animal kingdom, but also that tendency to indefinite extension which is characteristic of the Plant. In the Insect we have the opposite extreme; the most active powers of motion, and sensations of which some (at least) are very acute, with a low development of the organs of nutrition. In Man, and in the higher classes generally, we have less active powers of locomotion, but a much greater variety of Animal powers; and the instruments of the organic or nutritive operations attain their highest development, and their greatest degree of mutual dependence. We see in the fabric of all

things, in which the Animal powers are much developed, an almost entire want of that tendency to indefinite extension, which is so characteristic of the Plant; and when the large amount of food consumed by them is considered, the question naturally arises, to what purpose this food is applied, and what is the necessity for the continued activity of the Organic functions, when once the fabric has attained the limit of its development.

263. The answer to this question lies in the fact, that *the exercise of the Animal functions is essentially destructive of their instruments*; every operation of the Nervous and Muscular systems requiring, as its necessary condition, a disintegration of a certain part of their tissues, probably by their elements being caused to unite with oxygen. The duration of the existence of those tissues (as stated in the preceding Chapter) varies inversely to the use that is made of them; being less as their functional activity is greater. Hence, when an Animal is very inactive, it requires but little nutrition; if in moderate activity, there is a moderate demand for food; but if its Nervous and Muscular energy be frequently and powerfully aroused, the supply must be increased, in order to maintain the vigour of the system. In like manner, the amount of certain products of excretion, which result from the disintegration of the Nervous and Muscular tissues, increases with their activity, and diminishes in proportion to their freedom from exertion.* We are not to measure the activity of the Nervous system, however, like that of the Muscular, only by the amount of *movement* to which it gives origin. For there is equal evidence, that the demand for blood in the brain, the amount of nutrition it receives, and the degree of disintegration it undergoes, are proportional likewise to the energy of the purely *psychical* operations; so that the vigorous exercise of the intellectual powers, or a long-continued state of agitation of the feelings, produces as great a *waste* of Nervous matter, as is occasioned by active bodily exercise. From this and other considerations, we are almost irresistibly led to the belief, that every act of Mind is inseparably connected, in our present state of being, with material changes in the Nervous System; a doctrine not in the least inconsistent with the belief in the separate immaterial existence of the Mind itself, nor with the expectation of a future state, in which the communion of Mind with Mind shall be more direct and unfettered.

264. Thus in the Animal fabric, among the higher classes at least, the function or purpose of the organs of Vegetative life is not so much the extension of the fabric, for this has certain definite limits, as *the maintenance of its integrity, by the reparation of the destructive effects of the exercise of the purely Animal powers*. Thus, by the operations of Digestion, Assimilation, and Circulation, the nutritious materials are prepared and conveyed to the points where they are required; the Circulation of Blood also serves to convey oxygen, which is introduced by the Respiratory process; and it has further for its office to convey away the products of the decomposition of the Muscular and Nervous tissues that results from their functional activity,—these products being destined to be separated by the Respiratory and other Excreting operations. In the performance of the Organic functions of Animals, as in those of Plants, there is a continual new production, decay, exuviation, and renewal, of the cells, by whose instrumentality they are effected; which altogether effect a change not less complete than of the leaves in Plants. But it takes place in the penetralia of the system, in such a manner as to elude observation, except that of the most scrutinizing kind; and it has been in bringing this into view, that the Microscope has rendered most essential service in Physiology.

* This doctrine, though propounded in general terms by previous writers, was first pointed out by Prof. Liebig, so far as regards Muscular tissue, in his Treatise on Animal Chemistry. It will be hereafter shown, however, to be equally applicable to the Nervous substance.

265. The regular maintenance of the functions of Animal life is thus entirely dependent upon the due performance of the Nutritive operations; a consideration of great importance in practice, since a very large proportion of what are termed functional disorders (of the Nervous system especially) are immediately dependent upon some abnormal condition of the Blood. But there also exists a connection of an entirely reverse kind, between the Organic and Animal functions; for the conditions of Animal existence render the former in great degree dependent on the latter. Thus, in regard to the acquisition of food, the Animal has to make use of its senses, its psychical faculties, and its power of locomotion, to obtain that which the Plant, from the different provision made for its support, can derive without any such assistance. Moreover, the propulsion of the food along the alimentary canal is effected by a series of operations, in which the Nervous and Muscular systems are together involved at the two extremes; though simple Muscular contractility is alone employed through the greater part of the intestinal canal. Thus, the change in the conditions required for the ingestion of food by Animals, has rendered necessary the introduction of an additional element in the apparatus, to which nothing comparable was to be found in Plants. Again, in the function of Respiration as performed in the higher Animals, the Nervous and Muscular systems are alike involved; for the movements, by which the air in the lungs is being continually renewed, are dependent upon the action of both; and those by which the blood is propelled through the respiratory organs, are chiefly occasioned by the contractility of a muscular organ,—the heart. But in regard to the simple contractility of muscular fibre, upon the direct application of a stimulus to it, which is the agent in the movements of the heart and of the alimentary canal, it may be remarked, that it does not differ in any essential particular from that which is witnessed in many Vegetables: so that it strictly belongs to the functions of Organic life. And with respect to those concerned in the act of Respiration, as well as those which govern the two orifices of the alimentary tube, it will hereafter appear that they result, equally with the former, from the application of a stimulus; and that they may be performed without any consciousness on the part of the individual (though ordinarily accompanied by it):—the difference being, that in the former the stimulus is applied to the contractile part itself, whilst in the latter it is applied to an organ with which this is connected by nerves only. Now we have, even in Vegetables, instances of the propagation of an irritation from one part to another, so that a motion results in a part distant from that stimulated,—as in the case of the Sensitive Plant or Venus's Fly-trap. The only essential difference, therefore, between those movements of Animals, which are thus closely connected with the maintenance of the organic functions, and those of Plants, consists in the medium through which they are performed,—this being in Animals a distinct Nervous and Muscular apparatus, whilst in Plants it is only a peculiar modification of the ordinary structure.

266. From what has been said, then, it appears that all the functions of the Animal body are so completely bound up together, that none can be suspended without the cessation of the rest. The properties of all the tissues and organs are dependent upon their regular Nutrition, by a due supply of perfectly-elaborated blood; this cannot be effected unless the functions of Circulation, Respiration, and Secretion, be performed with regularity,—the first being necessary to convey the supply of nutritious fluid, and the two latter to separate it from its impurities. The Respiration cannot be maintained without the integrity of a certain part of the nervous system; and the due action of this, again, is dependent upon its regular nutrition. The materials necessary for the replacement of those which are continually being separated from the blood, can only be derived by the Absorption of ingested aliment; and this cannot be accomplished without the preliminary process of Digestion. The intro-

duction of food into the stomach, again, is dependent, like the actions of Respiration, upon the operations of the muscular apparatus and of a part of the nervous centres; and the previous acquirement of food necessarily involves the purely Animal powers. Now it will serve to show the distinction between these powers, and those which are merely subservient to Organic life, if we advert to the case, which is of no unfrequent occurrence, of a human being, deprived, by some morbid condition of the brain, of all the powers of Animal life,—Sensation, Thought, Volition, &c.; and yet capable of maintaining a vegetative existence,—all the organic functions going on as usual, the morbid condition not having affected the division of the nervous system, that is concerned in the movements on which some of them depend. It is evident that we can assign no definite limits to such a state, so long as the necessary food is placed within reach of the grasp of the muscles, that will convey it into the stomach; as a matter of fact, however, it is seldom of long continuance; since the disordered state of the brain is sure to extend itself, sooner or later, to the rest of the nervous system. This condition may be experimentally imitated, however, by the removal of the brain in many of the lower animals, whose bodies will sustain life for many months after such a mutilation; but this can only take place when that food is conveyed by external agency within the pharynx, which they would, if in their natural condition, have obtained for themselves. A similar experiment is sometimes made by Nature for the Physiologist, in the production of fœtuses, as well of the human as of other species, in which the brain is absent; these can breathe and suck and swallow, and perform all their organic functions; and there is no assignable limit to their existence, so long as they are duly supplied with food. Hence we may learn the exact nature of the dependence of the Organic functions upon those of purely Animal life; and we perceive that, though less immediate than it is upon the simple organic operations of the nervous and muscular systems, it is not less complete. On the other hand, the functions of Animal life are even more closely dependent upon the Nutritive actions than are those of organic life in general; for many tissues will retain their several properties, and their power of growth and extension, for a much longer period after a general interruption of the circulation, than will the Nervous structure; which is, indeed, instantaneously affected by a cessation of the due supply of blood, or by the deprivation of its quality.

267. It is of little consequence, then, with which group of functions we commence the detailed study of the phenomena, which in their totality make up the *life* of Man. In viewing him merely as one of the widely-extended group of organized beings, it would be natural to commence with those phenomena which are common to all; and to make, therefore, the Organic functions the first object of our consideration. On the other hand, regarding Man as a being in some degree isolated from all these by his peculiar characteristics, it seems right to inquire into the latter in the first instance; more especially as, in a general view of his life, these occupy the most prominent place. It will be necessary, however, previously to entering upon them, to take a more detailed survey than we have hitherto done, of the vital operations performed by his several organs, and of their connections with each other. We shall commence with those of Vegetative Life.

2. *Functions of Vegetative Life.*

268. It is one of the most peculiar characteristics of Organized structure, that its elements have a constant tendency (under ordinary circumstances at least) to separate into more simple combinations; and although it has been ordinarily considered, that their living state prevents such a change, and that

they have no tendency to it except when dead, reason will hereafter be given for the belief that no such distinction exists (Chap. XIV., Sect. 4). The maintenance of the vital properties of all organized structure then, requires either that this structure should be completely secluded from air, moisture, warmth, and other agents which tend to its decomposition; or that it should be renewed as fast as it decays. Now the exclusion of these decomposing agents would prevent any vital actions from being called into operation; since they are the ordinary stimuli which are necessary to them. For instance, a seed which is buried so deep in the soil as to be excluded from the contact of air, and from the warmth of the sun, will not vegetate, although it may retain its power of germinating when placed in more favourable circumstances; and it will not decay, because secluded from the air and warmth which are necessary to its decomposition. But as a certain change of composition appears to be a necessary condition of its vital activity, it is obviously requisite that a provision should be made, for removing from the organism all those particles which are manifesting an incipient tendency to decay, and are thus losing their vital properties; and for replacing these by newly-combined particles, which in their turn undergo the same process. Thus we find that, in the softest parts of the Animal frame-work, as in those of the Plant, there is much less permanency than there is in those harder and more solid portions, which often seem altogether to defy the lapse of time. Now it is in the former that the most active *vital* changes take place,—those of the nervous system, for example; whilst of the latter, the function is chiefly, if not entirely, that of giving *mechanical* support to the structure. The former organs are renewed many times, whilst the fabric of the latter is not once completely changed; and thus a very interesting correspondence is shown between the degree in which the action of any organized structure is removed from, or is similar to, that of a mere inorganic substance, and the amount of tendency to decomposition which that structure exhibits; since this constant renewal can scarcely serve any other purpose than that of making up for the effects of decay.

269. One of the most important purposes of the supply of aliment, therefore, which all living beings continually require, is the replacement of the portions of the fabric that are thus lost. The effects of the process of decay, when uncompensated by that of renovation, are remarkably seen in cases of starvation; for it is a very constant indication of this condition, that the body exhales a putrescent odour, even before death, and that it subsequently passes very rapidly into decomposition. This, it may be considered, is the reason why a constant supply of aliment is still required for the maintenance of every organic structure, though it may have arrived at its full growth; and it also affords one source of explanation of the fact, that old people require less food than adults, since their tissues are more consolidated, and thus become at the same time unable to perform their usual actions with their pristine energy, whilst their tendency to decomposition is less. In the growing state, however, an additional important source of demand for food obviously exists, in the extension which the tissues themselves are constantly receiving; yet this, perhaps, does not make so great a difference, as it appears to do, in the supply which is requisite. For if the *addition* which is made by growth to the body in any given time, be compared with the amount of *exchange* which has taken place in the same time,—the latter being judged of by the quantity of matter excreted from the lungs, liver, kidneys, skin, &c.,—it will be found to bear but a very small proportion to it; except during *foetal* life, when the growth is very rapid, and a large proportion of the effete particles are communicated to the maternal blood, to be excreted from it. The real cause of the increased demand for nutriment, during the early part of life, is rather

this,—that the tissues are far from having acquired that firmness and consolidation which they gain at adult age; and that they are, therefore, more prone to decomposition, at the same time that their vital activity is greater, as is well known to be the case.—The feeling of hunger or desire for food originates, we shall hereafter find reason to believe (Chap. X., Sect. 1), not so much in the stomach itself, as in the system at large; of whose condition, in regard to the requirement of an increased supply of aliment, it may, during the state of health, be considered as a pretty faithful index. The same may be said of thirst. The feeling of hunger, then, is the stimulus to the mental operations, which have for their object the acquisition of food; whether these be of a voluntary or of a purely instinctive kind. In Man they are obviously the former, during all but infant life.

270. The food received into the mouth, and prepared there by the acts of mastication and insalivation (the movements concerned in which are dependent upon the brain, and can only be performed when it is in a condition of some activity), is brought by them within reach of the pharyngeal muscles, whose contraction cannot be effected by the will, but is purely *excito-motor*,—resulting merely from the impression made upon the fauces by the contact of the substance swallowed, which impression is conveyed to the medulla oblongata and reflected back to the muscles (§ 383). By these it is propelled down the œsophagus; and, after their action has ceased, it is taken up (as it were) by the muscular coat of the œsophagus itself, and conveyed into the stomach. How far the movements of the lower parts of the œsophagus and of the stomach are in Man dependent upon reflex action, is uncertain; the facts which have been ascertained on this point, by experiment on animals, will be detailed in their proper place (§ 390). In the stomach the food is subjected to the gastric secretion; the chemical action of which, aided by the constantly-elevated temperature of the interior of the body, and by the continual agitation effected by the contractions of the parietes of the organ, effects a more or less complete solution of it. The mixture of the biliary and pancreatic secretions with the *chyme* thus produced, occasions a separation of its elements into those adapted for nutrition, and those of which the character is excrementitious; and this separation can scarcely be regarded in any other light than as a chemical precipitation. By the agency of the biliary secretion, moreover, certain elements of the food that would otherwise be rejected, are reduced to a form in which they can be absorbed. The nutritious portion is taken up by the Blood-vessels and by the Absorbent vessels (or Lacteals), which are distributed on the walls of the alimentary canal; whilst the remainder is propelled along the intestinal tube by the simple contractility of its walls, undergoing at the same time some further change, by which the nutritive materials are still more completely extracted from it. And at last, the excrementitious matter,—consisting not only of a portion of the food taken into the stomach, but also of part of the secretion of the liver, and of that of the mucous surface of the intestines and of their glandulæ,—is avoided from the opposite extremity of the canal, by a muscular exertion, which is partly reflex, like that of deglutition, but is partly voluntary, especially (as it would appear) in Man.

271. There seems no doubt that fluid containing saline, albuminous, or other soluble matters, may be absorbed by the Blood-vessels, with which the mucous membrane of the alimentary canal is so copiously supplied; and this simple process of Imbibition probably takes place according to the physical laws of Endosmose. But the Selection and Absorption of certain *nutritious* elements appear to be performed, not by *vessels*, but by the growth and development of *cells* (§ 181); which, by their subsequent disintegration, give it up to the Lacteals. The absorbed fluid, which now receives the name of

Chyle, is propelled through the Lacteals, by the contractility of their walls ; aided in part, perhaps, by a *vis à tergo* derived from the force of the absorbent vessels. With the reception of the nutritious fluid into the absorbent vessels, commences its real preparation for Organization. Up to that period, it cannot be said to be in any degree *vitalised* ; the changes which it has undergone being only of a chemical and physical nature, and such as merely *prepare* it for subsequent assimilation. But in its passage through the long and tortuous system of absorbent vessels and glands, it undergoes changes which, with little chemical difference, manifest themselves by a decided alteration in its properties ; so that the chyle of the thoracic duct is evidently a very different fluid from the chyle of the lacteals, approaching much nearer to blood in its general characters. These characters are such as indicate that the process of organization and vitalization has commenced ; as may be known alike from the microscopic appearance of the fluid, and from the actions it performs when removed from the body. There is reason to believe that the changes, which the Chyle undergoes in its progress through the lacteals, are due to the action of certain *cells* which are seen to be diffused through the liquid (§ 155) ; these, by their own independent powers of growth, are continually absorbing into themselves the fluid in which they float ; whilst, by bursting or liquefying, as soon as their term of life is completed, they give this back in an altered state. The Chyle thus modified is conveyed into the Sanguiferous system of vessels, and flows directly to the heart ; by which it is transmitted with the mass of the blood, to the lungs. It there has the opportunity of excreting its superfluous carbonic acid, and of absorbing oxygen ; and probably acquires gradually the properties, by which the blood previously formed is distinguished,—thus becoming the *pabulum vitæ* for the whole system.

272. The Circulation of the Blood through the tissues and organs which it is destined to support, is a process evidently necessary for the conveyance to them of the nutritious materials, which are provided for the repair of their waste ; and for the removal of those elements of their fabric, which are in a state of incipient decomposition. In the lowest classes of organized beings, every portion of the structure is in direct relation with its nutritive materials ; it can absorb for itself that which is required ; and it can readily part with that of which it is desirable to get rid. Hence in such, no general circulation is necessary. In Man, on the other hand, the digestive cavity occupies so small a portion of the body, that the organs at a distance from it have no other means, than their vascular communication affords, of participating in the results of its operations ; and it is moreover necessary that they should be continually furnished with the organizable materials, of which the occasional operation of the digestive process would otherwise afford only an intermitting supply. This is especially the case, as already mentioned, with the Nervous system, which is so predominant a feature in the constitution of Man ; and we accordingly find both objects provided for, in the formation of a large quantity of a semi-organized product, which contains within itself the materials of all the tissues, and is constantly being carried into relation with them. Blood has been not unaptly termed *chair coulante*, or liquid flesh ; and although it has been heretofore much questioned, whether it could be regarded as either organized or endowed with vital properties, there now appears to be sufficient reason for admitting, that this is the case to a very considerable extent. The propulsion of the blood through the large trunks, which subsequently divide into capillary vessels, is due to the contractions of a hollow muscular organ, the Heart ; but these, like the peristaltic movements of the alimentary canal, are quite independent of (though frequently influenced by) the

agency of the Nervous system; and are therefore to be referred to the class of Organic movements, such as occur in Vegetables.

273. Upon the circulation of the blood through all parts of the fabric, depends, in the first place, the Nutrition of the tissues. Upon this subject, formerly involved in the greatest obscurity, much light has recently been thrown by Microscopic discovery; it being now understood (as explained in the preceding Chapter), that the continued growth and renewal of each tissue are effected by a continuation of a process of cell-growth, similar to that by which it was first developed. Even where the primary cells have changed their character, their nuclei remain persistent; and may be regarded (in the language of Mr. J. Goodsir) as so many "germinal centres," for giving origin to new products. The greatest difficulty, in the present condition of our knowledge of this most interesting subject, is to comprehend the reason why such a variety of products should spring up; when the cells in which they all originate, appear to be so exactly alike. The important discoveries now referred to are not confined to healthy structures; for it has been ascertained, that diseased growths have a similar origin and mode of extension; and that the *malignant* character, assigned to Cancer, Fungus Hæmatodes, and other such productions, is to be traced to the fact, that they are composed of cells which undergo little metamorphosis, and retain their reproductive power; so that from a single cell, as from that of a Vegetable Fungus, a large structure may rapidly spring up, the removal of which is by no means attended with any certainty that it will not speedily re-appear, from some germs left in the system.

274. The independent character of the cells in which all organized tissues originate, might be of itself a satisfactory proof that, in Animals, as in Plants, the actions of Nutrition are performed by the powers with which they are individually endowed; and that, whatever influence the Nervous system may have upon them, they are not in any way essentially dependent upon it. Moreover, there is an evident improbability in the idea, "that any one of the solid textures of the living body should have for its office, to give to any other the power of taking on any vital actions:" and the improbability becomes an impossibility, when the fact is made known, that no formation of nervous matter takes place in the embryonic structure, until the processes of Organic life have been for some time in active operation. The influence which the Nervous System is known to have upon the Function of Nutrition, is probably exerted, rather through the medium of its power of regulating the diameter of the arteries and capillaries, by which it controls in some degree the afflux of blood, and of affecting those preliminary actions on which the quantity and quality of the nutritious fluid depend; than in any more direct manner. At any rate, it may be safely asserted, that no such proof of its more direct influence, as is required to counterbalance the manifest improbability which has been shown to attend it, has yet been given;—all the facts which have been adduced in support of this hypothesis being equally explicable on the other, which, being in itself more probable, ought to be preferred.

275. The renewal which the various tissues of the body are continually undergoing, has for its chief object the counteraction of the decay into which they would otherwise speedily pass; and it is obviously required, that a means should be provided for conveying away the waste, as well as for supplying the new material. This is partly effected by the Venous circulation; which takes up a large part of the products of incipient decomposition, and conveys them to organs of Excretion, by which they may be separated and cast forth from the body. The first product of the decay of all organized structures, is carbonic acid; and this is the one which is most constantly and rapidly accumulating in the system, and the retention of which, therefore, within the

body, is the most injurious. Accordingly, we find two large organs—the Lungs and the Liver—adapted to remove it; and to both these Venous blood passes, before it is again sent through the system. The function of the Lungs is so important in warm-blooded animals, that a special heart is provided for propelling the blood through them; in addition to the one possessed by most of the lower animals, the function of which is the propulsion of the blood through the system. In these organs, the blood is subjected to the influence of the atmosphere, by which the carbonic acid with which it was charged, is removed and replaced by oxygen; and this change takes place, through the delicate membrane that lines the air-cells of the lungs, according to the physical law of the mutual diffusion of gases. The introduction of oxygen into the blood is necessary for the maintenance of those peculiar vivifying powers, by which the Nervous and Muscular systems are kept in a state fit for activity; and its union with their elements appears to be a necessary condition of the manifestation of their peculiar powers. Of this union, carbonic acid is one of the chief products; and we shall find that the demand for oxygen, and the excretion of carbonic acid, vary according to the amount of nervous and muscular action. The continual formation of carbonic acid, in this and other interstitial changes, appears to have a most important purpose in the vital economy,—that of keeping up its temperature to a fixed standard; for the union of carbon and oxygen in this situation may be compared to a process of slow combustion; and it is well known that, the more energetic this is, the higher is the temperature. Thus, in Birds, whose muscular and nervous activity is so great, and whose respiration is so energetic, the temperature is constantly maintained at a point higher than that which other animals ever attain, in the healthy state at least; whilst in Reptiles, which present a condition exactly the reverse of this, the temperature is scarcely above that of the surrounding medium.—The function of the Liver is, like that of the lungs, twofold; it separates from the blood a large quantity of the superfluous hydro-carbon, which it acquires by circulating through the tissues; and it combines that carbon with other elements, into a secretion, which, as we have seen, is of great importance in the digestive process. The hepatic circulation, however, is not kept up by a distinct impelling organ; but the venous blood from the abdominal viscera (and, in the lower Vertebrata, that from the posterior part of the body) passes through the Liver on its return to the heart.

276. All animal substances have a tendency, during their decomposition, to throw off nitrogen, as well as carbon; and this nitrogen may take the form either of cyanogen, by going off in combination with carbon, or of ammonia, by uniting at the time of its liberation with hydrogen. The chief function of the Kidneys is evidently to separate the azotized products of decay from the circulating fluid; for the secretion which is characteristic of them,—namely *urea*,—contains a larger proportion of nitrogen than is found in any other organic compound; it is identical in its chemical nature with cyanate of ammonia, and may be considered as the result of the union of these two products of animal decomposition. The action of the kidneys is equally essential to the continued performance of the other vital functions, with that of the lungs and liver; since death invariably follows its suspension, unless some other means be provided by Nature (as occasionally happens), for the separation of its characteristic excretion from the circulating blood.

277. There seems reason to believe, however, that, of the products of decomposition which are set free in the various tissues and organs of the body, only a part is destined to be immediately excreted; and that it is this part, which is taken up by the Veins, and conveyed, by the general vascular apparatus, to the several glands which are to separate it. The remainder, consisting of substances which are fit to be re-assimilated, appears to be

taken up by a distinct system of vessels, termed *Lymphatics*; which may be considered as an extension of the Lacteal system through the fabric at large. There is good reason to believe, that the special function of the Lymphatics is, like that of the Lacteals, to minister to *Nutritive* absorption (although other substances *may* find their way into them, by the mere physical process of imbibition); the latter being especially destined to take up assimilable matter from the digestive cavity, whilst the former absorb the products of the secondary digestion, which seems to be continually going on in every part of the body. (See Chap. XI., Sects. 1 and 2.) Of these, however, a portion may still be destined to immediate excretion.

278. The various Secretions which have not already been adverted to, appear for the most part to have for their object the performance of some special function *in* the system, rather than the conveyance *out* of it of any substances which it would be injurious to retain. This is the case, for example, in regard to the secretion of the Lachrymal, Salivary, and Mammary Glands, as well as with that of the Mucous and Serous Membranes. The Excretion of fluid from the cutaneous surface, however, appears to answer two important purposes,—the removal from the body of a portion of its superfluous fluid,—and the regulation of its temperature. Just as, by the action of the Lungs, the conditions are supplied, by which the temperature of the body is kept up to a certain standard, so, by that of the Skin, it is prevented from rising too high; for by the continual excretion from its surface, of fluid which has to be carried off by evaporation, a degree of cold is generated, which keeps the calorific processes in check; and this excretion is augmented, in proportion to the elevation of the external temperature, which seems, in fact, the direct stimulus to the process.—In all forms of *true* Secretion, the selection of the materials to be separated from the blood, is accomplished, like selective Absorption, by the agency of *cells*. These are developed in the interior of the secreting organ; and when they are distended with the fluid they have imbibed, their term of life appears to have expired, so that they burst or liquefy, yielding their contents to the ducts, by which the secreted product is conveyed away. In the case of Adipose tissue, we have an instance in which the secreted product (separated from the blood by the cells of which this tissue essentially consists) is not carried out of the body, but remains to form a constituent part of it.—The regulation of the amount of fluid in the vessels, is provided in a kind of *safety-valve* structure, which has been lately shown to exist in the Kidneys. This readily permits the escape of aqueous *fluid* from the capillary vessels, into the urinary canals, by a process altogether distinct from the secretion of the *solid* matter, which it is the office of the kidneys to separate from the circulating fluid. Hence, if the excretion of fluid from the skin be checked by cold, so that an accumulation would take place in the vessels, the increased pressure within them causes an increased escape of water through the kidneys. The relation between the true process of Secretion, which is performed by the selective power of cells, and that of simple Transudation, is the same as that which has been already pointed out, between Selective Absorption and simple Imbibition (§ 271).

279. There is no sufficient reason to believe, that the Nervous System has any more direct influence on the process of Secretion, than it has been stated to have on that of Nutrition. That almost every secretion in the body is affected by states of mind, which must operate through the nerves, daily experience teaches; but the very remarkable degree of control, which the Nervous system possesses over the Circulation, appears sufficient to explain any of these effects, whether they be local or general. The flow of the secreted fluids through their efferent ducts, seems to be principally caused by

the proper contractility of these, which (like that of the heart and alimentary canal) is directly stimulated by the contact of their contents; but there is also evidence that this contractility may be affected (as it is in those two instances) by the nervous system; and thus we have an additional means of influence, by which the nervous system can operate on these processes, since its power is probably not confined to the large ducts, but extends to their ultimate ramifications. Where, as happens in the case of the urinary excretion, there is a reservoir into which it is received as fast as it is formed, for the purpose of preventing the inconvenience which its constant passage from the body would otherwise occasion,—the power of emptying this reservoir is usually placed in some degree under the dominion of the will, although chiefly governed by reflex action. It is obvious that such a provision is by no means essential to the function; and that it has for its object the adaptation, merely, of that function, to the conditions of Animal existence.

280. Thus we see that, when we enter, as it were, into the *penetralia* of the Animal system, and study those processes, of which the development and maintenance of the material fabric essentially consist, we find them performed under conditions essentially the same as those which obtain in Plants; and we observe that the operations of the Nervous System have none but an indirect influence or control over them. It is, therefore, quite philosophical to distinguish these Organic Functions, or phenomena of Vegetative Life, from those concerned in the Life of Relation, or Animal Life. The distinction is, indeed, of great practical importance, and lies at the foundation of all Physiological Science; yet it is seldom accurately made, and a very confused notion on the subject is generally prevalent. It is commonly said, for example, that the function of Respiration is the connecting link between the two:—the fact being, however, that the *true* process of Respiration is no more a function of Animal life, than is any ordinary process of secretion; but that, in order to secure the constant interchange of air, which is necessary to its performance, the assistance of the nervous and muscular systems is called in, though not in a manner which necessarily involves either *consciousness* or *will*.

281. The process of Reproduction, like that of Nutrition, has been until recently involved in great obscurity; and although it cannot be said to be yet fully elucidated, it has been brought, by late investigations, far more within our comprehension, than was formerly deemed possible. The close connection between the Reproductive and Nutritive operations, both as regards their respective characters, and their dependence upon one another, has long been recognized; and it is now rendered still more evident. Nutrition has not been unaptly designated “a perpetual reproduction;” and the expression is strictly correct. In the fully-formed organism, the supply of alimentary material to every part of the fabric, enables it to produce a tissue resembling itself; thus we only find true bone produced in continuity with bone, nerve with nerve, muscle with muscle, and so on. Hence it would appear that, when a group of cells has once taken on a particular *kind* of development, it continues to reproduce itself on the same plan. But in the Reproductive process it is different. A single cell is generated by certain preliminary actions,—from which single cell, all those which subsequently compose the embryonic structures, take their origin; and it is not until a later period, that any distinction of parts can be traced, in the mass of vesicles which spring from it. Hence the essential character of the process of Reproduction consists in the formation of a cell, which can give origin to others, from which again others spring;—and in the capability of these last to undergo *several* kinds of transformation, so as ultimately to produce a fabric, in which the number of different parts is equal to that of the functions to be performed, every separate part

having a purpose distinct from that of the rest. Such a fabric is considered as a very *heterogeneous* one; and is eminently distinguished from those *homogeneous* organisms, in which every part is but a repetition of the rest. Of all Animals, Man possesses, as already shown, the greatest variety of endowments,—the greatest number of distinct organs; and yet Man, in common with the simplest Animal or Plant, takes his origin in a single cell. It is in the almost homogeneous fabrics of the Cellular Plants, that we find the closest connection between the function of Nutrition, and that of Reproduction; for every one of the vesicles which compose their fabric, is endowed with the power of generating others similar to itself; and these may either extend the parent structure, or separate into new and distinct organisms. Hence it is scarcely possible to draw a line, in these cases, between the Nutrition of the individual, and the Reproduction of the species.

282. But, it will be inquired, how and where in the Human body (and in the higher Animals in general) is this embryonic vesicle produced, and what are the relative offices of the two sexes in its formation? This is a question which must still be answered with some degree of doubt; and yet observed phenomena, if explained by the aid of analogy, seem to lead to a very direct conclusion. The embryonic vesicle itself, like other cells, must arise from a germ; and reasons will be hereafter given for the belief, that the germ is supplied by the male parent, and that the female supplies only the materials for its development. Here, as in the Nutritive processes, we find that the operations immediately concerned in this function,—namely, the act of fecundation, and the development of the ovum,—are not directly influenced in any way by the nervous system; and that the functions of Animal Life are called into play, only in the preliminary and concluding steps of the process. In many of the lower Animals, there is no sexual congress, even where the concurrence of two sets of organs (as in the Phanerogamic Plants) is necessary for the process; the ova are liberated by one, and the spermatozoa by the other; and the accidental meeting of the two produces the desired result. In many Animals higher in the scale, the impulse which brings the sexes together is of a purely instinctive kind. But in Man, it is of a very compound nature. The instinctive propensity, unless unduly strong, is controlled and guided by the will, and serves (like the feelings of hunger and thirst) as a stimulus to the reasoning processes, by which the means of gratifying it are obtained; and a moral sentiment or affection of a much higher kind is closely connected with it, which acts as an additional incitement. Those movements, however, which are most closely connected with the essential part of the process, are, like those of deglutition, respiration, &c., simply reflex and involuntary in their character; and thus we have another proof of the constancy of the principle, that, where the action of the apparatus of Animal Life is brought into near connection with the Organic functions, it is not such as requires the operation of the purely animal powers,—sensation and volition. Thus, then, as it has been lucidly remarked, “the Nervous System lives and grows within an Animal, as a parasitic Plant does in a Vegetable; with its life and growth, certain sensations and mental acts, varying in the different classes of Animals, are connected by nature in a manner altogether inscrutable to man; but the objects of the existence of Animals require, that these mental acts should exert a powerful controlling influence over all the textures and organs of which they are composed.”

3. *Functions of Animal Life.*

283. The existence of *consciousness*, by which the individual (*le moi*, in the language of French physiologists) becomes *sensible* of impressions made

upon its bodily structure,—and the power of *spontaneously* exciting contractions in its tissues, by which evident motions are produced,—have been already stated to be the peculiar attributes of the beings composing the Animal kingdom. The evident motions exhibited by some Plants, cannot be regarded as indicating the existence of any psychical endowments in the beings included in the Vegetable kingdom; for they are usually to be referred without difficulty to the action, either direct or indirect, of an external stimulus, upon a contractile tissue; and even where no such action *evidently* takes place, there is good reason to suppose its existence. To refer, therefore, the movements of Vegetables to a Nervous system, of which no traces can be found,—still more to suppose them endowed with consciousness and will, as some have done,—is to violate most grossly a well-known rule in philosophy, which cannot be too steadily kept in view in prosecuting physiological inquiries—*non fingere hypotheses*.

284. There are in Animals, however, many movements which are equally dependent upon direct stimuli for their production; such are (as we have seen), even in the highest, the actions of the heart and of the alimentary canal. These, in the lowest tribes, probably bear a much greater proportion to the whole amount of those exhibited by the beings, than they do in the higher; whilst those, which we may regard as specially dependent upon a nervous system, appear to constitute but a small part of their general vital actions. The life of such beings, therefore, bears a much closer resemblance to that of the Vegetable, than to that of the higher Animal. Their organic functions are performed with scarcely more of sensible movement, than is seen in plants; and of the motions which they do exhibit (nearly all of them *immediately* concerned in the maintenance of the organic functions), it is probable that many are the result of the simple contractility of their tissues, called into action by the stimuli directly applied to them. It is scarcely possible to imagine that such beings can enjoy any of those higher mental powers, which Man recognizes by observation on himself, and of which he discerns the manifestations in those tribes, which, from their nearer relation to himself, he regards as more elevated in the scale of existence.—If we direct our attention on the other hand, to the *psychical** operations of Man, as forming part of his general vital actions, we perceive that the proportion is completely reversed. So far from his organic life exhibiting a predominance, it appears entirely subordinate to his animal functions, and seems destined only to afford the conditions for their performance. If we could imagine his nervous and muscular systems to be isolated from the remainder of his corporeal structure, and endowed in themselves with the power of retaining their integrity and activity, we should have all that is essential to our idea of Man. But, as at present constituted, these organs are dependent, for the maintenance of their integrity and functional activity, upon the nutritive apparatus; and the whole object of the latter appears to be the supply of those conditions, which are necessary to the exercise of the peculiarly *animal* functions. That his mental activity should be thus made dependent upon the due supply of his bodily wants, is a part of the general scheme of his probationary existence; and the first excitement of his intellectual powers is in a great degree dependent upon this arrangement.

285. The most simple or elementary function of the Nervous System is, as already observed, the establishment of a communication between a part which is susceptible of impressions, and another which can perform contractile move-

* Here and elsewhere this term will be employed in its most extended sense, to designate all the mental operations,—whether intellectual, emotional or instinctive,—of which Man's nervous system is the instrument.

ments ; so that a stimulus applied to one may immediately excite a respondent action in the other, however great may be its distance. Hence it may be said to have an *internuncial* function ; but this, so far as it is performed without the necessary participation of the consciousness or will of the individual, is not essentially higher in character, than the corresponding function in Plants, although the latter is affected by a different apparatus. The ministration of the nervous system to purely Animal life, obviously consists in its rendering the mind cognizant of that which is taking place around, and in enabling it to act upon the material world, by the instruments with which the body is provided for the purpose. It is important to observe, that every method at present known, by which Mind can act upon Mind, requires muscular contraction as its medium, and sensation as its recipient. This is the case, for example, not only in that communication which takes place by language, whether written or spoken ; but in the look, the touch, the gesture, which are so frequently more expressive than any words can be ; and thus we trace the limitation, which, even in communication that appears so far removed from the material world, constantly bounds the operations of the most powerful intellect, and the highest flights of the imagination. That in a future state of being, the communion of mind with mind will be more intimate, and that Man will be admitted into more immediate converse with his Maker, appears to be alike the teaching of the most comprehensive Philosophical inquiries, and the most direct Revelation of the Divinity.

286. The Organs of Sense are instruments, which are adapted to enable particular nerves to receive impressions from without ; of a kind, and in a degree, of which they would not otherwise be sensible. Thus, although the simple contact of a hard body with the nerve may be readily conceived to produce a material change in it, of such a kind as would be easily propagated to the central sensorium, it is evident that a nerve must be peculiarly modified, to receive and conduct sonorous impressions from the undulations of the air ; still more—to be susceptible of the impressions produced by those undulations, to which most Natural Philosophers now attribute the transmission of light. And, even when this difficulty has been provided for, by some modification in the structure of the nerve itself, there is evidently another still remaining,—that of understanding how distinct images of the form, colour, &c., of external objects can be communicated to the nerve of sight ; or ideas of the direction, pitch, quality, &c., of sonorous undulations, can be obtained through the auditory nerve. There is reason to believe that many among the lower Animals, which do not *see* objects around them, are conscious of the influence of light ; and thus the distinction between the mere reception of the impression, and the communication of the optical image, becomes evident. The former may take place through the intervention of nerves, whose sensory extremities offer no peculiarities : the latter can only be received through the medium of an instrument, which shall, from the mixture of rays falling equally upon every part of a surface, produce an optical image, and then impress it upon the expanded surface of the nerve ; so that each fibril may receive a distinct impression, the image presented to the mind being formed by the combination of the whole. That this is, in fact, the share which the organs of special sense bear in the general endowments of the whole apparatus, may be inferred especially from the conformation of the Eye ; which is in every respect a merely *optical* instrument, of the greatest beauty and perfection, adapted to present to the nerve, in the most advantageous manner, the images of surrounding objects in all their variations. And we might conceive that, if it were possible for the interior of the living eye to be replaced by one constructed of inorganic materials by the hand of man, without destroying the functional power of the retina, the sense of sight would be but

little impaired,—except through the incapability, on the part of any piece of human mechanism, to imitate those wondrous contrivances of Infinite Skill, which have for their object the adaptation of the instrument to varieties of distance, of intensity of light, &c. There can be little doubt, that the structure of the Ear is arranged to do the same for the sonorous vibrations, which the eye does for the rays of light; that is, through its means, the undulations which strike upon the external surface of the organ are separated and distinguished, those of a like kind being brought together upon one division of the nerve, and those of another order upon a different set of fibres; so that the different kinds of sound, and the peculiar quality and direction of each, may be discriminated; whilst, by the concentration of all the impressions of the same character, a higher amount of force is given to them. Of the sense of Smell, no similar account can be given; since the medium by which odours are propagated is not known. If, as is generally believed, this is accomplished by the diffusion through space, of minute particles of the odoriferous body itself (which supposition seems to derive support from the general fact, that the most volatile substances are usually most odoriferous), smell may be regarded,—as taste also is probably to be considered,—in the light of a refined kind of touch.

287. Thus, the general rule holds good, here as elsewhere, that the processes, by which the organism is *immediately* brought into relation with the external world, are performed in obedience to physical laws; the living structure only affording certain peculiar conditions, which may be imitated in a great degree by other means. This is the case, for example, with regard to Digestion, which is in itself a simply Chemical process, that will take place out of the body as well as in it, if the materials and the necessary solvent be submitted to the same circumstances, as those to which they are exposed in the stomach; and in regard also to the act of Respiration, which depends upon the physical tendency to mutual diffusion, inseparable from the existence of gases; and we notice the prevalence of the same general fact in the Animal as in the Organic functions. We cannot become cognizant of the changes, or even of the existence, of the external world, unless some material effect be produced by it on our organs of sense; nor can we produce any alteration in its condition, except by powers which act according to purely mechanical principles.

288. In regard to the Muscular System, it has already been sufficiently explained, that it forms a part of the apparatus of Animal life, no otherwise than as the instrument by which nervous energy operates upon external objects. The contractility which it manifests on the application of a stimulus, is an endowment which it derives from its own structure, and not from the nervous system; for it will be clearly proved in its appropriate place, that the presence of this contractility is connected with the healthy nutrition of the tissue, and with its due supply of arterial blood; and that the complete separation of any muscular part from all its nervous connections, has none but an indirect influence on its properties.

CHAPTER V.

FUNCTIONS OF THE NERVOUS SYSTEM.

1. *General Summary.*

289. OUR fundamental idea of a Nervous System includes a central organ or *ganglion*, essentially composed of *vesicles* or *cells*, with a plexus of capillary vessels distributed amongst these; and a set of trunks and ramifying branches, composed of tubular fibres, and connecting the ganglion with different parts of the fabric. These branches are for the most part distributed, on the one hand, to the sensory surfaces and organs; and, on the other, to the muscles or motor organs. The former serve for the conveyance of impressions, made upon the periphery, towards the centre; and they may thence be denominated *afferent* fibres.* The latter, on the other hand, serve to convey an influence, originating in the central ganglion, to the muscles, which are thereby thrown into contraction; and these are distinguished as *efferent* or *motor* fibres. Although the distinctness of these two sets of fibres has only been proved in the Vertebrata, yet there can be no reasonable doubt of its universality. Now this fundamental idea of a Nervous apparatus, which is based upon what are believed to be the relative offices of its several component parts (as formerly explained § 248), is found to be exactly realized in the simple forms of that system, which we find in the lowest animals in which Nervous structure can be discovered at all; and even where the apparatus has, to all appearance, a character of much greater complexity, it may still be reduced to the same simple idea, by taking it to pieces (so to speak) and examining its component parts. For it will then be found, that the multiplication of ganglia and trunks is principally due to the multiplication of the organs to be supplied; as in the case of the nervous ring of the Star-fish, where the ganglia,—all of them apparently identical in function, and similar in the distribution of their branches,—are repeated in conformity with the number of the radiating parts of the body; or in the case of the ventral nervous cord of an Articulated animal, in which the ganglia are in like manner repeated longitudinally, in accordance with the number of segments of the body, and of the pairs of members connected with them. In other instances, the multiplication of ganglia is due to the increased complexity of the functions performed by a set of organs; of this we shall see numerous examples in the higher Vertebrata. In all cases, the individual ganglia remain to a great extent independent of each other; so that the removal of any one (if it can be accomplished without injury to the rest) affects only the particular organ with which it may be connected, and the special function of that organ to which alone it ministers.

290. Before proceeding to inquire into the operations of the Nervous System as a whole, it is desirable that we should stop to consider the conditions

* Such are commonly denominated *sensory* fibres; but this designation is objectionable, in as much as many of them serve to excite reflex actions, without necessarily producing sensations.

on which its functional activity is dependent.—The chief of these, is a constant supply of oxygenated blood; which is more necessary for the maintenance of the Nervous power, than it is for that of any other tissue whatever. This supply is peculiarly required at those points at which changes *originate*; not being, it would appear, so necessary for the mere *conduction* of impressions. Consequently we find that the greatest supply of blood is afforded to the nervous centres, and to the peripheral extremities or origins of the afferent nerves; and that the effects of any interruption to the supply are manifested in an immediate and most striking manner. Thus, if the circulation through the Brain be suspended but for an instant, insensibility and loss of voluntary power supervene, and continue until it is restored. This was shown by the following experiment of Sir A. Cooper's. After having tied both carotid arteries in a dog, he compressed the Vertebral trunks; and immediate insensibility came on, the animal at the same time falling powerless. But convulsive movements occurred at the same time; showing that the functions of the spinal cord were not suspended, but only deranged. As soon as the blood was re-admitted to the brain, the animal recovered its consciousness and voluntary power, and stood on its legs again; the convulsive movements ceased at the same time.—In Syncope, the circulation through the Spinal cord is weakened, by the failure of the heart's action, to the same extent as the flow of blood through the Brain; and a general cessation, not merely of muscular movement, but of all power of exciting it, is the immediate result. No sooner, however, is the circulation fully re-established, than the power of the Nervous centres is restored.—Again, the influence of diminished circulation, at the origins of the afferent nerves, is shown in the deficient impressibility of the nerves, at the part affected. Thus, if the movement of blood through the capillaries of a limb be stagnated,—whether by pressure on the arterial trunks, by cold, or by any other cause,—it is at once made apparent by the numbness of the surface; and a complete stagnation produces complete insensibility. The power of receiving impressions, that are to excite reflex movements, is diminished in the same degree.

291. On the other hand it is found, that increased circulation through the same parts, is attended with an exaltation of their function. This is particularly noticed in those affections of the brain and spinal cord, closely bordering on inflammation, to which the terms *active congestion* and *determination of blood* have been applied. We have, in such cases, extreme acuteness of sensation, excessive activity of the mental functions, or violent excitement of the motor powers; according (it would seem) to the particular division of the nervous centres most affected. Again, we find that an increase in the circulation through any organ, from which afferent nerves arise, increases their readiness to receive impressions; thus the sensibility of the genital organs of animals during the period of heat, and of those of man in a state of venereal excitement, are greatly augmented; and the tendency of impressions, made upon them, to excite reflex movements, is similarly exalted.

292. The due activity of the Nervous System is not merely dependent upon a constant and ample supply of Blood; but it requires that this blood should be in a state of extreme purity, and more especially that it should contain a due supply of oxygen, and should be depurated of its carbonic acid, and of other products of the decomposition of the body. The final cessation of nervous power, in death by Asphyxia, is partly due (as will be shown hereafter, Chap. XIII., Sect. 3), to a positive deficiency in the supply of blood; but the obtuseness of sensibility which gradually increases until a state of unconsciousness comes on, may be clearly traced in the first instance to the deficient aeration of the blood, which is gradually deprived of its oxygen, and charged with more and more carbonic acid. Corresponding but less severe

symptoms occur, when the excretion of carbonic acid is not checked, but only slightly impeded; provided the impediment be in operation for a sufficient length of time, as in the case of an ill-ventilated apartment; an indisposition to mental exertion, a deficiency of muscular power, and an obtuseness of the intellectual and moral faculties, being the general result.—These facts are readily explained upon the hypothesis (which seems now to have a sufficiently wide foundation, to be entitled to rank as physiological truth, although no very direct proof of it can be given), that the *functional activity of the nervous system is mainly dependent upon the combination of the oxygen supplied by the blood, with its elements*; the production of the nervous force, whatever be its nature, being a result of this change of composition. The chief grounds for this doctrine will now be enumerated.

293. In the first place, the dependence of nervous energy upon the constant circulation of blood through the tissue, is much more close and immediate than can be accounted for on the idea that the relation is one of mere nutrition or development. On the contrary, where these last changes are taking place most actively, we often find rather a disposition to stagnation of the current, to give time for the elaboration of the nutrient materials that are to be withdrawn from it; and in no case does the process so instantaneously cease, when the flow is suspended. From this it would appear, that some combination takes place between the elements of the nervous tissue, and some material supplied by the blood; which is much more rapid in its character, than the process of cell-development; and which is essentially concerned in the production and maintenance of the active condition of the nervous system.—Again, that the material supplied by the blood for this purpose is Oxygen, would appear from a variety of considerations. A general survey of the Animal kingdom shows, that oxygen is essential to the maintenance of *animal* life, as distinct from *vegetative*; and a more particular comparison of different tribes demonstrates most unequivocally, that the consumption of oxygen is in direct relation to the development of the animal powers in each. These facts harmonize completely with what has been just stated, respecting the effects of a suspension of the oxygenating process.

294. Further, in proof that the activity of the Nervous system is immediately dependent, not upon a process of development or nutrition, but upon one of disintegration or destruction, it may be urged, that it is impossible for this state of activity to be maintained, in a large portion of it, without an interval of repose, which we know to be favourable to the vegetative or reparative processes. There are certain parts of the Nervous System, particularly those that put in action the respiratory muscles, which are in a state of unceasing though moderate activity; and in these, the constant nutrition is sufficient to repair the effects of the constant decay. But those parts which operate in a more powerful and energetic manner, and which are therefore more rapidly disintegrated when in action, need a season of rest for their repair. Hence the sense of fatigue which is experienced when the mind has been long acting through its instrument,—the Brain; and the irresistible tendency to sleep, which usually supervenes after any unusual exertion of this kind. In the healthy state of the body, when the exercise of the nervous system by day does not exceed that which the repose of the night may compensate, the Nervous System is maintained in a condition which fits it for constant moderate exercise; but unusual demands upon its powers,—whether by long-continued and severe exercise of the intellect, by excitement of the emotions, or by the combination of both, in that state of *anxiety* which the circumstances of man's condition too frequently induce,—occasion an unusual waste, and require a prolonged repose and uninterrupted nutrition, for the complete restoration of its powers. There can be no doubt that (from causes which

are not known) the amount of sleep required by different persons, for the maintenance of a healthy condition of the Nervous System, varies considerably; some being able to dispense with it to a degree which would be exceedingly injurious to other individuals, who do not surpass them in mental activity. Where a prolonged exertion of the mind has been made, and the natural tendency to sleep has been habitually resisted, by a strong effort of the will, injurious results are sure to follow. The bodily health breaks down; and too frequently the mind itself is permanently enfeebled. It is obvious that the Nutrition of the Nervous System becomes completely deranged; and that the tissue is no longer formed in a manner requisite for the discharge of its healthy functions. The same may be said of the state of Mania; in which there is, for a time, an extraordinary degree of activity (though manifested in an irregular manner) of the cerebral functions, and an absence of disposition to sleep. Such a state may continue for some time; but the subsequent exhaustion of nervous power is proportioned to the duration of the excitement, and frequent attacks of mania almost invariably subside at last into imbecility.

295. Additional evidence for the belief that the functional activity of the Nervous tissue involves disintegration of its tissue by the agency of Oxygen, is found in the increase of *phosphatic* deposits in the urine,—and especially of those having alkaline bases,—when there has been any unusual demand upon the nervous power. No others of the soft tissues contain any large amount of phosphorus; and the marked increase in these deposits, which has been continually observed to accompany long-continued *wear* of mind, whether by intellectual exertion, or by the excitement of the feelings,—and which follows any temporary strain upon its powers, can scarcely be set down to any other cause. The most satisfactory proof is to be found in cases, in which there is a periodical demand upon the mental powers; as, for example, among Clergymen, in the preparation for and discharge of their Sunday duties. This is found to be almost invariably followed by the appearance of a large quantity of the alkaline phosphates in the urine. And in cases in which constant and severe intellectual exertion has impaired the nutrition of the brain, and has consequently weakened the mental power, it is found that any premature attempt to renew the activity of its exercise, causes the re-appearance of the excessive phosphatic discharge indicative of an undue waste of nervous matter.*

296. There is not the same evidence of constant change, however, in regard to the *fibrous* element of the Nervous System; and its conducting power appears to be much less dependent upon the supply of blood, than is the originating power of the vesicular matter. It remains, with little decrease, for some time after death; especially in cold-blooded animals; for we can, by pinching, pricking, or otherwise stimulating the motor trunks, give rise to contractions in the muscles supplied by them, exactly as during life. Its earlier departure in warm-blooded animals, may be partly due to the cooling of the body.

297. Of the actual nature of the changes by which impressions are received upon the peripheral origins of the afferent nerves, or are communicated to the

* A large amount of evidence confirmatory of the above views, and showing the importance of carefully distinguishing between the *alkaline* and *earthy* phosphates, has been adduced by Dr. Bence Jones, in a Paper lately read to the Royal Society. The quantity of the *latter*, which is present in the urine, is found to bear a constant relation to that which is contained in the food. On the other hand, the amount of the former varies with different conditions of the nervous system, in such a manner as to warrant the inference that its production is a result of the disintegration of nervous matter; being due to the union of the phosphoric acid thus set free, with alkaline bases present in the blood in a state of feeble combination.

central origins of the motor, and by which they are conducted along each to their opposite extremities, Physiologists have no certain knowledge. That they are Electrical in their character, has been, and still continues to be, a favourite theory with some; and the idea seems to derive support from the marked degree in which Electricity, transmitted along the Nervous trunks, can excite the changes to which those nerves are ordinarily subservient. Thus, a feeble galvanic current, transmitted along the motor nerves of an animal recently killed, will call the muscles supplied by it into contraction; whilst, on the other hand, a similar current transmitted along an afferent nerve, shall excite reflex movements through its ganglionic centre. Further, if the current be transmitted along an afferent nerve, in a living animal, it will excite sensations which are referred to the part whence the nerve arises; and, as will be shown hereafter (Chap. VI., Sect. 1), Electricity is capable of thus producing sensations of a *special* kind, as well as those of a *general* nature. Moreover, in the instantaneousness of the transmission of Nervous agency from one part of the system to another, there is more analogy to Electricity, than to any other known force. But these and similar arguments do not prove the *identity* of Nervous agency with Electricity; since the effects of the former may be imitated to a certain extent, not merely by Electricity, but by mechanical and chemical stimulation of various kinds. Further, there are powerful arguments *against* such a supposition, the validity of which cannot be easily set aside. All attempts to prove the existence of an Electric current, in a Nervous trunk that is actively engaged in conveying motor influence, have completely failed, though made with the greatest precaution. Thus, Matteucci has lately experimented upon the very large crural nerve of a Horse, which was caused, by stimulating its roots, to throw the muscles of the leg into violent contraction; nevertheless, although he used instruments of such delicacy, as to be capable of detecting an infinitesimally-small disturbance of the electric equilibrium, no such disturbance was apparent. Further, it is well known that the conducting power of the nerves is destroyed, not merely by dividing the trunk, but also by putting a ligature round it; which last operation does not diminish its powers as a conductor of Electricity. Moreover, the various fibrils are not as completely insulated from each other in regard to Electricity, as we know them to be with respect to nervous agency; for the first of these forces, when transmitted along a nervous trunk, cannot be restricted to any fibre or fasciculus of fibres, but spreads through the entire trunk, and even to the neighbouring parts in which it is imbedded; whilst the latter is continually restricted to a small portion of the trunk, as is manifested by its results. Again, if a small piece of nervous trunk be cut out, and be replaced by an electric conductor, electricity will still pass along the nerve; but no nervous force, excited by stimulus above the section, will be propagated through the conductor to the parts below. And lastly, the conducting power of Nerve for Electricity is stated by Matteucci to be not more than one-fourth that of Muscle; whilst Messrs. Todd and Bowman give it as the result of their experiments, that both Nerve and Muscle are both *infinitely worse* conductors than copper; their power of conduction not ranking above that of water holding in solution a small quantity of saline matter.

a. Although, for the sake of convenience, Electricity and Nervous power are spoken of, here and elsewhere, as actual *entities* or *agents*, traveling along the wires or cords that conduct them, it must not be forgotten that the present tendency of scientific inquiry leads us to abandon such an idea, in the former case at least; what is commonly termed the *transmission* of electricity being the result of a *molecular change*, instantaneously occurring along the whole length of the conducting body, in virtue of a disturbance, in the *polar* arrangement of its particles, at one extremity, which causes a similar disturbance to manifest itself at the other. Thus if

ab ab ab ab ab ab ab ab ab

represent the arrangement of the particles, in the condition of equilibrium or quiescence, and this condition be disturbed at one extremity, by the operation of a new attraction upon the first particle *a*, a new arrangement will instantaneously take place throughout: this may be represented by

a ba ba ba ba ba ba ba b

which shows *b* in a free state at the opposite end, ready to exert its influence upon anything submitted to it. It is probable that in this respect there is an analogy between the Nervous and electrical forces; and that, instead of speaking of the "transmission of nervous influence" along a nerve, we should describe the change as the production of a "polar state" in the nervous trunk; as first pointed out by Messrs. Todd and Bowman (Physiological Anatomy, vol. i. p. 240).

298. Every fibre, there is reason to believe, runs a distinct course between the central organ, in which it loses itself at one extremity, and the muscle or organ of sense in which it terminates at the other. Each Nervous Trunk is made up of several fasciculi of these fibres; and each fasciculus is composed of a large number of the ultimate fibres themselves. Although the fasciculi occasionally intermix and exchange fibres with one another (as occurs in what is termed a *plexus*), the fibres themselves never inosculate. Each fibre would seem, therefore, to have its appropriate office, which it cannot share with another. The objects of a plexus are twofold. In some instances it serves to intermix fibres, which have endowments fundamentally different: for example, the Spinal Accessory nerve, at its origin, appears to be exclusively motor, and the roots of the Par Vagum are as exclusively afferent; but by the early admixture of these, a large number of motor fibres are imparted to the Par Vagum, and are distributed in variable proportion, with its different branches; whilst few of its sensory filaments seem to enter the Spinal Accessory.—In other instances, the object of a plexus appears to be, to give a more advantageous distribution to fibres, which all possess corresponding endowments. Thus the Brachial plexus mixes together the fibres arising from five segments of the spinal cord, and sends off five principal trunks to supply the arm. Now if each of these trunks had arisen by itself, from a distinct segment of the spinal cord, so that the parts on which it is distributed had only a single connection with the nervous centres, they would have been much more liable to paralysis than at present. By means of the plexus, every part is supplied with fibres arising from each segment of the spinal cord; and the functions of the whole must therefore be suspended, before complete paralysis of any part can occur, from a cause which operates above the plexus. Such a view is borne out by direct experiment; for it has been ascertained by Panizza that, in Frogs, whose crural plexus is much less complicated than that of Mammalia, section of the roots of one of the three nerves which enter into it, produces little effect on the general movements of the limb; and that, even when two are divided, there is no paralysis of any of its actions, all being weakened in a nearly similar degree.—It is not unlikely also that, by this arrangement, a *consentaneousness* of action is in some degree favoured, as is supposed by Sir C. Bell; for comparative anatomy shows that something resembling it may be traced, wherever a similar purpose has to be attained. Thus, in the Hymenoptera, there is a similar interlacement between the nerves of the anterior and posterior pairs of wings, which act very powerfully together; whilst in the Coleoptera, in which the anterior wings are converted into elytra, and are motionless during flight, the nerves supplying each pair run their course distinctly. In the Octopus, or Poulp, again, the trunks which radiate from the cephalic mass to the eight large arms surrounding the head, are connected by a circular band; forming a kind of plexus, which seems to contribute to the very powerful and harmonious movements of the arms of this Cephalopod.

299. The following statements, in which the language of Müller is adopted

with some modification, embody the general principles ascertained by experiment, respecting the transmission of sensory and motor impressions. Their *rationale* will be at once understood, from the facts already mentioned in regard to the isolated characters of each fibril, and the identity of its endowments through its whole course. 1. When the whole trunk of a sensory nerve is irritated, a sensation is produced, which is referred by the mind to the parts to which its branches are ultimately distributed; and if only part of the trunk be irritated, the sensation will be referred to those parts only, which are supplied by the fibrils it contains.—This is evidently caused by the production of a change in the sensorium, corresponding with that which would have been transmitted from the peripheral origins of the nerves, had the impression been made upon them. Such a change only requires the integrity of the afferent trunk, between the point irritated and the sensorium; and is not at all dependent upon the state of the extremity, to which the sensations are referred: for this may have been paralyzed by the division of the nerve; or altogether separated, as in amputation; or the relative position of its parts may have been changed.—It results from the foregoing, that, when different parts of the thickness of the same trunk are separately subjected to irritation, the sensations are successively referred to the several parts supplied by these divisions. This may be easily shown by compressing the ulnar nerve, in different directions, where it passes at the inner side of the elbow-joint.

ii. The sensation produced by irritation of a branch of the nerve, is confined to the parts to which that branch is distributed, and does not affect the branches which come off from the nerve higher up. The rationale of this law is at once understood: but it should be mentioned that there are certain conditions, in which the irritation of a single nerve will give rise to sensations over a great extent of the body. This seems due, however, to a particular state of the central organs; and not to any direct communication among the sensory fibres.

iii. The motor influence is propagated only in a centrifugal direction, never in a retrograde course. It may originate in a spontaneous change in the central organs: or it may be excited by an impression conveyed to them through afferent nerves; but in both cases its law is the same.

iv. When the whole trunk of a motor nerve is irritated, all the muscles which it supplies are caused to contract: but when only a part of the trunk or a branch is irritated, the contraction is confined to the muscles, which receive their nervous fibres from it. This contraction evidently results from the similarity between the effect of an artificial stimulus applied to the trunk in its course, and that of the change in the central organs by which the motor influence is ordinarily propagated. In this instance, as in the other, there is no lateral communication between the fibrils.

300. Various methods of determining the functions of particular nerves present themselves to the Physiological inquirer. One source of evidence is drawn from their anatomical distribution. For example, if a nervous trunk is found to lose itself entirely in the substance of *muscles*, it may be inferred to be chiefly, if not entirely, *motor* or *afferent*. In this manner, Willis long ago determined that the third, fourth, sixth, portio dura of the seventh, and ninth cranial nerves, are almost entirely subservient to muscular movement; and the same had been observed of the fibres proceeding from the small root of the fifth pair, before Sir C. Bell experimentally determined the double function of that division of the nerve, into which alone it enters. Again, where a nerve passes through the muscles, with little or no ramification among them, and proceeds to a *cutaneous* or *mucous* surface, on which its branches are minutely distributed, there is equal reason to believe that it is of a *sensory*, or rather of an *afferent*, character. In this manner Willis came to the con-

clusion, that the fifth pair of cranial nerves differs from those previously mentioned, in being partly sensory. Further, where a nerve is *entirely* distributed upon a surface adapted to receive impressions of a *special* kind,—as the Schneiderian membrane, the retina, or the membrane lining the internal ear,—it may be inferred that it is not capable of transmitting any other kind of impressions; for experiment has shown, that the *special sensory* nerves do not possess common sensibility. The case is different, however, in regard to the sense of taste, which originates in impressions not far removed from those of ordinary touch; and it is probable that the same nerves minister to both.—Anatomical evidence of this kind is valuable also, not only in reference to the functions of a principal trunk, but even as to those of its several branches, which, in some instances, differ considerably. Thus, some of the branches of the Par Vagus are especially motor, and others almost exclusively afferent; and anatomical examination, carefully prosecuted, not only assigns the reasons for these functions, when ascertained, but is in itself nearly sufficient to determine them. Thus the superior laryngeal branch is distributed almost entirely upon the mucous surface of the larynx, the only muscle it supplies being the cricothyroid; whilst the inferior laryngeal or recurrent is almost exclusively distributed to the muscles. From this we should infer, that the former is an afferent, and the latter a motor nerve; and experimental inquiries (hereafter to be detailed) fully confirm this view. In like manner it may be shown, that the Glosso-pharyngeal is chiefly an afferent nerve, since it is distributed to the *surface* of the tongue and pharynx, and scarcely at all to the muscles of those parts; whilst the pharyngeal branches of the Par Vagus are chiefly if not entirely, motor. Lower down, however, the branches of the glosso-pharyngeal cease, and the œsophageal branches of the par vagum are distributed both to the mucous surface and to the muscles; from which it may be inferred that they are both afferent and motor—a deduction which experiment confirms.

301. We perceive, therefore, that much knowledge of the function of a nerve may be obtained, from the attentive study of its ultimate distribution: but it is necessary that this should be very carefully ascertained, before it is made to serve as the foundation for physiological inferences. As an example of former errors in this respect, may be mentioned the description of the Portio Dura of the seventh, at first given by Sir C. Bell: he stated it to be distributed to the skin as well as to the muscles of the face, and evidently regarded it as in part an afferent nerve, subservient to respiratory impressions as well as to motions. In the same manner, from inaccurate observation of the ultimate distribution of the Superior Laryngeal nerve, it was long regarded as that which stimulated to action the constrictors of the glottis.—But the knowledge obtained by such anatomical examinations alone is of a very general kind; and requires to be made particular,—to be corrected and modified by other sources of information. One of these relates to the connection of the trunks with the central organs. The evidence derived from this source, however, is seldom of a very definite character; and, in fact, the functions of particular divisions of the nervous centres have rather been hitherto judged of, by those of the nerves with which they are connected, than afforded aid in the determination of the latter. Still, this kind of examination is not without its use, when there is reason to believe that a particular tract of fibrous structure has a certain function, and when the office of a nerve whose roots terminate in it is doubtful. Here again, however, very minute and accurate examination is necessary, before any sound physiological inferences can be drawn from facts of this description; and many instances might be adduced to show, that the real connections of nerves and nervous centres are often very different from their apparent ones.

302. Experimental inquiries into the functions of particular nerves are also

liable to give fallacious results, unless they are prosecuted with a full knowledge of all the precautions necessary to insure success. Some of these will be here explained. Suppose that, upon irritating the trunk of a nerve, whilst still in connection with its centre, muscular movements are excited; it must not be hence concluded that the nerve is an efferent one, for it may have no *directly* motor powers. The next step would be to divide the trunk, and to irritate each of the cut extremities. If, upon irritating the end *separated* from the centre, muscular contractions are produced, it may be safely inferred that the nerve is, in part at least, of an *efferent* character. Should no such result follow, this would be doubtful. If, on the other hand, muscular movement should be produced by irritating the extremity *in connexion with* the centre, it will then be evident, that it is occasioned by an impression conveyed *towards* the centre by *this* trunk, and propagated to the muscles by some other; in other words, to use the language of Dr. M. Hall, this nerve is an excitor of motion, not a direct motor nerve. The glosso-pharyngeal nerve has been satisfactorily determined to be chiefly, if not entirely, an efferent nerve, by experiments of this kind, performed by Dr. J. Reid.

303. It has been from the want of a proper mode of experimenting, that the functions of the *posterior* roots of the Spinal nerves have been regarded as in any degree motor. If they be irritated, without division of either root, motions are often excited; but if they be divided, and their separated trunks be then irritated, no motions ensue; nor are any movements produced by irritation of the roots in connexion with the spinal cord, if the *anterior* roots have been divided. Hence it appears that the motor powers of these fibres are not direct, but that they convey an impression to the centre, which is reflected to the muscles through the anterior roots. Another source of fallacy is to be guarded against, arising from the communication to a nerve, in its course, of properties it did not possess at its root, by inosculation with another nerve. Of this many instances will hereafter present themselves.

304. The same difficulties do not attend the determination of the *sensory* properties of nerves. If, when the trunk of a nerve be pricked or pinched, the animal exhibits signs of pain, it may be concluded that the nerve is sensible to ordinary impressions at its peripheral extremity. But not unfrequently this sensibility is derived by inosculation with another nerve; as is the case with the portio dura, which is sensory after it has passed through the parotid gland, having received there a twig from the fifth pair. A similar inosculation explains the apparent sensibility of the *anterior* roots of the spinal nerves. If these be irritated, the animal usually gives signs of uneasiness; but if they be divided, and the cut ends nearest the centre be irritated, none such are exhibited; whilst they are still shown, when the farther ends are irritated, but not if the posterior roots are divided. This seems to indicate that, from the point of junction of the two roots, sensory fibres derived from the posterior root pass backwards (or towards the centre) in the anterior; and thus its apparent sensory endowments are entirely dependent upon its connexion with the posterior column of the spinal cord, through the posterior roots.

305. The fallacies to which all experiments upon the nerves are subject, arising from the partial loss of their powers of receiving and conveying impressions, and of exciting the muscles to action, after death, are too obvious to require particular mention here; yet they are frequently overlooked. Of a similar description are those arising from severe disturbance of the system, in consequence of operations; which also have not been enough regarded by experimenters.

306. All our positive knowledge of the functions of the Nervous System in general, save that which results from our own consciousness of what passes

within ourselves, and that which we obtain from watching the manifestations of disease in Man, is derived from observation of the phenomena exhibited by animals made the subjects of experiments; and it is desirable to preface our general summary of the results of these, by some remarks upon the inferences to be drawn from them.—In the first place it must be constantly borne in mind that, except through the *movements* consequent upon them, we have no means of ascertaining, whether or not particular changes in the Nervous System, whose character we are endeavoring to determine, are attended with Sensation; since we have no power of judging whether or not this has been excited, save by the cries and struggles of the animal made the subject of experiment. Now although such cries and struggles are ordinarily considered as indications of pain, yet it is not right so to regard them in every instance; and the only unequivocal evidence is derived from observation of the corresponding phenomena in the Human subject; since we can there ascertain, by the direct testimony of the individual affected, what impressions produce sensation, and what excite movements independently of sensation. Further, we are not justified in assuming that consciousness is excited by an irritation,—still less that the intelligence and will are called into exercise by it,—merely because movements, evidently tending to get rid of this, are performed in response to it. We know that the contractions of the heart and alimentary tube are ordinarily excited by a stimulus, without any sensation being involved; and these movements, like all that are concerned in the maintenance of the Organic functions, have an obvious design, when considered either in their immediate effects, or in their more remote consequences. The character of *adaptiveness*, then, in Muscular movements excited by external stimuli, is no proof that they are performed in obedience to sensation; much less, that they have a voluntary character. In no case is this adaptiveness more remarkable, than in some of those actions, which are not only performed without any effort of the will, but which the will cannot imitate. This is the case, for example, with the act of Deglutition; the muscles concerned in which cannot be thrown into contraction by a voluntary impulse, being stimulated only by impressions conveyed from the mucous surface of the fauces to the medulla oblongata, and thence reflected along the motor nerves. No one can swallow without producing an impression of some kind upon this surface, to which the muscular movements will immediately respond. Now it is impossible to conceive any movements more perfectly adapted to a given purpose than those of the parts in question; and yet they are independent, not only of Volition, but of Sensation,—being still performed in cases in which consciousness is completely suspended, or entirely absent.

307. There is much difficulty, then, in ascertaining the really elementary functions of the Nervous System, by experiments upon animals; and it is only when their results are corrected and explained by pathological observation on Man,—the sole case in which we can obtain satisfactory evidence of the presence or absence of sensation,—that they have much value to the physiological inquirer. From these combined sources, however, a vast amount of knowledge of the functions of the nervous system has recently been gained; and the general purposes to which it is subservient, may be advantageously stated in a systematic form, before we enter upon any detailed examination of them.

1. The Nervous System receives impressions, which, being conveyed by its *afferent* fibres to the Sensorium, are there communicated to the conscious Mind, and thus give origin to Sensations. The Nervous structure is further subservient, in some way, to the acts of that mind; as the result of which, a motor impulse is transmitted along the *efferent* trunks, to particular Muscles,

exciting them to contraction. There is reason to believe, however, that this motor impulse may proceed from at least two distinct sources; being either the direct consequence of the sensation, acting involuntarily as an *emotional* or *instinctive* impulse; or resulting from a more or less complicated series of intellectual operations, which terminate in an act of *volition* or will.—To these functions, taken collectively, the Encephalon, and the nerves connected with it, are alone subservient; and we may probably assign the group of simple *consensual* or *involuntary* actions to the ganglia which receive the nervous trunks from the organs of sense, and which make up nearly the whole of the Cephalic masses of ganglia in the Invertebrata; whilst the Cerebral hemispheres of Vertebrata are the instruments of the *intellectual* operations and of the mandates of the *will*.

II. Certain parts of the Nervous System receive impressions which are propagated along *afferent* fibres, that terminate in ganglionic centres distinct from the sensorium; and in these a reflex motor impulse is excited, which, being conveyed along the *efferent* trunks proceeding from them, excites muscular contraction, without any necessary intervention of sensation or volition. Of this function (called by Dr. Hall, to whom the discovery of it is in a great part due, the *reflex* function), we shall find that the portion of the *Spinal Cord* of Vertebrata, which is not continuous with the fibrous structure of the brain, together with the portion of the nervous trunks which are connected with it alone, is the instrument: whilst, in the Invertebrata, the same office is performed by ganglia still more obviously disconnected from the cephalic mass.

III. Another division of the Nervous System appears to have for its object, to combine and harmonize the muscular movements immediately connected with the maintenance of Organic life; and to bring these into relation with certain conditions of the mind. There is reason to believe (though this is less certain) that it also influences, and brings into connection with each other, the processes of Nutrition, Secretion, &c.; though these, like the muscular movements just mentioned, are essentially independent of it. This portion of the nervous apparatus is commonly known under the name of the *Sympathetic* system.

308. Now, in reference to the first of these classes of operations, it is well to explain that though the Physiologist speaks of the intellectual powers, moral feelings, &c., as *functions* of the Nervous System, they are not so in the sense in which the term is employed in regard to other operations of the bodily frame. In general, by the *function* of an organ, we understand some change which may be made evident to the senses; as well in our own system, as in the body of another. Sensation, Thought, Emotion, and Volition, however, are changes imperceptible to our senses, by any means of observation we at present possess. We are cognizant of them in ourselves, without the intervention of those processes by which we observe material changes external to our minds; but we judge of them in others, only by inferences founded on the actions to which they give rise, when compared with our own. When we speak of sensation, thought, emotion or volition, therefore, as functions of the Nervous System, we mean only that this system furnishes the conditions under which they take place in the living body; and we leave the question entirely open, whether the $\Psi\chi\eta$ has or has not an existence independent of that of the material organism, by which it operates in Man, as he is at present constituted.

309. In regard to the second class of actions, it may be remarked, that they are nearly all connected, more or less closely, with the maintenance of the Organic functions, or with the protection of the body from danger. Thus the movements of the pharynx supply to the stomach the alimentary materi-

als, which it has to prepare for the nutrition of the body; and those of the muscles of the thorax, &c., maintain that constant interchange of air in the lungs, which is necessary for the aeration of the blood: whilst those, by which a limb is involuntarily retracted from any cause of pain or irritation, are obviously adapted to the latter of these two ends.

2. *Comparative Anatomy and Physiology of the Nervous System in Invertebrated Animals.*

310. Although the structure and distribution of the Nervous System in the different classes of Animals have been, until recently, but little appealed to in the determination of its functions, they are capable of supplying evidence regarding some of these, not less important in its character than that which Comparative Anatomy affords to other departments of Physiology. Some of the principal of these contributions will now be pointed out.

311. In the lowest tribes of the RADIATED division of the animal kingdom, no Nervous System has yet been discovered. These have, therefore, been separated by some naturalists into a new primary group, to which the designation of *Acruta* has been given, on account of the (supposed) "*indistinct, diffused, or molecular character of their nervous system.*" This idea of a "*diffused nervous system*" seems to be regarded by many—Physiologists as well as Naturalists—as the necessary alternative, resulting from the want of any definite indications of its presence. It may be said, however, to be based on very erroneous notions, as to the true offices of the nervous apparatus. Its influence is not required to endow the tissues with *contractility*; a property possessed in a high degree by the structures of many Plants, to which these beings present a much greater *general* resemblance, than they bear to the higher Animals; and, even in the latter (as will be shown hereafter), this property is independent of nervous agency, although generally called into exercise by it. That a nervous system is not required by them for the performance of the functions of Nutrition and Reproduction, otherwise than to supply, by its locomotive actions, the conditions of those functions, would also appear from its absence in Plants. It is on the sensible movements of these beings, that our belief in their possession of a nervous system must be founded, when we cannot render it cognizable by our senses. But we must be careful not to draw hasty inferences from such phenomena. Sensible movements are, as we have seen, performed by the *Dionæa* and Sensitive plant, in response to external stimuli acting on distant organs; and they are also exhibited, in a very remarkable manner, by the reproductive particles of many of the simpler Plants, as well as by numerous beings now generally referred to the Vegetable kingdom. It is to be remarked, however, that such motions are of a very simple description. In objects of the latter class, they are of a rhythmical character, and do not seem to be in direct dependence on any external influences. And even where they are performed solely in response to external stimuli, there is usually such a uniformity in their character, as indicates that the means by which the influence is propagated are of a very mechanical nature. On the other hand, those movements of Polypes, which are performed in response to external stimuli, are of a much more varied character; and there are others, which seem to indicate a certain degree of voluntary power, and therefore to display a consciousness of impressions made upon the body. These phenomena, then, would lead us to suspect the existence of a Nervous System in the beings which exhibit them; not, however, in a "*diffused*" condition, but in the form of connected filaments. For, what consentaneousness of action can be looked for in a being whose nervous matter is incorporated in the state of isolated globules with its tissues? How

should an impression made on one part be propagated by these to a distance? And how can that consciousness and will, which are *one* in each individual, exist in so many unconnected particles? If, then, we allow any sensibility, consciousness, and voluntary power, to the beings of this group of *Acerita*—to deny which would be in effect to exclude them from the Animal Kingdom—we must regard these faculties as associated with nervous filaments, of such delicacy as to elude our means of research. When the general softness of the textures, and the laxity of structure that characterizes the nervous fibres, in the lowest animals in which they *can* be traced, are kept in view, little difficulty need be felt in accounting for their apparent absence. The case is very different from that of Vegetable structure; the greater consistency of which enables us to place much more reliance upon the negative evidence afforded by anatomical research.

312. The correctness of this view (which has been here dwelt on the longer, because it involves a fundamental question in Nervous Physiology), is borne out by the fact, that, in those members of the group whose size and consistency allow their structures to be sufficiently examined, a definite nervous system has been detected; in the position which it might, *à priori*, be expected to occupy, according to the type of the individual. Thus, in the large fleshy isolated polype, commonly known as the Sea-Anemone (*Actinia*), a nervous ring has been discovered, surrounding the mouth as in other Radiata, and sending off branches to the tentacula, with a minute ganglionic enlargement at the base of each. In the higher Radiata, as the *Star-Fish*, the nervous system has the same regular form as that which prevails through the other organs. The mouth is surrounded by a filamentous ring, which presents a regular series of ganglionic enlargements, one of them corresponding with each segment of the body. From every one of these, a branch is transmitted to the corresponding ray; and two smaller ones proceed to the viscera included in the central disk.

313. The POLYPIFERA being the lowest of the Radiated classes, in which there is a regularly-organized digestive apparatus, and which perform movements of a character ascribable only to a Nervous System, it will be desirable to inquire a little more particularly into the phenomena they exhibit, and the degree in which these necessarily involve the possession of the higher mental endowments. In this inquiry we shall refer principally to the little *Hydra*, or fresh-water Polype; the habits of which are better known than those of any other species. Although no nervous filaments have been detected in this, we have a right to infer their presence for the reasons already given; and they probably form a ring around the mouth, as in the *Actinia*, sending filaments to the tentacula. This interesting little being may be regarded as essentially a *stomach*; and the orifice of this is provided with tentacula, which contract when irritated by the touch of any adjacent body, and endeavour to draw it towards the entrance. Now, the action in the Human body, to which this is most allied, is evidently that of the muscles of Deglutition; which lay hold, as it were, of the food that has been conveyed to the fauces, and carry it into the stomach. These muscles are called into action, not by an effort of the will, but by the contact of the food with the lining membrane of the pharynx. This *impression* is propagated by the glosso-pharyngeal nerve to the medulla oblongata, where a respondent motor impulse is excited, which is transmitted through the pharyngeal branches of the par vagum to the muscles of deglutition, and causes their contraction. This phenomenon will be more fully examined hereafter; it is here adduced simply as an instance of the important class of *reflex* movements, which are independent of the brain (though, to a certain extent, controlled by it), which are altogether involuntary, and which do not *necessarily* involve the produc-

tion of sensation. There would appear to be little difference in the character of this movement, between the simple Hydra and the most perfect Vertebrated animal. In the latter, however, another set of muscles are superadded to these, for the purpose of preparing the aliment by mastication for the operation of the stomach, and of bringing it within reach of the pharyngeal constriction.—But, it has been urged, the inactivity of the tentacula when the Hydra is gorged with food, proves that they are excited to action by the will of the animal. This inference, however, may be easily disproved. The muscles of deglutition in Man are not called into action with nearly the same readiness and energy, when the stomach is distended, as when it is empty; a fact of which any one may convince himself, by observing the relative facility of swallowing, at the commencement and the termination of a full meal. No one will assert that *this* variation is an effect of the will; indeed, it is often opposed to it; being one of those beautiful adaptations, by which the welfare of the economy is provided for, but which the indulgence of the sensual appetites opposes. Most of the movements of this animal, and of others of the class, appear to be equally the result of external stimuli, with that already described; and it is only in a few instances, principally those of absolute locomotion or change of place, that any evidence of *voluntary* action can be discerned. It may be occasionally remarked, however, that one or more of the tentacula are retracted or extended, without the slightest appreciable change in any of those external circumstances, which seem ordinarily to affect the motions of the animal; and this action we can scarcely regard as otherwise than voluntary.

314. Thus in the Nervous System of Radiated Animals, we have an instance of that community of function, which is so remarkable in the organism of the lower tribes, when contrasted with the separation, which is perceptible in those at the opposite extremity of the scale. The visceral nerves of the Asterias are not isolated at their central terminations from those which are connected with the sensorial and locomotive functions: nor are the nerves which minister to the instinctive actions separable from those which convey the influence of the will. Every segment of the body appears equal in its character and endowments to the remainder; each has a ganglion appropriated to it; and, as the ganglia, like the segments, are all alike, neither of them can be regarded as having any *presiding* character.

315. From the Radiated we now pass to the MOLLUSCOUS classes; the general character of which, as a natural group, is the remarkable predominance of the Nutritive system over that of Animal life. There is not in the Mollusca, as in the Radiata, any repetition of parts around a common centre; and we do not therefore meet in them with a number of ganglia, nearly or altogether alike in endowments. In some of the higher species, there is a conformity between the two sides of the body, or a lateral symmetry; which involves a subdivision of some of the ganglia, that are single in the inferior tribes, into two masses, which always remain in connexion with each other. With this exception, it may be observed, that all the principal ganglia, to the number of four or five, which we meet with in the higher Mollusca, appear to have distinct functions; as may be determined by tracing the distribution of their nerves. Thus we find a pair of *cephalic ganglia*, situated above the œsophagus, connected with the organs of special sensation, and sending motor nerves (as we shall see reason to believe) to all parts of the body. This is obviously analogous to the brain of Vertebrata. Below the œsophagus there is generally a small ganglion, connected with the apparatus of deglutition, which may be called the *stomato-gastric* ganglion. In connexion with the gills we have always one ganglion, sometimes a pair, which may be termed the *branchial* ganglion. Another is found at the base of the foot, which may

be called the *pedal* ganglion. And there is sometimes another, which especially supplies the mantle with nerves; and this may be called the *palteal* ganglion.—The distribution of their nerves to the different organs, would alone indicate the respective functions of these ganglia; but these are placed beyond doubt, by that very great variety in the disposition of these organs, which is characteristic of the Mollusca. The development of the sensory organs, the situation of the gills, the structure and position of the foot, the conformation and uses of the mantle, are well known to differ in the most obvious manner, in genera which are closely allied to each other. Hence the anatomist is enabled, by the discovery of corresponding changes in the nervous system, to satisfy himself of the particular functions of its different centres.*

316. It is only in the higher tribes, however, that this separation of function is evident; for in the lowest, we find the Nervous System in its least developed form. This is the case in the class TUNICATA; composed of animals, in which the whole body is enclosed in a tunic or bag, having two orifices, through one of which the water is drawn in by ciliary action, whilst through the other it is expelled. This bag incloses a large chamber, the lining of which is devoted to the respiratory function; and at the bottom of it lies the mass of the viscera, on which is the entrance to the stomach. A part of the water which is taken into the respiratory chamber flows into this, and passes through the intestinal canal; being discharged along with that, which has only served the purpose of aerating the blood. These animals have no power of motion, but such as is effected by the general contraction of the respiratory sac; this is effected by a single ganglion placed between its orifices, which is therefore chiefly a *branchial* ganglion, and is the only nervous centre they possess. The trunks connected with it send branches over the muscular envelope of the respiratory sac, and to the sphincters which surround its orifices; whilst other branches proceed to the membrane lining the orifices, and especially to the tentacula, or lips, which are situated at the oral entrance. The maintenance of the regular current is effected, as just stated, by ciliary action; but when any substance is being drawn in, the entrance of which would be injurious, its contact with the tentacula excites a general contraction of the muscular envelope, and causes a jet of water to issue from one or both orifices, which carries the offending body to a distance. And, in the same manner, if the exterior of the body be touched, the mantle suddenly and violently contracts, and expels the contents of the sac.—These are the chief, if not the only actions, which the Nervous System of these animals is destined to perform; and they are evidently of a *reflex* character; bearing a close correspondence with the acts of coughing and sneezing in Man, which are in like manner destined to expel injurious substances from the respiratory passages. By the contact of such substances with the tentacula that guard the oral orifice, or with the lining of the respiratory sac, or by irritation of the external surface of the body, an impression is produced on the *afferent* fibres; which, being conveyed to the central ganglion, excites there a reflex motor impulse; and the propagation of this impulse along the *afferent* fibres, to the muscular fibres of the contractile sac, and to the sphincters, produces the movements in question.

317. In the CONCHIFERA, or Mollusks inhabiting *bivalve* shells, there are invariably two ganglia, having different functions. The larger of these (Fig. 124, *e*), corresponding to the single ganglion of the Tunicata, is situated towards the posterior end of the body (that is, the end most distant from the mouth),

* See Mr. Garner on the Nervous System of the Mollusca, in the Linnæan Transactions, Vol. XVII.

in the neighbourhood of the posterior adductor muscle; and its branches are distributed to that muscle, to the mantle, to the gills, and to the siphons through which the water is introduced and carried off. But we find another ganglion, or rather pair of ganglia, *a*, *a*, situated near the front of the body, either upon the œsophagus, or at its sides; these ganglia are connected with the very sensitive tentacula which guard the mouth; and they may be regarded as presenting the first approach, both in position and functions, to the brain of higher animals. In the *Oyster*, and others of the lower *Conchifera* which have no foot,—which is a muscular tongue-like organ,—we find an additional ganglion (*b*) connected with it.—This is the case in the *Solen*, or animal of the *Razor-shell*; whose foot is a very powerful boring instrument, enabling it to penetrate deeply into the sand. Here, then, we have three distinct kinds of ganglionic centres; every one of which may be doubled, or repeated on the two sides of the body. *First*, the *cephalic* ganglia, *a*, *a*, which are probably the sole instruments of sensation and of consensual movements; as well as of whatever *voluntary* power the animal may possess: these are almost invariably double, being connected together by a transverse band, which arches over the œsophagus. *Second*, the *pedal* ganglion, *b*, which is usually single, in conformity with the single character of the organ it supplies; but in one very rare Bivalve Mollusk, the foot is double, and the pedal ganglion is double also.—*Third*, the *respiratory* ganglion, *c*, which frequently presents a form that indicates a partial division into two halves, corresponding with the repetition of the organs it supplies, on the two sides of the body. Besides these principal centres, we meet with numerous smaller ones upon the nervous cords (*f*, *f*, and *g*, *g*), which proceed from them to the different parts of the general muscular envelope or mantle.

318. Now it will be observed, that the two cephalic ganglia *a*, *a*, are connected with the pedal ganglion, *b*, by means of a pair of trunks, *e*, proceeding from the former to the latter; and that they are, in like manner, separately connected with the respiratory or branchial ganglion *c*. It is found, upon

Fig. 124.

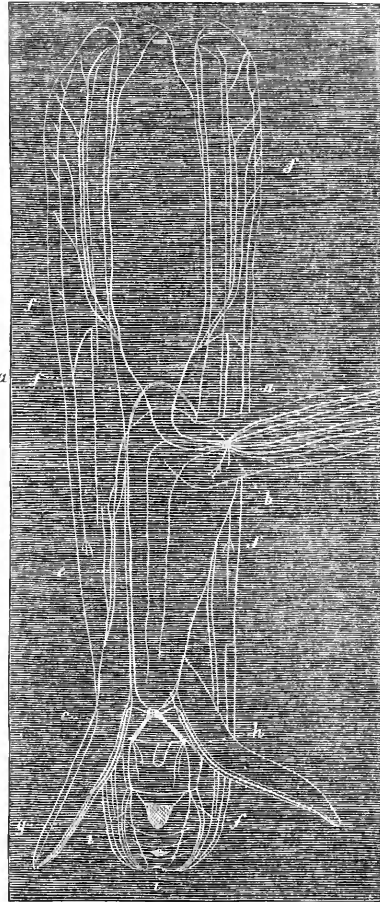

Nervous system of *Solen*; *a*, *a*, cephalic ganglia, connected by a transverse band passing over the œsophagus; *b*, pedal ganglion, the branches of which are distributed to the powerful muscular foot; *c*, branchial ganglion, the branches of which proceed to the gills *g*, the siphons *i*, *i*, and other parts; *h*, anus; *e*, trunks connecting cephalic and branchial ganglia; *f*, *f*, *f*, *f*, minute ganglia on the branches distributed to the mantle.

careful dissection, that these cords do not serve merely to bring the ganglia into relation: but that a part of them pass *through* the ganglion into the trunks proceeding from it. Thus, of the nerves which supply the large fleshy foot, and which appear to proceed from the pedal ganglion, *b*, a part are undoubtedly connected with that ganglion alone, coming into relation with its vesicular substance; but a part also pass on to the cephalic ganglia, by the connecting trunks,—so that *these*, rather than the pedal ganglion, constitute their centre. The same may be said of the nerves proceeding from the branchial ganglion: a portion of them having their centre in the vesicular matter of that ganglion; whilst another portion has no relation to it whatever (beyond that of proximity), but passes through or over it, to become connected with the cephalic ganglia. There is good reason to believe, that the *pedal* and *branchial* ganglia minister to the purely *reflex* actions of the organs they respectively supply; and that they would serve this purpose as well, if altogether cut off from connection with the cephalic ganglia: whilst the latter, being the instruments of the actions which are called forth by sensation (whether these be of a *consensual* or of a *voluntary* nature), exert a general control and direction over the movements of the animal.

319. The animals of the class *GASTEROPODA*, whether furnished with *uni-valve* shells, or entirely destitute of such protection, are, for the most part, much more highly organized than the preceding; possessing not merely greater locomotive power, but organs of special sense, which are situated in the neighbourhood of the mouth, upon a projecting part of the body, which is thus constituted a *head*. Their nervous system consists of at least *three* distinct centres; the relative position of which varies with that of the organs supplied by them. The *anterior* or *cephalic* ganglia are larger in proportion to the rest, than they are in the *Conchifera*; and they exhibit a tendency to gain a position anterior to the œsophagus, and to approximate towards each other, so as to meet and form a single ganglionic mass on the median line. The *branchial* ganglion is constantly to be met with; but its position is extremely variable. This centre, however, always bears a close relation with the gills, both in situation and in degree of development; and even where conjoined, as it frequently is, with the pedal ganglion, it may be distinguished from it by the distribution of its nerves, as well as by its separate connection with the cephalic ganglia, which is always noticed in such cases. This may be observed in the *Patella* (limpet) and *Limax* (slug). Sometimes the functions of this ganglion are subdivided between two; of which one is still appropriated to the branchiæ; whilst the other is connected with the general surface of the mantle, and with the respiratory passages which are prolongations of it, and hence may be called the *palleal* ganglion. The position of the *pedal* ganglion (which is generally double in the *Gasteropoda*, though the foot is single), also varies, but in a less degree, since it is generally in the neighbourhood of the head.—Besides these nervous centres, we find, in many of the *Gasteropoda*, a separate system connected with a very important set of organs, the gustatory and manducatory, which are but slightly shadowed out among the *Conchifera*. In these higher tribes, the œsophagus is dilated at its commencement into a muscular cavity (Fig. 3, *a*); containing a curious rasp-like tongue, often supported upon cartilages, which serves to reduce the food; and sometimes furnished with horny maxillæ. The nerves which supply these do not proceed directly from the cephalic ganglia, but from a distinct centre; and their ramifications proceed along the œsophagus and stomach, and are occasionally connected with the other nerves by inosculating filaments. This set of ganglia and nerves, which is even more important from its relative development in some other classes, and into the analogies of

which in the nervous system of Vertebrata we shall hereafter inquire, may be called, from its distribution, the *stomato-gastric* system.

320. The ganglia first described may be regarded as corresponding with those parts of the nervous centres in the Vertebrata, the distribution of whose nerves is analogous. Thus the *branchial* ganglion obviously corresponds with that portion of the Medulla Oblongata which is the centre of their respiratory actions; and the *pedal* ganglion is analogous to that division of the Spinal Cord from which the nerves of the anterior or posterior extremities pass off. It is well known that such portions of the spinal cord may be completely isolated, without destroying the functions to which they minister. Thus, the brain and lower part of the spinal cord may be removed,—that portion only of the cerebro-spinal axis being left, which is connected with the principal respiratory nerves, in fact the *respiratory ganglion*,—and yet the animal may continue to exist for some time. It is then reduced to a condition similar to that of the Tunicata; whose single ganglion, though combining in some degree the functions of those which exist separately in the higher tribes, has evidently the regulation of the respiratory movements for its chief object. In the same manner, the integrity of the segment of the cord, with which the nerves of the extremities are connected, will enable them to execute those movements of a reflex character, which depend upon its power as their centre; even though it be isolated from every other part of the nervous apparatus.—The *cephalic* ganglia must be regarded as chiefly analogous to those portions of the Encephalon of Vertebrata, which are immediately connected with the nerves of sense. We find nerves of special sensation proceeding from them, certainly to eyes and an auditory apparatus, perhaps also to olfactive organs; as well as others of common sensation, supplying the tentacula and mouth. Hence we must admit, that they perform the functions of the optic ganglia of Vertebrata, and perhaps also of the olfactory lobes; as well as of the portion of the medulla oblongata, in which the sensory portion of the fifth pair terminates. Moreover, they certainly give origin also to motor nerves; and must thus perform the functions of the Medulla Oblongata, from which the corresponding nerves arise in Vertebrata; as well as, perhaps, of the Cerebellum.—It is obvious that the portion of the Nervous system of the Gasteropod Mollusca, into the analogies of which we have thus inquired, cannot in the least be compared *as a whole* with the *Sympathetic* system of the Vertebrata, which it was formerly imagined to resemble. The distribution of some of its nerves to the viscera, however, may indicate that it partly performs the functions of that system; with which it is structurally intermixed, even in Vertebrata. But the stomato-gastric system may, perhaps, with more probability, be considered as executing its offices. Into the peculiar character of that system we shall be more competent to inquire when we have traced it through other classes of Invertebrata.

321. Having thus separately considered the nervous centres of the Gasteropoda, and determined their special functions by their structural relations, we shall inquire into the mode in which these functions are combined, so as to enable them to act in harmony. This is an inquiry of much interest, in reference to the determination of the offices of the different parts of the nervous centres in Articulated and Vertebrated animals. If we examine the mode in which the different ganglia are united by connecting trunks, we are led to perceive the important fact, that, while they have little or no communication with each other, they are all directly connected with the cephalic ganglia; which seem thus to harmonize and control their individual actions. Frequently a communication with one another appears to exist, where there is really none. Thus, in the *Aplysia*, a cord passes from the branchial ganglion (Fig. 125, D),

which is situated in the posterior part of the body, to the pedal ganglion of each side, (c, c). Where such is the

Fig. 125.

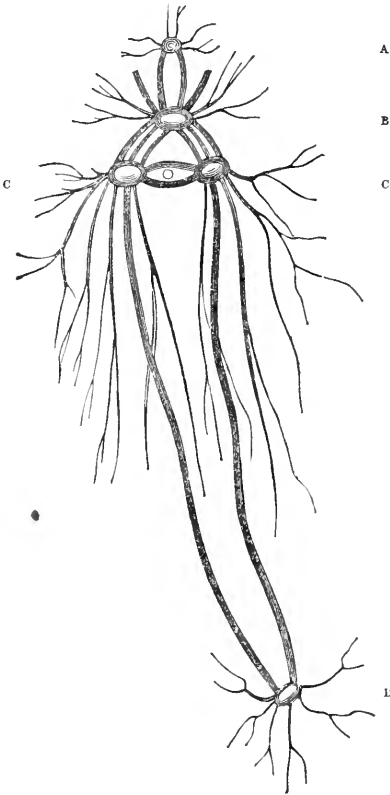

Nervous system of *Aplysia*. A. pharyngeal ganglion; B. cephalic ganglion. The cephalic is connected, by three distinct cords on each side, with the lateral masses, C C, which combine the functions of *pedal* and *palleal* ganglia; these are united with each other by two transverse bands, between which the aorta passes. From the lateral ganglia, a connecting cord passes backwards on each side to the *branchial* ganglion, D; this cord is continuous with one of the three proceeding from the cephalic ganglion.

sions, and of the motor impulses prompted by them.—This is well illustrated in the curious disposition of parts, which we find in the arms of the Cuttle-fish. These are provided, it is well known, with a series of suckers, which are to the animal important instruments of locomotion and prehension. It has been observed by Dr. Sharpey, that the nerves which supply these arms are furnished with ganglionic enlargements, of which one corresponds with each sucker; and that each trunk consists of two tracts, in one of which the ganglionic enlargements exist; whilst the other passes continuously over these, but sends off nervous filaments, which help to form the branches going to the

case, the trunk is not united with that proceeding from the ganglion through which it passes; but the two remain distinct, though running in the same direction. Moreover, the double function of a ganglion may be sometimes recognized, by its being connected with the cephalic mass by a double trunk. Thus, in the *Aplysia*, that which has been termed the *pedal* ganglion is really made up of a *pedal* and *palleal* ganglion, as is proved by the distribution of its branches; and in conformity with this double function, we find it communicating with the cephalic mass by two cords, besides the one which has been just mentioned as passing through it, and which appears as a third. In the *Bullæa*, whose nervous system is disposed on the same general plan, the *pedal* and *palleal* ganglia are separately connected with the cephalic; the cord from the *branchial* ganglion passing through the *palleal*.

322. Further, a careful examination of these ganglia, and of their connecting cords, discloses this important fact, which is peculiarly evident in the case of the *pedal* ganglia—that the cords proceeding from the cephalic mass do not lose themselves in the grey matter of these ganglia; but divide themselves into filaments, which mix with those proceeding from them, to form the nervous trunks which they distribute. We can scarcely, then, fail to infer, that the *pedal* ganglion, with the nervous fibrils proceeding from itself, is the source of the reflex actions of this organ; whilst the filaments which are continuous with those of the connecting trunk, and which are thus connected with the nucleus of the cephalic ganglia, are the channels of *sensory* impres-

several suckers. When the animal endeavours to embrace any object firmly with its arm, it brings all the suckers simultaneously to bear upon it. There can be little doubt that this action is occasioned by a motor impulse, propagated from the cephalic masses by the non-ganglionic portion of the cord, which supplies all the suckers alike. On the other hand, any individual sucker may be made to attach itself, by placing a substance in contact with it alone; this action is independent of the cephalic ganglia, as is evident from the fact, that it will take place when the arm is severed from the body, or even in a small piece of the arm, if recently separated; and it can scarcely be doubted, that it is due to the reflection of the impression made upon the sucker, through the small ganglion in its own neighbourhood, where it excites a motor impulse. The operation of these independent centres appears, in the entire living animal, to be controlled, directed, and combined, by the cephalic ganglia; through the medium of the fibrous band which passes over them, and which mixes its branches with theirs. A very similar arrangement will be presently shown to exist in the double nervous column of the Articulata.

323. Upon reviewing all the anatomical facts hitherto stated, it will be perceived that ganglionic masses, characterized by nuclei of grey matter, or of something equivalent to it, seem to exist, wherever it is desirable that impressions made upon the afferent nerves should excite motions; and that, as we rise in the scale, there is an increase in the number of centres possessing a diversity of functions. We have seen that sometimes these centres are, for the sake of convenient disposition, united into one mass; whilst on the other hand, when the organs are multiplied, they also are repeated to a like extent; especially when it is desirable that they should be able to act independently of one another, as in the case of the suckers of the Cuttle-fish. It may further be remarked, that wherever the presence of special sensory organs, confined to one part of the body, gives to that part a predominance over the remainder (the entrance to the alimentary canal being always in this neighbourhood), we find the ganglia with which they are connected possessing a special relation with all the rest, which these do not possess with each other. It is obvious that, where visual organs are developed, the impressions made upon these will determine the movements of the animal, more than those of any other kind; and it would seem to be chiefly owing to the information they communicate, that the cephalic ganglion has such an evident presiding influence over the rest, even when smaller than any of them. This is, however, more the case in animals whose movements are rapid, and in which, therefore, the perception of distant objects is more important—as in the Insect tribes. Except in the Cephalopoda, the subservience of the nervous system to the nutritive functions of the Mollusca is so great that it might almost be regarded as an appendage to the digestive organs, destined for the selection and prehension of aliment. But in the more active members of that class it derives a more elevated character, from the development of organs of special sensation and of active locomotion.

324. The animals composing the group ARTICULATA all present, in a more or less evident degree, a division into segments, which have an obvious tendency to resemble one another, as in the Radiata; these are disposed, however, not in a circle, as in the Radiata, but in a continuous line. In those in which these segments differ but little (as in the Centipede, or the Caterpillar of the Insect), the nervous system is a repetition of similar parts; the most anterior of the ganglia, however, has an evident predominating influence over the rest, for the reason just specified; and this influence will be found, by comparison in other classes, to diminish with the loss, and to increase with the development, of the faculties of special sensation, which have their seat there. The locomotive powers are just as predominant in the Articulated series, as

Fig. 126.

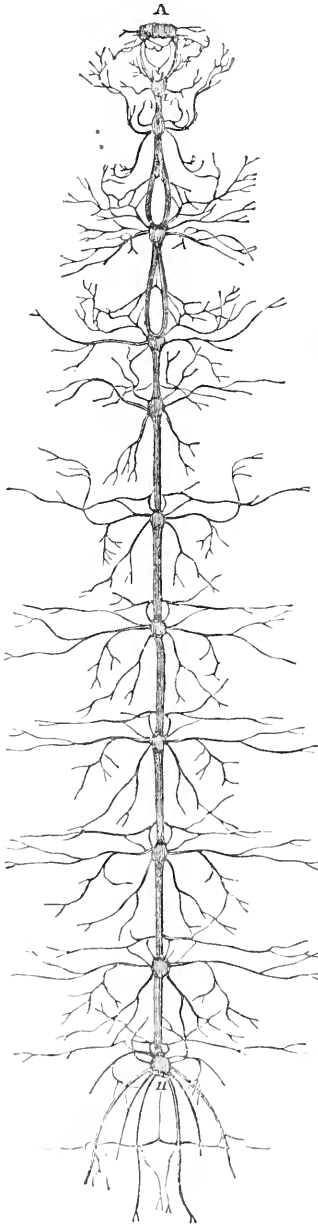

Nervous System of Larva of *Sphinx ligustri*, after Newport; A, cephalic ganglia; 1-11, ganglia of the trunk, disposed at nearly equal distances; the last is formed by the consolidation of the 11th and 12th.

are the nutritive functions among the Mollusca. Accordingly, we find the development of the Nervous system to bear a special reference to them; and the sensori-motor divisions of it can be more distinctly separated, than in the Mollusca, from the portion which ministers to the organic functions.

325. The general arrangement of the Nervous System differs so little, except as to the degree of concentration of the ganglia, in the different classes of this sub-kingdom, that it is of little consequence what example we select. It will be convenient to take for illustration that of the Larva of the *Sphinx ligustri*, or Privet Hawk-Moth, which has been minutely described by Mr. Newport. Here we observe a chain of ganglia running from one extremity of the body to the other, along the ventral surface, and in the median line. These ganglia are connected by trunks, which, on close examination, are seen to consist of two cords closely united. The cephalic ganglion is bilobed; evidently consisting of two masses, which are united on the median line. These receive the nerves of the eyes and antennæ; but they are still of small size, in accordance with the low development of the sensory organs. The ganglia of the longitudinal cord are nearly equal from one extremity of the body to the other. Each sends off nerves to its respective segments; and the branches proceeding from the different ganglia have little communication with each other. The highest of them, situated just beneath the œsophagus, is connected with the cephalic masses by two cords; between which that canal passes, encircled, as it were, in a ring.

326. The most detailed account of the conformation of the Nervous Centres in the Articulata, is that recently given by Mr. Newport, in regard to the *Iulus*, and other animals of the class MYRIAPODA.* Their general arrangement corresponds with that which has been just described in the larvæ of the *Sphinx ligustri*; but the number of ganglia is much greater. In each lateral half of the cord, two distinct tracts or layers of fibres can be detected: of these, one—known as the *fibrous tract*—is continuous with the cephalic ganglia,

* Philosophical Transactions, 1843.

and contains no vesicular matter; whilst the other known as the *ganglionic tract*—has vesicular matter deposited at intervals amongst its fibres, some of which are continuous with the brain, whilst others do not reach it. (Fig. 128, A.) Every nerve that is given off from this ventral column, is connected with *both* tracts; and thus it has two sets of roots, one proceeding to the brain, the other entering the ganglion near which it arises. Of this last division, a part crosses to the opposite side, forming the *commissural* fibres which unite together the lateral halves of the cord; whilst another bundle of fibres runs along the side of the ganglionic tract, for a greater or less proportion of its length, and then emerges again forming part of another nervous trunk. In Fig. 127 is seen Mr. N.'s representation of one of the ventral ganglia, and part of the cord, of *Polydesmus maculatus*; showing the longitudinal and commissural fibres, together with those to which he has given the name of *fibres of reinforcement*. These lateral fibres, which do not pass on to the brain, but issue again from the ventral cord at a point a little distant from their entrance, seem to be more numerous in the hinder part of the body of the Centipede tribe, than in its front portion: and thus it is, that the whole size of the cord remains nearly the same along its entire length; whilst that of the portion which passes backwards from the brain, must be continually diminishing, as it gives off fibres to the nerves.

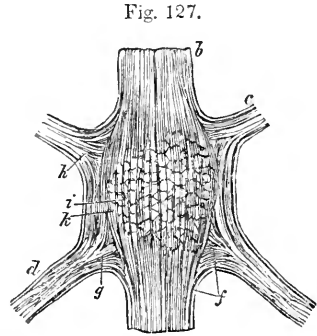

Portion of the ganglionic tract of *Polydesmus maculatus*; *b*, inter-ganglionic cord; *c*, anterior nerves; *d*, posterior nerves; *f*, *k*, fibres of reinforcement; *g*, *h*, commissural fibres; *i*, longitudinal fibres, softened and enlarged, as they pass through ganglionic matter.

327. After what has been said of the offices which the ganglia perform in the Mollusca, and of the relation which they bear to the cephalic mass, we shall have little difficulty in understanding the character of the nervous apparatus in the Articulata, if our minds be unoccupied by any preconceived notion. When we examine into the actions of the ventral cord, we perceive that those of all its ganglia are similar to each other; being related only to the movements of their respective segments, and of the members which belong to them. In fact, these ganglia may be regarded as so many repetitions of the *pedal* or locomotive ganglion of the Mollusca. It is easily proved, that the movements of each pair of feet may be produced by that ganglion alone, with which it is connected; since a single segment, isolated from the rest, will continue to perform these movements for some time, under favourable circumstances. But it is evident that they must be placed, in the living animal, under some general control; by which the consentaneousness of action, that is essential to regular locomotion, may be produced. This is proved by the experiments to be presently quoted. We can scarcely account for the exercise of such a general control, otherwise than by attributing it to the fibrous portion of the cord,* which directly connects each of the nervous

* It is believed by Mr. Newport, that the *fibrous portion of the ganglionic tract*, which lies nearest the surface of the body, may be the channel by which *sensory* impressions are conveyed to the brain; whilst the *fibrous tract* itself may convey downwards the *motor* impulses which originate in the cephalic ganglia. The chief reason for this supposition, is the correspondence in position,—relatively to each other, and to the rest of the body,—between the *fibrous* and *ganglionic* columns in Articulata, and the portions of the Spinal Cord of Vertebrata, from which the *anterior* or *motor* roots, and the *posterior* or *sensory*, respectively arise.—But the fibres which are *peculiar* to the ganglionic tract, obviously form a distinct system.

trunks with the cephalic ganglia, as in the Mollusca; and this must, therefore, conduct to the sensorium (whose seat is probably in the latter) the impressions which there produce sensations, and must convey downwards the locomotive impulse; whilst the ganglion of each segment, with the filaments connected with its nucleus, will form the circle necessary for the simply-reflex actions of its members. The independence of the segments of the Articulata, as far as their reflex actions are concerned, and their common subordination to one presiding centre of the will, are fully explained on this supposition. It is also quite conformable to the analogy, both of Mollusca, and of Vertebrata.

328. The number and variety of the reflex actions, which take place in the Articulata after decapitation, are very remarkable; and they seem to have a consentaneousness, proportioned to the closeness of the relation between the nervous centres in the respective species. Thus, in the Centipede, we find the ganglia of the several segments distinct, but connected by a commissural trunk. Here an impression made *equally* upon the afferent nerves of *all* the ganglia, will produce a consentaneous action. Thus, if the respiratory orifices on one side of a decapitated Centipede be exposed to an irritating vapour, the body will be immediately flexed in the opposite direction; and if the stigmata of the other side be then similarly irritated, a contrary movement will occur. But different actions may be excited in different parts of the cord, by the proper disposition of the irritating cause. In the higher classes, however, where the ganglia of the locomotive organs are much concentrated, the same irritation will produce consentaneous motions in several members, similar to those which the unamputated animal performs. In the *Mantis religiosa*, for example,—which ordinarily places itself in a very curious position, especially when threatened or attacked, resting upon its two posterior pairs of legs, and elevating its thorax with the anterior pair, which are armed with powerful claws,—if the anterior segment of the thorax, with its attached members, be removed, the posterior part of the body will still remain balanced upon the four legs which belong to it, resisting any attempts to overthrow it, recovering its position when disturbed, and performing the same agitated movements of the wings and elytra, as when the unamputated animal is irritated: on the other hand, the detached portion of the thorax, which contains a ganglion, will, when separated from the head, set in motion its long arms, and impress their hooks on the fingers which hold it. These facts prove unequivocally, that the combined automatic movements of these parts, which are performed in direct responsiveness to external expressions, are only dependent for their stimulation upon that ganglionic centre, with which the nerves that excite them are immediately connected. Another instance, related by Burmeister, is still more satisfactory in regard to the manner in which these movements are excited. A specimen of the *Dytiscus Sulcatus*, from which the cephalic ganglia had been removed, and which remained in a motionless condition whilst lying with its abdomen on a dry hard surface, executed the usual swimming motions, when cast into water, with great energy and rapidity, striking all its comrades to one side by its violence, and persisting in this for half an hour.

329. These conclusions are also fully confirmed by the experiments of Mr. Newport, upon various Insects and Myriapoda; the results of which have been recently made public.* The following, upon the *Iulus terrestris*, is particularly interesting. “The cord was divided in the fourteenth, and also the twentieth segment; and the intervening portion was destroyed, by breaking it down with a needle. The animal exhibited in the anterior part

* Philos. Trans., 1813, p. 267.

of its body all the evidences of perfect volition. It moved actively along, turning itself back on either side repeatedly, as if to examine the anterior wounded portion, which it felt again and again with its antennæ: and when attempting to escape, frequently turned back as if in pain and aware of some hindrance to its movements; but it seemed perfectly unconscious of the existence of the posterior part of its body, behind the first incision. In those segments, in which the cord was destroyed, the legs were motionless; while those of the posterior division, behind the second incision, were in constant but involuntary motion, the movements being similar to those of walking or running, uniformly continued, but without any consentaneous action with those of the anterior part, by which locomotion was performed, dragging the posterior divisions of the body after them. When the animal was held by the posterior segments, reflex actions were excited in the legs, and powerful contractions and gyrations of the whole animal were performed in those segments; but these movements appeared to be entirely the result of reflex actions of the muscles, since exactly similar ones took place in the whole body of decapitated specimens. At the expiration of twelve hours, the most perfectly voluntary acts were performed by the head and anterior division of

Fig. 128.

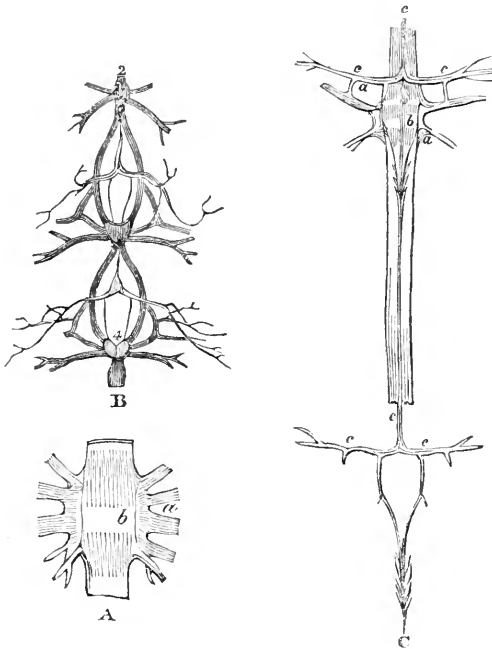

Parts of Nervous System of Articulata. A. single ganglion of *Centipede*, much enlarged, showing the distinctness of the purely fibrous tract, *b*, from the ganglionic column, *a*. B. portion of the double cord from thorax of Pupa of *Sphinx ligustri*, showing the respiratory ganglia and nerves, between the ganglia (2, 3, 4), and the separated cords of the symmetrical system. C. view of two systems combined, showing their arrangement in the Larva; *a*, ganglion of ventral column; *b*, fibrous tract passing over it; *c*, respiratory system of nerves distinct from both.

the body, such as locomotion forwards or to either side, avoidance of any obstacle, touching it with the antennæ, (which were in rapid action, as in an uninjured animal,) and attempting to reach and to climb up an object pre-

sented to it, but not in immediate contact with it. But reflex movements alone existed in the posterior division, in which the legs were very slowly moved, even when the animal was not progressing. Brisk actions were now more easily excited in them than at first, either by contact with the segments, by irritation of one or two of the legs themselves, or by a sudden current of air. By these means, when the animal was lying still, actions were immediately excited in all the legs of the posterior parts of the body, anterior and posterior to those which were irritated; and these actions were induced in those of both sides of the body, but appeared to commence on the opposite side, in the legs corresponding to those which were first irritated. In eighteen hours, the anterior part of the body was quite dead, so that no motions whatever could be excited in it, either voluntary or reflex; but reflex actions were then readily excited in the posterior, and also slightly so by mechanical irritation, even at twenty-four hours." It would appear, then, that we may obtain more decided proof, in the Articulated series, of the real character of *reflex* actions, and of their dependence upon a distinct system of nerves, than we can draw from any other class of animals. In the Vertebrata, it is easy to distinguish the *sensory* from the *motor*—the *afferent* from the *efferent*—fibres; but the distinctness of the excito-motor system from the sensori-volitional, is not so clearly made out. Here, however, the afferent and efferent fibres cannot be readily distinguished; but it is obvious that the *reflex* actions, which manifest themselves when the communication with the cephalic ganglia is cut off, are to be attributed to those fibres, which enter the cord under the *afferent* character,—pass into the edge of the ganglion as the *fibres of reinforcement*, or cross it as *commissural* fibres,—and then emerge again as *efferent* fibres, either in the nerves of the same segment, or in those of another more or less distant. By traversing the cord along a part of its length, and thus placing the several segments in communication with each other, the fibres of reinforcement thus constitute a part of the *longitudinal* filaments of the cord,—the remainder consisting of the fibres continuous with the cephalic ganglia.

330. Hitherto we have spoken only of that division of the nervous system of the Articulata, which may be regarded as corresponding with the sensory and locomotive ganglia of the Mollusca; we have next to inquire what we find corresponding with the branchial ganglion. It is to be recollected, that the respiratory apparatus of Insects is diffused throughout the whole body, so that its presiding system of nerves must be proportionally extended; and we are, therefore, prepared to find the *branchial* ganglion of the Mollusca repeated, like the *pedal*, in each segment. Besides the nervous trunks proceeding from the ventral cord at its ganglionic enlargement, we find, in most of the Articulated classes, a series of smaller nerves, given off at intermediate points, without any apparent swelling at the points of divergence. The connections of these are most distinctly traced in the thoracic region, just as the Larva is passing into the Pupa state; for the cords of the ventral column then diverge, so that an additional tract may be seen which occupies the central line. By a close scrutiny, this tract may be found in the perfect Insect, on the superior or visceral aspect of the cord; and its nerves are given off from minute ganglionic enlargements upon it. It seems to be quite unconnected, along its whole course, with the column upon which it lies. Its nerves, however, communicate with those of the sensori-motor system; but they have a separate distribution, being transmitted especially to the tracheæ, on the parietes of which they ramify minutely, and also to the muscles concerned in the respiratory movements. (The latter, however, being a part of the general locomotive apparatus, are also supplied from the principal ganglionic column.) These nerves, then, which are evidently analogous to those of the gills and siphonic

apparatus in the Mollusca, may be regarded as corresponding with the pneu-
monic portion of the Par Vagus in Vertebrata (which is in like manner dis-
tributed on the air passages), and with its associated motor nerves.

331. In comparing the nervous system of Insects with that of the higher
Mollusca, it will be seen that they differ more in the arrangement and in the
relative proportion of their parts, than in their essential character. In both
there is a Cephalic division of the ganglionic centres, in which sensibility and
psychical power appear to reside more particularly, if not entirely. In both
there is a division specially appropriated to the Locomotive apparatus, differ-
ing only in the multiplication of the centres in Insects, conformably with the
arrangement of the members they supply; and sometimes consolidated to
nearly the same degree. In both, also, we find a division appropriated to the
Respiratory apparatus, in which there is a corresponding multiplicity of
centres in the Articulata, in harmony with the universal distribution of their
tracheal system. And in both, as we shall now see, there is a separate system of nerves, distributed to the
alimentary apparatus, and supplying the organs of mas-
tication (with the salivary glands), of deglutition, and of
digestion.

332. Of the *stomato-gastric* system, some traces may
be found in nearly all the Articulated classes. Thus, in the Leech, we find a minute ganglion existing at the
base of each of the three teeth which form the mouth; these ganglia are connected together, and, to the cephalic
by slender filaments; and they seem also to be in connection with other filaments, which may be traced on the
alimentary canal. As a specimen of its highly-developed form, we shall describe that of the *Gryllotalpa*
vulgaris (Common Mole-Cricket). Here we find it consisting of two divisions; one placed on the median
line, which may hence be called the *median* system; the other running on each side at some little distance,
and hence called the *lateral* system.—The median system appears to originate in a small ganglion, situated an-
teriorly and inferiorly to the cephalic mass, with which it communicates by a connecting branch on each side.
From this ganglion, nerves proceed to the walls of the buccal cavity, the mandibles, &c. Its principal trunk,
however, (the *recurrent* of authors,) is sent backwards beneath the pharynx. The ramifications of this are
distributed along the œsophageal tube and dorsal vessel; whilst the trunk passes downwards to the stomach,
where its branches inosculate with those supplied by the lateral system, and seem to assist in forming a
pair of small ganglia, from which most of the visceral nerves radiate.—The ganglia of the lateral system are
two on each side, lying behind and beneath the cephalic masses. The anterior pair are the largest, and meet on
the median line, just behind the cephalic ganglia, with which they communicate. Posteriorly to these lie the
second pair, which are in connection with them. Two cords pass backwards on each side; one derived from
the anterior, the other from the posterior, of these gan-
glia. They run along the sides of the œsophagus and
dorsal vessel; and, after inosculating with the branches of the central system,

Fig. 129.

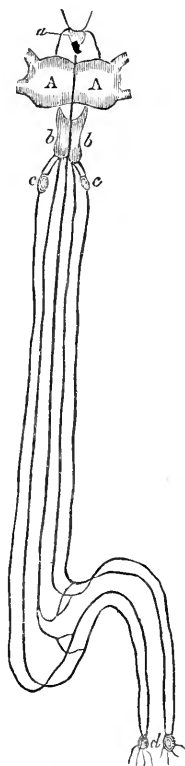

Stomato-gastric system
of *Gryllotalpa vulgaris*;
AA, cephalic ganglia; a,
anterior median ganglion
with the recurrent trunk
passing downwards from
it; bb, and cc, lateral gan-
glia; d, visceral ganglia.

enter the two cœliac ganglia, from which branches radiate to the abdominal viscera.

333. This system of ganglia and nerves has an evident affinity with the *Sympathetic* system of Vertebrata, as well as with some parts of the Cerebro-spinal system, more especially with the Par Vagus. It is to be remembered, that the Pneumogastric nerve of Vertebrata is distributed to three separate systems—the respiratory, the circulating and the digestive. As we know that the ultimate fibrils of nerves never anastomose, there can be no doubt that these branches might be separately traced backwards into their ganglionic centres; and they may thus be regarded as *functionally* three distinct nerves, though bound up in a single trunk. There is no difficulty, then, in understanding that the respiratory system of nerves, in Insects, and other Invertebrata, may be analogous with the pneumonic portion of the Par Vagus; although it bears no relation with the cardiac and gastric divisions of the nerve. To the latter divisions, the analogy of the recurrent nerve becomes sufficiently plain, when we look at its distribution upon the dorsal vessel, œsophagus, and stomach;* but its commencement in the anterior ganglion, which also supplies the mouth and pharynx, might seem to place it on a different footing, until we have determined the true analogy of this last centre. It may be inferred from its situation, and from the distribution of its nerves, that this anterior ganglion is analogous both to the labial and pharyngeal ganglia of the higher Mollusca. These appear to form a division of the nervous system, by which the actions *immediately* concerned in the prehension of food are performed; and these seem almost as independent of the cephalic ganglia, as are those of respiration. There is evidently, however, a greater tendency towards the union of *these* centres with the œsophageal collar, than of those presiding over the respiratory function, which is more independent of the will.

334. The division of the nervous system of Vertebrata with which the *central* portion of this system corresponds, is a question of some apparent difficulty; but, if we bring into comparison not only the highest but the lowest forms of the cerebro-spinal apparatus, the chief difficulties will be removed. The analogies drawn from the distribution of the nervous branches would lead us to infer, that the *third* division of the Fifth pair (including its sensory and motor origins), the Glosso-Pharyngeal, and the gastric portion of the Par Vagus, would most nearly represent its central portion. Now, when the fifth pair is traced back to its true origin, it is found to be not a cerebral but a spinal nerve; and it is then seen to arise from the Medulla Oblongata, in such close approximation with the par vagum and glosso-pharyngeal, as to show that, if this portion of the nervous centres were isolated from the rest, the nerves which proceed from it would form, anatomically as well as functionally, a natural group. The fifth pair, like other spinal nerves, may act in a simply-reflex character; although, in Man, it is usually under the dominion of the will. In the lower animals we find these reflex actions bearing a much larger proportion to the voluntary, than in Man; and even in him we not unfrequently meet with cases, in which the functions of the cerebral hemispheres seem suspended, whilst those of the spinal cord are unimpaired; so that the prehension of food by the lips may take place without any effort of the will. This has been observed in anencephalous fetuses, in puppies from which the brain has been removed, and in profound apoplexy. Further, the connection between the fifth pair and par vagum is very intimate in fishes; the class which approaches nearest, in the character of its nervous system, to Invertebrata. We may reasonably infer, then, that the anterior ganglion is

* See Newport, in Phil. Trans., 1832, p. 386.

the principal centre of the reflex actions of those nerves, which correspond to the third branch of the fifth pair, to the glosso-pharyngeal, and to the gastric portion of the par vagum, in Vertebrata; whilst the branches which connect them with the cephalic ganglia, bring these nerves more or less under the influence of the latter.—The *lateral* ganglia seem more analogous to the centres of the *Sympathetic* system in Vertebrata; especially in the connection of their branches with all the other systems of nerves; and in the share which they have in the formation of the cœliac ganglia. This view of the relative functions of these two divisions of the stomato-gastric system, is strengthened by the fact, that the connection between the Sympathetic system of Fishes and the Par Vagum is much more intimate than in the higher Vertebrata; although, even in the latter, as will be shown hereafter, it is by no means so slight as it appears.*

335. Upon taking a general review of the facts which have been stated, and of the inferences which have been erected upon them, we perceive that a gradual elevation may be traced, in the character of the actions to which the Nervous System is subservient, as we ascend from the lower to the higher parts of the Animal Scale. In the Radiata and lower Mollusca, in which no organs of special sensation exist, all, or nearly all, of the movements which are witnessed, may be legitimately regarded as simply *reflex* in their character; being analogous to those, which are unquestionably so in the higher animals; and being performed by the instrumentality of a nervous apparatus, that seems to have little else than an *intermucial* purpose. But when, as in the higher Mollusca and in nearly all the Articulata, we meet with distinct organs of special sensation, it becomes evident that the *consciousness* of the animal must be concerned in the direction of its actions; since no impressions upon these organs (the eyes, for example) can exert any motor influence on the muscles, except by producing *sensations*;—that is, if we may apply to the lower tribes the laws deduced from the study of the higher. Whilst, therefore, a large proportion of the actions of the higher Invertebrata still continues to be reflex (as we have especially seen in the Articulata), a new group is superadded to these; and this, consisting of actions, which are directly stimulated by sensations, and in which no Reasoning powers nor Will appear to have any direct participation, may be termed *consensual*. They require, as their instruments, a set of ganglia to receive the trunks which originate in the organs of sense, and to issue motor nerves to the several parts of the body. These last are distributed along with the trunks, which are connected with the ganglia belonging to each particular organ; thus the legs and wings of an Insect appear to derive their motor nerves, partly from the ganglia of the ventral cord, which minister to their reflex actions, and partly from the cephalic ganglia, which seem to harmonize, to control, and even to antagonize, the influence of the former. In like manner, the parts of the body, which are capable of receiving sensory impressions, appear to have a double connection; one with the ganglia of the ventral cord, for the purpose of conveying thither those impressions which are destined to excite reflex actions; and the other with the cephalic ganglia, in order to originate sensations.—Of this double system of nerves and ganglia, the one connected solely

* The view given above of the comparative structure and offices of the Nervous System, in the Invertebrated animals, is chiefly abridged from the Author's Prize Thesis on this subject; in which additional details will be found, as well as many other illustrative figures and references to authorities. He has there, also, discussed the physiological explanation which had been previously given of the double nervous cord of the Articulata; and having shown that it is neither consistent with itself, nor capable of being applied to the other Invertebrata, he has deemed it unnecessary to complicate the present sketch by introducing it.

with the *reflex* actions, and the other with the *consensual*, the existence in Articulata seems to be clearly established by Mr. Newport's researches (§ 326); and although the distinction between the *afferent* and *motor* fibres, of each system respectively, has not here been clearly made out, there can be no reasonable doubt of its existence.

336. The class of *consensual* actions evidently becomes more predominant, in proportion as the special sensory organs are more evolved, and as the ganglia in immediate connection with them (and altogether forming the cephalic mass) present an increase in their proportionate development. This is especially the case in the higher Articulata; in which the Instinctive group of actions attains its highest perfection and predominance. The propriety of referring these to the consensual group, will be obvious upon a little consideration. They are as evidently prompted by particular *sensations*, as are the reflex actions by particular *impressions*; and the responsiveness is as uniform in the one case, as in the other. Although in these movements, there is a most remarkable adaptation of means to ends, (as in the construction of habitations by various Insects, and especially by the social Hymenoptera,) yet few persons will maintain that this adaptation is performed by the *reason* of the animal; since, on this supposition, every Bee solves a problem which has afforded scope for the laborious inquiries of the acutest human mathematician.* The adaptation is in the original construction of a nervous system, which should occasion particular movements to be performed under the influence of particular sensations; and the constancy with which these are performed by different individuals of the same species, when placed in the same conditions, leads at once to the belief, that they must be independent of any operations so variable as those of judgment and voluntary exertion.

337. On the other hand, in the Vertebrata, we shall find the purely reflex and consensual movements forming a smaller proportion of their actions, and brought under a more complete subjection to the Volitional system. This is evident, from the greater variety which the actions exhibit; from the mode in which they are adapted to peculiar circumstances; from the degree in which they may be modified by education; and from various other indications of a superior kind of Intelligence. At last, in adult Man, we perceive that all the movements, which are elsewhere involuntary, but which are not immediately requisite (as are those of deglutition, respiration, &c.) for the maintenance of

* The *hexagonal* form of the cell is the one in which the greatest strength, and the nearest approach to the cylindrical cavity required for containing the larva, are attained, with the least expenditure of material. But the instinct which directs the Bees in the construction of the partition that forms the bottom or end of the cell, is of a nature still more wonderful than that which governs its general shape. The bottom of each cell rests upon three partitions of cells upon the opposite side of the comb; so that it is rendered much stronger, than if it merely separated the cavities of two cells opposed to one another. The partition is not a single plane surface; but is formed by the union of three rhomboidal planes, uniting in the centre of each cell. The angles formed by the sides of these rhombs, were determined by the measurements of Maraldi to be $109^{\circ} 28'$ and $72^{\circ} 32'$; and these have been shown, by mathematical calculation, to be *precisely* the angles, at which the greatest strength and capacity can be attained, with the least expenditure of wax. The solution of the problem was first attempted by Koenig, a pupil of the celebrated Bernouilli; and as his result proved to differ from the observed angle by only two minutes of a degree, it was presumed that the discrepancy was due to an error of observation, which it was easy to account for by the smallness of the surfaces whose inclination had to be measured. The question has been since taken up, however, by Lord Brougham (Appendix to his Illustrated edition of Paley's Natural Theology); who has worked it out afresh, and has shown that, when certain small quantities, neglected by Koenig, are properly introduced into the calculation, the result is exactly accordant with observation,—the *Bees* being thus proved to be *right*, and the *Mathematician wrong*.

the Organic functions, are placed under the control of the Will, guided by the reasoning faculties. This is especially true of the locomotive organs, whose reflex actions are entirely governed by the will; being only distinguishable as such, when, from peculiar states of the system, the immediate influence of the controlling power is suspended.—We shall find ground to believe, that the exercise of the Reasoning faculties, and the resulting operations of the Will, take place through the instrumentality of another division of the nervous centres; to which there is nothing distinctly analogous among the Invertebrata; but which seems to bear a constant proportion in size and importance, among Vertebrated animals, to the development of the Intelligence and its influence on the movements of the body:—namely, the Cerebral ganglion.

338. There is another aspect, however, under which we are to consider the Nervous System; and this becomes more important in the highest division of the Animal kingdom, on which we are now about to dwell. We have hitherto spoken only of its influence on the *contractile* properties of the tissues, to which it is distributed. It has, however, an important and direct connection with the purely organic functions of Nutrition and Secretion; and we shall see reason to regard it as the means, not only of placing the *animal* in relation with the external world, but of harmonizing and controlling the *organic* changes taking place in its own structure, and of bringing these under the influence of particular mental conditions. The opinion is entertained by many, that all the Organic Functions are *dependent* upon the innervation, supplied to them by the system of nerves, which has been termed *Sympathetic* or *visceral*. It is incumbent, however, on those who uphold the necessity of this nervous power, to prove it definitively; since all analogy leads to an opposite conclusion. We may regard the capability of separating a particular secretion from the blood, as a peculiar property inherent in the glandular cells, just as contractility is the inherent property of muscular fibre. But as the peculiar arrangement of the excitable and contractile tissues in Animals, requires a nervous system to act as a conductor between them, and to blend their actions; so may the complicated Organic functions of Animals require to be harmonized and kept in sympathy with each other, by some mode of communication more direct and certain than that afforded by the circulating system, which is their bond of union in Plants. We have seen, in the foregoing sketch, that the Visceral system does not exist in a distinct form in the lower classes of Invertebrated animals; and also that the nervous system of these classes cannot, as a whole, be compared with it, although it may be regarded as containing some rudiments of it. As the divisions of this system become more evident, however, and the organic functions more complicated, some appearance of a separate Sympathetic system presents itself; but this is never so distinct as in Vertebrata. Hence, it may fairly be inferred that,—as the Sympathetic system is *not* developed in proportion to the predominant activity of the functions of organic life (which is so remarkable in the Mollusca when contrasted with the Articulata), but in proportion to the development of the higher divisions of the nervous system,—its office is not to contribute to these functions anything essential to their performance; but rather to exercise that general control over them which becomes the more necessary as they become more independent of one another; and to bring them into relation with the system of Animal life.

3. Nervous System of Vertebrata.

339. When we direct our attention to the Nervous System of the Vertebrated classes, we are immediately struck by two remarkable differences which its condition presents, from that under which we have seen it to exist in the

Invertebrata. In the latter it has seemed but a mere appendage to the rest of the organism,—a mechanism superadded for the purpose of bringing its various parts into more advantageous relation. On the other hand, in the Vertebrata the whole structure appears subservient to it, and designed but to carry its purposes into operation. Again, in the Invertebrata, we do not find any special adaptation of the organs of support, for the protection of the Nervous System. It is either inclosed, with the other soft parts of the body, in one general hard tegumentary envelope, as in the Echinodermata and Articulata; or it receives a still more imperfect protection, as in the Mollusca. In the latter, the naked species are destitute of any means of passive resistance, and the Nervous System shares the general exposed condition of the whole body; and it is not a little remarkable that, in the testaceous kinds, the portion of the body containing the most important nervous centres should be protruded beyond the shell, whilst the principal viscera are retained within it. Now, in the Vertebrata, we find a special and complex bony apparatus, adapted in the most perfect manner for the protection of the Nervous System; and it is, in fact, the possession of a jointed spinal column, and of its cranial expansion, which best characterizes the group.

340. When we look more particularly at the Nervous Centres themselves, we perceive that they combine the general characters of those of the Articulata with those of the Mollusca; the locomotive powers of the former (comparatively reduced, however, in activity) being united with the complex nutritive system of the latter; and we find this combination manifested, not only in the organs themselves, but in the Nervous System, which stands in so close a relation with them. The Spinal Cord of Vertebrata is evidently the analogue of the ventral columns of Articulata. It is a continuous ganglion, containing two portions as distinct as the two tracts in the Articulata;—a *fibrous* structure, which is continuous between the Brain and the spinal nerves, and thus resembles the white tract in Insects;—and a *ganglionic* portion, principally composed of gray matter. Into this gray matter, as in the ventral ganglia of Insects, a part of the roots of the spinal nerves may be traced; whilst others seem to pass on continuously to the brain. At the upper extremity of the Spinal cord (commonly termed the *Medulla Oblongata*) we find the ganglia and nerves of special sensation; and the organs which these supply are placed in immediate proximity with the entrance to the alimentary canal, holding the same relation to it as in the Mollusca. But in addition to these we find two ganglionic masses in all Vertebrata, to which we have no distinct analogue in the lower classes—the Cerebral Hemispheres, and the Cerebellum. With the development of the former of these, as already remarked, the perfection of the reasoning powers appears to hold a close relation; that of the latter seems connected with the necessity which exists, for the adjustment and combination of the locomotive powers, when the variety of movements performed by the animal is great, and the harmony required among them is more perfect. Upon these points, however, we shall hereafter dwell.

341. The Visceral system of nerves now assumes a more distinct form. It does not share the protection of the Spinal column; but its ganglia lie for the most part in the general cavity of the trunk. These ganglia, which are doubtless the independent centres of some of the nerve-fibres proceeding from them, are much more numerous than is commonly supposed. It appears from recent researches, that we are to regard as belonging to the Visceral or Sympathetic system, not only the Semilunar and Cardiac ganglia (which seem to be its principal centres), with the chain of cranial, cervical, thoracic, lumbar, and sacral ganglia, which are in nearer proximity to the

Cerebro-spinal system, but also numerous minute ganglia, which are to be found on its branches in various parts, and, in addition, the ganglia upon the posterior roots of the Spinal nerves. If, indeed, we are to regard the *fine* nerve-fibres, wherever they present themselves, as belonging to the Visceral system, we must regard this as still largely interwoven with the Cerebro-spinal system, notwithstanding that the former has its own set of ganglionic centres; since, as already mentioned (§ 244), these peculiar fibres are found in considerable numbers in all the Cerebro-spinal nerves, and may be shown to originate in the caudate corpuscles of the Brain and Spinal Cord. On the other hand, there unquestionably exist numerous fibres in the Visceral system, which proceed into it from the Cerebro-spinal system; these, however, are not uniformly distributed, for some of the Visceral nerves contain few or none of them, whilst in others they are numerous. The branches by which the Sympathetic system communicates with the Cerebro-spinal, and which were formerly considered as the *roots* of the Sympathetic system, contain fibres of both kinds:— i. e., Cerebro-spinal fibres passing into the Sympathetic, and Sympathetic fibres passing into the Cerebro-spinal. The latter are chiefly, if not entirely, transmitted into the *anterior* branches of the Spinal nerves; the *posterior* branches being principally supplied with fine fibres, from the ganglia on

[Fig. 130.

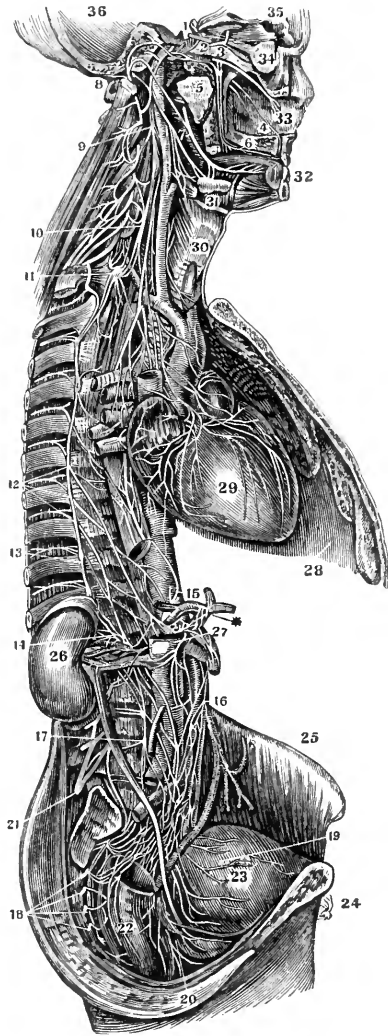

A view of the Great Sympathetic Nerve.—1, the plexus on the carotid artery in the carotid foramen; 2, sixth nerve (motor externus); 3, first branch of the fifth or ophthalmic nerve; 4, a branch on the septum narium going to the incisive foramen; 5, the recurrent branch or vidian nerve dividing into the carotid and petrosal branches; 6, posterior palatine branches; 7, the lingual nerve joined by the corda tympani; 8, the portio dura of the seventh pair or the facial nerve; 9, the superior cervical ganglion; 10, the middle cervical ganglion; 11, the inferior cervical ganglion; 12, the roots of the great splanchnic nerve arising from the dorsal ganglia; 13, the lesser splanchnic nerve; 14, the renal plexus; 15, the solar plexus; 16, the mesenteric plexus; 17, the lumbar ganglia; 18, the sacral ganglia; 19, the vesical plexus; 20, the rectal plexus; 21, the lumbar plexus (cerebro-spinal); 22, the rectum; 23, the bladder; 24, the pubis; 25, the crest of the ileum; 26, the kidney; 27, the aorta; 28, the diaphragm; 29, the heart; 30, the larynx; 31, the sub-maxillary gland; 32, the incisor teeth; 33, nasal septum; 34, globe of the eye; 35, 36, cavity of the cranium.]

[Fig. 131.

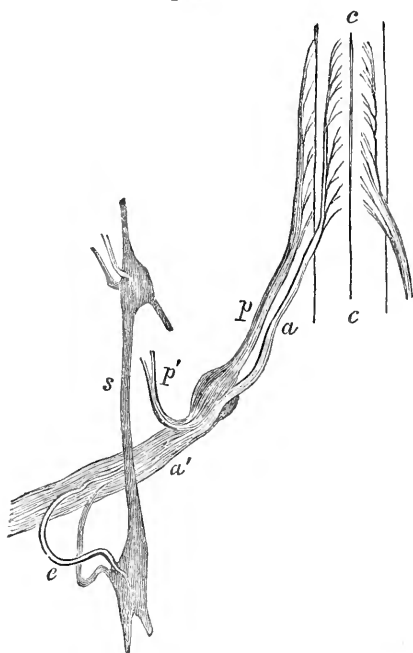

Roots of a dorsal spinal nerve, and its union with sympathetic:—*e, e*. Anterior fissure of the spinal cord. *a*. Anterior root. *p*. Posterior root, with its ganglion. *a'*. Anterior branch. *p'*. Posterior branch. *s*. Sympathetic. *e*. Its double junction with the anterior branch of the spinal nerve by a white and a grey filament.]

their posterior roots. Some of these last fibres also pass, with the ordinary large nerve-tubes, from the Cerebro-spinal into the Sympathetic system. By these communications the two systems of fibres are so blended with each other, that it is impossible to isolate them; and all that can be said is, that the large tubular fibres *predominate* in the former, and the fine homogeneous fibres in the latter.

342. The branches proceeding from the Semilunar ganglia are distributed upon the abdominal viscera; and those of the Cardiac ganglia upon the heart and the vessels proceeding from it. The latter seem to accompany the arterial trunks through their whole course, ramifying minutely upon their surface; and it can scarcely be doubted, that they exercise an important influence over their functions. What the nature of that influence is, however, will be a subject for future inquiry. It is so evidently connected with the operations of nutrition, secretion, &c., that the designation of "nervous system of organic life," as applied to this system does not seem objectionable, provided that we do not understand

it as denoting the *dependence* of these functions upon it.—Even in Vertebrata, however, we do not always find the distribution of the visceral trunks distinct from those of the cerebro-spinal. In the Cyclostome Fishes, the par vagum supplies the intestinal canal along its whole length, as well as the heart; and no appearance of a distinct sympathetic can be discovered. In Serpents, again, the lower part of the alimentary canal is supplied from the spinal cord, and the upper part by the par vagum; and though the lateral cords of the sympathetic may be traced, they are almost destitute of ganglia. Even in the highest Vertebrata, some of the glands, of which the secretion is most directly influenced by the condition of the mind, are supplied with most of their nerves from the cerebro-spinal system; thus, the lachrymal and sublingual glands receive large branches from the fifth pair, and the mammary glands from the intercostal nerves. But it appears probable, from what has just been stated, that the influence is conveyed through the *visceral* fibres, contained in these nerves, and either originating in the ganglia at their roots, or derived from the Sympathetic system.

343. The Spinal Cord, with its encephalic continuation—the Medulla Oblongata,—may be regarded as constituting the essential part of the nervous system of Vertebrata. Although the Cerebral Hemispheres in Man bear so large a proportion to it in size, that the Spinal Cord seems but a mere appendage to them, the case is reversed when we look at the other extremity of the scale; the Cerebral Hemispheres, in many Fishes, being but ganglionic

protuberances from the Medulla Oblongata. Moreover, the fact that animals are capable of living without the brain, whilst they at once die if deprived of the spinal cord, sufficiently demonstrates this. The spinal cord, then, when viewed in relation to the nervous system of the Invertebrata, may be regarded as including their respiratory, stomato-gastric, and pedal ganglia. That these should be associated together, can scarcely be considered remarkable. It is obviously convenient that they should all be inclosed in the bony sheath provided for their protection; and their closer relation favors that sympathy of action, which is so important in animals of such complex structure and mutually dependent functions, as the higher Vertebrata. An animal either congenitally or experimentally deprived of its cerebral hemispheres, is very much in the condition of one of the Acephalous Mollusca. It can perform those respiratory movements, on which depend the maintenance of its circulation, and consequently its whole organic life; it can swallow food brought within its reach, and it can, in some degree, exert its locomotive powers to obtain it; but it is unconscious of the direction in which these can be best employed, and is dependent upon the supplies of food that come within its grasp. The Acephalous Mollusca are so organized, that they find support from the particles brought in by their respiratory current; but the more highly-organized Vertebrata are not capable of so existing, and they must have their food provided for them by an exertion of the mental powers. So long as an anencephalous Vertebrated animal is duly supplied with its requisite food, so long may it continue to exist, although in a state analogous to that of profound sleep; and thus it is seen, that the operations of the Brain are not immediately connected with the maintenance of the organic functions; the movements requisite for these being carried on, as in the lower animals, through the instrumentality of ganglionic centres and nerves specially appropriated to them.

344. It is only in the Vertebrata, that the difference between the *afferent* and *efferent* fibres of the nerves, has been satisfactorily determined. The merit of this discovery is almost entirely due to Sir C. Bell. He was led to it by a chain of reasoning of a highly philosophical character; and though his first experiments on the Spinal nerves were not satisfactory, he virtually determined the respective functions of their two roots, by experiments and pathological observations upon the cranial nerves, before any other physiologist came into the field.* Subsequently his general views were confirmed by the very decided experiments of Müller; but, until very recently, some obscurity hung over a portion of the phenomena. It was from the first maintained by Magendie, and has been subsequently asserted by other physiologists, that the anterior and posterior roots of the nerves were both concerned in the reception of sensations and in the production of motions; for that, when the anterior roots were touched, the animal gave signs of pain, at the same time that convulsive movements were performed; and that, on touching the posterior roots, not only the sensibility of the animal seemed to be affected, but muscular motions were excited. These physiologists were not willing, therefore, to admit more, than that the anterior roots were especially motor, and the posterior especially sensory. But the recently attained knowledge of the reflex function of the spinal cord, enables the latter portion of these phenomena to be easily explained. The motions excited by irritating the posterior root are entirely dependent upon its connection with the spinal cord, and upon the integrity of the anterior roots and of the trunks into which they enter; whilst they are not checked by the separation of the posterior roots from the peripheral portion of the trunk. It is evident, therefore, that excita-

* See British and Foreign Medical Review. Vol. ix., p. 140, &c.

tion of the posterior root does not act immediately upon the muscles through the trunk of the nerve, which they contribute to form; but that it excites a motor impulse in the Spinal Cord, which is propagated through the anterior roots to the periphery of the system. The converse phenomenon, the apparent sensibility of the anterior roots, has been still more recently explained by the experiments of Dr. Kronenberg;* which seem to prove, that it is dependent upon a branch of the posterior root passing into the anterior root at their point of inosculation, and then directing itself towards the cord (§ 304).

345. On the other hand, the distinctness of the system of nerves concerned in the *simply-reflex* actions, from those which minister to sensation, emotion, and volition by their connection with the brain, is by no means so obvious as in the Invertebrated classes. When first pointed out by Dr. Marshall Hall, who had grounded his opinion more upon physiological phenomena than upon anatomical facts, the statement did not command general assent; since, while the phenomena were admitted, the inferences which he drew from them were not regarded as necessary results. When, however, the anatomy of the Nervous centres in Vertebrata was more closely inquired into (by Mr. Grainger, who had been partly anticipated by Bellingeri), it was found to present certain phenomena which might be regarded as supporting Dr. M. Hall's views; and when the inquiry was extended to the Invertebrated classes, the confirmation was found to be still more decisive. In our previous sketch these doctrines have been treated as established; since they have been found not only to correspond with the facts disclosed by anatomical research, but to be required by them. We shall now apply them to the nervous apparatus of the Vertebrata.

Fig. 132.



Nervous centres in Frog; A, olfactory ganglia; B, cerebral hemispheres; C, optic ganglia; D, cerebellum, so small as not to cover the 4th ventricle, or cavity left by the divergence of the columns of the Spinal Cord.

346. The Spinal Cord consists of two lateral halves; these are partially separated, in the higher classes, by the superficial anterior and posterior fissures; and in Fishes by an internal canal, which is continuous with the fourth ventricle.† This canal is evidently the indication of that complete separation of the two columns, which exists in the lower Articulata; and the fourth ventricle, which in many Fishes remains unclosed (the cerebellum not being sufficiently developed to overlap it), corresponds with the passage between the cords uniting the cephalic ganglia, with the first sub-œsophageal, through which the œsophagus passes in all the Invertebrata. The two lateral halves have little connection with each other in Fishes, and the pyramidal bodies at their apex scarcely decussate; but in ascending towards the higher classes, the communication between the two sides is more intimate, and a larger proportion of the pyramidal fibres, crosses to the opposite side. In all the Vertebrata, the true Spinal Cord contains grey substance, or something equivalent to it; thus possessing the character of a continuous ganglion. The proportion of the vertebral column which this ganglionic portion occupies, is, however, extremely variable; depending principally on the position of the chief organs of locomotion. Thus, in the Eel, and other Vermiform Fishes, it is continued through the whole spinal canal; whilst in the Lophius and Tetraodon, whose body is less prolonged, and more dependent for its movements upon the anterior extremi-

* Müller's Archiv., 1839, Heft v.; and Brit. and For. Med. Rev., vol. ix. p. 547.

† This canal may be traced in the Spinal Cord of Man and other Mammalia; but it is nearly obliterated.

ties, the true Spinal Cord scarcely passes out of the cranium. The quantity of grey matter is nearly uniform in every part of the cord, where there is no great diversity in the functions of the nerves which originate from each portion. In most Fishes, for example, the body is propelled through the water more by the lateral action of the flattened trunk (whose surface is extended by the dorsal and caudal fins erected upon prolongations of its vertebræ), than by the movements of its extremities, which serve principally to guide it. Hence we usually find the amount of grey matter varying but little in different parts of the cord. But in the Flying-fish, and others whose pectoral fins are unusually powerful, a distinct ganglionic enlargement of the cord takes place where the nerves are given off. In Serpents, again, the spinal cord is nearly uniform throughout its entire length; whilst in Amphibia it is so during the Tadpole condition, but presents enlargements corresponding to the anterior and posterior extremities, when these are developed; at the same time becoming much shortened, as the tail is less important to locomotion, or is altogether atrophied. In Birds, the ganglionic enlargements are generally very perceptible; and bear a close relation in size, with the development of the locomotive organs with which they are connected. Thus, in birds of active flight, and short powerless legs, the anterior enlargement is the principal; but in those which are more adapted to run on hand than to wing their way through the air, such as the whole tribe of Struthious birds, the size of the posterior enlargement is very remarkable. Hence we have a right to infer, that the increase in the quantity of grey matter in the cord has some connection with the amount of power to be supplied; and this exactly corresponds with what has been observed in the Articulated classes, and especially in watching the metamorphosis of Insects. In Birds and Mammalia, however, the whole amount of the grey matter in the spinal cord does not bear so large a proportion to the bulk of the nerves proceeding from it, as in the lower Vertebrata; and the reason of this seems obvious.

The actions of the locomotive organs are less and less of a reflex character, and are more directly excited by the will, and consequently by the brain than in the inferior tribes; and just in proportion, therefore, to the development of the Brain, will it become the centre of all the actions performed by the animal, and the Spinal Cord a mere appendage to it. Still, in all the Mammalia, even in Man, do we find these ganglionic enlargements of the spinal cord; and in Man it is the posterior one (or rather the inferior), which contains the largest quantity of grey matter. In the cord of this class, too, the lateral halves are much more intimately united, than in the classes below; for not only is the central canal for the most part absent, but the two crescent-shaped plates of grey matter are united by a transverse lamella, which connects their centres like a commissure.

347. The Cord is transversed, not only by the anterior and posterior fis-

Fig. 133.

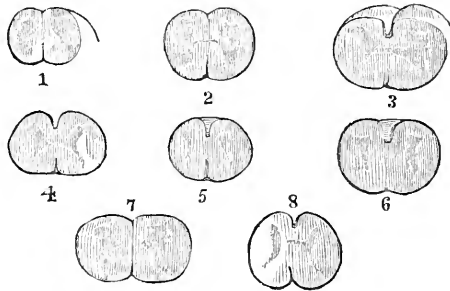

Transverse sections of human Spinal Cord at different points, showing the proportional quantity and arrangement of grey and white matter at each: 1, opposite 11th dorsal vertebra; 2, opposite 10th dorsal; 3, opposite 8th dorsal; 4, opposite 5th dorsal; 5, opposite 7th cervical; 6, opposite 4th cervical; 7, opposite 3d cervical; 8, section of medulla oblongata through centre of corpus olivare.

tures, but by two furrows on each side, marking out three columns upon it. We have, therefore, on each half of the cord, an *anterior middle* or *lateral* and *posterior* column. The points of the crescentic lamellæ of grey matter approach these furrows pretty closely; but elsewhere the grey matter is covered deeply by the fibrous columns. Each spinal nerve arises from two sets of roots. The anterior roots join the spinal cord, near the anterior furrow; and the posterior, near the posterior furrow. Respecting their intimate connection with the principal divisions of the cord, a considerable diversity has existed among the statements of anatomists; but it seems to be now generally admitted, that, as in the Articulata, a part of each root enters the

[Fig. 134.

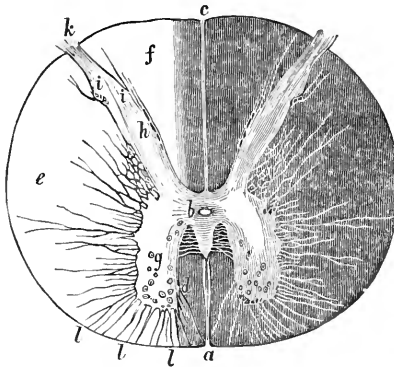

Transverse section of human spinal cord, close to the third and fourth cervical nerves; magnified ten diameters, (from Stilling:)—*f*. Posterior columns. *ii*. Gelatinous substance of the posterior horn. *k*. Posterior root. *l*. Supposed anterior roots. *a*. Anterior fissure. *c*. Posterior fissure. *b*. Grey commissure, in which a canal is contained, which, according to these writers, extends through the length of the cord. *g*. Anterior horn of grey matter containing caudate vesicles. *e*. Antero-lateral column (from *k* to *a*).

Fig. 135.

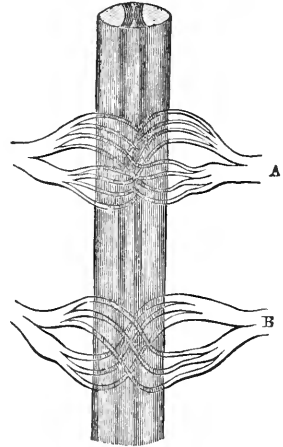

Passage of Nerve-fibres through the Spinal Cord, according to Stilling; *A*, posterior fibres continuous with the anterior of the same side, through the nucleus of the cord; *B*, posterior fibres continuous with the anterior of the opposite side.

grey matter or *ganglionic* portion of the cord, whilst a part is continuous with its *white* or *fibrous* columns.—The course of the fibres which enter the grey matter, has been lately displayed, in part, at least, by the researches of Dr. Stilling.* It appears that of the fibres of the *posterior* roots, some form loops in the grey matter, and become continuous with those of the *anterior* roots of the *same side*, as seen at *A*, fig. 135. Others cross the grey matter, and become continuous with those of the anterior roots of the *opposite side*, as seen at *B*. It can scarcely be doubted that these fibres, being unconnected, with the brain, constitute the system to which reflex actions are due. Although Dr. Stilling's inquiries have not proved the fact,† yet it may be inferred from physiological phenomena, as well as from the facts recently shown by Mr. Newport (§ 326), that there are other fibres, which pass from the posterior

* Ueber die Textur und Function der Medulla Oblongata.

† It may be thought that the mode of examination which he adopted,—that of making very thin *transverse* sections of the Spinal Cord,—is not well fitted to display the connections of the roots with *longitudinal* fibres. The subsequent observations of Budge (Muller's Archiv., 1844, p. 160), seem to have established the fact of the continuity of a portion of each root with the longitudinal fibres of the cord.

roots into the anterior roots of other nerves *above* and *below*, both on the same side and on the opposite.—Of the portions of the roots which are continuous with the fibrous columns, the anterior would seem to have a connection with both the anterior and lateral columns; and the posterior cannot be said to be restricted to the lateral column, some of their fibres entering the posterior division of the cord.

348. If the white or fibrous portion of the Spinal Cord be really continuous with the medullary matter of the Brain, the roots of the nerves which enter it are in reality thus brought into connection with the Cerebral Hemispheres and Cerebellum; and the posterior division of these may, therefore, be regarded as conducting to the Sensorium those impressions, which there become sensations; whilst the anterior roots convey the motive influence, which has been propagated, by a voluntary or emotional impulse, down the tract of the Spinal Cord with which they are continuous. On the other hand, the passage of one portion of each set of roots through the grey matter of the Cord, completes the nervous circle required for the performance of reflex actions; and by this they would seem to take place in Vertebrated animals, just as through the distinct system of excito-motor fibres in the Articulata (§ 328.) The fibres which pass continuously from the posterior to the anterior roots of the nerves on the same side, probably constitute the channel of those reflex actions, which can be excited in a part supplied by any compound nerve, by stimulating its *afferent* fibres, and thus causing a motor impulse to be transmitted from the Spinal Cord along its *afferent* portion. The fibres which cross to the opposite side, will produce similar movements in its corresponding parts. And the fibres, if such there be, that pass from the posterior (*afferent*) roots of each nerve, into the anterior (*motor*) roots of distant nerves, would convey to a great variety of muscles, the influence of a stimulus applied to a single afferent nerve. It follows, then, on this view of the character of the Spinal Cord, that the continuity of the fibrous tracts is all that is required, to convey the influence of the brain to the parts below; whilst the completeness of the nervous circle is all that is necessary, for the performance of reflex actions excited through it. This is found to be strictly true; the former having been observed in cases of disease, and the latter having been proved by experiment. As far as simple reflex actions are concerned, there is as much segmental independence in Vertebrata, as in the Articulata; but these actions seldom have so completely the character of adaptation, and are of a more irregular and convulsive nature. Still, however, there is an essential correspondence between them; and we may, therefore, regard the distinction between the reflex and voluntary movements as the same in each group; the former predominating in Articulata; the latter in Vertebrata. On this view, then, each spinal nerve contains at least four sets of fibres.

i. A *sensory* bundle passing upwards to the Brain.

ii. A *motor* set, conveying the influence of volition and emotion downwards from the Brain.

iii. A set of *excitor* or centripetal fibres, terminating in the true Spinal Cord or ganglion, and conveying impressions to it.

iv. A *motor* or centrifugal set, arising from the same Ganglionic centre, and conveying the motor impulse reflected from it to the muscles.

Of these, the first and third are united in the posterior or *afferent* roots; the second and fourth in the anterior or *efferent* roots.

349. It is difficult to trace the course of the fibres within the Spinal Cord; but it is now proved, that Sir C. Bell was not altogether correct in his idea, that the functions of the columns of the Cord are respectively similar to those of the roots connected with them. Cases, indeed, are of no unfrequent occurrence, in which a portion of one of the columns has been almost entirely

destroyed by injury or disease, without any corresponding loss of the function attributed to it.* Such cases have kept alive, in the minds of many eminent practical men, a considerable distrust of the accuracy of Sir C. Bell's conclusions. We have seen that, in regard to the *roots of the nerves*, his first statements have been confirmed, and rendered more precise, by subsequent researches; but it is not so in regard to the functions of the anterior and posterior divisions of the Spinal Cord.—Bellingeri was led, by experiments on the spinal cord, to the conclusion, that the anterior roots of the nerves were for the flexion of the various articulations, and the posterior for their extension. He also was wrong, in extending an inference, founded on experiments on the Cord, to the roots of the nerves.—The recent experiments of Valentin, whilst they fully confirm Sir C. Bell's determination of the functions of the roots of the nerves, coincide, to no small degree, with Bellingeri's opinion, in regard to the offices of the anterior and posterior divisions of the Cord. He obtained reason to believe that, in the Frog, neither the superior nor inferior strand of the cord (posterior and anterior columns in Man) solely possesses motor functions; but he found that, when the former were irritated, sensations predominated; and when the latter, motions were chiefly excited. He further states that, if the superior strand (*posterior column*) be irritated at the point at which the nerves of either extremity are given off, that extremity is *extended*; and that if the inferior strand (*anterior column*) be irritated, the extremity is *flexed*. At their entrance into the spinal cord, therefore, it would appear that the motor fibres of the extensors pass towards the superior stratum (*posterior column in Man*), whilst those of the flexors are continuous with the inferior stratum (*inferior column*); their course being more altered, however, when they are examined far from the point of issue. This doctrine was confirmed by experiments on Mammalia; and is borne out (according to Valentin) by pathological phenomena observed in Man. According to this eminent physiologist, also, relaxation of the sphincters is analogous to the extended state of the extremities; and he has noticed a manifest relaxation of the sphincter ani in the frog, when the superior part of the spinal cord was irritated, so as to produce extension of the limbs. These statements are entitled to considerable weight, on account of the quarter from which they come; but they are not, perhaps, to be received altogether without hesitation, until confirmed by other physiologists, especially whilst the phenomena of reflex action are still so imperfectly known. For it is quite possible that, whilst stimulation of the anterior part of the cord may excite *direct* motions of flexion, in preference to those of extension, the movements of extension produced by stimulating the posterior column may be of a *reflex* character.

350. There is no reason to believe, that the functions of the Spinal Cord are essentially different along its whole length. Everywhere it appears to consist of a ganglionic centre, supplying nerves to its particular segment; and of connecting fibres, by which the nerves proceeding from any one division are brought into relation with distant portions of the organ, and with the large ganglionic masses at its anterior extremity. In this respect, then, it corresponds precisely with the double nervous cord of the Articulata; the only prominent difference between the two being, that in the former the ganglionic matter is continuous from one extremity of the organ to the other; whilst in the latter it is interrupted at intervals; and in the Mollusca, the centres are still further separated from each other. The connection of the

* See especially a case recorded by Dr. Webster (Medico-Chirurgical Transactions, vol. xxvi.), in which there was complete destruction of the posterior column in the lower part of the cervical region; which was not attended with loss of sensibility in the parts below, but, on the contrary, with loss of power of voluntary motion.

Spinal Cord with the large ganglia contained within the cavity of the cranium, is effected by means of processes from its superior extremity, the arrangement of which is somewhat complex. This portion of the cord, which also lies within the cavity of the cranium, has been termed the *Medulla Oblongata*. It has been supposed to be the peculiar seat of vitality; but the only real foundation of this idea is, that it is the great centre of the Respiratory actions, on the continuance of which all the other functions are dependent. The Brain may be removed from above, and nearly the whole Spinal Cord from below, without an immediate check being put upon all the phenomena of life. In this *Medulla Oblongata*, four different parts may be distinguished on each side:—1, The Anterior Pyramids, or *Corpora Pyramidalia*; 2, The Olivary Bodies, or *Corpora Olivaria*; 3, The Restiform bodies, or *Corpora Restiformia*; otherwise called *Processus a Cerebello ad Medullam Oblongatam*; 4, The

[Fig. 136.

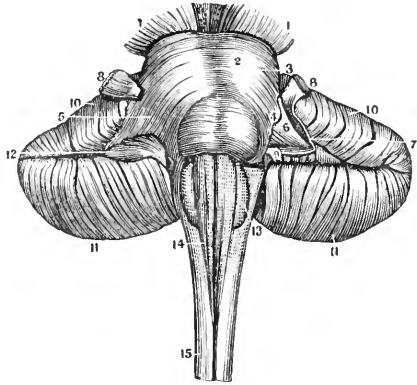

A posterior superior view of the Pons Varolii, the Cerebellum, and the Medulla Oblongata and Spinalis. 1, 1, the crura cerebri; 2, the pons varolii or tuber-annularis; 3, its middle fossa; 4, an oblique band of medullary matter seen passing from its side; 5, the external surface of the crus cerebelli in its natural state; 6, the same portion deprived of outer layer; 7, the nervous matter which united it to 4; 8, the trigeminus or fifth pair of nerves; 9, portion of the auditory nerve—the white neurine is seen passing from the oblique band which comes from the corpus restiforme to the trigeminus nerve in front, and the auditory nerve behind; 10, 11, the superior portion of the hemispheres of the cerebellum; 12, lobulus amygdaloides; 13, corpus olivare; 14, corpus pyramidale; 15, medulla spinalis.]

[Fig. 137.

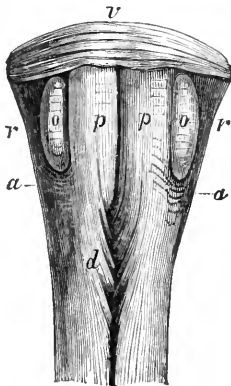

Front view of the medulla oblongata:—p, p, Pyramidal bodies, decussating at d. o, o, Olivary bodies. r, r, Restiform bodies. a, a, Arciform fibres. v, Lower fibres of the Pons Varolii.]

[Fig. 138.

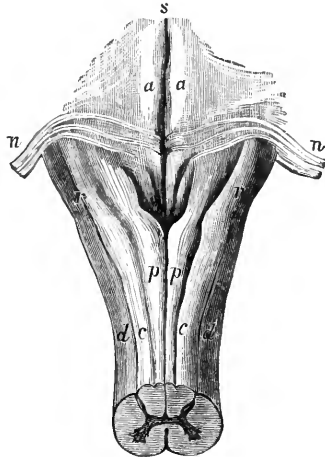

Posterior view of the medulla oblongata:—pp, Posterior pyramids, separated by the posterior fissure. rr, Restiform bodies, composed of cc, posterior columns, and dd, lateral part of the antero-lateral columns of the cord. aa, Olivary columns, as seen on the floor of the fourth ventricle, separated by s, the median fissure, and crossed by some fibres of origin of nn, the seventh pair of nerves.]

Posterior Pyramids, or *Corpora Pyramidalia Posteriora*. The connections of these with the Brain above, and with the Spinal Cord below, will be now traced.*

[Fig. 139.

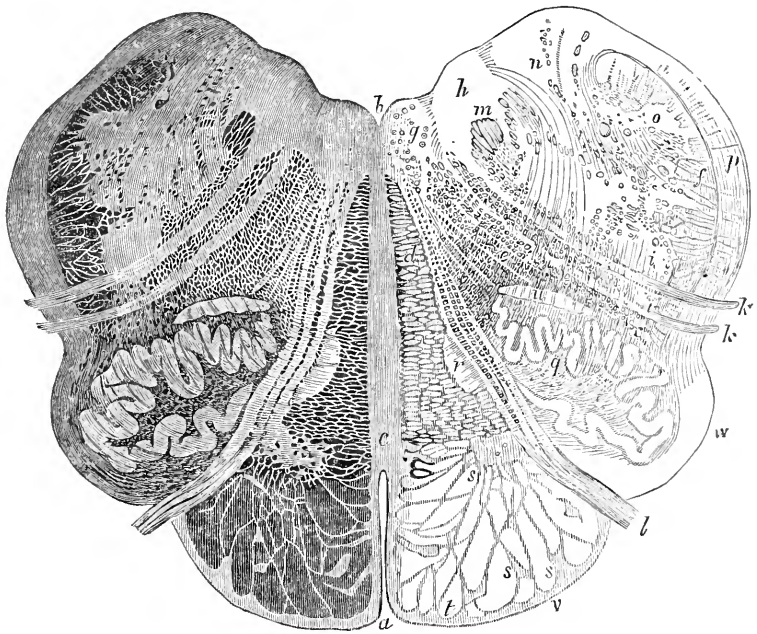

Transverse section of the medulla oblongata through the lower third of the olivary bodies. (From Stilling.) Magnified 4 diameters.

a. Anterior fissure. b. Fissure of the calamus scriptorius. c. Raphé. d. Anterior columns. e. Lateral columns. f. Posterior columns. g. Nucleus of the hypoglossal nerve, containing large vesicles. h. Nucleus of the vagus nerve. i, i. Gelatinous substance. k, k. Roots of the vagus nerve. l. Roots of the hypoglossal, or ninth nerve. m. A thick bundle of white longitudinal fibres connected with the root of the vagus. n. Soft column (*Zartsrang*, Stilling). o. Wedge-like column (*Keelstrang*, Stilling). p. Transverse and areiform fibres. q. Nucleus of the olivary bodies. r. The large nucleus of the pyramid. s, s, s. The small nuclei of the pyramid. u. A mass of grey substance near the nucleus of the olives (*Olivem-Neben kern*). u, q, r, are traversed by numerous fibres passing in a transverse semicircular direction. v, w. Arciform fibres. x. Grey fibres.]

351. As our object, however, is rather Physiological than purely Anatomical, we shall commence with a description of the *motor* and *sensory* tracts, which may, according to Sir C. Bell,† be very distinctly separated in the Pons

* Great diversities will be found in the accounts given of those connections by different Authors; some of which are attributable to a variation in the use of terms, which must not pass unnoticed. By the majority of Anatomists, the name of *Corpora Restiformia* is given to the *Cerebellar Columns*; and its designation, therefore, it seems advisable to retain. Some, however, and amongst them Dr. J. Reid, in his late very excellent description of the Anatomy of the Medulla Oblongata (*Edinb. Med. & Surg. Journal*, Jan. 1841), give the name to the columns that pass up from the posterior division of the spinal cord into the crus cerebri,—which are here called (after Sir C. Bell) the posterior pyramids; and apply the terms Posterior Pyramids to the Cerebellar column. The truth is that, as Sir C. Bell has justly observed, all the tracts of fibrous matter connecting the Brain with the Spinal Cord, have a somewhat *pyramidal* form; and it might be added that all have something of a *restiform* or cord-like aspect.

† Philosophical Transactions, 1835.

Varolii. The Pons has been correctly designated as the great Commissure of the Cerebellum, inclosing the Crura Cerebri; and its transverse fibres not only *surround* the longitudinal bands which connect the Cerebrum with the Spinal Cord, but *pass through* them; so as in some degree to isolate the

Fig. 140.

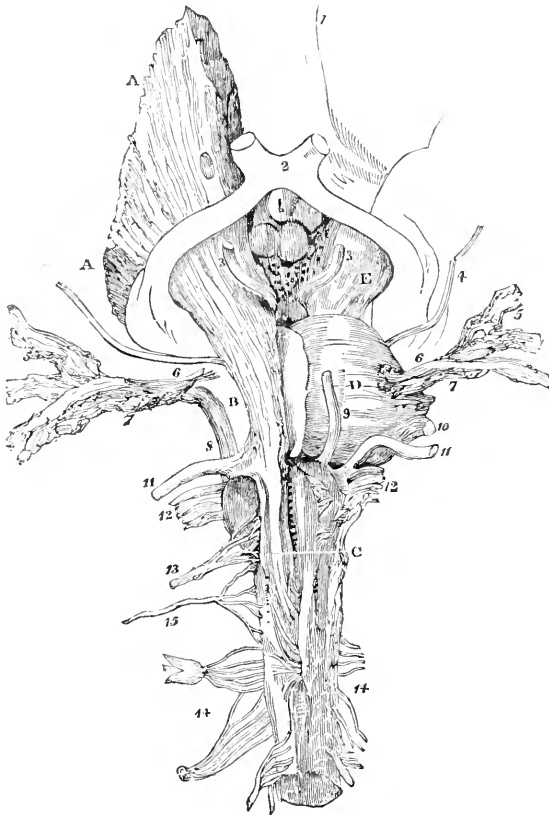

Course of the Motor tract, according to Sir C. Bell. A, A, fibres of the hemispheres, converging to form the anterior portion of the crus cerebri; B, the same tract where passing the crus cerebri; C, the right pyramidal body, a little above the point of decussation; D, the remaining part of the pons Varolii, a portion having been dissected off to expose E.—1, olfactory nerve, in outline; 2, union of optic nerves; 3, motor oculi; 4, 4, patheticus; 5, 5, trigemini; 6, 6, its muscular division; 7, 7, its sensory root; 8, origin of sensory root from the posterior part of the medulla oblongata; 9, abducens oculi; 10, auditory nerve; 11, facial nerve; 12, eighth pair; 13, hypoglossal; 14, spinal nerves; 15, spinal accessory of right side, separated from par vagum and glosso-pharyngeal.

two lateral halves from one another, and to form a complete septum between the anterior and posterior portions of each. The *Motor* tract is brought into view, by simply raising the superficial layer of the Pons, and tracing upwards and downwards the longitudinal fibres which then present themselves. It is

then found, that these fibres may be traced *upwards*, chiefly into the Corpora Striata, whence they radiate to the Hemispheres; and *downwards*, chiefly into the Anterior Pyramids. From this tract arise *all the Motor nerves* usually reckoned as Cranial; as will be seen in the accompanying Figure.—The *Sensory* tract is displayed, by opening the Medulla Oblongata on its posterior aspect; and then separating and turning aside the Restiform Columns, so as to bring into view the Posterior Pyramids, which lie on the outside of the calamus scriptorius. On tracing their fibres upwards, it is found that they form a part of the posterior layer of the Crura Cerebri, ultimately passing on to the Thalami optici, whence they radiate to the Hemispheres. From this tract, no motor nerves arise; but on tracing it downwards into the Spinal Cord, it is found that the *sensory* root of the fifth pair terminates in it, and that the

Fig. 141.

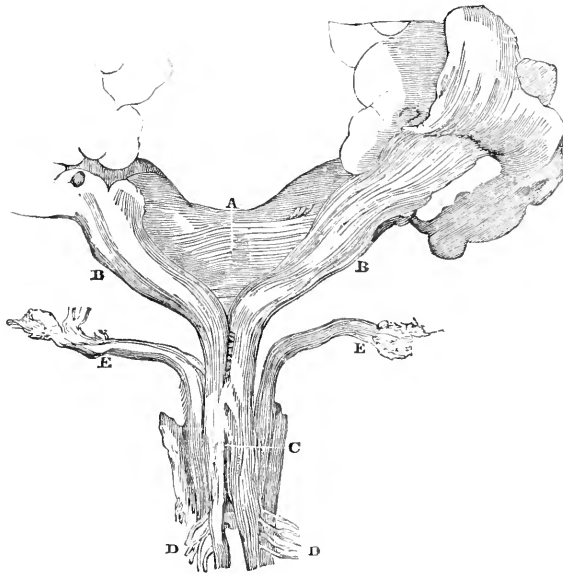

Course of the Sensory tract according to Sir C. Bell. A. Pons Varolii; B, B, sensory tract separated; C, union and decussation of posterior columns; D, D, posterior roots of spinal nerves; E, sensory roots of fifth pair.

posterior roots of the spinal nerves are evidently connected with its continuation. Also forming part of the posterior division of the crus cerebri, and separated from the anterior by the transverse septum, is a layer of fibres which ascends from the Olivary bodies, some of which terminate in the Corpora Quadrigemina.

352. On tracing *upwards* the four divisions of the Medulla Oblongata, the following are found to be their chief connections with the Brain.—1. The fibres of the Anterior Pyramids for the most part enter the Crura Cerebri, passing through the Pons Varolii, and traversing the Optic Thalami (which, it must be carefully borne in mind, have scarcely any real connection with the Optic Nerves, or with the sense of sight); after which they diverge and become intermingled with grey matter, thus forming the Corpora Striata, and finally radiate to the convolutions of the Cerebrum.—2. The fibres of the Olivary body also pass into the Pons Varolii, and there divide into two bands;

of which one proceeds upwards and forwards to join the Crus Cerebri, thence to pass to the Optic Thalami; whilst the other passes upwards and backwards into the Corpora Quadrigemina.—3. Of the true Restiform bodies, the fibres pass entirely into the Cerebellum.—4. Finally, of the Posterior Pyramids, the fibres pass directly onwards through the Crura Cerebri into the Thalami, whence they radiate to the convolutions.

353. The *downward* course of these fibres into the Spinal Cord now remains to be traced; and their arrangement is by no means a simple one.—1. The Anterior Pyramids decussate, as is well known, at their lower extremity;

[Fig. 142.]

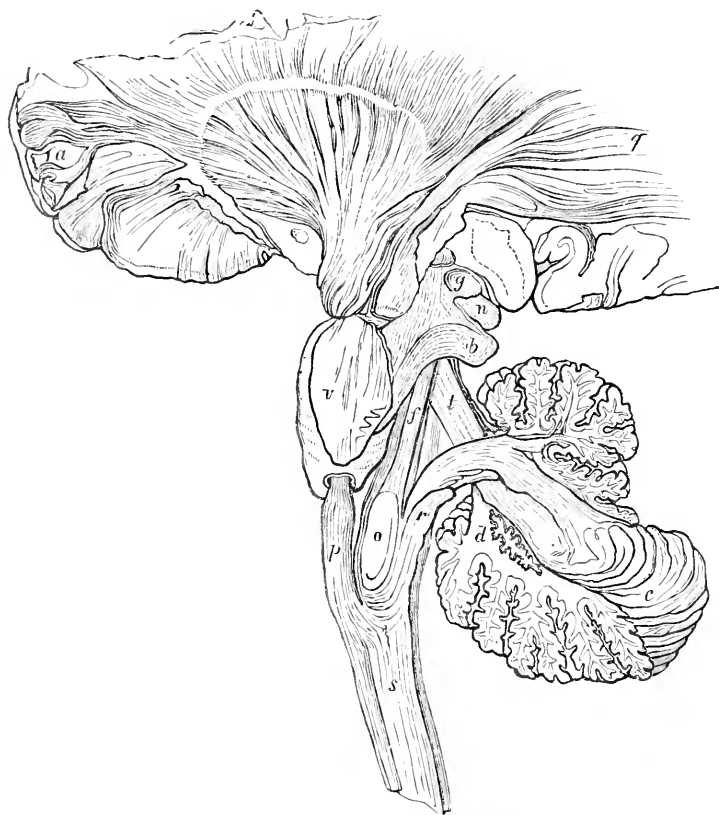

Analytical diagram of the encephalon—in a vertical section. (After Mayo.)

s. Spinal cord. r. Restiform bodies passing to, c the cerebellum. d. Corpus dentatum of the cerebellum. o. Olivary body. f. Columns continuous with the olivary bodies and central part of the medulla oblongata, and ascending to the tubercular quadrigemina and optic thalami. p. Anterior pyramids. v. Pons Varolii. n, b. Tubercular quadrigemina. g. Geniculate body of the optic thalamus. t. Processus cerebelli ad testes. a. Anterior lobe of the brain. q. Posterior lobe of the brain.]

the principal part (but not the whole) of the fibres on each side, passing over to the other. The *decussating* fibres pass *backwards* as well as downwards, and enter, not the anterior column of the spinal cord, (as commonly stated,) but the *lateral* column. The smaller bundle of fibres, which do not decussate, passes downwards, along with those of the olivary bodies, to form the *anterior* column.—2. The fibres descending from the Olivary bodies converge

as those of the pyramids pass backwards from between them, until they meet on the median line, forming the greater part of the *anterior* column.—3. The fibres of the Restiform, or Cerebellar columns,—which, like those of the Olivary columns, do not decussate, mostly pass downwards into the *posterior* columns; but a band (which has been termed, from its curved aspect, the *arciform* layer) passes forwards into the *anterior* columns: and another small fasciculus enters the *lateral* columns.—4. The fibres of the Posterior Pyramids are stated by Sir C. Bell to decussate like those of the anterior; they pass down chiefly into the posterior part of the *lateral* column, forming part also of the *posterior*.

354. The following tabular view may assist, better than any delineations could do, in the comprehension of this very intricate piece of Anatomy; the knowledge of which can be readily applied to the explanation of many curious pathological phenomena, and cannot but assist in the elucidation of others, whose rationale is as yet obscure.

SPINAL CORD.	MEDULLA OBLONGATA.	BRAIN.
Anterior Column	{ Arciform fibres of Cerebellar Columns } Cerebellum
Middle Column	{ Non-decussating portion of Ant. Pyramids } Corpora Striata
Posterior Column	{ Post. Pyramidal Columns (decussating?) } Cerebellum

355. The Medulla Oblongata is not to be viewed, however, solely as a series of connecting bands or commissures, between the Brain and Spinal Cord; for it contains vesicular matter of its own, in virtue of which it serves as a ganglionic centre to nerves that are specially connected with it. The vesicular matter is partly found in a situation corresponding to that which it occupies in the spinal cord; and it forms a tract, which is continuous above with the grey nucleus of the Corpora Quadrigemina, and below with that of the Spinal Cord; and which is opened out to view (as it were) on the floor of the fourth ventricle, forming the *calamus scriptorius*. Besides this central portion, there are other outlying masses, which are continuous with it. Thus the bulk of the Olivary body is principally due to the presence of a ganglionic mass in its interior; inclosed in the fibres of which the olivary column is composed, and which, for the most part, pass over and around it without entering it. This mass consists of a layer of grey matter, spread in a thin plicated stratum over a centre of white substance, and altogether forming what is known as the *corpus dentatum*. There is a considerable amount of vesicular substance in the Restiform bodies also; and this is continuous with the grey matter forming the posterior cornua in the Spinal Cord.

356. We have now to inquire into the character of the ganglionic masses, which form, with the Medulla Oblongata, the Encephalon of Vertebrated animals. We should be liable to form a very erroneous conception of the relative importance, and of the real nature, of these, if we were to study them only in the Brain of Man and of the higher animals; for the great development of *their* Cerebrum and Cerebellum throws into the shade (so to speak) certain other ganglionic centres, which constitute yet more essential parts of the nervous apparatus. It is one of the most interesting results of the comparison of the Human Brain with that of the lower tribes of Vertebrata, that the great change in the relative proportions of the parts, which we encounter in the latter, makes evident the real nature and importance of what would otherwise have been considered as subordinate appendages: whilst, at the same time, they afford us the connecting links, by which we are enabled to trace the real analogies of the different parts of the Encephalon with the ganglionic masses which represent it among Invertebrated animals.

357. Commencing with FISHES, we find a series of *four* distinct ganglionic masses, arranged in a line which is nearly continuous, from behind forwards, with that of the Spinal Cord; of these, the posterior is usually single, and on the median plane, whilst the others are in pairs. The posterior, from its position and connections, is evidently to be regarded in the light of a Cerebellum; and it bears a much larger proportion to the rest, in this class, than in any other. The pair in front of this are not the hemispheres of the Cerebrum, as their large size in some instances (the Cod for instance) might lead us to suppose; but they are immediately connected with the Optic nerve, which, in fact, terminates in them, and are therefore to be considered (like the chief part of the cephalic masses of Invertebrated animals) as Optic Ganglia. In front of these are the Cerebral Hemispheres, which are small, generally destitute of convolutions, and possess no ventricle in their interior,—except in the Sharks and Rays, in which they are much more highly developed than in the Osseous Fishes. Anterior to these is another pair of ganglionic enlargements, from which the Olfactory nerves arise; and these are, therefore, correctly designated as the Olfactive tubercles or ganglia. In some instances, these ganglia are not immediately seated upon the prolonged spinal cord, but are connected with it by long peduncles; this is the case in the Sharks; and we are thus led to perceive the real nature of the portion of the trunk of the Olfactory nerve in Man, which lies within the cranium, and of its bulbous expansion on the Ethmoid bone. Besides these principal ganglionic enlargements, there are often smaller ones, with which other nerves are connected. Thus, in the Shark, we find a pair of tubercles of considerable size, at the origin of the Trifacial nerves; and another pair, in most Fishes, at the roots of the Vagi. In some instances, too, distinct Auditory ganglia present themselves; as in the Carp.

Fig. 143.

Pike.

Cod.

Fox-shark.

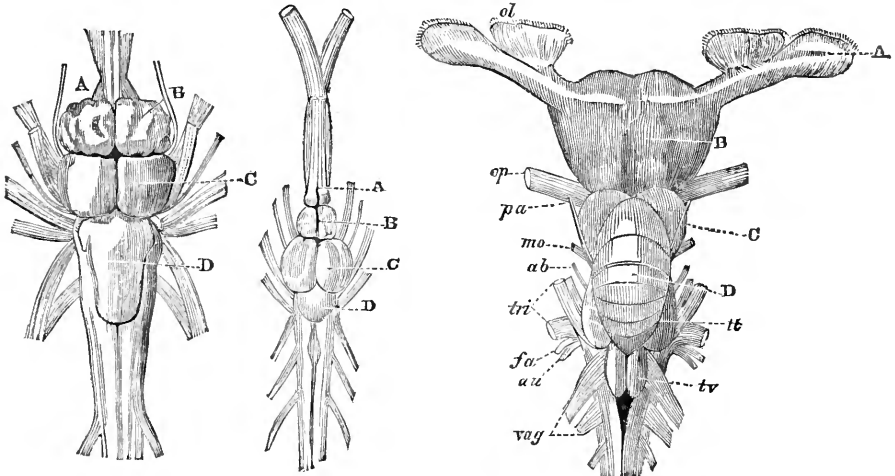

Brains of Fishes. A, olfactive lobes or ganglia; B, cerebral hemispheres; C, optic lobes; D, cerebellum; ol, olfactory nerve; op, optic nerve; pa, patheticus; mo, motor oculi; ab, abducens; tri, trifacial; fa, facial; vag, vagus; tt, tubercles or ganglia of the trifacial; tv, tubercles of the vagus.

358. The Optic Lobes of Fishes have no analogy whatever with the Thalami optici of Mammalia; the connection of which, with the Optic nerves, is

very slight. They are rather to be compared with the Tubercula Quadrigemina, which are the real ganglia of the Optic nerve. Their analogy is not so complete, however, to these bodies in the fully formed Brain of Man, as it is to certain parts which occupy their place at an earlier period. The *Third Ventricle*, which is quite distinct from the Corpora Quadrigemina, is hollowed out, as it were, from the floor of the Optic Lobes of Fishes; and the Anterior Commissure bounds its front; hence these must be considered as analogous to the parts surrounding the Third Ventricle, as well as to the Corpora Quadrigemina. This is made evident by the fact, observed by Müller, that, in the Lamprey, there is a distinct Lobe of the third ventricle, replacing the Optic Lobes of other Fishes, and partly giving origin to the optic nerves; and a separate vesicle, analogous to the Corpora Quadrigemina. With this condition, the early state of the Brain in the embryo of the Bird and Mammiferous animal, and even in Man himself, bears a very close correspondence. The Encephalon consists at this time of a series of vesicles, arranged in a line with

each other, of which those that represent the Cerebrum are the smallest, whilst that which represents the Cerebellum is the largest. The latter, as in Fishes, is single, covering the fourth ventricle on the dorsal surface of the Medulla Oblongata. Anterior to this, is the single vesicle of the Corpora Quadrigemina, from which the Optic nerve chiefly arises; this has in its interior a cavity, the ventricle of Sylvius, which exists even in the adult Bird, where the Corpora Quadrigemina are pushed, as it were, from each other by the increased development of the Cerebral hemispheres. In front of this is the vesicle of the Third Ventricle, which contains also the Thalami; as development proceeds, this, like the preceding, is covered by the enlarged hemispheres; whilst its roof becomes cleft anteriorly on the median line, so as to form the anterior entrance to the cavity. Still more anteriorly is the double vesicle, which represents the hemispheres of the

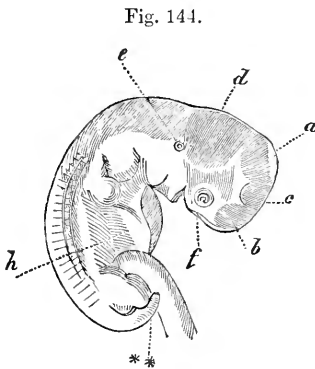

Human Embryo of sixth week, enlarged about three times; *a*, vesicle of corpora quadrigemina; *b*, vesicle of cerebral hemispheres; *c*, vesicle of thalami optici and third ventricle; *d*, vesicle for cerebellum and medulla oblongata; *e*, auditory vesicle; *f*, olfactory fossa; *h*, liver; ** caudal extremity.

Cerebrum; this has a cavity on each side, the floor of which is formed by the corpora striata. The cavity of the cerebral vesicles has at first no opening, except into that of the third ventricle; at a later period is formed that fissure on the inferior and posterior side, which (under the name of the fissure of Sylvius) enables the membranes enveloping the brain to be reflected into the lateral ventricles.

359. Thus it will be seen that the real analogy between the brain of the Human fœtus, and that of the adult Fish, is not so close as, from the resemblance in their external form, might have been supposed. In the small proportion which the Cerebral Hemispheres bear to the other parts, there is evidently a very close correspondence; and this extends also to the general simplicity of their structure, the absence of convolutions, and the deficiency of commissures. But there is a much nearer analogy between the *fœtal* brain of the Fish, and the *fœtal* brain of the Mammal; indeed, at the earliest period of their formation, they could not be distinguished; during their advance to the permanent condition, however, each undergoes changes, which are so much more decided in the higher animals than in the lower, that in the latter there seems but little departure from the fœtal condition, whilst in the former the condition

appears entirely changed. Hence it is not correct to assert, as is frequently done,—that the Brain, or any other organ, in the higher animals, passes through a series of forms, which are parallel to the permanent forms of the same organ in different parts of the animal scale; since the fact is rather, that the more nearly *all* are traced back to their first origin, the closer will their conformity be found to be; the subsequent development of each taking place not only in various degrees, but in different modes or directions; so that the resemblances presented by the higher, at different epochs of their evolution, to the permanent conditions of the lower, are often far from being complete.* This we have seen to be the case in the present instance; the vesicle of the Corpora Quadrigemina, and that of the third Ventricle, uniting to form the Optic Lobes of Fishes, whilst in the higher Vertebrata they remain distinct; so that there is no single part, with which the Optic Lobes can be properly compared, either in the fetal or perfect state of the Human Brain.

360. The Brain of REPTILES does not show any considerable advance in its general structure above that of Fishes; but the Cerebral Hemispheres are usually much larger in proportion to the Optic lobes; whilst the Cerebellum is smaller. The very low development of the Cerebellum is especially seen in the Frog (Fig. 132), in which it is so small as not even to cover in the Fourth Ventricle; but it is common to nearly the whole group. The deficiency in commissures still exists to a great extent. The anterior Commissure in front of the third ventricle, is the only uniting band which can be distinctly traced in Fishes; and Reptiles have, in addition to this, a layer of uniting fibres which may be compared to the Fornix; but as yet, there is no vestige of a true Corpus Callosum, or great transverse commissure of the hemispheres. The distinction between the tubercula quadrigemina, and the parts inclosing the third ventricle, is more obvious than in Fishes; in fact the Optic ganglia of Reptiles correspond pretty closely with the Vesicle of the tubercula quadrigemina in the brain of the fetal Mammal.

Fig. 145.

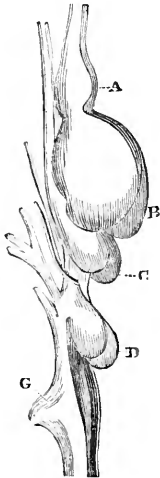

Brain of Turtle; A, olfactory ganglia; B, cerebral hemispheres; C, optic ganglia; D, cerebellum.

Fig. 146.

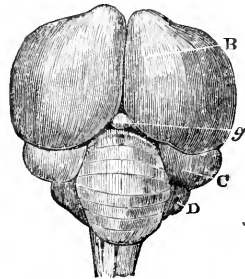

Brain of Buzzard; the olfactory ganglia are concealed beneath B, the hemispheres; C, optic ganglia; D, cerebellum; G, pineal gland

* For a fuller examination of this interesting question, see General and Comparative Physiology, § 244.

361. This is still more evident in BIRDS, in whose Encephalon the Tubercula Quadrigemina or Optic Ganglia, and the Thalami with their included ventricle, are obviously very distinct parts. The Cerebral Hemispheres attain a great increase of development, and arch backwards, so as partly to cover the Optic ganglia; and these are separated from one another, and thrown to either side. The Cerebellum also is much increased in size, proportionably to the Medulla Oblongata and its ganglia; and it is sometimes marked with transverse lines, which indicate the intermixture of grey and white matter in its substance; there is as yet, however, no appearance of a division into hemispheres. On drawing apart the hemispheres of the Cerebrum, the Corpora Striata, Optic Thalami, and Tubercula Quadrigemina or Optic Ganglia, are seen beneath them; the size of the last still bears a considerable proportion to that of the whole Encephalon. The Optic Ganglia are still hollow, as they are in the embryo condition of Man. Indeed the Brain of the Human fœtus about the twelfth week will bear comparison, in many respects, with that of the Bird. The Cerebral hemispheres, much increased in size, and arching back over the Thalami and Optic ganglia, but destitute of convolutions, and imperfectly connected by commissures,—the large cavity still existing in

Fig. 147.

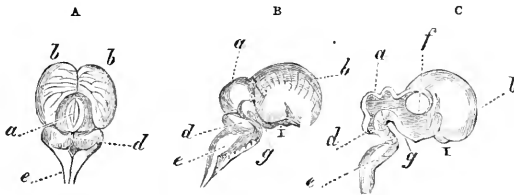

Brain of Human Embryo at twelfth week. A, seen from behind; B, side view; C, sectional view; a, corpora quadrigemina; bb, hemispheres; d, cerebellum; e, medulla oblongata; f, optic thalamus; g, floor of third ventricle; I, olfactory nerve.

the Optic ganglia, and freely communicating with the third ventricle,—and the imperfect evolution of the Cerebellum,—make the correspondence in the general condition of the two very considerable.

362. The Brain of the lowest MAMMALIA presents but a slight advance upon that of Birds, in regard both to the relative proportions of its parts, and to their degree of development. Thus, in the Marsupialia, the Cerebral hemispheres exhibit no convolutions; and the great transverse commissure,—the Corpus Callosum,—is deficient. There is gradually to be noticed, however, in ascending the scale, a backward prolongation of the Cerebral hemispheres; so that first the Optic ganglia, and then the Cerebellum, are covered by them. The latter partly shows itself, however, in all but the Quadrumana, when we look at the brain from above downwards; in the Rabbit, which is in this respect among the lowest of the true Viviparous Mammalia, nearly the whole of the Cerebellum is uncovered. In proportion to the increase of the Cerebral hemispheres, there is a diminution in the size of the ganglia immediately connected with the organs of sense; and this in comparison, not only with the rest of the Encephalon, but even

Fig. 148.

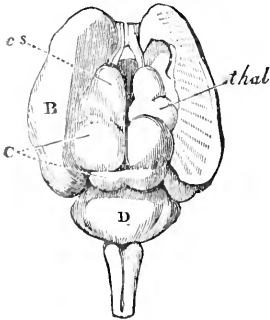

Brain of Squirrel, laid open; the hemispheres, B, being drawn to either side to show the subjacent parts:—c, the optic lobes; d, cerebellum; thal, thalamus opticus; cs, corpus striatum.

with the Spinal Cord; so that in Man the Tubercula Quadrigemina are absolutely smaller than they are in many animals of far inferior size. The inter-

Fig. 149.

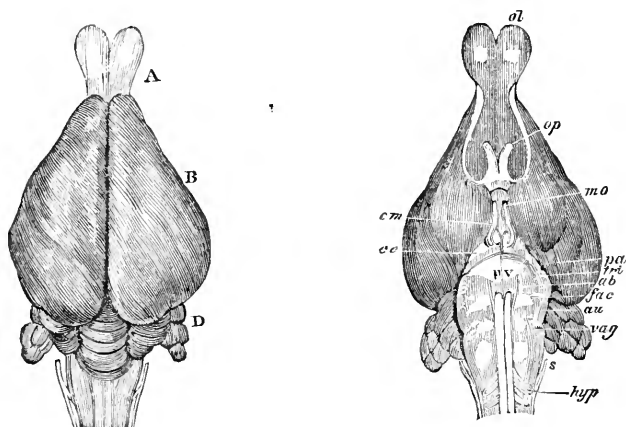

Upper and under surface of Brain of Rabbit. A, B, D, as before; *ol*, olfactory lobes; *op*, optic nerve; *mo*, motor oculi; *cm*, corpora mamillaria; *cc*, crus cerebri; *pv*, pons varolii; *pa*, patheticus; *tri*, trifacial; *ab*, abducens; *fac*, facial; *au*, auditory; *vag*, vagus; *s*, spinal accessory; *hyp*, hypoglossal.

nal structure of the hemispheres becomes more complex, in the same proportion as their size and the depth of the convolutions increase; and in Man all these conditions present themselves in a far higher degree, than in any other animal. In fact it is only among the Ruminantia, Pachydermata, Carnivora, and Quadrumana, that regular convolutions can be said to exist. The correspondence between the bulbous expansion of the Olfactive Nerves in Mammalia, and the Olfactive lobes of the lower Vertebrata, is made evident by the presence, in both instances, of a cavity which communicates with the lateral ventricle on each side; it is in Man only that this cavity is wanting. The external form of the Corpora Quadrigemina of Mammalia, differs from that of the Optic ganglia of Birds, owing to the division of the former into anterior and posterior eminences, (the nates and testes;) and there is also an internal difference, occasioned by the contraction of the cavity or ventricle, which now only remains as the Aqueduct of Sylvius. The Cerebellum is chiefly remarkable for the development of its lateral parts or hemispheres; the central portion, sometimes called the vermiform process, is relatively less developed than in the lower Vertebrata, in which it forms the whole of the organ.

4. General Functions of the Spinal Cord.—Reflex Action.

363. The functions of the Nervous System in Vertebrated Animals are so complex in their nature, and our means of analyzing them are so imperfect, that the inquiry is confessedly one of the greatest difficulty, and needs all the light which can be thrown upon it from any source. The great accession to our knowledge of them, which has been made within the last few years, chiefly by the labours of Sir C. Bell, and Dr. M. Hall, has so far changed the aspect of this department of Physiological Science, as to render it necessary for those who had previously studied it, to begin *de novo*. This is especially the case in regard to the actions dependent on the Spinal Cord; which it seems desirable to consider in the first instance, in order that it may be

clearly defined what the Brain does *not* do. By many, even in recent times, the Spinal Cord has been considered as a mere appendage to the Brain; but the phenomena of its independent action render such an idea quite inadmissible. These phenomena have been especially pointed out by Dr. M. Hall; and it is mainly owing to his arguments, that Physiologists are now for the most part agreed in the general fact,—that the Spinal Cord constitutes a distinct centre, or rather a collection of centres, of nervous influence, and that its operations are carried on through the nervous trunks with which it is connected. It is further generally admitted that its functions are independent of the will; and that they are in effect frequently opposed to those of the Brain, which operates on the muscles, either by a *volitional*, or by an *emotional* impulse. And lastly, its actions are always (except when excited by a physical irritation directly applied to itself) entirely of a *reflex* character; that is to say, the motor impulses which originate in it are not spontaneous, but result from the stimulus of impressions, conveyed to it by the afferent trunks, and operating upon it, to use the expression of Prochaska, according to certain “peculiar laws written, as it were, by nature on its medullary pulp.” It is not, however, universally admitted that these actions are independent of *sensation*; and some eminent physiologists, among whom may be named Dr. Alison, still hold that the intervention of sensation is necessary—in the case at least, of the ordinary associated movements, which have definite ends in view, and follow one another in regular succession, as those of Respiration,—for an impression to give rise to that organic change in the Spinal Cord, which shall terminate in a muscular motion.* It will be desirable, therefore, to consider the evidence upon which the statement rests, that reflex actions are independent of sensation, though ordinarily accompanied by it.

364. In the first place, then, it has long been well known that, in the Human being, the Spinal Cord does not by *itself* possess, in the remotest degree, the power of communicating sensory impressions to the mind; since, when its lower portion has been severed from the brain by injury or disease, there is complete anæsthesia of all the parts of the body, which derive their nerves exclusively from it. Hence it might be inferred, that throughout the Vertebrated classes, the spinal cord is equally destitute of sensibility; and that any movements produced by stimuli acting through it, are the results of a physical, and not of a sensorial change. This inference, however, has been disputed; and, if unsupported by other evidence, it would not, perhaps, be entitled to rank as an ascertained truth. The very performance, by decapitated animals of inferior tribes, of actions which had not been witnessed in Man under similar circumstances, has been held to indicate, that the spinal cord in them has an endowment which his does not possess. The possibility of such an explanation—however unconformable to that analogy throughout organized nature, which the more it is studied, the more invariably is found to guide to truth—could not be disproved. Whatever experiments on decapitated animals were appealed to, in support of the doctrine that the brain is the only seat of sensibility, could be met by a simple denial that the spinal cord is everywhere as destitute of that endowment, as it appears to be in Man. The cases of profound sleep and apoplexy might be cited, as examples of reflex action without consciousness; and these might be met by the assertion, that in such conditions sensations are *felt*, though they are not *remembered*. It is difficult, however, to apply such an explanation to the case of anence-

* See Outlines of Physiology, 3d edit., 211. By many of the German Physiologists, also, it is maintained that Sensation is a necessary link in the chain of reflex actions; but as they employ the term sensation in a sense which does not involve *consciousness*, it is obvious that their dissent from Dr. Hall's views is chiefly verbal.

phalous human infants (in which all the ordinary reflex actions have been exhibited, with an entire absence of brain), without supposing that the Medulla Oblongata is the seat of a sensibility which we know that the lower part of the Spinal Cord does not possess; and of this there is no evidence whatever.

365. Experiments on the lower animals, then, and observation of the phenomena manifested by apoplectic patients and anencephalous infants, *might* lead to the conclusion, that the Spinal Cord does not possess a sensibility, and that its reflex actions are independent of sensation. At this conclusion, Prochaska, Sir G. Blane, Flourens, and other physiologists, had arrived; but it was not until special attention was directed to the subject by Dr. M. Hall, that facts were obtained by which a positive statement of it could be supported. For the question might have been continually asked,—If the spinal cord in Man is precisely analogous in function to that of the lower Vertebrata, why are not its reflex phenomena manifested, when a portion of it is severed from the rest by disease or injury? The answer to this question is twofold. In the first place, simple division of the cord with a sharp instrument leaves the separated portion in a state of much more complete integrity, and therefore in a state much more fit for the performance of its peculiar functions, than it ordinarily is after disease or violent injury; and as the former method of division is one with which the Physiologist is not likely to meet in Man as a result of accident, and which he cannot experimentally put in practice, the cases in which reflex actions are manifested, are likely to be comparatively few. But, secondly, a number of such instances *have* now been accumulated, sufficient to prove that the occurrence is by no means so rare as might have been supposed; and that nothing is required but patient observation, to throw great light on this interesting question, from the phenomena of disease. A most valuable collection of such cases, occurring within his own experience, has been published by Dr. W. Budd;* and the leading facts observed by him will be now enumerated.

366. In the first case, paraplegia was the result of angular distortion of the spine in the dorsal region. The sensibility of the lower extremities was extremely feeble, and the power of voluntary motion was almost entirely lost. “When, however, any part of skin is pinched or pricked, the limb that is thus acted on jumps with great vivacity; the toes are retracted towards the instep, the foot is raised on the heel, and the knee so flexed as to raise it off the bed; the limb is maintained in this state of tension for several seconds after the withdrawal of the stimulus, and then becomes suddenly relaxed.” “In general, while one leg was convulsed, its fellow remained quiet, unless stimulus was applied to both at once.” “In these instances, the pricking and pinching were perceived by the patient; but *much more violent* contractions are excited by a stimulus, of *whose presence he is unconscious*. When a feather is passed lightly over the skin, in the hollow of the instep, as if to tickle, convulsions occur in the corresponding limb, much more vigorous than those induced by pinching or pricking; they succeed one another in a rapid series of jerks, which are repeated as long as the stimulus is maintained.” “When any part of the limb is irritated in the same way, the convulsions which ensue are very feeble, and much less powerful than those induced by pricking or pinching.” “Convulsions, identical with those already described, are at all times excited by the acts of defecation and micturition. At these times, the convulsions are much more vigorous than under any other circumstances, insomuch that the patient has been obliged to resort to mechanical means to secure his person while engaged in these acts. During the act of expulsion, the convulsions succeed one another rapidly, the urine is discharged

* Medico-Chirurgical Transactions, vol. xxii.

in interrupted jets, and the passage of the *faeces* suffers a like interruption." The convulsions are more vigorous, the greater the accumulation of urine; and involuntary contractions occur whenever the bladder is distended, and also when the desire to relieve the rectum is manifested. "In all these circumstances, the convulsions are perfectly involuntary; and he is unable, by any effort of the will, to control or moderate them." The patient subsequently regained, in a gradual manner, both the sensibility of the lower extremities, and voluntary power over them; and as voluntary power increased, the susceptibility to involuntary movements, and the extent and power of these, diminished.

367. This case, then, exhibits an increased tendency to perform reflex actions, when the control of the brain was removed; and it also shows that a slight impression upon the surface, of which the patient was not conscious, was more efficacious in exciting reflex movements, than were others that more powerfully affected the sensory organs. This is constantly observed in experiments upon the lower animals; and it harmonizes, also, with the important fact, that, when the *trunk* of an afferent nerve is pinched, pricked, or otherwise irritated, the reflex function will not be nearly so strongly excited, as when a gentler impression is made on a *surface* supplied by the branches of this nerve. The former produces *pain*, whilst the latter does not; the amount of sensation, therefore, does not at all correspond with the intensity of reflex action, but rather bears a converse relation to it. Mr. Grainger found, that he could remove the entire hind leg of a Salamander with the scissors, without the creature moving, or giving any expression of suffering, if the spinal cord had been divided: yet that, by irritation of the foot, especially by heat, in an animal similarly circumstanced, violent convulsive actions in the leg and tail were excited.—It should be added that, in the foregoing case, the nutrition of the lower extremities was not impaired, as in most cases of paraplegia. The rationale of this phenomenon, which is to be constantly observed when the reflex actions of the part remain entire, will be hereafter noticed (Chap. VII.).

368. In another case, the paralysis was more extensive, having been produced by an injury (resulting from a fall into the hold of a vessel) at the lower part of the neck. There was at first total loss of voluntary power over the lower extremities, trunk, and hands; slight remaining voluntary power in the wrists, rather more in the elbows, and still more in the shoulders. The intercostal muscles did not participate in the movements of respiration. The sensibility of the hands and feet was greatly impaired. There were retention of urine, and involuntary evacuation of the *faeces*. Recovery took place very gradually; and during its progress, several remarkable phenomena of reflex action were observed. At first, tickling one sole excited to movement that limb only which was acted upon; afterwards, tickling either sole excited both legs, and, on the 26th day, not only the lower extremities, but the trunk and other extremities also. Irritating the soles, by tickling or otherwise, was at first the only method, and always the most efficient one, by which convulsions could be excited. From the 26th to the 69th day, involuntary movements in all the palsied parts continued powerful and extensive, and were excited by the following causes:—In the lower extremities only, by the passage of flatus from the bowels, or by the contact of a cold urinal with the penis; convulsions in the upper extremities and trunk, attended with sighing, by plucking the hair of the pubes. On the 41st day, a hot plate of metal was applied to the soles, and found a more powerful excitor of movement than any before tried. The movements continued as long as the hot plate was kept applied; but the same plate, at the common temperature, excited no movements after the first contact. The contact was distinctly felt by the patient; but *no sensation of*

heat was perceived by him, although the plate was applied hot enough to cause vesication. At three different intervals, the patient took one-eighth of a grain of strychnia three times a day. Great increase of susceptibility to involuntary movements immediately followed, and they were excited by the slightest causes. No convulsions of the upper extremities could ever be produced, however, by irritating their integument; though, under the influence of strychnia, pulling the hair of the head, or tickling the chin, would occasion violent spasmodic actions in them. Spontaneous convulsions of the palsied parts, which occurred at other times, were more frequent and more powerful after the use of strychnia. On the first return of voluntary power, the patient was enabled to restrain in some measure the excited movements; but this required a distinct effort of the will; and the first attempts to walk were curiously affected, by the persistence of the susceptibility to excited involuntary movements. When he first attempted to stand, the knees immediately became forcibly bent under him; this action of the legs being excited by contact of the soles with the ground. On the 95th day this effect did not take place, until the patient had made a few steps; the legs then had a tendency to bend up, a movement which he counteracted by rubbing the surface of the belly: this rubbing excited the extensors to action, and the legs became extended with a jerk. A few more steps were then made; the manœuvre repeated, and so on. This susceptibility to involuntary movements from impressions on the soles, gradually diminished; and on the 141st day, the patient was able to walk about, supporting himself on the back of a chair which he pushed before him; but his gait was unsteady, and much resembled that of chorea. Sensation improved very slowly: it was on the 53d day that he first slightly perceived the heat of the metal plate.

369. This important case suggests many interesting reflections. Common sensation was not so completely abolished as in the former instance; but of the peculiar kind of impression, which was found most efficacious in exciting reflex movements, *no consciousness whatever was experienced*. Not less interesting was the circumstance, that convulsions could be readily excited by impressions on surfaces *above* the seat of injury; as, by pulling the hair of the scalp, a sudden noise, and so on. This proves two important points: first, that a lesion of the cord may be such, as to intercept the transmission of voluntary influence, and yet may allow the transmission of that reflected from incident nerves. Secondly, that all influences from impressions on incident nerves are diffused through the cord; for, in the instance adduced, the reflected influence was undoubtedly not made to deviate into the cord by the morbid condition of that organ, but followed its natural course of diffusion, being rendered manifest in this case by the convulsions which were excited, in consequence of increased activity of the motor function of the cord. It is further interesting to remark, that, in the foregoing case, the reflex actions were very feeble during the first seven days, in comparison with their subsequent energy; being limited to slight movements of the feet, which could not always be excited by tickling the soles. In another case of very similar character, it was three days after the accident, before any reflex actions could be produced. It is evident, then, that the spinal cord must have been in a state of concussion, which prevented the manifestation of its peculiar functions, so long as this effect lasted; and it is easy, therefore, to perceive, that a still more severe shock might permanently destroy its power, so as to prevent the exhibition of any of the phenomena of reflex action.

370. It seems well established, then, by such cases, that the Spinal Cord, or small segments of it, may serve in Man as the centre of very energetic reflex actions; when the voluntary power exercised through the Brain, over the muscular system, is suspended or destroyed. And it is further evident,

that these movements are produced by a mere physical change in the nervous centres; the consciousness of the individual not being affected in their performance, and sensation having therefore no necessary participation in them. As the movements witnessed in the lower animals, under the same circumstances, are altogether of a similar character, there seems no good reason to attribute to *their* Spinal Cord an attribute, of which it is certainly destitute in Man. There is no essential difference, either in structure, or in the nature of the actions performed by them, between the Spinal Cord and the Medulla Oblongata, which can warrant us in assigning to the latter a function that the former does not possess: and if the reflexions of the Spinal Cord do not involve sensation, there is good reason for concluding, that this change is not a necessary element in those of the Medulla Oblongata. It is perfectly true, that it usually *accompanies* in us the greater number of actions, to which that division of the centre is subservient; for example, those of respiration and deglutition: and it is scarcely possible for such an accident to occur in the Human being, as the separation of the Medulla Oblongata from the brain, without the destruction of the independent functions of both. It is not likely that we can ever have the power of ascertaining, by the testimony of a patient so affected, that the Respiratory movements are performed without the necessary intervention of sensation; as we have been able to do in regard to other reflex movements. But as the general fact is, that there is no positive ground whatever for regarding any part of the Spinal Cord as a *sensorium* independent of the brain, and that the Respiratory movements certainly correspond in all their conditions with the actions denominated reflex,—there would seem no good reason for maintaining that sensation is an element in *their* production, whilst it is admitted to be not essential in the case of the less regular convulsive actions already described. The character of *adaptiveness* to a designed end, in regard to their combination and succession, which the movements of respiration and deglutition exhibit, has been shown to be no proof of their dependence on sensation.

371. The question has been often put to those who advocate this view,—why the sensation should be so constantly associated with these changes, if not essential to produce the motion? An objection might fairly be made to any reasoning from final causes, in a question of facts; but the inquiry may be easily answered. In many instances the production of sensations is the stimulus necessary for the excitement of *other* actions, which are required for the *continued maintenance* of those in question. This may be rendered more comprehensible by a simple illustration.—A cistern filled with water may be speedily emptied by a cock occasionally opened at the bottom; but, if it communicate with a reservoir, by means of a valve opened by a ball floating on the surface of the water it contains, it may be kept constantly full. The lower cock is opened, and the water flows out; and, in consequence of the lowering of the surface thus produced, the floating valve above is opened, and the cistern is refilled from the reservoir. Now here the action of the ball-cock at the top is not essential to the flow of water at the bottom, but is rather consecutive upon it.—Just so is it with regard to those movements of Animals, which are concerned in the ingestion of their food. The muscular contractions required to propel it along the alimentary canal, from the stomach downwards, are provided for, without even the intervention of the nervous system. To bring it within reach of these, a muscular apparatus is provided, by which anything that comes within its grasp is conveyed downwards, through a reflex operation, originating in the impression made upon the surface of the pharynx. Now this action, in the ordinary condition, may be considered as attended with sensation, in order that the Animal may be called upon to execute those other movements, which will bring food within the

reach of the apparatus of deglutition. The Polype is dependent for its supplies of aliment, upon what the currents in the surrounding fluid, or other chances, bring into its neighbourhood; but anything which touches its tentacula, is entrapped and conveyed into its stomach. The anencephalous Infant, again, can swallow, and even suck; but it can execute no other movements adapted to obtain the supply of food continually necessary for maintenance, because it has not a mind which sensations could awake into activity.

372. The sensation connected with reflex actions has not only this important end, but it frequently contributes to enjoyment, as in suction and ejaculatio seminis. Now there is evidence that the latter of these processes, involving though it does the combined action of a number of muscles, and dependent as it seems upon sensation of a very peculiar kind, may take place without consciousness on the part of the individual. Brachet mentions a case of this kind in the Human subject, in which the patient's own testimony could be adduced; and he ascertained that emission could be produced in dogs, in which the spinal cord had been divided in the back, and in which, therefore, it can scarcely be doubted that the sensibility of the genital organs was destroyed. Such cases, it might be thought, are sufficient to prove, that the Reflex power, operating independently of sensation, is not confined to such irregular convulsive movements as are seen in Man after disease or injury; but is exercised in producing the regular combined actions which are necessary for the maintenance of the organic functions. The sensation accompanying these actions, moreover, frequently affords premonition of danger, or gives excitement to supplementary actions destined to remove it, as in the case of respiration; for where anything interferes with the due discharge of the function, the uneasy sensation that ensues occasions unwonted movements, which are more or less adapted to remove the impediment, in proportion as they are guided by judgment as well as by consciousness. Again, sensation often gives warning against inconvenience, as in the excretory functions; and here it is very evident, that its object is not only (if it be at all) to excite the associated muscles necessary for the excretion, but actually to make the Will set up the antagonizing action of the sphincters, as will be hereafter explained (§ 391). There is one unequivocal case, in the ordinary condition of the human body, of reflex action without sensation; this is the muscular contraction, by which the food is propelled from the bottom of the pharynx to the stomach. Unless the morsel be very bulky, so as to press on the surrounding parts, or be very different in temperature from the surface it touches, or have any peculiar irritating quality, we are not more conscious of its presence, whilst it is passing down the lower part of the œsophagus, than when it is being propelled along the intestinal tube; and yet, as Dr. J. Reid's experiments* have shown, this contraction is of a reflex character, not being stimulated by direct contact, but requiring the completeness of the nervous circle for its performance.

373. We shall now separately consider the chief operations, in which the Spinal Cord and its system of nerves are usually concerned, in the ordinary course of the vital actions of the Human body. Upon taking a general survey of these, it will be found that their principal function is, *to supply the conditions requisite for the maintenance of the various Organic processes.* Thus, the aeration of the blood, which takes place whenever that fluid is placed in relation with the atmosphere, can only be carried on, by the regular exchange of the small quantity of the gas contained in the lungs; if this cease, the circulation is soon brought to a stand, and loss of vitality of the whole system speedily results. Hence this is the most constantly necessary

*. Edinb. Med. and Surg. Journ., vol. xlix.

of all the actions of the Spinal Cord; and we find its maintenance, in spite of accident or disease of the spine, remarkably provided for, in the location of the centre of the respiratory movements, which occupies a position where it receives the greatest possible amount of protection. The supply of the digestive apparatus, again, is immediately dependent upon the Spinal system; and this, being another essential function, has its centre equally protected. The outlets of the cavities are also controlled by the Spinal system; but this control, although essential to the comfort of life, is less necessary to its maintenance; and we find it dependent upon a portion of the Cord, which is more liable to lose its powers by disease or injury. It is possible, as will hereafter be shown, that several actions, which are at first voluntary, may be effected, when so frequently performed as to become habitual, through the medium of the Spinal system; of this kind seem to be the movements of locomotion, which are continued involuntarily, when the whole attention of the mind is given to other objects, but which the Will can check at any time. We shall commence our particular survey of the Reflex movements in Man, with the consideration of those of Respiration, which are well adapted for illustrating their general character.

374. *Respiratory Movements.*—The centre of these is the upper part of the Medulla Oblongata; into this may be traced the *excitor* nerves, that convey the stimulus on which the movements are dependent; and from it proceed, either directly or indirectly, the *motor* nerves by which they are carried into effect. The chief Excitor of the respiratory movements is unquestionably the Par Vagus. When this is divided on both sides, according to the experiments of Dr. Reid,* the number of respiratory movements is considerably diminished, usually about one-half. Now if this nerve excites the motions of respiration by its powerful action in producing sensation, we should expect to find its trunk endowed with considerable sensibility, which is not the case; for all experimenters agree in stating that, when its trunk is pinched or pricked, the animal does not exhibit signs of pain nearly so acute, as when the trunks of the ordinary spinal nerves, or of the fifth pair, are subjected to similar treatment. It cannot be questioned, however, that its power as an excitor of respiration is very great; since, besides the fact of the diminution in the number of inspirations which occurs immediately on section of it, irritation of its trunk in the neck is instantly followed by an act of inspiration. It is evident that this power must arise from impressions made upon its peripheral extremities. The impression is probably due to the presence of venous blood in the capillaries of the lungs; or, as Dr. M. Hall thinks, to the presence of carbonic acid in the air-cells. Either or both may be true.—The Pneumogastric nerve, however, is *not* the *only* excitor of the respiratory movements; since, when the nerve is cut on each side, they still continue. Dr. Reid has satisfactorily shown the statement of many experimenters, that the inspirations are *increased* in frequency after this operation, to be erroneous; this idea having originated in their very prolonged and laborious character. The removal of the Encephalon, also, diminishes the frequency of the respiratory movements, whether it be performed before or after the section of the Vagi. Dr. Reid found that, in a kitten of a day old, in which the inspirations were 100 per minute, they fell to 40 when the Encephalon was removed; and on subsequently cutting the Pneumogastrics, the number of inspirations instantly fell to between 3 and 4 in the minute, and continued so for some time. Hence it appears that the respiratory movements are partly dependent upon sensation, and a motor influence excited by it; and this may also be learned from the prolonged and laborious character of the inspirations

* Edinb. Med. and Surg. Journ., vol. li.

during sleep or profound attention, when the influence of the *Encephalon* is more or less suspended.

375. But why (it may be asked) do the movements continue, when the *Pneumogastrics* have been divided, and the *Encephalon* has been removed? It is evident that there must be other excitors to the action of the respiratory muscles. Amongst these, the nerves distributed to the general surface, and particularly to the face, probably perform an important part; and in exciting the first inspiration, the Fifth pair seems the principal agent. It has long been a well-known fact, that the first inspiratory effort of the new-born infant is most vigorously performed, when the cool external air comes into contact with the face; and that impressions on the general surface, such as a slap of the hand on the nates, are often effectual in exciting the first inspiratory movements, when they would not otherwise commence. Dr. M. Hall relates an interesting case, in which the first inspiration was delayed, simply because the face was protected by the bed-clothes from the atmosphere; and, on lifting up these, the infant immediately breathed. Dr. M. Hall has recently mentioned the important fact, that if the *cerebrum* be removed, and the *pneumogastrics* be divided, in a young kitten, the number of acts of respiration will be reduced to four in a minute; but by directing a stream of air on the animal, or by irritating various parts of the general surface, we may excite twenty or thirty acts of respiration within the same space of time. He further remarks, that in the very young warm-blooded animal, as in the cold-blooded animal, the phenomena of the excito-motor power are far more vividly manifested, than in the older and the warm-blooded. In the very young kitten, even when asphyxiated to insensibility, every touch, contact, or slight blow,—every jar of the table, any sudden impression of the external air, or that of a few drops of cold water, induces at once energetic reflex movements, and acts of inspiration. This may be looked upon as Nature's provision for the first establishment of the acts of inspiration in the new-born animal.—But the influence of the nerves of the general system is by no means wanting in the adult; as the following experiment of Dr. J. Reid's demonstrates. After dividing the *pneumogastrics*, and removing the *cerebrum* and *cerebellum*, he divided the spinal cord high up in the neck, so as to cut off the communication between the spinal nerves and the *Medulla Oblongata*; and he found that the frequency of the respiratory movements was still further diminished, although they were not even then entirely suspended.—Every one knows the fact, that the first plunge into cold water, the first descent of the streams of the shower-bath, or even the dashing of a glass of cold water in the face, will produce inspiratory efforts; and this fact has many important practical applications. Thus in the treatment of *Asphyxia*, whether congenital, or the result of narcotic poisoning, drowning, &c., the alternate application of cold and heat is found to be one of the most efficacious means of restoring the respiratory movements; and a paroxysm of hysteric laughter may be cut short, by dashing a glass of cold water in the face.—It may be surmised that the *Sympathetic* nerve, which derives many filaments from the *Cerebro-Spinal* system, and which especially communicates with the *Pneumogastric* nerves, is one of the excitors to this function; and this, perhaps, not only through its ramifications in the lungs, which are considerable, but also by its distribution on the systemic vessels; so that it may convey to the *Spinal Cord* the impression of imperfectly-arterialized blood, circulating in these, such as the *Pneumogastric* is believed to transmit from the lungs. It will hereafter be shown, that an impression of a corresponding kind is more probably the cause of the sense of Hunger and Thirst, than any which originates in the stomach alone (Chap. X., Sect. 1).

376. The Motor or Efferent nerves concerned in the function of Respira-

tion, are those which Sir C. Bell has grouped together in his respiratory system. The most important of these, the Phrenic, arises from the upper part of the Spinal Cord; the Intercostals much lower down; whilst the Facial nerve and the Spinal Accessory, to the latter of which, as will hereafter be stated (§ 408), the motor powers of the par vagum are chiefly due, take their origin in the Medulla Oblongata itself. But we must not decide upon the connection of a particular nerve with a particular segment of the Spinal Cord, simply because it diverges from it at that point. It has been shown that, in the Mollusca, a nerve passing to, or proceeding from, one ganglion, frequently passes through or over another which lies in its course; and in the Articulata, this is a still more constant occurrence. It is by no means improbable, then, that the connection of the intercostal nerves is really in part with the grey matter of the Medulla Oblongata; at any rate, such a connection has not been disproved. The white columns of the Spinal Cord consist of fibres, which bring the spinal nerves into connection, not only with the brain, but also with other segments of the ganglionic portion of the cord; being analogous in function, not merely to the distinct fibrous tract of the ventral column of the Articulata, but also to the fibrous bands that connect the ganglia themselves. And as the Medulla Oblongata, in Vertebrated animals, is the chief centre of the actions of Respiration, it can scarcely be doubted that all the nerves concerned in that function have a direct structural connection with it.

377. That the Respiratory movements, as ordinarily performed, are essentially independent of the Will, appears not only from our own consciousness, but also from cases of paralysis; in some of which, the power of the will over the muscles has been lost, whilst the movements have been kept up by the reflex action of the Medulla Oblongata or respiratory ganglion; whilst in others, some of the respiratory muscles have been motionless during ordinary breathing, and yet have remained under the power of the will. Such cases are mentioned by Sir C. Bell, in the Appendix to his work on the Nervous System. That consciousness is not a necessary link in the chain of causes, which produce the respiratory movements, we are enabled to judge from the phenomena presented by the human being in sleep and coma, by anencephalous fetuses, and by decapitated animals. Further, Dr. Ley* has put on record a case, which confirms this particular inference, just in the same manner as the cases already related confirm the general doctrine of the non-existence of sensibility in the Spinal Cord. He had under his care a patient, in whom the par vagum appeared to be diseased; the lungs suffered in the usual way in consequence, and the patient had evidently laborious breathing; but he distinctly said that he felt no uneasiness in his chest.—The experience of every one informs him, that Respiratory movements are partly under the control and direction of the will, though frequently unrestrainable by it. In ordinary circumstances, when the blood is being perfectly aerated, and there is a sufficient amount of arterial blood in the system to carry on the functions of life for a short time, we can suspend the respiratory actions during a few seconds without any inconvenience. If, however, we endeavour to prolong the suspension, the stimulus conveyed by the excitor nerves to the Medulla Oblongata becomes too strong, and we cannot avoid making inspiratory efforts; and if the suspension be still further prolonged, the whole body becomes agitated by movements, which are almost of a convulsive nature; and no effort of the will can then prevent the ingress of air.† It is easy to understand why, in

* On Laryngismus Stridulus, p. 417.

† It is asserted by M. Bourdon (Récherches sur le Mécanisme de la Respiration, p. 81), that no person ever committed suicide, though many have attempted to do so, by simply holding the breath; the control of the will over the respiratory muscles not being sufficiently great, to antagonize the stimulus of the "besoin de respirer," when this has become aggra-

the higher animals at least, and more especially in Man, the respiratory actions should be thus placed under the control of the will: since they are subservient to the production of those sounds, by which individuals communicate their feelings and desires to each other; and which, when articulate, are capable of so completely expressing what is passing in the mind of the speaker. If the respiratory muscles of Man were no more under his control, than they appear to be in the Insect or Molluscous animal, he might be provided with the most perfect apparatus of speech, and yet he would not be able to employ it to any advantage.

378. The motor power of the Respiratory nerves is exercised, however, not only on the muscles which perform the inspiratory and expiratory movements, but on those which guard the entrance to the windpipe, and also on certain other parts. The movements of the internal respiratory apparatus are chiefly, if not entirely, effected through the medium of the motor fibres, which the Par Vagum contains. These motor fibres exist in very different amount in its different branches. For example, the pharyngeal and œsophageal branches, by which (as will hereafter appear) the muscles of deglutition are excited to contraction, possess a much larger proportion of them, and exhibit much less sensibility when irritated, than do other divisions of the trunk. Between the superior and inferior laryngeal nerves, again, there is an important difference, which anatomical and experimental research has now very clearly demonstrated. It has long been known, that section of the Par Vagum in the neck, above the inferior laryngeals, is frequently followed by suffocation, resulting from closure of the glottis; and hence it has been inferred, that the office of the inferior laryngeals was to call into action the dilators of the larynx, whilst the superior laryngeals were supposed to stimulate the constrictors. This view, however, is incorrect. It is inconsistent with the results, just stated, of anatomical examination into the respective distribution of these two trunks; and it has been completely overthrown by the very careful and satisfactory observations and experiments of Dr. J. Reid, which have established that, whilst the *inferior* laryngeal is the *motor* nerve of nearly all the laryngeal muscles, the *superior* laryngeal is the *excitor* or *afferent* nerve, conveying to the Medulla Oblongata the impressions by which muscular movements are excited. Its motor endowments are limited to the crico-thyroid muscle, to which alone of all the muscles its filaments can be traced, the remainder being distributed beneath the mucous surface of the larynx; and its sensibility is very evident, when it is pinched or irritated during experiments upon it. On the other hand, the motor character of the inferior laryngeal branch is shown by its very slight sensibility to injury, its nearly exclusive distribution to muscles, and its influence in exciting contraction of these when its separated trunk is stimulated.

379. It has been ascertained by Dr. Reid that, if the inferior laryngeal branches be divided, or the trunk of the par vagum be cut above their origin from it, there is no constriction of the glottis, but a paralyzed state of its muscles. After the first paroxysm occasioned by the operation, a period of quiescence and freedom from dyspnœa often supervenes, the respirations being performed with ease, so long as the animal remains at rest; but an unusual respiratory movement, such as takes place at the commencement of a struggle, induces immediate symptoms of suffocation,—the current of air carrying inwards the arytenoid cartilages, which are rendered passive by the paralyzed

vated by the temporary cessation of the action. But such persons have succeeded better, by holding the face beneath the surface of water; because here another set of muscles is called into action, which are much more under the control of the will, than are those of respiration; and a strong volition applied to these can prevent all access of air to the lungs, however violent may be the inspiratory efforts.

state of their muscles; and these, falling upon the opening of the glottis, like valves obstruct the entrance of air into the lungs. The more effort is made, the greater will be the obstruction: and accordingly, it is generally necessary to counteract the tendency to suffocation, when it is desired to prolong the life of the animal after this operation, by making an opening into the trachea. Dr. Reid further ascertained that the application of a stimulus to the inferior laryngeal nerves, when separated from the trunk, would occasion distinct muscular contractions in the larynx; whilst a corresponding stimulus applied to the superior laryngeal occasioned no muscular movement, except in the crico-thyroid muscle. But when the superior laryngeals were entire, irritation of the mucous surface of the larynx, or of the trunks themselves, produced contraction of the glottis and efforts to cough; effects which were at once prevented by dividing those nerves, and thereby cutting off their communication with the Medulla Oblongata. There can be no doubt, then, that the superior and inferior laryngeal branches constitute the circle of incidents and motor nerves, by which the aperture of the glottis is governed, and by which any irritation of the larynx is made to close the passage, so as to prevent the entrance of improper substances; whilst the superior laryngeal nerve also excites the muscles of expiration, so as to cause the violent ejection of a blast of air, by which the offending gas, fluid, or solid, may be carried off. The effect of carbonic acid in causing spasmodic closure of the glottis is well known; and affords a beautiful example of the protective character of this system of nerves. The mucous surface of the trachea and bronchi appears, from the experiments of Valentin, to be endowed with excitability, so that stimuli applied to it produce expiratory movements; and this evidently operates through the branches of the par vagum distributed upon the membrane. Here, as elsewhere, we find that a stimulus applied to the *surface* has a much more decided influence than irritation of the *trunk* of the nerve supplying it.

380. The actions of *sighing*, *yawning*, *sobbing*, *laughing*, *coughing*, and *sneezing*, are nothing else than simple modifications of the ordinary movements of respiration, excited either by mental emotions, or by some stimulus originating in the respiratory organs themselves.—*Sighing* is nothing more than a very long-drawn inspiration, in which a larger quantity of air than usual is made to enter the lungs. This is continually taking place to a moderate degree; and we notice it particularly, when the attention is released, after having been fixed upon an object, which has excited it strongly, and which has prevented our feeling the insufficiency of the ordinary movements of respiration. Hence this action is only occasionally connected with mental emotion.—*Yawning* is a still deeper inspiration, which is accompanied by a kind of spasmodic contraction of the muscles of the jaw, and also by a very great elevation of the ribs, in which the scapulæ partake. The purely involuntary character of this movement is sometimes seen, in a remarkable manner, in cases of palsy; in which the patient cannot raise his shoulder by an effort of the will, but does so in the act of yawning. Nevertheless this act may be performed by the will, though not completely; and it is one that is particularly excited by an involuntary tendency to imitation; as every one must have experienced, who has ever been in company with a set of yawners.—*Sobbing* is the consequence of a series of short convulsive contractions of the diaphragm; and it is usually accompanied by a closure of the glottis, so that no air really enters. In *Hiccup*, the same convulsive respiratory movement occurs; and the glottis closes suddenly in the midst of it; the sound is occasioned by the impulse of the column of air in motion, against the glottis.—In *Laughing*, a precisely reverse action takes place: the muscles of expiration are in convulsive movement, more or less violent, and send out the breath in a series of jerks, the glottis being open. This sometimes goes on, until the diaphragm is more

arched, and the chest is more completely emptied of air, than it could be by an ordinary movement of expiration.—The act of *Crying*, though occasioned by a contrary emotion, is, so far as the respiration is concerned, very nearly the same as the last. Every one knows the effect of mixed emotions, in producing an expression of them, which is “between a laugh and a cry.”—The greater part of the preceding movements seem to belong as much to the *consensual* or *emotional*, as to the purely *reflex* group of actions; for whilst they are sometimes the result of peculiar states of the respiratory organs, or of the bodily system in general, they may also be called forth by influences, which operate directly through the senses, or which excite the emotions. Thus, whilst Sighing and Yawning often occur as simple results of deficient aeration, they may be brought on,—the former by a depressed state of the feelings,—the latter by the mere sight of the act in another person. The actions of Laughter and Crying never seem to originate in the respiratory system; but to be always either expressions of the emotions, or simple results of sensations,—crying being connected with the sense of pain,—and laughter with that of tickling. The origin of the act of Hiccup does not seem very clear; but the movement is probably of a purely reflex nature.

381. The purposes of the acts of Coughing and Sneezing are, in both instances, to expel substances from the air-passages, which are sources of irritation there; and this is accomplished in both, by a violent expiratory effort, which sends forth a blast of air from the lungs.—*Coughing* occurs, when the source of irritation is situated at the back of the mouth, in the trachea, or bronchial tubes. The irritation may be produced by acrid vapours, or by liquids or solids, that have found their way into these passages; or by secretions which have been poured into them in unusual quantity, as the result of disease; or by the simple entrance of air (especially if cold), when the membrane is in a peculiarly irritable state. Any of these causes may produce an impression upon the excitor fibres of the Par Vagum, which, being conveyed to the Medulla Oblongata, shall give rise to the transmission of motor impulses to the several muscles, that shall combine them in the act of coughing. This act consists,—1st, in a long inspiration, which fills the lungs; 2d, in the closure of the glottis at the moment when expiration commences; and 3d, in the bursting open (as it were) of the glottis, by the violence of the expiratory movement; so that a sudden blast of air is forced up the air-passages, carrying before it anything that may offer an obstruction.—The difference between coughing and *Sneezing* consists in this,—that in the latter, the communication between the larynx and the mouth is partly or entirely closed, by the drawing together of the sides of the velum palati over the back of the tongue; so that the blast of air is directed, more or less completely, through the nose, in such a way as to carry off any source of irritation that may be present there.—It is difficult to say how far these actions are simply reflex; or how far they may require the stimulus of sensation for their performance.

382. *Deglutition and Defecation*.—Another very important function of the Spinal Cord (and of the ganglia corresponding to it in the Invertebrata), is the control which it exercises over the entrance and termination of the Alimentary Canal; and this reflex action might probably be traced in some animals, in which the necessity for that of Respiration does not exist. In all beings which are unequivocally of an *animal* character, a stomach or digestive cavity exists; and a means must be provided for the introduction of food into it. This is partly accomplished by the power, with which its entrance is endowed, of contracting upon, and of attempting to draw inwards, whatever comes in contact with it; as we may readily observe in the Star-Fish, or Sea-Anemone, where what is commonly regarded as the mouth, is really the aperture of the stomach. But we almost always find some more special apparatus, for bring-

ing food within reach of this orifice. In the Sea-Anemone, the Hydra, and other Polypes, for example, we find that aperture surrounded by tentacula; which have an evident tendency to lay hold of anything that touches them, so as to bring it, by their contraction, within reach of the muscles immediately surrounding the aperture. This is just the purpose of the pharyngeal muscles of Man. The lower part of the œsophagus, near its termination in the stomach, has the same simple tendency to contraction from above downwards (so as to convey into the stomach anything which is brought within its reach), as have the muscles surrounding the mouth of the Polype; but there is need of some more complex apparatus, for the purpose of laying hold of the food, and of conducting it into its grasp. This is provided for, in the higher animals, in the muscles of that funnel-like entrance to the œsophagus, which is called the Pharynx. The actions of these are most distinctly *reflex*; and it is interesting to remark, that the movements can neither be caused nor controlled by the direct influence of the will. In the case of the movements of respiration, we found sufficient provision made for their constant maintenance; and yet, for secondary purposes, they were placed in a considerable degree under the control of the brain. But here there are no secondary purposes to be answered; the introduction into the stomach of food, brought by the will within reach of the pharyngeal muscles, is the only object contemplated by them; and they are accordingly placed under the sole government of the Spinal Cord.

383. No attempts, on our own part, will succeed in producing a really voluntary act of Deglutition. In order to excite it, we must supply some stimulus to the fauces. A very small particle of solid matter, or a little fluid (saliva, for instance), or the contact of the back of the tongue itself, will be sufficient; but without either of these *we cannot swallow at will*. Nor can we restrain the tendency, when it is thus excited by a stimulus; every one knows how irresistible it is, when the fauces are touched in any unusual manner; and it is equally beyond the direct control of the will, in the ordinary process of eating,—voluntary as we commonly regard this. The only mode in which the will can influence it, is by regulating the approach of the stimulus necessary to excite it; thus, we voluntarily bring a morsel of food, or a little fluid, into contact with the surface of the fauces, and an act of deglutition is then involuntarily excited: or we may voluntarily keep all stimulus at a distance; and no effort of the will can then induce the action. Moreover, this action is performed, like that of respiration, when the power of the will is suspended, as in profound sleep, or in apoplexy affecting only the brain; and it does not seem to be at all affected by the entire removal of the brain, in an animal that can sustain the shock of the operation; being readily excitable, on stimulating the fauces, so long as the nervous structure retains its functions. This has been experimentally proved by Dr. M. Hall; and it harmonizes with the natural experiment sometimes brought under our notice in the case of an anencephalous infant, in which the power of swallowing seems as vigorous as in the perfect one. But, if the nervous circle be destroyed, either by division of the trunks, or by injury of any kind to the portion of the nervous centres connected with them, the action can no longer be performed; and thus we see that, when the effects of apoplexy are extending themselves from the brain to the spinal cord, whilst the respiration becomes stertorous, the power of Deglutition is lost, and then respiration also speedily ceases.

384. Our knowledge of the nerves specially concerned in this action is principally due to the very careful and well-conducted experiments of Dr. J. Reid.* The distribution of the Glosso-Pharyngeal evidently points it out as

* Edinb. Med. and Surg. Journ., vol. xlix.

in some way connected with it; and this, when carefully examined, discloses the important fact, that the nerve scarcely sends any of its branches to the muscles which they enter; but that these mostly pass through them, to be distributed to the superjacent mucous surface of the tongue and fauces. Further, when the trunk is separated from the nervous centres, irritation scarcely ever produces muscular movements. Hence it is not in any great degree an efferent or motor nerve; and its distribution would lead us to suppose its function to be, the conveyance of impressions from the surface of the Fauces to the Medulla Oblongata. This inference is fully confirmed by the fact, that, so long as its trunk is in connection with the Medulla Oblongata, and the other parts are uninjured, pinching, or other severe irritation of the Glosso-Pharyngeal, will often excite distinct acts of deglutition. Such irritation, however, may excite only convulsive twitches, instead of the regular movements of swallowing; and it is evident that, here, as elsewhere, the impressions made upon the extremities of the nerves are much more powerful excitors of reflex movement, than those made upon the trunk, though the latter are more productive of pain. It was further observed by Dr. Reid, that this effect was produced by pinching the pharyngeal branches only; no irritation of the lingual division being effectual to the purpose.

385. If, then, the muscles of deglutition are not immediately stimulated to contraction by the Glosso-Pharyngeal nerve, it remains to be inquired, by what nerve the motor influence is conveyed to them from the Medulla Oblongata; and Dr. Reid has been equally successful in proving, that this function is chiefly performed by the pharyngeal branches of the Par Vagus. Anatomical examination of their distribution shows, that they lose themselves in the muscles of the pharynx; and whilst no decided indications of suffering can be produced by irritating them, evident contractions are occasioned, when the trunk, separated from the brain, is pinched or otherwise stimulated. It appears, however, that neither is the Glosso-Pharyngeal the sole excitor nerve, nor are the pharyngeal branches of the Par Vagus the sole motor nerves, concerned in deglutition; for after the former has been perfectly divided on each side, the usual movements can still be excited, though with less energy; and, after the latter have been cut, the animal retains the means of forcing small morsels through the pharynx, by the action of the muscles of the tongue and neck. From a careful examination of the actions of deglutition, and of the influence of various nerves upon them, Dr. Reid draws the following conclusions:—The *excitor impressions* are conveyed to the Medulla Oblongata chiefly through the Glosso-Pharyngeal, but also along the branches of the Fifth pair distributed upon the fauces, and probably along the branches of the Superior Laryngeal distributed upon the pharynx. The *motor influence* passes chiefly along the pharyngeal branches of the Vagus; along the branches of the Hypo-glossal, distributed to the muscles of the tongue, and to the sterno-hyoid, sterno-thyroid, and thyro-hyoid muscles; along the motor filaments of the Recurrents, ramifying upon the larynx; along some of the branches of the Fifth, supplying the elevator muscles of the lower jaw; along the branches of the Portio Dura, ramifying upon the digastric and stylo-hyoid muscles, and upon the muscles of the lower part of the face; and probably along some of the branches of the Cervical plexus, which unite themselves to the descendens noni.

386. When the food has been propelled downwards by the Pharyngeal muscles as far as their action extends, its further progress through the Œsophagus is effected by the peristaltic movement of the muscular coat of the tube itself. This movement is not, however, due *only* to the *direct* stimulus of the muscular fibre by the pressure of the food, as it seems to be in the lower part of the alimentary canal; for Dr. J. Reid has found, by repeated

experiment, that the continuity of the œsophageal branches of the Par Vagus with the Spinal Cord, is necessary for the rapid propulsion of the food; so that it can scarcely be doubted, that an impression made upon the mucous surface of the œsophagus, conveyed by the afferent fibres of these nerves to the Medulla Oblongata, and reflected downwards along the motor fibres, is the real cause of the muscular contraction. If the Par Vagus be divided in the rabbit, on each side, above the œsophageal plexus, but below the pharyngeal branches, and the animal be then fed, it is found that the food is delayed in the œsophagus, which becomes greatly distended. Further, if the lower extremity of the par vagum be irritated, distinct contractions are seen in the œsophageal tube, proceeding from above downwards, and extending over the cardiac extremity of the stomach. We have here, then, a distinct case of *reflex action without sensation*, occurring as one of the *regular associated movements* in the natural condition of the animal body; and it is very interesting to find this following upon a reflex action *with* sensation (that of the pharynx), and preceding a movement which is altogether unconnected with the Spinal Cord (that of the lower part of the alimentary canal). The use of sensation in the former case will presently appear. The muscular fibres of the œsophagus are *also* excitable, though usually in a less degree, by *direct* stimulation; for it appears that, in some animals (the Dog, for example), section of the pneumogastric does not produce that check to the propulsion of the food, which it occasions in the Rabbit; and even in the Rabbit, as Dr. M. Hall* has remarked, the simple contractility of the muscular fibre occasions a distinct peristaltic movement along the tube, after its nerves have been divided; causing it to discharge its contents, when cut across. Such a movement, indeed, seems to take place in something of a rhythmical manner (that is, at short and tolerably regular intervals), whilst a meal is being swallowed; but as the stomach becomes full, the intervals are longer, and the wave-like contractions less frequent.—These movements are reversed in Vomiting; and this reversion has been observed, even after the separation of the stomach from the œsophagus, as a consequence of the injection of tartar emetic into the veins.

a. It will be desirable here to revert for a short time to the actions, which, in the higher animals, precede those of Deglutition. There can be no doubt that, in the Human being, the motions adapted to the Ingestion and Mastication of aliment originally result, in part at least, from distinct operations of the Will; but it would appear almost equally certain that, in time, they come to be of so habitual a character, that the will only exerts a general controlling influence over them, each individual act being directly excited by sensation. Every one is conscious that the act of mastication may be performed as well, when the mind is attentively dwelling on some other object, as when directed to it; but, in the former case, one is rather apt to go on chewing and rechewing what is already fit to be swallowed, simply because the will does not exert itself to check the action, and to carry the food backwards within the reach of the muscles of deglutition. We now see why sensation should be *associated with* the latter process, though not *essential* to it. The conveyance of food backwards to the fauces is a distinctly voluntary act; and it is necessary that it should be guided by the sensation, which there results from the contact it induces. If the surface of the pharynx were as destitute of sensation, as is the lower part of the œsophagus, we should not know when we had done what was necessary to excite its muscles to operation.—The muscles concerned in the Mastication of food are nearly all supplied by the third branch of the Fifth pair, a large proportion of which is well known to have a motor character. Many of these muscles, especially those of the cheeks, are also supplied by the Portio Dura of the Seventh; and yet, if the former be paralyzed, this cannot stimulate them to the necessary combined actions. Hence we see that the movements are of an associated character, their due performance being dependent on the part of the nervous centres, from which the motor influence originates. If the Fifth pair, on the other hand, be uninjured, whilst the Portio Dura is paralyzed, the movements of Mastication are performed without difficulty; whilst those connected in any way with the Respiratory function, or with Expression, are paralyzed.

* Third Memoir on the Nervous System, § 201.

b. Comparative Anatomy supplies us with the key to the explanation of these phenomena. It has been seen that, in the lower animals, the Respiratory organs are completely unconnected with the mouth, and that a very distinct set of muscles is provided to keep them in action. These muscles have distinct ganglia as the centres of their operations; and these ganglia are only connected indirectly with those of the sensori-motor system. The same would appear to be the case, in regard to the introduction of the food into the digestive apparatus. It has been shown that the muscles concerned in this operation have their own centres,—the Stomato-gastric and Pharyngeal ganglia, which are not very closely connected with the cephalic, or with the respiratory, or with those of general locomotion. Now in the Vertebrata, the distinct organs have been so far blended together, that the same muscles serve the purposes of both; but the different sets of movements of these muscles are excited by different nerves; and the effect of division of either nerve, is to throw the muscle out of connection with the function, to which that nerve previously rendered it subservient,—as much as if the muscle were separated from the nervous system altogether. There is an apparent exception to this view of the matter, in the case of the Portio Dura; this being the source of those movements of the upper lip, which, in many animals, are essential to the prehension of food. These movements, however, are dependent upon *sensations* conveyed through the Fifth pair,* being completely checked by division of its infra-orbital trunk; and it can scarcely be doubted, from their general character, that they are of a strictly *voluntary* nature, and are not to be regarded as part of the reflex associated movements in which that nerve is concerned.

c. Now although, in the adult Human being, the movements required to convey the food to the pharynx are under the control of the Will, if not constantly dependent upon it, there is good reason to believe that this is not the case in regard to those remarkable associated movements, which constitute the act of suction in the Infant. The experiments provided for us by nature, in the production of anencephalous monstrosities, fully prove that the nervous connection of the lips and respiratory organs with the Spinal Cord, is alone sufficient for its execution; and Mr. Grainger has sufficiently established the same, by experiment upon puppies whose brain had been removed. He adds that, as one of the puppies lay on its side, sucking the finger which was presented to it, it pushed out its feet in the same manner as young pigs exert theirs against the sow's dugs. On the whole, however, the act of suction belongs more to the Respiratory ganglion (so to speak) than to the Stomato-gastric system of nerves; and hence we can understand why, even in the highest animals, it should be purely reflex; the movements of Respiration being so from the first, whilst those ordinarily concerned at a later period in the Ingestion of the food are more directed by sensation and volition. The actions of the mammary fetus of the kangaroo, described by Mr. Morgan, furnish a very interesting exemplification of the same function of the Spinal Cord; this creature, resembling an earth-worm in appearance, and only about fourteen lines in length, with a brain corresponding in degree of development to that of a human fetus of the ninth week, executes regular, but slow, movements of respiration, adheres firmly to the point of the nipple, and moves its limbs when disturbed. The milk is forced into the œsophagus by a compressor muscle, with which the mamma of the parent is provided. "Can it be imagined," very justly asks Mr. Grainger, "that in this case there are sensation and volition, in what can be proved anatomically to be a fetus?"

387. The Sphincter muscle, which guards the Cardiac orifice of the stomach, appears to be under the influence of the Spinal system of nerves. It is usually closed; but it opens when there is a sufficient pressure on it, made by the accumulated food propelled by the movements of the œsophagus above; and it then closes again, so as to retain the food in the stomach. That this closure is due to reflex action appears from the fact that, when the nerves supplying the muscle are divided, the sphincter no longer contracts, and the food regurgitates into the œsophagus. The opening of the cardiac orifice is one of the first of the changes, which occur in the act of vomiting.—With regard to the degree, in which the movements of the Stomach, that have so important a share in the Digestive operation, are dependent upon the Spinal system, and are consequently of a reflex nature, it is difficult to speak with

* Hence originated one of Sir C. Bell's early errors. He found that an ass, in which the infra-orbital branch of the fifth was divided, would not pick up oats with its lip, although they were in contact with it; hence he concluded that its power of motion was destroyed,—when it was in reality only the sensation necessary to excite the will to cause the motion, that was deficient.

certainly, owing to the contradictory results obtained by different experimenters. These contradictions, however, seem partly due to a diversity in the nature of the animals experimented on. It seems to be well established, by the researches of Reid, Valentin, and others, that distinct movements may be excited in the Stomach of the Rabbit, if distended with food, by irritating the Par Vagus soon after the death of the animal; these movements seem to commence from the cardiac orifice, and then to spread themselves in a sort of peristaltic manner along the walls of the stomach; but no such movements can be excited if the stomach be empty. Various experiments upon living animals have led to a similar conclusion; food taken in shortly before or subsequently to its division, having been found to be only dissolved on the surface of the mass, where it was in contact with the mucous membrane. But these experiments have been made for the most part upon Herbivorous animals, such as horses, asses, and rabbits; whose food is bulky and difficult of solution, requiring to be constantly changed in its position, so that every part of it may be successively brought to the exterior. On the other hand, Dr. Reid found, in his experiments upon Dogs, that, after the first shock of the operation had gone off, solution of the food in the stomach, and absorption of chyle, might take place; and hence it may be inferred, that no influence of this nerve upon the muscular parietes of the stomach is essential to digestion in that species. This conclusion harmonizes well, therefore, with the fact already stated respecting the absence of such influence in the lower parts of its œsophagus; and it may, perhaps, be explained by the consideration, that the natural food of the dog is much less bulky and more easy of solution, than that of the animals already named; so that there is not so much need of the peculiar movement, which is in them so important an aid to the process of reduction.—The muscular walls of the stomach appear to be called into reflex contraction in the act of Vomiting; the mechanism of which will be considered hereafter (§ 505).

388. That the ordinary peristaltic movements of the Intestinal canal, from the stomach to the rectum, may take place without any connection with the nervous system, being due to the direct stimulation of the contact of food, there is now ample evidence; and though some may yet be found to deny the Hallerian doctrine, that muscular fibre possesses in itself the property of contractility, so much additional evidence of its truth has been recently adduced whilst the doctrine itself is so conformable to the analogy supplied by other vital phenomena, that it will be here unhesitatingly adopted. (See Chapter V.) Some Physiologists still suppose, that the peristaltic movements of the alimentary canal are due to a sort of reflex action, taking place through the ganglia of the Sympathetic system of nerves, especially, of course, the semi-lunar. This supposition, however, has little or no evidence to support it; for it has been fully proved that the muscular contractions will continue, long after the tube has been separated from its nervous connections through its whole extent; and the only evidence in its favour is derived from the contractions, which may sometimes be induced in parts of the tube which are at rest, when the Sympathetic nerves supplying them are irritated. The experiments of Valentin, however,—by which the fact that such contractions may be induced (which has been denied by some) is clearly substantiated,—also show that the motor influence does not originate in the Sympathetic ganglia, but in the Spinal Cord. The following are the general results of upwards of three hundred experiments, so far as they apply to this subject.—The pharynx may not only be excited to contraction by irritation of the pharyngeal branches of the Par Vagus, or of the roots of the Spinal Accessory, from which their motor power is derived (as will be hereafter explained), but also by stimulating the roots of the first two Cervical nerves; and the lower

part of the œsophagus in the neck is made to contract peristaltically from above downwards, by irritation of the roots of the first three Cervical nerves, and of the cervical portion of the Sympathetic, through which last the former evidently operate. The thoracic portion of the œsophagus is made to contract, by irritation of the lowest Sympathetic ganglion of the neck, and of the higher thoracic ganglia, and also of the roots of the lower Cervical spinal nerves. Muscular contractions of the stomach are produced, by irritation of the roots of the 4th, 5th, 6th, and 7th Cervical nerves, and of the first thoracic in the rabbit; so that a distinct furrow is evident between the cardiac and pyloric portion of the viscus; and the lower the nerve irritated, the nearer the pylorus do the contractions extend. Irritation of the first thoracic ganglion of the Sympathetic produces the same effect. Contractions of the intestinal tube, varying in place according to the part of the Spinal Cord experimented on, may be excited by irritation of the roots of the dorsal, lumbar, and sacral nerves, and of the trigeminus; and similar effects are produced by irritation of the lower part of the thoracic portion, of the lumbar, and of the sacral portions of the Sympathetic,—also of the splanchnic, and of the gastric plexus.

389. From these facts it is evident, that the movements of the Intestinal tube may be influenced by the Spinal Cord; and that what is commonly termed the Sympathetic nerve, is the channel of that influence, by the fibres which it derives from the Spinal system. But it by no means thence follows, that the ordinary peristaltic actions of the muscles in question are *dependent* on a stimulus reflected through the spinal cord, rather than on one directly applied to themselves. It is clear that, although these movements are of the first importance to the welfare of the system, such means of sustaining them are feeble, compared to those which we find provided for the maintenance of the distinctly-reflex actions of deglutition, respiration, &c. The difficulty with which any evidence can be obtained of the connection, is a sufficient proof of this. On the other hand, we do know that these peristaltic movements are *influenced* by particular states of mind, or by conditions of the bodily system; and the connection just traced satisfactorily accounts for this, and is itself sufficiently explained. The intestinal tube, then, from the stomach to the rectum is not dependent upon the Spinal cord for its contractility, but is enabled to propel its contents by its own inherent powers; still we find that here, as in other instances, the nervous centres exert a general control over even the Organic functions,—doubtless for the purpose of harmonizing them with each other, and with the conditions of the organs of Animal life.

390. The Muscular Coat of the Bladder appears, like that of the Intestinal tube, to be ordinarily excited to contraction, rather by direct stimulation than by the agency of the Spinal nerves. It is not, however, altogether removed from the influence of the Spinal Cord; for the experiments of Valentin have shown that a connection exists, as in the former case, through the Sympathetic nerve, affecting not only the bladder but also the ureters. That physiologist states, that a very distinct and powerful peristaltic action of the ureter, proceeding from the kidneys to the bladder, may be produced, by irritating the abdominal ganglia of the Sympathetic, or the roots of the superior abdominal Spinal nerves; and that strong contractions of the bladder are excited, by irritation of the inferior portion of the abdominal Sympathetic, but especially of its sacral portion, and of the roots of the middle and inferior nerves of the Spine. In these, as in former cases, no effect is produced by irritation of the Spinal Nerves, unless the portion of the Sympathetic connected with the particular organ be entire.

391. On examining the outlets by which the excretions are voided, we find that they are placed, like the entrances, under the guardianship of the Spinal Cord; subject, however, to some control on the part of the Will. In the

lowest animals, the act of discharging excrementitious matter is probably as involuntary, as are the acts immediately concerned in the introduction of nutriment; and it is performed as often as there is anything to be got rid of. In the higher classes, however, such discharges are much less frequent; and reservoirs are provided, in which the excrementitious matter may accumulate in the intervals. The associated movements required to empty these, are completely involuntary in their character; and are excited by the quantity, or stimulating quality, of the contents of the reservoir. But, had volition no control over them, great inconveniences would ensue; hence sensation is excited by the same stimulus, which produces the movements; in order that, by arousing the will, the otherwise involuntary motions may be restrained and directed.—There can be little doubt, from the experiments of Dr. M. Hall, as well as from other considerations, that the associated movements, by which the contents of the rectum and bladder are discharged, correspond much with those of Respiration; being in their own nature excito-motor, but capable of a certain degree of voluntary restraint and assistance. The acts of Defecation and Urination chiefly depend upon the combined contraction of the abdominal muscles, similar to that which is concerned in the expiratory movement; but, the glottis being closed, and the diaphragm fixed, the expulsor power is restricted to the contents of the abdominal cavity; and so long as the sphincter of the cardia remains closed, the force must act downwards, upon the walls of the rectum and bladder,—the contents of the one or the other of these cavities, or of both, being expelled, according to the condition of their respective sphincters. These actions are doubtless assisted by the contraction of the walls of the rectum and bladder themselves; for we sometimes find their agency sufficient to expel the contents of the cavities, when there is a total paralysis of the ordinary expulsors,—provided that the sphincters be at the same time sufficiently relaxed. This is more especially the case, when their power is augmented by increased nutrition. For example, in many cases of disease or injury of the Spinal Cord, the bladder ceases to expel its contents, through the interruption of the circle of reflex actions; but after a time, the necessity for drawing off the urine by the catheter is found to exist no longer; the fluid is constantly expelled as soon as it has accumulated in small quantities. In such cases, the mucous coat is found after death to be thickened and inflamed; and the muscular coat to be greatly increased in strength, and contracted upon itself. It would seem, then, that the abnormal irritability of the mucous membrane, and the increased nutrition of the muscular substance which appears consequent upon it, enable the latter to expel the urine without the assistance of the ordinary expulsors.

392. On the other hand, the sphincters which antagonize the expellent action, are usually maintained in a state of moderate contraction, so as to afford a constant check to the egress of the contents of the cavities; and this condition has been fully proved by Dr. M. Hall, to result from their connection with the Spinal Cord, ceasing completely when this is interrupted. But the sphincters are certainly in part controlled by the will, and are made to act in obedience to the warning given by sensation; and this voluntary power is frequently destroyed by injuries of the Brain, whilst the Spinal Cord remains able to perform all its own functions, so that discharge of the urine and faeces occurs.—In their moderate action, the expulsors and the sphincters may be regarded as balancing one another, so far as their reflex action is concerned,—the latter having rather the predominance, so as to restrain the operation of the former. But, when the quantity or quality of the contents of the cavity gives an excessive stimulus to the former, their action predominates, unless the will is put in force to strengthen the resistance of the sphincter; this we are frequently experiencing, sometimes to our great

discomfort. On the other hand, if the stimulus is deficient, the will must aid the expulsors, in order to overcome that resistance which is due to the reflex contraction of the sphincters; of this also we may convince ourselves, when a sense of propriety, or a prospective regard to convenience, occasions us to evacuate the contents of the rectum or bladder without a natural call to do so.

393. *Movements of the Genital Organs.*—The muscular contractions involved in the *Emissio Seminis* are clearly of a *reflex* nature; being independent of the will and not capable of restraint by it, when once fully excited; and being producible in no other way, than (like those concerned in Deglutition) by a particular local irritation. That this irritation need *not* amount to a *sensation*, is proved by cases already referred to (§ 372); and it has been also shown by experiment, that section of the Spinal Cord in the lumbar region does not prevent the act from being performed, the lower division only being concerned in the reflexion of the impression. It further appears, from the experiments of Valentin, that the Spinal Cord may operate on the Genital organs through the Sympathetic system. Contractions were excited in the *vas deferens vesiculæ seminales*, especially of the Guinea Pig at the time of heat, by irritation of the inferior lumbar and highest sacral portions of the Sympathetic; and the Fallopian tubes, as well as the Uterus itself, may be excited to contraction, by irritation of the same nerves as those which excite the rectum,—namely, the lower lumbar and first sacral nerves of the Spine. This last fact is important, in regard to the rationale of the operation of certain medicines, such as aloes, which are known to have an influence on both parts.—In regard to the act of Parturition, there would seem reason to believe, from the evidence of cases of paraplegia, that, of the muscles whose operation is associated in it, the diaphragm, abdominal muscles, &c., are called into action (as in defecation) through the Spinal Cord; but that the contractions of the Uterus itself are but little dependent on its connection with the nervous centres. Of the reason why the muscles, which were up to that time inert, should then combine in this extraordinary manner, and with such remarkable energy, Physiology can afford no certain information. There can be little doubt, however, that the stimulus usually originates in the uterus, or in some of the neighbouring organs which are incommoded by the pressure; but it may also result from some condition of the general system, in which the uterus itself is but little concerned. It is an interesting fact, which has been more than once observed, that the fœtus may be expelled from the dying body of the mother, even after the respiratory movements have ceased. This would appear due to the contraction of the Uterine fibres alone, which, like those of the heart and alimentary canal, retain their irritability longer than those of the muscles supplied by the cerebro-spinal nerves; and the power of these would be unopposed by the resistance which they ordinarily have to encounter; since the tension of all the muscles surrounding the outlet would be destroyed, by the cessation of the activity of the Spinal system of nerves (§ 398).

394. *Protecting Agency of the Spinal Cord.*—From the foregoing details it appears, that one of the chief functions of the Spinal Cord is to control the orifices of the various open cavities of the body; and this function evidently has safety, as well as convenience, in view. It has been manifestly designed by the All-wise Creator, that the Glottis should close against agents injurious to the organs within; and that the effort to vomit should be excited by the attempt to swallow substances so nauseous as to induce loathing.—There is another protective influence exerted by it, of a still more remarkable nature. It has been ascertained by Dr. M. Hall that, if the functions of the Brain be suspended or destroyed, without injury to the Spinal system of nerves, the

Orbicularis muscle will contract, so as to occasion the closure of the eyelids, upon the tarsal margin being touched with a feather. This fact is interesting in several points of view. In the first place, it is a characteristic example of pure reflex action; occurring under circumstances in which volition cannot be imagined to guide it, and in which there is no valid reason to believe that sensation directs it. Further, it explains the almost irresistible nature of the tendency to winking, which is performed at short intervals by the contraction of the Orbicularis muscle; this is evidently a Spinal action, capable of being in some degree restrained (like that of respiration) by the will, but only until such time as the stimulus (resulting perhaps from the collection of minute particles of dust upon the eyes, or from the dryness of its surface in consequence of evaporation), becomes too strong to be any longer resisted. Again, we have in sleep or in apoplexy an example of this purely spinal action, unbalanced by the influence of the will, which, in the waking state, antagonizes it by calling the levator palpebræ into action. As soon as the will ceases to act, the lids droop, and close over the eye in order to protect it; and if those of a sleeping person be separated by the hand, they will be found presently to return. Here, as in studying the respiratory and other movements, we are led to perceive, that it is the Brain alone, which is torpid during sleep, and whose functions are affected by this torpidity. As Dr. M. Hall very justly remarks, the Spinal system never sleeps; it is constantly in activity; and it is thus that, in all periods and phases of Life, the movements which are essential to its continued maintenance are kept up without sensible effort.

395. The closure of the Pupil against a strong light, is another movement of the same protective tendency. The channel, through which that just named is performed, is completed by the first branch of the Fifth and the Portio Dura of the seventh. The contraction of the pupil is immediately caused by the Third pair, or Motor Oculi; as is easily shown by irritating the trunk of that nerve and observing the result. But it is not easy to speak with certainty as to the afferent nerve, by which the motor influence is excited. Although the contraction of the pupil is usually in close accordance with the sensation occasioned by the impression of light upon the retina, yet there is no want of evidence to prove that the sensation of light is not always necessary; for, even when the sight of both eyes has been entirely destroyed by amaurosis, the regular actions have been witnessed in the pupil, in accordance with varying degrees of light impinging on the retina. This fact may be explained in two ways. It may either be imagined that the requisite stimulus is not that of *light* conveyed through the Optic nerve; but that of *heat* conveyed through the ophthalmic branch of the Fifth pair. Or it may be still supposed, that the motion results from an impression upon the retina, which impression, being conducted to the Sensorium, ordinarily produces a sensation; whilst in these curious cases, no sensation is produced, on account of a disordered state of the part of the ganglionic centre in which the Optic nerve terminates; though some filaments of that nerve, being connected with the Third pair by means of a distinct tract of vesicular matter, can produce a reflex action through it, although no sensation intervene. In either view, the rarity of the occurrence is at once accounted for; since in most cases of amaurosis, the disease lies in the trunk of the nerve, and thereby checks both its spinal and its encephalic actions.

396. The Physiologist has not at present any knowledge of any similar protective movements, in the Human being, designed to keep the organ of Hearing from injury; but there can be little doubt that those which we are constantly witnessing in other animals, possessing large external ears, are reflex actions excited by the irritation applied to them. In regard to the Nose, we find a remarkably complex action—that of Sneezing—adapted to drive off any cause

of irritation (§ 381). It will hereafter be shown that the stimulus is conveyed, in this case, not through the Olfactory nerve, but through the Fifth pair; so that it is not dependent upon the excitement of the sensation of Smell. The act of Coughing, also, may be regarded as of a protective character; being destined to remove sources of irritation from the air-passages. The automatic movements, performed by the limbs of Frogs and other animals, when their connection with the brain has been cut off (§§ 306, 370) appear destined to remove these parts from sources of irritation or injury; and they may thus be rightly placed under the same category.

397. *Movements of Locomotion.*—Lastly, we have to inquire how far the Reflex function of the Spinal Cord is concerned in the locomotive actions of the lower extremities in Man. It will be remembered that, in the *Dytiscus* whose head had been removed (§ 328), the stimulus of the contact of water immediately excited regular and continued locomotive actions which lasted for some time. So in the cases already quoted (§§ 366—368), when the control of the will over the lower extremities was lost, powerful muscular actions were excited in them, through the Spinal Cord alone. In the healthy condition of the Human system, when the Will is controlling all the movements, which are not immediately concerned in the maintenance and regulation of the organic functions, no such actions can be excited: but in proportion as its control is lost, does the independent power of the Spinal Cord manifest itself. The more such actions are of a simple rhythmical character, similar to those of Respiration, the more does it seem that they may with probability be referred to the Spinal system; and if we attribute to this (as we can scarcely help doing) the rapid vibration of the wings of Insects, there seems no reason why we should not extend the same view to the wings of Birds. Such an explanation of their movements will account for their occasional continuance, without apparent fatigue, during a period through which no known voluntary effort can endure; for it is one of the attributes of the Spinal system of nerves, well pointed out by Dr. M. Hall, that the exercise of the muscles excited by it does not occasion fatigue, the sense of which is Cerebral only. It would seem to the Author more probable, however, that those movements which *guide* the body, and which must themselves be directed by Sensation, are to be referred to a class intermediate between the Voluntary and the Reflex, which may be properly termed Consensual. Numerous actions, in Man, which were at first Voluntary, appear at last to be performed as instinctively or intuitively, as they are in the lower animals from the commencement of their existence. (See the next Section.)

398. *Influence on Muscular Tension.*—The various muscles of the body, even when there is the most complete absence of effort, maintain, in the healthy state of the system, a certain degree of firmness, by their antagonism with each other; and if any set of muscles be completely paralyzed, the opposing muscles will draw the part on which they act, out of its position of repose; as is well seen in the distortion of the face, which is characteristic of paralysis of the facial nerve on one side. This condition has been designated as the *tone* of the Muscles; but this term renders it liable to be confounded with their *tonic contraction*, which is also concerned in maintaining their firmness, but which operates in a very different manner. The latter is dependent upon the simple contractility of the muscle; and is exhibited alike by the striated and the non-striated forms of muscular fibre, but more especially by the latter (§ 593). On the other hand, the condition now alluded to, which may perhaps be appropriately termed their *tension*, is the result of a moderate though continued excitement of that contractility, through the nervous centres. It has been proved by Dr. M. Hall, that the Muscular Tension is not dependent upon the influence of the Brain; but upon that of the Spinal

Cord; as the following experiments demonstrate.—“Two Rabbits were taken; from one the head was removed; from the other also the head was removed, and the spinal marrow was cautiously destroyed with a sharp instrument; the limbs of the former retained a certain degree of firmness and elasticity; those of the second were perfectly lax.” Again:—“The limbs and tail of a decapitated Turtle possessed a certain degree of firmness or tone, recoiled on being drawn from their position, and moved with energy on the application of a stimulus. On withdrawing the spinal marrow gently out of its canal, all these phenomena ceased. The limbs were no longer obedient to stimuli, and became perfectly flaccid, having lost all their resilience. The sphincter lost its circular form and contracted state, becoming lax, flaccid, and shapeless. The tail was flaccid, and unmoved on the application of stimuli.” It is further remarked by Messrs. Todd and Bowman, that ‘a decapitated frog will continue in the sitting posture through the influence of the spinal cord; but immediately this organ is removed, the limbs fall apart.’”

399. This operation of the Spinal Cord is doubtless but a peculiar manifestation of its ordinary reflex function. We shall hereafter see (Section 5) how much the influence of the will in producing the active contraction of a muscle, is connected with sensations received from it; and it seems highly probable, that the impression of the state of the muscle, conveyed by the afferent fibres proceeding from it to the spinal cord, is sufficient to excite this state of moderate tension through the motor nerves, arising from the latter. Such a view derives probability from the fact, which must have fallen under the observation of almost every one, that most reflex actions become increased in energy if resistance is made to them. Of this we have familiar examples in the action of the expulsor muscles, which operate in defecation, urination, and parturition, if, when they are strongly excited, their efforts be opposed by the will acting on the sphincters, or by mechanical means. Many forms of convulsive movement exhibit the same tendency; their violence being proportional to the mechanical force used to restrain them.* Here it is evident that the *impression of resistance*, conveyed to the Spinal Cord, is the source of the increased energy of its motor influence;—from which we may fairly infer that the moderate resistance, occasioned by the natural antagonism of the muscles, is the source of their continued and moderate tension, whilst they are under the influence of the Spinal Cord. This constant though gentle action serves to keep up the nutrition of the muscles, which are paralyzed to the will; and this is still more completely maintained, if the portion of the nervous centres, with which they remain connected, is so unduly irritable, that the muscles are called into contraction upon the slightest excitation, and are thus continually exhibiting twitchings, startings, or more powerful convulsive movements. It is upon the state of nutrition of the muscles, that their contractility depends, as will be shown hereafter (§ 588); and hence the Spinal Cord has an indirect influence upon this peculiar property, which is more likely to be retained, when the muscle is still subject to the influence of the Spinal Cord, though cut off from that of the Brain, than when it is completely paralyzed by the entire cessation of the influence of the nervous centres.

400. *Pathological Phenomena.*—It would not be right to conclude this account of the principal functions of the Spinal Cord, without adverting to some of the leading Pathological applications of the physiological doctrines

* Hence the absurdity of the common practice of endeavouring to *prevent* the movements of the limbs and body, in convulsive paroxysms, by mechanical constraint. Nothing should be attempted but what is requisite to prevent the sufferer from doing himself an injury.

which have been developed in it; although they will hereafter be passed under a more general review (Section 8). A large part of these were first pointed out by Dr. M. Hall;* and they are receiving continual and important extensions from his own labours and those of other practical inquirers. It may be remarked, in the first place, that the power of the whole Spinal system is capable of being morbidly diminished or augmented. It may even be for a time almost completely suspended, as in Syncope; which state may be induced by sudden and violent impressions, either of a mental or physical nature, that operate upon the whole nervous system at once,—commencing, however, in the brain. It is to be remarked that, in recovering from these, it is the Spinal system of which the activity is first renewed,—the respiratory movements recommencing, and the power of swallowing being restored, before any voluntary actions can be performed. A corresponding state may be induced in particular portions of the system by concussion; as is seen in severe injuries of the Spinal Cord, which are almost invariably followed for a time by the suspension of its functions. Again, the power of the whole Spinal Cord may be diminished by various causes, such as enfeebled circulation, pressure, &c.; and then we have torpidity of the whole muscular system. If oppression exists in the Brain, the functions of the Medulla oblongata will be especially affected; and if it be prolonged and sufficiently severe, Asphyxia will result from the interruption of the respiratory movements which it occasions.

401. On the other hand, the excitability of the whole Cord, or of particular parts of it, may be morbidly increased. This is especially seen in ordinary Tetanus and the artificial Tetanus induced by Strychnine; in which the slightest external stimulus is sufficient to induce reflex actions in their most terrific forms. It is interesting to remark, that in this formidable disease the functions of the muscles controlling the various orifices are those most affected; and it is by the spasms affecting the organs of respiration or deglutition, that life is commonly terminated.—Various remedial agents will probably be found to operate, by occasioning increased excitability in some particular segments of the Cord; so that the usual stimuli applied to the parts connected with these, will occasion increased muscular tension. This seems to be the case, for example, in regard to the influence of aloes on the rectum and uterus, cantharides on the neck of the bladder and adjoining parts, and secale cornutum on the uterus. The mode of influence of cantharides is illustrated by a curious case, related by Dr. M. Hall, of a young lady who lost the power of retention of urine, in consequence of a fatty tumour in the spinal canal, which gradually severed the Spinal Cord, and induced paraplegia. The power of retaining the urine was always restored *for a time* by a dose of tincture of cantharides, which augmented the excitability of the segment of the cord, with which the sphincter vesicæ is connected.—The researches of Valentin, when grafted (as it were) on the doctrines of Dr. M. Hall, afford the key to the explanation of the numberless sympathetic influences of the organs of nutrition, &c., upon one another; by showing that they are all connected with the Spinal Cord; and that the muscular structure, with which they are all provided, may be excited to contraction through it. And, lastly, the more recent observations of Dr. M. Hall, in regard to the peculiar excitor power that belongs to the nervous fibres distributed on various serous and fibrous membranes, will probably lead, when they have been fully carried out, to the explanation of the various convulsive actions, that result from pressure or irritation affecting these parts.

* See especially his Treatise on the Diseases and Derangements of the Nervous System.

a. It has been pointed out by Messrs. Todd and Bowman (Physiological Anatomy, Vol. I. p. 315), that the Spinal Cord of the male frog, at the season of copulation, naturally possesses a state of most extraordinary excitability. The thumb of each anterior extremity at this season, becomes considerably enlarged; as is well known to Naturalists. "This enlargement is caused principally by a considerable development of the papillary structure of the skin which covers it; so that large papillæ are formed all over it. A male frog, at this season, has an irresistible propensity to cling to any object, by seizing it between his anterior extremities. It is in this way that he seizes upon, and elings to the female; fixing his thumbs to each side of her abdomen, and remaining there for weeks, until the ova have been completely expelled. An effort of the Will alone could not keep up the grasp uninterruptedly for so long a time, yet so firm is the hold, that it can with difficulty be relaxed. Whatever is brought in the way of the thumbs, will be caught by the forcible contraction of the anterior limbs; and hence we often find frogs elinging blindly to a piece of wood, or a dead fish, or some other substance which they may chance to meet with. If the finger be placed between the anterior extremities, they will grasp it firmly; nor will they relax their grasp until they are separated by force. If the animal be decapitated, whilst the finger is within the grasp of its anterior extremities, they still continue to hold on firmly. The posterior half of the body may be cut away, and yet the anterior extremities will still cling to the finger; but immediately that the segment of the cord, from which the anterior extremities derive their nerves, has been removed, all their motion ceases. This curious instinct only exists during the period of sexual excitement; for at other periods the excitability of the anterior extremities is considerably less than that of the posterior."

402. *Nerves of the Spinal System.*—The nerves which minister to the functions of the Spinal Cord, conveying to it the impressions made on the periphery, and transmitting its motor influence to the muscles,—are not those alone which are ordinarily designated as Spinal nerves; for several of those, which pass forth through the base of the cranium, and which are commonly described as Cephalic nerves, belong to the same category. The general characters of the Spinal nerves, their mode of connection with the Spinal Cord by two sets of roots, and the presence of ganglion upon the posterior root, have already been adverted to (§ 344). The anterior roots are usually the smaller; and this is particularly the case with those of the cervical nerves, in which the posterior roots are of remarkable comparative size. In the First Cervical or Sub-occipital pair, the anterior roots are sometimes wanting; but there is then a derivation of fibres from the Spinal Accessory, or from the Hypoglossal, or from both. The two roots of the ordinary Spinal nerves unite immediately beyond the ganglion, which is situated on the posterior one; and the trunk thus formed separates immediately into two divisions,—the anterior and posterior,—each of which contains both afferent and motor fibres. These divisions, of which the anterior is by far the larger, proceed to the anterior and posterior parts of the body respectively; and are chiefly distributed to the skin and the muscles. The anterior branch is that which communicates with the sympathetic nerve.

403. The pair of nerves commonly designated as the *Fifth* of the Cephalic series, or as the *Trifacial*, is the one which more nearly resembles the ordinary Spinal nerves (as was long since pointed out by Sir C. Bell), than does any other of those originating within the cranium. It possesses two distinct sets of roots, of which one is much larger than the other; on the larger root, as on the posterior and larger root of the Spinal nerves, is a distinct ganglion; and the fibres arising from the smaller root do not blend with the others, until after the latter have passed through this ganglion. The trunk of the nerve separates, as is well known, into three divisions,—the Ophthalmic, the Superior Maxillary, and the Inferior Maxillary; and it can be easily shown, by careful dissection, that the fibres of the smaller root pass into the last of these divisions alone. When the distribution of this nerve is carefully examined, it is found that the first and second divisions of it proceed almost entirely to the skin and mucous surfaces; a very small proportion, only, of their fibres being lost in the muscles: whilst of the branches of the third division, a large number are distinctly muscular. Hence analogy, and the facts supplied by

anatomical research, would lead to the conclusion, that the first two divisions are nerves of sensation only, and that the third division combines sensory and motor endowments. Such an inference is fully borne out by experiment. When the whole trunk is divided within the cranium by the penetration of a sharp instrument (which Magendie, by frequent practice, has been able to accomplish), evident signs of acute pain are given. After the incision has been made through the skin, the animal remains quiet until the nerve is touched; and when it is pressed or divided, doleful cries are uttered, which continue for some time, showing the painful effect of the irritated state of the cut extremity. The common sensibility of all the parts supplied by this nerve is entirely destroyed on the affected side. The jaw does not hang loosely, because it is partly kept up by the muscles of the other side; but it falls in a slight degree; and its movements are seen, when carefully observed, to be somewhat oblique. If the trunk be divided on each side, the whole head is deprived of sensibility; and the animal carries it in a curious vacillating manner, as if it were a foreign body.

Fig. 150.

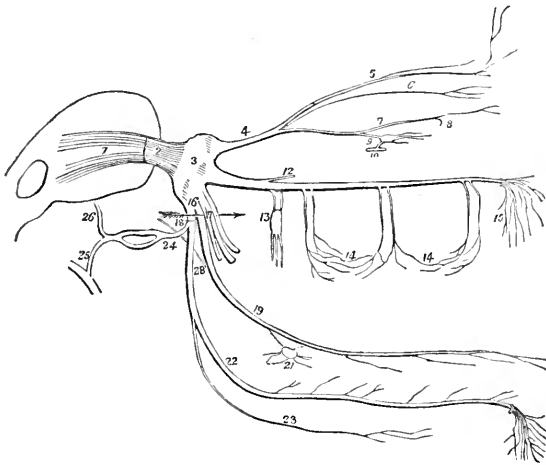

A diagram showing the Fifth pair of nerves with its branches. 1. The origin of the nerve by two roots. 2. The nerve escaping from the crus cerebelli. 3. The Gasserian ganglion. 4. Its ophthalmic division. 5. The frontal nerve, giving off the supra-trochlear branch, and escaping on the forehead through the supra-orbital foramen. 6. The lachrymal nerve. 7. The nasal nerve, passing at 8 through the anterior ethmoidal foramen, and giving off the infra-trochlear branch. 9. The communication of the nasal nerve with the ciliary ganglion. 10. A small portion of the third nerve with which the ganglion is seen communicating; the ganglion gives off the ciliary branches from its anterior aspect. 11. The superior maxillary nerve. 12. Its orbital branch. 13. The two branches communicating with Meckel's ganglion; the three branches given off from the lower part of the ganglion are the posterior palatine nerves. 14, 14. The superior dental nerves, posterior, middle, and anterior. 15. The infra-orbital branches distributed upon the cheek. 16. The inferior maxillary nerve. 17. Its anterior or muscular trunk. 18. The posterior trunk; the two divisions are separated by an arrow. 19. The gustatory nerve. 20. The corda tympani joining it at an acute angle. 21. The submaxillary ganglion. 22. The inferior dental nerve. 23. Its mylo-hyoidean branch. 24. The auricular nerve, dividing behind the articulation of the lower jaw, to reunite and form a single trunk. 25. Its branch of communication with the facial nerve. 26. Its temporal branch.

404. If the anterior or *Ophthalmic* branch only be divided, all the parts supplied by it are found to have lost their sensibility, but their motions are unimpaired; and all experiments and pathological observations concur in at-

tributing to it sensory endowments only. The only apparent exception is in the case of the Naso-Ciliary branch; since there is good reason to believe that the long root of the ciliary ganglion, and the long ciliary nerves, possess motor

[Fig. 151.

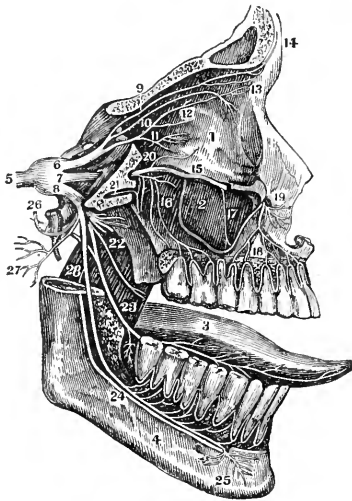

A view of the distribution of the Trifacial or Fifth pair; 1, orbit; 2, antrum highmorianum; 3, tongue; 4, lower jaw-bone; 5, root of the fifth pair, forming the ganglion of Gasser; 6, first branch of the fifth pair, or ophthalmic; 7, second branch of the fifth pair, or superior maxillary; 8, third branch of the fifth pair, or inferior maxillary; 9, frontal branch, dividing into external and internal frontal nerves; 10, lachrymal branch of the fifth pair; 11, nasal branch; just under the figure is the long root of the lenticular or ciliary ganglion and a few of the ciliary nerves; 12, internal nasal nerve, disappearing through the anterior ethmoidal foramen; 13, external nasal nerve; 14, external and internal frontal nerve; 15, infra-orbital nerve; 16, posterior dental branches; 17, middle dental branch; 18, anterior dental nerve; 19, terminating branches of the infra-orbital nerve, called the labial and palpebral nerves; 20, subcutaneous maxæ, or orbital branch; 21, pterygoid, or recurrent nerve, from Meckel's ganglion; 22, five anterior branches of the third branch of the fifth pair; 23, lingual branch of the fifth, joined by the chorda tympani; 24, inferior dental nerve; 25, its mental branches; 26, superficial temporal nerve; 27, auricular branches; 28, mylo-hyoid branch.]

powers; but these appear to be derived from the Sympathetic nerve. When the whole nerve, or its anterior branch, is divided in the rabbit, the pupil is exceedingly contracted, and remains immovable; but in dogs and pigeons it is dilated. The pupil of the other eye is scarcely affected; or, if its dimensions be changed, it soon returns to its natural state. The eyeball speedily becomes inflamed, however; and the inflammation usually runs on to suppuration and complete disorganization. The commencement of these changes may be commonly noticed within twenty-four hours after the operation; and they appear to be due to the want of the protective secretion, which (as will be explained when the direct influence of the nervous system upon the organic functions is considered), is necessary to keep the mucous surface of the eye in its healthy condition, and which is not formed when the sensibility of that surface is destroyed.—The *Superior Maxillary* branch, considered in itself, is equally destitute of motor endowments with the ophthalmic; but its connections with other nerves, through the spheno-palatine ganglion and its anastomosing twigs, may introduce a few motor fibres into it.—The *Inferior Maxillary* branch is the only one which possesses motor as well as sensory endowments from its origin; but its different subdivisions possess these endowments in varying proportions, some being almost exclusively motor, and others as completely of a sensory character. The latter is probably the nature of the Lingual branch; and there seems good reason to believe, as will hereafter be shown, that this ministers not only to the tactile sensibility of the tongue, but to the sense of Taste. The muscles put in action by this division of the Fifth pair, are solely those concerned in the masticatory movements.

405. The *Third, Fourth, and Sixth* pairs, together make up the apparatus of motor nerves, by which the muscles of the Orbit are called into action. The *Third* pair supplies the greater number of the muscles; the *Fourth*

being confined to the superior oblique, and the Sixth to the abductens. Of these nerves, the Third pair is the only one which exhibits any appearance of sensibility, when its trunk is irritated; but this sensibility is not nearly so great as that of the Fifth pair; and it may be doubted whether it is really possessed by the Third, in virtue of its direct connection with the nervous centres, or whether it is not imparted by the anastomosis of that nerve with the Fifth,—some filaments of which may pass backwards as well as forwards, so as to confer sensibility on the trunk of the Third, above as well as beyond their point of entrance.—The peculiar mode in which these motor nerves ordinarily excite the muscles to action, will be considered in the next Section. Although commonly ranked as cephalic nerves, they have no direct connection with the Cerebrum; their real origin being from the upper part of the Medulla Oblongata, and those prolongations of it which are known as the *Crura Cerebri*. The

roots of the Third pair may be traced into direct connection with the *Corpora Quadrigemina*; a fact of considerable physiological importance, as will hereafter appear. The chief actions of a purely *reflex* nature, to which this group of nerves ordinarily ministers, are the government of the diameter of the pupil, which is accomplished through the Third pair; and the rolling of the eyeball beneath the upper lid during sleep, as well as in the efforts of sneezing, coughing, &c. But irregular movements of the eyeballs, which must be referred to the same group, are continually seen to accompany various other forms of convulsive action.

406. The *Portio Dura* of the Seventh pair, or *Facial* nerve, has been supposed, since the first researches of Sir C. Bell, to be a nerve of motion only; but some recent physiologists have maintained, that it both possesses sensory endowments, and arises by a double root. According to Valentin, however, who experimented on the roots exposed within the cranium, it possesses no sensory endowments at its origin; since, when these roots were touched, the animals gave no signs of pain, though violent muscular movements were excited in the face. Subsequently to its first entrance into the canal by which it emerges, however, it anastomoses with other nerves; and thus sensory fibres are introduced into it from many different sources,—anteriorly, from the Fifth pair, and posteriorly, from the Cervical nerves,—which cause irritation of several of its branches to produce pain. The number and situation of the anastomoses vary much in different animals; so that it is impossible to make any very comprehensive statement in regard to them.—Experimental researches leave no doubt that the *Portio Dura* is the *general motor* nerve of the face; ministering to the influence of volition and Emo-

[Fig. 152.]

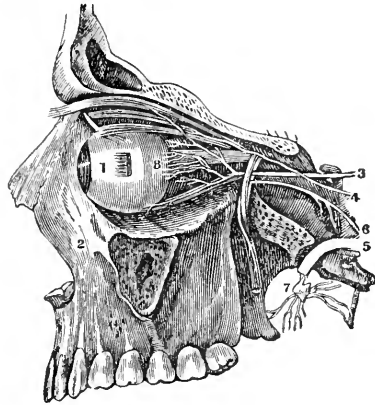

A view of the Third, Fourth and Sixth pairs of Nerves; 1, ball of the eye and rectus externus muscle; 2, the superior maxilla; 3, the third pair, or motores oculi, distributed to all the muscles of the eye except the superior oblique and external rectus; 4, the fourth pair, or pathetici, going to the superior oblique muscle; 5, one of the branches of the seventh pair; 6, the sixth pair, or motor externus, distributed to the external rectus muscle; 7, sphenopalatine ganglion and branches; 8, ciliary nerves from the lenticular ganglion, the short root of which is seen to connect it with the third pair.]

Fig. 153.

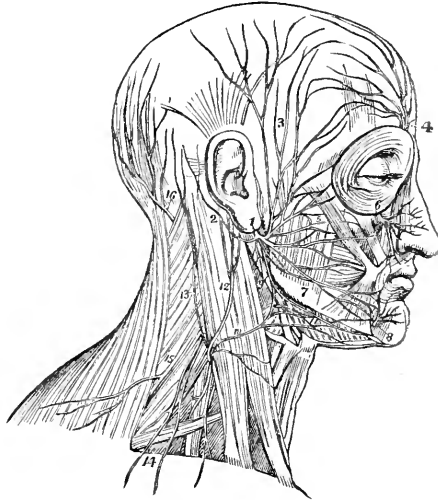

The distribution of the Facial nerve, and the branches of the Cervical plexus. 1. The facial nerve, escaping from the stylo-mastoid foramen, and crossing the ramus of the lower jaw; the parotid gland has been removed in order to see the nerve more distinctly. 2. The posterior auricular branch; the digastric and stylo-mastoid filaments are seen near the origin of this branch. 3. Temporal branches, communicating with (4) the branches of the frontal nerve. 5. Facial branches, communicating with (6) the infra-orbital nerve. 7. Facial branches, communicating with (8) the mental nerve. 9. Cervico-facial branches, communicating with (10) the superficialis colli nerve, and forming a plexus (11) over the sub-maxillary gland. The distribution of the branches of the facial in a radiated direction over the side of the face, constitutes the *pes anserinus*. 12. The auricularius magnus nerve, one of the ascending branches of the cervical plexus. 13. The occipitalis minor, ascending along the posterior border of the sterno-mastoid muscle. 14. The superficial and deep descending branches of the cervical plexus. 15. The spinal accessory nerve, giving off a branch to the external surface of the trapezius muscle. 16. The occipitalis major nerve, the posterior branch of the second cervical nerve.

tion, and also being the channel of the Reflex movements concerned in respiration and other associated movements of the muscles; but not being in the least concerned in the act of mastication.

a. The distinctness of the Spinal and Encephalic actions of this nerve, is made evident by the not unfrequent occurrence of paralysis in either of them, without the other being affected.—Thus we may see the mouth drawn to one side (in consequence of the loss of *tone*, which the muscles have experienced), and all the Reflex and Emotional actions of the face performed only on one side; and yet Voluntary power may remain unaffected; so that, in ordinary *winking*, the lid of the affected side does not close; though the patient can shut the eye by an effort of the will.—On the other hand, the *tension* of the muscles may remain unimpaired, and all their Reflex and Emotional actions may be performed as usual; and yet distortion may be at once apparent, when Voluntary actions are attempted; in consequence of paralysis of the Cerebral portion of the nerve on one side.

407. The functions of the *Glosso-Pharyngeal* nerve have been heretofore alluded to in part; but there still remain several questions to be discussed in regard to them. Reasons have been given for the belief that it is chiefly an afferent nerve,—scarcely having any *direct* power of exciting muscular contraction, but conveying impressions to the Medulla Oblongata, which produce reflex movements of the other nerves (§ 384). This view of its function has been deduced by Dr. Reid from minute anatomical investigation, and from a large number of experiments. Some experimenters assert, that they have succeeded in exciting direct muscular actions through its trunk; but these actions seem to be limited to the stylo-pharyngei and to the palato-glossi mus-

cles. Much controversy has taken place on the question, whether this nerve is to be regarded as ministering, partly or exclusively, to the sense of Taste; and many high authorities have ranged themselves on each side. The question involves that of the function of the Lingual branch of the Fifth pair; and it is partly to be decided by the anatomical relations of the two nerves respectively. The glosso-pharyngeal is principally distributed on the mucous surface of the fauces, and on the back of the tongue. According to Valentin, it sends a branch forwards, on either side, somewhat beneath the lateral margin, which supplies the edges and inferior surface of the tip of the tongue, and inosculates with the Lingual branch of the Fifth pair. On the other hand, the upper surface of the front of the tongue is supplied by this lingual branch. The experiments of Dr. Alcock, whose conclusions are borne out by Dr. J. Reid, decidedly support the conclusion, that the gustative sensibility of *this* part of the tongue is due to the latter nerve, being evidently impaired by division of it. Moreover, cases are by no means rare, in which the gustative sensibility of the anterior part of the tongue has been destroyed, with its tactual sensibility; when there was no reason to suppose that any other than the Fifth pair of nerves was involved.* On the other hand, it is equally certain, that the sense of taste is not destroyed by section of the Lingual nerve on each side; and it seems also well ascertained, that it is impaired by section of the Glosso-pharyngeal nerve. Considering how nearly allied is the sense of Taste to that of Touch, and bearing in mind the respective distribution of these two nerves, it does not seem difficult to arrive at the conclusion, that both nerves are concerned in this function; but there seems good reason to believe the Glosso-pharyngeal to be exclusively that through which the impressions made by disagreeable substances taken into the mouth are propagated to the Medulla Oblongata, so as to produce nausea, and to excite efforts to vomit.

408. The functions of the *Par Vagum* at its *roots* have lately been made the subject of particular examination by various experimenters; some of whom (for instance, Bischoff, Valentin, Longet, and Morganti), have concluded that it *there* possesses no motor power, but is entirely a sensory, or rather, an afferent nerve. According to these, if the roots be carefully separated from those of the Glosso-Pharyngeal, and (which is a matter of some difficulty) from those of the spinal Accessory nerve, and be then irritated, no movements of the organs supplied by it can be observed; whilst, if the roots be irritated when in connection with the nervous centres, muscular contractions, evidently of a reflex character, result from the irritation; and strong evidences of their sensibility are also given. It has been further asserted that, when the roots of the Spinal Accessory nerve are irritated, no indications of sensation are given; but that the muscular parts supplied by the *Par Vagum*, as well as by its own trunk, are made to contract, even when the roots are separated from the nervous centres; so that these roots must be regarded as the channel of the motor influence, transmitted to them from the Medulla Oblongata. When the *Par Vagum* swells into the jugular ganglion, an interchange of fibres takes place between it and the Spinal Accessory; and it seems clear that the pharyngeal branches, which are among the most decidedly motor of all those given off from the Pneumogastric, may in great part be traced backwards into the Spinal Accessory. These statements confirm the idea of Arnold and Scarpa,—that the *Par Vagum* and Spinal Accessory are together analogous to a spinal nerve, the former answering to the posterior roots, and the latter to the anterior.—But, on the other hand, an equally numerous and trustworthy set of experimenters (among whom may be mentioned J. Reid, Müller, Volkman, and Stilling) are opposed to this opinion; maintaining that the *Par Vagum* has motor roots of its own, and that the Spinal Accessory possesses sen-

* Romberg, in Müller's Archiv., 1838, Heft III.

Fig. 154.

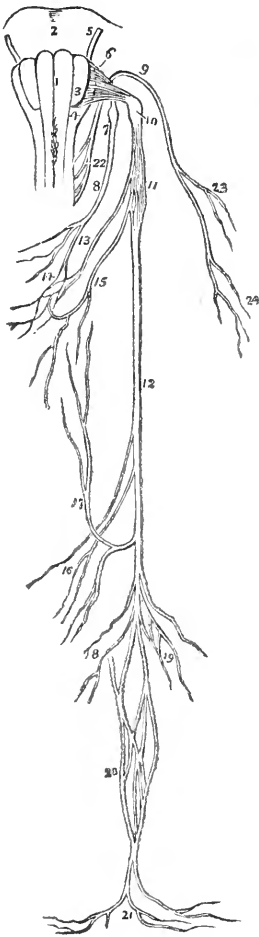

Origin and distribution of the Eighth pair of nerves. 1, 3, 4, the medulla oblongata; 1, the corpus pyramidale of one side; 3, the corpus olivare; 4, the corpus restiforme; 2, the pons Varolii; 5, the facial nerve; 6, the origin of the glosso-pharyngeal nerve; 7, the ganglion of Andersch; 8, the trunk of the nerve; 9, the spinal accessory nerve; 10, the ganglion of the pneumogastric nerve; 11, its plexiform ganglion; 12, its trunk; 13, its pharyngeal branch forming the pharyngeal plexus (14) assisted by a branch from the glosso-pharyngeal (8) and one from the superior laryngeal nerve (15); 16, cardiac branches; 17, recurrent laryngeal branch; 18, anterior pulmonary branches; 19, posterior pulmonary branches; 20, œsophageal plexus; 21, gastric branches; 22, origin of the spinal accessory nerve; 23, its branches distributed to the sterno-mastoid muscle; 24, its branches to the trapezius muscle.

[Fig. 155.]

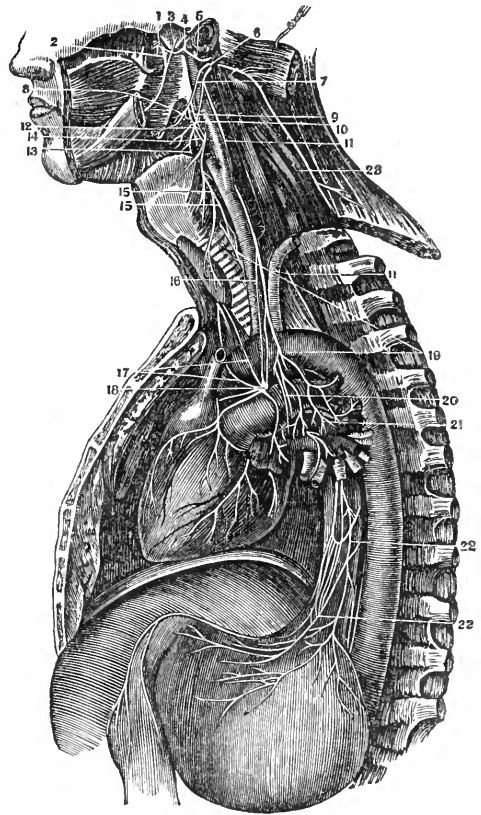

A view of the distribution of the Glosso-Pharyngeal, Pneumogastric and Spinal Accessory Nerves, or the Eighth pair; 1, the inferior maxillary nerve; 2, the gustatory nerve; 3, the chorda-tympani; 4, the auricular nerve; 5, its communication with the portio dura; 6, the facial nerve coming out of the stylo-mastoid foramen; 7, the glosso-pharyngeal nerve; 8, branches to the stylo-pharyngeus muscle; 9, the pharyngeal branch of the pneumogastric nerve descending to form the pharyngeal plexus; 10, branches of the glosso-pharyngeal to the pharyngeal plexus; 11, the pneumogastric nerve; 12, the pharyngeal plexus; 13, the superior laryngeal branch; 14, branches to the pharyngeal plexus; 15, 15, communication of the superior and inferior laryngeal nerves; 16, cardiac branches; 17, cardiac branches from the right pneumogastric nerve; 18, the left cardiac ganglion and plexus; 19, the recurrent or inferior laryngeal nerve; 20, branches sent from the curve of the recurrent nerve to the pulmonary plexus; 21, the anterior pulmonary plexus; 22, 22, the œsophageal plexus.]

sory roots; and affirming that irritation of the roots of the Spinal Accessory produces little or no effect on the muscles supplied by the trunk of the Par Vagus. The fact appears to be, that the roots of these two nerves are so commingled, that it is difficult to say what belong exclusively to each. Some of the fibres usually considered to belong to the Spinal Accessory, are occasionally seen to connect themselves with the roots of the Par Vagus, even before the ganglion is found upon it. And it seems most probable, that the roots of the Spinal Accessory are chiefly motor, and those of the Par Vagus chiefly afferent; that they mosculate with each other in a degree which may vary in different species, and even in different individuals; and that the Par Vagus may thus derive additional motor fibres from the Spinal Accessory, whilst it supplies that nerve with additional afferent fibres.—In regard to its *trunk*, there can be no doubt that the Par Vagus is to be considered as a nerve of double endowments; although it is certain that these endowments are very differently distributed amongst its branches. That the nerve is capable of conveying those impressions which become *sensations* when communicated to the sensorium, is experimentally proved by the fact that, when its trunk is pinched, the animal gives signs of acute pain; but it is also evident from the painful consciousness we occasionally have of an abnormal condition of the organs which it supplies. Thus, the suspension of the respiratory movements gives rise to a feeling of the greatest uneasiness, which must be excited by impressions conveyed through this nerve from the lungs; and an inflamed state of the walls of the air-passages causes the contact of cold and dry air to produce distressing pain and irritation. Yet, of the ordinary impressions conveyed from these organs, which are concerned in producing the respiratory movements, and in regulating the actions of the glottis, we are not conscious. The same may be said of the portion of the nerve distributed upon the alimentary tube. The pharyngeal branches are almost exclusively motor, the afferent function being performed by the Glosso-pharyngeal; whilst the œsophageal and gastric are both afferent and motor, conveying impressions which excite reflex movements in the muscles of those parts, but which do not become sensations except under extraordinary circumstances.

409. The section of the Par Vagus produces, as would readily be expected, great disorder of the functions of Respiration and Digestion, to which it ministers. It is an operation which has been very frequently performed; and the statements of its results vary considerably amongst each other, being generally influenced, in some degree, by the preconceived views of the experimenter.* The section of the Par Vagus, when practised with the view of ascertaining the influence of the nerve upon the lungs and stomach, is usually made in the neck, between the origins of the superior and inferior (or recurrent) laryngeal branches. Hence the muscles of the larynx are paralyzed (§ 379); and, if the animal should struggle violently, the ingress of air is likely to be obstructed by the flapping down of the arytenoid cartilages, and by the closure of the glottis. This is especially the case in young animals, in which the larynx is small. But in those that are full grown, and have a large larynx, an adequate quantity of air may still find its way through the aperture, if the animal refrain from any violent effort. In a considerable number of Dr. Reid's experiments, therefore, he did not find it necessary to introduce the trachea-tube, which other experimenters have generally employed; an opening was made into the trachea, however, in those instances in which, from any cause, the entrance of air was obstructed.

* The Author employs, as in his opinion the most worthy of confidence, the experiments of Dr. J. Reid (Edinb. Med. and Surg. Journ., vols. xlix. and li.), on whose accuracy he has strong personal reasons for placing reliance; and whose anatomical and pathological attainments are such as to render him fully competent to the task.

410. The functions of the Pharyngeal and Laryngeal branches of the Pneumogastric having been already explained (§§ 378, 379, and 385), we may now proceed to its Pulmonary division. In regard to this, we have to notice, that its endowments are chiefly *afferent*; its most important office being, to convey to the Medulla Oblongata the impression produced by venous blood in the capillaries of the lungs, or of carbonic acid in the air-cells. This impression may give rise, as we have seen, to respiratory movements, without producing sensation; but if it be from any cause stronger than usual, the sense of uneasiness which it occasions is very distressing. The impression may be imitated by pressure on the nerve; which occasions an immediate inspiratory movement. Hence the chief function of the afferent portion of the pulmonary division of the Par Vagus, is to serve as an excitor to the respiratory movements; which are consequently diminished in frequency, when the trunk is divided on both sides.—But this division also contains motor fibres, which are distributed upon the muscular fibres surrounding the bronchial tubes; and the experiments of Dr. Williams, which have been recently confirmed by Longet and Volkmann, agree in proving, that the calibre of the bronchial tubes can be caused to contract in a very considerable degree, by stimuli applied to this nerve, and especially by electricity.

411. Various alterations are produced in the Lungs, by section of the Pneumogastric nerves. The order in which these arise, and the causes to which they are immediately due, constitute very interesting subjects of investigation; and the knowledge of them will probably throw light upon many ill-understood morbid phenomena.

a. In the first place, it has been fully established by Dr. Reid, that section of the Vagus on one side only does not necessarily, or even generally, induce disease of that lung; and hence the important inference may be drawn, that the nerve does not exercise any *immediate* influence on its functions. When both Vagi are divided, however, the animal rarely survives long; but its death frequently results from the disorder of the digestive functions. Nevertheless, the power of digestion is sometimes restored sufficiently to re-invigorate the animals; and their lives may then be prolonged for a considerable time. In fifteen out of seventeen animals experimented on by Dr. Reid, the lungs were found more or less unfit for the healthy performance of their functions. The most common morbid changes were a congested state of the blood-vessels, and an effusion of frothy serum into the air-cells and bronchial tubes. In eight out of the fifteen, these changes were strongly marked. In some portions of the lungs, the quantity of blood was so great as to render them dense. The degree of congestion varied in different parts of the same lung; but it was generally greatest at the most depending portions. The condensation was generally greater, than could be accounted for by the mere congestion of blood in the vessels; and probably arose from the escape of the solid parts of the blood into the tissue of the lung. In some instances the condensation was so great, that considerable portions of the lung sank in water, and did not crepitate; but they did not present the granulated appearance of the second stage of ordinary pneumonia. In five cases in which the animals had survived a considerable time, portions of the lungs exhibited the second, and even the third stages of pneumonia, with puriform effusion into the small bronchial tubes; and in two, gangrene had supervened.

b. One of the most important points to ascertain, in an investigation of this kind, is the first departure from a healthy state;—to decide whether the effusion of frothy reddish serum, by interfering with the usual change in the lungs, *causes* the congested state of the pulmonary vessels and the laboured respiration; or whether the effusion is the *effect* of a previously congested state of the blood-vessels. The former is the opinion of many physiologists, who have represented the effusion of serum as a process of morbid secretion, directly resulting from the disorder of that function produced by the section of the nerve; the latter appears the unavoidable inference from the carefully-noted results of Dr. Reid's experiments. In several of these, only a very small quantity of frothy serum was found in the air-tubes, even when the lungs were found loaded with blood, and when the respiration before death was very laboured. This naturally leads us to doubt, whether the frothy serum is the cause of the laboured respiration, and of the congested state of the pulmonary vessels, in those cases where it is present; though there can be no doubt that, when once it is effused, it must powerfully tend to increase the difficulty of respiration, and still further to impede the circulation through the lungs. Dr. R. has satisfied himself of an important point, which has

been overlooked by others—that this frothy fluid is not mucus, though occasionally mixed with it; but that it is the frothy serum so frequently found in cases where the circulation through the lungs has been impeded before death. From this and other facts, Dr. R. concludes “that the congestion of the blood-vessels is the first departure from the healthy state of the lung, and that the effusion of frothy serum is a subsequent effect.”

c. The next point, therefore, to be inquired into, is the cause of this congestion; and this is most satisfactorily explained, upon the general principles regulating the circulation of the blood, by remembering that section of the Par Vagus greatly diminishes the frequency of the respiratory movements, and that the quantity of air introduced into the lungs is, therefore, very insufficient for the due aeration of the blood. We shall hereafter see reason to regard it as one of the best established principles in Physiology, that the activity of the changes which the blood undergoes in the capillary vessels, does, in some way or other, regulate its movement through them;—that, when these changes are proceeding with activity, the capillary circulation is proportionably accelerated;—and that when they are abnormally low in degree, the movement of the blood in the capillaries is stagnated. There is now abundant evidence, in regard to the Pulmonary circulation in particular, that, to prevent the admission of oxygen in the lungs, either by causing the animal to breathe pure nitrogen or hydrogen, or by occlusion of the air-passages, is to bring the circulation through their capillaries to a speedy check. Hence we should at once be led to infer, that diminution in the number of Respiratory movements would produce the same effect; and as little or no difference in their frequency is produced by section of one Vagus only, the usual absence of morbid changes in the lung supplied by it is fully accounted for. The congestion of the vessels, induced by insufficient aeration, satisfactorily accounts not only for the effusion of serum, but also for the tendency to pass into the inflammatory condition, sometimes presented by the lungs, as by other organs similarly affected. Dr. Reid confirms this view, by the particulars of cases of disease in the human subject, in which the lungs presented after death a condition similar to that observed in the lower animals after section of the Vagi; and in these individuals, the respiratory movements had been much less frequent than natural during the latter part of life, owing to a torpid condition of the nervous centres. The opinion (held especially by Dr. Wilson Philip) that section of the par vagum produces the serous effusion, by its direct influence on the function of Secretion, is further invalidated by the fact stated by Dr. Reid,—that he always found the bronchial membrane covered with its true mucus, except when inflammation was present.

“The experimental history of the Par Vagus,” it is justly remarked by Dr. Reid, “furnishes an excellent illustration of the numerous difficulties with which the physiologist has to contend, from the impossibility of insulating any individual organ from its mutual actions and reactions, when he wishes to examine the order and dependence of its phenomena.” In such investigations, no useful inference can be drawn from one or two experiments only; in order to avoid all sources of fallacy, a large number must be made; the points in which all agree must be separated from others, in which there is a variation of results; and it must be then inquired, to what the latter is due.

412. These observations apply equally to the other principal subject of inquiry in regard to the functions of the Par Vagus,—its influence upon the process of Digestion. The results obtained by different experimenters have led to differences of opinion as to its action, no less remarkable than those which have prevailed on the question just discussed. Thus, in regard to the afferent fibres of the Gastric division of the nerve, some physiologists maintain it to be by impressions on them alone, that the sense of hunger or satiety is excited; whilst others deny that they have any power of transmitting such impressions, which, according to them, do not originate in the stomach at all. Dr. Reid has arrived at the conclusion, from his numerous experiments, that the Par Vagus is the channel through which the mind becomes cognizant of the condition of the stomach; but that it is not the sole excitor of the sense of hunger. Animals, which have sustained section of the nerve on both sides, will eagerly take food, if they have not received too great a shock from the operation; but they seem to experience no feeling of satiety when the stomach is loaded. This inference is confirmed by Valentin, who mentions that puppies after the operation will take three times the same quantity of milk, as uninjured individuals of the same age, so as greatly to distend the abdomen.

The act of Vomiting has been proved to be excitable by impressions transmitted through the Gastric branches of the Par Vagus; although they constitute by no means the only channel, through which the various muscles concerned in it may be called into combined action (§ 505).

413. The question of the influence of the motor fibres of the Pneumogastric, upon the muscular walls of the stomach, has been already in part discussed (§ 387). Although it seems unquestionable that they have the power of stimulating these muscles to contraction, yet there is evidence that the movements of the stomach, which are most essential to digestion, may take place without it. Thus Dr. Reid found, in several of his experiments, that food was not only digested in the Stomach, but propelled into the Duodenum, subsequently to the operation. It seems very probable, however, that a temporary suspension of these movements (as of other independent functions of the stomach) may be the first effect of the operation.

414. It is necessary here to stop to notice, on account of the currency which it has obtained, the doctrine of Dr. Wilson Philip;—that the Par Vagus controls the secretion of the Gastric fluid; and that its division checks the secretion. He further stated, that the influence of Galvanism propagated along the nerve, would re-establish the secretion. This statement has been quoted and re-quoted, as an established physiological position; and, when united with the well-known fact, that galvanism would excite muscular contraction, it has seemed to Dr. W. Philip and other physiologists sufficient to establish the important position, that galvanism and nervous influence are identical. It has been disputed, however, by many other experimenters; who have satisfied themselves that the secretion of gastric juice continues after the operation; and consequently, that the elaboration of this product cannot be *dependent* on nervous influence supplied by the Par Vagus, though doubtless in part regulated by it. The first effects of the operation, however, are almost invariably found to be vomiting (in those animals capable of it), loathing of food, and arrestment of the digestive process; and it is not until after four or five days, that the power seems re-established. In the animals which died before that time, no indication of it could be discovered by Dr. R.; in those which survived longer, great emaciation took place; but when life was sufficiently prolonged, the power of assimilation seemed almost completely restored. This was the case in four out of the seventeen dogs experimented on; and the evidence of this restoration consisted in the recovery of flesh and blood by the animals, the vomiting of half-digested food permanently reddening litmus paper, the disappearance of a considerable quantity of alimentary matter from the intestinal canal, and the existence of chyle in the lacteals. It may serve to account in some degree for the contrary results, obtained by other experimenters, to state that seven out of Dr. R.'s seventeen experiments were performed before he obtained any evidence of digestion after the operation; and that the four which furnished this followed one another almost in succession; so that it is easy to understand why those who were satisfied with a small number of experiments, should have been led to deny it altogether.

[M. Bernard has instituted fresh experiments to determine this still-debated question, making use of the artificial fistulous openings into the stomach, invented by M. Blondlot. A dog's digestion had been thus watched for eight days, and had always been well effected. On the ninth day, after a day's fast, M. Bernard sponged out the stomach, which contracted on the contact of the sponge, and at once secreted a large quantity of gastric fluid; he then divided the pneumogastric nerves in the middle of the neck, and immediately the mucous membrane, which had been turgid, became pale, as if exsanguine, its movements ceased, the secretion of gastric fluid was instantaneously put a stop to, and a quantity of ropy neutral mucus was soon produced in its place. After this, no digestion was duly performed, and milk was no longer coagulated; raw meat remained unchanged, and the food (meat, milk, bread and sugar, which the dog had before thoroughly digested) remained for a long time

neutral, and at last acquired acidity only from its own transformation into lactic acid. In the stomachs of other dogs after the division of the nerves, he traced the transformation of cane-sugar into grape-sugar in three or four hours; and in ten or twelve hours the transformation into lactic acid was complete. In others, when the food was not capable of an acid transformation, it remained neutral to the last. In no case did any part of the food pass through the peculiar changes of chymification. In a last experiment, he gave to each of two dogs, in one of which he had cut the nerves, a dose of emulsine, and half an hour after, a dose of amygdaline (substances which are innocent alone, but when mixed produce hydrocyanic acid). The dog, whose nerves were cut, died in a quarter of an hour, the substances being absorbed unaltered and mixing in the blood: in the other, the emulsine was changed by the action of the gastric fluid before the amygdaline was administered, and it survived.—*Gazette Méd., Juin 1, 1844, from the Report of the Acad. des Sci., séance du 27 Mai, 1844.*—M. C.]

a. Another series of experiments was performed by Dr. Reid, for the purpose of testing the validity of the results obtained by Sir B. Brodie, relative to the effects of section of the Par Vagus upon the secretions of the stomach, after the introduction of arsenious acid into the system. According to that eminent Surgeon and Physiologist, when the poison was introduced after the Par Vagus had been divided on each side, the quantity of the protective mucous and watery secretions was much less than usual, although obvious marks of inflammation were present. In order to avoid error as much as possible, Dr. Reid made five sets of experiments, employing two dogs in each, as nearly as possible of equal size and strength, introducing the same quantity of the poison into the system of each in the same manner, but cutting the Vagi in one, and leaving them entire in the other. This comparative mode of experimenting is obviously the only one admissible in such an investigation. Its result was in every instance opposed to the statements of Sir B. Brodie; the quantity of the mucous and watery secretions of the stomach being nearly the same, in each individual of the respective pairs subjected to experiment; so that they can no longer be referred to the influence of the Eighth pair of nerves. Moreover, the appearances of inflammation were, in four out of the five cases, greatest in the animals whose Vagi were left entire; and this seemed to be referrible to the longer duration of their lives after the arsenic had been introduced. The results of Sir B. Brodie's experiments may perhaps be explained, by the speedy occurrence of death in the subjects of them, consequent (it may be) upon the want of sufficiently free respiration, which was carefully guarded against by Dr. Reid.

415. So far as the results of Dr. Reid's experiments may be trusted to, therefore, (and the Author is himself disposed to rely on them almost implicitly,) all the arguments which have been drawn in favour of the doctrine that Secretion depends upon Nervous agency, from the effects of lesion of the Vagi upon the functions of the Stomach, must be set aside. That this nerve has an important *influence* on the gastric secretion, is evident from the deficiency in its amount soon after the operation, as well as from other facts. But this is a very different proposition from that just alluded to; and the difference has been very happily illustrated by Dr. R. "The movements of a horse," he observes, "are independent of the rider on his back,—in other words, the rider does not furnish the conditions necessary for the movements of the horse;—but every one knows how much these movements may be influenced by the hand and heel of the rider." It may be hoped, then, that physiologists will cease to adduce the oft-cited experiments of Dr. Wilson Philip, in favour of the hypothesis (for such it must be termed) that secretion is dependent upon nervous influence, and that this is identical with galvanism.—Additional evidence of their fallacy is derived from the fact mentioned by Dr. Reid, that the usual mucous secretions of the stomach were always found; and they are further invalidated by the testimony of Müller, who denies that galvanism has any peculiar influence in re-establishing the gastric secretion, when it has been checked by section of the nerves.

416. It only remains to notice the influence of section of the Vagi upon the actions of the Heart. It has been asserted by Valentin and other experimenters, that mechanical irritation of these nerves, especially at their roots, has a tendency to excite or accelerate the heart's action; other experimenters, however, have obtained none but negative results. Admitting, what seems probable, that the Cardiac branches of the Pneumogastric have some influence

upon the Heart's action, it remains to inquire whether that influence is essential to its movements; and whether these nerves form the channel, through which they are affected by emotions of the mind, or by conditions of the bodily system. In regard to the first point, no doubt can be entertained; since the regular movements of the heart are but little affected by section of the Vagi. With respect to the second, there is more difficulty; since the number of causes, which may influence the rapidity and pulsations of the heart, is very considerable. For example, when the blood is forced on more rapidly towards the heart, as in exercise, struggling, &c., the stimulus to its contractions is more frequently renewed, and they become more frequent; and when the current moves on more slowly, as in a state of rest, their frequency becomes proportionably diminished. If the contractions of the heart were not dependent upon the blood, and their number were not regulated by the quantity flowing into its cavities, very serious and inevitably fatal disturbances of the heart's action would soon result. That this adjustment takes place otherwise than through the medium of the nervous centres, is evident from the fact that, in a dog, in which the par vagum and sympathetic had been divided in the neck on each side, violent struggling, induced by alarm, raised the number of pulsations from 130 to 260 per minute. It is difficult to ascertain, by experiment upon the lower animals, whether simple emotion, unattended with struggling or other exertion, would affect the pulsation of the heart, after section of the Vagi; but when the large proportion of the Sympathetic nerves proceeding to this organ is considered, and when it is also remembered that irritation of the roots of the upper cervical nerves stimulates the action of the heart through these, we can scarcely doubt that both may serve as the channels of this influence, especially in such animals as the dog, in which the two freely inosculate in the neck.

417. In regard to the functions of the *Spinal Accessory* nerve, also, there has been great difference of opinion; the peculiarity of its origin and course having led to the belief, that some very especial purpose is answered by it. The predominance of motor fibres in its roots, its inosculature with the Par Vagum, and its probable reception of sensory fibres from the latter whilst imparting to it motor filaments, have been already referred to (§ 408). As its trunk passes through the foramen lacerum, it divides into two branches; of which the internal, after giving off some filaments that assist in forming the pharyngeal branch of the Par Vagum, becomes incorporated with the trunk of that nerve; whilst the external proceeds outwards, and is finally distributed to the sterno-cleido-mastoideus and trapezius muscles, some of its filaments inosculating with those of the cervical plexus. When the external branch is irritated, before it perforates the sterno-mastoid muscle, vigorous convulsive movements of that muscle, and of the trapezius, are produced; and the animal does not give any signs of pain, unless the nerve is firmly compressed between the forceps, or is included in a tight ligature. Hence it may be inferred, that the functions of this nerve are chiefly motor, and that its sensory filaments are few in number. Further, when the nerve has been cut across, or firmly tied, irritation of the lower end is attended by the same convulsive movements of the muscles; whilst irritation of the upper end, in connection with the spinal cord, is unattended with any muscular movement. Hence it is clear that the motions occasioned by irritating it are of a direct, not of a reflex character. The same muscular movements are observed on irritating the nerve in the recently-killed animal, as during life.

a. According to Sir C. Bell, the *Spinal Accessory* is a purely Respiratory nerve, whose office it is to excite the involuntary or automatic movements of the muscles it supplies, which share in the act of respiration; and he states that the division of it paralyzes the muscles to which it is distributed, as muscles of respiration; though they still perform the voluntary

movements, through the medium of the spinal nerves. Both Valentin and Dr. Reid, however, positively deny that this is the case. Dr. Reid's method of experimenting was well adapted to test the truth of the assertion. Considering that, in the ordinary condition of the animal, it might be difficult to distinguish the actions of particular muscles, beneath the skin, when those in the neighbourhood were in operation; and also that the usual automatic movements might be simulated by voluntary action, when the breathing might be rendered difficult; he adopted the following plan:—A small dose of prussic acid was given to an animal, in which the Spinal Accessory had been previously divided on one side; and after the convulsive movements produced by it had ceased, the animal was generally found in a state similar to that which we sometimes see in apoplexy,—the action of the heart going on, the respirations being slow and heaving, and the sensorial functions appearing to be completely suspended. The Respiratory movements always ceased before the action of the heart; but they continued, in several of the animals experimented on, sufficiently long to allow the muscles of the anterior part of the neck to be laid bare, so that accurate observations could be made upon their contractions. In the dog and cat, the sterno-mastoid does not appear to have much participation in the ordinary movements of respiration; for in several instances it could not be seen to contract on either side, though the head was forcibly pulled towards the chest at each inspiratory movement, chiefly by the action of the sterno-hyoid and thyroid muscles. In two dogs and one cat, however, in which the head was fixed, and these respiratory movements were particularly vigorous, distinct contractions were seen in the exposed sterno-mastoid muscles, synchronous with the other movements of respiration: these were, perhaps, somewhat weaker on the side on which the nerve had been cut, but were still decidedly present. In one of these dogs, similar movements were observed in the trapezius, on the side on which the nerve had been divided. As the condition of the animal forbade the idea that volition could be the cause of these movements, it can scarcely be questioned that Sir C. Bell's statement was an erroneous one. As far, therefore, as these experiments afford any positive data, in regard to the functions of this nerve, it may be concluded that they are the same as those of the cervical plexus, with which it anastomoses freely. "Future anatomical researches," as Dr. Reid justly remarks, "may perhaps explain to us how it follows this peculiar course, without obliging us to suppose that it has a reference to any special function in the adult of the human species." Thus, the study of the history of development has accounted satisfactorily for the peculiar course of the recurrent laryngeal, which may be traced passing *directly* from the par vagum to the larynx, at a time when the neck can scarcely be said to exist, and when that organ is buried in the thorax. As this rises in the neck, the nerve, which at first came off below the great transverse blood-vessels, has both its origin and its termination carried upwards; whilst it is still tied down by these vessels in the middle of its course.

418. The *Hypoglossal* nerve, or *Motor Linguae*, is the only one which, in the regular order, now remains to be considered. That the distribution of this nerve is restricted to the muscles of the tongue, is a point very easily established by anatomical research; and accordingly we find that, long before the time of Sir C. Bell, Willis spoke of it as the nerve of the motions of articulation, whilst to the Lingual branch of the fifth pair he attributed the power of exercising the sense of taste; and he distinctly stated, that the reason of this organ being supplied with two nerves is its double function. The inference that it is chiefly, if not entirely, a *motor* nerve, which has been founded upon its anatomical distribution, is supported also by the nature of its origin, which is usually from a single root, corresponding to the anterior root of the Spinal nerves. Experiment shows that, when the trunk of the nerve is stretched, pinched, or galvanized, violent motions of the whole tongue, even to its tip, are occasioned; and also, that similar movements take place after division of the nerve, when the cut end most distant from the brain is irritated. In regard to the degree in which this nerve possesses sensory properties, there is some difference of opinion amongst physiologists, founded, as it would seem, on a variation in this respect between different animals. Indications of pain are usually given, when the trunk is irritated after its exit from the cranium; but these may proceed from its free anastomosis with the cervical nerves, which not improbably impart sensory fibres to it. But in some Mammalia, the hypoglossal nerve has been found to possess a small posterior root with a ganglion: this is the case in the ox, and also in the rabbit;

and in the latter animal, Valentin states that the two trunks pass out from the cranium through separate orifices, and that, after their exit, one may be shown

[Fig. 156.

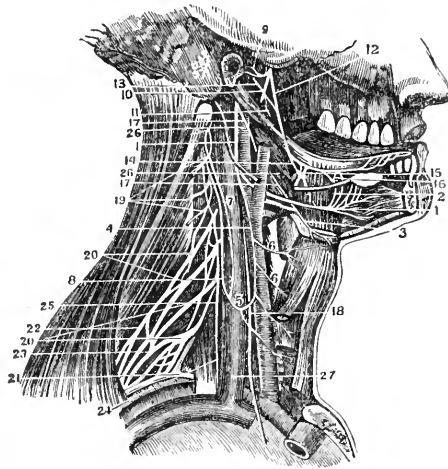

The course and distribution of the Hypo-Glossal or Ninth pair of nerves; the deep-seated nerves of the neck are also seen; 1, the hypo-glossal nerve; 2, branches communicating with the gustatory nerve; 3, a branch to the origin of the hyoid muscles; 4, the descendens noni nerve; 5, the loop formed with the branch from the cervical nerves; 6, muscular branches to the depressor muscles of the larynx; 7, a filament from the second cervical nerve, and 8, a filament from the third cervical, uniting to form the communicating branch with the loop from the descendens noni; 9, the auricular nerve; 10, the inferior dental nerve; 11, its mylo-hyoidean branch; 12, the gustatory nerve; 13, the chorda-tympani passing to the gustatory nerve; 14, the chorda-tympani leaving the gustatory nerve to join the sub-maxillary ganglion; 15, the sub-maxillary ganglion; 16, filaments of communication with the lingual nerve; 17, the glosso-pharyngeal nerve; 18, the pneumogastric or par vagum nerve; 19, the three upper cervical nerves; 20, the four inferior cervical nerves; 21, the first dorsal nerve; 22, 23, the brachial plexus; 24, 25, the phrenic nerve; 26, the carotid artery; 27, the internal jugular vein.]

to be sensory, and the other to be motor. Hence, this nerve, which is the lowest of those that originate in the cephalic prolongation of the spinal cord, generally known as the medulla oblongata, approaches very closely in some animals to the regular type of the spinal nerves; and though in Man it still manifests an irregularity, in having only a single root, yet this irregularity is often shared by the first cervical nerve, which also has sometimes an anterior root only.

419. The Hypoglossal nerve is distributed not merely to the tongue, but to the muscles of the neck which are concerned in the movements of the larynx; and the purpose of this distribution is probably to associate them in those actions, which are necessary for articulate speech. Though *all* the motions of the tongue are performed through the medium of this nerve, yet it would appear, from pathological phenomena, to have at least two distinct connections with the nervous centres; for in many cases of paralysis, the masticatory movements of the tongue are but little affected, when the power of articulation is much injured or totally destroyed: and the converse may be occasionally noticed. When this nerve is paralyzed on one side, in hemiplegia, it will be generally observed that the tongue, when the patient is directed to put

it out, is projected *towards* the palsied side of the face: this is due to the want of action of the lingual muscles of that side, which do not aid in pushing forward the tip; the point is consequently directed only by the muscles of the other side, which will not act in a straight direction, when unantagonized by their fellows. It is a curious fact, however, that the hypoglossal nerve seems not to be always palsied on the same side with the facial, but sometimes on the other. This has been suggested to be due to the origination of the roots of this nerve from near the point, at which the pyramids of the medulla oblongata decussate; so that some of its fibres come off, like those of the spinal nerves, without crossing; whilst others are transmitted to the opposite side, like those of the higher cerebral nerves; and the cause of paralysis may affect one or other of these sets of roots more particularly. Whatever may be the validity of this explanation, the circumstance is an interesting one, and well worthy of attention.*

420. The *general character and arrangement* of the Cephalic nerves, as distinguished from the ordinary Spinal, constitute a study of much interest, when considered in relation to Comparative Anatomy, and to Embryology. It appears, from what has been already stated, that the Par Vagus, Spinal Accessory, Glosso-pharyngeal, and Hypoglossal nerves, may be considered nearly in the light of ordinary Spinal nerves. They all take their origin exclusively in the Medulla Oblongata; and the want of correspondence in position, between their roots and those of the Spinal nerves, is readily accounted for by the alteration in the direction of the columns of the Spinal Cord, which,—as long since pointed out by Rosenthal, and lately stated prominently by Dr. Reid,—not only decussate laterally, but, as it were, antero-posteriorly (§ 353). The Hypoglossal, as just stated, not unfrequently possesses a sensory in addition to its motor root. The Glosso-pharyngeal, which is principally an afferent nerve, is stated by Arnold and others to have a small motor root; at any rate, the motor fibres which answer to it are to be found in the Par Vagus. That the Par Vagus and a portion of the Spinal Accessory together make up a spinal nerve, has been already stated as probable.

421. Leaving these nerves out of the question, therefore, we proceed to the rest. Comparative anatomy, and the study of Embryonic development, alike show that the Spinal cord and Medulla Oblongata constitute the most essential part of the nervous system in Vertebrata; and that the Cerebral Hemispheres are superadded, as it were, to this. At an early period of development, the Encephalon consists chiefly of three vesicles, which correspond with the ganglionic enlargements of the nervous cord of the Articulata, and mark three divisions of the cerebro-spinal axis; and, in accordance with this view, the Osteologist is able to trace, in the bones of the cranium, the same elements which would form three vertebræ, in a much expanded and altered condition. However improbable such an idea might seem, when the cranium of the higher Vertebrata alone is examined, it at once reconciles itself to our reason, when we direct our attention to that of Reptiles and Fishes; in which classes the size of the Cerebral or hemispheric ganglia is very small, in comparison with that of the Ganglia of special sensation; and in which the latter evidently form but a continuation of the Spinal Cord, modified in its function; so that, when we trace upwards the cavity of the spinal column into that of the cranium, we encounter no material change, either in its size or

* It may be questioned, however, whether the Hypoglossal is really paralyzed on the opposite side from the facial in such cases. An instance has been communicated to the Author by Dr. W. Budd, in which the hypoglossal nerve was completely divided on one side; and yet the tip of the tongue, when the patient was desired to put it out, was sometimes directed *from* and sometimes *towards* the palsied side; showing that the muscles of either half are sufficient to give any required direction to the whole.

direction. The three pairs of nerves of special sensation make their way out *through* these three cranial vertebræ respectively. At a later period of development, other nerves are interposed *between* these; which, being *intervertebral*, are evidently more analogous to the Spinal nerves, both in situation and function. A separation of the primitive fibres of these takes place, however, during the progress of development, so that their distribution appears irregular. Thus the greater part of the sensory fibres are contained in the large division of the Trigemini; whilst, of the motor fibres, the anterior ones chiefly pass forwards as the Oculo-motor and Patheticus; and of the posterior, some form the small division of the Trigemini, and others unite with the first pair from the Medulla Oblongata to form the Facial. This last fact explains the close union which is found in Fishes and some Amphibia, between that nerve and those proceeding more directly from the Medulla Oblongata. According to Valentin, the Glosso-pharyngeal is the sensory portion of the first pair from the Medulla Oblongata, of which the motor part is chiefly comprehended in the Facial nerve. It is very interesting to trace this gradual metamorphosis from the character of the Spinal nerves, which is exhibited in the Cephalic, when they are traced upwards from the Medulla Oblongata; and this is shown also, in some degree, in the nerves of special sensation (§ 446, a). Although we are accustomed to consider the Fifth pair as *par eminentie* the Spinal nerve of the head, the foregoing statements, founded upon the history of development, show that the nerves of the Orbit really belong to its motor portion; they may consequently be regarded as altogether forming the *first* of the *intervertebral* or Spinal nerves of the cranium. The Facial and Glosso-pharyngeal appear to constitute the *second*; whilst the Par Vagum and Spinal Accessory, forming the *third* pair, intervene between this and the true spinal, of which the Hypoglossal may be considered as the first.

5. Of the Sensory Ganglia and their Functions.—Consensual Movements.

422. At the base of the Brain in Man, concealed by the Cerebral Hemispheres, but still readily distinguishable from them, we find a series of ganglionic masses; which are in direct connection with the nerves of Sensation; and which appear to have functions quite independent of those of the other components of the Encephalon.—Thus anteriorly we have the *Olfactive* ganglia, in what are commonly termed the bulbous expansions of the Olfactive nerve. That these are real ganglia, is proved by their containing grey or vesicular substance; and their separation from the general mass of the Encephalon, by the peduncles or footstalks commonly termed the trunks of the Olfactory nerves, finds its analogy in many species of Fish (§ 357). The ganglionic nature of these masses is more evident in many of the lower Mammalia, in which the organ of smell is highly developed, than it is in Man, whose olfactive powers are comparatively moderate.—At some distance behind these, we have the representatives of the *Optic* ganglia, in the Tubercula Quadrigemina, to which the principal part of the roots of the Optic nerve may be traced. Although these bodies are so small in Man, in comparison to the whole Encephalic mass, as to be apparently insignificant, yet they are much larger, and form a more evidently important part of it in many of the lower Mammalia; though still presenting the same general aspect.—The *Auditory* ganglia do not form distinct lobes or projections; but are lodged in the substance of the Medulla Oblongata. Their real character is most evident in certain Fishes, as the Carp; in which we trace the Auditory nerve into a ganglionic centre as distinct as the Optic ganglion. In higher animals, however, and in Man, we are able to trace the Auditory nerve into a small mass of vesicular matter, which lies on each side of the Fourth Ventricle; and although this is lodged in the midst

of parts whose function is altogether different, yet there seems no reason for doubting that it has a character of its own, and that it is really the ganglionic

[Fig. 157.

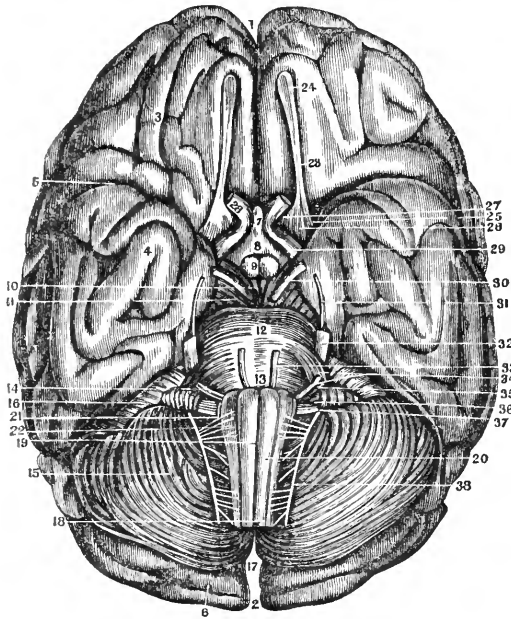

A view of the base of the Cerebrum and Cerebellum, together with their nerves ; 1, anterior extremity of the fissure of the hemispheres of the brain ; 2, posterior extremity of the same fissure ; 3, the anterior lobes of the cerebrum ; 4, its middle lobe ; 5, the fissure of Sylvius ; 6, the posterior lobe of the cerebrum ; 7, the point of the infundibulum ; 8, its body ; 9, the corpora albicantia ; 10, cineritious matter ; 11, the crura cerebri ; 12, the pons Varolii ; 13, the top of the medulla oblongata ; 14, posterior prolongation of the pons Varolii ; 15, middle of the cerebellum ; 16, anterior part of the cerebellum ; 17, its posterior part and the fissure of its hemispheres ; 18, superior part of the medulla spinalis ; 19, middle fissure of the medulla oblongata ; 20, the corpus pyramidale ; 21, the corpus restiforme ; 22, the corpus olivare ; 23, the olfactory nerve ; 24, its bulb ; 25, its external root ; 26, its middle root ; 27, its internal root ; 28, the optic nerve beyond the chiasm ; 29, the optic nerve before the chiasm ; 30, the motor oculi, or third pair of nerves ; 31, the fourth pair or pathetic nerves ; 32, the fifth pair, or trigemini nerves ; 33, the sixth pair, or motor externus ; 34, the facial nerve ; 35, the auditory—the two making the seventh pair ; 36, 37, 38, the eighth pair of nerves. (The ninth pair is not here seen]

centre of the Auditory nerve.—In like manner, we may probably fix upon a collection of vesicular matter, imbedded in the Medulla Oblongata,—which is considered by Stilling to be the nucleus of the Glosso-pharyngeal nerve, and to which a portion of the sensory root of the Fifth pair may be traced,—as representing the *Gustatory* ganglion.

423. At the base of the Cerebral Hemispheres, we find two other large ganglionic masses, on either side ; into which all the fibres appear to pass, which connect the Hemispheres with the Medulla Oblongata. These are the *Thalami Optici*, and the *Corpora Striata*. Now, although these are commonly regarded in the light of appendages, merely, to the Cerebral Hemispheres, it is evident, from the large quantity of vesicular matter they contain, that they have an independent character ; and that, even if the *Cerebral* fibres simply *pass through* them, other fibres have their proper ganglionic centres

in them. Such an idea is further warranted by the history of their development; for we find, in the Human embryo of the sixth week, a distinct vesicle for the *Thalami Optici*, interposed between the vesicle of the *Corpora Quadrigemina*, and that which gives origin to the *Cerebral Hemispheres*; whilst the *Corpora Striata* constitute the floor of the cavity or ventricle, which exists in the latter.—Now, as already pointed out, we may distinguish in the *Medulla Oblongata* and *Crura Cerebri*, a *sensory* and a *motor* tract; by the endowments of the nerves which issue from them. The sensory tract may be traced upwards from the *Olivary columns*, until it almost entirely spreads itself through the substance of the *Thalamus*. Moreover, the *Optic nerves*, and the *peduncles of the Olfactive*, may be shown to have a distinct connection with the *Thalami*; the former by the direct passage of a portion of their roots into these *ganglia*; and the latter through the medium of the *Fornix*. Hence we may fairly regard the *Thalami Optici* as the chief focus of the *Sensory nerves*; and more especially as the *ganglionic centre* of the nerves of *common sensation*, which ascend to it from the *Medulla Oblongata* and *Spinal Cord*.—On the other hand, the *Corpora Striata* are implanted on the motor tracts of the *Crura Cerebri*, which descend into the *Pyramidal columns*; and their connection with the *motor function* is very generally admitted, from the constancy with which *paralysis* is observed to accompany lesions of these bodies, even when they are affected to a very trifling extent.

424. The *Thalami Optici*, and the *Corpora Striata*, as is well known, are very closely connected with each other by *commissural fibres*; and, if the preceding account of their respective offices be correct, they may be regarded as having much the same relation to each other, as that which exists between the posterior and anterior peaks of vesicular matter in the *Spinal Cord*; the latter issuing motor impulses in response to sensations excited through the former. They are also closely connected with other *ganglionic masses* in their neighbourhood, such as the *locus niger*, and the vesicular matter of the *pons*; which again, are in close relation with the vesicular matter of the *medulla oblongata*.—Altogether it is very evident, that an extensive tract of *ganglionic matter* exists at the base of the *Encephalon*, which is really just as distinct from either the *Cerebrum* or *Cerebellum*, as these are from each other; and we have next to inquire, what functions are to be assigned to it.

425. The determination of these may seem the more difficult, as it is impossible to make any satisfactory experiments upon the *ganglionic centres* in question, by isolating them from the *Cerebral Hemispheres* above, and from the *Medulla Oblongata* and *Spinal Cord* below. But the evidence derived from *Comparative Anatomy* appears to be in this case particularly clear; and, rightly considered, seems to afford us nearly all the information we require. In the series of “experiments prepared for us by nature,” which is presented to us in the descending scale of *Animal life*, we witness the effects of the gradual change of the relative development of the *Sensory ganglia* and *Cerebral Hemispheres*, which are presented to us in the *Vertebrated classes*; and the results of the entire withdrawal of the latter, and of the sole operation of the former, which are presented in the higher *Invertebrata*. In the sketch already given of the *Comparative Anatomy of the Encephalon in Vertebrata*, it has been shown that the *Sensory ganglia* gradually increase, whilst the *Cerebral hemispheres* as regularly diminish, in relative size and importance, as we descend from the higher *Mammalia* to the lower,—from these to *Birds*,—thence to *Reptiles*,—from these, again, to the higher *Fishes*, in which the aggregate size of the *Sensory ganglia* equals that of the *Cerebrum*,—thence to the lower *Fishes*, in which the size of the *Cerebral lobes* is no greater than that of a single pair of *sensory ganglia*, the *Optic*, and frequently even inferior,—and lastly, to the *Amphioxus* or *Lancelot*, the lowest *Vertebrated animal* of which we have

any knowledge, in which there is not the rudiment of a Cerebrum, the Encephalon being only represented by a single ganglionic mass, which, from its connection with the nerves of sense, must obviously be regarded as analogous to the congeries of ganglia that we find in the higher forms of the class.

a. It has been supposed, from the results of an imperfect examination of this very remarkable animal, that it is altogether destitute of Encephalon; and that it possesses no ganglionic centre, except the Spinal Cord and Medulla Oblongata. The researches of M. de Quatrefages, however, indicate that the most anterior of the ganglionic enlargements exhibited by its Cerebro-Spinal axis, is of a more special character than the rest; uniting in itself the characters of several distinct ganglionic centres. The ganglionic enlargements, arranged in a linear series, which altogether represent the Spinal Cord, each give origin to a *single* pair of nerves; but the cephalic ganglion is the centre of *five* pairs. Of these, the *first* pair is distinctly an *Optic* nerve; being exclusively distributed to an organ, which has the structure of a rudimentary Eye, though lodged within the dura mater;—reminding us, in its situation, of the Auditory apparatus of the Gasteropod Mollusks, which is actually imbedded in the posterior part of the Cephalic ganglia. The *second* pair seems to correspond in its distribution with the Facial; whilst the *third* represents the Fifth pair and the Pneumogastric conjointly. The *fourth* and *fifth* pairs are distributed to the fin-like expansion, which forms the margin of the head as well as of the body; and seem to hold the same relation to the two preceding pairs, as the dorsal branches of the Spinal nerves bear to the ventral,—or, in Man, the posterior to the anterior. Hence we see that this single ganglion is made up of at least three centres; of which the first corresponds to the Optic ganglion of higher Vertebrata; whilst the second and third are analogous to certain parts of the Medulla Oblongata in immediate connection with them. Moreover, this little animal possesses an organ of Smell, much more distinct than the rudimentary eye; and although its connection with the anterior part of the cephalic ganglion has not yet been traced (owing to the extreme minuteness of the parts, and the difficulty resulting from the interposition of the dura mater, which is in equally close contact with the nervous mass which it incloses, and with the olfactive organ which abuts upon its exterior), there can be little doubt that such a connection exists, and that the Cephalic mass unites within itself also the characters of an Olfactive ganglion. But no part whatever can be traced, which bears any resemblance to the Cerebral hemispheres; and as these, wherever they exist, are completely isolated from the Sensory ganglia, their absence may be stated as an almost certain fact. Hence, in this particular, the Amphioxus evidently corresponds with the Invertebrata; to which its affinity is so close in other particulars, that many Naturalists have hesitated to assign it a place in the Vertebrated series at all; and, as will be seen in the next paragraph, the union of several really distinct ganglionic centres into one Cephalic mass, is a fact which is capable of actual demonstration. (See the Memoir on the Branchiostoma or Amphioxus, by M. de Quatrefages, in the Annales des Sciences Naturelles, 3^{me} Série, Zoologie, tom. iv.)

426. Descending to the Invertebrated series, we find that, except in a few of those which border most closely upon Vertebrata (such, for example, as the Cuttle-Fish), the whole Cephalic mass appears to be made up of ganglia, in immediate connection with the nerves of sense. These may appear to form but a single pair; yet they are in reality composed of *several* pairs, fused (as it were) into one mass. Of this we may judge by determining the number of distinct pairs of nerves which issue from them; and also by the investigation of the history of their development, the results of which bear a close correspondence with those obtained in the preceding method.

a. Thus, Mr. Newport has shown, by studying the development of the head in certain species of the class Myriapoda, that it is originally composed of no less than *eight* segments; each having its peculiar appendages; and each possessing (like the segments of the body) its own pair of ganglionic centres. These segments afterwards coalesce into two portions; of which the most anterior, made up by the union of four sub-segments, is termed the proper *cephalic*; whilst the posterior, also made up of four sub-segments, is termed the *basilar*. The four pairs of ganglia belonging to the cephalic portion coalesce into the one pair of *cephalic* ganglia; whilst the other four pairs unite to form the *first sub-oesophageal* ganglia.—The *first* of the original sub-segments had, as its proper appendages, the antennæ; and the ganglia contained in it were evidently the proper centres of the *antennal* nerves. The *second* had no movable appendages, but contained the eyes; and its ganglia were evidently the proper centres of the *optic* nerves. To the *third* belonged the first pair of jaws, the maxillæ; and to the *fourth*, the maxillary palpi; and these organs derived nerves from their

own ganglionic centres, belonging to their respective segments. Now as all these nerves are found to proceed, in the adult animal from the single pair of Cephalic ganglia, it is obvious that these combine the functions of the ganglionic centres of the nerves of the antennæ, eyes, and palpi, which are all sensory organs, as well as of the maxillary nerves, which must be chiefly motor. And it is equally obvious, that there is nothing in such an animal, which, can be compared to a pair of Cerebral hemispheres; since all the ganglia of the original segments are directly connected with the appendages of those segments respectively.

427. It is further to be remarked, that the development of the Cephalic ganglia in the Invertebrata always bears an exact proportion to the development of the *eyes*; the other organs of special sense being comparatively undeveloped; whilst these, in all the higher classes at least, are instruments of great perfection, and evidently connected most intimately with the direction of the movements of the animals. Of this fact we have a remarkable illustration in the history of the metamorphoses of Insects; the eyes being almost rudimentary, and the Cephalic ganglia comparatively small, in most Larvæ; whilst both these organs attain a high development in the Imago, to whose actions the faculty of sight is essential.

428. Now upon making a similar comparison of the *psychical* operations of these different classes of animals, we are led to perceive that, as we descend from the higher to the lower Vertebrata, we gradually lose the indications of Intelligence and Will, as the sources of the movements of the animal; whilst we see a corresponding predominance of those, which are commonly denominated *Instinctive*, and which are performed (as it would appear) in immediate response to certain sensations,—without any *intentional* adaptation of means to ends on the part of the individual, although such adaptiveness doubtless exists in the actions themselves, being a consequence of the original constitution of the nervous system of each animal performing them. It cannot be doubted by any person who has attentively studied the characters of the lower animals, that many of them possess psychical endowments, corresponding with those which we term the intellectual powers and moral feelings in Man; but in proportion as these are undeveloped, in that proportion is the animal under the dominion of those Instinctive impulses, which, so far as its own consciousness is concerned, may be designated as blind and aimless, but which are ordained by the Creator for its protection from danger, and for the supply of its natural wants. The same may be said of the Human infant, or of the Idiot, in whom the reasoning powers are undeveloped. Instinctive actions may in general be distinguished from those which are the result of voluntary power guided by reason, chiefly by the two following characters:—1. Although, in many cases, experience is required to give the Will command over the muscles concerned in its operations, no experience or education is required, in order that the different actions, which result from an Instinctive impulse, may follow one another with unerring precision. 2. These actions are always performed by the same species of animal, nearly, if not exactly, in the same manner; presenting no such variation in the means adapted to the object in view, and admitting of no such improvement in the progress of life, or in the succession of ages, as we observe in the habits of individual men, or in the manners and customs of nations, that are adapted to the attainment of any particular ends, by those voluntary efforts which are guided by reason. The fact, too, that these instinctive actions are often seen to be performed under circumstances rendering them nugatory, as reason informs us, for the ends which they are to accomplish—(as when the Flesh-fly deposits her egg on the Carrion-plant instead of a piece of meat, or when the Hen sits on a pebble instead of her egg)—is an additional proof, that the Instinctive actions of animals are prompted, like the consensual movements

we have been recently inquiring into, by an impulse which immediately results from a particular sensation being felt, and not by anticipation of the effect which the action will produce.

429. The highest development of the purely Instinctive tendencies, is to be found in the class of Insects; and above all in the order *Hymenoptera*, and in that of *Neuroptera*, which is nearly allied to it. It is in this division of the class, that we find the highest development of the sensory organs and of the cephalic ganglia, and the most active powers of locomotion. We may here trace the operations of Instinct, with the least possible interference of Intelligence. It is, of course, impossible to draw the line between the two sources of action, with complete precision; but we observe, in the habits of Bees and other social Insects, every indication of the absence of a power of choice, and of the entire domination of instinctive propensities called into action by sensations. Thus, although Bees display the greatest art in the construction of their habitations, and execute a variety of curious contrivances, beautifully adapted to variations in their circumstances, the constancy with which individuals and communities will act alike under the same conditions, appears to preclude the idea of their possessing any inherent power of spontaneously departing from the line of action, to which they are tied down by the constitution of their Nervous system. We do not find one individual or one community clever, and another stupid; nor do we ever witness a disagreement, or any appearance of indecision, as to the course of action to be pursued by the several members of any republic.* For a Bee to be destitute of its peculiar tendency to build at certain angles, would be as remarkable as for a Human being to be destitute of the desire to eat, when his system should require food. It may be doubted, on the other hand, whether there was ever a case, in which an Insect of any kind could be taught to recognize any one, who had been in the habit of feeding it; or to show any other unequivocal indications of intelligence.

a. Such anecdotes have been related of *Spiders*; but these animals are the highest of the Articulated series, having many points of approach to Vertebrata. It is probable, therefore, that they may possess the rudiment of a Cerebrum; a similar rudiment making its appearance in the higher Cephalopods, which occupy a corresponding place in the Molluscous series.

b. The only manifestation of educability, which the Author has ever noticed, during a pretty long familiarity with the habits of Bees, is the acquirement of a power of distinguishing the entrance of their hive from that of others around. When a swarm is first placed in a new box, and the Bees have gone forth in search of food, they often seem puzzled on their return, as to which is their own habitation; more especially if there be several hives, with similar entrances, in one bee-house; and it has been proposed to paint these entrances of different colours, in order to enable the Bee to distinguish them more readily. In a short time, however, even without such aid, the Bees are seen to dart from a considerable height in the air, directly down to their proper entrances; showing that they have *learned* to distinguish these, by a memorial power. This the Author has observed most remarkably, in a case in which a hive is placed in the drawing-room of a house, the entrance to it being beneath one of the windows; the adjoining houses have windows precisely similar, except in the absence of this small passage; and he has often noticed that, when a new stock has been placed in this hive, the Bees are some days in learning the exact position of their house, considerably annoying the neighbours by flying in at their windows.

* The community of Bees, though commonly reputed to be a *monarchy*, governed by a sovereign, is really a republic, in which every individual performs its own independent part. The function of the queen is simply that of *breeding*; and as (among the Hive-Bees at least) she is the *only* female, the purpose of the instinct, which leads the workers to treat her with peculiar attention, is very obvious. But the idea that she directs the operations of the hive, or exerts any peculiar control over the ordinary Bees, is entirely destitute of foundation. The actions of the latter all tend to one common end; simply because they are performed in response to impulses, which all alike share.

430. Thus the analysis of such of the actions of these animals, as are evidently of a higher order than the simply-reflex, terminates in referring them to the immediate directing influence of Sensations; which, being received by the cephalic ganglia through the sensory nerves, excite respondent motor impulses, which are propagated to the various muscles of the body, through those portions of the motor trunks that issue from them. As the term Instinctive has been employed in a great variety of significations, and is very indefinite in its character, we may more appropriately apply the designation *Consensual* to the actions of this group. We have now to inquire, whether there is any class of movements in Man and the higher Vertebrata, which seems to possess a similar character, and which may be regarded as the special function of the ganglionic centres under consideration.—By far the larger part of the movements of these animals (putting aside the simply-reflex) are performed under the direction of the Intelligence; to which the sensations are communicated; by which a reasoning process is founded upon them; and from which, at last, issues that mandate, which is called the Will. Consequently, there are comparatively few movements, in the adult at least, which can be clearly distinguished as neither *voluntary*, on the one hand, nor *reflex* on the other. Such actions, however, do exist; and serve to show that, although the Instinctive propensities are in great measure superseded by the Intelligence, they may still operate independently of it. As examples of this group, we may advert to the act of Vomiting, produced by various causes which act through the organs of sense; such as the sight of a loathsome object, a disagreeable smell, or a nauseous taste. The excitement of the act of Sneezing by a dazzling light, is another example of the same kind; for even if it be granted, that the act of sneezing is ordinarily excited through the reflex system alone (which is by no means certain), there can be no doubt that in this instance it cannot be brought into play without a sensation actually felt. The same may be said of the Laughter which sometimes involuntarily bursts forth, at the provocation of some sight or sound, to which no distinct ludicrous idea or emotion can be attached; and of that resulting from the act of tickling, in which case it is most certainly occasioned by the sensation, and by that alone.

431. The direct influence of Sensations, in occasioning and governing movements, which are neither reflex nor voluntary, is most remarkably manifested in many phenomena of disease. Thus in cases of excessive irritation of the retina, which renders the eye most painfully sensitive to even a feeble amount of light,—the state designated as *photophobia*,—the eyelids are drawn together spasmodically, with such force as to resist very powerful efforts to open them; and if they be forcibly drawn apart, the pupil is frequently rolled beneath the upper lid (apparently by the action of the inferior oblique muscle), much further than it could be carried by a voluntary effort. And in Pleuritis, Pericarditis, and other painful affections of the parietes of the chest, we may observe the usual movements of the ribs to be very much abridged; the dependence of this abridgement upon the painful sensation which they occasion, being most evident in those instances in which the affection is confined to one side,—for there is then a marked curtailment in *its* movements, whilst those of the other side may take place as usual; a difference which cannot be reflex, and which the Will cannot imitate. Again, in some Convulsive disorders, we observe that the paroxysms are excited by causes, which act through the organs of special sense; thus in Hydrophobia, we observe the immediate influence of the sight or the sound of liquids, and of the slightest currents of air; and in many Hysterical subjects, the sight of a paroxysm in another individual is the most certain means of inducing it in themselves.

432. The results of experiments, so far as any reliance can be placed upon them, confirm these views; by showing that any disturbance of the usual

actions of the organs of sense, and of the nervous centres with which they are connected, in animals whose movements are directly governed by the sensations received through these, is followed by abnormal movements. Thus it has been ascertained by Flourens, that a vertiginous movement may be induced in pigeons, by simply blindfolding one eye; and Longet has produced the same effect, by evacuating the humours of one eye. These vertiginous movements are more decided and prolonged, when, instead of blinding one eye, one of the tubercula quadrigemina is removed; the animal continuing to turn itself towards the injured side, as if rotating on an axis.—The results of the experiments of M. Flourens upon the portion of the Auditory nerve proceeding to the Semi-circular canals, are still more extraordinary. Section of the horizontal semi-circular canal in Pigeons, on both sides, induces a rapid jerking horizontal movement of the head, from side to side; and a tendency to turn to one side, which manifests itself whenever the animal attempts to walk forwards. Section of a vertical canal, whether the superior or inferior, of both sides, is followed by a violent vertical movement of the head. And section of the horizontal and vertical canals at the same time, causes horizontal and vertical movements. Section of either canal on one side only, is followed by the same effect as when the canal is divided on both sides; but this is inferior in intensity. The movements continue to be performed during several months. In Rabbits, section of the horizontal canal is followed by the same movements, as those exhibited by pigeons; and they are even more constant, though less violent. Section of the anterior vertical canal causes the animal to make continued forward *somersets*; whilst section of the posterior vertical canal occasions continual backward somersets. The movements cease when the animal is in repose; and they recommence when it begins to move, increasing in violence as its motion is more rapid.—These curious results are supposed by M. Flourens to indicate, that the nerve supplying the semi-circular canals does not minister to the sense of hearing, but to the direction of the movements of the animal: but they are fully explained upon the supposition that the normal function of the semi-circular canals is to indicate to the animal the *direction* of sounds, and that its movements are partly determined by these; so that a destruction of one or other of them will produce an irregularity of movement (resulting, as it would seem, from a sort of giddiness on the part of the animal), just as when one of the eyes of a bird is covered or destroyed, as in the experiments just cited.

433. But we may trace the influence of the Sensory ganglia, not merely in their direct and independent operation on the muscular system, but also in the manner in which they participate in all Voluntary actions. There can be no doubt that, in every exertion of the *will* upon the muscular system, we are guided by the sensations communicated through the afferent nerves, which indicate to the Sensorium the state of the muscle. Many interesting cases are on record, which show the necessity of this Muscular Sense, for determining voluntary contraction of the muscle. Thus, Sir C. Bell (who first prominently directed attention to this class of facts, under the designation of the *Nervous Circle*), mentions an instance of a woman, who was deprived of it in her arms, without losing the motor power; and who stated, that she could not sustain anything in her hands (not even her child), by the strongest effort of her will, unless she kept her eyes constantly fixed upon it; the muscles losing their power, and the hands dropping the object, as soon as the eyes were withdrawn from it. Here the employment of the *visual* sense supplied the deficiency of the *muscular*; but instead of being inseparably connected, as the latter is in the state of health, with the action of the muscle, the former could be only brought to bear by an effort of the will; and the sustaining power was therefore dependent, not upon the immediate influence of the will upon the

muscle, but upon the voluntary direction of the Sight towards the object to be supported. Again, in the production of vocal sounds, the nice adjustment of the muscles of the larynx, which is requisite to produce determinate tones, can only be learned in the first instance under the guidance of the sensation of the sounds produced, and can only be effected by an act of the will, in obedience to a mental conception (a sort of inward sensation) of the tone to be uttered,—which conception cannot be formed, unless the sense of hearing has previously brought similar tones to the mind. Hence it is, that persons who are born *deaf*, are also *dumb*. They may have no malformation of the organs of speech; but they are incapable of uttering distinct vocal sounds or musical tones, because they have not the guiding conception, or recalled sensation, of the nature of these. By long training, and by efforts directed by the muscular sense of the larynx itself, some persons thus circumstanced have acquired the power of speech; but the want of a sufficiently definite control over the vocal muscles, is always very evident in their use of the organ.

434. The conjoint movements of the two eyes, which concur to direct their axes towards the same object, are among the most interesting of these actions, in which Volition and Consensual action are alike concerned; and they afford an excellent illustration of the necessity for guiding sensations, to determine the actions of muscles. The sensations, however, are not so much those of the muscles themselves, as those received through the visual organ; but the former appear capable of continuing to guide the harmonious movements of the eyeballs, when the sense of sight has been lost. It is a striking peculiarity of these movements, that, in the majority of them, two muscles or combinations of muscles of opposite action are in operation at once; thus, when the eyes are made to rotate in a horizontal plane, the internal rectus of one side acts with the external rectus of the other. In most other cases, there is a difficulty in performing two opposite movements, on the two sides at the same time. Thus, if we move the right hand as if winding on a reel, and *afterwards* make the left hand revolve in a contrary direction, no difficulty is experienced; but if we attempt to move the two *at the same time* in contrary directions, we shall find it almost impossible.—As the Consensual movements of the Eyes are of sufficient interest and importance, to require a detailed consideration, they will be examined more fully at the close of the present section (§§ 450—456).

435. If the preceding views be correct, we may regard the series of Ganglionic centres which have been enumerated (§§ 422, 423), as constituting the real *Sensorium*; each ganglion having the power of communicating to the mind the impressions derived from the organ, with which it is connected, and of exciting automatic muscular movements in response to these sensations. If this position be denied, we must either refuse the attribute of consciousness to those animals, which possess no other encephalic centres than these; or we must believe that the *addition* of the Cerebral hemispheres, in the Vertebrated series, *alters* the endowments of the Sensory ganglia,—an idea which is contrary to all analogy. So far as the results of experiments can be relied on, they afford a corroboration of these views. The degree in which animals high in the scale of organization can perform the functions of life, without any other centre of action than the Ganglia of Special sense, the Medulla Oblongata, and the Cerebellum, appears extraordinary to those who are accustomed to regard the Cerebral Hemispheres as the centre of all energy. From the experiments of Flourens, Hertwig, Magendie, and others, it appears that not only Reptiles, but Birds and Mammalia, may survive for many weeks or months (if their physical wants be duly supplied) after the removal of the whole Cerebrum. It is difficult to substantiate the existence in them of actual Sensation; but some of their movements appear to be of a higher kind

than those resulting from mere Reflex action. One of the most remarkable phenomena exhibited by such a being, is the power of maintaining its equilibrium, which could scarcely exist without consciousness. If it be laid upon the back, it rises again; if pushed, it walks. If a Bird thus mutilated be thrown into the air, it flies; if a Frog be touched, it leaps. It swallows food and liquid, when they are placed in its mouth; and the digestive operations, the acts of excretion, &c., take place as usual. In the case of a Pigeon experimented on by Malacorpis, which is recorded by Magendie, there appears sufficient proof of the persistence of a certain amount of sensation. Although the animal was not affected by a strong light suddenly made to fall upon its eyes, it was accustomed, when confined in a darkened or partially-illuminated room, to seek out the light parts; and *it avoided objects that lay in its way*. In the same manner, it did not seem to be affected by sudden noises; but at night, when it slept with closed eyes and its head under its wing, it would raise its head in a remarkable manner, and open its eyes, on the slightest noise; speedily relapsing into a state of complete unconsciousness. Its principal occupation was to prune its feathers and scratch itself.—The condition of such a being seems to resemble that of a Man, who is in a slumber sufficiently deep to lose all distinct *perception* of external objects, but who is yet conscious of *sensations*, as appears from the movements occasioned by light or by sounds, or from those which he executes to withdraw the body from an uneasy position.*

436. Among the ganglia of special sensation, the functions of the Optic Lobes, or *Corpora Quadrigemina*, have been chiefly examined. The researches of Flourens and Hertwig have shown, that their connection with the visual function, which might be inferred from their anatomical relations, is substantiated by experiment. The partial loss of the ganglion on one side produces partial loss of power and temporary blindness on the opposite side of the body, without necessarily destroying the mobility of the pupil; but the removal of a larger portion, or complete extirpation of it, occasions permanent blindness and immobility of the pupil, with temporary muscular weakness, on the opposite side. This temporary disorder of the muscular system sometimes manifests itself (as already stated) in a tendency to move on the axis, as if the animal were giddy. No disturbance of consciousness appears to be produced; and Hertwig states that he never witnessed the convulsions, which Flourens mentions as a consequence of the operation, and which were probably occasioned by his incision having been carried too deeply. These results are confirmed by pathological phenomena in Man; for there are many instances on record, in which blindness has been one of the consequences of diseased alterations in one or both tubercles; and in some of the cases, in which the lesion extended to parts seated beneath the tubercles, disturbed movements were observed.—No definite conclusions can be drawn, either from experiment or from pathological observation, in regard to the functions of the Thalami Optici and Corpora Striata; but there is nothing in these sources of information to oppose the views already offered, which are based on other foundations.

437. *Emotional Actions*.—There appears strong reason for regarding the Ganglionic tract, which is the instrument of Consensual actions, as the immediate centre also of those movements which *directly* result from the excitement of the Emotions. Several considerations tend to establish this position.

* It must not be forgotten that, in such experiments, the severity of the operation will of itself occasion a suspension or disturbance of the functions of parts that remain; so that the loss of a power must not be at once inferred from the absence of its manifestations. But the *persistence* of a power, after the removal of a particular organ, is a clear proof that it cannot be the peculiar attribute of that organ.

In the first place, that the channel through which the direct impulses of the Emotions are conveyed to the Muscles, is not the same with that which conveys to them the mandates of the Will, appears sufficiently established by Pathological observation ; since cases of paralysis not unfrequently occur, in which the muscles are obedient to an emotional impulse, though the will exerts no power over them ; whilst, on the other hand, the will may have its due influence, and yet the emotional state cannot manifest itself. This is especially remarkable in the different forms of paralysis of the Facial nerve ; since the facial muscles manifest the ordinary influence of the Emotions, more evidently than any others. But it is not, however, confined to them ; thus, for example, the arm of a man, which no effort of his will could move, has been seen to be violently agitated at the sight of a friend. Dr. M. Hall has inferred from cases of this kind, that the Spinal system of nerves constitutes the channel of the Emotional actions ; but all which is proved by them is, that these are not effected through the same agency with the Volitional ; and the idea that they are of the same character with Reflex actions is distinctly negated by the fact, that in a great majority of instances, they are excited through the organs of *special* sense, and that *consciousness* is a distinct element in the series of changes which ends in their performance. These facts would lead us to infer, that the Emotional actions are dependent on a set of centres, intermediate between the Cerebrum and the Spinal Cord ; a position which is precisely that of the ganglionic tract under consideration.—In the next place it may be remarked, that the Emotions are so closely linked with Sensations, as to be regarded by many Metaphysicians as almost identical with them ; and this connection is universally recognized in the term *Feelings* popularly applied to both. Like the Instinctive tendencies of Animals, the Emotional states follow directly and necessarily upon Sensations, without any intervening process of ratiocination ; and there is such a marked correspondence in the character of the actions, which flow from these sources, as to point to the conclusion of the identity of the conditions on which they immediately depend. Of this, an example will be presently given. We have seen that the Sensory ganglia must necessarily be regarded as the instruments of the Instinctive actions ; and a probable inference may therefore be drawn from this fact, in regard to their relation to those which (in Man) are designated as Emotional.*—A third argument in support of this view may be drawn from the fact, of the very close connection of this division of the nervous centres, with the nervous trunks, through which the emotional states are excited, and the respondent muscular actions are stimulated. For the Sensory ganglia receive *all* those nerves, which communicate the Sensations through whose immediate agency the Emotion is excited ; and the nerves of the Orbit, the Face, and the Respiratory organs,—those most concerned in producing the movements, by which the emotions are expressed or manifested,—arise in their immediate proximity. It is chiefly through these nerves, too, that the

* It seems by no means certain, that we are always to attribute to the lower animals the Emotions which we ourselves feel, because they perform movements analogous to those by which we ordinarily express them : for the movements may be *directly* excited by the Sensations, without the intervention of the Emotion ; just as in ourselves, involuntary laughter is occasioned by tickling, although no ludicrous emotion be excited ; or as Vomiting results from the sight of a loathsome object, rather in response to the sensation of nausea, than to the emotion of disgust which it concurrently excites. We might, on equally valid grounds, assert, that the Bee goes through a process of mathematical ratiocination, before it commences the construction of its cell. The purpose of the Emotion, in animals possessed of Intelligence, may be rather to act upwards upon *it* ; and, although closely connected with the sensation which excites it ; it may be no more necessary to the resulting muscular movement, than sensation is to reflex action.—On this view, all actions of the *directly* Emotional character would be in reality purely Consensual.

abnormal movements are effected, in those disorders of the Nervous centres, which may be most distinctly referred to the Emotional system; such as Chorea and Hysteria.

438. The correspondence between the purely Emotional actions in Man, and those actions in the lower animals to which we give the name of Instinctive, may be made evident by a very simple illustration. The Cuttle-fish is well known to discharge its ink, when pursued, and to tinge the water around with a colour so deep, as to enable it to escape under the cloud thus formed. Now it is not to be supposed, that the Cuttle-fish has any notion of the *purpose* which this act will serve; since its constancy and uniformity, and the provision for its performance immediately on the emersion of the young animal from the egg, forbid our regarding it as the result of any act of reasoning. Further, the ink is an excretion which corresponds to the urine (having been found to contain urea); and every one knows how strong an impulse to discharge this, is frequently caused by mental emotion. The same may be said of the strongly odorous secretions possessed by many Mammalia, which are discharged under similar circumstances, and evidently with the same object: though of that object, the animal itself be not conscious. The *emotion* of fear involuntarily opens the sphincters, and causes the contraction of the receptacle, in one case as in the other; and the great difference between the condition of Man, and that of the lower animals, in this respect, is simply that, in the former, the purely Emotional or Instinctive actions are few in comparison with the whole, whilst in the latter they constitute by far the largest part; and also that Man has much greater power of controlling these actions by a voluntary effort, than that which the lower animals possess, although even he is not unfrequently compelled by the strength of his Emotions to act against his Will. Thus, we see or hear something ludicrous, which involuntarily produces laughter, although we may have the strongest motives for desiring to restrain it.

a. It is a very interesting question, how far actions at first performed voluntarily by Man, may by *habit* cease to require an effort of the Will; being prompted, like the movements of the Consensual class, by the direct impulse of sensations. Thus we all know that, in walking along an accustomed road, we frequently occupy our minds with some continuous train of thought, and yet our limbs continue to move under us with regularity, until we are surprised by finding ourselves at the place of our destination, or perhaps at some other which we had not intended to visit, but to which habit has conducted us. Or we may read aloud for a long time, without having in the least degree comprehended the meaning of the words we have uttered; our attention having been closely engaged by some engrossing thoughts or feelings within. Or a Musician may play a well-known piece of music, whilst carrying on an animated conversation;—the Author has known a skilful performer who could play *at sight* whilst thus occupied. Now in such a case it would be said by some Metaphysicians (acknowledging, as most do, that the mind cannot *will* two different things at the same time) that the Volition is in a sort of vibratory condition between the two sets of actions, now prompting one, and now the other. But it would seem much more conformable to the analogy afforded by other psychical phenomena, to refer the *habitual* series of actions to the same operation of the Nervous System with the Instinctive; and perhaps the term *Automatic* may be fairly applied to the whole of this group. It is well known that in cases of severe injury of the brain, in which Intelligence and Will seem completely in abeyance, habitual actions may be often excited. Thus, Dr. Perceval, in his Essay on habit, mentions the case of a snuff-taking Countess, in whom, when seized with apoplexy, irritation of the nose with a feather produced contraction of the fore-finger and thumb of the right hand; and Mr. Travers has recorded a similar fact in the case of a boy, who, when apparently insensible from depressed fracture of the skull, assisted in removing his clothes, preparatorily to the required operation.

439. The purely Emotional actions are not always directly excited, however, by *external* sensations; for they may result from the operations of the Mind itself. Thus involuntary laughter may result from a ludicrous idea, called up by some train of association, and having no obvious connection with the sen-

sation which first set this process in operation; and the various movements of the face and person, by which Actors endeavour to express strong Emotions, are only effectual in conveying their meaning, when they result from the actual working of the emotions in the mind of the performer, who has, by an effort of the will, identified himself (so to speak) with the character he personates. A still more remarkable case is that, in which paroxysms of Hysterical convulsion, in themselves beyond the power of the Will to excite or to control, are brought on by a voluntary effort; which seems to act by "getting up," so to speak, the state of feeling, which is the immediate cause of the disordered movements. In all these instances, and others of like nature, it would seem as if the agency of the Cerebrum produced the same condition in the Sensory ganglia and their motor fibres, as that which is more directly excited by sensations received through their own afferent nerves. It may be reasonably surmised, that the Sensory ganglia, like the Cephalic ganglia which are the instruments of the Instinctive actions of the lower animals, can only be excited to action by stimuli *immediately* operating upon them; but that these stimuli may be either Sensations directly originating in external objects, or Conceptions resulting from the remembrance of those objects, of which there is strong reason to believe that the Cerebrum is the storehouse.

440. The Emotions are concerned in Man, however, in many actions, which are in themselves strictly voluntary. Unless they be strongly excited, so as to get the better of the Will, they do not operate directly through the nervous trunks, but are subservient to the intellectual operations; to which they supply materials, or motives. Thus, of two individuals, with differently constituted minds, one shall judge of everything through the medium of a gloomy morose temper, which, like a darkened glass, represents to his judgment the whole world in league to injure him; and all his determinations, being based upon this erroneous view, exhibit the indications of it in his actions; which are themselves, nevertheless, of an entirely voluntary character. On the other hand, a person of a cheerful, benevolent disposition, looks at the world around as through a Claude Lorraine glass, seeing everything in its brightest and sunniest aspect; and, with intellectual faculties precisely similar to those of the former individual, he will come to opposite conclusions; because the materials, which form the basis of his judgment, are submitted to it in a very different condition. Various forms of Moral Insanity exhibit the same contrast in a yet more striking light. We not unfrequently meet with individuals, still holding their place in society, who are accustomed to act so much upon *feeling*, and to be so little guided by *reason*, as to be scarcely regarded as sane; and a very little exaggeration of such a tendency causes the actions to be so injurious to the individual himself, or to those around him, that restraint is required, although the intellect is in no way disordered, nor are any of the feelings perverted. Not unfrequently we may observe similar inconsistencies resulting from the habitual indulgence of one particular feeling, or a morbid exaggeration of it. The mother who, through weakness of will, yields to her instinctive fondness for her offspring, in allowing it gratifications which she knows to be injurious to it, is placing herself below the level of many less gifted beings. The habit of yielding to a natural infirmity of temper often leads into paroxysms of ungovernable rage, which, in their turn, pass into a state of maniacal excitement. It is not unfrequently seen, that a delusion of the *intellect* (constituting what is commonly known as Monomania) has in reality resulted from a disordered state of the *feelings*, which have represented every occurrence in a wrong light to the mind of the individual. All such conditions are of extreme interest, when compared with those which are met with amongst idiots, and animals enjoying a much lower degree of intelligence: for the result is much the same, in whatever way the balance between the

feelings and the judgment (which is so beautifully adjusted in the well-ordered mind of Man) is disturbed; whether by a diminution of the intelligence, or by an exaltation of the feelings.—These views will probably be found correct, whatever be the truth of the speculation with which they have been here connected, as to the part of the Nervous system concerned in the performance of the purely Emotional actions. That their channel is alike distinct, however, from that of the Voluntary movements, and from that of Reflex operations, must be apparent to any one who fairly weighs the evidence.

441. *Nerves connected with the Sensory Ganglia.*—That the First pair, or *Olfactory* nerves, minister to the sense of smell, has long been known, yet it could not be predicted without experimental inquiry, that it is *not* a conductor of the impressions which produce *ordinary* sensation: nor that it is destitute of all power of exciting muscular movement, either by direct or reflex action. Anatomical examination of the distribution of this nerve, proves that it is not one which directly conveys motor influence to any muscles; since all its branches are distributed to the membrane lining the nasal cavity. Experimental inquiry leads to the same result; for no irritation of the peduncles or branches excites any muscular movement. Further, no irritation of any part of this nerve excites reflex actions through other nerves. Again, it is not a nerve of common sensation; for animals exhibit no sign of pain, when it is subjected to any kind of irritation. Neither the division of the nerve, nor the destruction of the olfactive ganglia, seems to inconvenience them materially. They take their food, move with their accustomed agility, and exhibit the usual appetites of their kind. The common sensibility of the parts contained in the olfactive organ is in no degree impaired, as is shown by the effect of irritating vapours; but the animals are destitute of the sense of smell, as is shown by the way in which these vapours affect them. At first they appear indifferent to their presence, and then suddenly and vehemently avoid them, as soon as the Schneiderian membrane becomes irritated. Moreover, if two dogs, with the eyes bandaged, one having the olfactory nerves and ganglia sound, and the other having had them destroyed, are brought into the neighbourhood of the dead body of an animal, the former will examine it by its smell; whilst the latter, even if he touches it, pays no attention to it. This experiment Valentin states that he has repeated several times, and always with the same results. Further, common observation shows that sensibility to irritants, such as snuff, and acuteness of the power of smell, bear no constant proportion to one another; and there is ample pathological evidence, that the want of this sense is connected with some morbid condition of the olfactory nerves or ganglia.—It is well known that Magendie has maintained, that the Fifth pair in some way furnishes conditions requisite for the enjoyment of the sense of smell; asserting that, when it is cut, the animal is deprived of this. But his experiments were made with irritating vapours, which excite sternutation or other violent muscular actions, not through the Olfactory nerve, but through the Fifth pair; and the experiments of Valentin, just related, fully prove that the animals are not sensitive to *odours*, strictly so called, after the Olfactory has been divided. It is by no means improbable, however, that the acuteness of the true sense of smell may be diminished by section of the Fifth pair; since the olfactory membrane is no longer duly moistened by its proper secretion; and, when dry, it is not so susceptible of the impressions made by those minute particles of odoriferous substances, to which the excitement of the sensation must be referred.

442. That the Second pair, or *Optic* nerves, have an analogous character, appears alike from anatomical and experimental evidence. No chemical or mechanical stimulus of the nerve produces *direct* muscular motion; nor does it give rise, as far as can be ascertained, to indications of pain; whence it may

be concluded, that this nerve is not one of common sensation. That the ordinary sensibility of the eyeball remains, when the functions of the Optic nerve are completely destroyed, is well known; as is also the fact, that division of it puts an end to the power of vision. Valentin states that, although the Optic nerve may, like other nerves, be in appearance completely regenerated, he has never been able to obtain any evidence that the power of sight has been in the least degree recovered. He remarks that animals suddenly made blind exhibit great mental disturbance, and perform many unaccustomed movements; and that the complete absence of the power of vision is easily ascertained. Morbid changes are sometimes observed to take place in eyes, whose Optic nerve has been divided; but these are by no means so constant or so extensive, as when the Fifth pair is paralyzed; and they may not improbably be attributed to the injury, occasioned by the operation itself, to the parts within the orbit.—It is well known that, when amaurosis is produced by a morbid condition of the Optic nerve alone, the eye retains its usual appearance; but, if the amaurosis is complete, the texture of the Retina undergoes a remarkable change, ceasing to exhibit that peculiar structure which normally characterizes it. Neither primitive nervous fibrils, nor nucleated vesicles, can be distinguished in it, and the yellow spot of Soemmering becomes paler, and is at last undistinguishable. But if a very slight degree of sensibility to light remain, these changes are much less decided. Further, it is well known that, when the sight is destroyed by a disease or injury,

[Fig. 158.

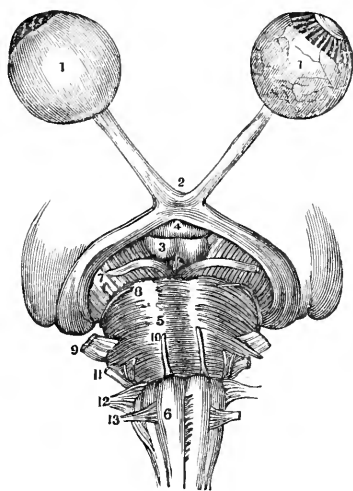

A view of the 2d pair or optic, and the origins of seven other pairs. 1, 1. Globe of the eye, the one on the left hand is perfect, but that on the right has the sclerotic and choroid removed to show the retina. 2. The chiasm of the optic nerves. 3. The corpora albicantia. 4. The infundibulum. 5. The Pons Varolii. 6. The medulla oblongata. The figure is on the right corpus pyramidale. 7. The 3d pair, motores oculi. 8. 4th pair, pathetici. 9. 5th pair, trigemini. 10. 6th pair, abducentes. 11. 7th pair, auditory and facial. 12. 8th pair, pneumogastric, spinal accessory, and glosso-pharyngeal. 13. 9th pair, hypoglossal.]

which prevents the passage of light through the pupil, the whole eye becomes more or less atrophied; and the Retina and Optic nerve, although previously sound, are found after death, (if the morbid condition have lasted sufficiently long) to have lost their characteristic structure. It seems evident, then, that the continuance of the functional operations of nerves, is a necessary condition of the maintenance of their normal organization; and we can very well understand that this should be the case, from the analogy of other parts of the system.

443. The Optic nerve, though analogous to the Olfactory in all the points hitherto mentioned, differs from it in one important respect;—that it has the power of conveying impressions which shall excite *reflex* muscular motions. This is especially the case in regard to the Iris, the ordinary actions of which are regulated by the degree of light impinging on the retina. When the optic nerve is divided, a contraction of the pupil takes place; but this does not occur, if the connection of this nerve with the third pair, through the nerv-

ous centres, be in any way interrupted. After such division (if complete), the state of the pupil is not affected by variations in the degree of light impinging on the retina; except in particular cases, in which it is influenced through other channels. Thus, in a patient suffering under amaurosis of one eye, the pupil of the affected eye is often found to vary in size, in accordance with that of the other eye; but this effect is produced by the action of light on the retina of the sound eye, which produces a motor change in the third pair on both sides. Further, as has been formerly stated (§ 395), the *impression* only of light upon the retina may give rise to contraction of the pupil, by reflex action, when the optic nerve is itself sound; whilst no *sensations* are received through the eye, in consequence of disease in the sensorial portion of the nervous centres. Although the contraction of the pupil is effected by the influence of motor fibres, which proceed to the sphincter of the Iris from the third pair of nerves, *through* the Ophthalmic ganglion, there is evidence that its dilatation depends rather upon the influence it derived from that ganglion itself, and from the Sympathetic system, of which it forms part.—Some have attempted to show, that the actions of the iris are in a slight degree voluntary, because, by an effort of the will, they could occasion contraction of the pupil; but this so-called voluntary contraction is always connected with a change in the place of the eyeball itself, occasioned by an action of some of its muscles. It is principally noticed under the two following conditions:—1. When an object is brought very near the eye, and we steadily fix our attention upon it, the axes of the two eyes are made to converge; and if this convergence be carried to a considerable extent, so that the pupils of both eyes are sensibly directed towards the inner canthus, a contraction of the pupil takes place. The final cause or purpose of this contraction is very evident. When an object is brought near the eye, the rays proceeding from it would enter the pupil (if it remained of its usual size) at an angle of divergence, so much greater than that which would allow them to be properly refracted to a focus, that indistinct vision would necessarily result. By the contraction of the pupil, however, the extreme or most divergent rays are cut off, and the pencil is reduced within the proper angle. The principle is precisely the same as that on which the optician applies a *stop* behind his lenses, which reduces their aperture in proportion to the shortness of their focal distance. 2. Contraction of the pupil is also noticed, when the eyeball is performing that rotation upwards and inwards, which, when performed along with violent respiratory actions, or during sleep, must be regarded as involuntary. This rotation also takes place, to a slight degree, when the eyelid is depressed, as in ordinary winking; and it is obvious that, in this manner, the surface of the eye is more effectually swept free from impurities which may have gathered upon it, than it would be by the downward motion of the lid alone. But the pupil is *not* contracted, when the eyeball is *voluntarily* rotated upwards and inwards.

444. Besides the contractions of the pupil, another action, which has been sometimes spoken of as reflex, is produced through the Optic nerve,—the contraction of the Orbicularis muscle under the influence of strong light, or when a foreign body is suddenly brought near the eye. But this cannot be produced by any mechanical stimulation, and it evidently involves *sensation*: in fact, it is a movement of a consensual kind, produced by the painful effect of light, which gives rise to the condition well characterized by the term *photophobia*. The involuntary character of it must be evident to every one, who has been engaged in the treatment of diseases of the eyes; and the effect of it is aided by a similarly-involuntary movement of the eyeball itself, which is rotated upwards and inwards, to a greater extent than the Will appears able to effect.

445. There is a further peculiarity, of a very marked kind, attending the course of the Optic nerves; this is the crossing or decussation which they

[Fig. 159.]

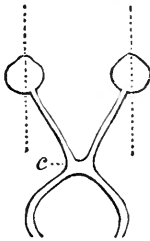

Plan of the optic nerves on a small scale, showing their divergence from the chiasma, *c*, and their junction with the globe, on the inner side of the axis of the humors.]

[Fig. 160.]

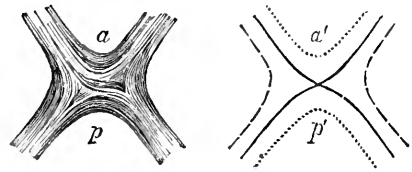

Course of fibres in the chiasma, as exhibited by tearing off the superficial bundles from a specimen hardened in spirit. *a*. Anterior fibres, commissural between the two retinae. *p*. Posterior fibres, commissural between the thalami. *a'*, *p'*. Diagram of the preceding.]

undergo, more or less completely, whilst proceeding from their ganglia to the eyes. In some of the lower animals, in which the two eyes (from their lateral position) have entirely different spheres of vision, the decussation is complete; the whole of the fibres from the right optic ganglion passing into the left eye, and *vice versá*. This is the case, for example, with most of the Osseous Fishes (as the cod, halibut, &c.); and also, in great part at least, with Birds. In the Human subject, however, and in animals which, like him, have the two eyes looking in the same direction, the decussation seems less complete; but there is a very remarkable arrangement of the fibres, which seems destined to bring the two eyes into peculiarly consentaneous action. The *posterior* border of the Optic Chiasma is formed exclusively of *commissural* fibres, which pass from one *optic ganglion* to the other, without entering the real optic nerve. Again, the *anterior* border of the Chiasma is composed of fibres, which seem, in like manner, to act as a commissure between the two *retinae*; passing from one to the other, without any connection with the optic ganglia. The tract which lies between the two borders, and occupies the *middle* of the Chiasma, is the true Optic Nerve; and in this it would appear that a portion of the fibres decussates, whilst another portion passes directly from each Optic ganglion into the corresponding eye. The fibres which proceed from the ganglia to the retina, and constitute the proper Optic Nerves, may be distinguished into an internal and an external tract. Of these, the *external* on each side, passes directly onwards to the eye of *that* side; whilst the *internal* crosses over to the eye of the *opposite* side. The distribution of these two sets of fibres in the retina of each eye respectively, is such that, according to Mr. Mayo, the fibres from either optic ganglion will be distributed to *its own side* of both eyes; the right optic ganglion being thus exclusively connected with the outer part of the retina of the right eye, and with the inner part of the retina of the left eye; and the left optic ganglion being, in like manner, connected exclusively with the outer side of the left retina, and with the inner side of the right. Now as either side of the eye receives the images of objects, which are on the other side of its axis, it follows, if this account of their distribution be correct, that in Man, as in the lower animals, each ganglion receives the sensations of objects situated on the *opposite* sides of the body. The purpose of this decussation may be, to bring the visual impressions, which are so important in directing the movements of the body, into proper harmony with the

apparatus; so that, the decussation of the motor fibres in the pyramids being accompanied by a decussation of the optic nerves, the same effect is produced as if neither decussated,—which last is the case with Invertebrated animals in general.

446. The functions of the *Auditory* nerve, or *Portio Mollis* of the Seventh, are easily determined, by anatomical examination of its distribution, and by observation of pathological phenomena, to be analogous to those of the two preceding. Atrophy or lesion of the trunk destroys the sense of Hearing; whilst irritation of it produces auditory sensations, but does not occasion pain.

From experiments made upon the nerve before it leaves the cranial cavity, it appears satisfactorily ascertained, that this nerve is not endowed either with common sensibility, or with the power of directly stimulating muscular movement. Nor can any obvious reflex actions be executed by irritation of this nerve; but it seems nevertheless by no means improbable, that the muscles which regulate the tension of the tympanum, are called into action by impressions made upon it and reflected through the auditory ganglion, in the same manner as the diameter of the pupil is regulated through the Optic nerve. —It has been attempted by Flourens to show, that the division of the Auditory nerve, which proceeds to the Semi-circular canals, has functions altogether different from that portion which supplies the Vestibule and Cochlea. This inference, however, is grounded only upon the movements exhibited by animals, in which these nerves are irritated; which movements are capable of a different explanation (§ 432).

[Fig. 161.

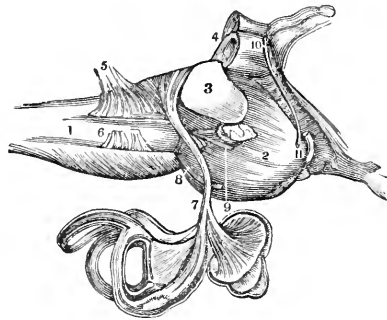

A view of the origin and distribution of the Portio Mollis of the Seventh pair or Auditory Nerve: 1, the medulla oblongata; 2, the pons Varolii; 3, 4, the crura cerebelli of the right side; 5, the eighth pair of nerves; 6, the ninth pair; 7, the auditory nerve distributed to the cochlea and labyrinth; 8, the sixth pair of nerves; 9, the portio dura of the seventh pair; 10, the fourth pair; 11, the fifth pair.]

a. It is interesting to remark, that microscopic examination of the structure of the Auditory nerve clearly indicates its intermediate character between the nerves of special sensation issuing from the anterior part of the cranium (namely, the Optic and Olfactory), and those whose function is to minister, either to common sensation, or to that of Taste, which approaches nearly to it, (namely, the Fifth pair and the Glosso-pharyngeal,) which issue from the posterior part of the Encephalon, and are more nearly analogous to the Spinal nerves. The primitive fibres are not so soft as those of the Olfactive, nor so slender as those of the Optic; and they are softer than those of the Glosso-pharyngeal. Moreover, the Auditory nerve forms a plexus with the Facial, to which there is no analogy in the Optic and Olfactive nerves, but to which a similar one exists in the Glosso-pharyngeal. This intermediate structural character is interesting, when we compare it with the intermediate character of the function: for the impressions made upon the sense of Hearing are produced through vibrations of a material fluid,—instead of being, as in the case of Sight, the result of changes so subtle as to be almost inscrutable to our means of research,—or, as in the case of Taste and Touch, being produced by the direct contact of the substance which gives rise to the sensation.

447. The nerves which minister to the sense of *Taste*, as already mentioned, are destitute of the peculiarities which distinguish the preceding; being no other than certain branches of ordinary afferent nerves,—the Fifth Pair and Glosso-pharyngeal,—the peculiar endowments of which seem to

depend rather upon the structure and actions of the papillæ at their peripheral extremities, than upon anything special in their own characters.—From the recent observations and experiments of M. Ch. Bernard, it appears that the Facial nerve (Portio Dura of the 7th) supplies some condition requisite for the sense of Taste, through the branch known as the Chorda Tympani, which is the motor-nerve of the Lingualis muscle. When paralysis of the Facial exists in Man, the sense of taste is very much impaired on the corresponding side of the tongue, provided the cause of the paralysis be seated above the origin of the Chorda Tympani from its trunk. Similar results have been obtained from experiments upon other animals. The nature of the influence afforded by this nerve is entirely unknown; and it is the more obscure, as the Chorda Tympani contains no sensory filament.

448. To the sense of *Touch*, all the afferent nerves of the body (save the nerves of special sense) appear to minister; in virtue—according to the hypothesis here upheld—of the direct connection of certain of their fibrils with the *Sensorium commune*. But the degree in which they are capable of producing Sensations, does not bear any constant relation to their power of exciting Reflex actions. Thus, the Glosso-pharyngeal is not nearly so *sensitive* as the Fifth pair; though more powerful as an *excitor* nerve. The Par Vagum appears to have even less power of arousing sensory changes; although it is the most important of all the excitors to reflex action. So again, the afferent nerves of the inferior extremities, in Man, are less concerned in ministering to sensations, than are those of the superior; and yet they appear to be much more efficient as excitors to muscular action.—These differences may be accounted for, by supposing that the proportion which the fibres, having their centre in the ganglionic matter of the Spinal Cord, bear to that of the fibres which pass on to the Sensorium, is not constant, but is liable to variation; the former predominating in the Par Vagum and the Glosso-pharyngeal; whilst the latter are more numerous in the Fifth Pair, and in most of the Spinal nerves.

449. It appears, from what has been already stated, that all the *motor* fibres of the Cerebro-spinal system, not exclusively concerned in Reflex movements, must be in connection with the Sensory ganglia; since we find that their actions, whether simply consensual, emotional, or volitional, are dependent upon *guiding sensations*. Of these sensations, the greater proportion are received from the muscles themselves; but there are certain cases, as we have seen, in which the guiding influence is communicated rather by the organs and nerves of Special sense. Of these, a good example is afforded by the movements of the Eyeball, presently to be examined in detail; and another is to be found in those of the Larynx, to be fully treated of hereafter (Chap. viii.). The Emotions, in like manner, may operate upon all the motor nerves of the body; as we see in the violent movements of unrestrained passion, or in the increased power given to voluntary efforts, by the simultaneous excitement of certain emotional states. But, as already remarked, their ordinary action is most displayed through the motor nerves of the face and respiratory organs.

450. *Consensual Movements of the Eye*.—It will be recollected that, in the Human Orbit, six muscles for the movements of the eyeball are found,—the four recti, and the two oblique muscles. The precise actions of these are not easily established by experiment on the lower animals; for in all those which ordinarily maintain the horizontal position, there is an additional muscle, termed the *retractor*, which embraces the whole posterior portion of the globe, and passes backwards to be attached to the bottom of the orbit. This muscle is most developed in Ruminating animals, which, during their whole time of feeding, carry their heads in a dependent position. In most Carni-

vorous animals, instead of the complete hollow muscular cone (the base inclosing the eyeball, whilst the apex surrounds the optic nerve) which we find in the Ruminants, there are four distinct strips, almost resembling a second set of recti muscles, but deep-seated, and inserted into the posterior instead of the anterior portion of the globe. It is obvious that the actions of these must greatly affect the results of any operation, which we may perform upon the other muscles of the Orbit; and, as it is impossible to divide the former, without completely separating the eye from its attachments, we have no means of correcting such results, but by reasoning alone. Experiments upon animals of the order of *Quadrumana*, most nearly allied to Man, would be more satisfactory; as in them, the retractor muscle is almost or entirely absent.—If the origin and insertion of the four *Recti* muscles be examined, however, no doubt can remain that each of them, acting singly, is capable of causing the globe to revolve in its own direction,—the superior rectus causing the pupil to turn upwards,—the internal rectus causing it to roll towards the nose,—and so on. A very easy and direct application of the laws of mechanics will further make it evident to us, that the combined action of any two of the *Recti* muscles will cause the pupil to turn in a direction intermediate between the lines of their single action; and that *any* intermediate position may thus be given to the eyeball by these muscles alone. This fact, which has not received the attention it deserves, leads us to perceive, that the *Oblique* muscles must have some supplementary function. It may be objected that this is a theoretical statement only; and that there may be some practical obstacle to the performance of diagonal movements by the *Recti* muscles, which renders the assistance of the *Obliques* essential for this purpose. But to this it may be replied, that *no single* muscle can direct the ball either downwards and inwards, or upwards and outwards; and that, as we have good reason to believe *these* movements to be effected by the combination of the *Recti* muscles, there is no reason why the other diagonal movements should not also be due to them.

451. The most probable account of the functions of the *Oblique* muscles of the eye, seems to be that which was long ago suggested by John Hunter, and which has received confirmation from the recent experiments of Dr. G. Johnson.*—It has been just shown that the action of the *Recti* muscles upon the pupil, is such as to cause it to *revolve* in any given direction; and they are put in action, not merely to alter the range of vision, the head remaining stationary, but also to keep the range of vision the same, and to cause the images of the objects, upon which our gaze is fixed, still to fall upon the same parts of the retina, by maintaining the position of the eyes when the head is moved upwards, downwards, from side to side, or in any intermediate direction. But these muscles are not able to *rotate* the eyeball upon its antero-posterior axis; and such rotation is manifestly necessary to preserve the fixed position of the eyeball, and consequently to keep the image of the object under survey upon the same part of the retina, when the head is inclined sideways, or bowed towards one shoulder and then towards the other. It appears from the experiments of Dr. G. Johnson, that the action of the *Oblique* muscles is exactly adapted to produce such a rotation; the *Inferior oblique*, in its contraction, causing the eyeball to move upon its antero-posterior axis, in such a manner that a piece of paper, placed at the outer margin of the cornea, passed downwards and then inwards towards the nose; and the *Superior oblique* effecting precisely the reverse action, the paper at the outer margin of the cornea passing first upwards and then inwards. There was not the slightest appearance, in these experiments, of elevation, depression, abduction, or ad-

* *Cyclopadia of Anatomy and Physiology*, vol. iii. p. 790.

duction, of the cornea, as a result of the action of the Oblique muscles; all these movements being attributable to the Recti alone.

452. On studying the conjoint movements of the Eyeball, we are led to observe the very curious fact, that they are not so much *symmetrical* as *harmonious*; that is to say, the corresponding muscles on the two sides are rarely in action at once; whilst such a harmony or *consent* exists between the actions of the muscles of the two orbits, that they work to one common purpose, namely, the direction of both eyes towards the required objects. In order to study them properly, it is necessary to reduce them to some kind of classification. We may divide them into the Voluntary and the Involuntary; and the former, being numerous, require to be further classified. They may be arranged under two groups; the first comprising those which are alike harmonious and symmetrical; the second including those which are harmonious but not symmetrical.—To the *first* group belong the following:—1. *Both* eyeballs are *elevated* by the contraction of the two Superior Recti.—2. *Both* eyeballs are *depressed* by the conjoint action of the Inferior Recti muscles.—3. *Both* are drawn directly *inwards*, or *inwards* and *downwards*, as when we look at an object placed on or near the nose; this movement is effected by the action of the Internal Recti of the two sides, with or without the Inferior Recti. It is evidently symmetrical, but might seem at first sight not to be harmonious, because the eyes do not move together towards one side or the other; it is, however, really harmonious, since their axes are directed towards the same point.—Now it is to be observed, with regard to these movements, that we can never effect them in antagonism with each other, or with those of other muscles. We cannot, for example, raise one eye and depress the other; nor can we raise or depress one eye, when we adduct or abduct the other. The explanation of this will be found in the fact, that we can never, by so doing, direct the eyes to the same point.—The harmonious but unsymmetrical movements, forming the *second* class, are those in which the Internal and External Recti of the two sides are made to act together, either alone, or in conjunction with the Superior and Inferior Recti. They are as follows.—4. *One* eye is made to revolve directly *inwards*, by the action of its Internal Rectus, whilst *the other* is turned *outwards* by the action of its External Rectus.—5. *One* eye is made to revolve *upwards* and *inwards*, by the conjoint action of the Internal and Superior Recti; *the other*, *upwards* and *outwards*, by the conjoint action of the External and Superior Recti.—6. *One* eye is made to revolve *downwards* and *inwards*, by the conjoint action of the Internal and Inferior Recti; *the other*, *downwards* and *outwards*, by the conjoint action of the External and Inferior Recti.—In these movements, *two different* muscles, the Abducens and Adducens, are called into action on the two sides; but they are so employed for the purpose of directing the axes of the eyes towards *the same* point.

453. The normal Involuntary movements of the eyeballs are only of two kinds.—1. The *rotation* of the two eyeballs on their own axes, which takes place when the head is moved in certain directions (§ 451); this is effected in direct response to certain guiding sensations, and without any influence or control on the part of the will; it is therefore a purely consensual action.—2. The revolution of *both* eyes *upwards* and *inwards*, which takes place in the acts of coughing, sneezing, winking, &c.; this is altogether independent of visual sensations, and is commonly, like the other movements associated in these actions, of a reflex nature.—Many abnormal movements of the eyeballs, in which there is neither harmony nor symmetry in the actions of the muscles, present themselves in convulsive diseases.

454. It may be stated as a physiological fact, that Single Vision with two eyes is dependent upon the formation of the image upon parts of the two

retinæ, which are *accustomed* thus to act with each other. In many physiological works it is asserted, that single vision is the result of the impressions being made on *corresponding* parts of the two retinæ,—that is to say, on parts equally distant from the axis, on one side or the other: but this seems to be disproved by the fact, that patients who have been long affected with Convergent Strabismus, and who see equally well with both eyes (as many do), are not troubled with double vision. On the other hand, when a person whose eyes look straight before him, is the subject of a disorder which renders their motions in any degree irregular, he is at once affected with double vision; and the same has been noticed to be a common immediate result of the successful operation for the cure of strabismus, where vision is good in both eyes. Although the images were previously formed on parts of the retinæ which were very far from corresponding with each other, yet no sooner is the position of the eyes rectified (so that the relation between the situation of the images is the same as it would have been in a sound eye), than the patient sees double. Now in these cases the difficulty very speedily diminishes, and the patient soon learns to see single. It can scarcely be imagined, then, that to any other cause than *habit*, is to be attributed the long-discussed phenomenon of single vision with two eyes. The mind receives the two images, frequently combining them together (as Mr. Wheatstone's ingenious experiments with the Stereoscope have most satisfactorily shown, § 547) to produce a picture in relief; and so long as these are conveyed to it in the accustomed manner, it reconciles them together, even if the parts of the retinæ on which they are formed do not correspond; but if any circumstance break this chain, and cause the images to be transmitted to the sensorium through a new channel, the mind requires some little time to adapt itself to this impression, as it does by habit to almost every other.

a. That there is a *greater* tendency to *consent* between the images, when they are formed upon corresponding parts of the retinæ, the Author readily admits; and he thinks that this is a principle of some importance, in explaining the re-adjustment of the eyes, after the operation for Strabismus. Every one who has seen much of this operation is aware, that the re-adjustment of the eye is not always immediate, but that, after the muscle has been freely divided, the eye often remains somewhat inverted for a few days, gradually acquiring its straight position. The Author has known one case, in which, after such a degree of temporary inversion as seemed to render the success of the operation very doubtful, eversion actually took place for a short time to a considerable extent; after which the axes became parallel, and have remained so ever since.

b. Another argument, derived from the results of this operation, in favour of the consensual movement being chiefly dependent upon the place of the impressions on the retina, is, that it is much more successful in those cases, in which the sight of the most displaced eye is good, than in those in which, (as not unfrequently happens from long disuse) it is much impaired. In cases of the latter class, the cure is seldom complete. There is another curious fact, which may be adverted to in reference to this subject: Strabismus not unfrequently arises from the formation of an opaque spot on the centre of the cornea, which prevents the formation of any images on the retina, except by the oblique rays; and nature seems to endeavour (so to speak) to repair the mischief, by causing the eye to assume the position most favourable for the reception of these.

c. To one more point only, connected with the subject of Strabismus, would the Author now allude. He is well convinced, from repeated observation, that those Surgeons are in the right, who have maintained, in a recent controversy, that, in a large proportion of cases, strabismus is caused by an affection of *both* sets of muscles or nerves, and not of one only; and that it then requires, for its perfect cure, the division of the corresponding muscle on both sides. Cases will be frequently met with, in which this is evident; the two eyes being employed to nearly the same extent, and the patient giving to both a slight inward direction, when desired to look straight forwards. In general, however, one eye usually looks straight forwards, whilst the other is greatly inverted; and the sight of the inverted eye is frequently affected to a considerable degree by disuse; so that, when the patient voluntarily rotates it into its proper axis, his vision with it is far from being distinct. Some Surgeons have maintained, that the inverted eye is usually the only one in fault, and consider that the division of the tendon of its Internal Rectus is sufficient for the cure. They

would even divide its other tendons, if the parallelism be not restored, rather than touch the other eye. The Author is himself satisfied, however, that the restriction of the abnormal state to a single eye, is the exception, and not the rule, in all but very slight cases of strabismus; and to this opinion he is led both by the consideration of the mode in which strabismus first takes place, and by the results of the operations which have come under his notice. If the eyes of an infant affected with cerebral disease be watched, there will frequently be observed in them very irregular movements; the axes of the two being sometimes extremely convergent, and then very divergent. This irregularity is rarely or never seen to be confined to one eye. Now, in a large proportion of cases of Strabismus, the malady is a consequence of some cerebral affection during infancy or childhood, which we can scarcely suppose to have affected one eye only. Again, in other instances we find the Strabismus to have resulted from the constant direction of the eyes to very near objects, as in short-sighted persons; and here, too, the cause manifestly affects both.

d. Now it is easy to understand, why one eye of the patient should *appear* to be in its natural position, whilst the other is greatly inverted. The cause of strabismus usually affects the two eyes somewhat unequally, so that one is much more inverted than the other. We will call the least inverted eye A, and the other B. In the ordinary acts of vision, the patient will make most use of the least inverted eye, A, because he can most readily look straight forwards or outwards with it; but to bring it into the axis, or to rotate it outwards, necessitates a still more decided inversion of B. This remains the position of things,—the patient usually looking straight forwards with A, which is the eye constantly employed for the purposes of vision,—and frequently almost burying under the inner canthus the other eye, B, the vision in which is of very little use to him. When, therefore, the tendon of the internal rectus of B is divided, the relative position of the two is not entirely rectified. Sometimes it appears to be so for a time; but the strabismus then begins to return, and it can only be checked by division of the tendon of the other eye, A; after which the cure is generally complete and permanent. That it has not been so, in many of the cases on which operations have been performed, the Author attributes, without the slightest doubt in his own mind, to the neglect of the second operation. As just now stated, the sight of the most inverted eye is frequently very imperfect; indeed it is sometimes impaired to such an extent, that the patients speak of it as entirely useless. That this impairment results in part from disuse merely, seems very evident, from the great improvement which often succeeds the rectification of the axes. The Author cannot help thinking it probable, however, that the same cause which produced the distortion of the eye may, in some instances at least, have affected the Optic nerve, as well as the Motor nerves of the orbit; and this idea is borne out by the fact of the restoration of sight, in certain cases of Amaurosis, by division of one or more tendons, where no Strabismus previously existed. (See Adams on Muscular Amaurosis.) It is interesting to remark that, in these cases, Strabismus was usually the first effect of the operation; but that the eye generally recovered its ordinary position within a short time, especially when the sight was improving.

455. If this be admitted, we gain an important step in the explanation of the Consensual movements of the Eye. The object to be attained is evidently this,—that the *usual* axes of the eye should always be directed towards the object to be viewed; and this, as we have seen, involves the necessity (in a great majority of cases), of *unsymmetrical* movements being performed by the two eyeballs. The combination of these movements is involuntary or automatic; and appears to be regulated by the sensations received through the retina. It is well known that, in children born blind, the movements are not consensual; they are frequently very far from being so, in cases of congenital cataract, where a considerable amount of light is evidently admitted, but where no distinct image can be formed; and in such cases, the movements are most consensual where the object is bright and luminous, and a more vivid impression therefore made upon the retina. It is no objection to this theory to say, that persons who have become blind may still move their eyes in a consensual manner; since, the habit of the association of particular movements having been once acquired, the guidance of the muscles may be effected by sensations derived from themselves, in the manner in which it takes place in the laryngeal movements of the deaf and dumb; and, as a matter of fact, a want of consent may be often noticed where the blindness is total. The peculiar vacant appearance, which may be noticed in the countenances of persons completely deprived of sight by amaurotic or other affections, which do

not alter the external aspect of the eyes, seems to result from this,—that their axes are *parallel*, as if the individual were looking into distant space, instead of presenting that slight convergence which must always exist between them, when the eyes are fixed upon a definite object. This convergence, which is of course regulated by the Internal Recti, varies in degree according to the distance of the object, and it is astonishing how minute an alteration in the axes of the eyes is perceptible to a person observing them. For instance, A sees the eyes of B directed towards his face, but he perceives that B is *not looking* at him; he knows this by a sort of intuitive interpretation of the fact, that his face is not the point of convergence of B's eyes. But if B, who might have been previously looking at something nearer or more remote than A's face, fix his gaze upon the latter, so that the degree of the convergence of the axes is altered, without the general direction of the eyes being in the least affected, the change is at once perceived by the person so regarded; and the *eyes* of the two then *meet*.

456. The foregoing considerations may be summed up in this simple statement:—that, when we voluntarily direct our eyes towards any object, the actions of the several muscles concerned, are guided by the *visual* sensations, rather than by the ordinary *muscular* sense, through which other voluntary movements are regulated. In this manner are accomplished, not merely the revolutions of the eyeballs from side to side, upwards and downwards, or in any direction that is required to cause the image to fall most advantageously upon the two retinae; but also that rotation on their axes, which keeps the images in the same position upon the retinae, when the head moves in a plane perpendicular to their axes; and likewise that exact convergence of the two axes which shall cause them to meet in the object on which the attention is fixed, and which consequently varies with its distance. Of all the movements of the eyes, there is none which exhibits the necessity of the guiding visual sensations so much as the revolution of *both eyes inwards*. Some persons can effect this voluntarily to a greater extent than others; but even then, they can only accomplish it by fixing the gaze upon some object situated between the eyes; and cannot call the adductor muscles into combined action in perfect darkness, or if the lids be closed. Even those who have the least power of effecting this extreme convergence, by at once directing the eyes towards a very near object, can accomplish it by looking at an object placed at a moderate distance, and gradually bringing this nearer to the nose, keeping the eyes steadily fixed upon it. The unwonted character of the movement is shown in this,—that it can only be maintained, even for a short time, by a strong effort, producing a sense of fatigue. No effort whatever can call into simultaneous action the two *external* Recti; and this fact is an additional proof of the necessity of a guiding visual sensation; since it is evident, that no object can ever be placed in such a position, as to require this action for the direction of the axes of the eyes towards it.

6. *Functions of the Cerebellum.*

457. That the Cerebellum has some special function, distinct from that of the Cerebral Hemispheres, can scarcely be doubted; since its peculiar structure and position, its independent connections with the Medulla Oblongata, and its extremely variable size relatively to the remainder of the Encephalon, point it out as an instrument adapted to some particular purpose. We shall inquire briefly into the nature of the evidence respecting its function, which is supplied to us by Comparative Anatomy, by Experiment, and by Pathological phenomena. A Cerebellum is found in all Vertebrated animals; although it is in some extremely small, looking like a little prominence on the Medulla

Oblongata. When this is the case, it is observed that the whole mass is not a miniature (so to speak) of the large Cerebellum of Man, but that the *central* portion (termed the vermiform process) is the part most developed; the *lobes* not presenting themselves until the organ has acquired an increased dimension. The following table, constructed from materials contained in M. Serres' most valuable Comparative Anatomy of the Brain, will afford some idea of the materials for speculating on the nature of the function of the Cerebellum, which we obtain from this source. The first column gives the diameter of the Spinal Cord, at the second cervical vertebra; in the two succeeding columns are stated the transverse and the antero-posterior diameters of the Cerebellum; these dimensions are stated in hundred-thousandths of a metre. The fourth column expresses, in round numbers, the proportion which the diameters of the Cerebellum bear to that of the Spinal Cord; the latter being reckoned as 1.

MAMMALIA.	Diam. of Spinal Cord at 2d Cervical Vertebra.	Transverse Diam. of Cerebellum.	Antero-posterior Diameter of Cerebellum.	Proportions.
Man . . .	1,100	12,000	6,000	11 — 5½
Simia Rubra .	900	4,500	2,443	5 — 2½
Bear . . .	1,300	5,900	3,500	4½ — 2½
Dog . . .	1,100	4,200	2,525	3¾ — 2¼
Dromedary .	1,900	7,100	4,600	3¾ — 2½
Kangaroo .	1,200	3,800	2,600	3⅙ — 2⅙
BIRDS.				
Falcon . . .	400	1,350	1,100	3⅓ — 2¾
Swallow . .	3,175	500	600	3 — 3½
Turkey . . .	500	1,350	1,600	2½ — 2⅙
Ostrich . . .	700	1,750	2,500	2⅙ — 3½
REPTILES.				
Crocodile .	300	500	400	1⅔ — 1½
Frog . . .	300	300	200	1 — ⅔
FISHES.				
Shark . . .	700	1,700	3,100	2½ — 4½
Cod . . .	575	1,350	1,700	2½ — 3
Turbot . . .	500	750	900	1½ — 1¼
Lamprey . .	275	225	100	⅘ — ⅘

458. This table affords us much scope for interesting speculation, and may be applied to the correction of hypotheses erected upon other foundations. Before we proceed to these, however, a few general remarks may be made upon it. In the first place, the proportional development of the Cerebellum is seen to be smallest in the Vermiform Fishes, which approach most nearly to the Invertebrata; but it is much greater in the higher Fishes than it is in Reptiles. If we consider in what particular, that may be reasonably supposed to have a connection with this organ, the former surpass the latter, we should at once be struck with their superiority in activity and *variety* of movement. Passing on to Birds, we remark that the average dimensions of the Cerebellum greatly surpass those of the organ in Reptiles; but that they do not exceed those occasionally met with in Fishes. The greatest size is not found in those

species which approach most nearly to the Mammalia in general conformation, such as the Ostrich; but in those of most active and varied powers of flight. Lastly, on ascending the scale of Mammiferous animals, we cannot but be struck with the rapid advance in the proportional size of the Cerebellum, that we observe, as we rise from the lowest, which are surpassed in this respect by many Birds, towards Man, in whom it attains a development which appears enormous, even when contrasted with that of the *Quadrumana*.

459. We have next to inquire what evidence can be drawn from Experimental investigations on the same subject: and in reference to this it is desirable to remark, in the first place, that the experimental mode of inquiry is perhaps more applicable to this organ than to other parts of the *Encephalon*; inasmuch as it can be altogether removed, with little disturbance of the actions immediately essential to life; and the animals soon recover from the shock of the operation, and seem but little affected, except in some easily-recognized particulars. The principal experimenters upon this subject have been *Rolando*, *Flourens*, *Magendie*, *Hertwig*, and *Longet*. It is not to be expected, that there should be an exact conformity among the results obtained by all. Every one who has been engaged in physiological experiments, is aware of the amount of difference caused by very minute variations in their circumstances; in no department of inquiry is this more the case than in regard to the *Nervous System*; and such differences are yet more likely to occur, in experiments made upon the *Nervous Centres*, than in those which concern their trunks.—The investigations of *Flourens* are the most clear and decisive in their results; and of these we shall accordingly take a general survey. He found that, when the *Cerebellum* was mechanically injured, the animals gave no signs of sensibility, nor were they affected with convulsions. When the *Cerebellum* was being removed by successive slices, the animals became restless, and their movements were irregular; and by the time that the last portion of the organ was cut away, the animals had entirely lost the powers of springing, flying, walking, standing, and preserving their equilibrium,—in short, of performing any combined muscular movements, which are not of a simply-reflex character. When an animal in this state was laid upon the back, it could not recover its former posture; but it fluttered its wings and did not lie in a state of stupor. When placed in the erect position, it staggered and fell like a drunken man,—not, however, without making efforts to maintain its balance. When threatened with a blow, it evidently saw it, and endeavoured to avoid it. It did not seem that the animal had in any degree lost voluntary power over its several muscles; nor did sensation appear to be impaired. The faculty of *combining* the actions of the muscles in groups, however, was completely destroyed; except so far as those actions (as that of respiration) were dependent only upon the Reflex function of the *Spinal Cord*. The experiments afforded the same results, when made upon each class of *Vertebrate animals*; and they have since been repeated, with corresponding effects, by *Bouillaud* and *Hertwig*. The latter agrees with *Flourens*, also, in stating that the removal of one side of the *Cerebellum* affects the movements of the opposite side of the body; and he further mentions that, if the mutilation of the *Cerebellum* have been partial only, its function is in great degree restored.

460. All these results are objected to by those who assert that the *Cerebellum* is the seat of the sexual instinct; on the ground that the observed aberrations of the motor functions are sufficiently accounted for, by the general disturbance which an operation so severe must necessarily induce. The fallacy of this objection, however, is shown by the fact, that the much more severe operation of removing the *Hemispheres* does not occasion such an aberration; the power of performing the associated movements, and of main-

taining the equilibrium, being remarkably preserved after the loss of them (§ 435).

461. Upon comparing these results with the preceding table, a remarkable correspondence will be observed between them. The classes which have the greatest variety of movements, and which require for them the most perfect combination of a large number of separate muscular actions, have, taken collectively, the largest Cerebellum. Of all classes of Vertebrata, Reptiles are the most inert; and their motions require the least co-ordination. The active predaceous Fishes far surpass them in this respect; and may be compared with Birds, in the energy of their passage through the water, and in their facility of changing their direction during the most rapid progression. The Cerebellum, accordingly, bears to the Spinal Cord in them, very much the same proportion as it does in Birds. On the other hand, the Flat Fish, which lie near the bottom of the ocean, and which have a much less variety of movement, have a very much smaller cerebellum: and the Vermiform Fishes, which are almost all completely destitute of fins, and whose progression is accomplished by flexion of the body, have a Cerebellum so small as to be scarcely discoverable: their motion being, like that of the Articulata, almost entirely of a reflex character,—each segment being influenced by its own ganglionic centre, and the Spinal Cord constituting by far the largest proportion of the nervous centres. On looking at the class of Birds, we observe that the active predaceous Falcons, and the Swift-winged Swallows (the perfect control possessed by which over their complicated movements must have been observed by every one), have a Cerebellum much larger in proportion than that of the Gallinaceous birds, whose powers of flight are small, or than that of the Struthious tribe, in which they are altogether absent. Lastly, on comparing its proportional size in the different orders of Mammalia, with the number and variety of muscular actions requiring combined movements, of which they are respectively capable, we observe an even more remarkable correspondence. In the hoofed Quadrupeds, in which the muscular apparatus of the extremities is reduced to its greatest simplicity, and in which the movements of progression are simple, the Cerebellum is relatively smaller than it is found to be in some Birds; but in proportion as the extremities acquire the power of prehension, and together with this a power of application to a great variety of purposes,—still more, in proportion as the animal becomes capable of maintaining the erect posture, in which a constant muscular exertion, consisting of a number of most elaborately-combined parts, is required,—do we find the size of the Cerebellum, and the complexity of its structure, undergoing a rapid increase. Thus, even between the Dog and the Bear there is a marked difference; the latter being capable of remaining for some time in the erect posture, and often spontaneously assuming it; whilst to the former it is anything but natural. In the semi-erect Apes, again, there is a very great advance in the proportional size of the Cerebellum; and those which most approach Man in the tendency to preserve habitually the erect posture, also come nearest to him in the dimensions of this organ.

462. Now it is evident that Man, although far inferior to many of the lower animals in the power of performing various particular kinds of movement, far surpasses them all, in the number and variety of the combinations which he is capable of executing, and in the complexity of the combinations themselves. Thus, if we attentively consider the act of *walking* in man, we shall find that there is scarcely a muscle of the trunk or extremities which is not actually concerned in it; some being engaged in performing the necessary movements, and others in maintaining the equilibrium of the body, which is disturbed by them. On the other hand, in the horse or Camel, the muscular movements are individually numerous, but they do not require nearly the same perfect

co-ordination. And in the Bird, the number of muscles employed in the movements of flight, and in directing the course of these, is really comparatively small; as may at once be perceived, by comparing the rigidity of the skeleton of the trunk of the Bird with that of Man, and by remembering the complete inactivity of the lower extremities during the active condition of the upper. In fact, the motions of the wings are so simple and regular, as to suggest the idea, that, as in Insects, their character is more reflex than directly voluntary:—an idea which is supported by the length of time during which they can be kept up without apparent fatigue, and also by the important facts already mentioned, which experimental research has disclosed (§ 435). It is seen, then, that Comparative Anatomy fully confirms the idea, which Experimental physiology suggests, respecting the chief functions of the Cerebellum.

463. Some of Magendie's experiments indicate a further connection of this organ with the motor function, the nature of which is still obscure. This physiologist asserts that, if a wound be inflicted on the Cerebellum, the animal seems compelled by an inward force to retrograde movement, although making an effort to advance; and that, if the Crus Cerebelli on one side be injured, the animal is caused to roll over towards the same side. Sometimes (if Magendie's statements can be relied on), the animals make sixty revolutions in a minute, and continued this movement for a week without cessation. Division of the second Crus Cerebelli restored the equilibrium. Hertwig observed the same phenomenon, when the Pons Varolii (which is nothing more than the commissure of the Cerebellum, surrounding the Crura Cerebri) was injured on one side; and he has also remarked, that the movements of the eyes were no longer consensual.

464. On turning to Pathology for evidence of the functions of the Cerebellum, we meet with much that seems contradictory. It must be remembered that a *sudden* effusion of blood, even to a small extent, in *any* part of the Encephalon, is liable to produce the phenomena of apoplexy or paralysis; and inferences founded upon the phenomena exhibited after sudden lesions of this description are, therefore, much less valid, than those based on the results of more chronic affections. In regard to these last, however, it is to be observed, that we are not yet in a condition to be able to state with precision, what amount of morbid alteration in any part of the nervous centres, is compatible with but slightly-disturbed performance of its function; and that cases are every now and then occurring, which would upset all our previous notions, if we were not aware, that the same difficulty presents itself, even in regard to the best-established results in Neurology. It is also to be remembered, that the results of disease, occasioning *pressure*, will be peculiarly liable to affect the Medulla oblongata, as well as the Cerebellum; and will thus occasion a greater loss of motor power than would be occasioned by the mere suspension of the function of the latter.

465. Pathological phenomena, when examined with these reservations, appear to coincide with the results of experiment, in supporting the conclusion, that the Cerebellum is not in any way the instrument of *psychical* operations. Inflammation of the membranes covering it, if confined to that part, does not produce delirium; and its almost complete destruction by gradual softening, does not appear necessarily to involve loss of intellectual power. "But," remarks Andral, "whilst the changes of intelligence were variable, inconstant, and of little importance, the lesions of motion, on the contrary, were observed in all the cases [of softening which had come under his notice] except one; and in this it is not quite certain that motion was not interfered with." In general, apoplexy of the Cerebellum is accompanied by paralysis; but this is by no means usual in cases of chronic disease, in which there is rather an irregularity of movement, with a degree of restlessness re-

sembling that described by Flourens as resulting from partial injury of this organ. In a few cases in which both lobes of the Cerebellum have been seriously affected, the tendency to retrograde movement has been observed; and instances are also on record, of the occurrence of rotatory movement, which has been found to be connected with lesion of the Crus Cerebelli on the same side. So far as they can be relied on, therefore, the results of the three methods of investigation bear a very close correspondence; and it can scarcely be doubted that they afford us some approximation to truth.

466. We have now to examine, however, another doctrine regarding the functions of the Cerebellum, which was propounded by Gall, and which is supported by the Phrenological school of physiologists. This doctrine—that the Cerebellum is the organ of the sexual instinct—is by no means incompatible with the other; and by some it has been held in combination with it. The greater number of Phrenologists, however, regard this instinct as the *exclusive* function of the Cerebellum; and assert that they can judge of its intensity, by the degree of development of the organ. We shall now examine the evidence in support of this position, afforded by the three methods of inquiry which have been already indicated. The results of fair observation as to the comparative size of the Cerebellum in different animals, can scarcely be regarded as otherwise than very unfavourable to the doctrine in question. In the greatest number of Fishes, it is well known that no sexual congress takes place; the seminal fluid being merely effused, like any other excretion, into the surrounding water; and being thus brought into accidental contact with the ova, of which a large proportion are never fertilized. But there are certain Fishes, as the Sharks, Rays and Eels, in which copulation takes place after the ordinary method. Now on contrasting these two groups, we find no corresponding difference in the size of the Cerebellum. It is true that this organ is of large size in the Sharks; but it is very small in the Rays; and almost rudimentary in the Eels:—in this respect bearing a precise correspondence with the variety and complexity of their movements. Further, in many ordinary Fishes, which do *not* copulate, such as the Cod, the Cerebellum is not only larger, but more complex in structure, than it is in the generality of Reptiles, in which the sexual instinct is commonly strong;—the whole spinal system of the Frog possessing, at the season of reproduction, an extraordinary degree of excitability, which is evidently destined to aid in the performance of the function (§ 401, *a*). Again, in comparing the Gallinaceous Birds, which are polygamous, with the Raptorial and Inessorial tribes which live in pairs, we find that the former, instead of having a larger cerebellum, have one of inferior size. Further on looking at the Mammalia, the same disproportion may be noticed. A friend who kept some Kangaroos in his garden, informed the Author that they were the most salacious animals he ever saw; yet their Cerebellum is one of the smallest to be found in the class. Every one knows, again, the salacity of Monkeys; there are many which are excited to violent demonstrations by the sight even of a human female; and there are few which do not practise masturbation, when kept in solitary confinement: yet in them the Cerebellum is much smaller than in Man, in whom the sexual impulse is much less violent. It has been supposed that the large size of the organ in Man is connected with his *constant* possession of the appetite, which is only *occasional* in others; but this does not hold good; since among domestic animals, there are many which are ready to breed throughout the year,—Cats and Rabbits for instance; and in these we do not find any peculiar difference in the size of the Cerebellum. It is asserted, however, that the results of observation in Man lead to a positive conclusion, that the size of the Cerebellum is a measure of the intensity of the sexual instinct in the individual. This assertion has been met by the counter-statement of others,—that no

such relation exists. It is unfortunate that here, as in many other instances, each party has registered the observations favourable to their own views, rather than those of an opposite character; so that until some additional evidence of a less partial nature has been collected, we must consider the question as *sub judice*. The Author is by no means disposed to deny that such a correspondence *may* exist; but on contrasting the degree of support which this part of phrenology really derives from pathological evidence, with that which the upholders of this view represent it to receive, he cannot but look with much distrust at all their observations on the subject.

467. It is stated in Phrenological works, as an ordinary result of disease of the Cerebellum, that there is an affection of the genital organs, manifesting itself in priapism, turgescence of the testes, and sometimes in seminal emissions. Now it is quite true that, in cases of apoplexy, in which these symptoms manifest themselves, there is very commonly found to be effusion upon the Cerebellum or in its substance; but it is to be remembered, that in all such lesions the Medulla Oblongata is involved, and these symptoms, equally with paralysis, may be due to affection of that organ.* Further, the converse does not by any means hold good; for the proportion of cases of disease of the Cerebellum, in which there is any manifest affection of the sexual organs, is really very small, being, according to the calculations of Burdach, not above *one in seventeen*. The same physiologist states that such affections do present themselves, although very rarely, when the Cerebrum is the seat of the lesion. A large number of facts adduced by Phrenologists in support of their views—such as the erections and emissions which often take place during hanging—may be explained as well, or even better, on the hypothesis that the Cerebro-spinal axis (that is, the Spinal cord with the Medulla Oblongata) is the seat of this instinct. And this hypothesis is much more conformable to the results of experiment and disease, than that which locates it in the Cerebellum. For it has been found that mechanical irritation of the Spinal Cord, and disease in its substance, much more frequently produce excitement of the genital organs, than do lesions of the Cerebellum. This view is entertained by Müller, and by most physiologists who have taken a comprehensive and unbiassed survey of the phenomena in question.

468. Among the arguments adduced by Gall and his followers in proof of the connection between the Cerebellum and the sexual instinct, is one which would deserve great attention, if the facts stated could be relied on. It has been asserted, over and over again, that the Cerebellum, in animals which have been castrated when young, is much smaller than in those which have retained their virility,—being, in fact, *atrophied* from want of power to act. Now, it is unfortunate that vague assertion, founded on estimates formed by the eye from the cranium alone, is all on which this position rests; and it will be presently shown, how very liable to error such an estimate must be. The following is the result of a series of observations on this subject, suggested by M. Leuret,† and carried into effect by M. Lassaigne:—The *weight* of the Cerebellum, both absolutely and as compared with that of the Cerebrum, was adopted as the standard of comparison. This was ascertained in ten Stallions, of the ages of from nine to seventeen years; in twelve Mares, aged

* A case has been recently communicated to the Author, in which the sexual desire, which had been always strong through life, but which had been controlled within the limits of decency, manifested itself, during a period of some months preceding death, in a most extraordinary degree: on *post-mortem* examination a tumour was found on the Pons Varolii. This fact harmonizes with the view given in the text (§ 470), that the sexual instinct, if connected with the Cerebellum at all, has its seat in the central lobe: but it also corresponds equally well with the idea, that the Medulla Oblongata is its centre.

† Anat. Comp. du Système Nerveux, tom. i., p. 427.

from seven to sixteen years; and in twenty-one Geldings, aged from seven to seventeen years. The average weight of the Cerebellum in the *Stallions* was 433 grammes; the greatest being 485 gr., and the least (which was in a horse of ten years old) being 350. The average weight of the Cerebellum was 61 gr.; the greatest being 65 gr., and the least 56 gr. The average proportion borne by the weight of the Cerebellum to that of the Cerebrum, was, therefore, 1 to 7·07; the highest (resulting from a very small Cerebrum) being 1 to 6·25; and the lowest (resulting from an unusually large Cerebrum) being 1 to 7·46. Throughout it might be observed, that the variation in the size of the Cerebellum was much less than in that of the Cerebrum.—In the twelve *Mares*, the average weight of the Cerebrum was 402 gr.; the highest being 432 gr., and the lowest 363 gr. That of the Cerebellum was 61 gr.; the highest being 66 gr., (which was in the individual with the smallest Cerebrum), and the lowest 58 gr. The average proportion of the weight of the Cerebellum to that of the Cerebrum was 1 to 6·59; the highest being 1 to 5·09, and the lowest 1 to 7. The proportion was, therefore, considerably higher in the perfect female, than in the perfect male.—In the twenty-one *Geldings*, the average weight of the Cerebrum was 419 gr.; the highest being 566 gr., and the lowest 346 gr. The average of the Cerebellum was 70 gr.; the highest being 76 gr., and the lowest 64 gr. The average proportion was, therefore, 1 to 5·97; the highest being 1 to 5·16, and the lowest 1 to 7·44. It is curious, that this last was in the individual which had the largest Cerebellum of the whole; but the proportional weight of the Cerebrum was still greater.

469. Bringing together the results of these observations, they are found to be quite opposed to the statement of Gall. The weight of the Cerebrum, reckoning the Cerebellum as 1, is thus expressed in each of the foregoing descriptions of animals:—

	Average.	Highest.	Lowest.
Stallions	7·07	7·46	6·25
Mares	6·59	7·00	5·09
Geldings	5·97	7·44	5·16

The average *proportional* size of the Cerebellum in Geldings, therefore, is so far from being *less* than that which it bears in entire Horses and Mares, that it is positively greater; and this depends not only on diminution in the relative size of the Cerebrum, but on its own larger dimension, as the following comparison of *absolute* weights will show:—

	Average.	Highest.	Lowest.
Stallions	61	65	56
Mares	61	66	58
Geldings	70	76	64

The difference is so remarkable, and appears, from examination of the individual results, to be so constant, that it cannot be attributed to any accidental circumstance, arising out of the small number of animals experimented on. The average weight of the Cerebellum in the ten Stallions and twelve Mares, is seen to be the same; and the extremes differ but little in the two; whilst the average in the Gelding is more than one-seventh higher, and the *lowest* is considerably above the *average* of the preceding, while the highest far exceeds the highest amongst the entire Horses. It is curious that Gall would have been much nearer the truth, if he had said that the dimensions of the *Cerebrum* are usually reduced by castration; for it appears from the following table that this is really the case:—

	Average.	Greatest.	Least.
Stallions	433	485	350
Mares	402	432	336
Geldings	419	566	346

The weight of the largest Cerebrum of the Gelding is far above the highest of the Stallions; but it seems to be an extraordinary case, as in no other was the weight above 490 gr. If this one be excluded, the *average* will be reduced still further, being then about 412; this may be seen, by looking over the whole table, to give a very fair idea of the usual weight in these animals, which is therefore *less*, by about one-twentieth, than the average of the Stallions.—The increased size of the Cerebellum in Geldings may perhaps be accounted for by remembering that this class of horses is solely employed for its muscular power, and that the constant exercise of the organ is not unlikely to develop its size; whilst Stallions, being kept especially for the purpose of propagation, are much less applied to occupations which call forth their motor faculties.

470. The Author is far from denying *in toto*, that any peculiar connection exists between the Cerebellum and the Genital system; but if the evidence at present adduced in support of the Phrenological position be held sufficient to establish it, in defiance of so many opposing considerations, we must bid adieu to all safe reasoning in Physiology. The weight of testimony appears to him to be quite decided, in regard to the connection of the Cerebellum with the regulation of the motor function. How far this invalidates the *moderate* phrenological view, which does not regard the function of the Cerebellum as *exclusively* devoted to the sexual instinct, is a question well deserving of attention. There is nothing opposed to such an idea in the results of the experiments already adverted to (§ 459); since there is no evidence that sexual instinct remained after the removal of the Cerebellum; but, on the other hand, there is no proof that it was destroyed. A circumstance which has been several times mentioned to him,—that great application to gymnastic exercises diminishes for a time the sexual vigour, and even totally suspends desire,—seems worthy of consideration in reference to such a view. If the Cerebellum be really connected with both kinds of functions, it does not seem unreasonable that the excessive employment of it upon one should diminish its energy in regard to the other. Further, it would seem by no means improbable, that the Lobes are specially connected with the regulation and co-ordination of movements; whilst the Vermiform processes, which are very large in many animals in which the former scarcely present themselves, are the parts connected with the sexual function. As an additional argument in favour of the former part of this view, it may be stated, that in Man the lobes bear a larger proportion to the Vermiform processes than in any other animal; and that they undergo their most rapid development during the first few years of life, when a large number of complex voluntary movements are being learned by experience, and are being associated by means of the muscular sensations accompanying them: whilst in those animals which have, immediately after birth, the power of regulating their voluntary movements for definite objects, with the greatest precision, the Cerebellum is more fully developed at the time of birth. In both instances it is well formed and in active operation (so far as can be judged of by the amount of circulation through it), long before the sexual instinct manifests itself in any perceptible degree.

7. Functions of the Cerebrum.

471. We come, in the last place, to consider the functions of that portion of the Nervous Centres, which is evidently, in Man, the predominant organ of his whole system; being not merely the instrument of his reasoning faculties, but also possessing a direct or indirect control over nearly all the actions of his corporeal frame, save those purely vegetative processes, which are most

completely isolated from his animal powers. We should be in great danger, however, of coming to an erroneous conclusion as to the real character of the Cerebrum and of its operations, if we confined ourselves to the study of the Human organism; and the history of Physiological science shows, that every advance of knowledge respecting its functions, has tended to *limit* them, whilst at the same time rendering them *more precise*. Thus the Brain (this term, in the older Anatomy, being chiefly appropriated to the Cerebrum) was accounted, not merely the centre of all motion and sensation, but also the source of all vitality; the different processes of nutrition, secretion, &c., being maintained, it was supposed, by a constant supply of "animal spirits," propagated from the brain, along the nerves, to each individual part. The more modern doctrine, that the Sympathetic System has for its special function to supply the nervous influence requisite for the maintenance of the functions of Organic life, was the first step in the process of limitation; still the Brain was regarded as the centre of all the Animal functions; and no other part was admitted to possess any power independently of it. By experiments and pathological observations, however, the powers of the Spinal Cord as an independent centre of action were next established; and it was thus shown, that there is a large class of motions, in which the Brain has no concern, and that the removal of the Cerebral hemispheres is not incompatible (even among the higher Vertebrata) with the prolonged maintenance of a sort of inert and scarcely conscious life. Still, it has been usually maintained, and with great show of reason, that the Cerebrum is the instrument of all *psychical* operations; and of *all* the movements which could not be assigned to the reflex action of the Spinal Cord. An attempt has been made, however, in the preceding pages, to show that this view is not altogether correct; and that there is a class of actions, neither reflex nor voluntary, but directly consequent upon Sensations and upon the instinctive and emotional propensities associated with these, which may be justly assigned to certain ganglionic centres, not less independent of the Cerebrum than is the Spinal Cord itself. It has been advanced, that the Cerebrum must be considered in the light of an organ *superadded* for a particular purpose or set of purposes, and not as one which is essential to life; that it has no representative among the Invertebrata (except in a few of the highest forms, which evidently present a transition towards the Vertebrated series); and that, at its first introduction, in the class of Fishes, it evidently performs a subordinate part in the general actions of the Nervous System. Hence, whatever be the function, or set of functions, we assign to the Cerebrum, we must keep in view the *special* character of the organ; and must never lose sight of the fact, that its predominance in Man does not deprive other parts of their independent powers, although it may keep the exercise of those powers in check, and may considerably modify their manifestations.

472. Before proceeding to inquire into the Physiology of the Cerebrum, we may advantageously take notice of some of the leading features of its structure.—In the first place, it forms an exception to the general plan, on which the elements of ganglionic centres are arranged; in having its vesicular substance on the *exterior*, instead of in the *central* part of the mass. The purpose of this is probably to allow the vesicular matter to be disposed in such a manner, as to present a very large *surface*, instead of being aggregated together in a more compact manner; and by this means, to admit the more ready access, on the one side, of the blood-vessels which are so essential to the functional operations of this tissue, as well as the more ready communication, on the other, with the vast number of fibres, by which its influence is to be propagated. There is no reason whatever to believe, that the functions

of the vesicular and fibrous substances are in the least altered by this change in their relative position ; indeed the results of observation upon the phenomena of disordered Cerebral action are such, as to afford decided confirmation to the idea already propounded,—that the action of the vesicular matter constitutes the source of nervous power ; whilst the fibrous structure has for its office, to conduct the influence generated in the preceding, towards the points at which it is to operate. The purpose of this arrangement is further evidenced by the fact, that, in all the higher forms of Cerebral structure, we find a provision for a still greater extension of the surface, at which the vesicular matter and the blood-vessels may come into relation ; this being effected, by the plication of the layer of vesicular matter into “convolutions,” into the sulci between which, the highly vascular membrane known as the *pia mater* dips down, sending multitudes of small vessels from its inner surface into the substance it invests.—In the fibrous or medullary substance of which the great mass of the Cerebrum is composed, three principal sets of fibres may be distinguished. These are,—*first*, the radiating fibres, which connect the vesicular matter of the cortical substance of the hemispheres with the Thalami Optici, and which, if our view of the function of the latter be correct, may be regarded as *ascending* or *sensory* ;—*second*, the radiating fibres, which connect the vesicular matter of the cortical substance of the hemispheres with the Corpora Striata, and which, on similar grounds, may be regarded as *descending* or *motor* ;—and *third*, the Commissural fibres, which establish the connection between the opposite hemispheres, and between the different parts of the vesicular substance of the same side, especially between that disposed on the surface of each hemisphere, and those isolated patches which are found in its interior. It is on the very large proportion which the Commissural fibres bear to the rest, that the bulk of the Cerebrum of Man and of the higher animals seems chiefly to depend ; and it is easy to conceive, that this condition has an important relation with the operations of the Mind, whatever be our view of the relative functions of different parts of the Cerebrum. It appears from the late researches of M. Baillarger, that the *surface* and the *bulk* of the cerebral hemispheres are so far from bearing any constant proportion to each other, in different animals, that, notwithstanding the depth of the convolutions in the Human Cerebrum, its bulk is $2\frac{1}{2}$ times as great in proportion to its surface, as it is in the Rabbit, the surface of whose Cerebrum is smooth. The entire surface of the Human Cerebrum, when the convolutions are unfolded, is estimated by him at about 670 square inches.*

473. With regard to the *Radiating* fibres, which connect the Corpora Striata and Thalami Optici with the vesicular surface of the Cerebral hemispheres, it must be admitted that no positive proof has yet been obtained of their direct continuity with those, which enter into the composition of the nerves proceeding from the Spinal Cord and Medulla Oblongata ; and however probable such a continuity may be regarded on some grounds, there are certain phenomena, which may perhaps be better explained on the idea, that these radiating fibres are of a *commissural* nature only, serving to connect the vesicular matter of the Cerebrum with that of the different portions of the *Cranio-Spinal Axis* (under which term are included the Spinal Cord, the Medulla

* The inference drawn by M. Baillarger from the facts he has collected,—namely, that the proportional surface of vesicular matter in different animals, whether considered absolutely, or relatively to the volume of the Cerebrum, has no correspondence with their intellectual capability,—is far too sweeping an assumption ; since, as above shown, the increase in the commissural fibres, causing an augmentation of the bulk of the Cerebrum, may be alike the cause of increased intelligence and of a diminished proportional amount of vesicular matter ; though the latter still remains as the original source of power.

Oblongata, and the chain of Sensory Ganglia at the summit of the latter), and thus brought, through the medium of the latter, into relation with the central terminations of the afferent nerves, and the origins of the motor. On this view, the Cerebrum would receive all its sensory impressions, by the commissural fibres that connect it with the ganglia, which are the real centres of these nerves; whilst it would call the motor trunks into action, by exciting, through another set of commissural fibres, the vesicular matter of the ganglionic centres from which they pass forth.*—This question cannot be determined until it shall have been shown, whether there is, or is not, a direct continuity between any of the fibres of the trunks connected with the Cranio-Spinal Axis, and any of the radiating fibres of the Cerebral hemispheres. But the latter view is certainly favoured by the very remarkable fact, in which the results of all experiments agree, that no irritation or injury of the Cerebral fibres themselves, produces either sensation or motion. Even the Thalami and Corpora Striata may be wounded, without the excitement of convulsive actions; but if the incisions involve the Tubercula Quadrigenina or the Medulla Oblongata, convulsions uniformly occur. These results are borne out by pathological observations in Man; for it has been frequently remarked, when it has been necessary to separate protruded portions of the Brain from the healthy part, that this has given rise to no sensation, even in cases in which the mind has been perfectly clear at the time.

474. The *Commissural* fibres constitute two principal groups, the *transverse*, and the *longitudinal*; the former connecting the two Hemispheres with each other; the latter uniting the different parts of the same Hemisphere.—Of the transverse commissures, the *Corpus Callosum* is the most important. This consists of a mass of fibres very closely interlaced together; which may be traced into the substance of the hemispheres on each side, particularly at their lower part, where their connections are the closest with the Thalami Optici and Corpora Striata. It is difficult, if not impossible, to trace its fibres any further; but there can be little doubt that they radiate, with the fibres proceeding from the bodies just named, to different parts of the cortical substance of the Hemispheres. This commissure is altogether wanting in Fish, Reptiles, and Birds; and it is partially or completely wanting in those Mammals, whose Cerebrum is formed upon the least complex plan—the Rodents and Marsupials. The *anterior* commissure particularly unites the Corpora Striata of the two sides: but many of its fibres pass through those organs, and radiate towards the convolutions of the Hemispheres, especially those of the middle lobe. This commissure is particularly large in those Marsupials, in which the Corpus Callosum is deficient. The *posterior* commissure is a band of fibres which connects together the Thalami optici; crossing over from the posterior extremity of one to that of the other. Besides these, there are other groups of fibres, which appear to have similar commissural functions, but which are intermingled with vesicular substance. Such are the *soft* commissure, which also extends between the Thalami; the *Pons Varoli*, which extends between the Crura Cerebri; and the *Tuber Cinereum*, which seems to unite the optic tracts with the thalami, the corpus callosum, the fornix, &c., and to be a common point of meeting for several distinct groups of fibres.—Of the *longitudinal* commissures, some lie above, and others below, the Corpus Callosum. Upon the transverse fibres of that body, there is a longitudinal tract on each side of the median line, which serves to connect

* See Messrs. Todd and Bowman's Physiological Anatomy, Chap. XI. for a fuller statement of this view, and of the arguments in its favour. See also the General Summary at the conclusion of the present Chapter.

the convolutions of the anterior and posterior Cerebral lobes. Above this, again, is the *superior longitudinal* commissure, which is formed by the fibrous matter of the great convolutions nearest the median plane on the upper surface of the Cerebrum, and which connects the convolutions of the anterior and middle lobes with those of the posterior. Beneath the Corpus Callosum, we find the most extensive of all the longitudinal commissures, the *Fornix*. This is connected in front with the *Thalami optici*, the *Corpora mammillaria*, the *tuber cinereum*, &c.; and behind it spreads its fibres over the hippocampi (major and minor), which are nothing else than peculiar convolutions that project into the posterior and descending cornua of the lateral ventricles. The fourth longitudinal commissure is the *Tænia semicircularis*, which forms part of the same system of fibres with the fornix; connecting the corpus mammillare and thalamus opticus of each side with the middle lobe of the cerebral hemisphere. If, as Dr. Todd has remarked,* we could take away the corpus callosum, the grey matter of the internal convolution, and the ventricular prominence of the optic thalami, then all these commissures would fall together, and would become united in the same series of longitudinal fibres.—Experiment does not throw any light upon the particular functions of the Corpus Callosum and other Commissures; since they can scarcely be divided without severe general injury. It would appear, however, that the partial or entire absence of these parts, reducing the Cerebrum (in this respect at least) to the level of that of the Marsupial Quadruped, or of the Bird, is by no means an unfrequent cause of deficient intellectual power.

a. The following case of deficient commissures, lately recorded by Mr. Paget, is of much interest. The middle portion of the Fornix, and the whole of the Septum Lucidum, were absent; and in place of the Corpus Callosum, there was only a thin fasciculated layer of fibrous matter, 1·4 inch in length, but of which the fibres extended to all the parts of the brain, into which the fibres of the healthy corpus callosum can be traced. The Middle commissure was very large; and the lateral parts of the Fornix, with the rest of the Brain, were quite healthy. The patient was a servant-girl, who died of pericarditis. She had displayed, during her life, nothing very remarkable in her mental condition, beyond a peculiar *want of forethought*, and *power of judging of the probable event of things*. Her memory was good; and she possessed as much ordinary knowledge as is commonly acquired by persons in her rank of life. She was of good moral character, trustworthy, and fully competent to all the duties of her station, though somewhat heedless; her temper was good, and disposition cheerful. The mental deficiencies in the few other cases of which the details have been recorded, seem to have been of the same order; and this is exactly what might have been anticipated; since the deprivation of these parts takes away that, which is most characteristic of the Cerebrum of Man and of the higher Mammalia; and their intellectual operations are peculiarly distinguished by that *application of past experience to the prediction of the future*, which constitutes the highest effort of Intelligence.

475. The weight of the entire Encephalon in the adult Male usually ranges between 46 and 53 ounces; and in the Female, from 41 to 47 ounces. The maximum of the healthy brain seems to be about 64 ounces, or *four pounds*; and the minimum about 31 oz., or something less than *two pounds*. But in cases of idiocy, the amount is sometimes much below this; as low a weight as 20 oz. having been recorded. It appears, from the recent investigations of M. Bourguery, that the relative sizes of the different component elements of the Human Encephalon are somewhat as follows. Dividing the whole into 204 parts, the weight of the Cerebrum will be represented by about 170 of those parts, that of the Cerebellum by 21, and that of the Medulla Oblongata with the Optic Thalami and Corpora Striata at 13. The weight of the Spinal Cord would be, on the same scale, 7 parts. Hence the Cerebral Hemispheres of Man include an amount of nervous matter, which is *four* times

* Anatomy of the Brain, Spinal Cord, &c., p. 234.

that of all the rest of the Cerebro-spinal mass, more than *eight* times that of the Cerebellum, *thirteen* times that of the Medulla Oblongata, &c., and *twenty-four* times that of the Spinal Cord.—The average weight of the whole Encephalon, in proportion to that of the body, in Man, taking the average of a great number of observations, is about 1 to 36. This is a much larger proportion than that which obtains in most other animals; thus the average of Mammalia is stated by M. Leuret to be 1 to 186, that of Birds 1 to 212, that of Reptiles 1 to 1321, and that of Fishes 1 to 5668. It is interesting to remark, in reference to these estimates, that the Encephalic prolongation of the Medulla Oblongata in Man (being about one-sixteenth of the weight of the whole Encephalon) is *alone* more than twice as heavy in proportion to his body, as the *entire* Encephalon of Reptiles, and ten times as heavy as that of Fish.—But there are some animals in which the weight of the Encephalon bears a higher proportion to that of the body than it does in Man; thus in the Blue-headed Tit, the proportion is as 1 to 12, in the Goldfinch as 1 to 24, and in the Field-Mouse as 1 to 31. It does not hence follow, however, that the *Cerebrum* is larger in proportion; in fact, it is probably not nearly so large; for in Birds and Rodentia, the sensory ganglia form a very considerable proportion of the entire Encephalon. The importance of distinguishing between the several parts of this mass, which are marked out as distinct, alike by their structure and connections, as by the history of their development, has not been by any means sufficiently attended to.

476. The Encephalon altogether receives a supply of Blood, the amount of which is very remarkable, when its comparative bulk is considered; the proportion which it receives being, according to the estimate of Haller, as much as one-fifth of the whole. The manner in which this blood is conveyed to the Brain, and the conditions of its distribution, offer some peculiarities worthy of notice. The two Vertebral and two Carotid arteries, by which the blood enters the cavity of the cranium, have a more free communication by anastomosis, than any similar set of arteries elsewhere; and this is obviously destined to prevent an obstruction in one trunk from interrupting the supply of blood to the parts, through which its branches are chiefly distributed,—the cessation of the circulation through the nervous matter being immediately productive (as formerly shown, § 290) of suspension of its functional activity.—Not only must there be a sufficient supply of blood, but it must make a regulated pressure on the walls of the vessels. Now the Encephalon is differently circumstanced from other vascular organs, in being inclosed within an unyielding bony case; and it has been supposed that the total amount of blood circulating through it must consequently be invariable, any disturbance of the circulation being due to an undue turgidity of the arteries and corresponding emptiness of the veins, or *vice versâ*. But this is by no means the case; for, independently of the fact that varying states of functional activity will doubtless produce a considerable variation in the entire bulk of the nervous mass, we find a special provision for equalizing the bulk of the contents of the cranial cavity, and for counterbalancing the results of differences in the functional activity of the brain and in its supply of blood. This is the existence of a fluid, which is found beneath the arachnoid, wherever pia mater exists in connection with the brain and spinal cord; whether on the surfaces of these organs, or in the ventricles of the latter. The amount of this fluid seems to average about two ounces; but in cases of atrophy of the brain, as much as twelve ounces of fluid may sometimes be obtained from the cranio-spinal cavity; whilst in all instances, in which the bulk of the brain has undergone an increase, whether from the production of additional nervous tissue, or from undue turgescence of the vessels, there is

either a diminution or a total absence of this fluid. It appears from the experiments of Magendie (to whom our knowledge of the importance of this fluid is chiefly due), that its withdrawal in living animals causes great disturbance of the cerebral functions, probably by allowing undue distention of the blood-vessels; it is, however, capable of being very rapidly regenerated; and its reproduction restores the nervous centres to their natural state.

477. As the cerebro-spinal fluid can readily find its way from the sub-arachnoid spaces of the *cranial* cavity into those of the *spinal*, and as the latter are distensible, to a very considerable extent, it evidently serves as an equalizer of the amount of pressure within the cranial cavity; admitting the distention or contraction of the vessels to take place, within certain limits, without any considerable change in the degree of compression to which the nervous matter is subjected. That this uniformity is of the greatest importance to the functional exercise of the brain, is evident from a few well-known facts. If an aperture be made in the skull, and the protruding portion of the brain be subjected to pressure, the immediate suspension of the activity of the whole organ is the result; in this manner, a state resembling profound sleep can be induced in a moment; and the normal activity is renewed as momentarily, as soon as the pressure is withdrawn. This phenomenon has often been observed in the Human subject, in cases in which a portion of the cranial envelope has been lost by disease or injury. The various symptoms of Cerebral disturbance, which are due to a state of general Plethora, are evidently owing to an *excess* of pressure within the vessels; but an undue diminution of pressure is no less injurious, as appears from the disturbance in the Cerebral functions, which results from the very opposite cause, namely, a depression of the power of the heart, or a deficiency of blood in the vessels.—It is of peculiar importance to bear in mind the disturbance of the Cerebral functions, which is occasioned by internal *pressure*, when we are endeavouring to draw inferences from the phenomena presented by disease.

478. We shall now proceed with our Physiological inquiry into the functions of the Cerebrum; confining ourselves, in the present Section, to certain general positions, with regard to which most Physiologists are agreed; and referring to the Appendix for a notice of the more detailed system of Cerebral Physiology, first propounded by Dr. Gall.—We shall, as before, apply to Comparative Anatomy, to Experiment, and to Pathology, for our chief data. Any general inferences, founded *only* upon observation of the phenomena presented by Man, must be looked upon with suspicion; since every advance in Comparative Physiology leads us to perceive, how close is the functional relation between organs, that are really of analogous nature in different classes of animals; and how necessary, therefore, it is, to examine and contrast all the facts which we can attain in regard to them, in order to impart to our conclusions the utmost validity of which they are capable.—Our first general proposition is, that the Cerebrum is the sole instrument of *intelligence*; by which term is implied the intentional adaptation of means to ends, in a manner implying a perception of the nature of both. The actions performed by the lower animals are often such, as to leave us in doubt, whether they are the result of a mere Instinctive impulse, or of an Intelligent adaptation of means to ends; and we are guided in our determinations, chiefly by the uniformity of these actions, in the several individuals of the same species. If we analyze any of our own instinctive actions, we shall perceive the same absence of design on our own parts, as that which we attribute to the lower animals. No one would assert that the tendency to sexual intercourse is the result of a knowledge of its consequences, and of a voluntary adaptation of means to ends; or that, if we can imagine a man newly coming into the

world in the full possession of all his powers, he would wait to eat when hungry, until experience had taught him that the swallowing of food would relieve the uneasy feeling. It has been already shown, that, in the infant, the act of sucking may be performed even without a Cerebrum (§ 386, c); and for this and other similar actions, therefore, it is doubtful whether consciousness is a requisite condition. Adult animals, whose Cerebral hemispheres have been removed, will eat food that is put into their mouths, although they will not go to seek it; and this is the case with many Human idiots. When the functions of the Brain are disturbed, or in partial abeyance, as in fever, we often see a remarkable return to the instinctive propensities in regard to food; and the Physician frequently derives important guidance as to the patient's diet and regimen (particularly as to the administration of wine), from the inclination or disinclination which he manifests.

479. The difference between actions of a purely Instinctive character, and those which rather result from the Intellectual faculties prompted by the instinctive propensities, is well seen in comparing Birds with Insects. Their Instinctive tendencies are of nearly the same kind; and the usual arts which they exhibit in the construction of their habitations, in procuring their food, and in escaping from danger, must be regarded as intuitive, on account of the uniformity with which they are practised by different individuals of the same species, and the perfection with which they are exercised on the very first occasion. But in the adaptation of their operations to peculiar circumstances, Birds display a variety and fertility of resource, far surpassing that which is manifested by Insects; and it is not doubted, by those who have attentively observed their habits, that in such adaptations they are often guided by real Intelligence. This must be the case, for example, when they make trial of several means, and select that one which best answers the purpose; or when they make an obvious improvement from year to year in the comforts of their dwelling; or when they are influenced in the choice of a situation, by peculiar circumstances, which, in a state of nature, can scarcely be supposed to affect them. The complete domesticability of many Birds is in itself a proof of their possessing a certain degree of intelligence; but this alone does not indicate the possession of more than a very low amount of it; since many of the most domesticable animals are of the humblest intellectual capacity, and seem to become attached to Man, principally as the source on which they depend for the supply of their animal wants. This is the case with most Herbivorous quadrupeds, and with Rabbits, Guinea-pigs, &c.; as well as with the Gallinaceous Birds.

480. The attachment which is formed to Man, by certain Mammalia of higher orders, such as the Dog, the Horse, and the Elephant, is evidently of a more elevated kind, and involves a much larger number of considerations. The *Intelligence* of such animals is peculiarly exhibited in their Educability;—that is, in the facility with which their natural habits may be changed by the new influences to which they are subjected, and the complication of the mental processes which they appear to perform under their altered circumstances. Their actions are evidently the result, in many instances, of a complex train of reasoning, differing in no essential respect from that which Man would perform in similar circumstances; so that the epithet, “half reasoning,” commonly applied to these animals, does not express the whole truth; for their mental processes are of the same *kind* with those of Man, and differ more in the *degree* of control which the animal possesses over them, than they do in their own character. We have no evidence, however, that any of the lower animals have a voluntary power of guiding, restraining, or accelerating their mental operations, at all similar to that which Man possesses; these

operations, indeed, seem to be of very much the same character as those which we perform in our dreams, different trains of thought commencing as they are suggested, and proceeding according to the usual laws, until some other disturb them. Although it is customary to regard the Dog and the Elephant as the most intelligent among the lower animals, it is not certain that we do so with justice; for it is very possible that we are misled by that peculiar attachment to Man, which in them must be termed an instinct, and which enters as a motive into a large proportion of their actions; and that, if we were more acquainted with the psychical characters of the higher Quadrumana, we should find in *them* a greater degree of mental capability than we now attribute to them. One thing is certain,—that, the higher the degree of intelligence which we find characteristic of a particular race,—the greater is the degree of variation which we meet with in the characters of individuals; thus every one knows that there are stupid Dogs and clever Dogs, ill-tempered Dogs and good-tempered Dogs,—as there are stupid Men and clever Men, ill-tempered Men or good-tempered Men. But no one could distinguish between a stupid Bee and a clever Bee, or between a good-tempered Wasp and an ill-tempered Wasp, simply because all *their* actions are prompted by an unvarying instinct.

481. It is important to bear in mind the view to which we have been conducted,—in regard to the relative offices of the vesicular and fibrous matter,—when forming our opinions upon the functions of the Cerebrum in general, or of its several parts; from the various data supplied to us by Comparative Anatomy, by the comparison of the Cerebra of different individuals of the Human race with each other and with their respective psychical manifestations, and by experimental and pathological inquiry. For in regard to the first of these sources it is to be remarked, that the *size* of the brain does not, considered alone, afford a means of judgment as to its *power*. The quantity of vesicular matter on its surface should rather be our guide; and this we may judge of, not only by the depth of the layer, but by the complexity of the convolutions by which the surface is extended. In no class, save in Mammalia, do we find the surface marked with convolutions; and in general we do not meet with that fissure between the hemispheres, which greatly increases the extent of surface. In forming comparisons as to the connection between the size of the Cerebrum, and the Intelligence, in different animals, we must not be at all guided by its simple proportional dimensions; since it is very evident, that it is rather the proportion of the bulk of the brain to that of the whole body, upon which we should found our comparison. But even this is not altogether a safe guide; and many Physiologists have endeavoured to compare the size of the brain, with the aggregate bulk of the nerves proceeding from it. This is a much fairer measure; but it cannot be taken without great difficulty. For all practical purposes, the comparison of the bulk of the Cerebrum with that of the Spinal Cord will probably answer very well. The following table, the materials of which are drawn from M. Serres' Comparative Anatomy of the Brain, exhibits the three diameters of the Cerebrum of a number of different animals, and the diameter of the Spinal Cord at the second cervical vertebra. The last three columns present in round numbers, the three diameters of the Cerebrum, reckoning that of the Spinal Cord as 1, for the sake of easy comparison.

	Diameter of Spinal Cord.	DIMENSIONS OF CEREBRUM.			Proportional Dimensions.		
		Anti-post.	Transv.	Vertical.			
Man	1,100	17,000	7,500	9,000	1—15½	1—6½	1—8½
Dolphin	1,100	9,500	5,850	8,200	1—9½	1—5½	1—8½
Mandril	950	8,100	3,200	4,900	1—8½	1—3½	1—5
Tiger	1,600	9,400	4,250	6,400	1—5¾	1—2½	1—4
Dromedary	1,900	10,500	5,050	5,800	1—5½	1—2	1—3
Ka-garoo	1,200	5,300	2,350	3,800	1—4½	1—2	1—3½
Vulture	800	3,200	2,200	1,550	1—4	1—2¾	1—2
Falcon	500	1,900	1,450	1,200	1—3½	1—3	1—2½
Swallow	175	1,000	600	550	1—5½	1—3½	1—3½
Pie	450	2,000	1,400	1,200	1—4½	1—3	1—2½
Turkey	500	1,750	1,250	1,200	1—3½	1—2½	1—2½
Parroquet	400	2,900	1,400	1,700	1—7¼	1—3½	1—4¼
Tortoise	300	1,600	500		1—5½	1—1½	
Crocodile	300	800	500		1—2½	1—1½	
Viper	200	600	300		1—2	1—1½	
Frog	300	500	400		1—1½	1—1½	
Shark	710	2,300	1,100		1—3½	1—1½	
Cod	575	725	800		1—1½	1—1½	
Lamprey	275	400	300		1—1½	1—1½	
Angler	400	400	300		1—1	1—¾	

482. As might be expected, the Cerebrum of Man bears by far the highest proportion; but this proportion is not so large in the transverse and vertical diameters, as in the antero-posterior; in fact, in the proportion of the vertical diameter the Cerebrum of Man is equalled by that of the Dolphin, and nearly so in that of the transverse diameter. In the complexity of the convolutions, however, and in the thickness of the grey matter, the Cerebrum of Man far surpasses that of this Cetaceous animal. In these respects the higher Quadrumana present the nearest approach to it; but their brain is much inferior in size. In descending the scale of Mammalia, there may be observed a gradual simplification in the general structure of the Cerebrum, depending upon a great diminution in the amount of commissural fibres; until in the Marsupialia the Brain presents nearly the same condition which it offers in Birds (§ 361). These animals manifest a much lower degree of Intelligence than many Birds evidently possess; and it is interesting to remark, that their Cerebral hemispheres are proportionably smaller than those which we find in many Birds: the diminution in their relative size not being counterbalanced (as it is in some other instances) by increased complexity of structure. In the class of Birds, we observe that the Vulture and the Falcon, whose predaceous instincts give them a considerable amount of general energy, are much inferior in the size of their brains to the Insessorial Birds, which are more intelligent; and that of all, there is none in which the brain is so proportionably large, as it is in the Parrot tribe, the educability of which is familiar to every one; whilst the easily-domesticable, but unintelligent Turkey, has a brain of scarcely half the proportional size. The very small size of the Cerebrum in Reptiles and Fishes, completely harmonizes with the same view; these animals presenting for the most part but feeble indications of intelligence. Among Reptiles, the Tortoise has a Cerebrum comparable in length to that of Birds; but its breadth and depth are far less. The largest Cerebra among Fishes are found in the Shark tribe; the superior intelligence of which is

well known to those who have had the opportunity of observing their habits : and it is interesting to remark, that their surface occasionally presents an appearance of rudimentary convolutions.

483. Comparative Anatomy, then, fully bears out the general doctrine, that the Cerebrum constitutes the organ of Intelligence, as distinguished from those mere Instincts, by which many of the lower animals seem to be almost entirely guided. By Intelligence, we do not mean, however, the reasoning faculties only ; but the combination of those powers which are of an educable character, and which become the springs of *voluntary* action, in varying proportions in different animals of the same tribe ; as distinguished from those, which have more immediate relation to the wants of the corporeal system, and which are *automatic* and invariable in the several individuals of the same species.—This definition does not leave out of view the operation of the Passions, Feelings, and Emotions ; which are all but modifications of Instinctive Propensities, to which different names are assigned. The true character of these, however, can only be understood, by studying the mode of their action on the bodily system. This action is of two kinds ;—the one direct, irrational and involuntary ;—the other indirect, rational, and voluntary. In the former, the action is the immediate result of the Emotion, following closely upon the Sensation which excited it, and consequently belongs to the *Consensual* group already discussed (Sect. 5) ; it is executed without any consciousness of the purpose to be answered by it ; and the power of the Will is only exerted to direct or restrain it. In the latter, as will be presently shown (§ 494), the action is but remotely the result of the Emotion, being altogether of the *Intelligent* class ; it is executed with a view to a distinct purpose, which has been determined on by the reasoning powers, and of which, therefore, the mind is fully conscious ; and it is purely an act of the Will, however strongly the Emotions may have acted in supplying motives to it and exciting the intellectual powers to action.

484. The general inferences drawn from Comparative Anatomy, are borne out by observation of the Human species. When the Cerebrum is fully developed, it offers innumerable diversities of form and size, among various individuals ; and there are as many diversities of character. It may be doubted if two individuals were ever exactly alike in this respect. That a Cerebrum which is greatly under the average size, is incapable of performing its proper functions, and that the possessor of it must necessarily be more or less idiotic, there can be no reasonable doubt. On the other hand, that a large well-developed Cerebrum is found to exist in persons, who have made themselves conspicuous in the world by their attainments or their achievements, may be stated as a proposition of equal generality. In these opposite cases, we witness most distinctly the antagonism between the Instinctive and Voluntary powers. Those unfortunate beings, in whom the Cerebrum is but little developed, are guided almost solely by their instinctive tendencies ; which frequently manifest themselves with a degree of strength that would not have been supposed to exist ; and occasionally new instincts present themselves, of which the Human being is ordinarily regarded as destitute.* On the other hand, those who have obtained most influence over the *understandings* of others, have always been themselves persons of strong intellectual and volitional powers ; in whom the instinctive tendencies have been subordinate to the reason and will, and who have given their whole energy to the particular object of their pursuit.—It is very different,

* A remarkable instance of this has been recently published. A perfectly idiotic girl, in Paris, having been seduced by some miscreant, was delivered of a child without assistance. It was found that she had *gnawed* the umbilical cord in two, in the same manner as is practised by the lower animals. It is scarcely to be supposed that she had any idea of the *object* of this separation.

however, with those who are actuated by what is ordinarily termed *genius*; and whose influence is rather upon the *feelings*, than upon the understandings, of those around them. Such persons are often very deficient in the power of even comprehending the ordinary affairs of life: and still more commonly, they show an extreme want of judgment in the management of them, being under the immediate influence of their passions and emotions, and not having brought these under the control of their intelligent will. The life of a *genius*, whether his bent be towards poetry, music, painting, or pursuits of a more material character, is seldom one which can be held up for imitation. In such persons, the *general* power of the mind being low, the Cerebrum is not usually found of any great size.—The *mere* comparative size of the Cerebrum, however, affords no accurate measure of the amount of mental power; we not unfrequently meet with men possessing large and well-formed heads, whilst their physical capability is not greater than that of others, the dimensions of whose crania have the same general proportion, but are of much less absolute size. Large brains, with deficient activity, are commonly found in persons of what has been termed the *phlegmatic* temperament, in whom the general processes of life seem in a torpid and indolent state; whilst small brains and great activity, betoken what are known as the *sanguine* and *nervous* temperaments. These distinctions come to be very important, where we proceed further in our inquiries, and attempt to determine the particular modes of development of the Brain, which coincide with certain manifestations of the mind.

485. Having now inquired into the evidence of the *general* functions of the Cerebrum, which may be derived from examination of its Comparative development, we proceed to our other sources of information; Experiment, and Pathological phenomena. From neither of these, however, is much information to be derived.—The effects of the entire removal of the Cerebral Hemispheres have been already stated (§ 435). So far as any inferences can be safely drawn from them, they fully bear out the conclusion, that the Cerebrum is the organ of Intelligence; since the animals which have suffered this mutilation appear to be constantly plunged in a profound sleep, from which no irritation ever seems able to arouse them into full activity. It may even be argued, that the phenomena which they exhibit do not imply the persistence of *consciousness*; and that this also must be regarded as the attribute of the Cerebral hemispheres, being destroyed by their ablation. But a careful analysis of them seems to show, that sensibility still exists, although it is much deadened; for in no other way can we legitimately explain the efforts made by the animals to balance themselves and maintain their position, which are of a much higher character than the mere reflex movements exhibited by the same animals after the removal of the entire Encephalon, and which can scarcely be explained without attributing to them a degree of sensation. That their sensibility should be greatly blunted, however, is to be anticipated from the fact, that it is almost impossible to remove the Hemispheres, without doing great injury to the other ganglionic centres, especially to the *Thalami Optici* and *Corpora Striata*; which, if the preceding views be correct, form a most important part of the *Sensori-Motor* apparatus, and which, in the experiments referred to, appear to have been generally removed with the Cerebral Hemispheres. The entire and permanent removal of all vascular pressure, top, which is consequent upon the laying-open of the cranial cavity, is another source of permanent disturbance in the functions of the parts which are left.—So far as they go, therefore, the results of such experiments confirm the deductions drawn from Comparative Anatomy, in regard to the general functions of the Cerebrum; but we must be careful not to infer too much from them, as to the extent to which the animal functions are brought to a close by the operation in question. In the most recent experiments, those of MM. Bouil-

laud and Longet, it was the opinion of the observers, that *sensibility* was retained, after the complete removal of the Cerebrum; although the animals appeared unable to attach any ideas to their sensations.*—The results of partial mutilations are usually, in the first instance, a general disturbance of the Cerebral functions; which subsequently, however, more or less subsides, leaving but little apparent affection of the animal functions, except muscular weakness. The whole of *one* Hemisphere has been removed in this way, without any evident consequence, save a temporary feebleness of the limbs on the opposite side of the body, and what was supposed to be a deficiency of sight through the opposite eye. The former was speedily recovered from, and the animal performed all its movements as well as before; the latter, however, was permanent, but the pupil remained active.—When the upper part, only, of both Cerebral Hemispheres was removed by Hertwig, the animal was reduced, for fifteen days, to nearly the same condition with the one from which they had been altogether withdrawn; but afterwards, sensibility evidently returned, and the muscular power did not appear to be much diminished.

486. The information afforded by Pathological phenomena is equally far from being definite. Many instances are on record, in which extensive disease has occurred in *one* Hemisphere, so as almost entirely to destroy it, without either any obvious injury to the mental powers, or any interruption of the influence of the mind upon the body. But there is no case on record of severe lesion of *both* hemispheres, in which morbid phenomena were not evident during life. It is true, that in Chronic Hydrocephalus, a very remarkable alteration in the condition of the Brain sometimes presents itself which might *à priori* have been supposed destructive to its power of activity;—the ventricles being so enormously distended with fluid, that the cerebral matter has seemed like a thin lamina, spread over the interior of the enlarged cranium. But there is no proof that absolute destruction of any part was thus occasioned; and it would seem that the very gradual nature of the change, gives to the structure time for accommodating itself to it. This, in fact, is to be noticed in all diseases of the Encephalon. A *sudden* lesion, so trifling as to escape observation, unless this be very carefully conducted, will occasion very severe symptoms; whilst a chronic disease may gradually extend itself, without any external manifestation. It will usually be found that sudden paralysis, of which the seat is in the Brain, results from some slight effusion of blood in the substance or neighbourhood of the Corpora Striata; whilst, if it follow disorder of the Brain of long standing, a much greater amount of lesion will usually present itself. In either case, the paralysis occurs in the opposite side of the *body*, as we should expect from the decussation of the pyramids; but it may occur either in the same, or on the opposite side of the *face*,—the cause of which is not very apparent. If convulsions accompany the paralysis, we may infer that the Corpora Quadrigemina, or the parts below, are involved in the injury; and in this case it is usually found, that the convulsions are on the paralyzed side of the body,—the effect of the lesion, both of the Cerebrum and of the Corpora Quadrigemina, being propagated to the opposite side, by the decussation of the Pyramids. Where, as not unfrequently happens, there is paralysis of one side, accompanying convulsions on the other, it is commonly the result of a lesion affecting the base of the Brain and Medulla Oblongata, on the side on which the convulsions take place;—here the effect of the lesion has to *cross* from the Brain, whilst its influence

* It is worthy of remark, also, that M. Flourens, who in the first instance maintained that sensation is altogether destroyed by the removal of the Cerebrum, has substituted, in the Second Edition of his Researches, the word *perception* for *sensation*: apparently implying exactly what is maintained above.—See § 435.

on the Medulla Oblongata is shown on the *same* side. Many apparent anomalies present themselves, however, which are by no means easy of explanation, in the present state of our knowledge.—The disturbance of the Cerebral functions, occasioned by those changes in its nutrition which are commonly included under the general term of Inflammation, presents a marked diversity of character, according to the part it affects. Thus it is well known that the delirium of excitement is usually a symptom of inflammation of the cortical substance or of the membranes of the hemispheres. This is exactly what might be anticipated from the foregoing premises, since this condition is a perversion of the ordinary mental operations, which are dependent upon the instrumentality of the vesicular matter; and it is evidently impossible for the membranes to be affected with inflammation without the nutrition of this substance being impaired, since it derives all its vessels directly from them. On the other hand, inflammation of the fibrous portion of the Cerebrum is usually attended rather with a state of torpor than with excitement; and with diminished power of the will over the muscles. It is stated by Foville, that in acute cases of Insanity, he has usually found the cortical substance intensely red, but without adhesion to the membranes; whilst in chronic cases, it is indurated and adherent: but where the Insanity has been complicated with Paralysis, he has usually found the medullary portion indurated and congested.

487. The general result of such investigations is, that the Cerebrum is the organ through which all those impressions are received which give rise to the operations of the Intellect; and that it affords the power of occasioning muscular contraction, in obedience to the influence of the Will, which is the result of those operations.—That all the operations of the Intellect are *originally* dependent upon the reception of Sensations, is a position that can scarcely be denied. If it were possible for a Human being to come into the world, with a Brain perfectly prepared to be the instrument of mental operations, but with all the inlets to sensation closed, we have every reason to believe that the Mind would remain dormant, like a seed buried deep in the earth. For the attentive study of cases, in which there is congenital deficiency of one or more sensations, makes it evident that the Mind is utterly incapable of forming any definite ideas, in regard to those properties of objects, of which those sensations are particularly adapted to take cognizance. Thus the man who is born blind can form no conception of colour; nor the congenitally-deaf, of musical tones. And in those lamentable cases, in which the sense of touch is the only one through which ideas can be introduced, it is evident that the mental operations would remain of the simplest and most limited character, if the utmost attention be not given by a judicious instructor, to the development of the intellectual faculties, and the cultivation of the moral feelings, through the restricted class of ideas which there is a possibility of exciting.—The activity of the Mind, then, is just as much the result of its consciousness of external impressions by which its faculties are called into play, as the Life of the body is the consequence of the excitement of its several vital properties by external stimuli. If these stimuli are prevented from acting in the first instance, the state of inaction continues; but when once the mind has been aroused, the sensations which it receives are treasured up by the Memory: and they may thus continue to be the sources of new ideas, long after the complete closure of the inlets, by which new sensations are ordinarily received. We have remarkable examples of this, in the vivid conceptions which may be formed from the description of a landscape or a picture, by those who have once enjoyed sight; or in the composition of music, even such as involves new combinations of sounds, by those who have become deaf,—as in the remarkable case of Beethoven. The mind thus

feeds, as it were, upon the store which has been laid up during the activity of its sensory organs; but instead of diminishing, like material food, these sensations become more and more vivid, the oftener they are recalled to the mind.

488. But the operations of the Intellect are immediately founded, not upon Sensations, but upon the *Ideas* they excite in the Mind.* Some ideas are so simple, and so constantly excited by certain sensations, that we can scarcely do otherwise than attribute them to original or fundamental properties of the mind, called into activity by the sensations in question; others, however, are of a much more complex nature, and vary according to the peculiar character of the individual mind, the general habits of thought, and its particular condition at the time. In either case, the formation in the mind of an elementary notion respecting the object of the Sensation, is the first operation in which the Cerebrum can be said to be necessarily concerned, and is introductory to all the rest. The process, whether simple or complex, is termed *Perception*; and the designation is applied, like Secretion, not merely to the act, but to its result,—being used to indicate the notion thus produced, whether it be simple and directly-excited, or more complex and the result of a succession of mental operations.

489. The difference between Perception and Sensation may be easily made evident. In order that a *sensation* should be produced, a *conscious* state of the mind is all that is required. Its whole attention may be directed towards some other object, and the sensation calls up no new ideas whatever; yet it will produce some change in the Sensorium, which causes it to be (as it were) registered there for a time, and which may become the object of subsequent attention; so that, when the mind is directed towards it, that idea or notion of the cause of the sensation is formed, which constitutes a *perception*. For example, a student, who is directing his thoughts to some object of earnest pursuit, does not receive any intimation of the passage of time, from the striking of a clock in his room. The sensation must be produced, if there be no defect in his nervous system; but it is not attended to, because the mind is bent upon another object. It *may* produce so little impression on the mind, as *not* to recur spontaneously, when the train of thought which previously occupied the mind has been closed, leaving the attention ready to be directed to any other object; or, the impression having been stronger, it may so recur, and at once excite an idea in the mind.—Again, the individual may then be able only to say, that he heard the clock strike; or he may be able to retrace the number of strokes. Now, in either case, a complex perception is formed, without his being aware that any mental operation has intervened. He would say that he remembers hearing the clock strike; but this would not express the truth. That which he remembers is a certain series of sonorous impressions, which was communicated to his mind; and he recognizes them as the striking of a clock, by a process in which memory and judgment are combined,—which process may further inform him, that the sounds proceeded from his own particular clock. If he had never heard a clock strike, and the sound produced by it had never been described to him, he would not have been able to form that notion of the object giving rise to the sensation, which, simple as it appears to be at the time, is the result of complex mental operations. But when these operations have been frequently performed, the per-

* Some Metaphysicians have spoken of *ideas* as *transformed sensations*; but this is a gross absurdity. The idea is *excited* by the sensation, in accordance with the original properties of the mind, and the laws of their operation, just as muscular contraction is excited by the stimulus of electricity or innervation; but it would be just as correct to speak of a muscular contraction as transformed electricity or innervation, because excited by either of these stimuli, as it is to call an idea a transformed sensation.

ception or notion of the object becomes inseparably connected with the sensation ; and thus it is excited by the latter, without any knowledge on the part of the individual, that a mental operation has taken place.

490. Such Perceptions are termed *acquired*, in contradistinction to the *intuitive* perceptions, of which the lower animals seem to possess a large number. The idea of the distance of an object, for example, is one derived in Man from many sources, and is the result of a long experience ; the infant, or the adult seeing for the first time, has to bring the senses of sight and of touch to bear upon one another, in order to obtain it ; but, when once the power of determining it is acquired, the steps of the process are lost sight of. In the lower tribes of animals, however, in which the young receive no assistance from their parents, there is an evident necessity for some *immediate* power of forming this determination ; since they would not be able to obtain their food without it. Accordingly, they manifest in their actions a perception or governing idea of distances, which can only be gained by Man after long experience. A fly-catcher, for instance, just come out of its shell, has been seen to peck at an insect, with an aim as perfect as if it had been all its life engaged in learning the art.—In some cases, animals seem to learn that by intuitive perception, at which Man could only arrive by the most refined processes of reasoning, or by the careful application of the most varied experience. Thus, a little fish, named the *Chatodon rostratus*, is in the habit of ejecting from its prolonged snout, drops of fluid, which strike insects that happen to be near the surface of the water, and causes them to fall into it, so as to come within its own reach. Now, by the laws of refraction of light, the place of the Insect in the air, will not really be that at which it appears to the Fish in the water ; but it will be a little below its apparent place, and to this point the aim must be directed. But the difference between the real and the apparent place will not be constant ; for the more perpendicularly the rays enter the water, the less will be the variation ; and, on the other hand, the more oblique the direction, the greater will be the difference. Now it is impossible to imagine but that, by an intuitive perception, the real place of the Insect is known to the Fish in every instance, as perfectly as it could be to the most sagacious Human mathematician, or to a clever marksman, who had learned the requisite allowance in each case by a long experience.

490*. In Man, the *acquisition* of perceptions is clearly a Cerebral operation ; but their *intuitive* formation in the lower animals is probably to be regarded as one of those processes to which the Sensory ganglia are subservient. The same may be said of many of the intuitive perceptions in Man ; which, if analyzed, are found to be connected rather with the instinctive and emotional tendencies, than with the intellectual powers ;—the perceptions which minister to the exercise of these last, being the result of experience. Thus, it has been well remarked by Dr. Alison, that the changes which Emotions occasion in the countenance, gestures, &c., of one individual, are *instinctively* interpreted by others ; for these signs of mental affection are very early understood by young children, sooner than any associations can be supposed to have been formed, by experience, of their connection with particular modes of conduct ; and they affect us more quickly and strongly, and with nicer varieties of feeling, than when it is attempted to convey the same feelings in words, which are signs addressed to the intellect.

491. By a certain *retentive* power, which appears to be peculiar to the Cerebrum, Sensations and the simple ideas or Perceptions they excite, are stored up (so to speak) in such a manner, as to become the subjects of further mental operations at a time more or less remote. They then present themselves as renewed images of past sensations ; and these may recur, either involuntarily, or by a special direction of the mind towards them by an effort

of *Recollection*. In either case, the Memory of them is probably due to the operation of the principle of *Association*; by which sensations and the ideas they excite become linked together, in such a manner that the recurrence of one shall be the means of the recal of others which are connected with it.—There seems much ground for the opinion, that *every* Sensation actually experienced *may* become the subject of a Perception at any future time, though beyond the voluntary power of the memory to retrace; and the phenomena of dreams and delirium, in which these sensations often recur with extraordinary vividness, afford much support to this doctrine. Some of the instances upon record are remarkable, as proving that the sensations may be thus remembered, without any perceptions being attached to them; these sensations having been of such a nature as not to excite any notion or idea in the mind of the individual. A very extraordinary case of this kind has been recorded, in which a woman, during the delirium of fever, continually repeated sentences in languages unknown to those around her, which proved to be Hebrew and Chaldaic; of these she stated herself, on her recovery, to be perfectly ignorant; but on tracing her former history, it was found that, in early life, she had lived as servant with a clergyman, who had been accustomed to walk up and down the passage, repeating or reading aloud sentences in these languages, which she must have retained in her memory unconsciously to herself. Of the nature of the change, by which sensations are thus registered, it is in vain to speculate; and it does not seem likely that we shall ever become acquainted with it. This is certain, however,—that disease or injury of the brain will destroy this power, or will affect it in various remarkable modes. We not unfrequently meet with cases in which the brain has been weakened by attacks of epilepsy or apoplexy, in such a manner as to prevent the reception of any *new* impressions; so that the patient does not remember anything that passes from day to day; whilst the impressions of events, which happened *long before* the commencement of his malady, recur with greater vividness than ever. On the other hand, the memory of the long-since-past is sometimes entirely destroyed; whilst that of events which have happened subsequently to the malady is but little weakened. The memory of particular classes of ideas is frequently destroyed;—that of a certain language, or some branch of science, for example. The loss of the memory of words is another very curious form of this disorder, which is not unfrequently to be met with: the patient understands perfectly well what is said, but is not able to reply in any other terms than *yes* or *no*,—not from any paralysis of the muscles of articulation, but from the incapability of expressing the ideas in language. Sometimes the memory of a particular class of words only, such as nouns or verbs, is destroyed; or it may be impaired merely, so that the patient mistakes the proper terms, and speaks a most curious jargon. These cases have a peculiar interest, in reference to the inquiry into the functions of different parts of the Cerebrum.

492. To the formation of vivid ideas of sensible objects, whether these have actually presented themselves in the same form at some previous time, or are modifications of the forms which had a real existence, the term *Conception* is applied; and this designation, like Perception, is also applied to the result of the operation, that is, to the idea which is thus formed. The novelty of the Conception may depend upon the new combination or correlation of the objects it includes; or it may result from a sort of decomposition of former complex ideas, and the re-assembly of their elements under a different form. These processes, like the Memory, of which they are modifications, may be either spontaneous or voluntary; and in both forms they are continually employed by almost every one,—the tendency to the exact reproduction of former

ideas, however, being most evident in some minds, whilst the tendency to the modification of them is more obvious in others. The latter is one source of that faculty, to which the term Imagination is given.

493. The Mind, however, is not restricted to external sources, for objects of perception; since, when once in activity, *it perceives its own operations*, and traces the various relations and connections among its objects of thought. The power of doing this may be termed *Internal Perception*. The mind often has internal perceptions without any direct effort of the will, just as it receives perceptions from external objects; but its power of cognizance is not unfrequently directed inwards by express volition; and the act is then peculiarly termed *Reflection*, or perhaps better, *Introspection*.—Now by this process, a new class of ideas is excited, of a very different character from those which are called up by external objects; and these, being entirely dependent upon the operation of the Intellectual powers, and having no dependence upon Sensations except as the original springs of those operations, may be termed *Intellectual Ideas*, in contradistinction to the *Sensational Ideas*. The former, like the latter, become the subjects of the Associating tendency; and thus are combined in *Trains of Thought*. Some of these intellectual ideas appear to be so necessarily excited by mental operations, even of the simplest kind, and to be so little dependent on individual peculiarities either inherent or acquired, that they take rank as fundamental axioms or principles of Human Thought. Such are,—the belief in our own *present existence*, or the faith which we repose in the evidence of Consciousness; this idea being necessarily associated with every form and condition of mental activity,—the belief in our *past existence*, and in our *personal identity* so far as our memory extends, which is necessarily connected with the act of Recollection; with this, again, is connected the general idea of Space:—the belief in the *external and independent existence* of the causes of our sensations, which results from Perception, or the direction of the mind to the ideas originating in them; with this is connected the general idea of Space:—the belief in the existence of an *efficient cause* for the changes which we witness around us, which springs from the Perception of those changes; whence is derived our idea of Power,—the belief in the *stability of the order of nature*, or in the invariable sequence of similar effects to similar causes, which also springs directly from the Perception of external changes, and seems prior to all reasoning upon the results of observation of them (being observed to operate most strongly in those whose experience is most scanty, and in relation to subjects that are perfectly new to them); but which is the foundation of all applications of our own experience or that of others, to the conduct of our lives, or to the extension of our knowledge:—lastly, the belief in *our own free will*, involving the general idea of Voluntary Power; which is in like manner a direct result of our Internal Perception of those mental changes which are excited by sensations. Hence it is evident, that “the only foundation of much of our belief, and the only source of much of our knowledge, is to be found in the constitution of our own minds;” but it must be steadily kept in view, that these fundamental axioms are nothing else than expressions of the general fact, that the ideas in question are uniformly excited (in all ordinarily-constituted minds, at least) by simple attention to the changes in which they originate.

494. Upon the Sensational and Intellectual Ideas thus brought under the cognizance of the Mind, all acts of *reasoning* are founded. These consist, for the most part, in the aggregation and collocation of ideas; the decomposition of complex ideas into more simple ones, and the combination of simple ideas into general expressions; in which are exercised the faculty of Comparison, by which the relations and connections of ideas are perceived,—that

of Abstraction, by which we fix our attention on any particular qualities of the object of our thought, and isolate it from the rest,—and that of Generalization, by which we fix in our minds some definite notions in regard to the general relations of those objects. These are the processes chiefly concerned in the simple acquirement of Knowledge; with which class of operations, the Emotional part of our nature has very little participation. But in those modes of exercise of our reasoning powers, which are chiefly concerned in the determination of our actions, the Emotions, &c., are largely concerned. As formerly explained (§ 440), they chiefly (if not solely) act upon the reasoning powers, by modifying the form in which the ideas are presented to the mind,—whether these ideas are directly excited by external sensations, or whether they are called up by an act of the Memory, or result from the exercise of the Imagination.* If we closely scrutinize our Emotions, indeed, we shall find that they consist chiefly, if not entirely, of feelings of pleasure and pain, connected with certain classes of ideas; the former producing a *desire* of the objects to which they relate: the latter a *repugnance* to them. They thus have a most important influence upon the *Judgment*, which is formed by the comparison of certain kinds of ideas; and they may consequently modify the Volitional determination, or act of the Will, which is consequent upon this, and which may either be directed towards the further operations of the mind itself, or may exert an immediate influence on the bodily frame, by the agency of the Nervous System. In either case, it is the characteristic distinction of a Volitional operation, that *means are intentionally adapted to ends*, in accordance with the belief of the mind as to their mutual relations. Upon the correctness of that decision, will depend the power of the action to accomplish what the mind had in view.

495. The faculty of *Imagination* is in some respects opposed in its character to that of Reason; being concerned about fictitious objects, instead of real ones. Still it is in a great degree an exercise of the same powers, though in a different manner. Thus it is partly concerned in framing new combinations of ideas relating to external objects, and is thus an extended exercise of Conception,—placing us, in idea, in scenes, circumstances, and relations, in which actual experience never placed us,—and thus giving rise to a new set of objects of thought. In fact, every Conception of that which has not been itself an object of perception, may, strictly speaking, be regarded as the result of the exercise of Imagination. Now the new Conceptions or mental creations thus formed take their character, in great degree, from the Emotional tendencies of the mind: so that the previous development of particular feelings and affections will influence, not merely the selection of the objects, but the mode in which they are thus idealized. In the higher efforts of the Imagination, the mind is concerned, not so much with the class of Sensational ideas, but with those of the Intellectual character: and the collocation, analysis, and comparison of these, by which new forms of combinations are suggested to the mind, involve the exercise of the same powers, as those concerned in acts of Reasoning,—but they are exercised in a different way. Whilst the Imagination thus depends upon the Intellectual powers for all its higher operations, the Understanding may be said to be equally indebted to the Imagination; for the ideal combinations, which are the results of the action of the latter, do not merely engage the attention of the Artist, who aims to develop them in material forms, but are the great sources of the im-

* The recal of *past* sensations and ideas may produce purely Emotional actions; by exciting in the centres, from which those actions proceed, a condition corresponding with that which would be excited by the *present* sensation (§ 439).

provement of the knowledge and happiness possessed by our race,—operating alike in the common affairs of life, by suggesting those pictures of the future which are ever before our eyes, and are our animating springs of action, with their visions of enjoyment never perhaps to be fully realized, and their prospects of anticipated evil that often prove to be an exaggeration of the reality,—prompting the investigations of Science, that are gradually unfolding the sublime plan on which the Universe is governed,—and leading to a continual aspiration after those highest forms of Moral and Intellectual beauty, which are inseparably connected with purity and love.

8. *General Recapitulation and Pathological Applications.*

496. A general Summary of the views here propounded, in regard to the Functions of the Cerebro-Spinal division of the Nervous system, may probably be useful in assisting the Student to gain clear ideas regarding them.—The fibres of the nervous *trunks* may be divided, according to the direction of their influence, into two classes,—the *afferent* or *centripetal*,—and the *efferent* or *centrifugal*. The afferent may be said to commence at the periphery, especially on the skin, mucous surfaces, &c., and to terminate in the vesicular matter of the nervous centres; whilst the efferent originate in that vesicular matter, and terminate in the muscles.* Every fibre runs a distinct course from its origin to its termination; and it is not improbable that there are *several* distinct endowments in the different fibres composing each trunk. There is no evidence that the fibrous structure serves any different purpose than that of a mere conductor; and there seems good reason to believe that all the active operations, of which the nervous system is the instrument, originate in the vesicular matter. A mass of vesicular matter, connected with nervous trunks, forms a *ganglion*. In the Invertebrata, the ganglia are frequently numerous, and are scattered through the system, without much connection with each other;—each having an independent action, although its function may be but a repetition of that of others. In Vertebrated animals, on the other hand, they are united into one mass; partly, it would seem, for the sake of the protection afforded them by the bony skeleton; and partly, in order that more complete consentaneousness of action may be attained. Still, certain divisions may be traced in the central masses of the Cerebro-Spinal system; both by the determination of their respective functions, as indicated by observation and experiment; and by the study of the distribution of the nerves proceeding from them. In this manner we arrive at the knowledge of several distinct *ganglionic centres*, of which the following may be considered as a general account.

1. The True Spinal Cord, consisting of a nucleus of vesicular matter, receiving *afferent* fibres, and giving origin to *efferent*; by these it is connected with all parts of the body, but especially with the surface and muscles of the extremities. The actions of this centre *may* be performed without consciousness on the part of the individual; and they consist in the *reflexion* of a *motor* impulse along an *efferent* nerve, on the reception of a *stimulus* conveyed by an *afferent* or *excitor* nerve. These reflex movements can be best excited, when the muscles are removed from the control of the Will, which otherwise generally antagonizes them. Some of them are connected with the maintenance

* The terms *originate* and *terminate* cannot be used with strict correctness; since, as formerly explained (§ 248), many fibres seem to have no actual termination, either in the muscles or in vesicular matter: but they cease to run in their previous direction, after forming their terminal loops; and their course as afferent or efferent fibres may consequently be said to begin or to end at these points.

of the Organic functions; others with locomotion; and others with the protection or withdrawal of the body from injury. Muscular movements may also be excited by a stimulus directly applied to the Spinal Cord itself (§§ 363—373).

II. The Medulla Oblongata, or cranial prolongation of the Spinal Cord. The actions of this do not essentially differ from those of the true Spinal Cord; but they are connected with different organs. This part consists chiefly of the centres of the nerves of Respiration and Deglutition,—two functions, of which the continual maintenance is essential to the life of the being; and it would seem as if these were placed within the cranium, to be more secured from accidental injury. The movements concerned in Respiration and Deglutition are, like those excited through the true Spinal Cord, of a strictly *reflex* character, being in all instances due to an impression or *stimulus* originating in the *periphery* of the system, which, being conveyed to the *centre*, excites there a *motor* impulse; and they, also, are independent of Sensation (§§ 374—387).

III. The Ganglia of the nerves of Sensation, common and special, which form, as it were, the continuation of the Medulla Oblongata. These appear to minister to actions, which, like the Reflex, are almost necessarily excited by certain stimuli, and are only in a degree controllable by the Will: but which differ from those of which the Spinal Cord is the centre, in being only excitable through Sensation. Reasons have been given for the belief, that these ganglia are the centres of those actions, which are commonly termed *instinctive* in the lower animals, and *consensual* and *emotional* in ourselves; these all correspond, in being performed without any idea of a purpose, and without any direction of the Will,—being frequently in opposition to it (§§ 422—460).

IV. The Cerebral Hemispheres or Ganglia, which are evidently the instruments or organs of the *intellectual* faculties. It is probably by them alone, that Ideas or notions of surrounding objects are acquired, and that these ideas are made the groundwork of mental operations. They would seem, also, to be the exclusive seat of Memory. The results of these operations are manifested on the bodily frame, through the *Will*; which is capable of acting, in greater or less degree, on all the muscles forming part of the system of Animal life (§§ 471—495).

V. The Cerebellum, which appears to be concerned in the regulation and *harmonization* of Muscular movements, especially those of a voluntary character (§§ 457—470).

497. The arrangement and connections of these parts may be thus concisely expressed:—

Tabular view of the Nervous Centres.

Cerebral Ganglia,
the centres of the operations
of Intelligence and Will.

Nerves of Special sensation. — Motor fibres mingled with general motor system (?).

Sensory Ganglia,
the centres of Consensual,
Instinctive, and Emotional actions.

{ Nerves of Special sensation. — Motor fibres mingled with general motor system (?).

Cerebellic Ganglia,
for harmonization of general
muscular actions.

Afferent and Motor Nerves }
of Respiration, Deglutition, }
&c.

Respiratory and }
Stomato-gastric Ganglia, }
in Medulla Oblongata.

{ Afferent and Motor Nerves
{ of Respiration, Deglutition,
{ &c.

Trunks of Spinal nerves, composed of afferent and motor fibres from true Spinal Cord and Medulla Oblongata; and probably also of sensory and motor fibres, connected by the longitudinal strands of the Cord, with the Sensory Ganglia.

Fibrous structure, continuous with Encephalon.
True Spinal Cord, consisting of chain of ganglia, for Reflex actions of the trunk and extremities.
Fibrous structure, continuous with Encephalon.

{ Trunks of Spinal Nerves, composed of afferent and motor fibres from true Spinal Cord and Medulla Oblongata; and probably also of sensory and motor fibres, connected by the longitudinal strands of the Cord, with the Sensory Ganglia.

The Spinal Cord, the Medulla Oblongata, and Sensory Ganglia, seem to constitute one continuous group of ganglionic centres; which must be regarded as the fundamental portion of the Nervous System. In descending the Vertebrated series, we find the Cerebrum and Cerebellum gradually diminishing in size and importance, and at last, in the *Amphioxus*, disappearing altogether; and the *Cranio-Spinal axis*, which then remains, differs in nothing but the continuity of its vesicular structure, from the nervous system characteristic of the Articulata, in which the vesicular matter is broken up (so to speak) into distinct centres. In this Cranio-Spinal Axis, all the nerves have their termination; and, from what has been ascertained of the anatomy of the gangliated cord in the Articulata, there seems much reason to believe, that their fibres may pass, in the longitudinal strands of the Cord, to great distances from their points of entrance or emersion; so that we may have, in the nerves connected with every part of the Cord, sensory fibres, whose real termination is in the Sensory ganglia at its summit, and motor fibres, which originate from these centres, and are the instruments of all the actions to which they minister. The great difficulty of tracing the individual fibres of the Spinal Cord, for any considerable part of its length, renders it impossible, however, to say with certainty that this is their real disposition; but it is known that *one* at least of the nerves, the Third pair, has this double connection with the Sensory Ganglia and the Spinal Cord (or rather the Medulla Oblongata), and it is likely that the same is true of the other motor nerves of the Orbit. Hence there is no improbability in the idea, that of the *afferent* fibres of the Spinal nerves, some are connected with the vesicular matter of the part of the Spinal Cord through which they pass, and others with the Sensory Ganglia in the Encephalon; the relative numbers entering these centres being accordant with the chief purposes of the trunk, whether as an *excitor* of reflex actions, or as destined to arouse *sensations*:—and that the like is true of the motor fibres, the relative proportions of those derived from the two sources having reference to the character of the motions, whether *simply-reflex* or *consensual*,—to which the trunk is destined to minister. But there is by no means the same evidence, that any fibres contained in the nerves actually go on to the Cerebrum and the Cerebellum; and the probability seems rather, that the fibres which connect these masses with the Cranio-spinal Axis are of a *commissural*

nature, and are destined to enable them to receive communications, and to act on the muscular system, through the mediation of the latter,—than that they are actually continuous with any of the fibres in the nerve-trunks connected with it (see § 473).

498. According to these views, the following will be the mechanism of the different classes of actions, in which the Cerebro-Spinal apparatus is directly concerned.

i. In *Reflex movements*, a stimulus acting through the *excitor* fibres upon the vesicular matter of certain parts of the Spinal Cord, causes the transmission of a reflex impulse through the *motor* fibres that proceed from it; and this gives occasion to muscular contraction.—With this operation, sensation will be coincident, if the stimulus act upon any of the fibres that pass on to the Sensory ganglia; but this is not essential to it; and will not be aroused if the connection does not exist, or the Sensory ganglia be in a state of torpor.

ii. In *Sensation*, the stimulus acts upon fibres which have their termination in the chain of ganglia that lies at the base of the cranial cavity in Man, and is closely connected with the Medulla Oblongata. The series is collectively termed the Sensorium; but it is probable that each is the instrument, by which the animal becomes cognizant of Sensations of a particular class,—the Olfactive, Optic, and Auditory ganglia, for those of Smell, Light, and Hearing respectively, the Thalami Optici for those of Touch, and certain parts of the Medulla Oblongata for those of Taste.

iii. In *Consensual movements*, the stimulus conveyed by the Sensory fibres becomes the direct source of motor impulses; which are conveyed through the agency of fibres that issue from the Sensory ganglia and Corpora Striata. All the movements which are neither reflex nor voluntary, seem to belong to this class; which will include, therefore, the instinctive actions of the lower animals, with the automatic and purely emotional movements in Man.

iv. In the act of *Perception*, or the formation of ideas from Sensations, in Memory, and in all the higher acts of Mind, the Cerebrum seems to be concerned; the vesicular matter which constitutes its active portion, receiving the stimulus to its operations, through the ascending and commissural fibres that connect its different parts with the Sensory Ganglia at its base. As the conducting power of these fibres acts *from*, not *towards*, the Sensory ganglia, we should not expect that irritation of them should produce Sensation; and this is precisely what experiment shows to be the case.

v. In the act of *Voluntary movement*, which results from mental operations, the vesicular matter of the Cerebrum operates, through the descending and commissural fibres, upon the motor portion of the Sensory ganglia; the stimulus transmitted downwards by Volition producing the same kind of state in its vesicular matter, as that which is transmitted upwards by Sensation. In the same manner, the recal of past Sensations and Ideas may reproduce, in the Sensory ganglia, the condition which gives occasion to the purely Emotional movements.

vi. The combination and harmonization of the separate acts of Voluntary Muscular movement, which is the function here attributed to the Cerebellum, appears to be prompted by the guiding sensations, of which the Sensory ganglia are the seat; the influence of these will be propagated along the commissural fibres known as the *processus a cerebello ad testes*; and the motor influence, resulting from the action thus excited in the vesicular matter of the Cerebellum, will be propagated downwards by its connections with the various columns of the Spinal Cord.

499. The distinctness of the operations of these several centres is shown in various ways: but especially by conditions of the bodily system, in which one or more of them is in a state of inaction, whether temporary or permanent;

or is prevented, by the interruption of the usual channel of communication, from operating on particular parts. Thus, in ordinary profound *Sleep*, which is a state of complete unconsciousness, it is evident that the Cerebral Hemispheres, and the Sensory Ganglia, are at rest; as the Cerebellum, also, may be considered to be: but the Medulla Oblongata and Spinal Cord must be in complete functional activity. The same is the case in profound *Coma*, resulting from effusion of blood, or from narcotic poisons, but not affecting the power of breathing or swallowing. It may be frequently observed, that the sleep is not so profound as entirely to suspend the consciousness of the individual; and that various movements of an *adaptive* character are performed, tending to relieve uneasiness resulting from various causes. In this condition it seems not improbable, that the Sensory ganglia are in some degree awake, and that the movements are of an *instinctive* nature;—the mind of the individual not being sufficiently active to discern the cause of the uneasiness, or to employ his intelligence in the removal of it. Whenever Dreaming takes place, it is evident that the Cerebrum is in a state of partial activity. The states of Dreaming and Delirium, and many forms of Insanity, have considerable analogy with each other; especially in the absence of the power which is so characteristic of the well-regulated mind of Man, of controlling and regulating the current of thought. One idea calls up another, according to their previous associations; and the most incongruous combinations are frequently the result; but it will generally, if not always, be found, that the ideas themselves have been previously in the mind, and that no entirely new train of thought is started. Of the degree in which, when the mind is thus closed to the external world, the hidden stores of Memory are opened to its search, many very curious instances are recorded.

500. The state of *Somnambulism* appears to be nearer to that of wakeful activity of the whole mind, than is that of Dreaming. In the latter condition, the individual is unconscious of external objects; for, if they produce an effect upon him, it is in modifying the current of ideas, frequently in some very extraordinary manner: and he does not form any true perception or idea of their nature. But in Somnambulism, his senses are partly awake, so that impressions made upon them may be properly represented to the mind, and excite there the ideas with which they are connected; moreover the Cerebellum is also awake, so that the movements which the individual performs, are perfectly adapted to their object; indeed, it has frequently occurred, that the power of balancing the body has been so remarkably exercised in this condition, that sleep-walkers have traversed narrow and difficult paths, over which they could not have passed in open day, when conscious of their danger. In Somnambulism, as in Dreaming, there is an evident want of voluntary control over the thoughts; their succession is more influenced, however, by impressions received from without, than it is in dreaming; and hence the mind may sometimes be easily guided into a particular train, by properly directing the impressions made upon the sensory organs. It may often be remarked, however, that impressions which do not in some degree harmonize with the train of ideas, are not received by the mind; or, at any rate, they are not applied to the correction of the erroneous notions which possess it. But there are many different shades in the condition of the mind, between Dreaming and Somnambulism; the individual being, in some cases, much less conscious of external objects, than he is in others. In some instances it appears as if the mind was so wholly engrossed in a particular train of thought, that it could not be affected by any new sensations, so that there is even an unconsciousness of those which produce pain; this has its parallel in the waking state. A very remarkable characteristic of the state of Somnambulism, is the complete isolation which commonly exists, between the trains of thought which then

occupy the mind, and its operations during the waking hours; so that in neither state is there a remembrance of what passes in the other. There is usually this difference, however;—that the mental operations which take place in Somnambulism are, like those of dreaming, frequently suggested by what has previously been occupying the mind; whilst these seem to leave no impression to be retraced in the waking state, though all that passes in one fit of Somnambulism may be recollected in the next. This has been most remarkably observed in the phenomena of that curious state, which is known under the name of Double Consciousness;* in this, the form of Somnambulism in which there is a consciousness of external impressions, seems to alternate with the condition of ordinary mental activity, and the individual leads (as it were) two distinct lives, recollecting in each condition what happened in previous states of the same character, but knowing nothing of the occurrences of the other.—In regard to the curious forms of these affections, which are produced by the so-called Mesmeric influence, the present views of the Author will be stated in the Appendix.

501. We have thus witnessed several varieties in the condition of the bodily system, depending upon partial or complete suspension of the functional activity of the Cerebrum, Cerebellum, and Sensory ganglia. There is no normal condition of the Spinal system, which at all corresponds with these; since its operations are so closely connected with the maintenance of the Organic functions, that the suspension of them necessarily induces the cessation of the latter. This is especially the case, however, in regard to the Respiratory ganglion; for the whole remainder of the Spinal Cord may be removed, without the interruption of the movements which are dependent on that segment of it. Cases have occurred, however, in which the natural performance even of these has been partially or entirely suspended; and in which the maintenance of life has for a time been effected, by a *voluntary* exertion of the muscles of Respiration. The influence of the Will upon the general motor apparatus of Man, seems to predominate so greatly over the Reflex action of the Spinal Cord, that few phenomena which are attributable to the latter ordinarily present themselves; these are manifested, however, when the influence of the Brain over any part is cut off, as is seen in certain cases of paralysis. These morbid conditions present us, also, with illustrations of other effects of the interruption of the communication between the nervous centres and particular sets of muscles. Thus, the influence of the Will may be cut off, although that of the Instincts, Emotions, and Reflex Function may remain; or the responsiveness of the muscles to Emotion may be prevented, whilst they are still capable of Voluntary control, or of Reflex action. Such cases seem to point very clearly to three distinct primary centres of nervous agency;—and to these, the Cerebrum Sensory Ganglia, and Spinal Cord (including the Medulla Oblongata) have been here assigned as the instruments. We shall next inquire into some other morbid conditions of the system, which seem due to the irregular action of these; and in this we shall be chiefly guided by the researches of Dr. M. Hall, which have been already slightly glanced at (§§ 400, 401).

502. Of the *Convulsive* diseases, it appears that the greater part, if not the whole, may be attributed to a morbid state of the Spinal System of nerves. So completely does the power of producing convulsive movements appear limited to that and to the Sensori-motor system, (no mechanical irritation of the Cerebral substance being effectual in exciting such movements, § 473,) that, where convulsions present themselves during diseases which appear

* Much interesting information on this and other subjects, alluded to in this Section, may be found in Dr. Abercrombie's Treatise on the Intellectual Functions.

limited to the Brain, we may infer that one of these systems is involved. Dr. M. Hall has recently pointed out, that this complication is due to the impressions made upon the fibres of the Spinal nerves distributed upon the Dura Mater, and other serous and fibrous membranes; for convulsive actions may be induced by pinching these membranes, or otherwise irritating them.—Of the distinct forms or combinations, of which the class of convulsive disorders is composed, *Tetanus* is one of the most interesting and instructive. This disease is evidently dependent upon a state of undue excitability of the whole Spinal System; and this may be produced by different causes. That which is termed the idiopathic form of the disease has its origin in the centres; it may result in Man from the operation of various predisposing and exciting causes: and may be artificially induced in Animals by the administration of Strychnia. In the traumatic form of the disease, the morbid state has its origin in a local injury; and the irritation propagated from this, and operating through the Spinal Cord, may be itself a cause of many of the convulsive movements. But, when the irritable state is once established in the nervous centres, convulsive action of the muscles may be excited by any stimuli, and even almost entirely without external causes. Hence it is that, whilst the amputation of the injured part is not unfrequently the means of saving the patient, if performed sufficiently early, it is attended with no benefit if delayed. The Cerebral apparatus is entirely unaffected in this disorder; but the nerves of deglutition are usually those first influenced by it; those of respiration, however, being soon affected, as also those of the trunk in general.—The condition termed *Hydrophobia* is nearly allied to that of traumatic Tetanus, differing chiefly in the mode in which the cranio-spinal axis is affected. The irritable state of the nervous centres results from a local injury of a peculiar kind; and here, too, the early removal of the part is very desirable as a means of prevention; although, when the malady has once reached the centres, it is of no use. The muscles of respiration and deglutition are, as in Tetanus, those spasmodically affected in the first instance; but there is this curious difference in the mode in which they are excited to action,—that, whilst in Tetanus the stimulus operates through the true Spinal Cord (either centrally, or by being conveyed from the periphery), in Hydrophobia it is often conducted from the ganglia of Special Sense, or even from the Cerebrum; so that the sight or sound of fluids, or even the idea of them, occasions—equally with their contact, or with that of a current of air—the most distressing convulsions. It would seem, therefore, as if the Sensori-motor system of nerves was involved in it.*—In these and other general convulsive diseases, it is probable that the whole vesicular matter of the centres involved is in so excitable a state, that a stimulus applied to any part of it may produce a reaction through the whole. In no other way would it be easy to explain the great number and variety of movements, which a small degree of local irritation may excite.

503. *Epilepsy* is another convulsive disease, principally involving the Spinal Cord, but partly affecting the Brain. The predisposition to convulsive movements may depend upon many causes; but the movements themselves are in general immediately excited by some local irritation, as by the presence of undigested matter in the stomach, of worms in the intestines, &c., although frequently also from causes purely mental. The convulsive movements usually affect the muscular system very extensively; acting especially upon the muscles of ingestion and egestion. The Brain is evidently much concerned in the disease, however; as is evident from the numerous instances in which it has been clearly traced to some local affection of that organ, as well as from

* For an interesting case of the excitement of involuntary muscular movements, by sensations received through the eye and ear, see Dr. Cowan, in *Lancet* for 1845. Vol. II., p. 364.

the loss of consciousness which accompanies the convulsion.—Many forms of that protean malady, *Hysteria*, are attended with a similar irritability of the Nervous Centres; but there is this remarkable difference in the two cases,—that the morbid phenomena of *Hysteria*, whilst they often simulate those of *Tetanus*, *Hydrophobia*, *Epilepsy*, &c., are evidently dependent upon a state of the system of a much less abnormal character, being frequently relieved by very mild remedies, and being often capable of prevention by a strong effort of the will. Dr. Hall has pointed out an important distinction between *Epilepsy* and *Hysteria*, which materially influences the proximate danger of the paroxysm of each respectively; in the former, the larynx is convulsively closed, and partial asphyxia is the necessary result, if the access of air be too long prevented, so that venous congestion ensues, increasing the disorder of the nervous centres even to a fatal degree; in *Hysteria*, on the contrary, much as the larynx is affected, it is not usually closed. Cases sometimes present themselves, however, in which the *Hysterical* paroxysm assumes the *Epileptic* character, the larynx being closed during expiration, so as to produce alarming results. The disordered state of the Nervous Centres, to which these convulsive actions are due, seems to be peculiarly connected with Emotional conditions of the mind, and with functional derangements of the sexual organs.

504. The foregoing are the chief *general* spasmodic diseases in which the Spinal system of nerves is evidently involved;* but there are many others of a more local character. Such are the various forms of Spasmodic Asthma, the attacks of which generally result from some internal irritation, either in the lungs themselves or in the digestive system, producing a reflex action upon the muscular fibres of the bronchial tubes. The Croup-like Convulsion, or Crowing Inspiration of Infants, again, is an obstruction to the passage of the air through the glottis, by a spasmodic contraction of the constrictors of the larynx. This spasmodic action may be induced by various kinds of irritation; such as that occasioned by teething, by the presence of undigested food, or by intestinal disorder. In the crowing inspiration, the larynx is partially closed; when the spasm is severe, however, there is complete occlusion of the passage; and forcible efforts at expiration are made, which induce, as in epilepsy, a severe degree of venous congestion, and this reacts upon the nervous centres, aggravating the previous disorder of their condition. The present increased knowledge of the functions of the laryngeal nerves, and of the symptoms of this disease, appears to render inadmissible the explanation of it given not long since by Dr. H. Ley, who attributed it to paralysis of the pneumogastric nerves occasioned by pressure.—Spasmodic closure of the larynx may occur from other causes. When the rima-glottidis is narrowed, by effusion of fluid into the substance of its walls, it is very liable to be completely closed, by spasmodic action, to which the unduly irritable condition of the mucous membrane will furnish many sources of excitement. Choking, again, does not result so much from the pressure of the food on the air-passages them-

* Chorea is ranked by Dr. M. Hall as a disease of the Spinal System of nerves; but this can scarcely be regarded as a correct determination. It is true that there is considerable irregularity in the ordinary Reflex actions; but the irregularity is still greater in those, to which Volition or Emotion are the stimuli. Moreover, the body is at rest during sleep; and "the Spinal system never sleeps." The frequent origin of the disease in causes which have excited strong mental emotions, and the effect of even moderate excitement of the feelings in greatly aggravating the movements of the body, seem to indicate the connection of this disease with the Sensori-motor system of nerves. Stammering may be regarded as a sort of Chorea affecting the muscles of voice; of this more hereafter (CHAP. VI). In Paralysis Agitans, it may be usually observed, that the voluntary actions are much more affected than the reflex; the latter, indeed, not in general manifesting any disturbance. An interesting and well marked case of this disease has been mentioned to the author by Dr. W. Budd, in which softening was found in the *Crura Cerebri*.

selves, as from the spasmodic action of the larynx, excited by this; and the dislodgement of the morsel by an act of vomiting, is the most effectual means of obtaining relief.—Tenesmus and Strangury are well-known forms of spasmodic muscular contraction, excited by local irritation acting through the Spinal system. The abnormal action which leads to Abortion is frequently excited in the same manner; how far the uterus itself is called into contraction by the ordinary spinal nerves, is a question as yet undecided; but the facts already stated leave no doubt, that stimuli operating on these may act upon it through the Sympathetic, into which their fibres pass (§ 393). It will be borne in mind, however, that, in abortion, as in ordinary parturition, many muscles are called in, to aid the contractions of the uterus, which are strictly under the dominion of the Spinal system.—There is a form of Incontinence of urine, which is very analogous to the morbid action just described; the sphincter has its due power; but the stimulus to the evacuation of the bladder is excessive in strength and degree, owing to the acidity of the urine or other causes. The part of the bladder upon which this appears chiefly to act, is the trigonum (which is well known to be more sensitive to the irritation of calculi, than the rest of the internal surface); and Sir C. Bell advises young persons who suffer during the night from this very disagreeable complaint, to lie upon the belly instead of the back, so that the contact of the urine with the trigonum may be delayed as long as possible.

505. One of the most familiar examples of the pathological excitement of the true Spinal system is the act of *Vomiting*; and, as Dr. M. Hall justly remarks, the special function of this system nowhere receives better illustration. The act may be excited in various ways. Thus, it results from the tickling of the fauces with a feather or with the finger; but if the feather be carried too far down, an act of deglutition is induced instead of vomiting.* In this instance the glosso-pharyngeal, and perhaps also the fifth pair, are the nerves by which the stimulus is conveyed to the Medulla Oblongata. Vomiting, again, may be induced by substances introduced into the stomach; and here the pneumogastric is evidently the excitor. When it takes place as a result of pregnancy, or of some intestinal irritation, the stimulus must be conveyed, either through one of the ordinary Spinal nerves, or through the Sympathetic. But it may also be occasioned by the sight, smell, or taste of any disagreeable object, or by the mere conception of it, or by mental emotion simply. In this case, the stimulus appears to be received by the ganglia of special sense, and to be transmitted by them to the muscles concerned, as by the Spinal Cord or Medulla Oblongata in the former case. When Vomiting is excited by the introduction of emetic substances into the blood, it is probable that their stimulation chiefly operates through the extended plexus of nerves, spread out by the Sympathetic upon the walls of the blood-vessels; but the irritant action of the substance upon the nervous centres may be also concerned.—In regard to the mechanism by which the act of Vomiting is produced, considerable difference of opinion has existed. The old doctrine was, that it was solely occasioned by the contraction of the stomach itself; but Magendie proved that this could not be the case, by substituting a bladder for the stomach of an animal, and then injecting a solution of tartarized antimony into its blood, which immediately caused the emptying of the bladder, by the pressure of the surrounding muscles; these muscles he considered to

* This has been the cause of many accidents. Patients have tickled the fauces with a feather in order to excite vomiting; and, having introduced it too far into the pharynx, it has been drawn out of their fingers by the muscles of deglutition, and carried into the œsophagus. Similar accidents have occurred with the rectum-bougie, and female catheter, as well as with probes, &c., introduced into the male urethra; all the orifices being furnished with a kind of ingestive power, which is clearly the result of Reflex action.

be the diaphragm and abdominal muscles, the conjoint actions of which would be a peculiarity observed in no other instance. By Dr. M. Hall, on the other hand, it is maintained that the act of vomiting is, like the expulsion of the fœtus, urine, fœces, &c., an expiratory effort, modified in its effects by the peculiar condition of the sphincters. It bears, indeed, great resemblance to the act of coughing; differing chiefly in this, that in vomiting, the larynx is closed during the whole operation, whilst it is only closed momentarily in coughing; and also, that in coughing, the cardiac orifice of the stomach is closed, whilst in vomiting it is opened. In this view, the accuracy of which has been proved by experiment, the diaphragm is quite inert.—A curious case has been recorded by Drs. Graves and Stokes,* in which vomiting took place from the stomach of a man, who was found after death to be the subject of a very remarkable change in the relative position of the viscera,—the stomach lying in the thorax, which cavity communicated with the abdomen, by an opening in the diaphragm, giving passage to the œsophagus and duodenum. This case was regarded by its reporters as proving that vomiting might take place by the action of the stomach alone; but it can scarcely be held to justify this conclusion; since, the diaphragm being entirely passive, the abdominal muscles would have the same power of emptying the stomach, as they would possess over the lungs. There can be little doubt, however, that the walls of the stomach participate in the action; for even the œsophagus is thrown into a state of reversed peristaltic movement.

CHAPTER VI.

ON SENSATION, AND THE ORGANS OF THE SENSES.

I.—Of *Sensation in General.*

506. By the term *Sensation* is rightly understood that change in the condition of the mind, by which we become aware of an *impression* made upon some part of the body; or, in a briefer form of expression, it may be defined to be the *consciousness of an impression*. Some physiologists have, it is true, spoken of a *sensation without consciousness*; but it seems very desirable thus to limit the term; since the word *impression* may be very well applied to designate the change produced in the afferent nerves by an external cause, up to the point at which the mind becomes conscious of it. We have seen reason to believe, that the impressions communicated to the Spinal Cord may there excite motor actions, without occasioning true Sensation; and it would seem to be with the Encephalon only, that the Mind possesses the relation necessary for the production of such a change in it. Hence this organ is spoken of as the *Sensorium*. For the reasons already given (§ 435), it seems probable that the ganglia of Special Sensation are rather the essential instruments of this function, than the Cerebral Hemispheres. The afferent nervous fibres, which connect the various parts of the body with the Sensorium, are termed *sensory*. This term has also been applied to those which terminate in the Spinal Cord; but as the impressions which these convey do *not* produce sensations, it seems desirable to avoid thus designating them;

* Dublin Hospital Reports, Vol. v.

and the term *excitor*, proposed by Dr. M. Hall, is much preferable. Every afferent spinal nerve, therefore, is made up of sensory and of excitor fibres; and these may be distributed in very different proportions to different parts. Of the excitor fibres, enough has been already said. Those parts of the body which are endowed with sensory fibres, and impressions on which, therefore, give rise to sensation, are ordinarily spoken of as *sensible*, and different parts are spoken of as sensible in different degrees, according to the strength of the sensation which is produced by a corresponding impression on each.

507. In accordance with what was formerly stated (§ 250) of the dependence of all nervous action on the continuance of the capillary Circulation, especially at the extremities of the fibres, it is found that the sensory nerves are distributed pretty much in the same proportion as the blood-vessels; that is to say, in the non-vascular tissues,—such as the epidermis, hair, nails, cartilage, and bony substance of the teeth,—no nerves exist, and there is an entire absence of sensibility; and in those whose vascularity is trifling, the sensibility is dull, as is the case with bones, tendons, ligaments, fibrous membranes, and other parts whose functions are simply mechanical, and even with serous and areolar membranes. Many of these textures are acutely sensible, however, under certain circumstances; thus, although tendons and ligaments may be wounded, burned, &c., with little or no consciousness of the injury, they cannot be stretched without considerable pain; and the fibrous, serous and areolar tissues, when their vascularity is increased by inflammation, also become extremely susceptible of painful impressions. All very vascular parts, however, do not possess acute sensibility; the muscles, for instance, are furnished with a large supply of blood, to enable them to perform their peculiar function; but they are not sensible in by any means the same proportion. Even the substance of the brain and of the nerves of special sensation, appears to be destitute of this property; and the same may be said of the mucous membranes, lining the interior of the several viscera, which, in the ordinary condition, are much less sensible than the membranes which cover those viscera, although so plentifully supplied with blood for their especial purposes. The most sensible of all parts of the body, is the Skin, in which the sensory nerves spread themselves out into a minute net-work; and even of this tissue, the sensibility differs greatly in different parts. The organs of *special* sensation are, by the peculiar character of the nerves with which they are supplied, rendered sensible to impressions of a particular kind: thus, the eye is sensible to light, the ear to sound, &c.; and whatever amount of *ordinary* sensibility they possess, is dependent upon other sensory nerves. The eye, for example, contrary to the usual notions, is a very insensible part of the body, unless affected with inflammation; for though the mucous membrane which covers its surface, and which is prolonged from the skin, is acutely sensible to some kinds of impressions, the interior is by no means so, as is well known to those who have operated much on the eye. And there are many parts of the body, that are supplied with the common sensory nerves which convey to the mind impressions of particular kinds, with much greater readiness than they communicate those of a different description.

508. It appears, then, that the vascularity of a part is an essential condition of its sensibility; but it does not follow that a tissue should be peculiarly sensible, because it is highly vascular; since its large supply of blood may be required for other purposes. It is not simple vascularity, however, which is necessary, but rather an active capillary circulation; any cause which retards this, deadens the sensibility, as is well seen in regard to cold; and, on the other hand, an increase in its energy produces a corresponding increase in the sensibility, as is peculiarly evident in the active congestion which usually precedes inflammation. Acute sensibility to external impressions may arise,

however, not only from abnormal activity of the circulation in the organ or part itself, but from the same condition affecting that part of the sensorium in which the impressions are received. Thus in active congestion and inflammation of the brain, the most ordinary external impressions produce sensations of an unbearable violence; and there are some peculiar conditions of the nervous system, known under the name of hysterical, in which the patients manifest the same discomfort, even when the circulation is in a feeble, rather than an excited state. It is remarkable that the sensibility of the mucous membranes lining the internal organs, is less exalted by the state of inflammation, than is that of most other parts; and in this arrangement we may trace a wise and beneficent provision; since, were it otherwise, the functions necessary to life could not be performed without extreme distress, with a very moderate amount of disorder in the viscera. If a joint is inflamed, we can give it rest; but to the actions of the alimentary canal we can give little voluntary respite.

509. The feelings of Pain or Pleasure, which are connected with particular sensations, cannot (for the most part at least) be explained upon any other principle than that of the necessary association of these feelings, by an original law of our nature, with the sensations in question. As a general rule, it may be stated, that the *violent* excitement of *any* sensation is disagreeable, even when the same sensation in a moderate degree may be a source of extreme pleasure. This is the case alike with those impressions, which are communicated through the organs of sight, hearing, smell and taste, as with those that are received through the nerves of common sensation; and there can be no doubt that the final cause, or purpose, of the association of painful feelings with such violent excitement, is to stimulate the individual to remove himself from what would be injurious in its effects upon the system. Thus, the pain resulting from violent pressure on the cutaneous surface, or from the proximity of a heated body, gives warning of the danger of injury, and excites mental operations destined to remove the part from the influence of the injurious cause; and this is shown by the fact, that loss of sensibility is frequently the indirect occasion of severe lesions,—the individual not receiving the customary intimation that an injurious process is taking place. Instances have occurred, in which severe inflammation of the membrane lining the air-passages has resulted from the effects of ammoniacal vapours, introduced into them during a state of syncope,—the patient not receiving that notice of the irritation, which would, in an active condition of his nervous system, have prevented him from inhaling the noxious agent.

a. The following case, recorded in the "Journal of a Naturalist," affords a remarkable instance of this general fact. The correctness of the statement having been called in question, it was fully confirmed by Mr. Richard Smith, the late senior surgeon of the Bristol Infirmary, under whose care the sufferer had been. "A travelling man, one winter's evening, laid himself down upon the platform of a lime-kiln, placing his feet, probably numbed with cold, upon the heap of stones, newly put on to burn through the night. Sleep overcame him in this situation; the fire gradually rising and increasing, until it ignited the stones upon which his feet were placed. Lulled by the warmth, the man slept on; the fire increased until it burned one foot (which probably was extended over a vent-hole) and part of the leg above the ankle entirely off, consuming that part so effectually, that a cinder-like fragment was alone remaining,—and still the wretch slept on! and in this state was found by the kiln-man in the morning. Insensible to any pain, and ignorant of his misfortune, he attempted to rise and pursue his journey, but missing his shoe, requested to have it found; and when he was raised, putting his burnt limb to the ground to support his body, the extremity of his leg-bone, the tibia, crumbled into fragments, having been calcined into lime. Still he expressed no sense of pain, and probably experienced none; from the gradual operation of the fire, and his own torpidity during the hours his foot was consuming. This poor drover survived his misfortunes in the hospital about a fortnight; but the fire having extended to other parts of his body, recovery was hopeless."

510. It is a general rule, with regard to all sensations, that their intensity is much affected by habit; being greatly diminished by frequent and continual repetition. This is not the case, however, with regard to those sensations to which the *attention* is peculiarly directed; for these lose none of their acuteness by frequent repetition; on the contrary, they become much more readily cognizable by the mind.—We have a good example of both facts, in the effects of sounds upon a sleeping person. If they are sounds which he has been accustomed to hear, and to disregard, they may not awake him, however loud they be: thus, the strokes of a forge-hammer, the firing of guns, the shouts of a multitude, or the loudest music, may neither prevent the accession of sleep, nor arouse the already unconscious sleeper; indeed, it oftener happens that individuals are prevented from sleeping by the *want* of some accustomed sound, or are awake by its *cessation*. On the other hand, a very slight sound, the nature of which excites the attention, is sufficient to prevent sleep; thus, the buzz of a single musquito, in the stillness of the night, is most effectual in dispelling repose;—and, in like manner, a person in a state of the profoundest unconsciousness may be aroused by a whisper, if the sound be one to which he has been accustomed to pay regard.

a. The following circumstance has been communicated to the Author by a Naval Officer of high rank:—When a young man he was serving as signal-lieutenant under Lord Hood; and being desirous of obtaining the favourable notice of his commander, he devoted himself to his duty with the greatest energy and perseverance, often remaining on deck nineteen hours out of the twenty-four, with his attention continually on the stretch. During the few hours which he spent in repose, his sleep was so profound, that no noise of an ordinary kind, however loud, would awake him. But if the word “signal” was softly uttered in his ear, he was instantly aroused.

511. The general law, that Sensations, not attended to, are blunted by frequent repetition, may perhaps be connected with certain other general facts, which lie under the observation of every one. It is well known, that the vividness of sensations depends rather on the degree of *change* which they produce in the system, than on the absolute amount of the impressing cause; and this is alike the case with regard to the special and the ordinary sensations. Thus, our sensations of heat and cold are entirely governed by the previous condition of the parts affected; as is shown by the well-known experiment, of putting one hand in hot water, the other in cold, and then transferring both to tepid water, which will seem cool to one hand, and warm to the other. Every one knows, too, how much more we are affected by a warm day at the commencement of the summer, than by an equally hot day later in the season. The same is the case in regard to light and sound, smell and taste. A person going out of a totally dark room into one moderately bright, is for the time painfully impressed by the light, but soon becomes habituated to it; whilst another, who enters it from a room brilliantly illuminated, will consider it dark and gloomy. Those who are constantly exposed to very loud noises, become almost unconscious of them, and are even undisturbed by them in illness; and the medical student well knows, that even the effluvia of the dissecting-room are not perceived, when the organ of smell is habituated to them, although an intermission of sufficient length would, in either instance, occasion a renewal of the first unpleasant feelings, when the individual is again subjected to the impression.

512. Again, it is a well-known fact, that impressions made upon the organs of sense continue for a time, after the cause of the impression has ceased. It is in this manner that a musical tone, which seems perfectly continuous, results from a series of consecutive vibrations, following each other with a certain rapidity; and that a line or circle of light is produced by a luminous body moving with a certain velocity. Now there is reason to believe that

changes, of which the effects thus transiently remain upon the nerves of sense, are more permanently impressed upon the Sensorium; since, as formerly shown (§ 491), we can only in this manner account for the phenomena of Memory, and for the effects produced upon this power, by material changes in the brain. Hence, the diminution in the force of sensations, which is the consequence of their habitual recurrence, may be considered as resulting from these two general facts,—the persistence of the impression made by them upon the sensorium,—and the consequent absence of a *change* in *its* state, when a sensory impression is brought to it, which is of the same nature with one already registered there: the degree in which the consciousness is excited, being dependent, as just stated, not upon the absolute degree of the impressing cause, but upon the amount of *change* which it produces in the sensorial apparatus. In this respect there is a perfect conformity between the law of sensation, and that of muscular contraction; for stimuli which excite the latter, usually lose their force in proportion to the frequency of their repetition. Indeed, both may be considered as results of the more general laws of vitality; for the actions of other tissues follow the same rule, as is shown by the *tolerance*, that may be gradually established in the system, of medicinal agents, poisons, &c., which would have at first produced the most violent effects, when given in the same amount.

513. It is curious, also, that the feelings of Pain or Pleasure, which unaccustomed sensations excite, are often exchanged for each other, when the system is habituated to them; this is especially the case, in regard to impressions communicated through the organs of smell and taste. There are many articles in common use among mankind,—such as Tobacco, Fermented Liquors, &c., the use of which cannot be said to produce a natural enjoyment, since it is at first unpleasant to most persons; and yet it first becomes tolerable, then agreeable; and at last the want of them is felt as a painful privation, and the stimulus must be applied in an increasing degree, in order to produce the usual effect.

514. It is through the medium of Sensation, that we acquire a knowledge of the material world around us; and that its changes excite mental operations in ourselves. The various kinds or modes of Sensation excite in us various ideas regarding the properties of matter; and these properties are known to us, only through the changes which they produce in the several organs. Thus a man totally blind from birth can form no idea of the nature of light or colours; nor could one completely deaf have any just conception of musical tones. It is well known that instances exist, in which, from some imperfection of the organization, there is an incapacity for distinguishing colours or musical tones, whilst there is no want of sensibility to light or sound; and that some persons are naturally endowed with a much greater range of the sensory faculties, than others possess. Hence it does not seem at all improbable, that there are properties of matter, of which none of *our* senses can take immediate cognizance; and which other beings might be formed to perceive, in the same manner as *we* are sensible to light, sound, &c. Thus, it is well known, that many animals are affected by atmospheric changes, in such a manner, that their actions are regarded by Man as indications of the probable state of the weather; and the same is the case in a less degree with some of our own species; who are peculiarly susceptible of the same influences. Now the most universal of all the qualities or propensities of matter,—that, in fact, on which our notion of it is founded,—is *resistance*; and it is this quality, of which the knowledge seems most universally diffused throughout the Animal kingdom. In the lowest tribes, we find that *contact*, between their surface and some material body, is required to produce sensa-

tion; and beings which cannot be made conscious, in this manner, of the existence of something external to themselves, do not deserve to be ranked in the Animal kingdom. Our difficulty lies (as heretofore remarked, § 1), in ascertaining what are to be regarded, in such beings, as unequivocal indications of consciousness. Those animals which are fixed to one spot, can have few other ideas of matter than this most general one; but in those which have the power of locomotion, the general sensibility of the surface doubtless communicates to them some notion of the character of the body over which they move, in the same manner as we learn it by passing the hand over its exterior. We shall presently see, however, that the idea of the *shape* of a body which we form from the touch, results from a very complex process; which animals of the lowest grade can scarcely be supposed to exercise. There can be no doubt that, next to the mere sense of resistance, sensibility to *temperature* is the most universally diffused through the Animal kingdom; and probably the consciousness of *luminosity* is the next in the extent of its diffusion. There is good reason to believe, from observation of their habits, that many animals are susceptible of the influence, and are directed by the guidance of light; whilst their organs are not adapted to receive true visual impressions, or to form optical images; and such would seem to be the function of the red spots, frequently seen on prominent parts of Animalcules, the lower Articulata and Mollusca, and even of some Radiata. Wherever these are of sufficient size to allow their structure to be examined, they are found to be largely supplied with nerves, but to be destitute of the peculiar organization which alone constitutes a true *eye*. The sense of Taste may be considered as a refined modification of that of Touch; and it is probable that this exists very low down in the animal scale, being obviously of great importance in the selection of food; but the Anatomist has no means of ascertaining where this refinement exists, and where it does not; since the organs of taste and touch are so similar. The sense of Hearing does not seem to be distinctly present among the Invertebrate animals, except in such as approach most nearly to the Vertebrata; it is not improbable, however, that sonorous vibrations may produce an effect upon the system of those animals which do not receive them as *sound*; and this would appear, from a fact subsequently to be mentioned (§ 526), to be not improbably the case, with regard especially to aquatic animals. The sense of Smell, which is concerned with one of the least general properties of matter, appears to be the least widely diffused among the whole; being only possessed in any high degree by Vertebrated animals, and being but feebly present in a large proportion of these.

515. Besides the various kinds of sensibility which have been just enumerated, there are others which are ordinarily associated together, along with the sense of material resistance (and its several modifications), and the sense of temperature, under the head of Common Sensation; but several of them, especially those which originate in the body itself, can scarcely be regarded in this light. Such are the feelings of Hunger and Thirst; that of Nausea; that of distress resulting from suspended aeration of the blood; that of "sinking at the stomach," as it is vulgarly but expressively described, which results from strong mental emotion; that of the venereal excitement, and perhaps some others. Now in regard to all these, it is impossible in the present state of our knowledge to say, whether their peculiarity results from the particular constitution of the nerves that receive and convey them, or only from a modification in the impressing causes, and in the mode in which they operate. Thus we have no evidence that the nervous fibrils, which convey from the lungs the sense of distress resulting from deficient aeration, may not be of a different character from those which convey from the surface of the air-pas-

sages the sense of the contact of a foreign body. But as we know that all the trunks, along which these peculiar impressions travel, do minister to ordinary sensation, whilst the nerves of truly special sensation are not sensible to common impressions, it is evident that the probability is in favour of the identity of the fibres, which minister to these sensations, with those of the usual sensory character. For the sense of temperature, however, it is not by any means certain that a special set of fibres does not exist; for many cases are on record, in which it has been lost, whilst the ordinary sense of tact remained; and it is sometimes preserved, when the anæsthesia is in other respects complete.

516. With regard to all kinds of Sensation it is to be remembered, that the change of which the mind is informed, is *not* the change at the peripheral extremities of the nerves, but the change communicated to the sensorium; hence it results, that external agencies can give rise to no kind of sensation, which cannot also be produced by internal causes, exciting changes in the condition of the nerves in their course. This very frequently happens in regard to the senses of sight and hearing; flashes of light being seen, and ringing sounds in the ears being heard, when no external stimulus has produced such impressions. The production of odorous and gustative sensations from internal causes, is perhaps less common; but the sense of nausea is more frequently excited in this manner, than by the direct contact of the nauseating substance with the tongue or fauces. The various phases of common sensibility often originate thus; and it is an additional evidence in favour of the distinctness of the fibres which convey the impressions of temperature, that these are frequently affected,—a person being sensible of heat or of chilliness in some part of his body, without any real alteration of its temperature,—whilst there is no corresponding affection of the tactual sensations. The most common of the internal causes of these *subjective* sensations (as they have been termed, in contradistinction to the *objective*, which result from a real material object), is congestion or inflammation; and it is interesting to remark that this cause, operating through each nerve, produces in the sensorium the changes to which that nerve is usually subservient. Thus, congestion in the nerves of common sensation gives rise to feelings of pain or uneasiness; but when occurring in the retina and optic nerve it produces flashes of light; and in the auditory nerve it occasions “a noise in the ears.”—It may be observed, also, of some external causes, that they may excite changes in the sensorium through several different channels; and that in each case the sensation is characteristic of the particular nerve, on which the impression is made. Thus pressure, which produces through the nerves of common sensation the feeling of resistance, is well known to occasion, when exerted on the eye, the sensation of light and colours; and, when made with some violence on the ear, to produce tinnitus aurium. It is not so easy to excite sensations of taste and smell, by mechanical irritation; and yet, as Dr. Baly* has shown, it may readily be accomplished in regard to the former. The sense of nausea may be easily produced, as is familiarly known, by mechanical irritation of the fauces. The stimulus of Electricity still more completely possesses the power of affecting all the sensory nerves, with the changes which are peculiar to them; for, by proper management, an individual may be made conscious at the same time of flashes of light, of distinct sounds, of a phosphoric odour, of a peculiar taste, and of pricking sensations, all excited by the same cause, the effects of which are modified, according to the respective peculiarities of the instruments through which it operates.—But although there are some stimuli which can produce sensory impressions on all the nerves of

* Translation of Müller's Physiology, p. 1062, *note*.

sensation, it will be found that those, to which any one organ is peculiarly fitted to respond, produce little or no effect upon the rest. Thus the ear cannot distinguish the slightest difference between a luminous and a dark object. A tuning-fork, which, when laid upon the ear whilst vibrating, produces a distinct musical tone, excites no other sensation when placed upon the eye than a slight jarring feeling. The most delicate touch cannot distinguish a substance which is sweet to the taste from one which is bitter; nor can the taste (if the communication between the mouth and the nose be cut off) perceive anything peculiar in the most strongly odoriferous bodies.

517. It may hence be inferred that no nerve of *special* sensation can, by any possibility, take on the function of another. How far the nerves of *common* sensation, can, under any circumstances, perform the offices usually delegated to those of special sense, we are not yet in a condition to determine. Comparative Anatomy seems to show that, in the lowest animals in which the rudiments of eyes can be detected, there is no distinction between the nerves proceeding to these organs, and the rest; and there would appear some ground for the belief that, as in other cases, the special organs of sensibility are gradually elaborated, in ascending the Animal scale, from the more general apparatus, and are not merely superadded to it. Hence we may conceive the possibility (though there is no proof of the fact) that states of the system might occur, in which a change in the common sensory nerves might produce the sensation of light, sound, &c. But it is quite impossible (so far at least as our present knowledge of physical phenomena permits us to decide upon the impossibility of anything) that distinct visual impressions should be communicated to a nerve, except through the mediation of such an optical instrument as the eye; or distinct sonorous impressions, except through such an acoustic instrument as the ear. Hence we must receive with the greatest caution the wonderful accounts of transference of sensation, many of which have undoubtedly been the offspring of deception. Still it may be objected that, since we are so totally destitute of real knowledge, as to the mode in which vision is ordinarily produced by inverted images upon the retina, we have no right to assert that it *may not* take place in some other way; and perhaps this objection should lead us to consider the phenomenon rather as *extremely improbable*, than as *impossible*. But the improbability may be compared to that of a stone ascending like a balloon, or a piece of lead floating on the water; for we have no more knowledge of the ultimate cause of that which we term the force of Gravitation, than we have of the nature of Sensation.

518. The peculiar aptitudes of the different Sensory nerves, to receive and convey impressions of various kinds, must be regarded as the result of properties inherent in themselves; just as we consider the difference between the afferent nerves in general, and the motor nerves, to be one belonging to their own constitution. But it is probable that there are also different localities in the Sensorium, in which the changes to which they give rise are performed. This may be judged of from the fact, that the phenomena of *subjective* sensation frequently originate in peculiar conditions of the encephalon itself, and not in the nervous trunks or organs of sense; thus, in dreaming, we have frequently very vivid pictures of external objects presented to our minds; and we sometimes distinctly hear voices and musical tones, or have perceptions (though this is less common) of tastes and odours. The phenomena of spectral illusions are very nearly connected with those of dreaming; both may be in some degree influenced by external causes, acting upon the organs of sensation, which are misinterpreted (as it were) by the mind, owing to its state of imperfect operation; but both also may entirely originate in the central organs. There seems to be no difference, in the feelings of the

individual, between the sensations thus originating, and those which are produced in the usual manner; for we find that, unless otherwise convinced by their own reason, persons who witness spectral illusions believe as firmly in the reality of the objects that come before their minds, as if the images of those objects were actually formed on their retinae. This is another proof, if any were wanting, that the organ of sense, and the nerve belonging to it, are but the instruments by which certain changes are produced in the sensorium; of which changes, and not of the immediate impression of the object, the sensation really consists. It seems to be by an innate law of our constitution, that these subjective sensations, whether originating in the central organs, or in the course of the nervous trunks, should be referred by the mind to the ordinary situations of the peripheral terminations of those nerves; even though these should not exist, or should be destitute of the power of receiving impressions. Thus after amputations, the patients are for some time affected with sensations (originating probably in the cut extremities of the nerves), which they refer to the removed extremities; the same has been noticed in regard to the eye, as well when it has been completely extirpated, as when its powers have been destroyed by disease. The effects of the Taliacotian operation also exhibit the operation of this law in a curious manner; for until the flap of skin, from which the new nose is formed, obtains vascular and nervous connections in its new situation, the sensation produced by touching it is referred to the forehead. Another interesting illustration of it may be obtained by the following very simple experiment:—if the middle finger of either hand be crossed behind the fore-finger, so that its extremity is on the radial side of the latter, and the ends of the two fingers thus disposed be rolled over a marble, pea, or other round body, a sensation will be produced, which, if uncorrected by reason, would cause the mind to believe in the existence of two distinct bodies; this is due to the impression being made at the same time upon the radial side of the fore-finger, and the ulnar side of the middle finger,—two joints which, in the natural position, are at a considerable distance.

519. The acuteness of particular sensations is influenced in a remarkable degree by the attention they receive from the mind. If the mind be entirely inactive, as in profound sleep, no sensation whatever is produced by ordinary impressions; on the other hand, when the mind is from any cause strongly directed upon them, impressions very feeble in themselves produce sensations of even painful acuteness. Every one knows how much a slight itching of some part of the surface may be magnified, by the direction of the thoughts to it; whilst as soon as they are forced by some stronger impression into another channel, the irritation is no longer felt. Every one is aware how vividly sounds are perceived, when they break in upon the stillness of the night; being increased in strength, not only by the contrast, but by absorbing the whole attention. An interesting experiment is mentioned by Müller, which shows how completely the mind may be unconscious of impressions communicated to it by one organ of sense, when occupied, even without a distinct effort of the will, by those received through another. If we look at a sheet of white paper through two differently-coloured glasses at the same time—one being placed before each eye,—the resulting sensation is seldom that of a mixture of the colours: if the experiment be tried with blue and yellow glasses, for example, we do not see the paper of an uniform green; but the blue is predominant at one moment, and the yellow at another; or blue nebulous spots may present themselves on a yellow field, or yellow spots on a blue field. We perceive from this experiment, that the attention may not only be directed to the impressions made on either retina, to the complete exclusion of those of

the other, but it may be directed to those made on particular spots of either. This may be noticed, again, in the process by which we make ourselves acquainted with a landscape or a picture; if our attention be directed to the whole field of vision at once, we see nothing distinctly; and it is only by abstracting ourselves from the contemplation of the greater part of it, and by directing our attention to smaller portions in succession, that we can obtain a definite conception of the details. The same is the case in regard to auditory impressions; and here the power of attention, in causing one sensation or series of sensations to predominate over others which are really more intense, is often most remarkably manifested. When we are listening to a piece of music played by a large orchestra, for example, we may either attend to the combined effect of all the instruments, or we may single out any one part in the harmony, and follow this through all its mazes; and a person with a practised ear (as it is commonly but erroneously termed, it being not the ear but the mind that is practised), can even distinguish the sound of the weakest instrument in the whole band, and can follow its strain through the whole performance. This attention to a single element can only be given, however, by withdrawing the mind from the perception of the rest; and a musician who thus listens, will have very little idea of the rest of the harmonic parts, or of the general effect. In fact, when the mind is thus directed, by a strong effort of the will, into a particular channel, it may be almost considered as unconscious *quoad* any other impressions.

520. The effects of this principle are manifested in regard to the sensations which originate within the system; as well as in respect to those which are excited by external impressions. Every one is aware how difficult it is to keep the body perfectly quiescent,* especially when there is a particular motive for doing so, and when the attention is strongly directed to the object. This is experienced even whilst a Photogenic likeness is being taken, when the position is chosen by the individual, and a support is adapted to assist him in retaining it; and it is still more strongly felt by the performers in the Tableaux Vivans, who cannot keep up the effort for more than three or four minutes. Now it is well known that, when the attention is strongly directed to an entirely different object (when we are listening, for example, to an eloquent sermon, or an interesting lecture), the body may remain perfectly motionless for a much longer period; the uneasy sensations, which would otherwise have occasioned the individual to change his position, not being felt; but no sooner is the discourse ended, than a simultaneous movement of the whole audience takes place, every one then becoming conscious of some discomfort, which he seeks to relieve. This is the case, also, in regard to the respiratory sensation; in general it may be observed, that the usual reflex movements are not enough for the perfect aeration of the blood, and that a more prolonged inspiration prompted by an uneasy feeling, takes place at intervals; but under such circumstances as those just alluded to, this feeling is not experienced, until the attention ceases to be engaged by a more powerful stimulus, and then it manifests itself by the deep inspirations which accompany, in almost every individual, the general movement of the body.

521. It is curious that the constant direction of the attention to internal sensations of a *subjective* kind, should sometimes occasion actual disorder of the parts to which these sensations are referred; and yet this seems the only way of accounting for some of the phenomena of disease. Sometimes the cause of the sensation may exist in the trunk of the nerve, in some part of its course; whilst in other instances, it may be confined to the sensorium. Pain

* Of course the movements of respiration and winking are left out of the question.

of the testicle, for example, may be occasioned by irritation having its seat in the lower part of the spine, the organ itself being perfectly sound; yet if that pain continue, it may become diseased. The following are some very interesting remarks on this subject, from the able pen of Dr. Holland.* “There is cause to believe the action of the heart to be quickened or otherwise disturbed, by the mere centering of consciousness upon it, without any emotion or anxiety.” This is especially the case where its impulses are irregular, or are so loud as to be audible. “The same may be said of the parts concerned in respiration. If this act be expressly made the subject of consciousness, it will be felt to undergo some change; generally to be retarded at first, and afterwards quickened.” “The act of swallowing is manifestly rendered more difficult, by the attention being fixed upon it; and the same cause will often be found to render articulation less distinct, especially when there exists already some impediment to the function. A similar direction of consciousness to the region of the stomach, creates in this part a sense of weight, oppression, or other less definite uneasiness; and, when the stomach is full, appears greatly to disturb the due digestion of the food. The state and action of the bowels are much influenced by the same cause.” A peculiar sense of weight and restlessness approaching to cramp, is felt in a limb, to which the attention is particularly directed. “The attention concentrated, for so by an effort of will it may be, on the head or sensorium, gives certain feelings of tension and uneasiness, caused possibly by some change in the circulation of the part; though it may be an effect, however difficult to be conceived, on the nervous system itself. Persistence in this effort, which is seldom indeed possible beyond a short time without confusion, produces results of much more complex nature, and scarcely to be defined by any common terms of language.” These phenomena have an evident affinity, on the one hand, with the exaltation of external or *objective* sensations, to which the attention is peculiarly directed; and on the other with those of several morbid conditions. The explanation of them all is probably to be sought in some change in the circulation of the part, to which the sensation is referred. Thus the hypochondriac patient, “in fixing his consciousness with morbid intentness on certain organs, creates not merely disordered sensations, but often also disordered actions in them. There may be palpitation of the heart, hurried or choked respiration, flatulence and other distress of stomach, irritation of the bladder; all arising from this morbid direction of attention to the organs in question.” In hysteria, again, “the instances are frequent, of attacks brought on by the mere expectation of them; or by irritation; or occasionally even a sort of morbid solicitation of the organs to these singular actions.” These facts go a long way to explain the phenomena of Mesmerism, many of which are obviously to be referred to the exaggerated operation of the same principle. (See Appendix.)—We now proceed to consider in more detail the functions of the several Organs of the Senses, and shall commence with that of the most general character.

2. Sense of Touch.

522. By the sense of Touch, as commonly understood, is meant that modification of the common sensibility of the body, of which the Cutaneous surface is the especial seat. It derives its peculiar power simply from the large amount of sensory nervous fibres, which are distributed in its substance; and especially through the terminations (or rather the origins) of these in the *papillæ*, which are little elevations of the surface of the cutis, easily perceptible

* Medical Notes and Reflections, Chap. v.

by the aid of a lens, and each

Fig. 162.

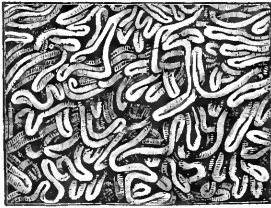

Capillary net-work at margin of lips.

chiefly composed of a vascular loop overlapping the extremity of the nervous fibril. The precise arrangement of the nerve-fibres in the cutaneous papillæ, has not been indisputably ascertained; but the opinion that they form loops (Fig. 119) is the one most generally adopted. The number of these papillæ within any given area, pretty closely corresponds with the degree of sensibility of that part of the surface; thus we find them most abundant on the hands, especially towards the points of the fingers, and on the lips and tongue. In some animals, especially those of the Feline tribe, the long *vibrissæ* (commonly termed whiskers) evidently

minister to sensation; and it has been demonstrated that their pulps are largely supplied with nerves from the fifth pair. Some interesting observations have been made by Prof. Weber, on the sensibility of different parts of the skin. His mode of ascertaining this, was to touch the surface with the legs of a pair of compasses, the points of which were guarded with pieces of cork; the eyes being closed at the time, the legs were approximated to each other, until they were brought within the smallest distance, at which they could be felt to be distinct from one another. The following are some of the results of the experiments. With the extremities of the fingers and the point of the tongue, the distance could be distinguished most easily in the longitudinal direction; on the dorsum of the tongue, the face, neck, and extremities, the distance could be recognized best when the points were placed transversely.

Point of middle finger	$\frac{1}{8}$ of a line	Mucous Membrane of gums	9 lines
Point of tongue	$\frac{1}{2}$ of a line	Lower part of forehead	10 "
Palmar surface of third finger	1 line	Lower part of occiput	12 "
Red surface of lips	2 lines	Back of hand	14 "
Palmar surface of middle finger	2 "	Neck, under lower jaw	15 "
Dorsal surface of third finger	3 "	Vertex	15 "
Tip of the nose	3 "	Skin over Patella	16 "
Dorsum and edge of tongue	4 "	———— Sacrum	18 "
Part of lips covered by skin	4 "	———— acromion	18 "
Palm of hand	5 "	Dorsum of foot	18 "
Skin of cheek	5 "	Skin over sternum	20 "
Extremity of great toe	5 "	Skin beneath occiput	24 "
Hard palate	6 "	Skin over spine, in back	30 "
Dorsal surface of forefinger	7 "	Middle of the arm	30 "
Dorsum of hand	8 "	———— thigh	30 "

It is curious that the distance between the legs of the compasses seemed to be greater (although really so much less), when it was felt by the more sensitive parts, than when it was estimated by parts of less distinct sensibility. As a general fact, it seems that the sensibility of the trunk is greater on the median line, both before and behind, and less at the sides. Differences of temperature, and the weight of bodies, were, according to Prof. Weber's observations, most accurately recognized at the parts, which were determined to be most sensible by the foregoing method of inquiry.

523. As already stated (§ 514), the only idea communicated to our minds by the sense of Touch, when exercised in its simplest form, is that of Resistance; but when the sensory surface and the substance touched are made to change their place in regard to each other, we obtain the additional notion of Extension or Space. By the various degrees of resistance which the sensory surface encounters, we estimate the hardness or softness of the body; but in this we

are assisted by the muscular sense (§ 433), which makes us conscious of the degree of pressure we are employing. By the impressions made upon the papillæ, during the movement of the tactile surface over that which is being examined, the roughness, smoothness, or other peculiar characters, of the latter are estimated. Our knowledge of *form*, however, is a very complex process, requiring not merely the exercise of the sense of touch, but also great attention to the muscular sensations. It is chiefly, as formerly remarked, in the variety of movements of which the hand of Man is capable, that it is superior to that of any other animal; and it cannot be doubted that this affords a very important means of acquiring information in regard to the external world, and especially of correcting many vague and fallacious notions, which we should derive from the sense of Sight, if used alone. On the other hand, it must be confessed, that our knowledge would have a very limited range, if this sense were the only medium, through which we could acquire ideas. It is probably on the sensations communicated through the touch, that the idea of the material world, as something external to ourselves, chiefly rests; but this idea is by no means a direct result of these sensations, being rather an instinctive or intuitive perception excited by them. Every person who directs the least attention to the subject must perceive, how completely different are those notions of the primary or elementary properties of matter, which we base upon the information thus communicated to us, from the sensations themselves; and, as Dr. Alison has justly remarked, "a decisive proof of this being the true representation of this part of our mental constitution, is obtained by attending to the idea of extension or space; which is undoubtedly formed during the exercise of the sense of touch; and is no sooner formed, than it 'swells in the human mind to Infinity,' to which certainly no human sensation can bear any resemblance."

524. That the conditions under which certain of the modifications of common sensation operate, are in some respects different from those of ordinary Touch, is very easily shown. Thus, the feeling of tickling is excited most readily in parts, which have the least tactual sensibility,—the armpits, flanks, and soles of the feet; whilst in the points of the fingers it cannot be excited. Moreover, the nipple is very moderately endowed with ordinary sensibility; yet by a particular kind of irritation, a very strong feeling may be excited through it. Again, in regard to temperature, it is remarked by Weber, that the left hand is more sensitive than the right; although the sense of touch is undoubtedly the most acute in the latter. He states that, if the two hands, previously of the same temperature, be plunged into separate basins of warm water, that in which the left hand is immersed will be felt as the warmest, even though its temperature is somewhat lower than that of the other. In regard to the sensations of heat and cold, he points out another curious fact,—that a weaker impression made on a large surface, seems more powerful than a stronger impression made on a small surface; thus, if the forefinger of one hand be immersed in water at 104° , and the whole of the other hand be plunged in water at 102° , the cooler water will be thought the warmer; whence the well-known fact, that water in which a finger can be held, will scald the whole hand. Hence it also follows, that minute differences in temperature, which are imperceptible to a single finger, are appreciated by plunging the whole hand into the water; in this manner, a difference of one-third of a degree may readily be detected, when the same hand is placed successively in two vessels. The judgment is more accurate, when the temperature is not much above or below the usual heat of the body; just as sounds are best discriminated, when neither very acute nor very grave.

525. The improvement in the sense of Touch, in those persons whose dependence upon it is increased by the loss of other senses, is well known; this

is doubtless to be in part attributed (as already remarked) to the increased attention which is given to the sensations, and in part to an increased development of the tactile organs themselves, resulting from the frequent use of them. The case of Saunderson, who, although he lost his sight at two years old, became Professor of Mathematics at Cambridge, is well known; amongst his most remarkable faculties, was that of distinguishing genuine medals from imitations, which he could do more accurately than many connoisseurs in full possession of their senses. The process of the acquirement of the power of recognizing elevated characters by the touch, is a remarkable example of this improveability. When a blind person first commences learning to read in this manner, it is necessary to use a large type; and every individual letter must be felt for some time, before a distinct idea of its form is acquired. After a short period of diligent application, the individual becomes able to recognize the combinations of letters in words, without forming a separate idea of each letter; and can read line after line, by passing the finger over each, with considerable rapidity. Now when this power is once thoroughly acquired, it is found that the size of the type may be gradually diminished; and this seems to indicate, that the sensations themselves are rendered more acute, by the frequent application of them in this direction. As an instance of the correct notions which may be conveyed to the mind, of the forms and surfaces of a great variety of objects, and of the sufficiency of these notions for accurate comparison, the Author may mention the case of a blind friend of his own, who has acquired a very complete knowledge of Conchology, both recent and fossil; and who is not only able to recognize every one of the numerous specimens in his own Cabinet, but to mention the nearest alliances of a Shell previously unknown to him, when he has thoroughly examined it by his touch. Many instances are on record, of the acquirement, by the blind, of the power of distinguishing the colours of surfaces, which were similar in other respects; and, however wonderful this may seem, it is by no means incredible. For it is to be remembered that the difference of colour depends upon the position and arrangement of the particles composing the surface, which render it capable of reflecting one ray whilst it absorbs all the rest; and it is quite consistent with what we know from other sources, to believe that the sense of Touch may become so refined, as to communicate a perception of such differences.

526. The examples of peculiar acuteness of this sense, which we occasionally meet with among the lower animals, are very interesting, when viewed in connection with its improveability in Man. It was found by Spallanzani, that Bats, when deprived of sight, and (as far as possible) of hearing and smelling also, still flew about with equal certainty and safety, avoiding every obstacle, passing through passages only just large enough to admit them, and flying about places previously unknown, with the most unerring accuracy, and without coming into collision with the objects near which they passed. He also stretched threads in various directions across the apartment, with the same result. So astonished was he at these curious facts, that he was led to attribute the phenomenon to the possession of a sixth sense, unknown to Man. Cuvier was the first to appreciate the real value of these experiments, as affording a proof of the existence of the most exquisite tactile sensibility, over the whole surface of the flying membrane; the naked surface and delicate structure of which, appear well adapted to constitute the seat of so important a function. From this view, therefore, it would appear that it is by means of the pulsation of the wings on the air, that the propinquity of solid bodies is perceived, through the manner in which the air reacts on their surface. It is curious that the instance which (so far as we at present know) is most analogous to this, should be met with among the inhabitants of the deep. It is a fact well

known to Whale-fishers, especially to those who pursue the Spermaceti Whale, that these animals have the power of communicating with each other at great distances. It has often been observed, for example, that when a straggler is attacked, at the distance of several miles from a shoal, a number of its fellows bear down to its assistance, in an almost incredibly short space of time. It can scarcely be doubted, then, that the communication must be made through the medium of the vibrations of the water, excited by the struggles of the animal, or perhaps by some peculiar movements especially designed for this purpose, and propagated through the fluid to the large cutaneous surface of the distant Whales; and this idea is fully confirmed by the fact, that the nerves which proceed to the skin, pass through the inner layers of blubber with scarcely any subdivision, but spread out into a network of extreme minuteness, as soon as they arrive at the surface.

3. Sense of Taste.

527. That this sense may be really considered as a peculiar modification of that of Touch, appears from several considerations. In the first place, the *actual contact* of the object of sense, with the organ through which the impression is received, is here necessary; and this is the case in regard to no other sense. Moreover the intimate structure of the organ is nearly the same in both instances. Again, it appears from the considerations formerly alluded to (§ 407); that there is no special nerve of taste; the gustative impressions made upon the front of the tongue, being conveyed by the lingual branch of the fifth pair; whilst those made upon the back of the organ, are conveyed by the glosso-pharyngeal. The first of these nerves also ministers to ordinary tactile sensibility; the second appears to convey the impressions which produce nausea. The papillæ of the Tongue are essentially the same in structure with those of the Skin; but many of them are of a peculiarly complex nature.

a. The characters of the papillæ of the tongue have recently undergone a very careful examination by Messrs. Todd and Bowman (Physiological Anatomy, Chap. xv.). They may be divided, in the first place, into the *simple* and the *compound*; the former of which had previously escaped observation, through not forming any apparent projection.—The Simple papillæ are scattered in the intervals of compound, over the general surface of the tongue; and they occupy much of the surface behind the circumvallate variety, where no compound papillæ exist. They are completely buried and concealed beneath the continuous sheet of epithelium, and can only be detected, when this membrane has been removed by maceration; they are then found

[Fig. 163.]

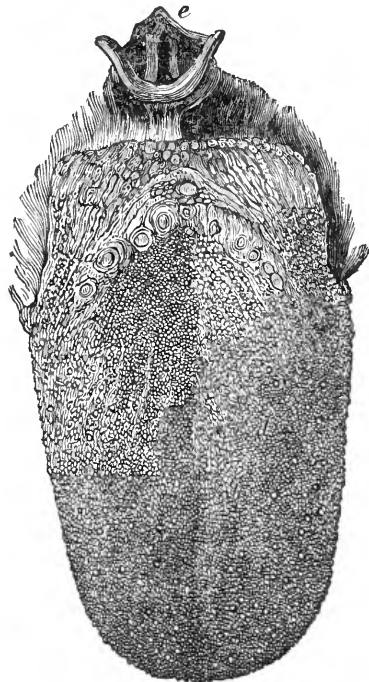

Tongue, seen on its upper surface: *a.* One of the circumvallate papillæ. *b.* One of the fungi-form papillæ. Numbers of the conical papillæ are seen about *d*, and elsewhere. *e.* Glottis, epiglottis, and glosso-epiglottidean folds of mucous membrane.—From Semmering.]

to have the general characters of the cutaneous papillæ, but nerve-tubes have not yet been detected in them.

[Fig. 164.

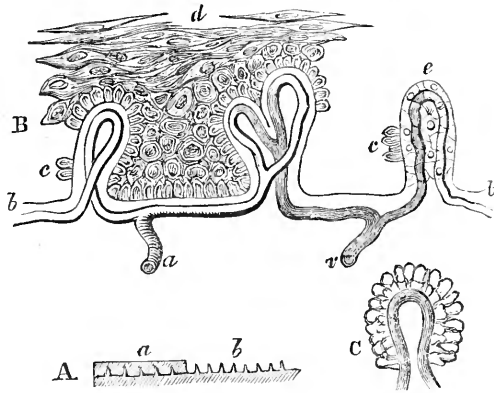

Simple papillæ near the base of the tongue:—A. *a*, concealed under the epithelium; *b*, uncovered by it.—Magnified 10 diameters. B. *a*, Arterial twig, supplying their capillary loops. *v*, Vein. The vessels are all contained within the line *b, b*, of basement membrane. *c, c*. Deeper epithelial particles resting on the basement membrane. *d*, Scaly epithelium on the surface. The granular interior of the papillæ is represented at *e*. C. Papillæ in which the basement membrane is not visible; and the deep layer of epithelium seems to rest on the capillary loop.—Magnified 200 diam.]

[Fig. 165.

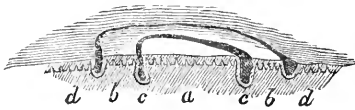

Vertical section of one of the circumvallate papillæ:—*a*, Central part. *b, b*, Border. *c, c*, Fissure between centre and border. The secondary papillæ are seen covered by the epithelium. Similar papillæ are seen *d, d*, on the membrane beyond.—Magn. 5 diam.]

[Fig. 166.

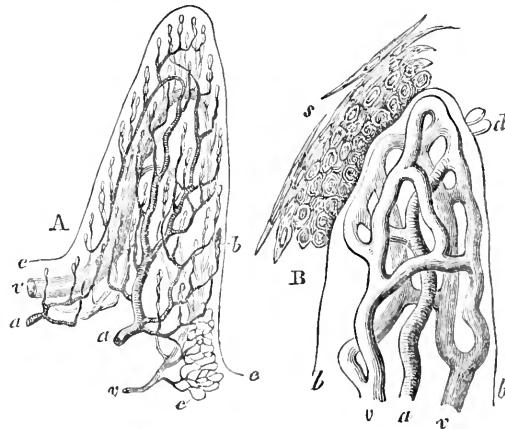

A. Compound papillæ on the side of the foramen cæcum, injected:—*a, a*, Arterial twigs. *v, v*, Veins. The capillary loops indicate the simple papillæ; in one of which, *b*, the injected matter has been extravasated within the basement membrane of the papillæ, the outline of which is thus distinguished. *c*, Capillary plexus, where no papillæ exist. *e, e*, External surface of the epithelium of the papilla.—Magn. 15 diam.

B. One of the simple papillæ of A:—*a, v, v*, Arterial and venous sides of the capillary loops. *b, b*, Basement membrane. *d*, Deeper epithelial particles resting on the basement membrane. *s*, Scaly epithelium on the surface.—Magnified 300 diameters.]

b. The Compound papillæ are visible to the naked eye; and have been classified, according to their shape, into the *circumvallate*, the *fungiform*, and the *filiform*.—The Circumvallate or calyciform papillæ are eight or ten in number, and are situated in a V-shaped line at the base of the tongue. Each consists of a central flattened circular projection of the mucous membrane, surrounded by a tumid ring of about the same elevation, from which it is separated by a narrow circular fissure. The surface of both centre and border is smooth, and invested by scaly epithelium, which conceals a multitude of simple papillæ.—The Fungiform papillæ are scattered singly over the tongue, chiefly upon its sides and tip. They project considerably from the surface, and are usually narrower at the base than at their summit. They contain a complex capillary plexus, the terminal loops of which enter the numerous simple papillæ that clothe the surface of the fungiform body. They contain nerve-tubes, in which a looped arrangement can be traced; and the epithelium which covers them is so thin, as to allow the red colour of the blood to be seen through it. In this manner they are readily distinguished from the filiform papillæ, among which they lie.—The Filiform papillæ, like the preceding, contain a plexus of

Fig. 167.

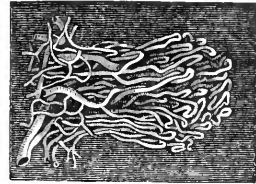

Capillary net-work of fungiform papilla of the tongue.

[Fig. 168.

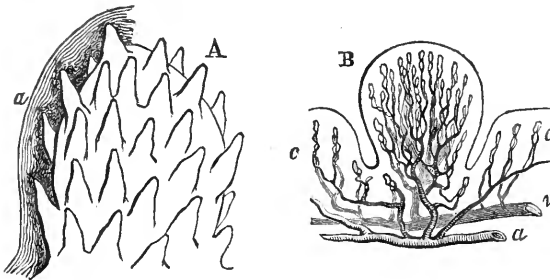

A. Fungiform papilla, showing the secondary papillæ on its surface, and at *a* its epithelium covering them over.—Magnified 35 diameters.

B. Another, with the capillary loops of its simple papillæ injected. *a*. Artery. *v*. Vein. The groove around the base of some of the fungiform papillæ is here represented, as well as the capillary loops, *c, c, c*, of some neighbouring simple papillæ.—Magnified 18 diameters.]

capillaries, and a bundle of nerve-fibres, both terminating in loops, which enter the simple papillæ that clothe the surface of the compound body; but instead of being covered with a thin scaly epithelium, they are furnished with bundles of long pointed processes, some of which approach hairs in their stiffness and structure. These are immersed in the mucus of the mouth, and may be moved in any direction, though they are generally inclined backwards.

[Fig. 169.

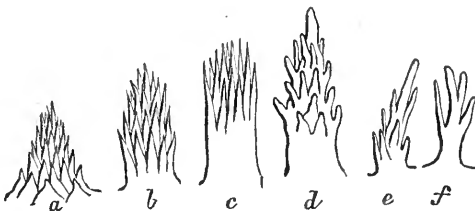

Various forms of the conical compound papillæ deprived of their epithelium:—*a, b*, and especially *c*, are the best marked, and were provided with the stiffest and longest epithelium; their simple papillæ are more acuminated. *d*, approaches the fungiform variety: *e, f*, come near the simple papillæ.—Magnified 20 diameters.]

c. The Simple papillæ which occur in an isolated manner, with those which are aggregated in the Circumvallate and Fungiform bodies, doubtless minister to the sense of Taste; but there seems much reason to coincide in the opinion of Messrs. Todd and Bowman, with regard to the different office of the Filiform papillæ. "The comparative thickness of their

[Fig. 170.]

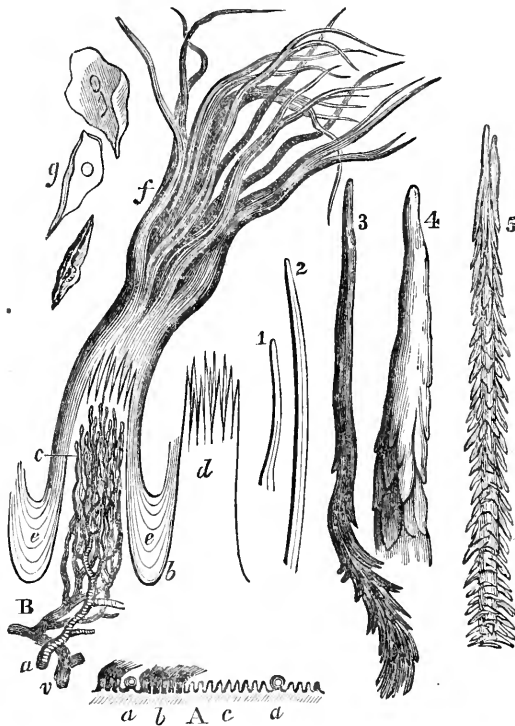

A. Vertical section near the middle of the dorsal surface of the tongue:—*a*, *a*. Fungiform papillæ. *b*. Filiform papillæ, with their hair-like processes. *c*. Similar ones deprived of their epithelium.—Magnified 2 diameters.

B. Filiform compound papillæ:—*a*. Artery. *v*. Vein. *c*. Capillary loops of the secondary papillæ. *b*. Line of basement membrane. *d*. Secondary papillæ, deprived of *e*, *e*, the epithelium. *f*. Hair-like processes of epithelium capping the simple papillæ.—Magnified 25 diameters. *g*. Separated nucleated particles of epithelium, magnified 300 diameters.

1, 2. Hairs found on the surface of the tongue. 3, 4, 5. Ends of hair-like epithelial processes, showing varieties in the imbricated arrangement of the particles, but in all a coalescence of the particles towards the point. 5, encloses a soft hair.—Magnified 160 diameters.]

protective covering, the stiffness and brush-like arrangement of their filamentary productions, their greater development in that portion of the dorsum of the tongue which is chiefly employed in the movements of mastication, all evince the subservience of these papillæ to the latter function, rather than to that of taste; and it is evident that their isolation and partial mobility on one another, must render the delicate touch with which they are endowed, more available in directing the muscular actions of the organ. The almost manual dexterity of the organ, in dealing with minute particles of food, is probably provided for, as far as sensibility conduces to it, in the structure and arrangement of these papillæ." It may be added, that the filiform papillæ of Man seem to be the rudimentary forms of those horny epithelial processes, which acquire so great a development in the tongues of the Carnivora, and which are of such importance in the abrasion of their food.

[Fig. 171.]

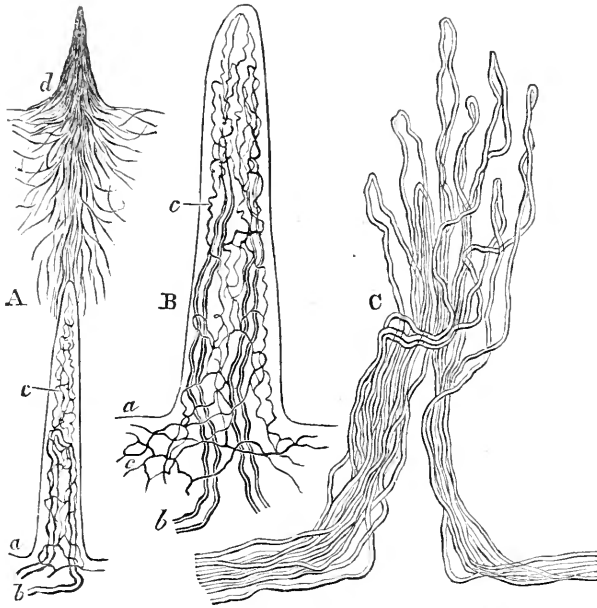

A. Secondary papilla of the conical class, treated with acetic acid:—*a*. Its basement membrane. *b*. Its nerve-tube forming a loop. *c*. Its curly elastic tissue. The epithelium in this instance is not abundant; but the vertical arrangement of its particles over the apex of the papilla is well seen, *d*, and illustrates the mode of formation of the hair-like processes described in the text.—Mag. 160 diam.

B. A similar papilla, deprived of its epithelium:—*a*. Basement membrane. *b*. Tubular fibre, probably forming a loop, but its arch not clearly seen. *c*, *c*. Elastic fibrous tissue at its base and in its interior.—Magnified 320 diameters.

C. Nerves of a compound papilla near the point of the tongue, in which their loop-like arrangement is distinctly seen.—Magnified 160 diameters.]

528. As a general rule, it is a necessary condition of the sense of Taste, that the object should either be in a state of solution, or should be soluble in the moisture covering the tongue; if this be not the case, or if the tongue be dry, a simple feeling of contact is all that is produced. As in the case of touch, the idea of the character of the sapid body is very imperfect, unless it is made to move over the gustative surface; and thus the taste is very much heightened, by the compression and friction of the substance between the tongue and the palate. From all these circumstances it appears indisputable, that a very strong analogy exists between Taste and Touch; indeed it may be questioned, whether they are not in reality more closely allied, than is the sense of Temperature with that of Resistance.

529. Although the Tongue seems to be the chief seat of Gustative sensibility, yet this is also possessed, though in a less degree, by the palate. But it is to be remarked that the sensations produced by most sapid substances are of a complex kind; and are in great part due to the organ of Smell. Of this any one may convince himself, by closing the nostrils, and inspiring and expiring through the mouth only, when holding in the mouth, or even rubbing between the tongue and the palate, some sapid substance; of which the taste is then scarcely recognized, although it is immediately perceived, when its effluvia are drawn into the nose. It is well known too, that, when the

sensibility of the Schneiderian membrane is blunted by inflammation (as in an ordinary cold in the head), the power of distinguishing flavours is very much diminished. In fact, some Physiologists are of opinion that *all* our knowledge of the *flavor* of sapid substances is received through the Smell; and this is not improbably true: but it is to be remembered, that, besides *flavor*, a sapid body may excite various other sensations, as those of irritation and pungency; and of these, it seems to be the true function of the sensory surface of the mouth, to take cognizance. Such sensations are evidently not far removed from those of ordinary touch; and correspond with those which may be excited in the nostrils, through the medium of the Fifth pair. Taken in its ordinary compound acceptation, the sense of Taste has for its object to direct us in the choice of food, and to excite the flow of the mucus and saliva, which are destined to aid in the preparation of the food for Digestion. Among the lower Animals, the instinctive perceptions connected with this sense are much more remarkable than our own; thus an omnivorous Monkey will seldom touch fruits of a poisonous character, although their taste may be agreeable; and animals, whose diet is restricted to some one kind of food, will decidedly reject all others. As a general rule, it may be stated, that substances of which the taste is agreeable to us, are useful in our nutrition; and vice versa: but there are many signal exceptions to this.

530. Like other senses, that of Taste is capable of being rendered more acute by education; and this on the principles already laid down in regard to touch. The experienced wine-taster can distinguish differences in age, purity, place of growth, &c., between liquors that to ordinary judgments are alike; and the epicure can give an exact determination of the spices that are combined in a particular sauce, or of the manner in which the animal, on whose flesh he is feeding, was killed. As in the case of other senses, moreover, impressions made upon the sensory surface remain there for a certain period: and this period is for the most part longer than that which is required for the departure of the impressions made upon the eye, the ear, or the organ of smell. Every one knows how long the taste of some powerful substances remains in the mouth; and even of those which make less decided impressions, the sensation remains to such a degree that it is difficult to compare them at short intervals. Hence if a person be blindfolded, and be made to taste substances of distinct, but not widely different flavours (such as various kinds of wine or of spirituous liquors), one after another in rapid succession, he soon loses the power of discriminating between them. In the same manner, the difficulty of administering very disagreeable medicines may be sometimes got over, by either previously giving a powerful aromatic, or by combining the aromatic with the medicine; its strong impression in both cases preventing the unpleasant taste from exciting nausea.

4. *Sense of Smell.*

531. Of the nature of Odorous emanations, the Natural Philosopher is so completely ignorant, that the Physiologist can not be expected to give a definite account of the mode, in which they produce sensory impressions. Although it may be surmised that they consist of particles of extreme minuteness, dissolved as it were in the air, and although this idea seems to derive confirmation from the fact that most odorous substances are volatile, and vice versa, —yet the most delicate experiments have failed to discover any diminution in weight, in certain substances (as musk) that have been impregnating with their effluvia a large quantity of air for several years; and there are some volatile fluids, such as water, which are entirely inodorous. The true Olfactory nerves pass down from the Olfactory Ganglion (§ 422) in the form of very

numerous minute threads, which form a plexus upon the surface of the Schneiderian or Pituitary membrane. Nothing satisfactory is known in regard to their ultimate arrangement; but it is probable that they form loops,

Fig. 172.

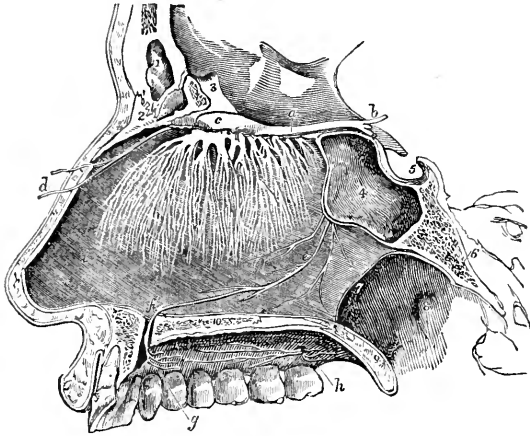

The Olfactory nerve, with its distribution on the septum nasi. The nares have been divided by a longitudinal section made immediately to the left of the septum, the right nares being preserved entire. 1. The frontal sinus. 2. The nasal bone. 3. The crista galli process of the ethmoid bone. 4. The sphenoidal sinus of the left side. 5. The sella turcica. 6. The basilar process of the sphenoid and occipital bones. 7. The posterior opening of the right nares. 8. The opening of the Eustachian tube in the upper part of the pharynx. 9. The soft palate, divided through its middle. 10. Cut surface of the hard palate. *a.* The olfactory peduncle. *b.* Its three roots of origin. *c.* Olfactory ganglion, from which the filaments proceed that spread out in the substance of the pituitary membrane. *d.* The nasal nerve, a branch of the ophthalmic nerve, descending into the left nares from the anterior foramen of the cribriform plate, and dividing into its external and internal branch. *e.* The naso-palatine nerve, a branch of the sphenopalatine ganglion distributing twigs to the mucous membrane of the septum nasi in its course to (*f.*) the anterior palatine foramen, where it forms a small gangliform swelling (Cloquet's ganglion) by its union with its fellow of the opposite side. *g.* Branches of the naso-palatine nerve to the palate. *h.* Posterior palatine nerves. *i, i.* The septum nasi.

similar to those of the cutaneous nerves. It would appear that every part of the Schneiderian membrane is not equally endowed with the faculty of distinguishing odours, which is a very different power from that of becoming sensible of irritation from them. The Olfactory nerves cannot be traced to the membrane covering the middle and inferior spongy bones, or to that which lines the different sinuses, these parts of the surface being supplied by the Fifth pair only; and it is a matter of common experience, that we cannot distinguish faint odours, unless, by a peculiar inspiratory effort, we draw the air charged with them to the upper part of the nose. In animals living in the air, it is a necessary condition of the exercise of the sense of Smell, that the odorous matter should be transmitted by a respiratory current through the nostrils; and that the membrane lining these should be in a moist state. Hence, by breathing through the mouth, we may avoid being affected by odours even of the strongest and most disagreeable kind; and in the first stage of a catarrh, when the ordinary mucous secretion is suspended, the sense of smell is blunted from this cause, as it afterwards is from the excess in the quantity of the fluid, which prevents the odoriferous effluvia from coming into immediate relation with the sensory extremities of the nerves. Hence we may easily comprehend, that section of the Fifth pair, which exercises a

considerable control over the secretions, will greatly diminish the acuteness of the smell; and it will have the further effect of preventing the reception of any impressions of irritation from acrid vapours, which are entirely different in their character from true odorous impressions, and which are not transmitted through the Olfactory nerve (§ 441). The nasal passages may indeed be considered as having, in the air-breathing Vertebrata, two distinct offices; they constitute the organ of smell, through the distribution of the olfactory nerve upon a part of their surface; but they also constitute the portals of the respiratory organs, having for their office to take cognizance of the aeriform matter which enters them, and to give warning of that which would be injurious; this latter function is performed by the Fifth pair, as by the Par Vagum in the glottis. It is through this nerve, that the act of sneezing is excitable: the evident purpose of which, is the ejection of a strong blast of air through the nasal passages, in such a manner as to drive out any offending matter they may contain.

532. The importance of the sense of Smell among many of the lower Animals, in guiding them to their food, or in giving them warning of danger and also in exciting the sexual feelings, is well known. To Man its utility is very subordinate under ordinary circumstances; but it may be greatly increased when other senses are deficient. Thus, in the well-known case of James Mitchell, who was deaf, blind and dumb, from his birth, it was the principal means of distinguishing persons, and enabled him at once to perceive the entrance of a stranger. It is recorded that a blind gentleman, who had an antipathy to cats, was possessed of a sensibility so acute in this respect, that he perceived the proximity of one that had been accidentally shut up in a closet adjoining his room. Among Savage tribes, whose senses are more cultivated than those of civilized nations, more direct use being made of the powers of observation, the scent is almost as acute as in the lower Mammalia; it is asserted by Humboldt, that the Peruvian Indians in the middle of the night can thus distinguish the different races,—whether European, American-Indian, or Negro.* The agreeable or disagreeable character assigned to particular odours, is by no means constant amongst different individuals. Many of the lower Animals pass their whole lives in the midst of odours, which are to Man (in his civilized condition at least) in the highest degree revolting; and will even refuse to touch food, until it is far advanced in putridity. It more frequently happens in regard to odours and savours, than with respect to other sensory impressions, that habit makes that agreeable, and even strongly relished, which was at first avoided; the taste of the epicure for game that has acquired the *fumet*,—for olives,—for assafoetida, &c., are instances of this. As to the length of time, during which impressions made upon the organ of smell remain upon it, no certain knowledge can be obtained. It is difficult to say that the effluvia have been completely removed from the nasal passages; since it is not improbable that the odorous particles (supposing such to exist) are absorbed or dissolved by the mucous secretion; it is probably in this manner that we may account for the fact, well known to every medical man, that the cadaverous odour is frequently experienced for days after a post-mortem examination.†

* The author has been assured by a competent witness, that a lad in the state of Somnambulism, had his sense of smell so remarkably heightened, as to be able to assign (without the least hesitation) a glove placed in his hand, to its right owner,—in the midst of about thirty persons, the boy himself being blindfolded.

† This may partly be attributed also to the effluvia adhering to the dress. It has been remarked that *dark* cloths retain these more strongly than light.

5. *Sense of Vision.*

533. The objects of this sense are bodies, which are either in themselves luminous, or which become so by reflecting the light that proceeds from others. Whether their light is transmitted by the actual emission of rays, or by the propagation of undulations analogous to those of sound, is a question at present keenly debated amongst Natural Philosophers; but it is of little consequence to the Physiologist, which is the true solution; since it is only with the laws, which actually regulate the transmission of light, that he is concerned. These laws it may be desirable here briefly to recapitulate.

534. Every point of a luminous body sends off a number of rays, which diverge in every direction, so as to form a cone, of which the luminous point is the apex. So long as these rays pass through a medium of the same density, they proceed in straight lines; but, if they enter a medium of different density, they are *refracted* or bent.—*towards* the perpendicular to the surface at the point at which they enter, if they pass from a rarer into a denser medium, and *from* the perpendicular, when they pass from a denser medium into a rarer. It is easily shown to be a result of this law, that, when parallel rays passing through air fall upon a convex surface of glass, they will be made to converge; so as to meet at the opposite extremity of the diameter of the circle, of which the curve forms part. If, instead of continuing in the glass, they pass out again, through a second convex surface, of which the direction is the reverse of the first, they will be made to converge still more, so as to meet in the centre of curvature. Rays which are not parallel, but which are diverging from a focus, are likewise made to converge to a point or focus; but this point will be more distant from the lens, in proportion as the object is nearer to it, and the angle of divergence consequently greater. The rays diverging from the several points of a luminous object, are thus brought to a corresponding focus; and the places of all these foci hold exactly the same relation to each other, with that of the points from which the rays diverged; so that a perfect image of the object is formed upon a screen held in the focus of the lens. This image, however, will be inverted; and its size, in proportion to that of the object, will depend upon their respective distances from the lens. If their distances be the same, their size will also be the same; if the object be distant, and the image near, the latter will be much the smaller; and vice versâ.

535. There are two circumstances, however, which interfere with the perfection of an image thus formed by a convex lens. The one is, that, if the lens constitute a large part of the sphere from which it is taken, the rays which fall near its margin are not brought to a focus at the same point with those which pass through its centre; but at a point nearer the lens. This difference, which must obviously interfere greatly with the distinctness of the image, is termed *Spherical Aberration*; it may be corrected by the combination of two or more lenses, of which the curvatures are calculated to balance one another, in such a manner that all the rays shall be brought to the same focus; or by diminishing the aperture of the lens by means of a stop or diaphragm, in such a manner that only the central part of it shall be used. The latter of these methods is the one employed, where the diminution in the amount of light transmitted is not attended with inconvenience. The nearer the object is to the lens (and the greater, therefore, the angle of divergence of its rays), the greater will be the spherical aberration, and the more must the aperture of the diaphragm be contracted in order to counteract it. The other circumstance that interferes with the distinctness of the image, is the unequal refrangibility of the differently-coloured rays, which together

make up white or colourless light; the violet being more bent from their course than the blue, the blue more than the yellow, and the yellow more than the red; the consequence of which will be, that the violet rays are brought to a focus much nearer to the lens than the blue, and the blue nearer than the red. If a screen be held to receive the image, in the focus of any of the rays, the others will make themselves apparent as fringes round its margin. This difference is termed *Chromatic Aberration*. It is corrected in practice, by combining together lenses of different substances, of which the *dispersive* power (that is, the power of separating the coloured rays) differs considerably. This is the case with flint and crown glass, for instance,—the dispersive power of the former being much greater than that of the latter, whilst its refractive power is nearly the same: so that, if a convex lens of crown glass be united with a concave of flint whose curvature is much less, the dispersion of the rays effected by the former will be counteracted by the latter, which diminishes in part only its refractive power.

536. The Eye may be regarded as an optical instrument of great perfection, adapted to produce, on the expanded surface of the optic nerve, a complete image or picture of luminous objects brought before it; in which the forms, colours, lights and shades, &c., of the object are all accurately represented. By the different refractive powers of the transparent media, through which the rays of light pass, and by the curvatures given to their respective surfaces, both the Spherical and Chromatic aberrations are corrected in a degree sufficient for all practical purposes: so that, in a well-formed eye, the picture is quite free from haziness, and from false colours. The power by which it adapts itself to variations in the distance of the object,—so as to form a distinct image of it, whether it be six inches, six yards, or six miles off,—is extremely remarkable, and cannot be regarded as hitherto completely explained. It is obvious that, if we fix upon any distance as that for which the eye is naturally adjusted (say 12 or 14 inches, the distance at which we

(Fig. 173.)

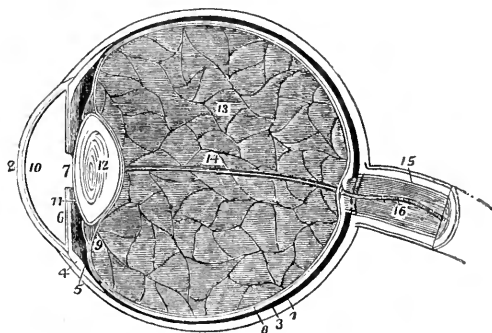

^ A longitudinal section of the globe of the Eye; 1, the sclerotic, thicker behind than in front; 2, the cornea, received within the anterior margin of the sclerotic, and connected with it by means of a beveled edge; 3, the choroid, connected anteriorly with (4) the ciliary ligament, and (5) the ciliary processes; 6, the iris; 7, the pupil; 8, the third layer of the eye, the retina, terminating anteriorly by an abrupt border at the commencement of the ciliary processes; 9, the canal of Petit, which encircles the lens (12); the thin layer in front of this canal is the zonula ciliaris, a prolongation of the vascular layer of the retina to the lens. 10, the anterior chamber of the eye, containing the aqueous humour; the lining membrane by which the humour is secreted is represented in the diagram; 11, the posterior; 12, the lens more convex behind than before, and enclosed in its proper capsule; 13, the vitreous humour enclosed in the hyaloid membrane, and in cells formed in its interior by that membrane; 14, a tubular sheath of the hyaloid membrane, which serves for the passage of the artery of the capsule of the lens; 15, the neurilemma of the optic nerve; 16, the arteria centralis retinae, imbedded in its centre.]

[Fig. 174.]

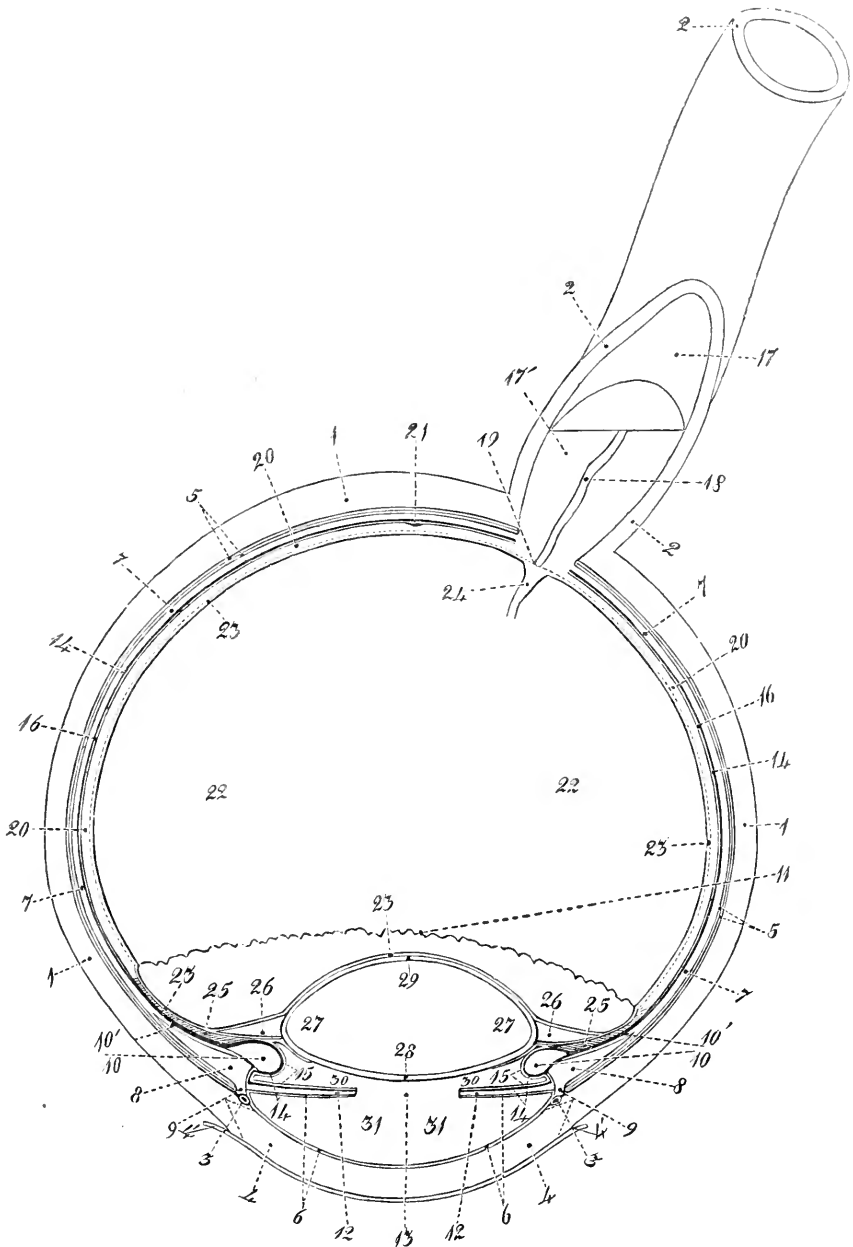

A Horizontal Section of the Eyeball; 1, sclerotic coat; 2, sheath of the optic nerve, or canal of Fontana; 3, circular venous sinus of the iris; 4, proper substance of the cornea; 5, arachnoidea oculi; 6, membrane of the anterior chamber of the aqueous humour; of the two dotted lines one points to the

supposed membrane of Descemet, the other to the supposed continuation of that membrane over the anterior surface of the iris; 7, choroid coat; 8, annulus albidus; 9, ciliary ligament; 10, 10', ciliary body, consisting of (10') a pars non-fimbriata, and (10) a pars fimbriata formed by the ciliary process; 11, ora serrata of the ciliary body; 12, iris; 13, pupil; 14, membrane of the pigment; 15, delicate membrane lining the posterior chamber of the aqueous humour; 16, membrane of Jacob; 17, the optic nerve surrounded by its neurilemma; 17', the fibres of the optic nerve consisting of fasciculi of primitivæ tubules; 18, central artery of the retina; 19, papilla cornica of the optic nerve; 20, retina; the situation of its vascular layer is indicated by a dotted line; 21, central transparent point of the retina; 22, vitreous humour; 23, the hyaloid membrane; 24, canalis hyaloideus; 25, zonula ciliaris; in the plate, none of its fimbriated part is seen, being concealed by the ciliary processes; 26, canal of Petit; 27, crystalline lens; 28, anterior wall of the capsule of the lens; 29, posterior wall of the capsule of the lens; 30, posterior chamber of the aqueous humour; 31, anterior chamber of the aqueous humour.]

ordinarily read), the rays proceeding from an object, placed nearer to the eye than this, would not be brought to a focus upon the retina, but would converge towards a point behind it; whilst on the contrary, the rays from an object at a greater distance would meet before they reached the retina, and would have again diverged from each other when they impinge upon it; so that in either case, vision would be indistinct. Now two methods of adaptation suggest themselves to the Optician. Either he may vary the distance between the refracting surface and the screen on which the image is formed, in such a manner, that the latter shall always be in the focus of the converging rays; or, the distance of the screen remaining the same, he may vary the convexity of his lens, in such a manner as to adapt it to the distance of the object. It is not improbable, that both of these methods are employed in the Eye, though no distinct evidence has been obtained of the operation of either. Several hypotheses have been proposed, to account for the phenomenon: it is easily proved that no one of them can alone be true; but it cannot be readily shown that any of them is entirely false: and it would not seem unlikely, therefore, that all may participate, in various degrees, in the effect. The following are the principal of these.—1. An alteration in the form of the globe of the eye by the action of the muscles, so that its antero-posterior diameter may be increased or diminished.*—2. A change in the convexity of the cornea. This might be very well connected with the last; since, if the globe were converted into a spheroid, of which the antero-posterior diameter would be the longest, the curvature of the cornea would be increased; whilst, if the antero-posterior diameter were shortened, the curvature would be diminished. 3. Change of position of the crystalline lens, by means of the ciliary processes. 4. Change of figure of the lens itself. That one or both of the last two are concerned in the effect, would appear from the fact, well known to every Oculist, that, after the removal of a cataract, the power of adapting the eye to distances is greatly diminished.—5. Change in the aperture of the pupil; the mode in which this could assist in accommodating the eye to variations of distance, is not very obvious.

537. Some curious circumstances, relative to the connection between the optical adaptation of the eye to distances, and the changes in the direction of the axes of the two eyes, have been pointed out by Müller. When both eyes are fixed upon an object, their axes must converge (as formerly explained, § 455) so as to meet in it. The nearer the object, the greater must be the degree of convergence; and when the object is brought within the ordinary distance of distinct vision, the convergence must very rapidly increase. Now this is precisely what takes place, in regard to alterations in the focus of the eye; for little change is required, when the object is made to approach from a considerable distance to a moderate distance; but, when it is brought near the eye, the

* The influence of the muscles in altering the form of the globe may be better comprehended, now that we know the mode in which this is kept in its place in the front of the orbit, by a fascia passing behind it, and attached anteriorly to the lids.

focus must be considerably lengthened, or the convexity of the eye increased, to cause the rays to meet on the retina: and hence it may be surmised, that the same cause is acting to produce both changes. But that the convergence of the axes is not itself in any way the occasion of the alteration of the focus of the eye, is shown by the fact, that the adaptation is as perfect, in a person who only possesses or uses one eye, as it is when both are employed; and also by the power, which is possessed by some persons, of altering the focus of the eye by an effort of the will, whilst the convergence remains the same. In regard to the adaptation of the eyes to varying distances, it is further to be remarked, that, when an object is being viewed as near to the eye as it can be distinctly seen, the pupil contracts in a considerable degree. The final cause of this change, is evidently to exclude the outer rays of the cone or pencil, which, from the large angle of their divergence, would fall so obliquely on the convex surface of the eye, as to be much affected by the spherical aberration; and to allow the central rays only to enter the eye, so as to preserve the clearness of the image. The channel through which it is effected is evidently the same, as that by which the convergence of the eyes is produced,—namely, the inferior branch of the third pair of nerves; to the action of which, the sensations upon the retina form the stimulus, in the same manner as they do to the ordinary variation in the diameter of the pupil under the influence of light.

538. The ordinary forms of defective vision, which are known under the names of *myopia* and *presbyopia*, or short-sightedness and long-sightedness, are entirely attributable to defects in the optical adaptation of the eye. In the former, its refractive power is too great; the rays from objects at the usual distance are consequently brought too soon to a focus, so as to cross one another and diverge, before they fall upon the retina; whilst the eye is adapted to bring to their proper focus on the retina, only those rays which were previously diverging at a large angle, from an object in its near proximity. Hence a short-sighted person, whose shortest limit of distinct vision is not above half that of a person of ordinary sight, can see minute objects more clearly; his eyes having, in fact, the same magnifying power, which those of the other would possess, if aided by a convex glass, that would enable him to see the object distinctly at the shorter distance. But as the myopic structure of the eye incapacitates its possessor from seeing objects clearly, at even a moderate distance, it is desirable to apply a correction; and this is done, by simply interposing a concave lens, of which the curvature is properly adapted to compensate for the excess of that of the organ itself, between the object and the eye. On the other hand, in the presbyopic eye, the curvature and refractive power are not sufficient to bring to a focus on the retina, rays which were previously divergent in a considerable or even in a moderate degree; and indistinct vision in regard to all near objects is, therefore, a necessary consequence, whilst distant objects are well seen. This defect is remedied by the use of convex lenses, which make up for the deficiency of the curvature. We commonly meet with myopia in young persons, and with presbyopia in old; but this is by no means the invariable rule; for even aged persons are sometimes short-sighted; and long-sightedness is occasionally met with amongst the young. In choosing spectacles, for the purpose of correcting the errors of the eye, it is of great consequence not to make an over-compensation; for this has a tendency to increase the defect, besides occasioning great fatigue in the employment of the sight. It may be easily found, when a glass of the right power has been selected, by inquiring of the individual, whether it alters the apparent size of the objects, or only renders them distinct. If it alter the size (increasing it if it be a convex lens, and diminishing it if it be a concave), its curvature is too great; whilst if it do not disperse the haze, it is not sufficiently

powerful. In general it is better to employ a glass which somewhat undercompensates the eye, than one which is of a curvature at all too high; since, with the advance of years in elderly persons, a progressive increase in power is required; and, as young persons grow up to adult age, they should endeavour to dispense with the aid of spectacles.

539. Many other interesting inquiries, respecting the action of the eye as an optical instrument, suggest themselves to the physical philosopher; but the foregoing are the chief in which the Physiologist is concerned; and we shall now proceed, therefore, to consider the share, which the Retina and Optic

Fig. 175.

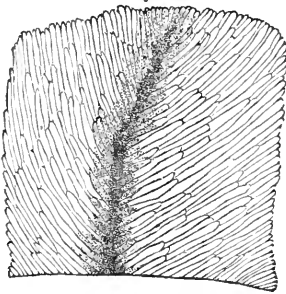

Part of the Retina of a Frog, seen from the outer surface. Magnified 300 times.

Fig. 176.

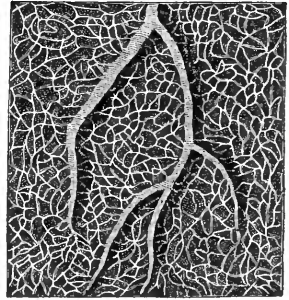

Distribution of Capillaries in Vascular layer of Retina.

Nerve perform in the phenomena of vision.—The optic nerve, at its entrance into the eye, divides itself into numerous small fasciculi of ultimate fibrils;

[Fig. 177.]

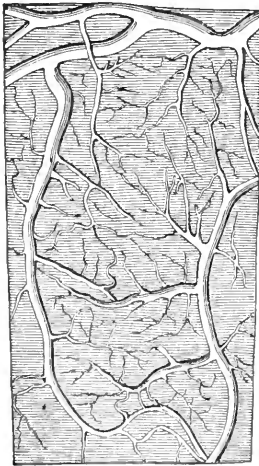

A portion of the Retina of an Infant, with its vessels injected and magnified 25 diameters. An outline of the natural size of this piece is seen just below the main cut.]

and to inosculate with each other by an exchange of fibrils, so as to form a net-like plexus. There is considerable difficulty, however, in the precise determination of the course of the nerve-fibrils in the Retina; on account of their minute size, and the absence of their distinctive characters. According to Mr. Bowman, the tubular membrane and the white substance of Schwann are deficient; and only the central part of the nerve-fibre, or axis-cylinder, is continued into this expansion. The plexus of nerve-fibrils comes into relation with a plexus of capillary vessels, very minutely distributed; and also with a layer of cells, so closely resembling those of the cortical substance of the brain, that there can be no reasonable doubt of their correspondence in function. This layer of cells, constitutes the *internal* layer of the true retina. We have here, then, all the elements of an apparatus for the *origin* of changes in the nervous trunks, in a fully displayed form; and it can scarcely be doubted that the essential parts of the same structures exist in the papillæ of the cutaneous and other sensory surfaces.—The true Retina is covered externally by a very peculiar investment, the Membrane of Jacob, which

separates it from the pigmentary layer. This seems to be composed of cells having a cylindrical form. These are sometimes arranged vertically to the

[Fig. 178.

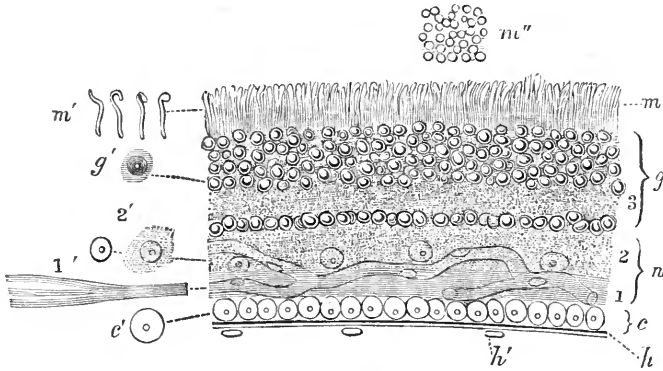

Vertical section of the Human Retina and Hyaloid Membrane. *h*. Hyaloid membrane. *h'*. Nuclei on its inner surface. *c*. Layer of transparent cells, connecting the hyaloid and retina. *c'*. Separate cell enlarged by imbibition of water. *n*. Gray nervous layer, with its capillaries. 1. Its fibrous lamina. 2. Its vesicular lamina. 1'. Shred of fibrous lamina detached. 2'. Vesicle and nucleus detached. *g*. Granular layer. 3. Light lamina frequently seen. *g'*. Detached nucleated particle of the granular layer. *m*. Jacob's membrane. *m'*. Appearance of its particles, when detached. *m''*. Its outer surface. Magnified 320 diameters.]

surface of the membrane, so that their extremities only are seen; whilst in other instances they are found to present an imbricated arrangement, lying over each other obliquely, in which case they are of considerable length (Fig. 175). They are remarkable for the rapidity with which they undergo alterations after death; and especially for the changes in their form, which are produced by the action of water.

540. The following statements on the Limits of Human Vision, in regard to the possible minuteness of the objects of which it can take cognizance, comprehend the result of numerous inquiries made by Ehrenberg, with the view of calculating the ultimate power of the Microscope.* In opposition to the generally-received opinion, Ehrenberg arrived at the conclusion that, in regard to the extreme limits of vision, there is little difference amongst persons of ordinarily good sight, whatever may be the focal distance of their eyes. The smallest square magnitude usually visible to the naked eye, either of white particles on a black ground, or of black upon a white or light-coloured ground, is about the 1-405th of an inch. It is possible, by the greatest condensation of light, and excitement of the attention, to recognize magnitudes between the 1-405th and 1-540th of an inch; but without sharpness or certainty. Bodies which are smaller than these, cannot be discerned with the naked eye when single; but may be seen when placed in a row. Particles which powerfully reflect light, however, may be distinctly seen, when not half the size of the

[Fig. 179.

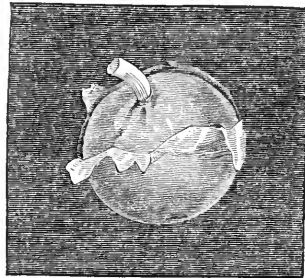

Outer surface of the Retina, showing the membrane of Jacob, partially detached. After Jacob.]

* Taylor's Scientific Memoirs. Vol. i. p. 576.

least of the foregoing ; thus, gold dust* of the fineness of 1-1125th of an inch, may be discerned with the naked eye in common daylight. The delicacy of vision is far greater for *lines* than for single articles ; opaque threads of 1-4900th of an inch in diameter may be discerned with the naked eye, when held towards the light. Such threads are about half the diameter of the Silk-worm's fibre. The degree in which the attention is directed to them, has a great influence on the readiness with which very minute objects can be perceived ; and Ehrenberg remarks that there is a much greater difference amongst individuals in this respect, than there is in regard to the absolute limits of vision. Many persons can distinctly see such objects, when their situation is exactly pointed out to them, who cannot otherwise distinguish them ; and the same is the case with persons of acuter perception, with respect to objects at distances greater than those, at which they can see most clearly. "I myself," says Ehrenberg, "cannot see 1-2700th of an inch, black on white, at twelve inches distance ; but having found it at from four to five inches distance, I can remove it to twelve inches, and still see the object plainly." Similar phenomena are well known in regard to a balloon, or a faint star, in a clear sky ; or a ship in the horizon : we easily see them after they have been pointed out to us ; but the faculty of rapidly descrying depends on the habit of using the eyes in search of such objects (§ 519).

541. The sense of Vision depends, in the first place, on the transference to our minds of the picture which is formed upon the retina ; this picture puts us in possession of the outlines, lights and shades, colours, and relative positions of the objects before us ; and all the ideas respecting the real forms, distances, &c., of bodies, which we found upon these data, must be considered in the light of *perceptions*, either instinctive or acquired. Many of these are derived through the combination, in our minds, of the Visual sensations, with those derived from the sense of Touch. Thus, to take a most simple illustration, the idea of *smoothness* is one essentially tactile ; and yet it constantly occurs to us, on looking at a surface which reflects light in a particular manner. But, if it were not for the association, which experience leads us to form, of the connection between *polish* as seen by the *eye*, and *smoothness* as felt by the *touch*, we should not be able to determine, as we now can do, the existence of both these qualities from an impression communicated to us through either sense singly. The general fact that, in Man, the greater part of those notions of the external world by which his actions in the adult state are guided, are acquired by the gradual association of the sensations communicated by the sight and by touch, is substantiated by amply-sufficient evidence. This evidence is chiefly derived from observations made upon persons born blind, to whom sight has been communicated by an operation, at a period of life which enabled them to give an accurate description of their sensations. The case recorded by Cheselden is one of the most interesting of these. The youth (about 12 years of age), for some time after tolerably distinct vision had been obtained, saw everything *flat*, as in a picture ; simply receiving the consciousness of the impression made upon his retina ; and it was some time before he acquired the power of judging, by his sight, of the real forms and distances of the objects around him. An amusing anecdote recorded of him, shows the complete want of natural or intuitive connection which there is in Man, between the ideas formed through visual and through tactile sensations. He was well acquainted with a Dog and a Cat by *feeling* ; but could not remember their respective characters when he *saw* them. One day, when thus puzzled, he took up the Cat in his arms, and felt her attentively, so as to as-

* Ehrenberg mentions that he obtained the finest particles of gold, by scraping gilt brass ; by filing pure gold, he always obtained much coarser particles.

sociate the two sets of ideas; and then, setting her down, said, "So, puss, I shall know you another time." A similar instance has come under the Author's own knowledge; but the subject of it was scarcely old enough to present phenomena so striking. One curious circumstance was remarked of him, which fully confirms (if confirmation were wanting) the view here given. For some time after the sight was tolerably clear, the lad preferred finding his way through his father's house, to which he had been quite accustomed when blind, by touch rather than by sight,—the use of the latter sense appearing to perplex rather than to assist him; but, when learning a new locality, he employed his sight, and evidently perceived the increase of facility which he derived from it.

542. The question has been proposed, whether a person born blind, who was able by the sense of Touch to distinguish a cube from a sphere, would, on suddenly obtaining his Sight, be able to distinguish them by the latter sense. This question was answered by Locke in the negative; and probably with justice. It is no real objection to such a reply, that a new-born animal seeks the nipple of its mother, when informed of its proximity by sight; for all that is indicated by this fact is, that the sensation excites an intuitive feeling of desire, which gives rise to movements adapted to gratify it. Such instinctive actions, founded upon intuitive perceptions, are, as already pointed out, much more numerous in the lower Animals than in the higher, and in the young of the Human species than in the adult (§ 428); and they do not afford any proof that definite notions, such as we acquire, of the forms and properties of external objects, are possessed by the animals which exhibit them. We shall now examine, a little more in detail, into the means by which we gain such notions, and the data on which they are founded.

543. The first point to be determined, is one which has been a fruitful source of discussion,—the cause of *erect vision*, the picture upon the retina being inverted. Many solutions of it have been attempted; but they are for the most part rather specious than really satisfactory. That which has been of late years the most in vogue, is founded upon what was styled the Law of Visible Direction, which has been supported by Sir D. Brewster, and other eminent Philosophers. This law affirms, that every object is seen in the direction of the perpendicular to that point of the retina, on which its image is formed; or, in other words, that, as all the perpendiculars to the several points of the inner surface of a sphere meet in the centre, the line of direction of any object is identical with the prolonged radius of the sphere, drawn from the point at which its image is made upon the retina. Upon close examination, however, it is found that this law cannot be optically correct; since the lines of direction cross each other at a point much anterior to the centre of the globe; as may be determined by drawing a diagram upon a large scale, and laying down the course of the rays received by the eye, according to the curvatures and refractive powers of its different parts. In this manner it has been determined by Volkmann, that the lines of direction cross each other in a point a little behind the crystalline lens; and that they will thus fall at such different angles on different points of the retina, that no general law can be laid down respecting them. It may be questioned, moreover, whether such a law would afford any assistance in explaining the phenomenon; since, after all, it is requisite to assume an intuitive application of it, in supposing the mind to derive its ideas of the relative situations of objects, from the imagined line of direction.—A much simpler and more direct explanation may be given. We must remember that, which we have had occasion to notice in regard to all the other senses,—the broad line of distinction between the *sensation* and the *perception* or *elementary notion*; and this is still more clearly shown by the complete absence of any relation, but such as experience develops, between

the perceptions derived through the sight, and those acquired from the touch. Hence there is no more difficulty in understanding, that an inverted picture upon the retina should convey to us a notion of the external world, which harmonizes with that acquired through the sense of touch, than there is in comprehending the formation of any of those intuitive perceptions of animals, which are so much more removed from the teachings of our own experience (§ 490). It is justly remarked by Müller that, "if we do see objects inverted [or rather, if the picture on the retina is inverted] the only proof we can possibly have of it, is that afforded by the study of the laws of Optics; and, if everything is seen reversed, the relative position of the objects remains unchanged. Hence it is, also, that no discordance arises between the sensations of inverted vision and those of touch, which perceives everything in its erect position; for the images of all objects, even of our own limbs, on the retina, are equally inverted, and therefore maintain the same relative position. Even the image of our hand, when used in touch, is inverted." From what has been stated, it would appear quite conceivable, that a person just endowed with sight, should not at first know by his visual powers, whether a pyramid placed before his eyes is the same body, and in the same position, as one with which he has become acquainted by the touch; and, if this be admitted, the inference necessarily follows, that the notion of *erectness*, which we form by the combined use of our eyes and our hands, is really the product of experience in ourselves, whilst it is probably innate or intuitional in the lower Animals.

544. The cause of *single vision with the two eyes* has, in like manner, been the subject of much discussion; since the mode in which we are affected by the two simultaneous impressions, is quite different from that, in which we derive our knowledge of external things through the other senses. Some have even asserted, that we do not really employ both eyes simultaneously, but that the mind is affected by the image communicated by one only; and this idea might seem to be confirmed by the fact heretofore mentioned (§ 519), respecting the alternate use of the two eyes, when they are looking through two differently-coloured media. But it is easily disproved in other ways.—It will presently be shown, that all our estimates of the forms of bodies, depend on the combination by the mind, of the images simultaneously transmitted by the two eyes; and our knowledge of distances is in great part obtained in like manner. The condition of Single Vision has been already stated (§ 454) to be probably this,—that the two images of the object should be formed on parts of the two retinae, which are *accustomed* to act in concert; and reasons were given for the belief, that *habit* is the chief means by which this conformity is produced. There can be no doubt, however, that double images are continually being conveyed to our minds; but that, from their want of force and distinctness, and from the attention being fixed on something else, we do not take cognizance of them. This may be shown by a very simple experiment. If two fingers be held up before the eyes, one in front of the other, and vision be directed to the more distant, so that it is seen singly, the nearer will appear double; while, if the nearer one be regarded more particularly, so as to appear single, the more distant will be seen double. A little consideration will show, therefore, that our minds must be continually affected with sensations, which cannot be united into the idea of a single image; since, whenever we direct the axes of our eyes towards any object, everything else will be represented to us as double; but we do not ordinarily perceive this, from our minds being fixed upon a clear and distinct image, and disregarding, therefore, the vague undefined images formed by objects at a different focus. Of this it is very easy to convince oneself. It is moreover evident from this experiment, that double vision cannot result from want of symmetry in the position of the images upon the retina, to which some have

attributed it; for it answers equally well, if the line of the two fingers be precisely in front of the nose, so that the inclination of both eyes towards either object is equal; the position of the images of the second object must then be at the same distance on each side from the central line of the retina, and yet they are represented to the mind as double. It is, moreover, easily shown, that, in the lower animals whose orbits are not directed forwards as in us, but sideways in a greater or less degree, whenever an object is so situated as to be seen by both eyes, the points of the two retinae on which its images are formed, must be very far from possessing this symmetry.

545. Many attempts have been made to explain the phenomena of Single Vision by the peculiar decussation of the Optic nerves (§ 445); and an interesting correspondence between the varieties in the degree of decussation, and the position of the eyes, in several animals, has been pointed out by Mr. Solly and Mr. Mayo. From these and other data, it has been concluded, that each nerve is used in looking towards the opposite side. This is evidently true of the Osseous Fishes, whose two eyes, being directed sideways, have two entirely different spheres of vision. And it is also true of Man, if Mr. Mayo's account of the distribution of the nerve be correct; since, when we look at an object held directly in front of the face, at the level of the eyes, and at the nearest point for distinct vision, almost the whole of that portion of the *right* retina, which lies to the outside of the entrance of the optic nerve, is directed to the left; and the exactly different, complementary, or inner portion of the *left* retina, which is supplied by the *same nerve*, is likewise directed to the left. On this supposition, all the rays entering the two eyes from any one point, will be brought to a focus on fibrils belonging to the nerve of the same side; though these are in Man, as in other animals whose spheres of vision are nearly or partly coincident, distributed to distinct visual organs.* It is obvious, however, that this or any similar explanation, must be insufficient to explain the phenomenon of single vision; since the images formed upon the two retinae are necessarily different, and must be combined or harmonized by an act of the mind, as will be shown in the succeeding paragraphs.

546. We shall next consider the mode, in which our notion of the *solid forms* and relative projection of objects is acquired; on which great light has recently been thrown by the interesting experiments of Mr. Wheatstone.† It is perfectly evident, both from reason and experience, that the flat picture upon the retina, which is the only object of our sensation, could not itself convey to our minds any notion, but that of a corresponding plane surface. In fact, any notion of *solidity*, which might be formed by a person, who had never had the use of more than one eye, would entirely depend upon the combination of his visual and tactile sensations. This idea is fully confirmed by the case already referred to, as recorded by Cheselden. The first visual idea formed by the youth was, that the objects around him formed a flat surface, which touched his eyes, as they had previously been in contact with his hands; and after this notion had been corrected, through the education of his sight by his touch, he fell into the converse error of supposing that a picture, which was shown to him, was the object itself represented in relief on a small scale.—But where both eyes are employed, it has been ascertained by Mr. Wheatstone,

* The late Dr. Wollaston was subject to a curious affection of vision, which consisted in his not being able to see more than half an object,—the loss being sometimes on one side, and sometimes on the other. The Author has met with several cases of this disorder, which has been termed *hemiopia*. Dr. W. thought that they might be explained by the decussation of the optic nerve; but Mr. Mayo states that he has known instances of a parallel affection, involving alternately the *centre* and the *circumference* of the retina, and therefore not attributable to any such structural arrangement.

† Philosophical Transactions, 1838.

that they concur in exciting the perception of solidity or projection, which arises from the combination of two different images in the mind. It is easily shown, that any near object is seen in two different modes by the two eyes. Thus let the reader hold up a thin book, in such a manner that its back shall be exactly in front of his nose, and at a moderate distance from it; he will observe, by closing first one eye and then the other, that his perspective view of it (or the manner in which he would represent it on a plane surface) is very different, according to the eye with which he sees it. With the right eye he will see its right side, very much foreshortened; with the left, he will gain a corresponding view of the left side; and the apparent angles, and the lengths of the different lines, will be found to be very different in the two views. On looking at either of these views singly, no other notion of solidity can be acquired from it, than that to which the mind is conducted, by the association of such a view with the touch of the object it represents. But it is capable of proof, that the mental association of the two different pictures upon the retina, does of itself give rise to the idea of solidity. This proof is afforded by Mr. Wheatstone's ingenious instrument, the Stereoscope.

547. The Stereoscope essentially consists of two plane mirrors, inclined with their backs to one another at an angle of 90° . If two perspective drawings of any solid object, as seen at a given distance with the two eyes respectively, be placed before these mirrors, in such a manner that their images shall be made to fall upon the corresponding parts of the two retinae, in the same manner as the two images formed by the solid object itself would have done, the mind will perceive, not a single representation of the object, nor a confused union of the two, but a body projecting in relief,—the exact counterpart of that from which the drawings were made. Mr. Wheatstone further shows by means of the Stereoscope, that similar images, differing to a certain extent in magnitude, when presented to the corresponding parts of the two retinae, give rise to the perception of a single object, intermediate in size between the two monocular pictures. Were it not for this, objects would appear single, only when at an equal distance from both eyes, so that their pictures upon the retina are of the same size; which will only happen, when they are directly in front of the median line of the face. Again, if pictures of dissimilar objects be simultaneously presented to the two eyes, the consequence will be similar to that which is experienced, when the rays come to the eye through two differently-coloured media;—the two images do not coalesce, nor do they appear permanently superposed upon one another: but at one time one image predominates to the exclusion of the other, and then the other is seen alone; and it is only at the moment of change, that the two seem to be intermingled. It does not appear to be in the power of the will, Mr. Wheatstone remarks, to determine the appearance of either; but, if one picture be more illuminated than the other, it will be seen during a larger proportion of the time. Many other curious experiments with this simple instrument are related by Mr. Wheatstone; and they all go to confirm the general conclusion, that the combination of the images furnished by the two eyes is a mental act, resulting from an inherent law of our psychological constitution; and that our perceptions of the solidity and projection of objects, near enough to be seen in different views with the two eyes, result from this cause. In regard to distant objects, however, the difference in the images formed by the two eyes is so slight, that it cannot aid in the determination; and hence it is, that, whilst we have no difficulty in distinguishing a picture, however well painted, from a solid object, when placed near our eyes, (since the idea, which might be suggested by the image formed on one eye, will then be corrected by the other,) we are very liable to be misled by a delineation, in which the perspective, light and shade, &c., are faithfully depicted, if we are placed at a distance from it, and are pre-

vented from perceiving that it is *but* a picture. In this case, however, a slight movement of the head is sufficient to undeceive us; since by this movement a great change would be occasioned in the perspective view of the object, supposing it to possess an uneven surface; whilst it scarcely affects the image formed by a picture. In the same manner, a person who only possesses one eye, obtains, by a slight motion of his head, the same idea of the form of a body, which another would acquire by the simultaneous use of his two eyes.

548. The appreciation of the *distance* of objects, may be easily shown to be principally derived from the association, in the mind, of visual and tactual sensations; assisted, in regard to near objects, by the muscular sensations derived from the convergence of the eyes. Thus, an infant, or a person who has but recently acquired sight, evidently forms very imperfect ideas regarding the distance of objects; and it is only after long experience that a correct notion is formed. The assistance which is given by the joint use of both eyes, is evident from the fact, that, if we close one eye, we are unable to execute with certainty many actions, which require a precise appreciation of the distance of near objects,—such as threading a needle, or snuffing a candle. In regard to distant objects, our judgment is chiefly founded upon their apparent size, if their actual size be known to us; but, if this is not the case, and if we are so situated that we cannot judge of the intervening space, we principally form our estimate from the greater or less distinctness of their colour and outline. Hence this estimate is liable to be greatly affected by varying states of the atmosphere; as is well known to every one who has visited warmer latitudes. The extreme clearness of the air sometimes brings, into an apparently near proximity, a hill that rises beyond some neighbouring ridge (the intervening space being hidden, so as not to afford any datum for the estimate of the distance of the remote hill); and which, by a slight haziness, is carried to three or four times the degree of apparent remoteness. It is probable that, in the lower Animals, the perception of distance is much more intuitive than it is in ourselves.

549. Our estimate of the real *size* of an object is manifestly connected with that of its distance. The *apparent* size is dependent upon the angle at which its rays diverge, to impinge upon the cornea; this angle increases with the proximity, and diminishes with the remoteness, of the object. Our estimate of the comparative size of near objects, of whose distances we can become aware by the inclination of the optic axes, is much more correct than that which we form, when one or both are far removed; since, when we are uncertain as to its distance, we cannot form a judgment of the real size of a body, from the angle at which its rays diverge. Hence our estimate of the size of objects even moderately distant, is much influenced by states of the atmosphere. Thus, if we walk across a common in a fog, a child approaching us appears to have the size of a man, and a man seems like a giant; since the indistinctness of the outline excites in the mind the idea of distance; and an object seen under a given visual angle at a distance, must of necessity be much larger than one, of which the apparent size is the same, but which is much nearer. The want of innate power in Man to form a true conception of either size or distance, is well shown by the effect produced on the mind unprepared for such delusions, by a skilfully-painted picture; the view of which is so contrived, that its distance from the eye cannot be estimated in the ordinary manner; the objects it represents are invested by the mind with their real sizes and respective distances, as if their real image was formed upon the retina.*

* This delusion has been extremely complete, in some of those who have seen the panoramic view of London in the Coliseum. A lively and interesting account of it is given in the Journal of the Parsee Shipbuilders, who visited England some time ago.

550. From all these considerations, we are led to perceive the truth of the quaint observation made by Dr. Brown,—that “vision is, in fact, the art of seeing things which are invisible;” that is, of acquiring information, by means of the eye, which is neither contained in the sensations of sight themselves, nor logically deducible from the intimations which those sensations really convey. We cannot too constantly bear in mind, in treating of this subject, that we do not take cognizance by our optic nerves, as we do by the nerves of touch, of material bodies themselves, but of the pictures or images formed by those objects; and whatever be the notions suggested by the picture, *that* can never be transformed into anything else. These notions appear to be, in the lower Animals, entirely of an intuitional or instinctive character; in Man they are so in a much less degree; and although it is impossible to come to a precise conclusion on the subject, from the want of sufficient data, it is indubitable that a large part of the knowledge of the external world, which he derives in the adult condition from the use of his eyes alone, is really dependent upon the early education of his perceptive powers, in which process, the sensations conveyed by different organs are brought to bear upon one another.

551. The persistence, during a certain interval, of impressions made upon the retina, gives rise to a number of curious visual phenomena. The prolongation of the impression will be governed, in part, by its previous duration. Thus, when we rapidly move an ignited point through a circle, the impression itself is momentary, and remains but for a short time; whilst, if we have been for some time looking at a window, and then close our eyes, the impression of the dark bars traversing the illuminated space is preserved for several seconds. Such phenomena can here be only briefly adverted to. One of these is the combination, into one image, of two or more objects presented to the eye in successive movements; but these must be of a kind which can be united, otherwise a confused picture is produced. Thus in a little toy, called the Thaumatrope, which was introduced some years ago, the two objects were painted on the opposite sides of a card,—a bird, for instance, on one, and a cage on the other; and, when the card was made (by twisting a pair of strings) to revolve about one of its diameters, in such a manner as to be alternately presenting the two sides to the eye at minute intervals, the two pictures were blended, the bird being seen in the cage. A far more curious illusion, however, was that first brought into notice by Mr. Faraday; who showed that, if two toothed wheels, placed one behind the other, be made to revolve with equal velocity, a stationary spectrum will be seen; whilst if one be made to revolve more rapidly than the other, or the number of teeth be different, the spectrum also will revolve. The same takes place when a single wheel is made to revolve before a mirror; the wheel and its image answering the purpose of the two wheels in the former case. On this principle, a number of very ingenious toys have been constructed; in some of these, the same figure or object is seen in a variety of positions; and the impressions of these, passing rapidly before the eye, give rise by their combination to the idea, that the object is itself moving through these positions. Similar illusions may be produced in regard to colour.

552. When the Retina has been exposed for some time to a strong impression of some particular kind, it seems less susceptible of feebler impressions of the same kind. Thus, if we look at any brightly luminous object, and then turn our eyes on a sheet of white paper, we shall perceive a dark spot upon it; the portion of the retina, which had been affected by the bright image, not being able to receive an impression from the fainter rays reflected by the paper. The dark spectrum does not at once disappear, but assumes different colours in succession,—these being expressions of the states through which the retina passes, in its transition to the natural condition. If the eye

has received a strong impression from a coloured object, the spectrum exhibits the complementary colour;* thus, if the eye be fixed for any length of time upon a bright red spot on a white ground, and be then suddenly turned so as to rest upon the white surface, we see a spectrum of a green colour.—The same explanation applies to the curious phenomenon of coloured shadows. It may not unfrequently be observed at sunset, that, when the light of the sun acquires a bright orange colour from the clouds through which it passes, the shadows cast by it have a blue tint. Again, in a room with red curtains, the light which passes through these produces green shadows. In both instances, a strong impression of one colour is made on the general surface of the retina: and at any particular spots, therefore, at which the light is colourless but very faint, that colour is not perceived, its complement only being visible. The correctness of this explanation is proved by the fact, that, if the shadow be viewed through a tube, in such a manner that the coloured ground is excluded, it seems like an ordinary shadow. It is not unlikely that, as Müller suggests, the predominant action of one colour on the retina disturbs (as it were) the equilibrium of its condition, and excites in it a tendency to the development of a state, corresponding to that which is produced by the impression of the complementary colour: for the latter is, according to him, perceived even where it does not exist;—as when the eye, after receiving a strong impression from a coloured spot, and directed upon a completely dark surface or into a dark cavity, still perceives the spectrum.—Upon these properties of the eye are founded the laws of harmonious colouring, which have an obvious analogy with those of musical harmony. All complementary colours have an agreeable effect, when judiciously disposed in combination; and all bright colours, which are not complementary, have a disagreeable effect, if they are predominant: this is especially the case in regard to the simple colours, strong combinations of any two of which, without any colour that is complementary to either of them, are extremely offensive. Painters who are ignorant of these laws, introduce a large quantity of dull grey into their pictures, in order to diminish the glaring effects, which they would otherwise produce; but this benefit is obtained by a sacrifice of the vividness and force, which may be secured in combination with the richest harmony, by a proper attention to physiological principles.

553. Some persons, who can perfectly distinguish forms, are deficient, through some original peculiarity in the constitution of the retina, in the power of discriminating colours. This is most commonly seen in regard to the complementary colours, especially red and green: such persons not being able to perceive cherries amidst the leaves on a tree, except by the difference of their form. Several distinct varieties of this affection may be distinguished, however. These have been classified by Seebeck and Wartmann.†

554. Amongst other curious phenomena of Vision, is the vanishing of images which fall at the entrance of the optic nerve; as is shown in the following experiment. Let two black spots be made upon a piece of paper, about four or five inches apart; then let the left eye be closed, and the right eye be strongly fixed upon the left-hand spot. If the paper be then moved backwards and forwards, so as to change its distance from the eye, a point will be found, at which the right-hand spot is no longer visible; though it is clearly seen, when the paper is brought nearer or removed further. In this position of the eye and object, the rays from the right-hand spot cross to the nasal

* By the complementary colour is meant that, which would be required to make white or colourless light, when mixed with the original. As red, blue, and yellow are the primary or elementary colours, red is the complement of green (which is composed of yellow and blue); blue is the complement of orange (red and yellow); and yellow of purple (red and blue); and vice versâ in all instances.

† Müller's Physiology, p. 1213; Taylor's Scientific Memoirs, Vol. iv. p. 156, *et seq.*

side of the globe, and fall upon the point of the retina, which has just been mentioned. The phenomenon is not confined to that spot, however; nor is it correct to say, as is sometimes done, that the retina is not sensible to light at that point; since, if such were the case, we should see a dark spot in our field of view, whenever we use only one eye. The fact is, that a similar phenomenon may occur under somewhat different conditions, in any division of the retina, especially in its lateral parts. Thus, if we fix the eye for some time, until it is fatigued, upon a strip of coloured paper lying upon a white surface, the image of the coloured object will in a short time disappear, and the white surface will be seen in its place; the disappearance of the image, however, is only of a few seconds duration. The truth seems to be, that there is a tendency in the retina, to the propagation over neighbouring parts, of impressions which occupy a large proportion of its surface; and that this tendency is the strongest, around the point at which the optic nerve enters, so that the state of this part will generally become similar to that of the surrounding portion of the retina. Hence, when we are using one eye only, we do not perceive any dark spot in the field, but only a certain degree of indistinctness in a portion of the image.

555. Under particular circumstances, we may receive a visual representation of the retina itself; as is shown by the experiments of Purkinje. "If, in a room otherwise dark, a lighted candle be moved to and fro, or in a circle, at a distance of six inches before the eyes, we perceive, after a short time, a dark arborescent figure ramifying over the whole field of vision; this appearance is produced by the vasa centralia distributed over the retina, or by the parts of the retina covered by those vessels. There are, properly speaking, two arborescent figures, the trunks of which are not coincident, but on the contrary arise in the right and left divisions of the field, and immediately take opposite directions. One trunk belongs to each eye, but their branches intersect each other in the common field of vision. The explanation of this phenomenon is as follows:—By the movement of the candle to and fro, the light is made to act on the whole extent of the retina, and all the parts of the membrane which are not immediately covered by the vasa centralia are feebly illuminated; those parts, on the contrary, which are covered with those vessels cannot be acted on by the light, and are perceived, therefore, as dark arborescent figures. These figures appear to lie before the eye, and to be suspended in the field of vision."* We have thus another demonstration of the fact that, in ordinary vision, the immediate object of our sensation is a certain condition of the retina, which is excited by the formation of a luminous image.

6. *Sense of Hearing.*

556. In the Ear, as in the Eye, the impressions made upon the sensory nerve are not at once produced by the body which originates the sensation; but they are propagated to it, through a medium capable of transmitting them. Here too, therefore, we take cognizance by the mind, not of the sonorous object, but of the condition of the auditory nerve; and all the ideas we form of sounds, as to their nature, intensity, direction, &c., must be based upon the changes which they produce in it. The complex contrivances, which we meet with in the organ of Hearing among higher animals, are evidently intended to give them greater power of discriminating sounds, than is possessed by the lower tribes: in which last it is reduced to a form so simple, that it may be questioned whether they can be said to possess an organ of *hearing*, if by this term we imply anything more than the mere consciousness of sono-

* Müller's Physiology, p. 1163.

rous vibrations. There is a considerable difference, however, between the Eye and the Ear, in regard to the special purposes for which they are respectively adapted. In the former we have seen, that the whole object of the instrument is to direct the rays of light received by it, in such a manner, as to occasion them to fall upon the expansion of the optic nerve in a similar relative position, and with corresponding proportional intensity, to that which they possessed when issuing from the object. We have no reason to believe anything of this kind to be the purpose of the Ear; indeed, it would be inconsistent with the laws of the propagation of sound. Sonorous vibrations having the most various directions, and the most equal rate of succession, are transmitted by all media without modification, however numerous their lines of intersection; and wherever these undulations fall upon the auditory nerve, they must cause the sensation of corresponding sounds. Still it is probable that some portions of the complex organ of hearing, in Man and in the higher animals, are more adapted than others to receive impressions of a particular character; and that thus we may be especially informed of the direction of a sound by one part of the organ, of its musical tone by another, and of some other of its qualities by a third. In our inquiries into this ill-understood subject, we shall commence with a brief survey of the comparative structure of the organ.

557. The essential part of an Organ of Hearing being obviously a nerve, endowed with the peculiar property of receiving and transmitting sonorous undulations, it is by no means indispensable that a special provision should be made for this purpose; since the Auditory nerve, if merely in contact with the solid parts of the head, will be affected by the vibrations, in which it is continually participating. Hence we must not imagine the sense to be absent, wherever we cannot discover a special organ. It is among the highest only of the Invertebrate animals, that any such special organ presents itself; and then only in a very simple form. Thus in the Crustacea and Cephalopoda,

[Fig. 180.]

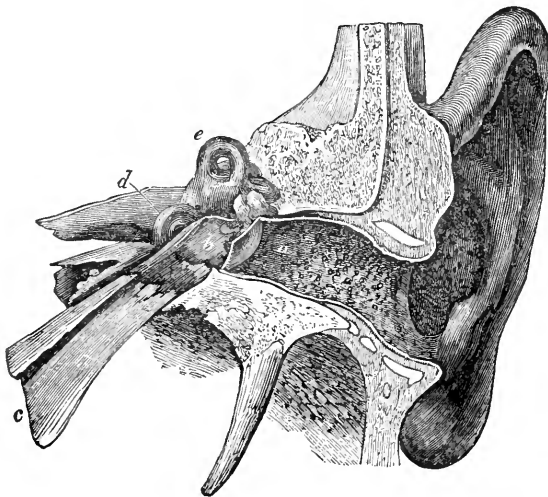

General view of the external, middle, and internal ear, as seen in a prepared section through *a*, the auditory canal. *b*. The tympanum or middle ear. *c*. Eustachian tube, leading to the pharynx. *d*. Cochlea; and *e*. Semicircular canals and vestibule, seen on their exterior, as brought into view by dissecting away the surrounding petrous bone. The styloid process projects below; and the inner surface of the carotid canal is seen above the Eustachian tube. From Scarpa.]

the ear consists of a small cavity excavated in the solid frame-work of the head; this cavity is lined with a membrane, on which the nerve is distributed; and it is filled with a watery fluid. In some instances, the cavity is completely shut in by its solid walls; and the sonorous vibrations can then only be communicated through these: but in the higher forms of this apparatus, there is a small aperture covered with a membrane, upon which the external medium can at once act. In tracing this most simple into the more complex forms, it is at once seen, that the cavity corresponds with the *vestibule* of the ear of higher animals, and its opening with the *fenestra ovalis*. In the lowest Cyclostome Fishes, the organ is but little more complicated; from the vestibule proceeds a single annular passage, which may be considered as a semicircular canal; and the auditory nerve is distributed minutely upon its lining membrane, as upon that of the vestibule itself. In species a little higher in the scale, two such canals exist; these are present in the Lamprey. And in all the rest of the class, three semicircular canals are found; holding the same direction in regard to each other, as they do in Man. Within the vestibular sac of Fishes are found calcareous concretions, which are pulverulent in the Cartilaginous, but hard and stony in the Osseous tribes; to these the name of Otolithes has been given. Some rudiments of a tympanic cavity may be found in Fishes; but there is no vestige of a cochlea: in several tribes, the organ of hearing possesses a peculiar connection with the air-bladder, which appears to be a foreshadowing of the Eustachian tube of higher classes.

558. In the true Reptiles, a considerable advance is constantly to be found in the character of the Ear; a tympanic cavity being added, with a drum and a chain of bones; and a rudiment of the cochlea being generally discoverable. Among the Amphibia, however, which are in so many respects intermediate

[Fig. 181.]



Diagram of the inner wall of the tympanum after maceration, the outer wall and ossicles being removed. a. Fenestra ovalis. b. Fenestra rotunda. c. Promontory. d. Pyramid, with the orifice at its apex. e. Projection of the aqueductus Fallopii. f. Some of the mastoid cells communicating with the tympanum. g. Proecess cochleariformis, bounding i, the canal for the tensor tympani muscle: the anterior pyramid is broken off, if it existed. h. Commencement of the Eustachian tube. j. Jugular-fossa, immediately below the tympanum. k, k'. Carotid canal, with the artery in outline, to show its course in relation to the tympanum and Eustachian tube. l. Portio dura of the seventh pair of nerves, as it would be seen in the terminal part of the aqueduct of Fallopius. m. Chorda tympani, leaving the portio dura, and entering a short canal, which opens in the tympanum, at the base of the pyramid. n. Grooves for the tympanic plexus.]

between the true Reptiles and Fishes, there is a remarkable variation in this respect,—some having a tympanum, and some being completely destitute of it. Wherever a tympanic cavity distinctly exists, there is an Eustachian tube connecting it with the fauces. This cavity, in the true Reptiles, not only possesses the *fenestra ovalis* (or opening into the vestibule), but the *fenestra rotunda* (or opening into the cochlea). The *membrana tympani* is usually

[Fig. 182.]

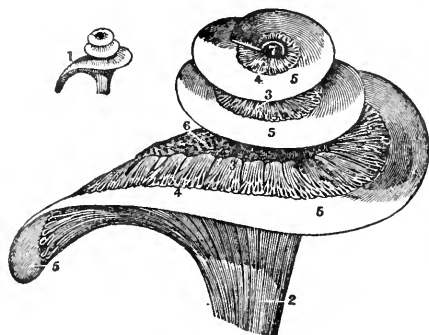

A view of the axis of the Cochlea and the Lamina Spiralis, showing the arrangement of the three Zones; the osseous zone and the membrane of the vestibule have been removed; 1, the natural size of the parts; the other figure is greatly magnified; 2, trunk of the auditory nerve; 3, the distribution of its filaments in the zona ossea; 4, the nervous anastomosis of the zona vesicularis; 5, the zona membranacea; 6, the osseous tissue of the modiolus; 7, the opening between the two scalæ.]

visible externally; but it is sometimes covered by the skin.—In Birds, the structure of the ear is essentially the same as in the higher Reptiles. A distinct cochlea exists, though its form is not spiral but nearly straight: of its character, however, there can be no doubt; a division into two passages, by a membranous partition on which the nerve is spread out, being evident. Moreover the tympanum communicates with cavities in the cranial bones, which are thus filled with air; and these, by increasing the extent of surface, produce a more powerful resonance. There is no external ear, except in a few species of nocturnal Birds.—In Mammalia, the organ of hearing is usually

[Fig. 183.]

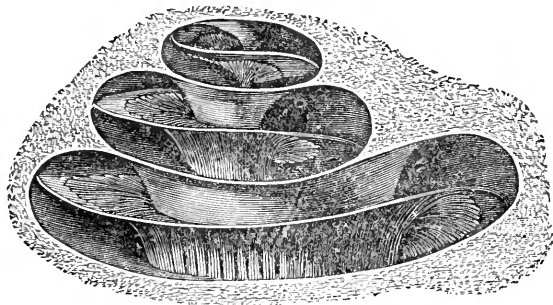

Cochlea of a new-born infant, opened on the side towards the apex of the petrous bone. It shows the general arrangement of the two scalæ, the lamina spiralis, and the distribution of the cochlear nerve. At the apex is seen the modiolus expanding into the cupola, where the spiral canal terminates in a cul-de-sac. The helicotrema is not visible in this view. From Arnold.]

formed upon the same plan, as it presents in Man; in the Monotremata, however, it more approaches that of Birds. The cochlea of the Mammalia in general is a spiral, forming about two turns and a half; the partition which

[Fig. 184.]

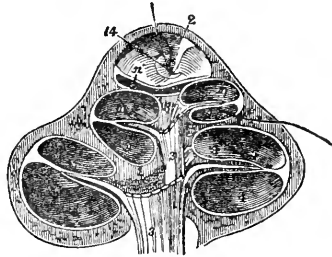

The Cochlea divided parallel with its axis, through the centre of the Modiolus; after Breschet; 1, the modiolus; 2, the infundibulum in which the modiolus terminates; 3, 3, the cochlear nerve, sending its filaments through the centre of the modiolus; 4, 4, the scala tympani of the first turn of the cochlea; 5, 5, the scala vestibula of the first turn; 6, section of the lamina spiralis, its zonula ossea; one of the filaments of the cochlear nerve is seen passing between the two layers of the lamina spiralis to be distributed upon the membrane which invests the lamina; 7, the membranous portion of the lamina spiralis; 8, loops formed by the filaments of the cochlear nerve; 9, 9, scala tympani of the second turn of the cochlea; 10, 10, scala vestibula of the second turn; the septum between the two is the lamina spiralis; 11, the scala tympani of the remaining half turn; 12, the remaining half turn of the scala vestibula; the dome placed over this half turn is the cupola; 13, the lamina of bone which forms the floor of the scala vestibula curving spirally round to constitute the infundibulum (2); 14, the helicotrema through which a bristle is passed; its lower extremity issues from the scala tympani of the middle turn of the cochlea.]

divides its canal is partly osseous, partly membranous; and its two passages communicate with the tympanic cavity and the vestibule respectively. The cavity of the tympanum is very large in some species, extending even into the contiguous bones. All the Mammalia, except the aquatic tribes, have an external ear; and this is sometimes of an enormous size in proportion to the dimensions of the body, as it is in the Bats. The labyrinth of the higher Vertebrata contains no otolithes.

559. The ultimate terminations of the fibres of the Auditory nerve, are

Fig. 185.

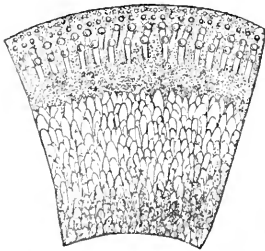

Papillæ (?) of the Auditory nerve, on a segment of the spiral lamina of the cochlea of a young Mouse; the lower portion is the osseous, and the higher the membranous part of the lamina. Magnified 300 times.

[Fig. 186.]

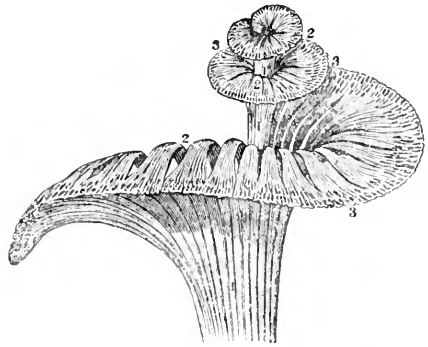

The Auditory Nerve taken out of the Cochlea; 1, 1, 1, the trunk of the nerve; 2, 2, its filaments in the zona ossea of the lamina spiralis; 3, 3, its anastomoses in the zona vesicularis.]

best seen in the *lamina spiralis* of the cochlea, and its membranous prolongation. Much diversity exists, however, as to the interpretation of the ap-

[Fig. 187.

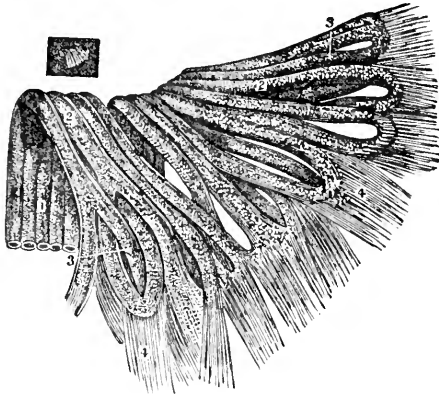

A highly magnified view of a small piece of the Lamina Spiralis, showing the globular structure of the Nerves, and the manner in which they leave their Neurilemma as they anastomose; the natural size of the piece is seen on the side of the figure: 1, portion of the auditory nerve; 2, 2, osseous canals in the zona ossea of the lamina spiralis; 3, 3, anastomoses in the zona mollis; 4, 4, the neurilemma leaving the nervous loops and interlocking to form the layer of the zona membranacea.]

[Fig. 188.

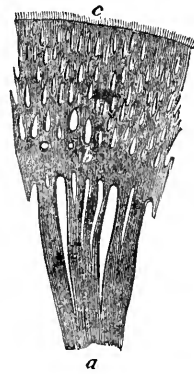

Plexiform arrangement of the cochlear nerves seen in the basal coil of the lamina spiralis, treated with hydrochloric acid. There are no ganglion globules in this plexus, which consists of tubular fibres. *a*, Twig of cochlear nerve in the modiolus, its fibres diverging and reuniting in *b*, a band in the plexus taking a direction parallel to the zones. From this other twigs radiate, and again and again branch and unite as far as the margin of the osseous zone *c*, where they terminate. From the sheep. Magnified 30 diameters.]

pearances there seen; some observers affirming that there are no free or papillary terminations, and that the nervous fibres all return by loops; whilst others state that the papillæ are clearly to be distinguished. The fact appears to be that, as in the retina, the fibres do form a minute plexus; but that fibres are connected with this, which end, or rather commence in papillæ. The Auditory nerve is also very minutely distributed on the membrane lining the vestibule and semicircular canals; and in the ampullæ or dilated extremities of the latter, there are little projections of this membrane internally, which are largely supplied with nerves.

560. In order to gain any definite idea of the uses of different parts of the Ear, it is necessary to bear in mind, that sounds may be propagated amongst solid or fluid bodies in three ways,—by *reciprocation*, by *resonance*, and by *conduction*.—1. Vibrations of *reciprocation* are excited in a sounding body, when it is capable of yielding a musical tone of definite pitch, and another body of the same pitch is made to sound near it. Thus if two strings of the same length and tension be placed along side of each other, and one of them be sounded with a violin-bow, the other will be thrown into reciprocal vibration; or if the same tone be produced near the string in any other manner, as by a flute, or a tuning-fork, the same effect will result.—2. Vibrations of *resonance* are of somewhat the same character; but they occur when a sound-

[Fig. 189.]

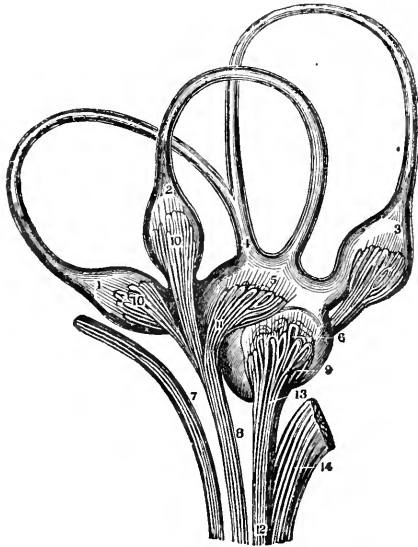

The soft parts of the Vestibule taken out of their bony case, so as to show the distribution of the Nerves in the Ampullæ; 1, the superior semicircular membranous canal or tube; 2, the external semicircular tube; 3, the inferior semicircular tube; 4, the tube of union of the superior and inferior canals; 5, the saccus ellipticus; 6, the saccus sphericus; 7, the portio dura nerve; 8, the anterior fasciculus of the auditory nerve; 9, the nerve to the saccus sphericus; 10, 10, the nervous fasciculi to the superior and external ampullæ; 11, the nerve to the saccus ellipticus; 12, the posterior fasciculus of the auditory nerve, furnishing 13, the filaments of the saccus sphericus, and 14, the filaments of the cochlea, cut off.]

[Fig. 190.]

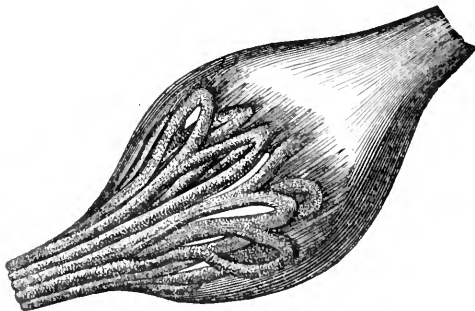

The Ampulla of the External Semicircular Membranous Canal, showing the Mode of termination of its Nerve.]

ing body is placed in connection with any other, of which one or more parts may be thrown into reciprocal vibration, even though the tone of the whole be different, or it be not capable of producing a definite tone at all. This is the case, for example, when a tuning-fork in vibration is placed upon a sound-board; for even though the whole board have no definite fundamental note,*

* The *fundamental note* of a body is the lowest tone which it will yield, when the whole of it is in vibration together. By dividing the body into two or more distinct parts, it may

it will divide itself into a number of parts, which will reciprocate the original sound, so as greatly to increase its intensity; and the same sound-board will act equally well for tuning-forks of several different degrees of pitch. When a smaller body is used for resonance, however, it is essential that there should be a relation between its fundamental note and that of the sonorous body; otherwise no distinct resonance is produced. Thus, if a tuning-fork in vibration be held over a column of air in a tube, of such a length that the same note would be given by its vibration, its sound will be reciprocated. And if it be held over a pipe, the column of air in which is a multiple of this, the column will divide itself into that number of shorter parts, each of which will reciprocate the original sound, and the total action will be one of resonance. But if the length of the pipe bear no such correspondence with the note sounded by the tuning-fork, no resonance is given by the column of air it contains.—3. Vibrations of *conduction* are the only ones by which sounds can strictly be said to be propagated. These are distinguishable into various kinds, into which it is not requisite here to inquire. It should be remarked, however, that all media, fluid, liquid, or solid, are capable of transmitting sound in this manner,—a vacuum being the only space through which it cannot pass. The transmission is usually much more rapid through solid bodies, than through liquid; and through liquid, than through gaseous. The greatest diminution in the intensity of sound is usually perceived, when a change takes place in the medium through which it is propagated, especially from the aeriform to the liquid.

561. The detailed application of these principles has been most elaborately worked out by Müller; and the following statement of what may be regarded as the present condition of our knowledge of the subject, is little more than an abstract of his results. Considering it desirable, in the first place, to establish the conditions under which those animals hear that are constantly immersed in water, he made a series of experiments, from which he draws the following conclusions:—i. Sonorous vibrations, excited in water, are imparted with considerable intensity to solid bodies.—ii. Sonorous vibrations of solid bodies are communicated with greater intensity to other solid bodies brought in contact with them, than to water; but with much greater intensity to water, than to atmospheric air.—iii. Sonorous vibrations are communicated from air to water with great difficulty,—with very much greater difficulty than they are propagated from one part of the air to another; but their transition from air to water is much facilitated, by the intervention of a membrane extended between them.—iv. Sonorous vibrations are not only imparted from water to solid bodies with definite surfaces, which are in contact with the water, but are also returned with increased intensity by these bodies to the water; so that the sound is heard loudly in the vicinity of those bodies, in situations where, if it had its origin in the conducting power of the water alone, it would be faint.—v. Sonorous undulations, propagated through water, are partially reflected by the surfaces of solid bodies.—vi. Thin membranes conduct sound in water without any loss of its intensity, whether they be tense or lax.—From iii., iv., and vi., we learn the mode in which the sound

be made to give a great variety of sounds. Thus, if a stretched string be divided by a bridge into two equal parts, each will sound the octave of the fundamental note, or the 8th note above it. If it be divided into three parts, each will give the 12th above the fundamental note; if into four, the 15th or double octave will be heard; if into five, the 17th; if into six, the 19th; if into seven, the 20 $\frac{1}{2}$ th (flat seventh above the second octave); if into eight, the 22d or triple octave. A string forcibly set in vibration has a tendency to sound these harmonics with the fundamental note, by spontaneous division into several distinct segments of vibration; as may be easily made evident by striking one of the lower keys of the piano, and listening to the sounds heard whilst the fundamental note is dying away.

is conducted to the ear, in aquatic animals not breathing atmospheric air. The labyrinth of such is either entirely inclosed within the bones of the head, as in the Cephalopoda, and in the Cyclostome and Osseous Fishes; or, its cavity being prolonged to the surface of the body, it is there brought into communication with the conducting medium, by means of a membrane,—besides receiving the vibrations through the medium of the solids of the body, as is the case in Cartilaginous Fishes and Crustacea. It would seem as if, in the Osseous Fishes, the resonance of the cranial bones, in which the labyrinth is imbedded, were sufficient to give the requisite increase of intensity to the sound; whilst in the Cartilaginous orders, the softness of these bones renders some other means necessary. In addition to this, we find in many Fishes a communication with the air-bladder; which indeed seems to have, in these, but little other use. The mode in which this increases by resonance the intensity of the sounds, will appear from the following experimental conclusions.—vii. When sonorous vibrations are communicated from water to air inclosed in membranes or solid bodies, a considerable increase in the intensity of the sound is produced, by the resonance of the air thus circumscribed.—viii. A body of air inclosed in a membrane, and surrounded by water, also increases the intensity of the sound by resonance, when the sonorous undulations are communicated to it by a solid body. From these observations, it may be concluded, that the air-bladder of Fishes, in addition to other uses, serves the purpose of increasing by resonance the intensity of the sonorous undulations, communicated from the water to the body of the Fish. Moreover, as the conducting and resonant power of the air in the air-bladder is greater in proportion to its density, the influence of this organ on the perception of sounds will, of course, be greater in deep waters, where the pressure upon it is considerably increased.

562. Most animals living in air, are provided with an opening into the vestibule, covered by a thin membrane; and, in the majority of cases, with the tympanic apparatus also. The following experimental results bear upon the manner in which the Ear of such animals is affected by sound.—ix. Sonorous undulations, in passing from air directly into water, suffer a considerable diminution in their strength; while, on the contrary, if a tense membrane exists between the air and the water, the sonorous undulations are communicated from the former to the latter medium with great intensity.—x. The sonorous vibrations are also communicated without any perceptible loss of intensity, from the air to the water; when, to the membrane forming the medium of communication, there is attached a short solid body, which occupies the greater part of its surface, and is alone in contact with the water.—xi. A small solid body, fixed in an opening by means of a border of membrane, so as to be movable, communicates sonorous vibrations, from air on one side, to water or the fluid of the labyrinth on the other, much better than solid media not so constructed. But the propagation of sound to the fluid is rendered much more perfect, if the solid conductor, thus occupying the opening, is by its other end fixed to the middle of the tense membrane, which has atmospheric air on both sides.—The fact stated in ix. is evidently one of great importance in the physiology of hearing; and fully explains the nature of the process in those animals which receive the sonorous vibrations through air, but which have no tympanic apparatus. In x. we have the elucidation of the action of the fenestra ovalis, and of the movable plate of the stapes which occupies it, in animals living in air, but destitute of tympanic apparatus; this is naturally the case in many Amphibia; and it may happen as the result of disease in the Human subject. In xi. we have a very interesting demonstration of the purpose and action of the tympanum, in the more perfect forms of the auditory apparatus. We are now prepared to inquire, in somewhat more

of detail, into the action of the different parts of this apparatus ; and it will be better to commence with that of the Internal Ear, the accessory organs being afterwards considered.

563. The object of the *Membrana Tympani* is evidently to receive the sonorous undulations from the air, in such a manner as to be thrown by them into a reciprocal vibration, which is to be communicated to the chain of bones. This membrane is, in its usual state, rather lax than tense ; and this laxity is found by experiment to be, for a small membrane, the best condition for the propagation of ordinary sounds. This is easily rendered sensible in one's own person ; for an increased tension may be given to the *membrana tympani*, either by holding the breath and forcing air into the Eustachian tube, so as to distend it from within, or by exhausting the cavity, so as to cause the external air to make increased pressure upon it. In either case the hearing is found immediately to become indistinct. It is observed, however, that grave and acute sounds are not equally affected by this action ; for the experimenter renders himself deaf to grave sounds, whilst acute sounds are heard even more distinctly than before. This fact is easily understood by referring to the laws of Acoustics already mentioned. The greater the tension to which the *membrana tympani* is subjected, the more acute will be its fundamental tone ; and as no proper reciprocation can take place in it, to any sound *lower* than its fundamental tone, its power of repeating perfectly the vibrations proper to the deeper notes will diminish. The nearer a sound approaches to the fundamental note proper to the tense membrane, the more distinctly will it be heard. On the other hand, when the membrane is in its natural lax condition, its fundamental note is very low, and it is capable of repeating a much greater variety of sounds ; for, when it receives undulations of a higher tone, than those to which the whole membrane would reciprocate, it divides itself into distinct segments of vibration, which are separated by lines of rest ; and every one of these reciprocates the sound ;* at the same time rendering it more intense by multiplication. These facts enable us to understand the influence of the tensor tympani muscle, in modifying the tension of the membrane, and thus causing it to vibrate in reciprocation to sounds having a great variety of fundamental notes. Moreover, the fact that some persons are deaf to grave sounds, whilst they readily hear the more acute, is thus accounted for. The tensor tympani, like the iris, is probably excited to operation by a reflex action ; and it is by no means improbable that one of its functions may be, to prevent the internal ear from being too violently affected by loud sounds, by putting the *membrana tympani* into such a state of tension, as not readily to reciprocate them.

564. The uses of the Tympanic cavity are very obvious. One of its purposes is, to render the vibrations of the membrane quite free ; and the other, to isolate the chain of bones, in such a manner as to prevent their vibrations from being weakened, by diffusion through the surrounding solid parts. As to the objects of the Eustachian tube, however, opinions have been much divided. From the experiments of Muller it appears, that it does not increase the intensity of sound, but that it prevents a certain degree of dulness, which would attend it, if the cavity of the tympanum were completely closed ; of this dulness we are conscious, when any tumefaction of the fauces causes an occlusion of the extremity of the tube. It has been supposed that, among other uses,

* This is very easily proved by experiments on a membrane stretched over a resonant cavity ; if light sand be strewed upon it, and a strong musical tone be produced in its vicinity, the membrane will immediately be set in vibration, not as a whole (unless its fundamental note be in unison with that sounded), but in distinct segments, of which every one reciprocates the sound ; from the vibrating parts, the sand will be violently thrown off ; but it will settle on the intermediate lines of rest, forming a variety of curious figures, which are known as the *nodal* lines.

this canal serves for the conduction of the speaker's voice to his ears ; but this is certainly not the case in any considerable degree ; for, when the Eustachian tubes are obstructed by disease, the patient hears his own voice well, though other sounds are indistinct ; and it is easily shown, that its transmission is chiefly accomplished in other ways. The common idea is, that it serves the same purpose with the hole in an ordinary drum ; the effect of which is generally supposed to be, the removal of the impediment to the vibrations of the membrane, that would be offered by the complete inclosure of the air within. It does not appear, however, that any such impediment is really offered ; and the effect of the hole in the drum seems rather to be the communication, to the ear of the auditor, of the sonorous vibrations of the contained air ; which are thus transmitted directly through the atmosphere, instead of being weakened by transmission through the walls of the instrument. Hence there is no real analogy in the two cases. The principal object of the Eustachian tube (which is always found where there is a tympanic cavity), seems to be, the maintenance of the equilibrium between the air within the tympanum and the external air ; so as to prevent inordinate tension of the *membrana tympani*, which would be produced by too great or too little pressure on either side, and the effect of which would be imperfection of hearing. It also has the office of conveying away mucus secreted in the cavity of the tympanum, by means of cilia vibrating on its lining membrane ; and the deafness, consequent on occlusion of this tube, is in part explicable by the accumulation, which will then take place in the tympanum.

565. From what has been stated, it is evident that sonorous undulations taking place in the air, will be propagated to the fluid contained in the labyrinth,—through the tympanum, the chain of bones, and the membrane of the *fenestra ovalis* to which the stapes is attached,—without any loss, but rather an increase, of intensity. Why water should be chosen as the medium through which the impression is to be made upon the nerve, it is impossible for us to say with anything like certainty, in our present state of ignorance as to the physical character of that impression. But, the problem being, to communicate to water the sonorous undulations of air, the experimental results already detailed satisfactorily prove that,—whilst this may be accomplished, in a degree sufficient for the wants of the inferior animals, by the simple interposition of a tense membrane between the air and the fluid,—the tympanic apparatus of the higher classes is most admirably adapted for this purpose. The *fenestra ovalis* is not, however, the only channel of communication between the tympanum and the labyrinth ; for there is, in most animals, a second aperture, the *fenestra rotunda*, leading into the cochlea, and simply covered with a membrane. It is generally supposed that, the labyrinth being filled with a nearly incompressible fluid, this second aperture is necessary to allow of the free vibration of that fluid,—the membrane of the *fenestra rotunda* being made to bulge out, as that of the *fenestra ovalis* is pushed in. It may, however, be easily shown by experiment, as well as by reference to comparative anatomy, that no such contrivance is necessary ; for sonorous undulations may be excited in a non-elastic fluid, completely inclosed within solid walls at every part, except where these are replaced by the membrane through which the vibrations are propagated ; and this is precisely the condition, not only of the Invertebrated animals, but even of Frogs ; in which last a tympanic apparatus exists, without a second orifice into the labyrinth. Moreover it is certain, that the vibrations of the air in the cavity of the tympanum, must of themselves act upon the membrane of the *fenestra rotunda* ; and this is perhaps the most direct manner in which the fluid in the cochlea will be affected ; although it will ultimately be thrown into much more powerful action, by the transmission of vibrations from the vestibule. For it has been satisfactorily determined by

[Fig. 191.]

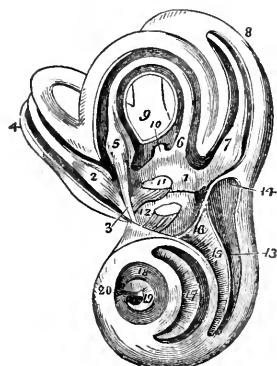

The labyrinth of the Left Ear, laid open in order to show its cavities and the Membranous Labyrinth; after Breschet; 1, the cavity of the vestibule, opened from its anterior aspect in order to show the three-cornered form of its interior, and the membranous labyrinth which it contains; the figure rests upon the common saccule of the membranous labyrinth—the sacculus communis; 2, the ampulla of the superior or perpendicular semicircular canal, receiving a nervous fasciculus from the superior branch of the vestibular nerve; 3, 4, the superior or perpendicular canal with its contained membranous canal; 5, the ampulla of the inferior or horizontal semicircular canal, receiving a nervous fasciculus from the superior branch of the vestibular nerve; 6, the termination of the membranous canal of the horizontal semicircular canal in the sacculus communis; 7, the ampulla of the middle or oblique semicircular canal, receiving a nervous fasciculus from the inferior branch of the vestibular nerve; 8, the oblique semicircular canal with its membranous canal; 9, the common canal, resulting from the union of the perpendicular with the oblique semicircular canal; 10, the membranous common canal terminating in the sacculus communis; 11, the otoconite of the sacculus communis seen through the membranous parietes of that sac; a nervous fasciculus from the inferior branch of the vestibular nerve is seen to be distributed to the sacculus communis near to the otoconite; the extremity of the sacculus above the otoconite is lodged in the superior ventricle of the vestibule, and that below it in the inferior ventricle; 12, the sacculus proprius situated in the anterior ventricle; its otoconite is seen through its membranous parietes, and a nervous fasciculus derived from the middle branch of the vestibular nerve, is distributed to it; the spaces around the membranous labyrinth are occupied by the aqua labyrinthi; 13, the first turn of the cochlea; the figure is situated in the scala tympani; 14, the extremity of the scala tympani corresponding with the fenestra rotunda; 15, the lamina spiralis; the figure is situated in the scala vestibuli; 16, the opening of the scala vestibuli into the vestibule; 17, the second turn of the cochlea; the figure is placed upon the lamina spiralis, and, therefore, in the scala vestibuli, the scala tympani being beneath the lamina; 18, the remaining half turn of the cochlea; the figure is placed in the scala tympani; 19, the lamina spiralis terminating in a falciform extremity; the dark space included within the falciform curve of the extremity of the lamina spiralis is the helicotrema; 20, the infundibulum.]

experiment (xii.), that vibrations are transmitted with very much greater intensity to water, when a tense membrane, and a chain of insulated solid bodies capable of free movement, are successively the conducting media, than when the media of communication between the vibrating air and the water are the same tense membrane, air, and a second membrane:—or, to apply this fact to the organ of hearing, the same vibrations of the air act upon the fluid of the labyrinth with much greater intensity, through the medium of the chain of auditory bones and the fenestra ovalis, than through the medium of the air of the tympanum and the membrane closing the fenestra rotunda.—The fenestra rotunda is not to be considered as having any peculiar relation with the cochlea; since, in the Turtle tribe, the former exists without the latter.

566. In regard to the functions of particular parts of the labyrinth, no certainty can be said to exist. From the experimental results already stated, it appears likely that, the greater the extension of the cavity into the dense substance of the bone, the greater will be the resonance communicated to the fluid, and thence transmitted to the nerves exposed to its influence.—It is

[Fig. 192.]

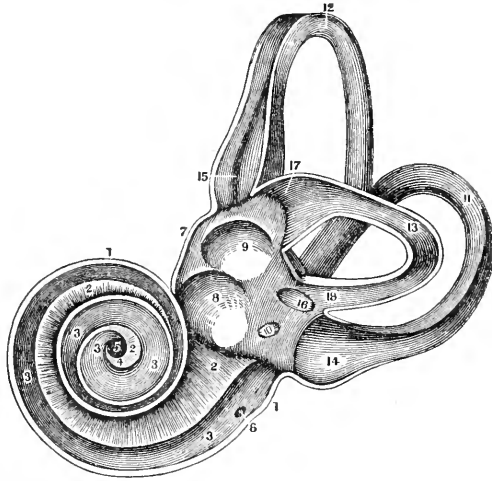

A view of the labyrinth of the Left Side, laid open in its whole extent so as to show its Structure; these figures are all magnified; 1, the thickness of the outer covering of the cochlea; 2, 2, the scala vestibuli or upper layer of the lamina spiralis; 3, 3, the scala tympani or lower layer of the lamina spiralis; 4, the hamulus cochleæ; 5, centre of the infundibulum; 6, the foramen rotundum communicating with the tympanum; 7, the thickness of the outer layer of the vestibule; 8, the foramen rotundum; 9, the fenestra ovalis; 10, the orifice of the aqueduct of the vestibule; 11, the inferior semicircular canal; 12, the superior semicircular canal; 13, the external semicircular canal; 14, the ampulla of the inferior canal; 15, the ampulla of the superior canal; 16, the common orifice of the superior and inferior canals; 17, the ampulla of the external canal.]

commonly supposed that the Semicircular Canals have for their peculiar function, the reception of the impressions by which we distinguish the *direction* of sounds; and it is certainly a powerful argument in support of this view, that, in almost every instance in which these parts exist at all, they hold the same relative position to each other as in Man, their three planes being nearly at right angles to one another. The idea, however, must be regarded as a mere speculation, the value of which cannot be decided without an increased knowledge of the laws, according to which sonorous vibrations are transmitted.—Regarding the special function of the Cochlea, there is precisely the same uncertainty. This part of the organ is peculiar in one respect,—that the expansion of the auditory nerve is here spread out (upon the lamina spiralis) in closer proximity with the bone itself, than it is in any other part of the labyrinth; so that the vibrations of the bone will be more directly communicated to the nerve. It is not easy to see, however, what can be the peculiar object of this disposition, in regard to the function of hearing. By M. Dugès it is surmised, that by the cochlea we are especially enabled to estimate the *pitch* of sounds, particularly of the voice; and he adduces, in support of this idea, the fact, that the development of the cochlea follows a very similar proportion with the compass of the voice. This is much the greatest in the Mammalia; less in Birds; and in Reptiles, which have little true vocal power, the cochlea is reduced to its lowest form, disappearing entirely in the Amphibia. That there should be an acoustic relation between the voice and ear of each species of animal, cannot be regarded as improbable; but the speculation of M. Dugès can at present only be received as a stimulus to further inquiry.

567. We have now to consider the functions of the accessory parts,—the External Ear, and the Meatus. The Cartilage of the external ear may pro-

pagate sonorous vibrations in two ways,—by reflection, and by conduction. In reflection, the concha is the most important part, since it directs the reflected undulations towards the tragus, whence they are thrown into the auditory passage. The other inequalities of the external ear cannot promote hearing by reflection; and the purpose of the extension of its cartilage is evidently to receive the sonorous vibrations from the air, and to conduct them to its point of attachment. In this point of view, the inequalities become of importance; for those elevations and depressions upon which the undulations fall perpendicularly, will be affected by them in the most intense degree; and in conse-

[Fig. 193.]

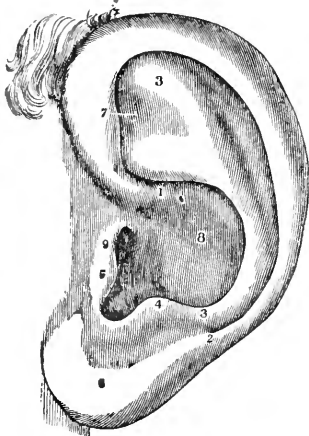

A view of the Left Ear in its natural state; 1, 2, the origin and termination of the helix; 3, the anti-helix; 4, the anti-tragus; 5, the tragus; 6, the lobus of the external ear; 7, points to the scapha and is on the front and top of the pinna; 8, the concha; 9, the meatus auditorius externus.]

[Fig. 194.]

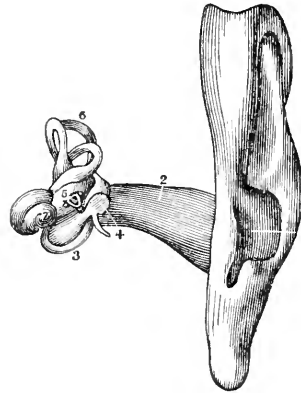

An anterior view of the External Ear, as well as of the Meatus Auditorius, Labyrinth, &c.; 1, the opening into the ear at the bottom of the concha; 2, the meatus auditorius externus or cartilaginous canal; 3, the membrana tympani stretching upon its ring; 4, the malleus; 5, the stapes; 6, the labyrinth.]

quence of the varied form and position of these inequalities, sonorous undulations, in whatever direction they may come, must fall advantageously upon some of them.—The functions of the Meatus appear to be threefold. The sonorous undulations entering from the atmosphere are propagated directly, without dispersion, to the membrana tympani:—the sonorous undulations received on the external ear, are conveyed along the walls of the meatus to the membrana tympani:—the air which it contains, like all insulated masses of air, increases the intensity of sounds by resonance. That, in ordinary hearing, the direct transmission of atmospheric vibrations to the membrana tympani, is the principal means of exciting the reciprocal vibrations of the latter, is sufficiently evident; the undulations which directly enter the passage, will pass straight on to the membrane; whilst those that enter obliquely will be reflected from side to side, and at last will fall obliquely on the membrane, thus perhaps contributing to the notion of direction. The power of the lining of the meatus to conduct sound from the external ear, is made evident by the fact, that, when both ears are closely stopped, the sound of a pipe having its lower extremity covered by a membrane, is heard more distinctly, when it is applied to the cartilage of the external ear itself, than when it is placed in contact with the surface of the head. The resonant action of the air in the tube is easily demonstrated, by lengthening the passage by the introduction of

another tube; the intensity of external sounds, and also that of the individual's own voice, as heard by himself, is then much increased.

568. Many facts prove, however, that the fluid of the labyrinth may be thrown into vibration in other ways, than by the tympanic apparatus. Thus in Osseous Fishes, it is only by the vibrations transmitted through the bones of the head, that hearing can take place. There are many persons, again, who can distinctly hear sounds which are thus transmitted to them; although, through some imperfection of the tympanic apparatus, they are almost insensible to those which they receive in the ordinary way. It is evident, where this is the case, that the nerve must be in a state fully capable of functional activity; and, on the other hand, where sounds cannot thus be perceived, there will be good reason to believe that the nerve is diseased.

569. A single impulse communicated to the Auditory nerve, in any of the foregoing modes, seems to be sufficient to excite the momentary sensation of *sound*; but most frequently a series of such impulses is concerned, there being but few sounds which do not partake, in a greater or less degree, of the character of a *tone*. Any continuous sound or tone is dependent upon a succession of such impulses; and its acuteness or depth is governed by the rapidity with which they succeed one another.

a. It is not difficult to ascertain by experiment, what number of such impulses or undulations are required, to give every tone which the ear can appreciate. Thus, if a circular plate, with a number of apertures at regular intervals, be made to revolve over the top of a pipe through which air is propelled, a succession of short *puffs* will be allowed to issue from this; and, if the revolution is sufficiently rapid, these impulses will unite into a definite tone. In the same manner, if a spring be fixed near the edge of a revolving toothed wheel, in such a manner as to be caught by every tooth as it passes, a succession of *clicks* will be heard; and these too, if the revolution of the wheel be sufficiently rapid, will produce a tone. The number of apertures in the plate, which pass the orifice of the pipe in a given time, or the number of teeth which pass the spring, being known, it is easy to see, that this must be the number of impulses required to produce the given tone. Each impulse produces a double vibration,—forwards and backwards (as is seen when a string is put in vibration, by pulling it out of the straight line); hence the number of impulses is always half that of the single vibrations. The maximum and minimum of the intervals of successive pulses, still appreciable by the ear as determinate sounds, have also been determined by M. Savart, more satisfactorily and more accurately than had previously been done. If their intensity is great, sounds are still audible which result from the succession of 24,000 impulses in a second; and this, probably, is not the extreme limit to the acuteness of sounds perceptible by the ear. From some observations of Dr. Wollaston's, it seems probable that the ears of different individuals are differently constituted in this respect,—some not being able to hear very acute tones produced by Insects, or even Birds, which are distinctly audible to others. Again, the sound resulting from 16 impulses per second, is not, as has been usually supposed, the lowest appreciable note; on the contrary, M. Savart has succeeded in rendering tones distinguishable, which are produced by only 7 or 8 impulses in a second; and continuous sounds of a still deeper tone could be heard, if the individual pulses were sufficiently prolonged. In regard, however, to the precise time during which a sonorous impression remains upon the ear, it is difficult to procure exact information, since it departs more gradually than do visual impressions from the eye. This is certain, however,—that it is much longer than the interval between the successive pulses in the production of tones; since it was found by M. Savart, that one or even several teeth might be removed from the toothed wheel, without a perceptible break in its sound,—showing that, when the tone was once established, the impression of it remained during an intermission of some length.

570. The Ear may, like the Eye, vary considerably, as regards general acuteness amongst different individuals; and its power may be much increased by practice. A part of this increase depends, however, as in other instances, upon the greater attention which its fainter indications receive; but a part, also, upon an increased use of the organ. The power of hearing very faint sounds, is as different from the power of distinguishing musical tones, as the power of discerning very minute objects, or of seeing with very faint degrees of light, is from that of distinguishing colours. Many persons are altogether

destitute of what is termed a musical ear ; whilst others are endowed with it in a degree, which is a source of great discomfort to them, since every discordant sound is a positive torment. The power of distinguishing the *direction* of sounds appears to be, in Man, at least, for the most part acquired by habit. It is some time before the infant seems to know anything of the direction of noises, which attract his attention. Now although there can be no question, that this perception is acquired by attention to certain variations in the impression made upon the nerve, through the medium either of the tympanic apparatus, or of the bones of the head, yet it is equally evident, that there can be nothing in these variations themselves adequate to excite the idea, and that it must therefore be either intuitive or acquired by habit. This is a consideration of some importance, in regard to the similar question as to the sense of Visual direction. In some cases we are probably assisted by the relative intensity of the sensations, communicated by the two ears respectively. The idea of the *distance* of the sonorous body is another acquired perception, depending principally upon the loudness or faintness of the sound, when we have no other indications to guide us. In this respect, there is a great similarity between the perception of the distance of an object, through the Eye, by its size, and through the Ear, by the intensity of its sound. When we know the size of the object, or are acquainted with the usual intensity of its sound, we can judge of its distance ; and vice versâ, when we know its distance, we can at once form an idea of its real from its apparent size, and of its real strength of tone from that which affects our ears. In this manner, the mind may be affected with corresponding deceptions through both senses ; thus, in the Phantasmagoria, the figure is gradually diminished whilst its distance remains the same, and it appears to the spectators to recede,—the illusion being more complete, if its brightness be at the same time diminished ; and the effect of a distant full military band gradually approaching, may be alike given by a corresponding *crescendo* of concealed instruments. It is upon the complete imitation of the conditions which govern our ideas of the intensity and direction, as well as of the character, of sounds, that the deceptions of the Ventriloquist are founded.

571. Some facts of much interest have lately been ascertained, in regard to an occasional variation in the rapidity of the perception of sensory impressions, received through the Eye and through the Ear. These facts are the result of comparisons made amongst different astronomical observers, who may be watching the same visual phenomena, and *timing* their observations by the same clock ; for it has been remarked, that some persons see the same phenomenon, a third or even half of a second earlier than others. There is no reason to suppose from this, however, that there is any difference in the rate of transmission of the sensory impressions in the two nerves. The fact seems rather to be, that the sensorium does not readily perceive two different impressions with equal distinctness ; and that, when several impressions are made on the nerves at the same time, the mind takes cognizance of one only, or perceives them in succession. When, therefore, both sight and hearing are directed simultaneously to one object, the communication of the impression through one sense will necessarily precede that made by the other. The interval between the two sensations is greater in some persons than in others ; for some can receive and be conscious of many impressions, seemingly at the same moment ; whilst in others a perceptible space must elapse.

572. Amongst other important offices of the power of Hearing, is that of supplying the sensations by which the Voice is regulated. It is well known that those who are born entirely deaf, are also dumb,—that is, destitute of the power of forming articulate sounds ; even though not the least defect exist in their organs of voice. Hence it appears that the vocal muscles can only be

guided in their action by the sensations received through the Ears, in the same manner as other muscles are guided by the sensations received through themselves (§ 433). On this point, more will be said hereafter (§ 611).

CHAPTER VII.

OF MUSCULAR ACTION.

1.—Of Contractility in General.

573. THE Nervous System has no power of occasioning movement in any part of the body, save by exciting to contraction certain structures, to which the term *Muscular* is given. That one tissue should possess within itself the property of Contractility on the application of a stimulus, is no more wonderful, than that another should be capable of conveying sensory or motor influences, or another of separating a peculiar secretion from the blood. Such contractile tissues are found in Vegetables, as well as in Animals; and they appear to consist, in both instances, of *cells*, whose peculiar property it is to change their form, when subjected to certain kinds of irritation (§ 230). The only essential difference in function, between the Contractility of the cells composing the ultimate fibrillæ of Muscular Fibre, and that of the cells composing the intumescence of the Sensitive Plant, consists in the susceptibility of the former to a stimulus, which does not operate on the latter. Both can be made to change their form by stimuli of various kinds,—mechanical, chemical, electrical, &c.,—directly applied to themselves; but the contractility of Muscular fibre is excited, in addition, by the stimulus of Innervation, which has no operation in the Plant; and it is when its peculiar property is thus excited, that the Muscular tissue becomes the instrument of the operation of the Nervous system upon the external world, and thus performs an important part in the purely Animal Functions.—The Muscular tissue, however, is not always thus called into activity through the medium of the Nervous system; for it is employed to execute numerous movements, which are immediately connected with the maintenance of the Organic functions, and in which the influence of Innervation seems to be but little concerned; its contractility being excited to action by stimuli directly applied to itself.—We have seen that there are two forms of Muscular tissue, the *striated* and the *non-striated*, which are appropriated to these two purposes; the former being the kind most readily acted on through the Nervous System, and invariably employed in the Muscles that are called into action by its influence; whilst the latter (which seems a less perfectly-developed form of the tissue) is with difficulty excited to contraction through the Nervous System, and is usually employed in Muscles, whose action is altogether uncontrollable by the will (§§ 225—234).

574. The general property of Contractility shows itself under two forms; which are alike distinct in the mode of their action, and in the conditions requisite for its excitation.—Its most obvious and striking manifestations present themselves in the Voluntary muscles and in the Heart; which, when in activity, exhibit powerful contractions tending to alternate with relaxations. The modification of contractility which is concerned in producing these, is distinguished as *Irritability*.—On the other hand, we find that the muscles

exhibit a tendency to a moderate and permanent contraction, which is not shown by them when they are dead, and which cannot, therefore, be the result of elasticity, or of any simple physical property; and the contraction, instead of being a result of stimulation through the nerves, is especially excited by changes of temperature in the tissue itself. This endowment, which seems to exist in the greatest amount in certain forms of the non-striated muscle, is called *Tonicity*.—These two modifications of Muscular Contractility require a separate consideration.

2.—Of Muscular Irritability.

575. All Muscular Fibres, which are in possession of vital activity, may be caused to contract by stimuli directly applied to themselves; and these stimuli may be of different kinds. The simplest is the contact of a solid substance, especially if it be pointed; thus we may excite contractions in Muscular fibres, by simply touching them with the point of a needle or of a scalpel. Most substances of strong chemical action, such as acids and alkalies, will excite the fibres to contraction, when directly applied to themselves; but the most powerful agent of all is Electricity.—If we thus irritate a portion of a muscle composed of *striated* fibre, the biceps, for example, the fasciculus of fibres which is touched will immediately contract, and that one only; and the contracted fasciculus will soon relax, without communicating its movements to any other. In fact, the only way to call the entire muscle into contraction at once (since it would be impossible to apply direct irritation to every fasciculus), is to stimulate it through its nerves. On the other hand, if we apply a similar irritation to a portion of *non-striated* fibre, as that of the Intestinal canal, the fasciculus which is stimulated will contract less suddenly, but ultimately to a greater amount; its relaxation will be less speedy; and, before it takes place, other fasciculi in the neighbourhood begin to contract; their contraction propagates itself to others; and so on. In this manner, successive contractions and relaxations may be produced through a considerable part of the canal, by a single prick with a scalpel; a sort of wave of contraction being transmitted in the direction of its length, and being followed by relaxation. Again, in the Muscular structure of the Bladder and Uterus (which is of the non-striated kind), direct irritation excites immediate and powerful contractions, which extend beyond the fasciculus actually irritated, and produce a great degree of shortening; but they do not alternate in the healthy state with any rapid and decided elongation. In the Heart, which is composed of a mixture of striated and non-striated fibre, the Muscular substance of a large part of the organ is thrown into rapid and energetic contraction, by a stimulus applied at any one point; and this contraction is speedily followed by relaxation, which is again succeeded by a number of alternating contractions and relaxations. And in the muscular tissue of the middle coat of the Arteries, which is of the non-striated character, the contraction takes place rather after the manner of that of the bladder and uterus; a considerable degree of shortening being effected, by the contraction of other fasciculi than those directly irritated, and this shortening not giving way speedily to relaxation; but a prolonged application of the stimulus is often necessary to produce the effect.

576. On the other hand, when the stimuli which excite Muscular Contractility are applied to the *nerves*, which supply any muscle composed of *striated* fibre (the Heart only excepted), they produce a simultaneous contraction in the whole muscle; the effect of the stimulus being at once exerted upon every part of it. The contraction speedily alternates with relaxation, unless the operation of the stimulus be continued,—as when an electric current is propagated without intermission along the nerve-trunks,—in which case the contraction lasts as

long as the stimulus is continuously applied, but ceases as soon as it is withdrawn. But it has been lately stated by Volkmann,* that, if the electric stimulus be applied to the central organs, from which the motor nerves arise, the muscular contraction continues for some time after its renewal. If this should prove to be a universal fact, it will afford a valuable means of distinguishing what are the real centres of the motor nerves of particular organs. Further, when the continuous electric current was passed through *incident* or *excitor* nerves, it produced alternating movements of contraction and relaxation, in the muscles which were thus called into play by reflex stimulation. The ordinary actions of the *non-striated* fibre, on the other hand, are *not* easily excitable by stimuli applied to their nerves; indeed many Physiologists have denied the possibility of producing them through this channel. Positive evidence to this effect, however, has been already given (§ 388). The results of Volkmann's recent electrical experiments upon the Heart and the Intestinal Canal are of much interest. He found that neither of these organs is thrown into fixed contraction, when the continuous electric current is applied to the Brain and Spinal Cord; whence he concludes that these organs are *not* the centres of *their* motor nerves. On the other hand, alternating contractions and relaxations were produced on applying the continuous current to the spinal cord, the par vagum, and the sympathetic nerves; whence it may be concluded that these parts contain afferent fibres, which excite motion through centres that can scarcely be any others than the ganglia of the Sympathetic system. When the Heart is removed from the body, and is left entire, it may be thrown into a state of fixed contraction, which lasts after the cessation of the current; whence it may be concluded, that it contains the centre of its own motor nerves.† These experiments, however, by no means warrant the conclusion, that the ordinary actions of these muscular organs are *dependent* upon the agency of their nerves; which is opposed by a variety of evidence.

577. The general fact, that Muscular Contraction alternates with Relaxation at no longer intervals,—is most evident in the rhythmical movements of the Heart, and in the peristaltic action of the Intestinal canal; since in those parts, the whole or a large proportion of the fibres seem to contract together, and then shortly relax. But it is probably no less true, as formerly stated (§ 232), of the individual fibres of those muscles, which are kept in a state of contraction by a stimulus transmitted through their nerves; since none of them appear, under ordinary circumstances at least, to remain in a contracted state for any length of time,—a constant interchange of condition taking place among the fibres, some contracting whilst others are relaxing, and *vice versâ*. It is difficult to speak with confidence, however, in regard to the condition of the individual fibres of a muscle, that is thrown into a state of *continued spasmodic* contraction; such as that produced by the application of the electric current to the centre of its motor nerves (§ 576). A state of this kind is often of considerable duration. Thus the Author has known a case of Hysterical Trismus, in which the jaws remained closed with the greatest violence during five days. Whether the individual fibres, in such instances, maintain a state of contraction without intermission, or whether the contraction of the entire muscle is kept up by a continual interchange of the fibres actually engaged, is a very curious subject for inquiry.

578. Muscles do not lose their Irritability immediately on the *general death* of the system, which must be considered as taking place, when the circulation ceases without a power of renewal; in cold-blooded animals it is re-

* Müller's Archiv., 1844, No. 5, p. 407.

† Op. cit.; and Mr. Paget's Report for 1845, in Brit. and For. Med. Rev., July, 1846.

tained much longer after this period than in the higher Vertebrata, in some of which it disappears within an hour. The muscles of young animals generally retain their irritability for a longer time than those of adults; on the other hand, those of Birds lose their irritability sooner than those of Mammalia. Hence, as a general rule, the duration of the irritability is inversely as the amount of respiration. From experiments on the bodies of executed criminals, who were previously in good health, Nysten ascertained that, in the Human subject, the irritability of the several muscular structures departs in the following time and order.—The left ventricle of the heart first; the intestinal canal at the end of 45 or 55 minutes; the urinary bladder nearly at the same time; the right ventricle after the lapse of an hour; the œsophagus at the expiration of an hour and a half; the iris a quarter of an hour later; the muscles of Animal life somewhat later; and lastly, the auricles of the heart, especially the right, which in one instance contracted under the influence of galvanism 16½ hours after death.

579. Muscular Irritability is deadened by many substances, especially by those which have a narcotic or sedative action on the Nervous system. In carbonic acid gas, hydrogen, carbonic oxide, or sulphurous acid gas, muscles contract very feebly, or not at all, when stimulated; whilst in oxygen they retain their irritability longer than usual. Narcotic substances, such as a watery solution of opium, when applied directly to the muscles, have an immediate and powerful effect in diminishing or even destroying their irritability; this effect is also produced, though in a less powerful degree, by injecting these substances into the blood. In the same manner, venous blood, charged with carbonic acid, and deficient in oxygen, has the effect of a poison upon muscles; diminishing their irritability, when it continues to circulate through them, to such a degree, that they sometimes lose it almost as soon as the circulation ceases, as is seen in those who have died from gradual and therefore prolonged Asphyxia. The unfavourable influence of venous blood is also shown in the *Morbus Cœruleus*; patients affected with which are incapable of any considerable muscular exertion.—Although most of the stimuli which occasion the contraction of muscles, when directly applied to their fibres, operate also when applied to their motor nerves, the same does not hold good in regard to those agents which diminish irritability. It is a fact of some importance, in relation to the disputed question of the connection of muscular irritability with the nervous system, that when, by the application of narcotic substances to the Nerves, *their* vital properties are destroyed, the irritability of the Muscle may remain for some time longer,—showing that the latter must be independent of the former.

580. We find, however, that sudden and severe injuries of the Nervous Centres have power to impair, directly and instantaneously, or even to destroy, the Contractility of the whole Muscular system; so that death immediately results, and no irritability subsequently remains. It is in this manner, that the *sudden* destruction of the Brain and Spinal Cord, especially of the latter, occasions the immediate cessation of the Heart's action; though they may be *gradually* removed, without any considerable effect upon it. Severe concussion has the same effect; hence the Syncope which *immediately* displays itself. It is sometimes an important question in Forensic Medicine, whether an individual, who has died from the effects of a blow upon the head, could have moved from the place where the blow was inflicted. If there be found, as is frequently the case, no sensible disorganization of the Brain, the death must be attributed to the concussion, and must have been in that case *immediate*. If, on the other hand, effusion of blood has taken place within the cranium, to any considerable extent, it is probable that the first effects of the blow were in some degree recovered from, and that the circulation was re-

established.—It is not essential, however, that the impression should be primarily made upon the Cerebro-Spinal system. The well-known fact of sudden death not unfrequently resulting from a blow on the stomach, especially after a full meal, without any perceptible lesion of the viscera, clearly indicates that an impression upon the widely-spread cœliac plexus of Sympathetic nerves (which will be much more extensively communicated to them, when the stomach is full, than when it is empty), may cause the immediate cessation of the Heart's action, in the same manner as a violent injury of the Brain or Spinal Cord.—Now it is interesting to remark that, in all these cases, *the whole vitality* of the system appears to be destroyed at once; for the processes which would otherwise succeed the injury, and which, after other kinds of death, less sudden in their character, produce evident changes in the part of the surface that has immediately received it, are here entirely prevented. An instance is on record, in which a criminal under sentence of death determined to anticipate the law by self-destruction. Having no other means of accomplishing his purpose, he stooped his head and ran violently against the wall of his cell; he immediately fell dead; and *no mark of contusion* showed itself on his forehead. The same absence of the usual results is to be noticed in the case of blows on the stomach. Yet it is well known, that many of the ordinary vital processes will take place in the injured parts, after death of a more lingering nature; the vitality of the individual organs not being destroyed immediately on the severance of the chain which binds together the different functions. Hence the Irritability of Muscle is not shown, by the foregoing facts, to have any closer dependence upon the Nervous system, than have the peculiar vital properties of any other tissue.

581. The influence of severe impressions on the Nervous System, in diminishing, where it does not altogether destroy, Muscular Irritability, is well seen in the effect of severe injuries affecting vital organs, or extending over a large part of the surface, in depressing the Heart's action. This is a well-known result of severe burns, especially in children, whose nervous system is more susceptible of such impressions than that of the adult; also of the rupture of the alimentary canal, of the bladder or uretus; and of the shattering of one of the extremities, by violence affecting a large part of their substance. In all these cases, the sufferer is in the same condition with one who has received a severe blow on the head, that does not quite stun him; the shock immediately diminishes the muscular contractility of the whole system; and its influence on the heart, which of course manifests itself most conspicuously, produces a degree of depression which is frequently never recovered from, and which, at any rate, renders necessary the employment of stimulants, for the purpose of counteracting this very dangerous effect.*—Excessive mental emotion, of a kind not in itself depressing, may occasion the sudden cessation of the Heart's action, and a general loss of muscular Irritability; and it is well known that muscular power is greatly diminished by emotions, which produce no other direct action.

582. There is no evidence that Muscular Irritability can be *increased* by any cause operating through the Nervous system. It is quite true that, under

* The large quantity of stimulus which can be borne even by children, suffering under severe burns, is very extraordinary. There can be no doubt that many lives have been saved by the judicious administration of them, to an amount which would, *à priori*, have been judged in itself fatal; but that many more have been sacrificed to neglect, even on the part of those whose duty it is to watch the indications with the closest attention. The Author's observation leads him to believe, that Hospital-Nurses very commonly make up their minds, that children, who have met with severe burns, *must* die; and that, unless closely watched, they neglect the means of which Science and Experience alike dictate the free employment.

the stimulus of alcohol, nitrous oxide, &c., or of some purely mental excitement, individuals can perform actions requiring a degree of strength, which they cannot exert under any other circumstances. But it does not hence follow, that the irritability is increased; since the energy of the action may be due solely to the power of the stimulus by which it is excited, and to the unusual number of fibres called into simultaneous contraction. It is well known that stimulating agents, which thus temporarily increase Muscular power, primarily excite the Nervous system; as is shown by the increased mental activity which results from the moderate use of alcohol, nitrous oxide, opium, &c.; and it does not seem necessary, therefore, to go further in search of an explanation of their effect on muscular action.—It is worthy of remark that, whilst the influence of general *depressing* causes acting through the Nervous System, is primarily manifested on the muscles of Organic life, that of *stimulants* chiefly shows itself in the muscles subjected to the Will.

583. There can be no question that, in the living body, the energy of Muscular contraction is determined (other things being equal), by the supply of Arterial Blood, which the muscle receives. It is well known that, when a ligature is applied to a large arterial trunk in the Human subject, there is not only a deficiency of sensibility in the surface, but also a partial or complete suspension of muscular power, until the collateral circulation is established. The same result has been constantly attained, in experiments upon the lower Animals; the contractility of the muscle being impaired or altogether extinguished, when the flow of blood into it was arrested; and being recovered again, when the supply of blood was restored. The influence of this supply of arterial blood is twofold;—it affords the materials for the nutrition of the tissue;—and it furnishes (what is perhaps more *immediately* necessary) the supply of oxygen required for that *metamorphosis* of the tissue, which seems to be an essential condition of the generation of its contractile force. As this oxygen is taken in through the lungs, and as the greater part of it is thrown off—when united with carbon into carbonic acid—by the same channel, we should expect to find a very close correspondence between the amount of muscular power developed in an animal, and the quantity of oxygen consumed in its Respiration: and this is in reality the case. We find, for example, that in Birds and Insects, whose respiration is the highest, the muscular power is greater in proportion to their size, than in any other animals. In the Mammalia, and certain Fishes that might be almost called warm-blooded, it is only in a degree inferior. But in the cold-blooded Reptiles, Fishes, and Mollusca, the muscular power is comparatively feeble; though even here we trace gradations, which accord well with the relative quantities of oxygen consumed. But in proportion to the feebleness of the power, do we usually find its duration greater (§ 578); so that it is not so immediately dependent upon the supply of oxygen, in cold-blooded, as in warm-blooded animals. Thus, it is found that Frogs are still capable of voluntary movement, after the heart has been cut out; they can move limbs which are connected with the trunk by the nerves alone: and that this power is not altogether due to the blood which may remain in the capillary vessels, is shown by the experiment of Muller, who found the muscles still contractile, after he had expelled all the blood, by forcing a current of water into an artery, until it escaped from the divided veins.

584. It seems probable that the Muscles of Organic life are less dependent upon a supply of arterialized blood, than are those of Animal life; for the Heart will continue to contract, when the blood in its vessels is entirely venous, and when the circulation in it has come to a stand. Still the dependence of its action upon a constant supply of arterial blood, is very close; and in all animals, however different the plans of their circulation, we find a provision

for this supply, by a special arrangement of the coronary arteries.* That the heart's action comes to an end much sooner, after the destruction of animal life by *pithing*, when the coronary arteries have been tied, than when they are left untouched, has been proved by the experiments of Mr. Erichsen.† In an animal that has been pithed, but whose heart has been left intact, artificial respiration will easily keep up its action for an hour, or an hour and a half. But when the coronary arteries were tied, a mean of six experiments gave a duration, for the ventricular action, of only $23\frac{1}{2}$ minutes after the ligatures were applied, and $32\frac{1}{2}$ minutes after the pithing; and in no instance was it prolonged more than 31 minutes after the application of the ligature, or 37 minutes after the pithing. On the other hand, when the aorta was tied, so that the coronary arteries were distended with blood, the circulation being carried on through them alone, the right ventricle continued to act up to the 82d minute.

585. There is a remarkable difference in the degree of Irritability in the two sides of the heart, to which Dr. M. Hall has directed attention. In the warm-blooded Vertebrata, the right side of the heart will act on the stimulus of venous blood; whilst the left side requires the stimulus of arterial. In Fishes, on the other hand, whose heart corresponds to the right side only of that of Man, the whole is put in action by venous blood. In Reptiles, one auricle is sufficiently stimulated by venous blood, whilst the other requires arterial; and the ventricle is excited to action by a mixed fluid. In all these cases, there must be a marked difference in the properties of the several parts; some being sufficiently affected by a stimulus, which is totally inoperative on others. This is still more remarkably exemplified by the fact, that the muscular fibre of Frogs would be thrown into a state of permanent and rigid contraction (through the powerful operation of its property of Tonicity), by the stimulus of a fluid no hotter than the blood, which ordinarily bathes the muscles of Birds. Now in those warm-blooded animals which pass the winter in a state of torpidity, the respiration is very slow and imperfect, and the blood is very imperfectly arterIALIZED. There must, therefore, be a change in the properties of the left ventricle, by which it becomes capable of action on a more feeble stimulus, thus resembling the ventricle of Reptiles.

a. This change Dr. M. Hall designates as an *increase* of Irritability; considering that, if muscular action be excited by a more feeble stimulus, the property to which that action is due, must be itself more exalted. Physiologists have been so long accustomed, however, to consider the irritability of the muscles in warm-blooded animals as greater than that of cold-blooded, on account of the greater energy and rapidity of their contractions when excited, that it seems undesirable to modify the term in the manner proposed by Dr. Hall. No one will assert that the *vitality* of the Muscles is *exalted*, when it is reduced to the condition of that of the Reptile; and, as Irritability is strictly a vital property, it cannot be correctly spoken of in that manner. The general principle, however, laid down by Dr. M. Hall,—that the facility with which the muscular system may be excited to contraction, or in other words the feebleness of the stimulus required for the purpose, is inversely as the respiration of the animal,—is, no doubt, generally correct.

586. The doctrine, now generally accepted as a Physiological truth, that the active exercise of the Contractility of Muscle, is attended with a *waste* or *disintegration* of its tissue, rests upon a great variety of evidence. The increase of the demand for food, occasioned by Muscular activity (§ 263), is an indication that the nutritive operations are excited by it; and the purpose of these can scarcely be anything else, than the reparation of the loss which the Muscle has sustained. Again, it has been just shown, that the presence of Oxygen is essential to the development of the Contractile force; and there is evidence that, in this development, a chemical change is effected in the substance of the

* Dr. M. Hall's Gulstonian Lectures, pp. 23, 24.

† Medical Gazette, July 8, 1842.

Muscle, which is of a nature destructive to its integrity as an organized tissue. For, in the first place, the researches of Helmholtz, formerly referred to (§ 238, *b*), indicate such a change, from the comparative results of Chemical analysis of the muscle, before and after the violent excitement of its contractility. But it is still more decidedly shown, by the increase in the excretions, which is consequent upon Muscular activity; and especially by the augmentation of the Carbonic acid set free from the respiratory organs, and by that of the Urea set free from the kidneys. The amount of the latter, indeed, may be regarded, *cæteris paribus*, as an approximative indication of the quantity of Muscular tissue which has undergone disintegration; being increased or diminished, in precise proportion to the degree of exertion to which the Muscular system has been subjected.—It cannot but be regarded as a probable inference from these facts, that the development of the Contractile force is in some way dependent upon the Chemical change, which seems to be so essential a condition of it; just as the development of the Electric force of the Galvanic battery is dependent upon the new chemical arrangements, which take place between the bodies brought to act upon one another in its trough.

587. The frequently-renewed exercise of Muscles, by producing a determination of blood towards them, occasions an increase in their nutrition; so that a larger amount of new tissue becomes developed, and the muscles are increased in size and vigour. This is true, not only of the whole Muscular system when equally exercised; but also of any particular set of muscles, which is more exercised than another. Of the former we have examples in those who practise a system of Gymnastics adapted to call the various muscles alike into play; and of the latter, in the limbs of individuals who follow any calling, that habitually requires the exertion of either pair, to the partial exclusion of the other,—as the arms of the Smith, or the legs of the Operadancer. But this increased nutrition cannot take place, unless an adequate supply of food be afforded; and if the amount of nutritive material be insufficient, the result will be a progressive diminution in the size and power of the muscles; which will manifest itself the more rapidly, as the amount of exertion, and consequently the degree of *waste*, are greater. Nor can it be effected, if the exercise be too constant; for it is during the intervals of repose that the reparation of the muscular tissue occurs; and the Muscular system, like the Nervous (§ 294), may be worn out by too constant use. The more violent the action, the longer is the period of subsequent repose, which is required for the reparation of the tissue: and the longest will, of course, be requisite, when (as sometimes occurs) the contractility of the muscle is so completely exhausted by excessive stimulation, that no new manifestation of it can be excited. Nevertheless it is certain, that there must be a provision in *some* Muscles, for the continuance of their nutrition during their state of activity; for in no other way could the Heart and Respiratory Muscles, which are in unceasing action during the whole of life, be kept in a state fit for the discharge of their functions.

588. On the other hand, Muscular Irritability, like the vital properties of other parts, is diminished by want of action; and in this, as in other cases, it is quite clear that the cause of its loss is to be found in the alteration of the nutritive processes, which is the uniform result of the cessation of the usual operations of any part. The Muscular tissue, like all other soft organized substances, has a constant tendency to spontaneous disintegration, especially at the high temperature of the body in warm-blooded animals; and it is consequently subject to a slow and regular *waste*, quite irrespectively of that produced by its vital activity.* Now when a Muscle or set of Muscles, in a

* This does not occur with nearly the same rapidity in cold-blooded Animals, nor in the

warm-blood animal, is reduced to a state of prolonged inactivity, from whatever cause, its supply of blood is diminished, and its spontaneous decay is not compensated by an equally active renewal; so that, in time, the characters of the structure are changed, and its distinguishing properties are no longer presented. Thus in persons whose lower extremities have been long disused, the muscles first become pale and flabby; their bulk gradually diminishes; their contractile force progressively decreases, and at last departs altogether; and their proper structure is replaced by a deposit of fat, intermixed with ordinary fibrous tissue, in which few or no characteristically-striated muscular fibres can be detected.

589. The continual and evident influence of the Nervous System upon Muscular Irritability, has led many Physiologists to the belief, that the latter is *dependent* upon the agency of the former. Two views upon this question have been commonly taught, to both of which it seems necessary to devote a brief consideration.—The first of these is, that Muscular Irritability is derived from some influence or energy communicated from the Brain or Spinal Cord.

a. This opinion is evidently analogous to that which attributes the vital properties of other parts to the Nervous System alone; and it is open to the same objection, *in lamine*, which has been applied to the latter,—the improbability that any one of the solid textures of the living body, should have for its office to give to any other the power of performing any vital action. Moreover it is inconsistent with the fact that, in Vegetables, tissues endowed with a high degree of contractility exist, and manifest their property when a stimulus is directly applied to themselves; which, nevertheless, can have no dependence whatever upon a nervous system. In the lower classes of Animals, too, there is good reason to believe, that the property is much more universally diffused through their tissues, than nervous agency can be. Again, the action of the heart may be kept up, in the highest Animals, by taking care that the current of the circulation be not interrupted, for a long time after the removal of the brain and spinal cord; it may even continue when completely separated from the body, which shows that the great centres of the ganglionic system cannot supply any influence necessary to it; and there are many instances, in which the human fetus has come to its full size, so that its heart must have regularly acted, without the existence of a brain or spinal cord. Further, the irritability of muscles of the first class continues for a long time after their nerves are divided, and may be called into action by stimuli directly applied to the parts themselves, or to their nerves below the section, so long as their nutrition is unimpaired.

b. The loss of the irritability of Muscles, within a few weeks after the section of their nerves,—on which great stress has been laid by Müller in support of a modified form of the above doctrine, (it being maintained by this distinguished physiologist, that, if muscular irritability is not *dependent* on the Brain and Spinal Cord, they supply some influence essential to its exercise.)—is clearly due to the alteration in their nutrition, consequent upon their disuse. This has been recently proved to demonstration, by the very ingenious experiments of Dr. J. Reid.* “The spinal nerves were cut across, as they lie in the lower part of the spinal canal, in four frogs; and both posterior extremities were thus insulated from their nervous connections with the spinal cord. The muscles of one of the paralyzed limbs were daily exercised by a weak galvanic battery; while those of the other limb were allowed to remain quiescent. This was continued for two months; and at the end of that time, the muscles of the exercised limb retained their original size and firmness and contracted vigorously, while those of the quiescent limb had shrunk to at least one-half of their former bulk, and presented a marked contrast with those of the exercised limb. The muscles of the quiescent limb still retained their contractility, even at the end of two months; but there can be little doubt that, from their imperfect nutrition, and the progressing changes in their physical structure, this would in no long time have disappeared, had circumstances permitted the prolongation of the experiment.”† This experiment satisfactorily explains the fact ob-

hibernating condition of certain warm-blooded Mammalia; indeed, when the temperature of the body is reduced to within a few degrees of the freezing point, no chemical change seems possible in muscle,—its spontaneous decay, and its vital activity, being alike checked.

* Edinburgh Monthly Journal of Medical Science, May, 1841.

† A fact of an exactly parallel character has fallen under the Author's observation, in a case of Hysterie Paraplegia, in which one leg was occasionally affected with severe cramps. The muscles of this leg suffered much less diminution of size and firmness, than those of

served by Dr. M. Hall, and heretofore adverted to (§ 399). that in cases in which the cause of the paralysis is situated in the Brain, and in which the Spinal Cord and its nerves are unaffected, the irritability of the muscles of the paralyzed part is not destroyed, even after a considerable lapse of time. For, if the capability of performing reflex actions still exist, on the part of the nervous system, it is manifest that the muscles will be occasionally excited to action through this channel; and that their nutrition and vital properties will thereby be preserved, as they were in Dr. Reid's experiments by the artificial excitement of galvanism. Hence Dr. M. Hall's opinion, that the property of Muscular contractility is derived from the Spinal Cord, is no more tenable than that which locates it in the Brain.

c. The loss of irritability from section of the nerves, takes place more speedily in warm-blooded Vertebrata, all whose vital operations are performed with a much greater activity, than in Reptiles, and other cold-blooded animals. Dr. Reid found that, in a Rabbit, a portion of whose sciatic nerve had been removed on one side, the muscles of that leg were but very feebly excited to contraction by Galvanism, after the lapse of seven weeks. The change in their nutrition was evident to the eye, and was made equally apparent by the balance. The muscles of the paralyzed limb were much smaller, paler, and softer, than the corresponding muscles of the opposite leg; and they scarcely weighed more than half,—being only 170 grains, whilst the others were 327 grains. It was found, also, that a perceptible difference existed in the size of the bones of the leg, even after so short an interval had elapsed; the tibia and fibula of the paralyzed limb weighing only 81 grains, whilst those of the sound limb weighed 89 grains. On examining the muscular fibres with the microscope, it was found that those of the paralyzed leg were considerably smaller than those of the sound limb, and presented a somewhat shrivelled appearance; and that the longitudinal and transverse striæ were much less distinct.

d. Another equally satisfactory proof, that the loss of Irritability, which follows the severance of the connection between the Nervous centres and the Muscle, is not immediately due to the interruption of any influence communicated by the former, has been given by the experiments of Dr. J. Reid. He has proved, that if the irritability of Muscles be exhausted by means, which have no tendency to impair their healthy nutrition, and the other conditions favour the normal performance of the nutrient processes, the irritability is restored, and remains for some time. His first experiments were on cold-blooded animals, and they would in themselves be sufficiently satisfactory; but he has since repeated them in the Rabbit, and established the fact beyond all doubt.* "The sciatic nerve was divided in the Rabbit, and a portion of it removed. One wire from two galvanic batteries consisting of thirty pairs of plates, was applied over the course of the nerve; and the other wire was applied over the foot, which was kept moist, until the muscles had ceased to contract. Three days after this, a weaker battery was used, and the muscles of the limb had recovered their contractility, and contracted powerfully. The more powerful battery was used as before, until the muscles had ceased to respond to the excitement; and three days after this, they had again recovered their contractility." It seems scarcely possible to draw any other inference from these experiments, than that Irritability is a property inherent in Muscular tissue, and that the agency of the Nervous system upon it is merely to call it into active operation.

590. The second doctrine referred to, as having been taught by some Physiologists, is, that Muscles, though not dependent on nerves for their peculiar vital power, are yet dependent upon them for the exercise of that power;—all stimuli, which excite muscles to contraction, operating first on the nervous filaments which enter muscles, and through them on the muscular fibres.

a. The facts which have been already stated, in regard to the ordinary action of the Muscles of Organic life, furnish a sufficient answer to this hypothesis. It is with great difficulty that these can be made to display their irritability, by any stimuli applied to their nerves; whilst they manifest it strongly, when the stimulus is directly applied to themselves. Even in the Muscles of Animal life, individual fasciculi may be thrown into action in the same manner; although the entire mass cannot be put into combined operation, except by a stimulus simultaneously communicated to the whole, which the nerve affords the readiest means of effecting. Perhaps the most satisfactory disproof of it, however, is to be found in the ob-

the other; so that there was a difference of more than an inch in the circumference of the limbs. But since the paraplegia has been recovered from, voluntary power having been established in both limbs, and the muscles of both having been exercised in the same degree, they have greatly improved in size and firmness, and there is no longer any perceptible difference between them.

* Loc. cit.

ervation of Mr. Bowman already cited (§ 231), that a single fibre, completely isolated from all its connections, may be seen with the microscope to pass into a state of contraction, under the influence of direct irritation. Further, it has been experimentally ascertained, that there are some chemical stimuli, which will produce the contraction of muscles when directly applied to them, but of which the influence cannot be transmitted through the nerves; this is especially the case with regard to acids.

591. When all these considerations are allowed their due weight, we can scarcely do otherwise than acquiesce fully in the doctrine of Haller, which involves no hypothesis, and which is perfectly conformable to the analogy of other departments of Physiology. He regarded every part of the body which is endowed with Irritability, as possessing that property in and by itself; but considered that the property is subjected to excitement and control from the Nervous System, the agency of which is one of the stimuli that can call it into operation.—It may be desirable briefly to recapitulate the facts, by which this doctrine is supported. 1. The existence in Vegetables of irritable tissues, which are excited to contraction by stimuli directly applied to themselves, and which can be in no way dependent upon, or influenced by, a Nervous system. 2. The existence in Animals of a form of Muscular tissue, which is especially connected with the maintenance of the Organic functions, and which is much more readily excited to action by direct stimulation, than it is by Nervous agency. 3. The fact that, by the agency of these, the Organic functions may go on (as long as their other requisite conditions are supplied) after the removal of the nervous centres, and when none were ever present; rendering it next to certain, that their ordinary operations are not dependent upon any stimuli received through the nerves, but upon those directly applied to themselves. 4. The persistence of irritability in muscles, for some time after the nerves have ceased to be able to convey them the effects of stimuli; this is constantly seen in regard to the Sympathetic system of nerves, and the muscles of Organic life upon which they operate; and it may also be shown to occur with respect to the Cerebro-Spinal system, and the muscles of Animal life, by the agency of narcotics. 5. The persistence of irritability in the muscles, after their complete isolation from the nervous centres, so long as their nutrition is unimpaired; and the effects of frequent exercise, in preventing the impairment of the nutrition and the loss of irritability. 6. The recovery of the irritability of muscles, when isolated from the nervous centres, after it has been exhausted by repeated stimulation; this also depends upon the healthy performance of the nutritive actions. 7. The contraction of muscular fibre under the microscope, when completely isolated from all other tissues.—In the words of Dr. Alison, then, “the only ascertained final cause of all endowments bestowed on Nerves in relation to Muscles, in the living body, appears to be, not to make Muscles irritable, but to subject their irritability, in different ways, to the dominion of the acts and feelings of the Mind,”—to its volitions, emotions, and instinctive determinations.

592. A curious question has been lately raised, the decision on which is of some importance in our determination of the nature of the force, by which the contraction of muscles is occasioned. This is,—whether the power of a muscle is greater or less at different degrees of contraction, the same stimulus being applied. This seems to have been determined, by the ingeniously-devised experiments of Schwann.* He contrived an apparatus, which should accurately measure the length of the muscle, and, at the same time, the weight which it would balance by its contraction. Having caused the muscle of a Frog to shorten to its extreme point, by the stimulus of galvanism applied to the nerve, so that no further stimulation could lift a weight placed in the opposite scale, he allowed the muscle to relax until it was extended to a certain

* Müller's Physiology, p. 903.

point, and then ascertained the weight which would balance its power. The same was several times repeated, as in the following manner:—The length of the muscle in its extreme state of contraction, at which no additional force could be exerted by it, being represented by 14, it was found that, when it had been extended to 17, it would balance a weight of 60; when its length increased to 19·6, it would balance a weight of 120; and at 22·5, it would balance 180. In another experiment, the muscle at 13·5, balanced 0; at 18·8, it balanced 100; and at 23·4, it balanced 200. Hence it appears that a uniform increase of force corresponds with a nearly uniform increase in the length of the muscle; or, in other words, that when the muscle is nearly at its full length, its contractile power is the greatest. In later experiments upon the same muscle, this uniform ratio seemed to be departed from; but, by comparing the results in a considerable number of instances, it was constantly found that, in those experiments which were performed the soonest after the preparation of the frog, and in which, therefore, the normal conditions of the system were the least disturbed, the ratio was very closely maintained. It has been ascertained by Valentin, on repeating these experiments, that, by repeated equal irritations, the strength of the muscles in beheaded frogs decreases in a regular and corresponding ratio; losing the same amount in each successive period of time. He also found that, when all the Irritability has ceased, the muscles *tear* with a far less weight, than they were previously able, when galvanized, to *draw*.

a. It has been inferred by Müller, from Schwann's experiments, that the power which causes the contraction of a Muscle, must be very different in its character, from any of the forces of attraction known to us; since these all increase in energy as the attracted parts approach each other, in the inverse ratio of the square of the distance; so that the power of a Muscle, if operated on by any of these, ought to increase, instead of regularly diminishing, with its degree of contraction. But it is to be remembered that, as the observations of Mr. Bowman have clearly shown, there must be a considerable displacement of the constituents of every fibre during contraction (§ 231); so that it is easy to understand that, the greater the contraction, the more difficult must any further contraction become. If, between a magnet and a piece of iron attracted by it, there were interposed a spongy elastic tissue, the iron would cease to approach the magnet at a point, at which the attraction of the magnet would be balanced by the force, needed to compress still further the intermediate substance.

3.—Of Muscular Tonicity.

593. We have now to consider the other form of Contractility, which produces a *constant* tendency to contraction (varying, however, as to its degree) in the Muscular fibre; but which is so far different from simple Elasticity, that it abates after death, before decomposition has taken place. This Tonicity is to be distinguished from the Muscular Tension, which is the result of the reflex operation of the nervous centres (§ 398); being manifested as well when the muscle is altogether removed from nervous influence, as when subjected to it, and being, like Irritability, an inherent property of the tissue itself, the presence of which is characteristic of its living state. It manifests itself in the retraction which takes place in the ends of a living muscle, when it is divided (as is seen in amputation); this retraction being permanent, and greater than that of a dead muscle. But its effects are much more remarkable in the non-striated, than in the striated form of Muscular Fibre; and are particularly evident in the contractile coat of the Arteries, causing the almost entire obliteration of their tubes, when they are no longer distended with blood. The disposition to tonic contraction is increased by any considerable change of temperature; the power of Heat is well seen in the following experiments of John Hunter's:—"As soon as the skin could be removed from a sheep that was newly killed, a square piece of muscle was cut off, which

was afterwards divided into three pieces, in the direction of the fibres; each piece was put into a basin of water, the water in each basin being of different temperatures, viz., one about 125°, about 27° warmer than the animal; another 98°, the heat of the animal; and the third 55°, about 43° colder than the animal. The muscle in the water heated to 125° contracted directly, so as to be half an inch shorter than the other two, and was hard and stiff. The muscle in the water heated to 98° after six minutes began to contract and grow stiff; and at the end of twenty minutes it was nearly, though not quite, as short and hard as the above. The muscle in the water heated to 55° after fifteen minutes, began to shorten and grow hard; after twenty minutes it was nearly as short and as hard as that in the water heated to 98°. At the end of twenty-four hours, they were all found to be of the same length and stiffness.”* The agency of Heat in producing this contraction is also remarkably shown in the fact, that if a Frog be immersed in water of the temperature of 110°, the muscles of its body and limbs will be thrown into a state of permanent and rigid contraction.—But it would seem that these effects are chiefly, if not entirely, exerted upon the striated form of Muscular fibre; and that the tonicity of the non-striated fibre is called into play by Cold, rather than by heat. For if a Tadpole or Frog be immersed in water, the temperature of which is *gradually* raised, until this state of contraction comes on, the Heart will be found to continue pulsating for many hours afterwards, not being affected by the heat. On the other hand, if an artery in a living warm-blooded animal be exposed to cold air for some time, the lowering of its temperature occasions its contraction to such an extent, that its cavity becomes almost obliterated. The influence of warmth in diminishing, and of cold in increasing, the tonicity of the arterial system, will be adverted to hereafter (Chap. XII., Sect. 3).

594. The distinctness of the Tonicity of Muscles from their Irritability, is further shown by the fact that the former commonly survives the latter; and that it is not destroyed by treatment, which occasions the complete departure of the Irritability. The first of these statements finds its proof in the phenomena of the Rigor Mortis, presently to be adverted to. Of the latter, the following remarkable experiment of John Hunter's is an ample demonstration:—“From a straight muscle in a bullock's neck, a portion, three inches in length, was taken out immediately after the animal had been knocked down, and was exposed between two pieces of lead, to a cold below 0°, for fourteen minutes; at the end of this time it was found to be frozen exceedingly hard, was become white, and was now only two inches long; it was thawed gradually, and in about six hours after thawing, it contracted so as only to measure one inch in length; but irritation did not produce any sensible motion in the fibres. Here, then, were the juices of muscles frozen, so as to prevent all power of contraction in their fibres, without destroying their life; for when thawed, they showed the same life which they had before; this is exactly similar to the freezing of blood too fast for its coagulation, which, when thawed, does afterwards coagulate, as it depends in each on the life of the part not being destroyed.”†

595. The *Rigor Mortis*, or death-stiffening of the muscles, is probably to be regarded as the final manifestation of this property; occurring after all the Irritability of the muscles has departed, but before any putrefactive change has commenced. This phenomenon is rarely absent; though it may be so slight, and may last for so short a time, as to escape observation. The period which elapses before its commencement, is as variable as its duration; and

* General Principles of the Blood, in Hunter's Works, Vol. iii., p. 110. .

† Op. cit., p. 109.

both appear to be in some degree dependent upon the vital condition of the body at the time of death. When the fatal termination has supervened on slow and wasting disease, occasioning great general depression of the vital powers, the rigidity usually develops itself very early, and lasts for a short time. In diseases which powerfully affect the nervous energy, such as Typhus, this is often the case; even though they have not been of long duration. Thus, after death from Typhus, the limbs have been sometimes known to stiffen within fifteen or twenty minutes. The same is observed in infants and in old people. On the other hand, where the general energy has been retained up to a short period before death, the rigidity is much later in coming on, and lasts longer; this happens, for example, in many cases of Asphyxia and Poisoning, in which it has been said not to occur at all. The commencement of the rigidity, however, is not usually prolonged much beyond seven hours; but twenty or even thirty hours *may* elapse, before it shows itself. Its general duration is from twenty-four to thirty-six hours; but it may pass off much more rapidly; or it may be prolonged through several days. An attempt has been made to connect it with the lowering of the temperature of the dead body; but with this it does not seem to have any relation. It occurs in cold-blooded Vertebrata, and even in Invertebrata, as well as in warm-blooded animals; and it has frequently been noticed to commence in the latter, long before the heat has entirely departed from the body. Moreover, it appears first upon the trunk, which is the region last deserted by the calorific. It first affects the neck and lower jaw, and seems gradually to travel downwards; but according to some observers, the lower extremities are stiffened before the upper. In its departure, which is immediately followed by decomposition, the same order is observed. It affects all the muscles nearly alike; but the flexors are usually more contracted than the extensors, so that the fingers are somewhat flexed on the palm, and the fore-arm on the arm; and the lower jaw, if previously drooping, is commonly drawn firmly against the upper. It is remarkable, that it is equally intense in muscles which have been paralyzed by Hemiplegia; provided that no considerable change has taken place in their nutrition. When very strong, it renders the muscles prominent, as in voluntary contraction.

596. The ordinary Irritability of the muscles appears to be almost invariably lost, or greatly diminished, before the Rigor Mortis commences. This statement holds good in regard to animals of different classes, as well as with respect to Man under various conditions. Thus, in Birds, whose muscles most speedily lose their contractility, the cadaveric rigidity is most quickly exhibited; whilst in Reptiles it is much longer in commencing, the irritability of the muscles being more persistent. The interval between the cessation of the Irritability and the accession of the Rigidity, is sometimes very considerable; and in such cases, the rigidity, when it does occur, is usually very decided and prolonged.—An attempt has been made to show a correspondence between the rigor mortis, and the coagulation of the blood in the vessels; and there is certainly evidence enough to make it appear, that some analogy exists between these two actions, though they are far from being identical. After those forms of death in which the blood does not coagulate, or coagulates feebly, the rigidity commonly manifests itself least; but this is by no means an invariable rule. It seems probable that, as the coagulation of the blood will be shown to be the last act of its vitality, so the stiffening of the muscles is the expiring effort of theirs.

a. It is necessary to bear in mind, when the phenomena of cadaveric rigidity are brought into question in juridical investigations, that a state at first sight corresponding to it may supervene *immediately* upon death, from some peculiar condition of the nervous and muscular systems at the moment. This has been observed in some cases of Asphyxia; but chiefly when death has resulted from apoplexy following chronic *ramollissement* of the brain or spinal

cord. This contraction, which is obviously of a tetanic character, ceases after a few hours, and is then succeeded by a state of flexibility, after which the ordinary rigidity supervenes. The following case illustrates the nature of the inquiries, to which this condition may give rise.* The body of a man was found in a ditch, with the trunk and limbs in such a relative position, as could only be maintained by the stiffness of the articulations. This stiffness must have come on at the very moment when the body took that position; unless it could be imagined that the body had been supported by the alleged murderers, until the joints were locked by cadaveric stiffness. A post-mortem examination showed, that there was no necessity for this supposition,—obviously a very improbable one in itself;—by affording sufficient evidence, that apoplexy, resulting from chronic disease, was the cause of death. A case occurred a few years since in Scotland, in which the same plea was raised. The body was found in a position in which it could have only been retained by rigidity of the joints; and it was pleaded on the part of the prisoner, that death had been natural, and had resulted from fracture of the *processus dentatus*, causing sudden pressure upon the spinal cord, whence the spasmodic rigidity would naturally result. Proof was deficient, however, as to the existence of this lesion before death; and the position of the body rather resembled that into which it might have been forced during the rigidity, than that in which it would probably have been at the moment of death. There were also marks of violence, and many other suspicious circumstances; but the prisoner was acquitted, chiefly from want of evidence against him. What seemed to indicate that the rigidity was of the ordinary cadaveric nature, was, that there was no evidence of the body having become flexible and again stiffened; as it would probably have done, had the rigidity been of the spasmodic character.

597. As the property of Tonicity manifests itself most decidedly in the non-striated muscles in the living body, so do we find this post-mortem contraction most remarkable in them. As soon as the muscular walls of the several cavities lose their irritability, they begin to contract firmly upon their contents, and thus become stiff and firm, though they were previously flaccid. In this manner the ventricles of the heart, which are the first parts to lose their irritability, become rigid and contracted within an hour or two after death; and usually remain in that state for ten or twelve hours, sometimes for twenty-four or thirty-six, then again becoming relaxed and flaccid. This rigid contracted state of the heart, in which the walls are thickened and the cavities diminished, was formerly supposed to be a result of disease, and was termed *concentric hypertrophy*; but it is now known, from the inquiries of Mr. Paget, to be the natural condition of the organ, at the period when the rigor mortis occurs in it.—The contraction of the arterial tubes is so great, as to produce for the time a great diminution in their calibre; and this doubtless contributes to the passage of the blood from the arterial into the venous system, which almost invariably takes place within a few hours after death. The arteries then enlarge again, and become quite flaccid, their tubes being emptied of their previous contents; and it was from this circumstance, that the ancient Physiologists were led to imagine, that the arteries are not destined to carry blood, but air.

4.—Energy and Rapidity of Muscular Contraction.

598. The energy of Muscular contraction is of course to be most remarkably observed in those instances in which the continual exercise of particular parts has occasioned an increased determination of blood towards them, and in consequence a permanent augmentation in their bulk. This has been the case, for example, with persons who have gained their livelihood by exhibiting feats of strength. Much will, of course, depend on the mechanically-advantageous application of muscular power; and in this manner, effects may be produced, even by persons of ordinary strength, which would not have been thought credible. In lifting a heavy weight in each hand, for example, a person who keeps his back perfectly rigid, so as to throw the pressure vertically upon the pelvis, and only uses the powerful extensors of the thigh and calf, by straightening the knees (previously somewhat flexed), and bringing the leg to a right angle with the foot, will have a great advantage over one who uses

* Annales d'Hygiène, tom. vii.

his lumbar muscles for the purpose. A still greater advantage will be gained, by throwing the weight more directly upon the loins, by means of a sort of girdle, shaped so as to rest upon the top of the sacrum and the ridges of the ilia; and by pressing with the hands upon a frame, so arranged as to bring the muscles of the arms to the assistance of those of the legs: in this manner, a single Man of ordinary strength may raise a weight of 2000 lbs.; whilst few who are unaccustomed to such exertions, can lift more than 300 lbs. in the ordinary mode. A man of great natural strength, however, has been known to lift 800 lbs. with his hands; and the same individual performed several other curious feats of strength, which seem deserving of being here noticed. "1. By the strength of his fingers, he rolled up a very large and strong pewter dish. 2. He broke several short and strong pieces of tobacco-pipe, with the force of his middle finger, having laid them on the first and third finger. 3. Having thrust in under his garter the bowl of a strong tobacco-pipe, his legs being bent, he broke it to pieces by the tendons of his hams, without altering the bending of the knee. 4. He broke such another bowl between his first and second fingers, by pressing them together sideways. 5. He lifted a table six feet long, which had half a hundred-weight hanging at the end of it, with his teeth, and held it in that position for a considerable time. It is true, the feet of the table rested against his knees; but, as the length of the table was much greater than its height, that performance required a great strength to be exerted by the muscles of his loins, neck, and jaws. 6. He took an iron kitchen poker, about a yard long, and three inches in circumference, and, holding it in his right hand, he struck it on his bare left arm between the elbow and the wrist, till he bent the poker nearly to a right angle. 7. He took such another poker, and, holding the ends of it in his hands, and the middle of it against the back of his neck, he brought both ends of it together before him; and, what was yet more difficult, he pulled it straight again."* Haller mentions an instance of a man, who could raise a weight of 300 lbs. by the action of the elevator muscles of his jaw: and that of a slender girl, affected with tetanic spasm, in whom the extensor muscles of the back, in the state of tonic contraction or opisthotonos, resisted a weight of 800 lbs., laid on the abdomen with the absurd intention of straightening the body. It is to be recollected, that the mechanical application of the power developed by muscular contraction, to the movement of the body, is very commonly disadvantageous as regards *force*; being designed to cause the part moved to pass over a much greater *space*, than that through which the muscle contracts. Thus the temporal muscle is attached to the lower jaw, at about one-third of the distance between the condyle and the incisors; so that a shortening of the muscle to the amount of half an inch, will draw up the front of the jaw through an inch and a half; but a power of 900 lbs. applied by the muscle, would be required to raise 300 lbs. bearing on the incisors. In the case of the forearm and leg, the disproportion is much greater; the points of attachment of the muscles, by which the knee and elbow-joints are flexed and extended, being much closer to the fulcrum, in comparison with the distance of the points on which the resistance bears.

599. The energy of muscular contraction appears to be greater in Insects, in proportion to their size, than it is in any other animals. Thus a Flea has been known to leap sixty times its own length, and to move as many times its own weight. The short-limbed Beetles, however, which inhabit the ground, manifest the greatest degree of muscular power. The *Lucanus cervus* (Stag Beetle) has been known to gnaw a hole of an inch diameter, in the side of an iron canister in which it had been confined. The *Geotrupes stercorearius* (Dung or shard-born Beetle) can support uninjured, and even elevate

* Desaguliers' Philosophy, Vol. ii.

a weight equal to at least 500 times that of its body. And a small *Carabus* has been seen to draw a weight of 85 grains (about 24 times that of its body) up a plane of 25° ; and a weight of 125 grains (36 times that of its body) up a plane of 5° ; and in both these instances the friction was considerable, the weights being simply laid upon a piece of paper, to which the insect was attached by a string.

600. The rapidity of the changes of position of the component particles of muscular fibres, may, as Dr. Alison justly remarks,* be estimated, though it can hardly be conceived from various well-known facts. The pulsations of the heart can sometimes be distinctly numbered in children, at more than 200 in the minute; and as each contraction of the ventricles occupies only one-third of the time of the whole pulsation, it must be accomplished in 1-600th of a minute, or 1-10th of a second. Again, it is certain that, by the movements of the tongue and other organs of speech, 1500 letters can be distinctly pronounced by some persons in a minute: each of these must require a separate contraction of muscular fibres; and the production and cessation of each of the sounds, imply that each separate contraction must be followed by a relaxation of equal length; each contraction, therefore, must have been effected in 1-1000th part of a minute, or in the 1-10th of a second. Haller calculated that, in the limbs of a dog at full speed, muscular contractions must take place in less than the 1-200th of a second, for many minutes at least in succession.—All these instances, however, are thrown into the shade, by those which may be drawn from the class of Insects. The rapidity of the vibrations of the wings may be estimated from the musical tone which they produce; it being easily ascertained by experiments, what number of vibrations are required to produce any note in the scale. From these data, it appears to be the necessary result, that the wings of many Insects strike the air *many hundred*, or even *many thousand*, times in every *second*.—The minute precision with which the degree of muscular contraction can be adapted to the designed effect, is in no instance more remarkable than in the Glottis. The musical pitch of the tones produced by it, is regulated by the degree of tension of the *chordæ vocales*, which are possessed of a very considerable degree of elasticity (§ 603). According to the observations of Müller,† the average length of these, in the male, in a state of repose, is about 73-100ths of an inch; whilst, in the state of greatest tension, it is about 93-100ths; the difference being therefore 20-100ths, or one-fifth of an inch: in the female glottis, the average dimensions are about 51-100ths, and 63-100ths respectively; the difference being thus about one-eighth of an inch. Now the natural compass of the voice, in most persons who have cultivated the vocal organ, may be stated at about two octaves, or 24 semitones. Within each semitone, a singer of ordinary capability could produce at least ten distinct intervals; so that of the total number, 240 is a very moderate estimate. There must, therefore, be at least 240 different states of tension of the vocal cords, every one of which is producible by the will, without any previous trial; and the *whole* variation in the length of the cords being not more than one-fifth of an inch even in man, the variation required to pass from one interval to another, will not be more than one twelve-hundredth of an inch. And yet this estimate is much below that which might be truly made from the performances of a practised vocalist.‡

* Cyclopaedia of Anatomy and Physiology, Art. Contractility.

† Physiology, 1018.

‡ It is said that the celebrated Made. Mara was able to sound 100 different intervals between each tone. The compass of her voice was at least three octaves, or 22 tones; so that the total number of intervals was 2200, all comprised within an extreme variation of one-eighth of an inch; so that it might be said that she was able to determine the contractions of her vocal muscles to the seventeen-thousandth of an inch.

601. Of the different *associations* of Muscular actions, which are employed for various purposes in the living body, it would be out of place here to speak; since these associations depend upon the Nervous rather than upon the muscular system; and the most important of them have already been considered in detail. It may be mentioned, however, that the aptitude which is acquired by practice, for the performance of particular actions, that were at first accomplished with difficulty, seems to result as much from a change, which the continual repetition of them occasions in the Muscle, as in the habit which the Nervous system acquires, of exciting their performance. Thus almost every person learning to play on a musical instrument, finds a difficulty in causing the two shorter fingers to move independently of each other and of the rest; this is particularly the case in regard to the ring-finger. Any one may satisfy himself of the difficulty, by laying the palm of the hand flat on a table, and raising one finger after the other, when it will be found, that the ring-finger cannot be lifted without disturbing the rest,—evidently from the difficulty of detaching the action of that portion of the *extensor communis digitorum*, by which the movement is produced, from that of the remainder of the muscle. Yet to the practised musician, the command of the will over all the fingers becomes nearly alike; and it can scarcely be doubted that some change takes place in the structure of the muscle, which favours the isolated operation of its several divisions.

CHAPTER VIII.

OF THE VOICE AND SPEECH.

1. *The Larynx, and its Actions.*

602. THE sounds produced by the organ of Voice constitute the most important means of communication between Man and his fellows; and the power of speech has, therefore, a primary influence, as well on his physical condition, as on the development of his mental faculties. Hence, although it only depends on one particular application of muscular force, comparable to that by which other volitional or emotional movements are effected, it seems right, in treating of the Physiology of man, to make it an object of special consideration. In order to understand the nature of the Organ of Voice as a generator of Sound, it is requisite to inquire, in the first, instance, into the sources from which sounds at all corresponding to the human voice are elsewhere obtained. It is necessary to bear in mind, that Vocal Sounds, and Speech or Articulate Language, are two things entirely different; and that the former may be produced in great perfection, where there is no capability for the latter. Hence we should at once infer, that the instrument for the production of Vocal Sounds was distinct from that by which these sounds are modified into articulate speech; and this we easily discover to be the case,—the Voice being unquestionably produced in the Larynx, whilst the modifications of it, by which language is formed, are effected for the most part in the Oral cavity. The structure and functions of the former, then, first claim our attention.

603. It will be remembered that the Windpipe is surmounted by a stout cartilaginous annulus, termed the *Cricoid* cartilage; which serves as a founda-

tion for the superjacent mechanism. This is embraced (as it were) by the *Thyroid*, which is articulated to its sides by its lower horns, round the extremities of which it may be regarded as turning, as on a pivot. In this man-

Fig. 195.

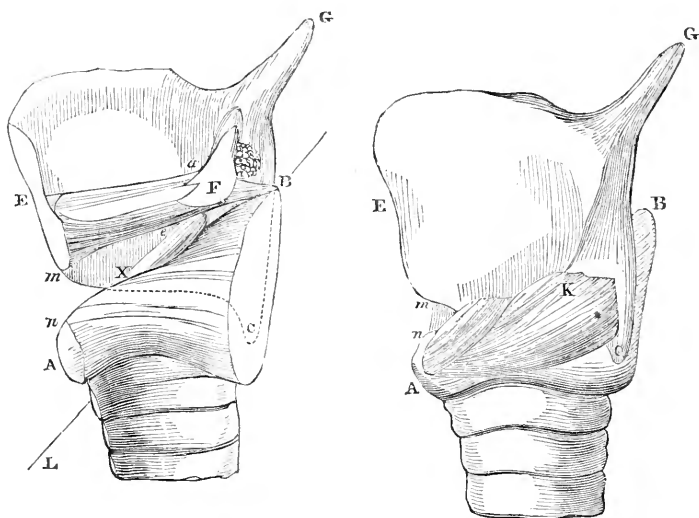

External and sectional views of the Larynx. A n B, the cricoid cartilage; E C G, the thyroid cartilage; G, its upper horn; c, its lower horn, where it is articulated with the cricoid; F, the arytenoid cartilage; E, F, the vocal ligament; A K, crico-thyroideus muscle; F e m, thyro-arytenoideus muscle; x e, crico-arytenoideus lateralis; s, transverse section of arytenoideus transversus; m n, space between thyroid and cricoid; B L, projection of axis of articulation of arytenoid with thyroid.

ner the lower front border of the thyroid cartilage, which is ordinarily separated by small intervals from the upper margin of the cricoid, may be made to approach it or recede from it; as any one may easily ascertain, by placing his finger against the little depression which may be readily felt externally, and observing its changes of size, whilst a range of different tones is sounded; it will then be observed that, the higher the note, the more the two cartilages are made to approximate,—whilst they separate in proportion to the depth of the tones.* Upon the upper surface of the back of the cricoid, are seated the two small *Arytenoid* cartilages; these are fixed in one direction by a bundle of strong ligaments, which tie them to the back of the cricoid; but they have some power of moving in other directions upon a kind of articulating surface. The direction of the surface, and the mode in which these cartilages are otherwise attached, cause their movement to be a sort of rotation in a plane, which is nearly horizontal, but partly downwards; so that their vertical planes may be made to separate from each other, and at the same time to assume a slanting position. This change of place will be better understood, when the action of the muscles is described. To the summit of the arytenoid cartilages are attached the *chordæ vocales* or Vocal Ligaments, which stretch across to the front of the thyroid cartilage; and it is upon the condition and relative situation of these ligaments, that their action depends. It

* In making this observation, it is necessary to put out of view the general movement to the larynx itself, which the finger must be made to follow up and down.

is evident that they may be rendered more or less tense by the movement of the Thyroid cartilage just described; being tightened by the depression of its front upon the Cricoid cartilage, and slackened by its elevation. On the other hand, they may be brought into more or less close apposition, by the movement of the Arytenoid cartilages; being made to approximate closely, or to recede in such manner as to cause the rima glottidis to assume the form of a narrow V, by the revolution of these cartilages. We shall now inquire into the actions of the muscles upon the several parts of this apparatus; and first into those of the larynx alone.

604. The depression of the front of the Thyroid cartilage, and the consequent tension of the Vocal Ligaments, are occasioned by the conjoint action of the *Crico-thyroidei* on both sides; and the chief antagonists to these are the *Thyro-arytenoidei*, which draw the front of the Thyroid back towards the Arytenoid cartilages, and thus relax the vocal ligaments. These two pairs of muscles may be regarded as the principal governors of the pitch of the notes, which, as we shall hereafter see, is almost entirely regulated by the tension of the ligaments; their action is assisted, however, by that of other muscles

presently to be mentioned.—The Arytenoid cartilages are made to diverge from each other, by means of the *Crico-arytenoideus posticus* of each side, which proceeds from their outer corner, and turns somewhat round the edge of the Cricoid, to be attached to the lower part of its back; its action is to draw the outer corner backwards and downwards, so that the points to which the vocal ligaments are attached, are separated from one another, and the Rima Glottidis is thrown open. This will be at once seen from the succeeding diagram, in which the direction of traction of the several muscles is laid down.—The action of this muscle is partly antagonized by that of the *Crico-arytenoideus lateralis*, which runs forwards and downwards from the outer corner of the Arytenoid cartilage; and its action, with that of its fellow, will be to bring the anterior points of the Arytenoid cartilages into the same straight line, at the same time depressing them, and thus to close the Glottis. This muscle is assisted by the *Arytenoideus transversus*, which connects the posterior faces of the Arytenoid cartilages, and which, by its contraction, will draw them together. By the conjoint action, therefore, of the *Crico-arytenoideus lateralis*, and of the *Arytenoideus transversus*, the whole of the adjacent faces of the Arytenoid cartilages will be pressed together; and the points to which the vocal ligaments are attached, will be depressed.—But if the *Arytenoideus* be put in action in conjunction with the *Crico-arytenoidei postici*, the tendency of the latter to separate the Arytenoid cartilages being antagonized by the former, its backward action only will be exerted; and thus it may be caused to aid the *Crico-thyroideus* in rendering tense the vocal

Fig. 196.

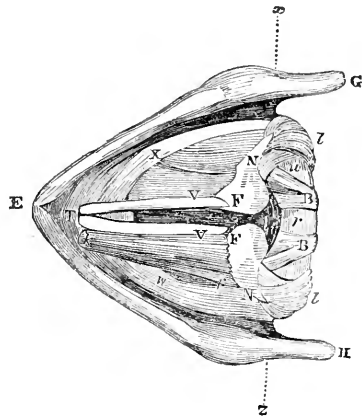

Bird's-eye view of larynx from above. G E H, the thyroid cartilage, embracing the ring of the cricoid *r u v*, and turning upon the axis *x z*, which passes through the lower horns, *c*, Fig. 113, N F, N F, the arytenoid cartilages, connected by the arytenoideus transversus; T V, T V, the vocal ligaments; N X, the right crico-arytenoideus lateralis (the left being removed); V K F, the left thyro-arytenoideus (the right being removed); N L, N L, the crico-arytenoidei postici; B, B, the crico-arytenoid ligaments.

ligaments. This action will be further assisted by the *Sterno-thyroideus*, which tends to depress the Thyroid cartilage, by pulling from a fixed point below ;* and the *Thyro-hyoideus* will be the antagonist of this, when it acts

Fig. 197.

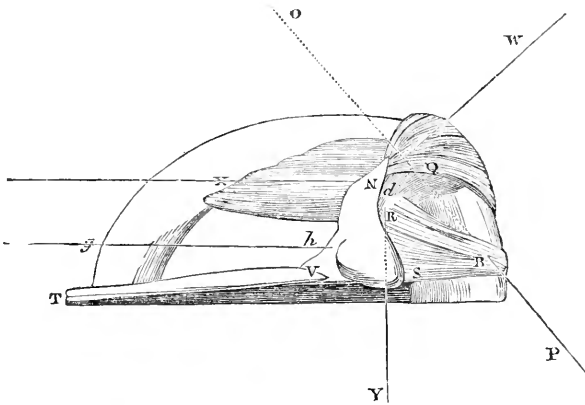

Part of Fig. 196 enlarged, to show the direction of the muscular forces, which act on the Arytenoid cartilage. Q N V S, the right Arytenoid cartilage ; T V, its vocal ligament ; B R S, bundle of ligaments uniting it to Cricoid ; O P, projection of its axis of articulation ; h g, direction of the action of the Thyro-arytenoideus ; N X, direction of Crico-arytenoideus lateralis ; N W, direction of Crico-arytenoideus posticus ; N Y, direction of Crytenoideus transversus.

from a fixed point above, the Os Hyoides being secured by the opposing contraction of several other muscles.—The respective actions of these muscles will be best comprehended by the following Table.

Govern the pitch of the notes.

Antagonists.	}	{	CRICO-THYROIDEI	}	{	Depress the front of the Thyroid cartilage on the
			STERNO-THYROIDEI			Cricoid, and stretch the vocal ligaments; assisted by the Arytenoideus and Crico-arytenoidei postici.
Antagonists.	}	{	THYRO-ARYTENOIDEI	}	{	Elevate the front of the Thyroid cartilage, and draw it towards the Arytenoids, relaxing the vocal ligaments.
			THYRO-HYOIDEI			

Govern the Aperture of the Glottis.

Antagonists.	}	{	CRICO-ARYTENOIDEI POSTICI	}	{	Open the Glottis.
			CRICO-ARYTENOIDEI LATERALES			Press together the inner edges of the Arytenoid cartilages, and close the Glottis.

605. The muscles which stretch or relax the Vocal ligaments, are entirely concerned in the production of Voice ; those which govern the aperture of the Glottis have important functions in connection with the Respiratory actions in general, and stand as guards (so to speak) at the entrance to the lungs. Their separate actions are easily made evident. We can close the aperture of the Glottis, by an exertion of the will, either during inspiration or expiration ; and it is a kind of spasmodic movement of this sort, which is

* This is not usually reckoned as one of the principal muscles concerned in regulating the voice ; but that it is so, any one may convince himself by placing his finger just above the sternum, whilst he is sounding high notes ; a strong feeling of muscular tension is then at once perceived.

concerned in the acts of Coughing and Sneezing (§ 381), as well as in the more prolonged impediments to the ingress and egress of air, which have been already noticed as resulting from disordered states of the Nervous system (§ 504). A slight examination of the recent Larynx is sufficient to make it evident that, when once the borders of the Rima Glottidis are brought together by muscular action, the effect of strong aerial pressure on either side,—whether produced by an expulsive blast from below, or by a strong inspiratory effort, occasioning a partial vacuum below, and consequently an increased pressure above,—will be to force them into closer apposition. With this action, then, the muscles which regulate the tension of the vocal ligaments have nothing to do. In the ordinary condition of rest, it seems probable that the Arytenoid cartilages are considerably separated from each other; so as to cause a wide opening to intervene between their inner faces, and between the vocal ligaments, through which the air freely passes; and the vocal ligaments are at the same time in a state of complete relaxation. In order to produce a vocal sound, it is not sufficient to put the ligaments into a state of tension; they must also be brought nearer to each other. That the aperture of the Glottis is greatly narrowed during the production of sounds, is easily made evident to one's self, by comparing the time occupied by an ordinary expiration, with that required for the passage of the same quantity of air during the sustenance of a vocal tone. Further, the size of the aperture is made to vary in accordance with the note which is being produced; of this, too, any one may convince himself, by noting the time during which he can hold out a low and a high note; from which it will appear, that the aperture of the Glottis is so much narrowed in producing a high note, as to permit a much less rapid passage of air, than is allowed when a low one is sounded. This adjustment of the aperture to the tension of the Vocal Ligaments, is a necessary condition for the production of a clear and definite tone. It further appears that, in the narrowing of the Glottis, which is requisite to bring the vocal ligaments into the necessary approximation, the upper points of the Arytenoid cartilages are caused to approximate, not only by being made to rotate horizontally towards each other, but also by a degree of elevation; so that the inner faces of the Vocal Ligaments are brought into parallelism with each other,—a condition which may be experimentally shown to be necessary, for their being thrown into sonorous vibration.

606. We have now to inquire what is the operation of the Vocal Ligaments in the production of sounds; and in order to comprehend this, it is necessary to advert to the conditions under which tones are produced, by instruments of various descriptions, having some analogy with the Larynx.

a. These are chiefly of three kinds,—strings, flute-pipes, and reeds or tongues. The Vocal Ligaments were long ago compared by Ferrein to vibrating Strings; and at first sight there might seem a considerable analogy, the sounds produced by both being elevated by increased tension. This resemblance disappears, however, on more accurate comparison; for it may be easily ascertained by experiment, that no string so short as the vocal ligaments could give a clear tone, at all to be compared in depth with that of the lowest notes of the human voice; and also, that the scale of changes produced by increased tension is fundamentally different. When strings of the same length, but of different tension, are made the subject of comparison, it is found that the number of vibrations is in proportion to the square roots of the extending forces. Thus, if a string extended by a given weight produce a certain note, a string extended by four times that weight will give a note, in which the vibrations are twice as rapid,—and this will be the octave of the other. If nine times the original weight be employed, the vibrations will be three times as rapid as those of the fundamental note, producing the twelfth above it. Now by fixing the larynx in such a manner, that the vocal ligaments can be extended by a known weight, Müller has ascertained that the sounds produced by a variation of the extending force will not follow the same ratio; and therefore the condition of these ligaments cannot be simply that of vibrating cords. Further, a cord of a certain length, which is adapted to give out a clear and distinct note, equal in depth to the lowest of the

human voice, may be made by increased tension to produce all the superior notes, which, in stringed instruments, are ordinarily obtained by shortening the strings.* But it does not follow that a short string, which, with moderate tension, naturally produces a high note, should be able, by a diminution of the tension, to give out a deep one; for, although this might be theoretically possible, yet it cannot be accomplished in practice; since the vibrations become irregular on account of the diminished elasticity.† These considerations are in themselves sufficient to destroy the supposed analogy; and to prove that the *Chordæ Vocales* cannot be reduced to the same category with vibrating strings.

b. The next kind of instrument, with which some analogy might be suspected, is the Flute-pipe, in which the sound is produced by the vibration of an elastic column of air contained in the tube; and the pitch of the note is determined almost entirely by the length of the column, although slightly modified by its diameter, and by the nature of the embouchure or mouth from which it issues. This is exemplified in the German Flute, and in the English Flute or Flageolet; in both of which instruments, the acting length of the pipe is determined, by the interval between the embouchure and the nearest of the side apertures; by opening or closing which, therefore, a modification of the tone is produced. In the Organ, of which the greater number of pipes are constructed upon this plan, there is a distinct pipe for every note; and their length increases in a regular scale. It is, in fact, with flute-pipes as with strings,—that a diminution in length causes an increase in the number of vibrations, in an inverse proportion; so that of two pipes, one being half the length of the other, the shorter will give a tone which is the octave above the other, the vibrations of its column of air being twice as rapid. Now there is nothing in the form or dimensions of the column of air between the larynx and the mouth, which can be conceived to render it at all capable of such vibrations, as are required to produce the tones of the Human voice; though there is some doubt, whether it is not the agent in the musical tones of certain Birds. The length of an open pipe necessary to give the lowest G of the ordinary bass voice, is nearly six feet; and the conditions necessary to produce the higher notes from it, are by no means those which we find to exist in the process of modulating the human voice.

c. We now come to the third class of instruments, in which sound is produced by the vibration of Reeds or Tongues; these may either possess elasticity in themselves, or be made elastic by tension. The reeds of the Mouth-Eolina, Accordion, Seraphine, &c., are examples of instruments of this character, in which the lamina vibrates freely in a sort of frame, that allows the air to pass out on all sides of it through a narrow channel, thus increasing the strength of the blast: whilst in the Hautboy, Bassoon, &c., and in Organ-pipes of similar construction, the reed is attached to one end of a pipe. In the former kind, the sound is produced by the vibration of the tongue alone, and is regulated entirely by its length and elasticity; whilst in the latter, its pitch is dependent upon this conjointly with the length of the tube, the column of air contained in which is thrown into simultaneous vibration. Some interesting researches on the effect produced on the pitch of a sound given by a reed, through the union of it with a tube, have been made by M. W. Weber; and, as they are important in furnishing data, by which the real nature of the vocal organ may be determined, their chief results will be here given.—i. The pitch of a reed may be lowered, but cannot be raised, by joining it to a tube. ii. The sinking of the pitch of the reed thus produced, is at the utmost not more than an octave. iii. The fundamental note of the reed thus lowered, may be raised again to its original pitch, by a further lengthening of the tube; and by a further increase is again lowered. iv. The length of tube, necessary to lower the pitch of the instrument to any given point, depends on the relation which exists between the frequency of the vibrations of the tongue of the reed, and those of the column of air in the tube, each taken separately.—From these data, and from those of the preceding paragraph, it follows that, if a wind-instrument can, by the prolongation of its tube, be made to yield tones of any depth in proportion to the length of the tube, it must be regarded as a flute-pipe; whilst, if its pitch can only be lowered an octave or less (the embouchure remaining the same) by lengthening the tube, we may be certain that it is a reed instrument. The latter proves to be the case in regard to the Larynx.

607. It is evident from the foregoing considerations, that the action of the Larynx has more analogy to that of reed instruments, than it has to that either

* Thus in the Piano-forte, where there are strings for each note, a gradual shortening is seen from the lowest to the highest; and in the Violin the change of tone is produced by *stopping* the strings with the finger, so as to diminish their acting length.

† Thus it would be impossible to produce good Bass notes on the strings of a Violin, by diminishing their tension; the length afforded by the Violoncello or Double Bass is requisite. The striking difference between the tone of the Bass strings in the Grand Piano-forte and the small upright Piccolo, is another exemplification of the same principle; being chiefly due to the length and tension of the former, as contrasted with the shortness and slackness of the latter.

of vibrating *strings*, or of *flute pipes*. There would seem, at first sight, to be a marked difference in character, between the Chordæ Vocales, and the tongue of any reed instrument; but this difference is really by no means considerable. In a reed, elasticity is a property of the tongue itself, when fixed at one end, the other vibrating freely; but by a membranous lamina, fixed in the same manner, no tone would be produced. If such a lamina, however, be made elastic by a moderate degree of tension, and be fixed in such a manner as to be advantageously acted on by a current of air, it will give a distinct tone. It is observed by Müller, that membranous tongues made elastic by tension, may have either of three different forms. I. That of a band extended by a cord, and included between two firm plates, so that there is a cleft for the passage of air on each side of the tongue. II. The elastic membrane may be stretched over the half or any portion of the end of a short tube, the other part being occupied by a solid plate, between which and the elastic membrane a narrow fissure is left. III. Two elastic membranes may be extended across the mouth of a short tube, each covering a portion of the opening, and having a chink left open between them.—This last is evidently the form most allied to the Human Glottis; but it may be made to approximate still more closely, by prolonging the membranes in a direction parallel to that of the current of air, so that not merely their edges, but their whole planes, shall be thrown into vibration. Upon this principle, a kind of artificial Glottis has been constructed by Mr. Willis; the conditions of action, and the effects of which, are so nearly allied to that of the real instrument, that the similar character of the two can scarcely be doubted. The following is his description of it. "Let a wooden pipe be prepared of the form of Fig. 198 *a*, having a foot, *c*, like that of an organ-pipe, and an upper opening, long and narrow, as at *B*, with a point *A*, rising at one end of it. If a piece of leather, or still better, of sheet India-rubber, be doubled round this point, and secured by being bound round the pipe at *D* with strong thread, as in Fig. 198, *b*, it will give us an artificial glottis, with its upper edges *G H*, which may be made to vibrate or not, at pleasure, by inclining the planes of the edges. A couple of pieces of cork, *E*, *F*, may be glued to the corners, to make them more manageable. From this machine, various notes may be obtained, by stretching the edges in the direction of their length, *G H*; the notes rising in pitch with the increased tension, although the length of the vibrating edge is increased. It is true, that a scale of notes equal in extent to that of the human voice, cannot be obtained from edges of leather; but this scale is much greater in India-rubber than in leather; and the elasticity of them both is so much inferior to that of the vocal ligaments, that we may readily infer that the great scale of the latter is due to its greater elastic powers." By other experimenters, the tissue forming the middle coat of the arteries has been used for this purpose, in the moist state, with great success; with this, the tissue of the vocal ligaments is nearly identical. It is worthy

Fig. 198.

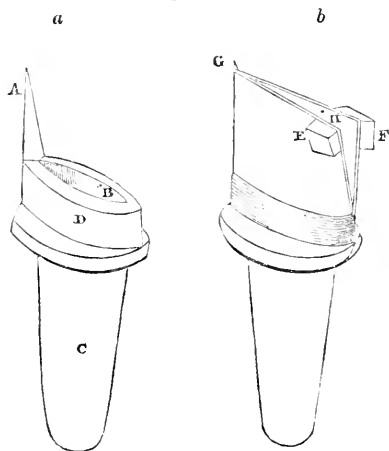

Artificial Glottis.

of remark that, in all such experiments, it is found that the two membranes may be thrown into vibration, when inclined *towards* each other in various degrees, or even when they are in the same plane, and their edges only approximate; but that the least inclination *from* each other (which is the position the vocal ligaments have during the ordinary state of the glottis, § 605,) completely prevents any sonorous vibrations from being produced.

608. The pitch of the note produced by membranous tongues, may be affected in several ways. Thus, an increase in the strength of the blast, which has little influence on metallic reeds, raises *their* pitch very considerably; and in this manner the note of a membranous reed may be raised by semitones, to as much as a fifth above the fundamental. The addition of a pipe has nearly the same effect on their pitch, as on that of metallic reeds; but it cannot easily be determined with the same precision. The effect of the junction of a pipe with a double membranous tongue, is well shown in the Trumpet, Horn, and other instruments; which require the vibration of the lips, as well as a blast of air, for the production of their sound, having no reed of their own. By some, these instruments have been classed with Flute-pipes; but the conditions of their action are entirely different. The mouth-piece of the horn or trumpet is incapable of yielding any tone, when a current of air is merely blown through it; and the lips are necessary to convert it into a musical reed, being rendered tense by the contraction of their sphincter, partly antagonized by the slightly-dilating action of other muscles. The variation of the tension of the lips is effected by muscular effort; and several different notes may be produced with a pipe of the same length; but there is a certain length of the column of air, which is the one best adapted for each tone; and different instruments possess various contrivances for changing this. It has been recently ascertained, that the length of the pipe prefixed to the reed, has also a considerable influence on its tone, rendering it deeper in proportion as it is prolonged, down to nearly the octave of the fundamental note; but the pitch then suddenly rises again, as in the case of the tube placed beyond the reed. The researches of Müller, however, have not succeeded in establishing any very definite relation between the length of the two tubes, in regard to their influence on the pitch of the reed placed between them.

609. From the foregoing statements it appears, that the true theory of the Voice may now be considered as well established, in regard to this essential particular,—that the sound is the result of the vibrations of the vocal ligaments, which take place according to the same laws with those of metallic or other elastic tongues: and that the pitch of the notes is chiefly governed by the tension of these laminæ. With respect, however, to the modifications of these tones, induced by the shape of the air-passages, both above and below the larynx, by the force of the blast, and by other concurrent circumstances, little is certainly known. Hence it is, that on the theory of the production of what are called *falsetto* notes, there is much difference of opinion amongst Physiologists. Some have contended, that these tones are produced by the vibration of the vocal ligaments along only a part of their length; but this is certainly untrue. By Müller it is believed, that in the falsetto notes merely the thin border of the glottis vibrates, so that the fissure remains distinctly visible; whilst in the production of the ordinary vocal tones, the whole breadth of the vocal ligaments is thrown into strong vibrations, which traverse a wider sphere, so that a confused motion is seen in the lips of the glottis, rendering its fissure obscure. That the tension of the vocal cords is not diminished (as it ought to be if only a part of their length were being used), but is progressively increased, as we pass from the ordinary to the falsetto scale, any one may convince himself, by placing his finger on the interval between the thyroid and

cricoid cartilages, as formerly described (§ 603).*—A very important adjunct to the production of the higher notes, has been pointed out by Müller, as being afforded by the modification in the space included between the two sides of the thyroid cartilage, which is effected by the thyro-arytenoidei. He had experimentally ascertained, that the introduction of a hollow plug into the upper end of the pipe beneath his artificial larynx (and therefore just below the reed), by diminishing its aperture, produced a considerable elevation of the tone. The action may be imitated in the human larynx, when made the subject of experiment, by compressing the thyroid cartilage laterally; and in this manner, the natural voice could be made to extend through a range, that could otherwise be only reached by a falsetto.

610. The strength of the tone produced in the larynx, is much increased by the resonance of the elastic tissue, which it contains in various other parts; but still more, perhaps, by that produced by the air in the trachea, bronchi, and pulmonary cells. This comes to be of great importance in the phenomena of auscultation. The aerial resonance is loudest where any large body of air is collected together, as in the trachea, the larger bronchi, an emphysematous dilatation, or a cavity resulting from tubercular softening. On the other hand, solidification of the pulmonary tissue will produce a resonance of a somewhat different kind. The influence of the prefixed and superadded tubes, in modifying the tones produced by the Human larynx, has been found by Prof. Müller not to be at all comparable to that which they exercised over the artificial larynx; the reason of which difference does not seem very apparent. It appears, however, that there is a certain length of the prefixed tube,—as there is a certain distance of the vibrating laminae, and a certain length or form of the tube above,—which is most favourable to the production of each note; and the downward movement of the whole vocal organ, which takes place when we are sounding deep notes, and its rise during the elevation of the tones, have been supposed to have the purpose of making this adjustment in the length of the trachea; but this requires the supposition, that the real length of the trachea is shortened whilst it appears extended,—for which there seems no foundation. It is considered by Mr. Wheatstone, that the column of air in the trachea may divide itself into harmonic lengths, and may produce a *reciprocation* of the tone given by the vocal ligaments (§ 560); and in this manner he considers that the falsetto notes are to be explained. It may be added, that the partial closing of the epiglottis seems to assist in the production of deep notes, just as the partial covering of the top of a short pipe fixed to a reed will lower its tone; and that something of this kind takes place during natural vocalization, would appear, from the retraction and depression of the tongue which accompany the lowering of the front of the head, when the very lowest notes are being sounded. The arches of the palate and uvula become contracted during the formation of the higher tones; but no difference can be perceived in their state, whether these tones be falsetto or not; hence it would appear that they have no concern in this peculiarity; and the purpose of their increased tension is probably to maintain their power of resonance. The experiments of Savart have shown, that a cavity which only responds to a shrill note, when its walls are firm and dry, may be made to afford a great variety of lower tones, when its walls are

* That the falsetto voice differs in some essential particular from the natural, is evident from this,—that many persons who possess a considerable range of both, are yet unable to unite them, so as to sing through the whole scale without a marked interruption. Thus a gentleman of the Author's acquaintance has a bass voice, ranging from the lowest D of the Square Piano to the second D above; and a falsetto ranging from the A below this to the E of the octave above, so as to give a compass of more than three octaves on the whole; yet the two registers cannot be smoothly blended.

moistened and relaxed in various degrees. This observation may probably be applied also to the trachea.

611. These and numerous other muscular actions, which are employed in the production and regulation of the voice, are effected by an impulse which can scarcely be termed Voluntary, and the nature of which is a curious subject for inquiry. It may be safely affirmed, that the production of sounds is in itself an Instinctive action; although the combination of these, whether into music or articulate language, is a matter of acquirement. Now it might be supposed that the Will has sufficient power over the vocal muscles, to put them into any state requisite for its purposes, without any further condition: but a little self-experiment will prove that this is not the case. No definite tone can be produced by a Voluntary effort, unless that tone be present to the mind, during however momentary an interval, either as immediately conveyed to it by an act of Sensation, recalled by an act of Conception, or anticipated by an effort of the imagination. When thus present, the Will can enable the muscles to assume the condition requisite to produce it; but under no other circumstances does this happen, except by a particular mode of discipline presently to be adverted to. The action itself, therefore, must be reduced to the class of consensual movements; and we must suppose that the will is exercised in preparing the conditions requisite for it, rather than in directly exciting it.—That those who are unfortunately labouring under congenital deafness, are thence debarred from learning the use of Voice in the ordinary manner, is well known; the consensual action cannot be excited, either through sensations of the present, or conceptions of the past; and the imagination is entirely destitute of power to suggest that which has been in no shape experienced. But such persons may be taught to speak in an imperfect manner, by causing them to imitate particular muscular movements, which they may be made to see; and it is evident, that they must be guided in the imitation and ordinary performance of those movements, by the common muscular sensations which accompany them, and not by the sensations conveyed through the Auditory nerve, which are ordinarily by far the most precise guides. Many instances, indeed, are on record, in which persons entirely deaf were enabled to carry on a conversation in the regular way; judging of what was said, by the movements of the lips and tongue, which they had learned to connect with particular syllables; and regulating their own voices in reply, by their voluntary power, guided by muscular sensation.*

[In the foregoing account of the Physiology of Voice, the author has been chiefly guided by the excellent paper by Mr. Willis in the Transactions of the Cambridge Philosophical Society, vol. iv.; and by the elaborate investigations of Müller and his coadjutors, as detailed in the Fourth Book of his Physiology.]

2.—Of Articulate Sounds.

612. The larynx, as now described, is capable of producing those *tones* of which Voice fundamentally consists, and the sequence of which becomes Music: but *Speech* consists in the modification of the laryngeal tones, by other organs, intervening between the Glottis and the Os Externum; so as to produce those *articulate sounds*, of which Language is formed. It cannot be questioned that Music has its language; and that it is susceptible of expressing the emotional states of the mind, among those at least who have been accustomed to associate these with its varied modes, to even a higher degree than articulate speech. But it is incapable of addressing the intellect, by conveying definite ideas of objects, properties, actions, &c., in any other

* See Johnstone on Sensation, p. 128.

way than by a kind of imitation, which may be compared to the signs used in hieroglyphic writing. These ideas it is the peculiar province of articulate language to convey; and we find that the vocal organ is adapted to form a large number of simple sounds, which may be readily combined into groups, forming words. The number of combinations which can be thus produced, is so inexhaustible, that every language has its own peculiar series; no difficulty being found in forming new ones to express new ideas. There is considerable diversity in different languages, even with regard to the use of the simplest of these combinations; some of them are more easy of formation than others, and these accordingly enter into the composition of all languages; whilst the more difficult ones, some are employed in one language, some in another,—no one language possessing them all. Without entering into any detailed account of the mechanism required to produce each of these simple sounds, a few general considerations will be offered in regard to the classification of them; and the peculiar defect of Articulation, termed Stammering, will be briefly treated of.

613. Vocal sounds are divided into Vowels and Consonants; and the distinctive characters of these are usually considered to be, that the Vowels are produced by the Voice alone, whilst the sound of the Consonants is formed by some kind of interruption to the voice, so that they cannot be properly expressed, unless conjoined with a vowel. The distinction may be more correctly laid down, however, in this manner:—the Vowel sounds are continuous tones, modified by the form of the aperture through which they pass out; whilst in sounding Consonants, the breath suffers a more or less complete interruption, in its passage through parts anterior to the larynx. Hence the really simple Vowel sounds are capable of prolongation during any time that the breath can sustain them; this is not the case, however, with the *real* Diphthongal sounds (of which it will presently appear that the English *i* is one); whilst it is true of some Consonants. It seems to have been forgotten by many of those who have written upon this subject, that the laryngeal voice is not essential to the formation of either vowels or consonants; for all may be sounded in a whisper. It is very evident, therefore, that the larynx is not primarily concerned in their production; and this has been fully established by the following experiment. A flexible tube was introduced by M. Deleau through his nostril into the pharynx, and air was impelled by it into the fauces; then, closing the larynx, he threw the fauces into the different positions requisite for producing articulate sounds, when the air impelled through the tube became an audible whisper. The experiment was repeated, with this variation,—that laryngeal sounds were allowed to pass into the fauces; and each articulated letter was then heard double, in a proper voice and in a whisper.

614. That the Vowels are produced by simple modifications in the form of the external passages, is easily proved, both by observation and by imitative experiment. When the mouth is opened wide, the tongue depressed, and the velum palati elevated, so as to give the freest possible exit to the voice, the vowel *a* in its broadest form (as in *ah*) is sounded.* On the other hand, if the oral aperture be contracted, the tongue being still depressed, the sound *oo* (the continental *u*) is produced. If attention be paid to the state of the buccal cavity, during the pronunciation of the different vowel sounds, it will be found to undergo a great variety of modifications, arising from varieties of position of the tongue, the cheeks, the lips, and velum palati. The posi-

* This sound of the vowel *a* is scarcely used in our language, though very common in most of the continental tongues; the nearest approach to it in English is the *a* in *far*: but this is a very perceptible modification, tending towards *au*.

tion of the tongue is, indeed, one of the primary conditions of the variation of the sound; for it may be easily ascertained that, by peculiar inflexions of this organ, a great diversity of vowel sounds may be produced, the other parts remaining the same. Still there is a certain position of all the parts, which is most favourable to the formation of each of these sounds; but this could not be expressed without a lengthened description. The following table, slightly altered from that of Kempelen, expresses the relative dimensions of the buccal cavity and of the oral orifice, for some of the principal of these; the number 5 expressing the largest size, and the others in like proportion:—

Vowel.	Sound.	Size of oral opening.	Size of buccal cavity.
a	as in <i>ah</i>	5	5
ā	as in <i>name</i>	4	2
e	as in <i>theme</i>	3	1
o	as in <i>cold</i>	2	4
oo	as in <i>cool</i>	1	5

These are the sounds of the five vowels, *a*, *e*, *i*, *o*, *u*, in most Continental languages; and it cannot but be admitted, that the arrangement is a much more natural one than that of our own vowel series. The English *a* has three distinct sounds capable of prolongation:—the true broad *a* of *ah*, slightly modified in *far*; the *a* of *fate*, corresponding to the *e* of French; and the *a* of *fall*, which should be really represented by *au*. This last is a simple sound, though commonly reckoned as a diphthong. In Kempelen's scale, the oral orifice required to produce it would be about 3, and the size of the buccal cavity 4.† On the other hand, the sound of the English *i* cannot, like that of a true vowel, be prolonged *ad libitum*; it is in fact a sort of Diphthong, resulting from the transition from a peculiar indefinite murmur to the sound of *e*, which takes its place when we attempt to continue it. The sound *oy* or *oi*, as in *oil*, is a good example of the true diphthong; being produced by the transition from *au* to *e*. In the same manner, the diphthong *ou*, which is the same with *ow* in *owl*, is produced in the rapid transition from the broad *a* of *ah*, to the *oo* of *cool*.—Much discussion has taken place as to the true character of *y*, when it commences a word, as in *yet*, *yawl*, &c.; some having maintained that it is a consonant, (for the very unsatisfactory reason, that we are in the habit of employing *a* rather than *an*, when we desire to prefix the indefinite article to such words,) whilst others regard it as a peculiar vowel. A slight attention to the position of the vocal organs during its pronunciation, makes it very clear, that its sound in such words really corresponds with that of the long (English) *e*; the pronunciation of the word *yawl* being the same as that of *ēaul*, when the first sound is not prolonged, but rapidly transformed into the second.—The sound of the letter *w*, moreover, is really of the vowel character, being formed in the rapid transition from *oo* to the succeeding vowel; thus *wall* might be spelt *ōōall*. Many similar difficulties might be removed, and the conformity between spoken and written language might be greatly increased (so as to render far more easy the acquirement of the former from the latter), by due attention to the state of the vocal organs in the production of the simple sounds.

* The short vowel sounds, as *a* in *fat*, *e* in *met*, *o* in *pot*, &c., are not capable of prolongation.

† The mode of making a determination of this kind may here be given, for the sake of example. If the broad *a* be sounded, the mouth and fauces being opened wide, and we contract the oral orifice by degrees, at the same time slightly elevating the point of the tongue, we gradually come to the sound of *au*; by still further contracting the orifice, and again depressing the tongue, we form *oo*. On the other hand, in sounding *e*, the tongue is raised nearly to the roof of the mouth; if it be depressed, without the position of the lips being altered, *au* is given.

615. It is not very difficult to produce a tolerably good artificial imitation of the Vowel sounds. This was accomplished by Kempelen, by means of an India-rubber ball, with an orifice at each end, of which the lower one was attached to a reed; by modifying the form of the ball, the different vowels could be sounded during the action of the reed. He also employed a short funnel-like tube, and obtained the different sounds by covering its wide opening to a greater or less extent. This last experiment has been repeated by Mr. Willis; who has also found that the vowel sounds might be imitated, by drawing out a long straight tube from the reed. In this experiment he arrived at a curious result:—with a tube of a certain length, the series of vowels, *i, e, a, o, u*, was obtained, by gradually drawing it out; but, if the length was increased to a certain point, a further gradual increase would produce the same sequence in an inverted order, *u, o, a, e, i*; a still further increase would produce a return to the first scale, and so on. When the pitch of the reed was high, and the pipe short, it was found that the vowels *o* and *u* could not be distinctly formed,—the proper tone being injured by the elongation of the pipe necessary to produce them; and this, Mr. Willis remarks, is exactly the case in the Human voice, most singers being unable to pronounce *u* and *o* upon their highest notes.

616. The most natural primary division of the Consonants is into those which require a total stoppage of the breath at the moment previous to their being pronounced, and which, therefore, cannot be prolonged; and those in pronouncing which the interruption is partial, and which can, like the vowel sounds, be prolonged *ad libitum*. The former have received the designation of *explosive*; and the latter of *continuous*.—In pronouncing the *explosive* consonants, the posterior nares are completely closed, so that the exit of air through the nose is altogether prevented; and the current may be checked in the mouth in three ways,—by the approximation of the lips,—by the approximation of the point of the tongue to the front of the palate,—and by the approximation of the middle of the tongue to the arch of the palate. In the first of these modes, we pronounce the letters *b*, and *p*; in the second, *d* and *t*; in the third, the hard *g*, and *k*. The difference between *b*, *d*, and *g*, on the one hand, and *p*, *t*, and *k*,* on the other, seems to depend on this;—that in the former group the approximating surfaces are larger, and the breath is sent through them more strongly at the moment of opening, than in the latter.—The *continuous* consonants may be again subdivided, according to the degree of freedom with which the air is allowed to make its exit, and the compression which it consequently experiences. 1. The first class includes those, in which no passage of air takes place through the nose, and in which the parts of the mouth that produce the sound are nearly approximated together, so that the compression is considerable. This is the case with *v* and *f*, which are produced by approximating the upper incisors to the lower lip; and which stand in nearly the same relation to each other, as that which exists between *d* and *t*, or *b* and *p*. The sibilant sounds *z* and *s*, stand in nearly the same relation to each other; they are produced by the passage of air between the point of the tongue and the front of the palate, the teeth being at the same time nearly closed. The simple sound *sh* is formed, by narrowing the channel between the dorsum of the tongue and the palate; the former being elevated towards the latter, through a considerable part of its length. If, in sounding *s*, we raise the point of the tongue a very little, so as to touch the palate, the sound of *t* is evolved; and in the same manner *d* is produced from *z*. This class also includes the *th*; which, being a perfectly simple sound, ought to be expressed by a single letter, as in Greek; instead of by two, of which the

* For the sake of proper comparison, this letter should be sounded not as *kay* but as *key*.

combination does not really produce anything like it. For producing this sound, the point of the tongue is applied to the back of the incisors, or to the front of the palate, as in sounding *t*;^{*} but, whilst there is complete contact of the tip, the air is allowed to pass out around it. II. In the second class of continuous consonants, including the letters *m*, *n*, *l*, and *r*, the nostrils are not closed; and the air thus undergoes very little compression, even though the passage of air through the oral cavity is almost or completely checked. In pronouncing *m* and *n*, the breath passes through the nose alone; and the difference of the sound of these two letters, must be due to the variation in the form of the cavity of the mouth, which acts by resonance. The letter *m* is a labial, like *b*; and the only difference between the two is, that in the former the nasal passage is open, whilst the mouth remains closed; whilst in the latter, the nose is entirely closed, and the sound is formed at the moment of opening the mouth. The same correspondence exists between *n* and *l*, or *n* and *g* (the particular part of the tongue approximated to the palate not being of much consequence in the pronunciation of *n*); and hence it is that the transition from *n* to *l*, or from *n* to *g*, is so easy, that the combinations *nl* and *ng* are found abundantly in most languages. The sound of *l* is produced, by bringing the tip of the tongue into contact with the palate, and allowing the air to escape around it, at the same time that a vocal tone is generated in the larynx; it differs, therefore, from *th* in the position at which the obstruction is interposed, as well as in the slight degree of the compression of the air which it involves. The sound of the letter *r* depends on an absolute vibration of the point of the tongue, in a narrow current of air forced between the tongue itself and the palate. III. The sounds of the third class are scarcely to be termed consonants, since they are merely *aspirations*, caused by an increased force of breath. These are *h*, and the *cht* of most foreign languages (the Greek χ). The first is a simple aspiration; the second, an aspiration modified by the elevation of the tongue, causing a slight obstruction to the passage of air, and an increased resonance in the back of the mouth. This sound would become either *g* or *k*, if the tongue, whilst it is being produced, were carried up to touch the palate.‡

617. These distinctions come to be of much importance, when we apply ourselves to the treatment of defects of articulation. Great as is the number of muscles employed in the production of definite vocal sounds, the number is much greater for those of articulate language; and the varieties of combination, which we are continually forming unconsciously to ourselves, would not be suspected, without a minute analysis of the separate actions. Thus, in uttering the explosive sounds, we check the passage of air through the posterior nares, in the very act of articulating the letter; and yet, this important movement commonly passes unobserved. We must regard the power of forming the several articulate sounds which have been adverted to, and their simple combinations, as so far resulting from intuition, that it can in general be more readily acquired by early practice, than other actions of the same complexity; so that we may consider these movements as having somewhat of the same consensual character as that which has been attributed to the purely vocalizing actions (§ 611). But there is in many individuals a deficiency of the power of rightly combining them; from which *Stammering* and other imperfections result.

618. Many theories regarding the nature of *Stammering* have been proposed; and there can be little doubt, that the impediment may be attributed to

* Hence it is easy to understand the substitution of *t* or *d*, for the English *th*, by foreigners.

† The English *ch* is merely a combination of *t* with *sh*; thus *chime* might be spelt *tshime*.

‡ The general classification proposed by Dr. M. Hall is here adopted, with some modification as to the details.

a great variety of exciting causes. A disordered action of the nervous centres must, however, be regarded as the proximate cause; though this may be (to use the language of Dr. M. Hall) either of *centric* or of *excentric* origin,—that is, it may result from a morbid condition of the ganglionic centre, or from an undue excitement conveyed through its afferent nerves. When of centric origin (and this is probably the most general case), the phenomena of Stammering and Chorea have a close analogy to each other; in fact, stammering is frequently one of the modes in which the disordered condition of the nervous system in Chorea manifests itself. It is in the pronunciation of the Consonants of the *explosive* class, that the stammerer experiences the greatest difficulty. The total interruption to the breath which they occasion, frequently becomes quite spasmodic; and the whole frame is thrown into the most distressing semi-convulsive movement, until relieved by expiration.* In the pronunciation of the *continuous* Consonants of the first class, the stammerer usually prolongs them, by a spasmodic continuance of the same action; and there is, in consequence, an impeded, but not a suspended respiration. The same is the case with the *l* and *r* in the second class. In pronouncing the *m* and *n*, on the other hand, as well as the aspirates and vowels, it is sometimes observed that the stammerer prolongs the sound, by a full and exhausting expiration. In all these cases, then, it seems as if the muscular sense, resulting from each particular combination of actions, became the stimulus to the involuntary prolongation of that action. In some instances, it is possible that the defect may result from malformation of the parts about the fauces, producing an abnormal stimulus of this kind, in some particular positions of the organ; and such cases *may be* really benefited by an operation for the removal of these parts. But the effect of the operation is evidently for the most part upon the Nervous System; and it coincides with what may be frequently observed,—that the Stammering is increased under any unusual excitement, especially of the Emotional kind.

619. The method proposed by Dr. Arnott for the prevention of Stammering, consists in the connection of all the words by a vocal intonation, in such a manner, that there shall never be an entire stoppage of the breath. It is justly remarked by Müller, however, that this plan may afford some benefit, but cannot do everything; since the main impediment occurs in the middle of words themselves. One important remedial means, on which too much stress cannot be laid, is to study carefully the mechanism of the articulation of the difficult letters, and to practise their pronunciation repeatedly, slowly, and analytically. The patient would at first do well to practise sentences, from which the explosive consonants are omitted; his chief difficulty, arising from the spasmodic suspension of the expiratory movement, being thus avoided. Having mastered these, he may pass on to others, in which the difficult letters are sparingly introduced; and may finally accustom himself to the use of ordinary language. One of the chief points to be aimed at, is to make the patient feel that he has command over his muscles of articulation; and this is the best done, by gradually leading him from that which he finds he *can* do, to that which he fears he cannot. The fact that stammering people are able to *sing* their words better than to *speak* them, has been usually explained on the supposition that, in singing, the glottis is kept open, so that there is less liability to spasmodic action; if, however, as here maintained, the spasmodic action is not in the larynx, but in the velum palati and the muscles of articulation, the difference must be due to the direction of the attention rather

* By Dr. Arnott this interruption is represented as taking place in the larynx; that such is not the case, the Author believes that a little attention to the ordinary phenomena of voice will satisfactorily prove.

to the muscles of the larynx than to those of the mouth. Every one must have noticed how much the impediment of Stammerers is increased, when they are particularly anxious to speak fluently.

CHAPTER IX.

INFLUENCE OF THE NERVOUS SYSTEM ON THE ORGANIC FUNCTIONS.

620. OF the modes in which the Nervous System influences the Organic Functions, a part have been already considered. It has been shown (§ 183) that it is concerned in providing the conditions, either immediate or remote, under which alone these functions can be performed; so that, when its activity ceases, they cannot be much longer maintained. The first mode in which it operates upon them is, therefore, by producing sensible movements in the Muscles or other contractile organs, which can be stimulated to action through it; and the contractions thus induced have usually an important effect upon them, which varies, however, in each individual case. Thus, the process of Nutritive Absorption, which is the very first stage in the operations of Vegetative Life, and which is accomplished in Plants by the accidental contact of the alimentary materials with the radical fibres, cannot take place in Animals, until the muscular apparatus of prehension has been set in action by the Will, that of deglutition by the Reflex Function, and that of the intestinal canal by direct stimulation,—the two former kinds of contraction being accomplished entirely through the Nervous System, and the latter being influenced by it. The Circulation of Blood, too, is chiefly effected, in the higher Animals at least, by the contractions of a muscular organ of impulsion; which contractions, though not essentially dependent upon Nervous action, are nevertheless greatly influenced by it. The function of Respiration, again, cannot be maintained even for a short time, without muscular movement, excited through the Nervous System. The functions of Nutrition and Secretion are more independent of it; taking place, as in Plants, so long as the conditions are supplied by other functions, without any sensible movements being actually concerned in them. We shall presently see, however, that they are subject to a peculiar kind of Nervous influence, which does not manifest itself in obvious movement, but in altered performance of the intimate processes themselves; showing itself in the character of the organized tissue, or of the secreted product. The act of Excretion is, like ingestion, entirely performed by Muscular movement, dependent upon Nervous agency. Now, wherever such movements of distant organs are usually performed in connection with each other, there is an obvious channel for one kind of *sympathy* between them; an interesting example of this, is the contraction of the Uterus, which may be frequently made to occur, when that organ is in a relaxed state at the conclusion of labour, by applying suction or other irritation to the nipple.

621. Sympathetic movements of this kind may be excited either through the Cerebro-Spinal, or the Ganglionic systems; and we shall be guided in our determination of their channel in each particular case, by the distribution of these systems respectively to the organ affected. The sympathetic movements of the Muscles of Animal life appear to be chiefly, if not entirely, ex-

cited through the Cerebro-Spinal system; whilst those of the contractile tissues of the Viscera (§ 234) are probably excited through nerves, which, though connected with the Cerebro-Spinal system, act under peculiar conditions, and are commonly spoken of as forming part of the Sympathetic system. It has been shown (§§ 388—393) that all the contractile organs, which may be excited through the Sympathetic or Visceral system of nerves, may also be made to act by stimuli applied to the roots of the Spinal nerves; but that each Cerebro-Spinal fibre appears to pass through several Ganglia, before being distributed to the organs which it supplies.

a. Many speculations have been hazarded, as to the reasons why the Visceral nerves are destitute of sensibility; and, at the time when the Sympathetic was supposed to be merely an offset from the Cerebro-Spinal system, it was imagined that the use of the ganglia upon the roots of the spinal nerves was to “cut off sensation” from those concerned in the “vital and involuntary motions.” The influence of Bichât’s ingenious hypothesis,—that the Sympathetic system is complete and independent, ministering to the functions of Organic Life, as the Cerebro-Spinal does to those of Animal Life—for a time caused this idea to be abandoned. Since, however, it has been anatomically proved, that a large proportion of the filaments of the visceral nerves are derived from the Spinal cord, this opinion has been revived, in a somewhat modified form.* Nevertheless the evidence in its support is somewhat vague; especially if the truth of the doctrine formerly urged,—that the Spinal Cord is not itself a centre of sensation,—be admitted. For it is only necessary to suppose, that the white fibres of the Sympathetic nerve terminate in the true Spinal Cord, without proceeding to the Brain, to have an explanation of the absence of sensory endowments in the organs to which they are distributed, and of the complete removal of the muscles supplied by their motor nerves, from voluntary control. That a few fibres, of which the actions cannot be excited under ordinary circumstances, pass on to the Brain, would seem probable from the fact of the sensibility of some parts, in disease, which are totally insensible in their normal condition;—a fact in the explication of which, the hypothesis just alluded to affords no assistance.

622. It appears, then, that it may be stated as a general proposition, that all the evident movements which can be excited, by irritation applied to one part of the body, in the contractile organs or tissues of another, are really effected through the true Spinal Cord; whether the contractile organ be a powerful muscle, or a thin and feeble layer of fibres around a blood-vessel or duct. Upon the reasons why the fibres of the Visceral nerves should be so peculiarly separated from the rest, we can at present only speculate; but it may not be considered improbable that, by their peculiar plexiform arrangement in the various ganglia through which they pass, connections are established between remote organs, which tend to bring their actions into closer relation with each other, than would otherwise be the case. The existence of such connections for the purpose of harmonizing the several movements of the Viscera, which are concerned in the various and complex operations of Digestion and its attendant processes, may be inferred from the perfect conformity which exists between them, during all their different states of regular action; and still more, perhaps, from the phenomena of their disordered conditions. The study of these Sympathies is one of those departments of Physiology, in which it may be expected that much will be gained by patient and well-directed investigation.

623. The movements immediately concerned in the Organic Functions, however, are not influenced by Reflex action alone, but also by Emotional conditions of the mind. This is most obvious in regard to the Heart. Every one must have experienced the disturbance of its pulsations, consequent upon excitement of the feelings, of almost any description. But other organs probably experience similar changes, although of a less manifest character. It is well known that the Sympathetic system is largely distributed upon the trunks of

* See Dr. Alison on the Nerves of the Orbit; Edin. Phil. Trans., vol. xv.; and Med. Gaz. vol. xxviii. p. 378.

the blood-vessels, accompanying them to their minutest ramifications; and it will be hereafter shown (§ 732), that the fibrous tissue of the walls of the arteries is probably susceptible of influence from these nerves. There can be little doubt, therefore, that they constitute the channel through which Emotions operate, in producing sudden distension of particular parts of the vascular system, as in blushing, erection, &c. And to the same kind of influence, more gradually exerted, we may very probably attribute the regulation of the supply of blood which passes to different secreting organs, in varying conditions of the system.

624. But the Sympathetic System does not consist of Cerebro-Spinal filaments alone; nor is its influence exerted only upon the motor or contractile tissues of the body. There is good evidence, that the Nervous System has an immediate action upon the molecular changes, which constitute the functions of Nutrition, Secretion, &c.; and the channel of such influence is probably to be found in that system of peculiar fibres formerly described (§ 244), which constitutes a considerable proportion of the Visceral nerves, existing much more sparingly in most of the Cerebro-Spinal, but being abundant in the Fifth pair. There is no valid reason, however, to believe that any of the processes of Nutrition and Secretion are *dependent* upon this, or any other, kind of Nervous agency. These processes go on with great rapidity and energy in the Vegetable kingdom, in which nothing approaching to a Nervous System exists; and in the Animal kingdom they take place with equal vigour, long before the least vestige of it appears. The Embryological researches of Dr. Barry have fully proved, that in the earliest condition of fœtal life, the germ consists but of a congeries of cells, which have all originated in a single one; and from this mass, the several tissues are gradually generated, by a process which is technically called *histological** transformation,—one set of cells being converted into muscular tissue, another into nervous tissue, another into mucous membrane, and so on. Now since this is the case, it is evident that all these processes of development must take place, in virtue of the inherent properties of the primary tissue itself; since no nervous influence can be supposed to operate, before nerves are called into existence. Throughout the Animal body, it may be observed that, the more Vegetative the nature of any function, the less is it connected with the Nervous System; and all the experiments, which have been regarded as proving that the Organic functions are dependent upon Nervous influence, are really explicable, fully as well, upon the supposition that they are capable of being affected by it, either in the way of excitement or retardation (see § 415). Moreover, there is abundant evidence, that Secretion may take place after the death of the general system, through the persistence of certain molecular changes, of which the essential conditions are not immediately altered; thus Mr. T. Bell mentions that, in dissecting the poison apparatus of a Rattle-snake, which had been dead for some hours, the poison continued to be secreted, so fast as to require being occasionally dried off. This is precisely what might have been anticipated, from the independent power of growth in the secreting cells; and other acts of Nutrition are recorded to have occurred under similar circumstances. In such a case, the Animal body is reduced to the condition of a Plant; since the influence of the Nervous system must then be entirely extinct. Upon those who maintain that Nervous agency is a condition essential to those molecular actions, of which Nutrition and Secretion consist, it is incumbent, therefore, to offer some more unexceptionable proof of their position than has yet been given; since their doctrine is opposed by so many considerations of great weight.

* This term is used in contradistinction to *morphological*, which applies to the alterations in the *form* of the several parts of the embryo.

625. That many of the Organic Functions, however, are directly influenced by the Nervous System, is a matter which does not admit of dispute; and this influence, exerted sometimes in exciting, sometimes in checking, and sometimes in otherwise modifying them, may well be compared to that, which the hand and heel of the rider have upon his horse, or which the engine-driver exerts over a locomotive. It is most remarkably manifested in the result of severe injury of the Nervous centres,—such as concussion of the Brain, or of the Solar plexus (§ 580); for this does not merely produce a suspension of the respiratory and other movements, which minister to the organic functions, and hence a gradual stagnation of the latter,—but a sudden and complete cessation of the whole train of action; which cannot be attributed to any other cause than a *positive* depressing influence of some kind, propagated through the Nervous System. It will hereafter appear (§ 701), that in such cases even the vitality of the Blood is often affected; the usual coagulation not taking place after death, so long, at least, as the blood remains within the vessels. A similar general depression may result from Mental Emotion, operating through the same channel; but this more commonly has rather a local action, or operates more gradually.—The influence of the Nervous System is often especially exerted, in giving temporary excitement to a Secreting process; which need not be kept in constant activity, or of which circumstances may occasionally require an increase. This is the case, for example, in regard to the secretions connected with the process of digestion,—the Saliva, Gastric fluid, Bile, Pancreatic fluid, &c.; all of these being excited by the contact of the substances on which they act, with the surfaces on which their respective ducts open. The secretion of Milk, again, in a nursing female, may be excited by irritation of the nipple; and the determination of blood to the Mammæ during pregnancy, must be due to increased action in the part, excited by the changes occurring in the Uterus, which can scarcely operate otherwise than through the Nervous System. No other channel of influence can be well imagined for most of these operations, than the Sympathetic system of Nerves; since the organs in question are for the most part supplied by it. There is an apparent exception, however, in the case of the Salivary and Lachrymal glands, which are supplied by the Fifth pair; but this nerve contains so many organic filaments, and is so intimately connected with the Sympathetic, as evidently to supply (in the head) the place of a separate ganglionic system. It is by Nervous influence, that the mucous secretion covering the membranes is caused to be regularly formed for their protection; for it is shown, by pathological facts, that, when this influence is interrupted, and the secretion is no longer supplied, the membrane losing its protection, is irritated by the air or the fluids with which it may be in contact, and passes into an inflammatory condition. This is the explanation of the fact, which has been well ascertained, that the Eye is liable to suppurate when the Fifth pair has been divided; and that the mucous Membrane of the bladder becomes diseased in Paraplegia.

626. The influence of particular conditions of the mind, in exciting various Secretions, is a matter of daily experience. The flow of Saliva, for example, is stimulated by the idea of food, especially that of a savoury character. The Lachrymal secretion, again, which is continually being formed to a small extent, for the purpose of bathing the surface of the eye, is poured out in great abundance under the moderate excitement of the emotions, either of joy, tenderness, or grief. It is checked, however, by violent emotions; hence in intense grief the tears do not flow. It is a well-known proof of moderated sorrow, when this takes place; tears, however, do not bring relief, as is commonly believed, but they indicate that it has been brought. Violent emotion may also suspend the Salivary secretion; as is shown by the well-known test.

often resorted to in India, for the discovery of a thief amongst the servants of a family,—that of compelling all the parties to hold a certain quantity of rice in the mouth during a few minutes,—the offender being generally distinguished by the comparative dryness of his mouthful, at the end of the experiment. The influence of the emotion of love-of-offspring, in increasing the secretion of Milk, is well known. The formation of this fluid is continually going on during the period of lactation; but it is greatly increased by the sight of the infant, or even by the thought of him, especially when associated with the idea of suckling: this gives rise to the sudden rush of blood to the gland, which is known by nurses as the *draught*, and which occasions a greatly-increased secretion. The strong desire to furnish milk, together with the irritation of the gland through the nipple, has often been effectual in producing the secretion in girls and old women, and even in men (§ 853, *d*). The quantity of the Gastric secretion is increased by exhilaration; at least if we may judge from the increase of the digestive powers, under such circumstances. Freedom from mental anxiety favours the secretion of fat; whilst continual solicitude effectually checks the disposition. It has been stated that total despair has an equal tendency, with absence of care, to produce this effect; persons left long to pine in condemned cells, without a shadow of hope, frequently becoming remarkably fat in spite of their slender fare.* The odoriferous secretion of the Skin, which is much more powerful in some individuals than in others, is increased under the influence of certain mental emotions (as fear or bashfulness), and commonly also by sexual desire. The Sexual secretions themselves are strongly influenced by the condition of the mind. When it is frequently and strongly directed towards objects of passion, these secretions are increased in amount to a degree which may cause them to be a very injurious drain on the powers of the system. On the other hand, the active employment of the mental powers on other objects, has a tendency to render less active, or even to check altogether, the processes by which they are elaborated.†

* Fletcher's Physiology, Part II., *b*, p. 11.

† This is a simple physiological fact, but of high moral application. The Author would say to those of his younger readers, who urge the wants of Nature as an excuse for the illicit gratification of the sexual passion: "Try the effects of close mental application to some of those ennobling pursuits, to which your profession introduces you, in combination with vigorous bodily exercise (for the effects of which see § 470), before you assert that the appetite is unrestrainable, and act upon that assertion. Nothing tends so much to increase the desire, as the continual direction of the mind towards the objects of its gratification. The following observations, which the Author believes to be strictly correct, are extracted from a valuable little work (anonymous) entitled, "Be not deceived," addressed to Young Men; they are directed to those who maintain that, the married state being natural to Man, illicit intercourse is necessary for those who are prevented by circumstances from otherwise gratifying the sexual passion. "When the appetite is naturally indulged, that is, in marriage, the necessary energy is supplied by the nervous stimulus of its natural accompaniment of love before referred to, which prevents the injury which would otherwise arise from the increased expenditure of animal power: and in like manner, also, the function being in itself grateful, this personal attachment performs the further necessary office of preventing immoderate indulgence, by dividing the attention, through the numerous other sources of sympathy and enjoyment which it simultaneously opens to the mind. But, when the appetite is irregularly indulged, that is in fornication, for want of the healthful vigour of true love, its energies become exhausted; and from the want of the numerous other sympathetic sources of enjoyment in true love, in similar thoughts, common pursuits, and above all in common holy hopes, the more gross animal gratification of lust is resorted to with unnatural frequency, and thus its powers become still further exhausted, and, therefore, still more unsatisfying, while, at the same time, a habit is thus created, and these jointly cause an increased craving; and the still greater deficiency in the satisfaction experienced in its indulgence further, continually, ever in a circle, increases—the habit, demand, indulgence, consequent exhaustion, diminished satisfaction, and again demand,—till the mind and body alike become disorganized." Such considerations as these may, to some persons, appear misplaced

627. No secretion so evidently exhibits the influence of the depressing Emotions, as that of the *Mammæ*; but this may be partly due to the fact, that the digestive system of the Infant is a more delicate apparatus for testing the qualities of that secretion, than any which the Chemist can devise; affording proof, by disorder of its function, of changes in the character of the Milk, which no examination of its physical properties could detect. The following remarks on this subject are abridged from Sir A. Cooper's valuable work on the Breast. "The secretion of milk proceeds best in a *tranquil state of mind*, and with a cheerful temper: then the milk is regularly abundant, and agrees well with the child. On the contrary, a *fretful temper* lessens the quantity of milk, makes it thin and serous, and causes it to disturb the child's bowels, producing intestinal fever and much griping. *Fits of anger* produce a very irritating milk, followed by griping in the infant, with green stools. *Grief* has a great influence on lactation, and consequently upon the child. The loss of a near and dear relation, or a change of fortune, will often so much diminish the secretion of milk, as to render adventitious aid necessary for the support of the child. *Anxiety of mind* diminishes the quantity, and alters the quality of the milk. The reception of a letter which leaves the mind in anxious suspense, lessens the draught, and the breast becomes empty. If the child be ill, and the mother is anxious respecting it, she complains to her medical attendant that she has little milk, and that her infant is griped, and has frequent green and frothy motions. *Fear* has a powerful influence on the secretion of milk. I am informed by a medical man who practices much among the poor, that the apprehension of the brutal conduct of a drunken husband, will put a stop for a time to the secretion of milk. When this happens, the breast feels knotted and hard, flaccid from the absence of milk, and that which is secreted is highly irritating, and some time elapses before a healthy secretion returns. *Terror*, which is sudden and great fear, instantly stops this secretion." Of this, two striking instances, in which the secretion, although previously abundant, was completely arrested by this emotion, are detailed by Sir A. C. "Those passions which are generally sources of pleasure, and which, when moderately indulged, are conducive to health, will, when carried to excess, alter, and even entirely check the secretion of milk."

a. The following is perhaps the most remarkable instance on record, of the effect of strong mental excitement on the Mammary secretion; the event could hardly be regarded as more than a simple coincidence, if it were not borne out by the less striking, but equally decisive facts already mentioned. "A Carpenter fell into a quarrel with a Soldier billeted in his house, and was set upon by the latter with his drawn sword. The wife of the carpenter at first trembled from fear and terror, and then suddenly threw herself furiously between the combatants, wrested the sword from the soldier's hand, broke it in pieces, and threw it away. During the tumult, some neighbours came in and separated the men. While in this state of strong excitement, the mother took up her child from the cradle, where it lay playing, and in the most perfect health, never having had a moment's illness; she gave it the breast, and in so

in a Physiological Treatise—yet the Author feels sure that, by his well-judging readers, he will not be blamed for adverting to this subject, or for the introduction of the above quotation from a writer, of whom he has no personal knowledge, but whose object must be confessed by all to be laudable. There seems to be something in the process of training young men for the Medical Profession, which encourages in them a laxity of thought and expression on these matters, that generally ends in a laxity of action and of principle. It might have been expected that those who are so continually witnessing the melancholy consequences of the violation of the Divine law in this particular, would be the last to break it themselves: but this is unfortunately very far from being the case. The Author regrets to be obliged further to remark, that some recent works which have issued from the Medical press, contain much that is calculated to excite, rather than to repress, the propensity; and that the advice sometimes given by practitioners to their patients is immoral as well as unscientific.

doing sealed its fate. In a few minutes the infant left off sucking, became restless, panted, and sank dead upon its mother's bosom. The physician who was instantly called in, found the child lying in the cradle, as if asleep, and with its features undisturbed; but all his resources were fruitless. It was irrecoverably gone.* In this interesting case, the milk must have undergone a change, which gave it a powerful sedative action upon the susceptible nervous system of the infant.

b. The following, which occurred within the Author's own knowledge, is perhaps equally valuable to the Physiologist, as an example of the similarly-fatal influence of undue emotion of a different character; and both should serve as a salutary warning to mothers, not to indulge either in the exciting or depressing passions. A Lady having several children, of which none had manifested any particular tendency to cerebral disease, and of which the youngest was a healthy infant a few months old, heard of the death (from acute hydrocephalus) of the infant child of a friend residing at a distance, with whom she had been on terms of close intimacy, and whose family had increased almost contemporaneously with her own. The circumstance naturally made a strong impression on her mind; and she dwelt upon it the more, perhaps, as she happened, at that period, to be separated from the rest of her family, and to be much alone with her babe. One morning, shortly after having nursed it, she laid the infant in its cradle, asleep and apparently in perfect health; her attention was shortly attracted to it by a noise; and, on going to the cradle, she found her infant in a convulsion, which lasted for a few minutes, and then left it dead.—Now, although the influence of the mental emotion is less unequivocally displayed in this case than in the last, it can scarcely be a matter of doubt; since it is natural that no feeling should be stronger in the mother's mind under such circumstances, than the fear that her own beloved child should be taken from her, as that of her friend had been; and it is probable that she had been particularly dwelling on it, at the time of nursing the infant on that morning.

c. Another instance, in which the maternal influence was less certain, but in which it was not improbably the immediate cause of the fatal termination, occurred in a family nearly related to the Author's. The mother had lost several children in early infancy, from a convulsive disorder; one infant, however, survived the usually-fatal period; but whilst nursing him, one morning, she had been strongly dwelling on the fear of losing him also, although he appeared a very healthy child. In a few minutes after the infant had been transferred into the arms of the nurse, and whilst she was urging her mistress to take a more cheerful view, directing her attention to his thriving appearance, he was seized with a convulsion-fit and died almost instantly. Now although there was here unquestionably a predisposing cause, of which there is no evidence in the other cases, it can scarcely be doubted that the *exciting* cause of the fatal disorder is to be referred to the mother's anxiety. This case offers a valuable suggestion,—which, indeed, would be afforded by other considerations,—that an infant, under such circumstances, should not be nursed by its mother, but by another woman of placid temperament, who had reared healthy children of her own.

628. Other Secretions are in like manner vitiated by mental Emotions, although the influence is not always so manifest. Thus, the halitus from the lungs is sometimes almost instantaneously affected by bad news, so as to produce fœtid breath. A copious secretion of fœtid gas not unfrequently takes place in the intestinal canal, under the influence of any disturbing emotion; or the usual fluid secretions from its walls are similarly disordered. The tendency to defecation which is commonly excited under such circumstances, is not, therefore, due simply to the relaxation of the sphincter ani (as commonly supposed); but is partly dependent on the unusually stimulating character of the fœces themselves. The same may be said of the tendency to micturition, which is experienced under similar conditions: the change in its

* Dr. Von Ammon, in his treatise "Die ersten Mutterpflichten und die erste Kindespflege," quoted in Dr. Combe's excellent little work on the Management of Infancy. Similar facts are recorded by other writers. Mr. Wardrop mentions (Lancet, No. 516), that having removed a small tumour from behind the ear of a mother, all went well, until she fell into a violent passion; and the child, being suckled soon afterwards, died in convulsions. He was sent for hastily, to see another child in convulsions, after taking the breast of a nurse who had just been severely reprimanded; and he was informed by Sir Richard Croft, that he had seen many similar instances. Three others are recorded by Burdach (Physiologie, § 522); in one of them, the infant was seized with convulsions on the right side, and hemiplegia on the left, on sucking immediately after its mother had met with some distressing occurrence. Another case was that of a puppy, which was seized with epilepsy, on sucking its mother after a fit of rage.

character becomes perceptible enough among many animals, in which it acquires a powerfully-disagreeable odour under the influence of fear; and thus answers the purpose, which is effected in others by a peculiar secretion. It is a prevalent, and perhaps not an ill-founded opinion, that melancholy and jealousy have a tendency to increase the quantity, and to vitiate the quality, of the biliary fluid; perhaps the disorder of the organic function is more commonly the source of the former emotion, than its consequence; but it is certain that the indulgence of these feelings has a decidedly morbid effect, by disordering the digestive processes, and thus reacts upon the nervous system by impairing its healthy nutrition. On the influence of mental emotion in the Mother, on the Fœtus in utero, some remarks will be offered hereafter (§ 938).

CHAPTER X.

OF FOOD, AND THE DIGESTIVE PROCESS.

1.—*Sources of the Demand for Aliment.—Hunger and Thirst.*

629. THE dependence of all Organized beings upon a supply of aliment,—in the first place for the development of their fabric, and in the second for the maintenance of their activity,—is a circumstance of such a familiar character, that it might not seem worth while to dwell upon it. Nevertheless the inquiry into the purposes which the aliment serves in the economy, and into the relative values of different articles of food, cannot be advantageously prosecuted, until we have first determined, with more precision, the causes which occasion the demand to be set up. These will be now briefly enumerated.

630. In the first place, a due supply of aliment is required, for the first development of the *germ* into the *adult fabric*. In all instances, the essential character of the act of Reproduction appears to be the liberation or setting-free of a cell-germ; which, according to the character of the being that gave origin to it, may be destined to evolve, either a simple cell (as in the lowest Cryptogamic Plants), a congeries of cells having a certain degree of variety of form and of difference of function (as in the higher classes of the Vegetable kingdom), or a complex fabric, composed of an immense variety of parts, most of them departing widely, in appearance at least, from the original cellular type, and destined to perform a vast variety of actions,—as we see in the perfectly developed organism of the higher Animals. The materials which are subservient to this evolution, are all derived from the external world; either immediately, or through the medium of the parent. The germs of the lowly Cryptogamia are thrown at once upon the world (so to speak), to obtain their own livelihood; and they themselves occasion the combination of the inorganic elements, which they there meet with, into the organic compounds, which are to be applied to the development of their simple organisms. In the Flowering Plants, on the other hand, the germ is at first supplied with a store of nutriment, which has already undergone this preparation, by the agency of the parent; and this store, laid up in the seed, is employed in the development of the fabric of the young plant, until its organs are sufficiently evolved to enable it to perform the same processes for itself. The same plan

is invariably followed in the development of the Animal; the nutriment stored up in the ovum being usually sufficient for the evolution of the fabric, until it acquires the power of ingesting food for itself; and where this is not the case (as in the Mammalia), a further provision being adopted, by which the supply is continued during a lengthened period. Even when thrown upon its own resources, the young Animal is often far from having attained even the *form* of its parent; much less its *size*: and in the progress of its evolution, a greater or less degree of *metamorphosis* or change of form is observable. This is not usually so much the case in the higher animals, as in the lower; because the supply of nutriment is proportionally greater in the former, and serves to carry on the development to a later period; but the changes of condition which their germinal structure undergoes within the ovum, are really as remarkable as those which are presented in the early embryos of the latter after their emersion from the egg.

a. The phenomena of *metamorphosis* are most familiarly known in the case of Insects, and Frogs, which were formerly thought to be exceptions to all general rules; the Insect coming forth from the egg in the state of a Worm; and the Frog in the condition of a Fish. But it is now known that changes of form, as complete as these, occur in a large proportion of the lower tribes of Animals; so that the *absence* of them is the exception. The true mode of viewing these early aspects of Animals of the inferior groups, seems to be to regard them as fetal or embryonic; thus, the Insect, in its larva state, is essentially a fetus, as regards the grade of development of its several tissues and organs; but it is a fetus capable of obtaining its own nourishment. In this condition it attains its full growth as regards *size*, though its *form* remains the same; but it then, in passing into the Chrysalis state, re-assumes (as it were) the condition of the embryo within the egg,—the development of various new parts takes place, at the expense of the nutriment stored up in its tissues,—and it comes forth in the state of the perfect Insect, which henceforth takes no more food than is requisite for the *maintenance* of the fabric thus evolved, or for the preparation of the stores to be imparted to the offspring.—In many of the lower tribes, the animal quits the egg at a still earlier period in comparison; thus it has been lately shown by M. Milne Edwards, that some of the long Marine Worms consist only of a single segment, forming a kind of head, when they leave the egg; and that the other segments, to the number it may be of several hundred, are gradually developed from this; the evolution continuing in some instances during a considerable part of life. In some of the Radiated tribes, propagation actually takes place whilst the animal is yet in its first or imperfect form; thus the Medusæ begin life as Polypes, and in this condition they increase by germination or budding, in the manner of the true or permanent Polypes.

631. It is desirable to bear in mind, that the function of the Germ is simply that of *occasioning the combination* of the materials supplied by the external world, and of *directing the appropriation* of those materials. The several parts of the complex fabric of the higher Animals, contain a great variety of materials; and it is therefore requisite for its development, that it should be duly supplied with all these.—The demand set up by the fabric, whilst in course of development or evolution, for the materials of its growth, constitutes, therefore, the primary source of the requirement of food; and the nature of this must be adapted to the wants of the being. Thus, the fabric of Plants is essentially composed of Cellulose, a compound of Oxygen, Hydrogen, and Carbon; and the materials required for the production of this are simply Carbonic Acid and Water. But nearly all Plants form some *azotized* compound in the interior of their cells; for the production of which, Ammonia also is required. And in those species, which, like the *Cercalia*, form a large quantity of azotized compounds, and store them up in their seeds, a free supply of Ammonia is requisite for the production of the greatest proportion which they are capable of generating.—In Animals, again, whose tissue chiefly consists of these very azotized compounds, or of modifications of them, a constant supply of such is required during the whole period of the development of the fabric, as well as subsequently; and if they be not afforded in

sufficient amount, the evolution of the organism is either retarded or checked altogether.* But there is one tissue, namely, Fat, the peculiar characters of which are derived from the presence of a non-azotized substance in its cells; and this cannot be developed, unless there be in the food either oily, saccharine, or amylaceous matters, from any of which the fatty compounds may be generated.

632. The full development of the Animal fabric, however, does not by any means involve the cessation of the demand for food; in fact, during the whole period of that development, it may be observed that the amount of nutriment ingested is far greater than that which is applied to the simple extension of the structure (§ 269). One source of this constant demand is to be found in the continual *waste* or disintegration of the fabric, which goes on to a certain extent under all circumstances, but which varies in degree according to certain conditions not difficult to be understood.—All organized substances are liable, from the peculiarity of their chemical composition, to interstitial decay; and this operates in the living organism, as much as in the dead body (§ 268). The difference is, that, in the living fabric, there is a provision for at once removing the products of decay, so that they may be cast out of the system as soon as possible; whilst in the dead body they remain, and act as ferments, accelerating the decomposition of other parts. Now the amount of this interstitial decay varies with the temperature; being increased by warmth, and retarded by cold. It is consequently greatest in warm-blooded animals, the temperature of whose bodies is constantly sustained at a high standard; it is reduced to its minimum in the torpid condition of cold-blooded animals, which is brought on by the agency of cold; and will be lowered to nearly the same degree in the hibernating state of certain Mammalia.—There is another source of waste and decay, which is common to Animals, and all but the simplest Plants; this results from the limited duration of life in the individual parts, which are most actively concerned in the Vegetative Functions. We have seen that the essential instruments in the various functions of Absorption, Assimilation, Respiration, Secretion, and Reproduction, are *cells*; each of which goes through a certain series of processes and then dies and decays,—just as do the isolated cells, which compose the entire fabric of the simplest Cryptogamic Plants. This is evidenced to us in the Vegetable kingdom by the “fall of the leaf;” which is nothing else than the result of the death and decay of the component cells of that organ, after having fulfilled their peculiar functions; these consisting in the preparation or elaboration of the nutritious sap, from which the various tissues and secretions of the plant are subsequently generated. The same process is continually taking place, though in a less obvious manner, in the Animal body; the rate of death and renewal of each group of cells being greater, as the functions to which it ministers are energetically performed; whilst the energy of these operations is mainly dependent upon the demand set up by the exercise of the *Animal* functions, for the reparation of the Nervous and Muscular tissues.

633. The great source of *waste* and *decay* in the Animal body, and consequently the chief source of the demand for food, is the disintegration of the Nervous and Muscular tissues, which has been shown to be a necessary condition of their functional activity. Every manifestation of Nervous power, of whatever kind, seems to require the combination of Oxygen with the elements of Nervous matter; the normal composition of which is thus destroyed,

* The very curious discovery has lately been made, in regard to the integuments of the Tunicated or Ascidian Mollusca (the lowest class of that sub-kingdom), that they contain a considerable quantity of *Cellulose*; a substance which had not been previously supposed to be a normal constituent of the Animal Fabric. See *Annales des Sciences Naturelles*; 3me Serie, Zool., tom. v. p. 193 *et seq.*

so that it ceases to be fit to form part of the body, and is cast out by the various processes of excretion. The same is the case in regard to the Muscular substance; the waste of which is conformable to the use made of it. The demand for the materials of reparation will follow the same proportion; and as the preparation of these materials can only be effected by the agency of the Vegetative or nutritive functions, the rate at which these are performed will be greatly influenced by the activity of the Animal functions. Hence we see the necessity of regulating the supply of food, in accordance with the state of the latter; since a diet which would be superfluous and injurious to an individual of inert habits, is suitable and beneficial to one who is leading a life of continual exertion. This difference manifests itself remarkably in the contrast between Animals of different tribes, whose natural instincts lead them to different modes of life. The Birds of most active flight, and the Mammals which are required to put forth the greatest efforts to obtain their food, need the largest and most constant supplies of nutriment; but even the least active of these classes stand in remarkable contrast with the inert Reptiles, whose slow and feeble movements are attended with so little waste, that they can sustain life for weeks and even months, with little or no diminution of their usual activity, without a fresh supply of food.*

634. Finally, there is a most important cause of demand for food, amongst the higher Animals, which does not exist either amongst the lower Animals, or in the Vegetable kingdom, at least to any great degree. In the classes of Mammals and Birds, and in that of Insects also, we find a capability of sustaining the heat of the body at a fixed standard; which is usually far above that of the surrounding medium. This they are enabled to do, as will be explained hereafter, by a process strictly analogous to ordinary combustion; the Carbon and Hydrogen, which are directly supplied by their food, or which have been employed for a time in the composition of their living tissues and then set free, being made to combine with Oxygen introduced by the respiratory process, and thus giving out the same heat, as if the same materials were burned in a furnace. It will be hereafter shown that the immediate cause of death in a warm-blooded animal, from which the food has been entirely withheld, is the inability any longer to sustain the temperature which is requisite for the performance of its vital operations (Chap. XVI., Sect. 2). Hence we see the necessity for a constant supply of aliment, in the case of warm-blooded animals, for this purpose alone; and the demand will be regulated by the external temperature. When the heat is rapidly carried off from the surface by the chilling influence of the surrounding air or water, a much greater amount of Carbon and Hydrogen must be consumed within the body, to maintain its proper heat, than when the medium is nearly as warm as the body itself; so that a diet, which is appropriate in the former circumstances, is superfluous and injurious in the latter; and the food which is amply sufficient in a warm climate, is utterly destitute of power to enable it to resist the influence of severe cold. Substances rich in carbon and hydrogen, and having little or no oxygen, afford the most efficient heat-sustaining materials; but it is an essential condition of their due action, that they should be of a kind that renders them capable of being reduced by the solvent action of the stomach, and of being absorbed into the system.

635. The demand for food is increased by any cause which creates an unusual drain or waste in the system. Thus an extensive suppurating action

* The materials which are required for the reparation of the Muscular tissue, are chiefly of a fibrinous nature; those employed for the renovation of the Nervous substance, would seem to be fatty matter with Phosphorus. But from the peculiar composition of the fatty matters of the Nervous substance (especially the presence of Azote in them), it seems quite uncertain from which of the constituents of the food they are really formed.

can be sustained only by a large supply of highly nutritious food. The mother who has to furnish the daily supply of milk, which constitutes the sole support of her offspring, needs an unusual sustenance for this purpose. And there are states of the system, in which the solid tissues seem to possess an unusual tendency to decomposition, and in which an increased supply of aliment is therefore required. This is the case, for example, in Diabetes; one of the first symptoms of which disease is the craving appetite, that seems as if it would be never satisfied. And there can be no doubt that, putting aside all the other circumstances which have been alluded to, there is much difference amongst individuals, in regard to the rapidity of the changes which their organism undergoes, and the amount of food consequently required for its maintenance.

636. The want of solid aliment is indicated by the sensation of Hunger; and that of liquid by thirst. The former of these sensations is referred to the stomach; and the latter to the fauces: but although certain conditions of these parts may be the immediate cause of the sensations in question, they are really indicative of the requirements of the system at large. For the intensity of the feelings bears no constant relation to the amount of solid or liquid aliment in the stomach; whilst, on the other hand, it does correspond with the excess of demand in the system, over the supply afforded by the blood; and it is caused to abate by the introduction of the requisite materials into the circulating fluid, even though this be not accomplished in the usual manner by the ingestion of food into the stomach.

637. That the sense of Hunger, however, is *immediately* dependent upon some condition of the Stomach, seems to follow from the fact, that it is abated, if not arrested, by section of the Par Vagus (§ 412); and that it may be temporarily alleviated, by introducing into the digestive cavity, matter which is not alimentary. Of the precise nature of that condition, however, we have no certain knowledge. It is easy to prove that many of the causes which have been assigned for the sensation, are but little, if at all, concerned in producing it. Thus, mere emptiness of the stomach cannot occasion it; since, if the previous meal have been ample, the food passes from its cavity some time before a renewal of the uneasy feeling; and this emptiness may continue (in certain disordered states of the system) for many hours or even days, without a return of desire for food. It cannot be due, as some have supposed, to the action of the gastric fluid upon the coats of the stomach themselves; since this fluid is not poured into the Stomach, except when the production of it is stimulated by the irritation of its secreting follicles. By Dr. Beaumont it is thought, that the distension of these follicles with the secreted fluid is the proximate cause of hunger; but there is no more reason to believe that the secretion of Gastric fluid is accumulating during the intervals when it is not required, than there is in regard to Saliva, the Lachrymal fluid, or any other secretions, which are occasionally poured out in large quantities under the influence of a particular stimulus; and, moreover, it is difficult to imagine how mental emotion, or any impression on the nervous system alone (which is able, as is well known, to dissipate the keenest appetite in a moment), can relieve such distension.—It may, perhaps, be a more probable supposition, that there is a certain condition of the Capillary circulation in the Stomach, which is preparatory to the secretion, and which is excited by the influence of the Sympathetic nerves, that communicate (as it were) the wants of the general system. This condition may be easily imagined to be the proximate cause of the sensation of hunger, by acting on the Par Vagus. When food is introduced into the stomach, the act of secretion is directly excited; the capillary vessels are gradually unloaded; and the immediate cause of the impression on the par vagum is withdrawn. By the conversion of the alimentary

matter into materials fit for the nutrition of the system, the remote demand also is satisfied; and thus it is that the condition of the stomach just referred to, permanently relieved by the ingestion of substances that can serve as food. But if the ingested matter be not of a kind capable of solution and assimilation, the feeling of hunger is only temporarily relieved, and soon returns in greater force than before.—The theory here given seems reconcilable with all that has been said of the conditions of the sense of hunger; and particularly with what is known of the effect produced upon it by nervous impressions, which have a peculiar influence upon the capillary circulation. It also corresponds exactly with what we know of the influence of the nervous system, and of mental impressions, upon other secretions (§ 624).

638. The sense of Hunger, like other sensations, may not be taken cognizance of by the Mind, if its attention be strongly directed towards other objects; of this fact, almost every one engaged in active occupations, whether mental or bodily, is occasionally conscious. The nocturnal student, who takes a light and early evening meal, and, after devoting himself to his pursuits for several hours uninterruptedly, retires to rest with a wearied head and an empty stomach, but without the least sensation of hunger, is frequently prevented from sleeping by an indescribable feeling of restlessness and *deficiency*; and the introduction of a small quantity of food into the stomach will almost instantaneously allay this, and procure comfortable rest. Many persons, again, who desire to take active exercise before breakfast, are prevented from doing so by the lassitude and even faintness which it induces,—the bodily exercise increasing the demand for food, whilst it draws off the attention from the sensation of hunger.

a. The Author may be excused for mentioning the following circumstance, which some years ago occurred to himself; and which seems to him a good illustration of the principle, that the sense of hunger *originates* in the condition of the general system, and that its *manifestation* through a peculiar action in the stomach, is to be regarded as a secondary phenomenon.—adapted, under ordinary circumstances, to arouse the mind to the actions necessary for the supply of the physical wants,—but capable of being overlooked if the attention of the mind be otherwise directed. He was walking alone through a beautiful country, and with much to occupy his mind; and, having expected to meet with some opportunity of obtaining refreshment on his road, he had taken no food since his breakfast. This expectation, however, was not fulfilled; but, as he felt no hunger, he thought little of the disappointment. It was evening before he approached the place of his destination, after having walked about twenty miles, resting frequently by the way; and he then began to feel a peculiar lassitude, differing from ordinary fatigue, which rapidly increased, so that during the last mile he could scarcely support himself. The “stimulus of necessity,” however, kept him up; but on arriving at his temporary home, he immediately fainted. It is obvious that, in this case, the occupation of the mind on the objects around, and on its own thoughts, had prevented the usual warning of hunger from being perceived; and the effect which succeeded was exactly what was to be anticipated, from the exhaustion of the supply of food occasioned by the active and prolonged exertion.

639. The conditions of the sense of Thirst appear to be very analogous to those of hunger. This sense is not referred, however, to the stomach, but to the fauces. It is generally considered that it immediately results from an impression on the nerves of the stomach; since, if liquids are introduced into the stomach through an œsophagus-tube, they are just as effectual in allaying thirst, as if they are swallowed in the ordinary manner. It may, however, be doubted, whether the sense of thirst is not even more immediately connected with the state of the general system, than that of hunger; for the immediate relief afforded by the introduction of liquid into the stomach, is fully accounted for by the instantaneous absorption of the fluid into the veins, which is known to take place when there is a demand for it, not only from Dr. Beaumont’s observations, but from many experiments made with reference to this particular question. This demand is increased with almost equal rapidity,

by an excess in the amount of the fluid excretions; and it may be satisfied without the introduction of water into the stomach* (§ 677). Thirst may also be produced, however, by the impression made by peculiar kinds of food or drink upon the walls of the alimentary canal; thus salted or highly-spiced meat, fermented liquors when too little diluted, and other similarly irritating agents, excite thirst; the purpose of which is obviously to cause ingestion of fluid, by which they may be diluted.

2.—*Nature and Destination of the Food of Animals.*

640. The substances which are required by Animals for the development and maintenance of their fabric, are of two kinds;—the Organic and the Inorganic. The former alone are commonly reckoned as aliments; but the latter are really not less requisite for the sustenance of the body, which speedily disintegrates, if the attempt be made to support it upon any organic compounds in a state of purity. In all ordinary articles of diet, however, the inorganic matters are present in the requisite proportion; and hence they have very commonly escaped notice. The nature of these substances, and the mode in which they are introduced into the body, will be considered hereafter (§ 648). The Organic matters, used as food by Animals, are partly derived from the Animal, and partly from the Vegetable kingdom; and they may be conveniently arranged under the four following heads:†—1. The *Saccharine* group, including all those substances, derived from the Vegetable kingdom, which are analogous in their composition to Sugar;—consisting of oxygen, hydrogen, and carbon, alone; and having the two first present in the proportions to form water. To this group belong starch, gum, woody fibre, and the various tissues of Plants; which closely resemble each other in the proportion of their elements, and which may be converted into Sugar by chemical processes of a simple kind.—2. The *Oleaginous* group, including oily matters, whether derived from the Vegetable kingdom, or from the fatty portions of Animal bodies. The characteristic of this class, is the great predominance of hydrogen and carbon, the small proportion of oxygen, and the entire absence of nitrogen.—3. The *Albuminous* group, comprising all those substances, whether derived from the Animal or Vegetable kingdom, which are closely allied to Albumen, and therefore to the majority of the Animal tissues, in their chemical composition. In this group, a large proportion of azote is united with the oxygen, hydrogen, and carbon of the preceding.—4. The *Gelatinous* group, consisting of substances derived from Animal bodies only, which are closely allied to Gelatine in their composition. These also contain azote; but the proportion of their components differs from that of the preceding.

641. The compounds of the *Saccharine* group cannot, without undergoing a metamorphosis, form part of any Animal tissue; as there is none which they resemble in composition. It will be shown, however, that they are convertible, within the Animal body, into those of the *Oleaginous* group; and, like them, may be deposited in the form of Adipose matter. There is no other tissue in the body, into which they can enter without considerable change; for all others are *azotized*; and it seems extremely improbable that non-azotized compounds can, under any circumstances, be converted within the body into compounds of the albuminous or gelatinous groups.

* This was among the remarkable results of the injection of fluid into the veins, in the Asiatic Cholera.

† Dr. Prout's classification of alimentary substances is here adopted, with a slight modification; not as being altogether unexceptionable, but as being, in the Author's opinion, the most convenient hitherto proposed.

642. The application of the substances forming the *Albuminous* group, to the support of the Animal body, by affording the materials for the nutrition and re-formation of its tissues, needs little explanation. The proportions of the four ingredients of which they are all composed, are so nearly the same, that no essential difference appears to exist among them; and it is a matter of little consequence, except as far as the gratification of the palate is concerned, whether we feed upon the flesh of animals (fibrine), upon the white of egg (albumen), the curd of milk (caseine), the grain of wheat (gluten), or the seed of the pea (legumin). All these substances are reduced in the stomach to the form of *albumen*; which resembles the *gum* of Plants, in being the raw material, as it were, out of which the various fabrics of the body are constructed. But the rule holds good, with regard to these also, that by being made to feed constantly on the same substance,—boiled white of egg, for instance, or meat deprived of the principle (osmazome) that gives it flavour,—an animal may be effectually starved; its disgust at the food being such, that even if it be swallowed, it is not digested. It is very interesting to remark that, in the only instance in which Nature has provided a *single* article of food for the support of the animal body, she has mingled articles from the three first of the preceding groups. This is the case in *Milk*, which contains a considerable quantity of an albuminous substance, *caseine*, which forms its curd; a good deal of *oily* matter, the butter; and no inconsiderable amount of *sugar*, which is dissolved in the whey. The proportions of these vary in different Mammalia; and they depend in part upon the nature of the food supplied to the Animal that forms the milk; but the substances are thus combined in every instance.—Although the greater part of the organized tissue of Animals is formed at the expense of the Albumen and Fibrine of their blood, yet many of them also contain a large quantity of *Gelatine*. It seems certain that this gelatine may be produced out of fibrine and albumen; since in animals that are supported on these alone, the nutrition of the gelatinous tissues does not seem to be impaired. But it also appears, that gelatine taken in as food may be applied to this purpose; for ordinary experience shows, that benefit is derived from jelly, soup, broth, &c.; peculiarly by persons who have been suffering under exhausting diseases, such as fevers. But it also appears certain, that it cannot be applied to the nutrition of the Albuminous tissues. Some important experiments have been recently made in Paris on this subject, with a view of determining how far the soup made from crushed bones, which constituted a principal article of diet in the hospitals of Paris, was adequate for the support of the patients. The result of these has been quite confirmatory of previous conclusions,—namely, that Gelatine may be advantageously mixed with albumen, fibrine, gluten, &c., and those other ingredients which exist in meat-soup and bread; but that, when taken alone, it has little more power of sustaining life than sugar or starch possesses; and that, even when bread is united with gelatine-soup, it does not give it the requisite power of nutrition.

643. If the *non-azotized* compounds which exist so largely in the food of Herbivorous animals, be not destined to form part (in any considerable degree at least) of their tissues, the question arises,—what becomes of them? It is not enough to say that they are deposited as Fat; since it is only when a large quantity of them is taken in, that there is any increase in the quantity of fat already in the body. We shall hereafter see, that they are used up in the process of Respiration; being burned-off within the body, for the purpose of keeping up its temperature. The process will be hereafter considered more in detail; and at present we need only stop to remark upon the adaptation between the food provided for animals in different climates, and the amount of heat which it is necessary for them to produce. Thus the bears, and seals,

and whales, from which the Esquimaux and the Greenlander derive their support, have an enormous quantity of fat in their massive bodies: this fat is as much esteemed as an article of food among these people, as it would be thought repulsive by the inhabitants of southern climates; and by the large quantity of it they consume, they are able to support the bitterness of an Arctic winter, without appearing to suffer more from the extreme cold, than do the residents in more temperate climates during *their* winter. On the other hand, the antelopes, deer, and wild cattle, which form a large proportion of the animal food of savage or half-cultivated nations inhabiting temperate or tropical regions, possess very little fat; and the comparatively small supply of carbon and hydrogen, whose combustion is required to keep up the bodily temperature of the inhabitants of those regions, is derived from the *flesh* of those animals, in the manner that will be presently explained. Every one knows how much less vigorous the appetite becomes, during the heat of summer, than it is during the colder portion of the year; and this is a natural result of the diminished demand for the fuel required to maintain the temperature. And one great means of preserving the health, during a prolonged residence in a hot climate, is to attend to the dictates of Nature, in regard to the quantity of food ingested; instead of endeavouring (as is the prevalent practice) to stimulate the appetite by artificial provocatives.

644. The maintenance of the bodily temperature in *Carnivorous* animals, appears to depend upon the combustion of the carbon and hydrogen set free by the disintegration of their Nervous and Muscular tissues: this disintegration taking place with much more rapidity, in consequence of their almost unceasing activity, than it does in the *Herbivorous* animals, which lead comparatively inactive lives. Every one who has visited a menagerie, must have noticed the continual restlessness of the Tigers, Leopards, Hyænas, &c., which keep pacing from one end of their narrow cages to the other; and it would seem as if this restlessness were a natural instinct, impelling them to use muscular exertion sufficient for the metamorphosis of an adequate amount of tissue, that enough carbon and hydrogen may be set free for the support of the respiratory process. And we see a corresponding activity in the Human hunters of the swift-footed Antelope and agile Deer, which answers a similar purpose: and which is remarkably contrasted with the stupid inertness of the inhabitants of the frigid zone, which is only occasionally interrupted by the necessity of securing the supplies of food afforded by the massive tenants of their seas.—The nutrition of the *Carnivorous* races may, then, be thus described. The bodies of the animals upon which they feed contain flesh, fat, &c., in nearly the same proportion as their own; and all, or nearly all, the aliment they consume, goes to supply the waste in the fabric of their own bodies, being converted into its various forms of tissue. After having remained in this condition for a certain time, varying according to the use that is made of them, these tissues undergo another metamorphosis, which ends in restoring them to inorganic matter; and thus give back to the Mineral world the materials which were drawn off from it by Plants. Of these Materials, part are burned off, as it were, within the body, by union with the oxygen of the air, taken in through the lungs; and are discharged from these organs, in the form of carbonic acid and water: the remainder are carried off in the liquid form by other channels. Hence we may briefly express the destination of their food in the following manner:—

Food consisting of albumen, fibrine, and other azotized compounds	} Convert-	} Living	} And this	} Carbonic acid and Water
	ed into	organized	metamor-	thrown off by respiration.
		tissue.	phosed into	Urea and biliary matter, &c.,
				thrown off by other excretions.

645. But in regard to the *Herbivorous* animals, the case is different. They perspire much more abundantly, and their temperature is thus continually kept down. They consequently require a more active combustion, to develop sufficient bodily heat; and the materials for this are supplied, as we have seen, by the non-azotized portions of their food, rather than by the metamorphosis of their own tissues, which takes place with much less rapidity than in the Carnivorous tribes. Hence we may thus express the destination of this part of their food; that of the azotized matter, here much smaller in amount, will be the same as in the preceding case:—

Starch, oil, and other non-azotized compounds	} partly converted into	{ Adipose tissue	} but chiefly thrown off directly as	{ Carbonic acid and Water, dis- engaged by the respiratory process.
---	-------------------------------	---------------------	--	---

The proportion of the food deposited as fat, will depend in part upon the surplus which remains, after the necessary supply of materials has been afforded to the respiratory process. Hence, the same quantity of food being taken, the quantity of fat will be increased by causes that check the perspiration, and otherwise prevent the temperature of the body from being lowered, so that there is need of less combustion within the body to keep up its heat. This is consistent with the teachings of experience respecting the fattening of cattle; for it is well known that this may be accomplished much sooner, if the animals are shut up in a warm dwelling and covered with cloths, than if they are freely exposed in the open air.

646. Now the condition of Man may be regarded as intermediate between these two extremes. The construction of his digestive apparatus, as well as his own instinctive propensities, point to a mixed diet as that which is best suited to his wants. It does not appear that a diet composed of *ordinary* vegetables only, is favourable to the full development of either his bodily or mental powers; but this cannot be said in regard to a diet of which *bread* is the chief ingredient, since the gluten it contains appears to be as well adapted for the nutrition of the animal tissues, as does the flesh of animals. On the other hand, a diet composed of animal flesh alone is the least economical that can be conceived; for, since the greatest demand for food is created in him (taking a man of average habits, in regard to activity and the climate he inhabits), by the necessity for a supply of carbon and hydrogen to support his respiration, this want may be most advantageously fulfilled by the employment of a certain quantity of non-azotized food, in which these ingredients predominate. Thus it has been calculated, that, since fifteen pounds of flesh contain no more carbon than four pounds of starch, a savage with one carcass and an equal weight of starch, could support life for the same length of time, during which another restricted to animal food would require five such carcasses, in order to procure the carbon necessary for respiration. Hence we see the immense advantage as to economy of food, which a fixed agricultural population possesses over those wandering tribes of hunters, which still people a large part both of the old and new continents. The mixture of the azotized and non-azotized compounds (gluten and starch), that exists in wheat flour, seems to be just that which is most useful to Man; and hence we see the explanation of the fact, that, from very early ages, bread has been regarded as the "staff of life." In regard to the nutritious properties of different articles of vegetable food, these may be generally estimated by the proportion of azote they contain; which is in almost every instance less than that existing in good wheat flour.

647. The following table represents the relative quantity of Nitrogen in different articles used as food; and thus shows their relative applicability to

the maintenance and reparation of the body.* Those which are poorest in nitrogen, are richest in Carbon and Hydrogen; and are, therefore, the best adapted to serve as the *pabulum* for the heat-sustaining process. It is to be borne in mind, however, that no table of this kind, founded simply upon the Chemical composition of the various substances, can indicate their respective fitness as articles of diet; since this depends also upon the facility with which they are reduced by the digestive process, and afterwards assimilated. Thus an aliment, abounding in nutritive matter, may be inferior to one which really contains a much smaller proportion, if only a part in the first case, and the whole in the second, be readily taken up by the system.—In the following table, Human Milk is taken as the standard; and the quantity of Nitrogen it contains is expressed by 100. But it must be borne in mind that this substance is intended for the nourishment of a being that passes nearly the whole of its time in a quiescent state; and must not be supposed to be adapted for the sole maintenance of the Human body in a state of activity. In fact, it is inferior in its proportion of Caseine (the substance of which alone the azote forms a part) to the milk of most, if not all, other Mammalia; *their* young bringing their animal functions into exercise at a much earlier period than the Human infant.

Vegetable.

Rice 81	Oats 138	Peas 239
Potatoes 84	White bread 142	Agaricus russula . . . 264
Turnips 106	Wheat 119-144	Lentils 276
Rye 106	Carrots 150	Haricot beans 283
Maize 100-125	Brown Bread 166	Agaricus deliciosus . . 289
Barley 125	Agaricus cantharellus 201	Beans 320

Animal.

Human milk 100	Salmon, raw 776	Flounder, raw 898
Cow's milk 237	——— boiled 610	——— boiled 954
Oyster 305	Liver of Pigeon 742	Pigeon, raw 756
Yolk of eggs 305	Portable soup 764	——— boiled 827
Cheese 331-447	White of Egg 845	Lamb, raw 833
Eel, raw 434	Crab, boiled 859	Mutton, raw 773
——— boiled 428	Skate, raw 859	——— boiled 852
Liver of crab 471	——— boiled 956	Veal, raw 873
Mussel, raw 528	Herring, raw 910	——— boiled 911
——— boiled 660	——— boiled 808	Beef, raw 880
Ox liver, raw 570	——— milt of 924	——— boiled 942
Pork-ham, raw 539	Haddock, raw 920	Ox lung 931
——— boiled 807	——— boiled 816	

648. Besides these substances, there are certain Mineral ingredients, which may be said to constitute part of the food of Animals; being necessary to *their* support, in the same manner as other mineral substances are necessary to the support of Plants. Of this kind are common salt, and also phosphorus, sulphur, and lime, either in combination or separate. The uses of *Salt* are very numerous and important. It consists of two substances of opposite qualities, muriatic acid and soda; and the former is the essential ingredient in the gastric juice; whilst the latter performs a very important part in the production of bile. *Phosphorus* is chiefly required to be united with fatty matter, to serve as the material of the nervous tissue; and to be combined with oxygen and lime, to form the bone-earth, by which the bone is consolidated. *Sulphur* exists in small quantities in several animal tissues; but its part is by no means so important, as that performed by phosphorus. *Lime* is required for the consolidation of the bones; and for the production of the shells and other

* Schlossberger and Kemp, in Philosophical Magazine. Nov. 1845.

hard parts, that form the skeletons of the Invertebrata. To these ingredients we may also add *Iron*, which is a very important element in the red blood of Vertebrated animals.—These substances are contained, more or less abundantly, in most articles generally used as food; and where they are deficient, the animal suffers in consequence, if they are not supplied in any other way. Thus common *Salt* exists, in no inconsiderable quantity, in the flesh and fluids of animals, in milk, and in the egg: it is not so abundant, however, in plants; and the deficiency is usually supplied to herbivorous animals by some other means. Thus salt is purposely mingled with the food of domesticated animals; and in most parts of the world inhabited by wild cattle, there are spots where it exists in the soil, and to which they resort to obtain it. Such are the “buffalo licks” of North America. *Phosphorus* exists also in the yolk and white of the Egg, and in Milk,—the substances on which the young animal subsists during the period of its most rapid growth; and it abounds, not only in many animal substances used as food, but also (in the state of phosphate of lime or bone-earth) in the seeds of many plants, especially the grasses. In smaller quantities it is found in the ashes of almost every plant. When flesh, bread, fruit, and husks of grain, are used as the chief articles of food, more phosphorus is taken into the body than it requires; and the excess has to be carried out in the excretions. *Sulphur* is derived alike from vegetable and animal substances. It exists in flesh, eggs, and milk; also in the azotized compounds of plants; and (in the form of sulphate of lime) in most of the river and spring-water that we drink. *Iron* is found in the yolk of egg, and in milk, as well as in animal flesh; it also exists in small quantities in most vegetable substances used as food by Man,—such as potatoes, cabbage, peas, cucumbers, mustard, &c.; and probably in most articles, from which other animals derive their support. *Lime* is one of the most universally diffused of all mineral bodies; for there are very few animal or vegetable substances, in which it does not exist. It is most commonly taken in, among the higher animals, combined with Phosphoric acid; and in this state it exists largely in the seeds of most grasses, especially in wheat flour. If it were not for their deficiency in Phosphate of lime, some of the Leguminous seeds would be more nutritious than wheaten flour; the proportion of azotized matter they contain being greater. A considerable quantity of lime exists, in the state of carbonate and sulphate, in all hard water.

649. The *absolute quantity* of food, required for the maintenance of the Human body in health, varies so much with the age, sex, and constitution of the individual, and with the circumstances in which he may be placed, that it would be absurd to attempt to fix any standard which should apply to every particular case. The appetite is the only sure guide for the supply of the wants of each; but its indications must not be misinterpreted. To eat when we are hungry, is an evidently natural disposition; but to eat as long as we are hungry, may not always be prudent. Since the feeling of hunger does not depend so much upon the state of fulness or emptiness of the stomach, as upon the condition of the general system, it appears evident that the ingestion of food cannot *at once* produce the effect of dissipating it, though it will do so after a short time; so that, if we eat with undue rapidity, we may continue swallowing food long after we have taken as much as will really be required for the wants of the system; and every superfluous particle is not merely useless, but injurious. Hence, besides its other important ends, the process of thorough mastication is important, as prolonging the meal, and giving time to the system to become acquainted (as it were) that the supply of its wants is in progress; so that its demand may be abated in due time to prevent the ingestion of more than is required. It is very justly remarked by Dr. Beaumont, that the cessation of this demand, rather than the positive

sense of satiety, is the proper guide. "There appears to be a sense of perfect intelligence conveyed to the encephalic centre, which, in health, invariably dictates what quantity of aliment (responding to the sense of hunger and its due satisfaction) is naturally required for the purposes of life; and which, if noticed and properly attended to, would prove the most salutary monitor of health, and effectual preventive of disease. It is not the sense of satiety, for this is beyond the point of healthful indulgence, and is Nature's earliest indication of an abuse and overburden of her powers to replenish the system. It occurs immediately previous to this; and may be known by the pleasurable sensations of perfect satisfaction, ease and quiescence of body and mind. It is when the stomach says, *enough*; and it is distinguished from satiety by the difference of sensations,—the latter saying *too much*." Every medical man is well aware how generally this rule is transgressed; some persons making a regular practice of eating to repletion; and others paying far too little attention to the preliminary operations, and thus ingesting more than is good for them, even though they may actually leave off with an appetite.

650. Although no universal law can be laid down for individuals, however, it is a matter of much practical importance to be able to form a correct *average* estimate. It is from the experience afforded by the usual consumption of food by large bodies of men, that our data are obtained; and these data are sufficient to enable us to predict with tolerable accuracy what will be required by similar aggregations, though they can afford no guide to the consumption of individuals.—We shall first consider the quantity sufficient for men in regular active exercise; and then inquire how far that may be safely reduced for those who lead a more sedentary life.—The Diet-scale of the British Navy may be advantageously taken as a specimen of what is required for the first class. It is well known that an extraordinary improvement has taken place in the health of seamen during the last 80 years; so that three ships can now be kept afloat with only the same number of men, which were formerly required for two. This is due to the improvement in the quality of the food, in combination with other prophylactic means. At present it may safely be affirmed, that it would not be easy to conceive of any diet-scale more adapted to answer the required purpose. The health of crews that have been long afloat, and have been exposed to every variety of external conditions, appears to be preserved (at least when they are under the direction of judicious officers), to the full as well as that of persons subject to similar vicissitudes on shore; and there can be no complaint of insufficiency of food, although the allowance cannot be regarded as superfluous. It consists of from 31 to 35½ ounces of *dry* nutritious matter daily; of this 26 oz. are vegetable; and the rest animal; 9 oz. of salt meat, or 4½ oz. fresh, being the allowance of the latter. This is found to be amply sufficient for the support of strength; and considerable variety is produced, by exchanging various parts of the diet for other articles. This, however, is sometimes done erroneously; thus 8 oz. of fresh vegetables, which contain only 1½ oz. of solid nutriment, are exchanged for 12 oz. of flour, which is almost all nutritious. Sugar and Cocoa are also allowed; partly in exchange for a portion of the Spirits formerly served out, the diminution of which, especially in the case of boys, has been attended with great benefit.

651. A considerable reduction in this amount is of course admissible, where little bodily exertion is required, and where there is less exposure to low temperatures. In the case of Prisoners, the diet should of course be as spare as possible, consistently with health; but it should be carefully modified, in individual cases, according to several collateral circumstances, such as depression of mind, compulsory labour, previous intemperate habits, and especially the length of confinement. It has been supposed by some, that

prisoners require a fuller diet than persons at large; this is probably erroneous; but more variety is certainly desirable, to counteract, as far as possible, the depressing influence of their condition upon the digestive powers. The circumstances which occurred at the Milbank Penitentiary in 1823, form a lamentable warning against the reduction of the diet-scale to an insufficient amount. The allowance to the prisoners had formerly been from 31 to 33 oz. of dry nutriment daily, and the prison was considered healthy; but in 1822, it was reduced to 21 oz. The health of the prisoners continued unbroken for nearly six months; but scurvy then showed itself unequivocally, and out of 860 prisoners, 437, or 52 per cent., were affected with it. The effect of previous confinement here became remarkable; for those were chiefly attacked, who had been in the prison for two years, a year, or six months. Again, the prisoners employed in the kitchen, who had 8 oz. of bread additional per day, were not attacked, except three who had only been there a few days. After the epidemic had spread to a great extent, it was found that the addition of 8 oz. to the daily allowance of vegetable food, and $\frac{1}{2}$ oz. to the animal, facilitated the operation of the remedies which were used for the restoration of the health of the prisoners.—The effects of confinement have been further shown in the experience of the Edinburgh House of Refuge, which was first established in 1832, for the reception of beggars during the cholera, and which has been continued to the present time. The diet was at first a quart of oatmeal porridge for each person, morning and evening; and at dinner 1 oz. of meat, in broth, with 7 oz. of bread; making altogether about 23 oz. of solid food a day. During some months, this diet seemed to answer very well; the people went out fatter than they came in, owing to the diet being better than that to which they had been accustomed; but afterwards a proneness to disease manifested itself in those who had been residents there for a considerable time, and the diet was therefore somewhat increased, with good effect. The quantity of animal food was probably here too small; and the total weight might still have been sufficient, if it had been differently apportioned.—In a Convict-ship, which took out 433 prisoners to New Holland in 1802, the mortality was very trifling, and the general health good; although these prisoners were supported on 16 oz. of vegetable food, and $7\frac{1}{2}$ oz. of animal food per day; a quantity which was found to be perfectly sufficient for them.—The aged inmates of work-houses, especially those who have been accustomed to poor food during their whole lives, require much less than this; their vital functions being comparatively inactive, and their amount of labour or exercise small. In the Edinburgh work-house, of which the inmates usually have good health, they are fed upon oatmeal-porridge morning and evening, with barley-broth at dinner; the total allowance of dry nutriment is about 17 oz.; namely 13 oz. vegetable, and 4 oz. animal.

652. It is a curious effect of insufficient nutriment, as shown by the recent inquiries of Chossat,* that it produces an incapability of digesting even the limited amount supplied. He found that, when turtle-doves were supplied with limited quantities of corn, but with water at discretion, the whole amount of food taken was scarcely ever actually digested; a part of it being rejected by vomiting, or passing off by diarrhoea, or accumulating in the crops. It seems as if the vital powers were not sufficient to furnish the requisite supply of gastric fluid, when the body began to be enfeebled by insufficient nutrition; or perhaps we might well say, the materials of the gastric fluid were wanting. Hence the loathing of food, which is often manifested by those who have been subjected to the influence of an insufficient diet-scale in our prisons and

* *Récherches Expérimentales sur l'Inanition*, 1843.

poor-houses, and which has been set down to caprice or obstinacy, and punished accordingly, may be actually a proof of the deficiency of the supply which we might expect to have been voraciously devoured, if really less than the wants of the system require.

653. The smallest quantity of food upon which life is known to have been supported with vigour, during a prolonged period, is that on which Cornaro states himself to have subsisted. This was no more than 12 oz. a day, chiefly of vegetable matter, for a period of 58 years. There is only one instance on record, in which his plan was followed; and there are probably few who could long persevere in it, at least among those whose avocations require much mental or bodily exertion. It is certain, however, that life with a moderate amount of vigour may be preserved for some time, with a very limited amount of food; this appears from the records of shipwreck and similar disasters. In regard, however, to those who have been stated to fast for a period of months or even years, taking no nutriment, but maintaining an active condition, it may be safely asserted that they were impostors,—probably possessing unusual powers of abstinence, which they took care to magnify. The instances in which the life of Man, or of other Mammalia, has been prolonged to the greatest extent without water, are those in which, from the peculiarity of the circumstances, the cutaneous exhalation must have been reduced to a very small amount, or in which there may have been an actual absorption of water by the skin and lungs. Thus, Fodéré mentions that some workmen were extricated alive, after fourteen days' confinement in a cold damp cavern, in which they had been buried under a ruin. And there is a well-known case of a Hog, which was buried in its sty for 160 days, under thirty feet of the chalk of Dover cliff, and was dug out alive at the end of that time, reduced in weight from 160 lbs. to 40 lbs.: here the temperature would be kept up by the non-conducting power of the chalk around; and the air surrounding the animal would soon become sufficiently charged with fluid, to resist further evaporation. The time during which life can be supported under total abstinence, is usually stated to vary from 8 to 10 days: the period may be greatly prolonged, however, by the occasional use of water, and still more by a very small supply of food. In a case recorded by Dr. Willan, of a young gentleman who starved himself, under the influence of a religious delusion, life was prolonged for 60 days; during the whole of which time nothing else was taken than a little orange-juice. In a somewhat similar case which occurred under the Author's notice, in the person of a young French lady, more than 15 days elapsed between the time that she ceased to eat regularly, and the time of her being compelled to take nourishment; during this period she took a great deal of exercise, and her strength seemed to suffer but little, although she swallowed solid food only once, and then in small quantity. If the cessation of muscular exertion be complete, it seems that life is usually more prolonged than where exercise of any kind is performed; and this is what might naturally be expected.—In certain states of the system commonly known as *Hysterical*, there is frequently a very remarkable disposition for abstinence, and power of sustaining it. In a case of this kind which occurred under the Author's own notice, a young lady, who had suffered severely from the tetanic form of *Hysteria*, was unable to take food for three weeks. The slightest attempt to introduce a morsel of solid matter into the stomach, occasioned very severe vomiting and retching; and the only nourishment taken during the period mentioned, was a cup of tea once or twice a day,—on many days not even this being swallowed. Yet the strength of the patient rather increased than diminished, during this period; her muscles became firmer, and her voice more powerful.—It may be well to remark that, under such circumstances, the continual persuasions of anxious friends are very injurious

to the patient; whose return to her usual state will probably take place the earlier, the more completely she is left to herself.

654. Of the quantity which *can* be devoured at a time, it is scarcely the place to speak; since such feats of gluttony only demonstrate the extraordinary capacity, which the stomach may be made to attain by continual practice. Many amusing instances are related by Captain Parry in his Arctic Voyages; in one case, a young Esquimaux, to whom he had given (for the sake of curiosity) his full tether, devoured in four-and-twenty hours, no less than 35lbs. of various kinds of aliment, including tallow candles. A case has recently been published of a Hindoo, who can eat a whole sheep at a time; this probably surpasses any other instance on record. The half-breed *voyageurs* of Canada, according to Captain Franklin, and the wandering Cossacks of Siberia, as testified by Capt. Cochrane, habitually devour a quantity of animal food, which would be soon fatal to any one unused to it. The former are spoken of as very discontented, when put on a short allowance of 8lbs. of meat a day; their usual consumption being from 12 to 20lbs.—That a much larger quantity of food than that formerly specified, may be taken, with perfect freedom from injurious consequences, under a particular system of exercise, &c., appears from the experience of those who are *trained* for feats of strength, pugilistic encounters, &c. The ordinary belief, that the Athletic constitution cannot be long maintained, appears to have no real foundation; nor does it appear that any ultimate injury results from the system being persevered in for some time. That trained men often fall into bad health, on the cessation of the plan, is probably owing in part to the intemperance and other bad habits of persons of the class usually subjected to this discipline. The effects of trainers' regimen are hardness and firmness of the muscles, clearness of the skin, capability of bearing continued severe exercise, and a feeling of freedom and lightness (or "corkiness") in the limbs. During the continuance of the system, it is found that the body recovers with wonderful facility from the effects of injuries; wounds heal very rapidly; cutaneous eruptions usually disappear. Clearness and vigour of mind, also, are stated to be results of this plan; and it is probable that, where persevering attention and intense application are necessary, a modification of this system, in which due allowance should be made for the diminished quantity of exercise, would be found advantageous.*

3.—Of the Passage of Food along the Alimentary Canal.

655. The introduction of alimentary matter into the system, is accomplished in Animals by the reception of the food into an internal cavity, where it is subjected to a preparatory process, to which nothing analogous exists in Plants, and which is termed Digestion. This process may be said to have three different purposes in view;—the reduction of the alimentary matter to a fluid form, so that it may become capable of absorption;—the separation of that

* The method of training employed by Jackson (a celebrated trainer of prize-fighters in modern times), as deduced from his answers to questions put to him by John Bell, was to begin on a clear foundation, by an emetic and two or three purges. Beef and mutton, the lean of fat meat being preferred, constituted the principal food; veal, lamb, and pork were said to be less digestible ("the last purges some men"). Fish was said to be a "watery kind of diet:" and is employed by jockeys who wish to reduce weight by sweating. Stale bread was the only vegetable food allowed. The quantity of fluid permitted was $3\frac{1}{2}$ pints *per diem*; but fermented liquors were strictly forbidden. Two full meals, with a light supper, were usually taken. The quantity of exercise employed was very considerable, and such as few men of ordinary strength could endure. This account corresponds very much with that which Hunter gave of the North American Indians, when about to set out on a long march.

portion of it which is fit to be assimilated or converted into organized texture, from that which cannot serve this purpose, and which is at once rejected;— and the alteration (when required) of the chemical constitution of the former,

[Fig. 199.]

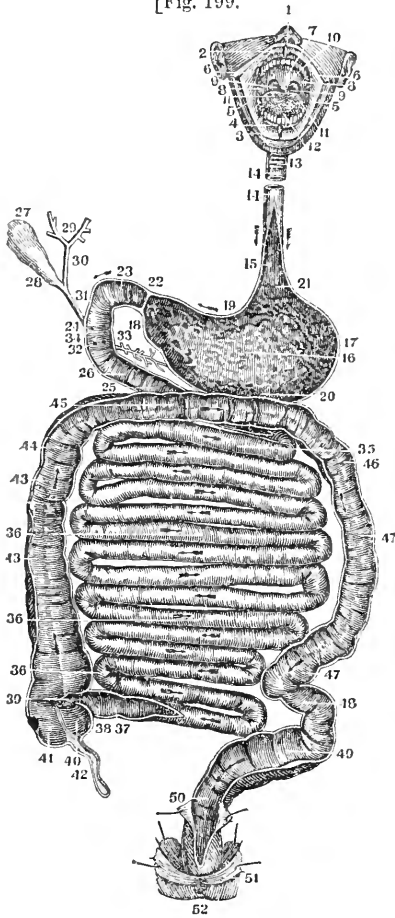

A view of the *Organs of Digestion*, opened in nearly their whole length; a portion of the œsophagus has been removed on account of want of space in the figure; the arrows indicate the course of substances along the canal; 1. the upper lip, turned off the mouth; 2. its frænum; 3. the lower lip, turned down; 4. its frænum; 5. 5. inside of the cheeks, covered by the lining membrane of the mouth; 6. points to the opening of the duct of Steno; 7. roof of the mouth; 8. lateral half arches; 9. points to the tonsils; 10. velum pendulum palati; 11. surface of the tongue; 12. papillæ near its point; 13. a portion of the trachea; 14. the œsophagus; 15. its internal surface; 16. inside of the stomach; 17. its greater extremity or great cul-de-sac; 18. its lesser extremity or smaller cul-de-sac; 19. its lesser curvature; 20. its greater curvature; 21. the cardiac orifice; 22. the pyloric orifice; 23. upper portion of duodenum; 24, 25. the remainder of the duodenum; 26. its valvulæ conniventes; 27. the gall bladder; 28. the cystic duct; 29. division of hepatic ducts in the liver; 30. hepatic duct; 31. ductus communis choledochus; 32. its opening into the duodenum; 33. ductus Wirsungii, or pancreatic duct; 34. its opening into the duodenum; 35. upper part of jejunum; 36. the ileum; 37. some of the valvulæ conniventes; 38. lower extremity of the ileum; 39. ileo-colic valve; 40, 41. cœcum, or caput coli; 42. appendicula vermiformis; 43, 44. ascending colon; 45. transverse colon; 46, 47. descending colon; 48. sigmoid flexure of the colon; 49. upper portion of the rectum; 50. its lower extremity; 51. portion of the levator-ani muscle; 52. the anus.]

which prepares it for the important changes it is subsequently to undergo. The simplest conditions requisite for the accomplishment of these purposes are the following:—a fluid capable of performing the solution and of effecting the required chemical changes;—a fluid capable of separating the unorganizable matter, by a process analogous to chemical precipitation;—and a cavity or sac, in which these operations may be performed. In the lowest Animals, we find this cavity formed on a very simple plan; being evidently nothing else than an inversion of the external integument, communicating with the exterior by one orifice only, through which the food is drawn in and the excrementitious matter rejected. The fluid necessary to dissolve the food, which is known by the name of *gastric fluid* or juice, and that required to separate the portion which is to be thrown off, which is known as the *bile*, are secreted in the walls of the stomach. In the Sea-Anemone, which affords a very characteristic example of this type of structure, it cannot be ascertained that the very rapid solution of food, which takes place in the digestive cavity, is assisted by any movement of its walls. In Polypes of a higher conformation, however, the digestive cavity is provided with a second orifice; the stomach opens into an intestinal tube, through which the excrement is rejected in little pellets; and the food, before entering the true digestive cavity, is submitted to a powerful gizzard or trituration apparatus. Still, the bile, like the gastric juice, is secreted in the walls of the stomach; as may be distinctly perceived in many of these animals, on account of their transparency, and the bright yellow colour of the fluid. As we ascend the animal series, we find no essential change in the character of the digestive apparatus. The biliary follicles are gradually collected into a glandular mass, which is altogether removed from the walls of the stomach, and which pours its secretion into the intestinal tube, at a short distance from its commencement; the gastric juice, however, is still secreted in minute sacs imbedded in the substance of the membrane. Several accessory glands are added, the uses of which are not accurately known; and particular modifications of the apparatus are adapted to peculiarities in the nature of the food, or in the mode of its ingestion. As a general rule it may be stated, that the digestive apparatus is most simple in Carnivorous animals, in which it has to effect little change upon the aliment except solution, in order to bring it to the state fit for absorption; whilst it is most complex in those that feed upon Vegetable matter, which needs to undergo a greater change, both in its chemical composition and in the mechanical arrangement of its components, before it can be rendered subservient to animal nutrition.

656. *Mastication and Deglutition.*—The first step in the process of reduction, is the Mastication of the food, and the impregnation of its comminuted particles with the Salivary secretion. Mastication is evidently of great importance, in preparing the substances to be afterwards operated on, for the action of their solvent; and it exactly corresponds with the trituration to which the Chemist would submit any solid matter, that he might present it in the most advantageous form to a digestive menstruum. The complete disintegration of the alimentary matter, therefore, is of great consequence; and, if imperfectly effected, the subsequent processes are liable to derangement. This derangement we continually meet with: for there is not, perhaps, a more frequent source of Dyspepsia than imperfect mastication, whether resulting from the haste with which the food is swallowed, or from the want of the proper instruments. The disintegration of the food by mechanical reduction, is manifestly aided by Insalivation: and the admixture of Saliva appears further to have the effect of commencing the transformation of the amylaceous or starchy particles into sugar. From recent experiments it would seem that Saliva, if acidulated, possesses the same power of acting on azotized compounds, as that which characterizes the gastric juice; and consequently, when introduced into

the stomach, the Saliva may afford important aid in the digestive process. (Sec §§ 668 and 863.) When the reduction of the food in the mouth has been sufficiently accomplished, it is carried into the œsophagus by the action of Deglutition. The share which the nervous system has in this action has been already stated (§ 382); and it here only remains to define more precisely the different movements which are concerned in it. These were first described in detail by Magendie; but his account requires some modification, through the more recent observations of Dzondi.* The *first* stage in the process is the carrying back of the food, until it has passed the anterior palatine arch; this, which is effected by the approximation of the tongue and the

[Fig. 200.

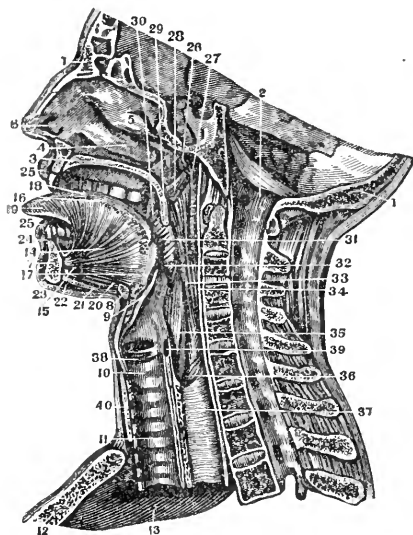

A view of the Muscles of the Tongue, Palate, Larynx and Pharynx—as well as the position of the upper portion of the (Esophagus, as shown by a vertical section of the head; 1. 1. the vertical section of the head; 2. points to the spinal canal; 3. section of the hard palate; 4. inferior spongy bone; 5. middle spongy bone; 6. orifice of the right nostril; 7. section of the inferior maxilla; 8. section of the os hyoideus; 9. section of the epiglottis; 10. section of the cricoid cartilage; 11. the trachea, covered by its lining membrane; 12. section of sternum; 13. inside of the upper portion of the thorax; 14. genio-hyo-glossus muscle; 15. its origin; 16, 17, the fan-like expansion of the fibres of this muscle; 18. superficialis linguæ muscle; 19. verticales linguæ muscle; 20. genio-hyoideus muscle; 21. mylo-hyoideus muscle; 22. anterior belly of digastricus; 23. section of platysma myoides; 24. levator menti; 25. orbicularis oris; 26. orifice of Eustachian tube; 27. levator palati; 28. internal pterygoid; 29. section of velum pendulum palati, and azygos uvulæ muscle; 30. stylo-pharyngeus; 31. constrictor pharyngis superior; 32. constrictor pharyngis medius; 33. insertion stylo-pharyngeus; 34. constrictor pharyngis inferior; 35. 36. 37. muscular coat of œsophagus; 38. thyreo-arytenoid muscle and ligaments, and above is the ventricle of Galen; 39. section of arytenoid cartilage; 40. border of sterno-hyoideus.]

palate, is a purely voluntary movement. In the *second* stage, the tongue is carried still further backwards, and the larynx is drawn forwards under its root, so that the epiglottis is depressed down over the rima glottidis. The muscles of the anterior palatine arch contract after the morsel has passed it, and assist its passage backwards; these, with the tongue, cut off completely the communication between the fauces and the mouth. At the same time, the muscles of the posterior palatine arch contract in such a manner, as to cause

* Müller's Physiology, p. 501.

the sides of the arch to approach each other like a pair of curtains; so that the passage from the fauces into the posterior nares is nearly closed by them; and to the cleft between the approximated sides, the uvula is applied like a valve. A sort of inclined plane, directed obliquely downwards and backwards, is thus formed; and the morsel slides along it into the pharynx, which is brought up to receive it. Some of these acts may be performed voluntarily; but the combination of the whole is automatic. The *third* stage of the process,—the propulsion of the food down the œsophagus,—then commences. This is accomplished in the upper part by means of the constrictors of the pharynx; and in the lower by the muscular coat of the œsophagus itself. When the morsels are small, and are mixed with much fluid, the undulating movements from above downwards succeed each other very rapidly; this may be well observed in Horses whilst drinking; large morsels, however, are frequently some time in making their way down. Each portion of food and drink is included in the contractile walls, which are closely applied to it during the whole of its transit. The gurgling sound, which is observed when drink is poured down the throat of a person in *articulo mortis*, is due to the want of this contraction. The whole of the third stage is completely involuntary. At the point where the œsophagus enters the stomach,—the cardiac orifice of the latter,—there is a sort of sphincter, which is usually closed. This opens when there is a sufficient pressure on it, made by accumulated food; and afterwards closes, so as to retain the food in the stomach. The opening of the cardiac is one of the first acts which takes place in vomiting. When the sphincter is paralyzed by division of the pneumogastric nerve, the food regurgitates into the œsophagus.

657. *Action of the Stomach.*—A remarkable opportunity of ascertaining the condition of the Stomach during Digestion, presented itself, some time since, in a case in which a large fistulous aperture remained after a wound that laid open the cavity, but in which the general health was completely recovered; so that the process may be considered as having been normally performed.* “The inner coat of the stomach, in its natural and healthy state, is of a light or pale pink colour, varying in its hues, according to its full or empty state. It is of a soft or velvet-like appearance, and is constantly covered with a very thin, transparent, viscid mucus, lining the whole interior of the organ. By applying aliment or other irritants, to the internal coat of the stomach, and observing the effect through a magnifying glass, innumerable lucid points, and very fine nervous or vascular papillæ, can be seen arising from the villous membrane, and protruding through the mucous coat, from which distils a pure, limpid, colourless, slightly viscid fluid. The fluid thus excited is invariably distinctly acid. The mucus of the stomach is less fluid, more viscid or albuminous, semi-opaque, sometimes a little saltish, and does not possess the slightest character of acidity. The gastric fluid never appears to be accumulated in the cavity of the stomach while fasting; and is seldom, if ever, discharged from its proper secreting vessels, except when excited by the natural stimulus of aliment, mechanical irritation of tubes, or other excitants. When aliment is received, the juice is given out in exact proportion to its requirements for solution, except when more food has been taken than is necessary for the wants of the system.” That the quantity of the Gastric Juice secreted from

* See the case of Alexis St. Martin, with the observations and experiments of Dr. Beaumont, republished in this country by Dr. A. Combe. [A very extended examination of the phenomena of gastric digestion has been made by M. Blondlot. The chief subject of experiment was a dog, in which he maintained, without affecting the health, a fistulous opening into the stomach for more than two years. His examinations have furnished many new and important facts, and have confirmed those of Dr. Beaumont made on Alexis St. Martin in nearly every point.—*Traité Analytique de la Digestion*, Paris, 1844.—M. C.]

the walls of the stomach depends rather upon the general requirements of the system, than upon the quantity of food introduced into the digestive cavity, is a principle of the highest practical importance, and cannot be too steadily kept in view in Dietetics. A *definite proportion* only of aliment can be perfectly digested in a given quantity of the fluid; the action of which, like that of other chemical operations, ceases after having been exercised on a fixed and definite amount of matter. "When the juice has become saturated, it refuses to dissolve more; and, if an excess of food has been taken, the residue remains in the stomach, or passes into the bowels in a crude state, and becomes a source of nervous irritation, pain, and disease, for a long time." The unfavourable effect of an undue burthen of food upon the stomach itself, interferes with its healthy action; and thus the quantity really appropriate is not dissolved. The febrile disturbance is thus increased; and the mucous membrane of the stomach exhibits evident indications of its morbid condition. The description of these indications, given by Dr. Beaumont, is peculiarly graphic, as well as Hygienically important.

658. "In disease, or partial derangement of the healthy function, the mucous membrane presents various and essentially-different appearances. In febrile conditions of the system, occasioned by whatever cause,—obstructed perspiration, undue excitement by stimulating liquors, overloading the stomach with food; fear, anger, or whatever depresses or disturbs the nervous system,—the villous coat becomes sometimes red and dry, at other times pale and moist, and loses its smooth and healthy appearance; the secretions become vitiated, greatly diminished, or even suppressed; the coat of mucus scarcely perceptible, the follicles flat and flaccid, with secretions insufficient to prevent the papillæ from irritation. There are sometimes found, on the internal coat of the stomach, eruptions of deep-red pimples, not numerous, but distributed here and there upon the villous membrane, rising above the surface of the mucous coat. These are at first sharp-pointed, and red, but frequently become filled with white purulent matter. At other times, irregular, circumscribed red patches, varying in size and extent from half an inch to an inch and a half in circumference, are found on the internal coat. These appear to be the effects of congestion in the minute blood-vessels of the stomach. There are also seen at times small aphthous crusts, in connection with these red patches. Abrasion of the lining membrane, like the rolling up of the mucous coat into small shreds or strings, leaving the papillæ bare for an indefinite space, is not an uncommon appearance. These diseased appearances, when very slight, do not always affect essentially the gastric apparatus. When considerable, and particularly when there are corresponding symptoms of disease,—as dryness of the mouth, thirst, accelerated pulse, &c.—*no gastric juice can be extracted by the alimentary stimulus.* Drinks are immediately absorbed or otherwise disposed of; but food taken in this condition of the stomach remains undigested for twenty-four or forty-eight hours, or more, increasing the derangement of the alimentary canal, and aggravating the general symptoms of disease. After excessive eating or drinking, chymification is retarded; and, though the appetite be not always impaired at first, the fluids become acrid and sharp, excoriating the edges of the aperture, and almost invariably producing aphthous patches and the other indications of a diseased state of the internal membrane. Vitiated bile is also found in the stomach under these circumstances, and flocculi of mucus are more abundant than in health. Whenever this morbid condition of the stomach occurs, with the usual accompanying symptoms of disease, there is generally a corresponding appearance of the tongue. When a healthy state of the stomach is restored, the tongue invariably becomes clean."

a. Dr. A. Combe's commentary on the above passage is too apposite to be omitted. "Many persons who obviously live too freely, protest against the fact, because they feel no immediate inconvenience, either from the quantity of food, or the stimulants in which they habitually indulge; or, in other words, because they experience no pain, sickness, or headache,—nothing, perhaps, except slight fulness and oppression, which soon go off. Observation extended over a sufficient length of time, however, shows that the conclusion drawn is entirely fallacious, and that the real amount of injury is not felt at the moment, merely because, for a wise purpose, nature has deprived us of any consciousness of either the existence or the state of the stomach during health. In accordance with this, Dr. Beaumont's experiments prove, that extensive erythematic inflammation of the mucous coat of the stomach was of frequent occurrence in St. Martin after excesses in eating, and especially in drinking, even when no marked general symptom was present to indicate its existence. Occasionally, febrile heat, nausea, headache, and thirst were complained of, but not always. Had St. Martin's stomach, and its inflamed patches, not been visible to the eye, he too might have been pleased that his temporary excesses did him no harm; but, when they presented themselves in such legible characters, that Dr. Beaumont could not miss seeing them, argument and supposition were at an end, and the broad fact could not be denied."

b. The observations of Dr. Beaumont have been confirmed by those of M. Blondlot (*Traité Analytique de la Digestion*), and of M. Ch. Bernard (*Archiv. d'Anat. Gén. et de Physiol.*, Jan. 1846); which were made upon Dogs, in whose stomachs fistulous openings were maintained for a length of time.—They found that, although a slight mechanical irritation, applied directly to the mucous surface of the stomach, excites at once an abundant flow of gastric fluid, yet if this irritation be carried beyond certain limits, so as to produce pain, the secretion, instead of being more abundant, diminishes or ceases entirely; whilst aropy mucus is poured out instead, and the movements of the stomach are considerably increased. The animal at the same time appears ill at ease, is agitated, has nausea, and, if the irritation be continued, actual vomiting; and bile has been observed to flow into the stomach, and escape by the fistulous opening. Similar disorders of the functions of the stomach result from violent pain in other parts of the body; the process of digestion in such cases being suspended, and sometimes vomiting excited. When acidulated substances, as food rendered acid by the addition of a little vinegar, were introduced into the stomach, the quantity of gastric fluid poured out was much smaller, and the digestive process consequently slower, than when similar food, rendered alkaline by a weak solution of carbonate of soda, was introduced. If, however, instead of a weak solution, carbonate of soda, in crystal or in powder, was introduced into the stomach, a large quantity of mucus and bile, instead of gastric fluid, flowed into the stomach; and vomiting and purging very often followed. When very cold water, or small pieces of ice, were introduced into the stomach, the mucous membrane was at first rendered very pallid; but soon a kind of reaction followed, the membrane became turbid with blood, and a large quantity of gastric fluid was secreted. If, however, too much ice was employed, the animal appeared ill, and shivered; and digestion, instead of being rendered more active, was retarded. Moderate heat, applied to the mucous surface of the stomach, appeared to have no particular action on digestion; but a high degree of heat produced most serious consequences. Thus, the introduction of a little boiling water threw the animal at once into a kind of adynamic state, which was followed by death in three or four hours; the mucous membrane of the stomach was found red and swollen, whilst an abundant exudation of blackish blood had taken place into the cavity of the organ. Similar injurious effects resulted in a greater or less degree, from the introduction of other irritants, such as nitrate of silver or ammonia; the digestive functions being at once abolished, and the mucous surface of the organ rendered highly sensitive.

659. The food which is propelled along the œsophagus, enters the Stomach through its cardiac orifice, in successive waves; and it is immediately subjected to a peculiar peristaltic movement, which has for its object to produce the thorough intermixture of the gastric fluid with the alimentary mass, and also to aid the solution of the latter by the gentle trituration to which it is thus subjected. The fasciuli composing the muscular wall of the human stomach, are so disposed as to shorten its diameter in every direction; and by the alternate contraction and relaxation of these bands, a great variety of motion is induced in this organ, sometimes transversely, and at other times longitudinally. "These motions," Dr. Beaumont remarks, "not only produce a constant disturbance or *churning* of the contents of the stomach, but they compel them, at the same time, to revolve about the interior from point to point, and from one extremity to the other." In addition to these movements, there is

[Fig. 201.

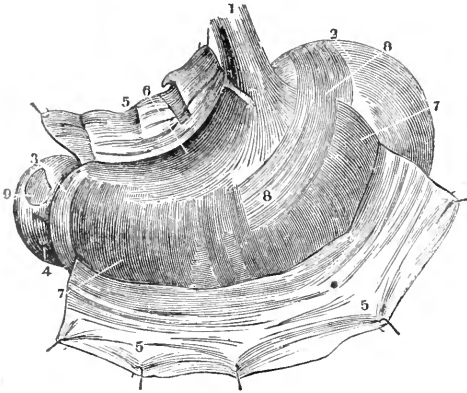

A front view of the Stomach, distended by flatus, with the Peritoneal Coat turned off; 1. anterior face of the œsophagus; 2. the cul-de-sac, or greater extremity; 3. the lesser or pyloric extremity; 4. the duodenum; 5, 5. a portion of the peritoneal coat turned back; 6. a portion of the longitudinal fibres of the muscular coat; 7. the circular fibres of the muscular coat; 8. the oblique muscular fibres, or muscle of Gavaré; 9. a portion of the muscular coat of the duodenum, where its peritoneal coat has been removed.]

[Fig. 202.

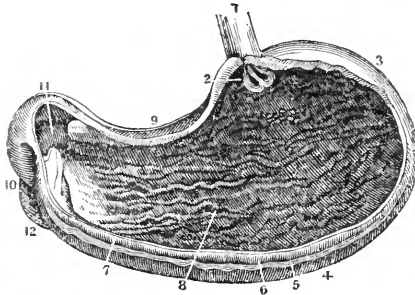

A view of the interior of the Stomach, as given by the removal of its anterior parietes; 1. œsophagus; 2. cardiac orifice of the stomach; 3. its greater extremity, or cul-de-sac; 4. the greater curvature; 5. line of the attachment of the omentum majus; 6. the muscular coat; 7. the anterior cut edge of the mucous coat; 8. the rugæ of the mucous coat; 9. the lesser curvature; 10. the beginning of the duodenum; 11. pyloric orifice, or valve; 12. the first turn of the duodenum downwards.]

a constant agitation of the stomach, produced by the respiratory muscles. The motions of the stomach itself are not performed on any very exact plan, and are much influenced by the character of the ingesta, the state of the general system, and by other circumstances. The following is the ordinary course, however, of the revolutions of the food. "After passing the œsophageal ring, it moves from right to left, along the small arch; thence, through the large curvature, from left to right. The bolus, as it enters the cardia, turns to the left, passes the aperture,* descends into the splenic extremity, and follows the great curvature towards the pyloric end. It then returns, in the course of the smaller curvature, makes its appearance again at the aperture in its descent

* The fistulous orifice in St. Martin's stomach, through which these observations were made.

[Fig. 203.

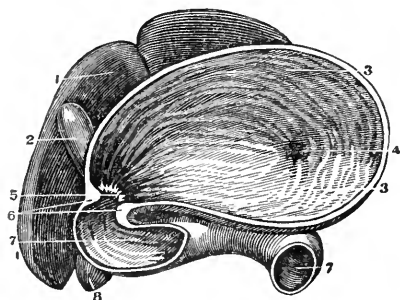

A view of the interior of the Stomach and Duodenum in situ, the inferior portion of each having been removed; 1, 1, the under side of the liver; 2, the gall bladder; 3, 3, the lesser curvature and anterior faces, as seen from below; 4, the rugæ, about the cardiac orifice; 5, the pyloric orifice; 6, the rugæ, and thickness of this orifice; 7, 7, the duodenum; 8, lower end of the right kidney.]

into the great curvature, to perform similar revolutions. These revolutions are completed in from one to three minutes. They are probably induced in a great measure, by the circular or transverse muscles of the stomach. They are slower at first, than after chymification has considerably advanced;” at which time also there is an increased impulse towards the pylorus. It is probable that, from the very commencement of chymification, until the organ becomes empty, portions of chyme are continually passing into the duodenum; for the bulk of the alimentary mass progressively diminishes, and this the more rapidly as the process is nearer its completion. The accelerated expulsion appears to be effected by a peculiar action of the transverse muscles; and especially of that portion of them which surrounds the stomach at about four inches from its pyloric extremity. This band is so forcibly contracted in the latter part of the digestive process, that it almost separates the two portions of the stomach, into a sort of hour-glass form; and Dr. B. states that, when he attempted to introduce a long thermometer tube into the pyloric portion of the stomach, the bulb was at first gently resisted, then allowed to pass, and then grasped by the muscular parietes beyond, so as to be drawn in: whence it is evident that the contraction has for its object, to resist the passage of solid bodies into the pyloric extremity of the stomach, at this stage of digestion; whilst the matter which has been reduced to the fluid form is pumped away (as it were) by the action of that portion of the viscus. These peculiar motions continue, until the stomach is perfectly empty, and not a particle of food or chyme remains. Of the degree in which they are dependent upon the influence of the Nervous System, some idea has been already given (§ 387); there is yet much to be learned, however, especially in regard to the degree in which the movements may be checked or altered, by impressions transmitted through the nervous system. It is stated by Brachet that, in some of his experiments upon the Par Vagus some hours after section of the nerve on both sides, the surface only of the alimentary mass was found to have undergone solution, the remainder of the mass remaining in the condition in which it was at first ingested; and if this statement can be relied on, it would appear that the movements of the stomach, like those of the heart, can be readily affected by a strong nervous impression. It may be partly in this manner, therefore, and not by acting upon the secretions alone, that strong Emotions influence the digestive process, as they are well known to do. On the other hand, the moderate excitement of pleasurable emotions may be fa-

avourable to the operation; not only by giving firmness and regularity to the action of the heart, and thence promoting the circulation of the blood, and the increase of the gastric secretion; but also in imparting firmness and regularity to the muscular contractions of the stomach.

660. *Action of the Intestinal Tube.*—The pulpy substance to which the aliment is reduced, by the mechanical reduction and chemical solution it has undergone in the mouth and stomach, is termed *chyme*. The consistence of this will of course vary in some degree with the quantity of fluid ingested; in general it is greyish, semifluid, and homogeneous; and possesses a slightly acid taste, but is otherwise insipid. Dr. Beaumont describes it as varying in its aspect,—from that of cream, which it presents when the food has been of a rich character,—to that of gruel, which it possesses when the diet has been farinaceous. The passage of the chyme through the pyloric orifice is at first slow; but when the digestive process is nearly completed, it is transmitted in much larger quantities. From the time that the ingested matter enters the intestinal canal, it is propelled by the simple peristaltic action of its muscular coat, which is directly excited by the contact either of this matter, or of the secretions which are mingled with it;* and all that is not absorbed is thus conducted to the rectum, its expulsion from which is due to an action of a distinctly reflex kind, excited through the nervous centres (§ 391). During its progress through the intestinal tube, the product of the gastric operation undergoes very important changes. The chyme is mingled in the duodenum with the biliary and pancreatic secretions, which effect an immediate alteration both in its sensible and chemical properties. The nature of this alteration can be best estimated, by mingling bile with chyme removed from the body. This has been done by several experimenters on the lower animals; and by Dr. Beaumont in the case already referred to, which afforded him the means of obtaining not only chyme, but bile and pancreatic fluid. The effect of this admixture was to separate the chyme into three distinct parts,—a reddish brown sediment at the bottom,—a whey-coloured fluid in the centre,—and a creamy pellicle at the top. The central portion, with the creamy pellicle, seems to constitute the *chyle* absorbed by the lacteals; the creamy matter being chiefly composed of oily particles; and the wheyey fluid having proteine-compounds, saccharine and saline matters, in solution: the sediment, partly consisting of the insoluble portion of the food, and partly of the biliary matter itself, is evidently excrementitious. It is not until the food has passed the orifice of the Ductus Choledochus, that the absorption of chyle begins,—the lacteals not being distributed upon the Stomach, or the higher part of the Duodenum.

661. By the gradual withdrawal of their fluid portion, the contents of the alimentary canal are converted into a mass of greater consistence; and this, as it advances through the small intestines, assumes more and more of a faecal character. A part of the *faeces*, however, may be derived from the secretions of the enteric mucous membrane, and of its glandulæ; the surface of the former, with its simple follicles, probably secretes nothing else than mucus; but the *glandulæ*, with which it is so thickly studded, appear to serve as the channel for the elimination of putrescent matter from the blood. There can be no doubt, that a large quantity of fluid is poured out by these glandulæ, when they are in a state of irritation from disease, or from the stimulus of a purgative medicine; since the amount of water discharged from the bowels is

* The bile seems to have an important share in producing this effect; since, when the ductus choledochus is tied, constipation always occurs. The action of mercury as a purgative appears to take place through the increase of the hepatic and other secretions which it induces.

often much greater than that which has been ingested, and must be derived from the blood.—The secretion of the cæcum has been ascertained to be, in herbivorous animals, distinctly acid during digestion; and there is reason to believe, that the food there undergoes a second process, analogous to that to which it has been submitted in the stomach, and fitted to extract from it whatever undissolved alimentary matter it may still contain. There is no evidence, however, that this is the case in Man, whose cæcum (commonly termed the appendix cæci vermiformis) is very small, compared to that of most herbivorous animals.

662. The act of *Defecation* having been already sufficiently considered (§ 391), it only remains to notice the composition of the Fæces. These are made up of certain parts of the food, which have not been reduced and absorbed; together with that portion of the secretions poured into the alimentary canal between the mouth and the anus, which has not been taken back again into the system. Of the former portion, the constituents may be in great part determined by the Microscope. Thus the cell-walls of the Vegetable tissues whose contents have been extracted, the entire woody fibres (on which the digestive process has no influence), the granules of starch, when they have undergone no preparation before being swallowed,—portions of tendon, ligament, adipose tissue, and even of muscular fibre,—with other substances constituting the undigested residue of the food, may be readily detected. Besides these, the microscope enables us to recognize the brown colouring-matter of the bile, epithelium-cells and mucus-corpuseles, and various saline particles, especially those of the ammoniaco-magnesian phosphate, whose crystals are well-defined; most of which are derived from the secretions.—The following is the result of the proximate analysis of the fæces of an individual in good health, who had taken the ordinary diet of this country, as given by Dr. Percy:—

Substances soluble in ether (brownish yellow fat)	.	.	.	11·95
“ “ alcohol of 830	.	.	.	10·74
“ “ water (brown resinoid matter)	.	.	.	11·61
Organic matter insoluble in the above menstrua	.	.	.	49·33
Salts soluble in water	.	.	.	4·76
Salts insoluble in water	.	.	.	11·61

Ultimate analysis of the same fæces gave the following as the proportion of the components of the Organic constituents; Carbon 46·20, Hydrogen 6·72, Nitrogen and Oxygen 30·71.—The mineral ash of fæcal matter has been examined by Enderlin; who has given the following as the proportion of its ingredients:—

Chloride of sodium and alkaline sulphates	.	.	1·367	} Soluble in water.
Bibasic phosphate of soda	.	.	2·633	
Phosphates of lime and magnesia	.	.	80·372	} Insoluble in water.
Phosphate of iron	.	.	2·090	
Sulphate of lime	.	.	4·530	
Silica	.	.	7·940	

It further appears from the inquiries of Enderlin, that a portion of the organic matter taken up by alcohol, sometimes (but not constantly) consists of Choleate of soda, the characteristic ingredient of bile; and he thinks that this is more likely to be present, when the fæces have remained for only a short period in the large intestine, and when there has been less time for its re-absorption.—In the fæcal discharges which result from the action of mercurials, large quantities of biliary matter may be detected, very little changed.

4. *Nature of Chymification and Chylification.*

663. The causes of the reduction of the food in the Stomach, have long been a fruitful source of discussion amongst physiologists; and various hypotheses have been devised to account for it. Some have compared the Stomach of Man to the Gizzard of a fowl, and have supposed that the *trituration* of the food between its walls was the essential element in the process; but this doctrine is completely incompatible with the fact, that digestible substances, inclosed in metallic balls with perforations in their sides, are still dissolved by the power of the gastric fluid, though the walls of the stomach do not come in contact with them. Others, again, have imagined that the process of digestion is one of *putrefaction*; but this idea, putting aside its inherent absurdity, is proved to be incorrect by the fact that the gastric juice has a decidedly antiseptic quality. Others, in despair of obtaining any other solution, have attributed the operation to the direct agency of the *vital principle*; forgetting that, as long as the aliment remains within the stomach and intestinal canal, it can no more be the subject of any peculiarly vital process, than if it were in contact with the skin, of which the mucous membrane is but an internal reflexion. The theory of *chemical solution*, which was at first regarded by many as quite untenable, has been of late years so much strengthened by new facts and arguments, that there now appears no valid reason for withholding our assent from it; even though it cannot yet give a complete explanation of the complex phenomena in question. The chief opposition to this theory has arisen from the difficulty of imagining, that any simply-chemical solvent should have the power of acting on so great a variety of substances, and of reducing them to a state so homogeneous. This difficulty, however, seems now in a great degree removed, by the discovery of the close Chemical relation that subsists, between the various substances of each of the groups already enumerated (§ 639); which renders it easy to conceive, that the changes involved in their reduction may be of a very simple character.

664. The first series of facts which will be here adduced, as throwing light on the process of Chymification, is that which has been obtained by the experiments of Dr. Beaumont upon the individual already alluded to (§ 658.) By introducing a tube of India-rubber into the empty stomach, he was able to obtain a supply of Gastric Juice whenever he desired it; for the tube served the purpose of stimulating the follicles to pour forth their secretion, and at the same time conveyed it away. This fluid, of which the existence has been denied by some physiologists, is not very unlike saliva in its appearance; it is, however, distinctly acid to the taste; and chemical analysis shows that it contains a considerable proportion of free muriatic acid, and also some acetic acid. The former must evidently be derived from the decomposition of the muriate of soda contained in the blood, the remote source of which is the salt ingested with the food. The latter is an organic compound, probably formed at the expense of some of the saccharine matter of the previous aliment. Of equal importance with the free acids, is an animal matter, soluble in cold water, but insoluble in hot, bearing considerable resemblance to albumen. Of this more will be said hereafter. Besides these principal ingredients, the gastric fluid contains muriates and phosphates of potass, soda, magnesia, and lime. It possesses the power of coagulating albumen in an eminent degree; it is powerfully antiseptic, checking the putrefaction of meat; and it is effectually restorative of healthy action, when applied to old fetid sores and foul ulcerating surfaces. It may be kept for many months, if excluded from the air without becoming fetid.

a. The Chemistry of the Gastric Juice has been greatly unsettled by the results of recent

inquiries; which seem inconsistent with the statement just given, especially in regard to the presence of free muriatic acid. It may be well, in the first instance, to quote Professor Duglison's account of the analysis of the gastric fluid drawn from the stomach of Alexis St. Martin, and supplied to him by Dr. Beaumont. "*The quantity of free hydrochloric acid was surprising*; on distilling the gastric fluid, the acids passed over, the salts and animal matter remaining in the retort; the amount of chloride of silver thrown down, on the addition of nitrate of silver to the distilled fluid, was astonishing. The author had many opportunities of examining the gastric secretion obtained from the case in question. At all times, when pure or unmixed, except with a portion of the mucus of the lining membrane of the digestive tube, it was a transparent fluid, *having a marked smell of hydrochloric acid*; and of a slightly salt, and very perceptibly acid, taste." (Human Physiology, Sixth Edition, Vol. I., p. 546.)

b. From the experiments of MM. Blondlot, Bernard, and Barreswill, and Dr. R. D. Thomson, on the other hand, it would seem that no free hydrochloric acid is present in the gastric fluid; since the fluid which comes over, on distillation at a low temperature, contains none; whilst the matter remaining in the retort becomes more and more acid with the progress of the distillation, and may be subjected to a high temperature (300°) without giving off acid fumes. It is difficult to account for the discrepancy between these carefully conducted experiments, and the positive statement of Professor Duglison, otherwise than by supposing that the Human gastric fluid differs from that of the Dog and the Pig, which were employed in the analyses last quoted.—The acid reaction was referred by Blondlot to the presence of super-phosphate of lime; but this seems incorrect. Professor Thomson agrees with MM. Bernard and Barreswill in attributing it chiefly to Lactic acid; which, contrary to previous opinions, they regard as generally if not universally present in the stomach during healthy digestion, and it would seem that this acid may partially decompose the phosphates and muriates, which are contained in the secretion: and may thus occasion the phosphoric and muriatic acids to be set free. The presence of a small quantity of free Acetic acid, also, seems to have been recognized by them.

665. The Gastric Juice obtained from the stomach, was found by Dr. Beaumont to possess the power of dissolving various kinds of alimentary substances, when these were submitted to its action at a constant temperature of 100°, (which is about that of the stomach,) and were frequently agitated. The solution appeared to be in all respects as perfect as that which naturally takes place in the stomach; but required a longer time. This is readily accounted for when we remember, that no ordinary agitation can produce the same effect with the curious movements of the stomach; and that the continual removal from its cavity, of the matter which has been already dissolved, must aid the operation of the solvent on the remainder. The following is one out of many experiments detailed by Dr. Beaumont. "At 11½ o'clock, A. M., after having kept the lad fasting for 17 hours, I introduced a gum-elastic tube, and drew off one ounce of pure gastric liquor, unmixed with any other matter, except a small proportion of mucus, into a three-ounce vial. I then took a solid piece of boiled recently-salted beef, weighing three drachms, and put it into the liquor in the vial; corked the vial tight, and placed it in a saucpan filled with water, raised to the temperature of 100°, and kept at that point on a nicely-regulated sand-bath. In *forty* minutes, digestion had distinctly commenced over the surface of the meat. In *fifty* minutes, the fluid had become quite opaque and cloudy; the external texture began to separate and become loose. In *sixty* minutes, chyme began to form. At 1 o'clock, P. M., (digestion having progressed with the same regularity as in the last half-hour), the cellular texture seemed to be entirely destroyed, leaving the muscular fibres loose and unconnected, floating about in fine small shreds, very tender and soft. At 3 o'clock, the muscular fibres had diminished one-half, since the last examination. At 5 o'clock, they were nearly all digested; a few fibres only remaining. At 7 o'clock, the muscular texture was completely broken down, and only a few of the small fibres could be seen floating in the fluid. At 9 o'clock, every part of the meat was completely digested. The gastric juice, when taken from the stomach, was as clear and transparent as water. The mixture in the vial was now about the colour of whey. After

standing at rest a few minutes, a fine sediment, of the colour of the meat, subsided to the bottom of the vial.—A piece of beef, exactly similar to that placed in the vial, was introduced into the stomach, through the aperture, at the same time. At 12 o'clock it was withdrawn, and found to be as little affected by digestion as that in the vial; there was little or no difference in their appearance. It was returned to the stomach; and, on the string being drawn out at 1 o'clock P. M., the meat was found to be all completely digested and gone. The effect of the gastric juice on the piece of meat suspended in the stomach, was exactly similar to that in the vial, only more rapid after the first half hour, and sooner completed. Digestion commenced on, and was confined to, the surface entirely in both situations. Agitation accelerated the solution in the vial, by removing the coat that was digested on the surface, enveloping the remainder of the meat in the gastric fluid, and giving this fluid access to the undigested portions.* Many variations were made in other experiments; some of which strikingly displayed the effects of thorough mastication, in aiding both natural and artificial digestion.

666. The attempt was made by Dr. Beaumont, to determine the relative digestibility of different articles of diet, by observing the length of time requisite for their solution. But, as he himself points out, the rapidity of digestion varies so greatly, according to the quantity eaten, the nature and amount of the previous exercise, the interval since the preceding meal, the state of health, the condition of the mind, and the nature of the weather, that a much more extended inquiry would be necessary to arrive at results to be depended on. Some important inferences of a general character, however, may be drawn from his inquiries.—It seems to be a general rule, that the flesh of wild animals is more easy of digestion than that of the domesticated races which approach them most nearly. This may, perhaps, be partly attributed to the small quantity of fatty matter that is mixed up with the flesh of the former, whilst that of the latter is largely pervaded by it. For it appears from Dr. B.'s experiments, that the presence in the stomach of any substance which is difficult of digestion, interferes with the solution of food that would otherwise be soon reduced. It seems that, on the whole, Beef is more speedily reduced than Mutton, and Mutton sooner than either Veal or Pork. Fowls are far from possessing the digestibility that is ordinarily imputed to them; but Turkey is, of all kinds of flesh except Venison, the most soluble. Dr. B.'s experiments further show, that *bulk* is as necessary for healthy digestion, as the presence of the nutrient principle itself. This fact has been long known by experience to uncivilized nations. The Kamschatdales, for example, are in the habit of mixing earth or saw-dust with the train-oil, on which alone they are frequently reduced to live. The Veddahs or wild hunters of Ceylon, on the same principle, mingled the pounded fibres of soft and decayed wood with the honey, on which they feed when meat is not to be had; and on one of them being asked the reason of the practice, he replied, "I cannot tell you, but I know that the belly must be filled." It is further shown by Dr. B., that soups and fluid diet are not more readily chymified than solid aliment, and are not alone fit for the support of the system; and this, also, is conformable to the well-known results of experience; for a dyspeptic patient will frequently reject chicken-broth, when he can retain solid food or a richer soup. Perhaps, as Dr. A. Combe remarks, the little support gained from fluid diet, is due to the rapid absorption of the watery part of it; so that the really nutritious portion is left in too soft and concentrated a state, to excite the healthy action of the stomach.—Dr. Beaumont also ascertained that moderate exercise facilitates digestion, though severe and fatiguing exercise

* Experiments 2 and 3 of First Series.

retards it. If even moderate exercise be taken *immediately* after a *full* meal, however, it is probably rather injurious than beneficial; but if an hour be permitted to elapse, or if the quantity of food taken have been small, it is of decided benefit. The influence of temperature on the process of solution, is remarkably shown in some of Dr. B.'s experiments. He found that the gastric juice had scarcely any influence on the food submitted to it, when the bottle was exposed to the cold air, instead of being kept at a temperature of 100°. He observed on one occasion, that the injection of a single gill of water at 50° into the stomach, sufficed to lower its temperature upwards of 30°; and that its natural heat was not restored for more than half an hour. Hence the practice of eating ice after dinner, or even of drinking largely of cold fluids, is very prejudicial to digestion.

667. From the foregoing statements we may conclude, that the process by which the food is dissolved in the Gastric fluid is of a purely Chemical nature, since it takes place out of the living body as well as in it,—allowance being made for the difference in its physical condition. That the natural process of digestion is imitated, when the food is submitted to the action of the gastric juice in a vial, not only in regard to the disintegration of its particles, but as to the change of character which they are made to undergo, is proved by the fact, that the artificial chyme thus formed exhibits the same changes as the real chyme, when submitted to the action of the bile (§ 658). The process of digestion, however, may be freely conceded to be vital, in so far as it is dependent upon the agency of a secreted product, which vitality alone (so far at least as we at present know) can elaborate; and all for which it is here contended is, that, when this product is once formed, it has an agency upon the alimentary matter, which, though not yet fully understood, is conformable, in all that is known of its operation, to the ordinary laws of chemistry. Thus, Digestion is conformable to Chemical solution.—*first*, in the assistance which both derive from the minute division of the solids submitted to it;—*secondly*, in the assistance which both derive from the successive addition of small portions of the comminuted solid to the solvent fluid, and from the thorough intermixture of the two by continual agitation;—*thirdly*, in the limitation of the quantity of food on which a given amount of gastric juice can operate, which is precisely the case with chemical solvents;—*fourthly*, in the assistance which both derive from an elevation of temperature,—the beneficial influence of heat being only limited, in the case of digestion, by its tendency to produce decomposition of the gastric fluid;—*fifthly*, in the different action of the same solvent upon the various solids submitted to it.

668. It may be considered a well-established fact, that diluted acids alone have no power of chymifying alimentary substances, although capable of partially dissolving some of them; but that their presence in the gastric fluid is essential to its effectual action. The active agent in the process appears to be an Organic compound, to which the name of *pepsin* has been given. The properties of this have been investigated by Wasmann, who first succeeded in obtaining it in an isolated state; his observations were made upon the mucous membrane of the stomach of the Pig, which greatly resembles that of Man.

a. When this membrane is digested in a large quantity of water at from 85° to 95°, many other matters are removed from it besides pepsin; but if this water be removed, and the digestion be continued with fresh water in the cold, very little but pepsin is then taken up. Pepsin appears to be but sparingly soluble in water; when its solution is evaporated to dryness, there remains a brown, grayish, viscid mass, with the odour of glue, and having the appearance of an extract. The solution of this in water is turbid, and still possesses a portion of the characteristic power of pepsin, but greatly reduced. When strong alcohol is added to a fresh solution of pepsin, the latter is precipitated in white flocks, which may be collected on a filter, and produce a grey compact mass when dried. Pepsin enters into chemical com-

bination with many acids, forming compounds which still redden litmus paper; and it is when thus united with acetic and muriatic acids, that its solvent powers are the greatest.

b. "In regard to the solvent power of pepsin for coagulated albumen, it was observed by M. Wasmann that a liquid which contains 17-10,000ths of acetate of pepsin, and 6 drops of hydrochloric acid per ounce, possesses a very sensible solvent power, so that it will dissolve a thin slice of coagulated albumen in the course of 6 or 8 hours' digestion. With 12 drops of hydrochloric acid per ounce, the white of egg is dissolved in 2 hours. A liquid which contains $\frac{1}{2}$ gr. of acetate of pepsin, and to which hydrochloric acid and white of egg are alternately added, so long as the latter dissolves, is capable of taking up 210 grains of coagulated white of egg at a temperature between 95° and 104°. It would appear, from such experiments, that the hydrochloric acid is the true solvent, and that the action of the pepsin is limited to that of disposing the white of egg to dissolve in hydrochloric acid. The acid when alone dissolves white of egg by ebullition, just as it does under the influence of pepsin; from which it follows that pepsin replaces the effect of a high temperature, which is not possible in the stomach. The same acid with pepsin dissolved blood, fibrine, meat and cheese; while the isolated acid dissolved only an insignificant quantity at the same temperature; but when raised to the boiling point, it dissolved nearly as much, and the part dissolved appeared to be of the same nature. The epidermis, horn, the elastic tissue (such as the fibrous membrane of arteries) do not dissolve in a dilute acid containing pepsin. M. Wasmann has remarked that the pepsin of the stomach of the pig is entirely destitute of the power to coagulate milk, although the pepsin of the stomach of the calf possesses it in a very high degree; from which he is led to suppose, that the power of the latter depends upon a particular modification of pepsin, or perhaps upon another substance accompanying it, which ceases to be formed when the young animal is no longer nourished by the milk of its mother."*

669. It is considered by Liebig, however, that Pepsin has no proper existence as such; and that it is nothing else than a proteine-compound in a state of change,—being, when obtained after the method of Wasmann, the result of the partial decomposition of the membrane of the stomach, which has been induced in it by exposure to air. This view accords well with the fact, recently ascertained by MM. Bernard and Barreswill, that the Saliva and Pancreatic fluid have an equal solvent power when acidulated. In their alkaline condition, their action appears limited to starchy matters; of which they effect the conversion into sugar. In their acid state, they act, like the gastric fluid, upon azotized matters; and, in common with it, they are destitute of power to act upon starch.—We are further led, by this remarkable fact (the knowledge of which enables us to harmonize many previous results, which were apparently discordant), to a better understanding of the nature of the action of this Organic compound in the Digestive process. Its operation on starch is precisely that of the substance termed *Diastase*, which is found in Plants, and which is the agent employed for the conversion of starch into sugar, in various processes of the Vegetable economy. In so doing, it acts as a sort of *ferment*; having the power of exciting a change in another substance, in which it does not itself participate. This appears to be precisely the nature of its operation upon azotized matters; in which it produces an incipient change, that so alters their condition, as to dispose them to solution in hydrochloric and acetic acids, with which they form definite chemical compounds.—The analogy of the action of Pepsin to that of a ferment, is further shown in the power possessed by a very small quantity of it, to excite the required change in an almost unlimited amount of alimentary matters; whilst only a definite quantity of these matters, when thus prepared, can be dissolved in a limited amount of dilute acid; which is precisely analogous to the process of chemical solution. The agency of Pepsin, in preparing them for that process, resembles that of Heat; by which it may be replaced,—the dilute acids alone, at a high temperature, having the power of dissolving azotized compounds.

670. We have, in the last place, to consider the changes which are effected

* Graham's Elements of Chemistry, [Am. ed. p. 695.]

in the nutritive materials, by the admixture of the biliary and pancreatic secretions; and to inquire into the form in which they are received into the absorbent vessels.—The substances of the first or *saccharine* group consist chiefly of Sugar and Starch. It appears from the late researches of MM. Bouchardat and Sandras, that Sugar is gradually converted, during its passage along the alimentary canal, into lactic acid; and that it is absorbed in this form alone, unless it have been administered in considerable quantity or for a long period. The conversion of sugar into lactic acid, appears to be preliminary to the elimination of that substance by the respiratory process. The particles of Starch, as already mentioned, are but very little acted on by the digestive process, at least in Man and the Mammalia, unless their envelopes have been previously ruptured by heat or chemical agents; but the triturating power of the gizzard in granivorous Birds, aided by the high temperature and the more alkaline character of the secretions, enables them to act with more energy upon amylaceous substances. The products of the digestive action upon starch, are dextrine and grape-sugar; and this is gradually converted into lactic acid, in which state it is absorbed. If sugar be introduced into the blood-vessels unchanged, it is drawn off by the urine; and its heat-sustaining agency, therefore, is not exerted. It is probably to avoid its too rapid introduction that the conversion of amylaceous into saccharine matter is so slowly effected in the alimentary canal; this conversion seems to begin in the mouth, to cease in the stomach during the operation of the acid solvent, and to recommence after the neutralization of the acid by the biliary and pancreatic fluids,—subsequently continuing during nearly the whole of the passage of the alimentary matter along the intestinal tube.—It is now quite certain, that the substances of this class may be converted, in the living body, into oleaginous matter. Of the mode and the situation in which this conversion takes place, nothing whatever is certainly known; but a clue to an acquaintance with the former seems to be given by the recently-discovered fact, that the continued contact of bile with saccharine matter occasions the conversion of a portion of the sugar into an adipose compound (§ 835).

671. The substances forming the *Oleaginous* class do not seem to undergo any change, except minute division of their particles, until the Chyme is mingled with bile; which substance acts as a soap, and renders the oily matters soluble, or at any rate reduces them to a condition in which they can be absorbed by the lacteals. This, indeed, seems to be the main purpose of that admixture of the bile with the mass in process of digestion, which experiments and pathological observation abundantly prove to be requisite for the due performance of that function. Thus, it has been shown by the experiments of Schwann, that, if the bile-duct be divided, and be made to discharge its contents externally through a fistulous orifice in the walls of the abdomen, instead of into the intestinal canal, those animals which survive the immediate effects of the operation, subsequently die from inanition, almost as soon as if they had been entirely deprived of food. In like manner, if the flow of the biliary secretion into the intestine be prevented by disease,—such as obstruction of the gall-duct,—the digestive function is evidently disordered, the peristaltic action of the intestine is not duly performed, the feces are white and clayey; and there is an obvious insufficiency in the supply of nutriment prepared for the absorbent vessels. This deficiency seems partly due to the want of power to absorb the oleaginous particles of the food, which is the result of the non-intermixture of the bile with the chyme; and partly to the suspension of the supply of combustible matter, that is afforded by certain constituents of the bile itself, which are destined, not to be carried out of the system, but to be re-absorbed.—The presence of bile in the stomach has the effect of suspend-

ing the solution of the various azotized principles, and in regard to them, therefore, it is injurious; but it seems, from the observations of Dr. Beaumont, to be a spontaneous occurrence, whenever the diet has been for a long time, and in great part, of an oleaginous nature; and it then appears destined to aid in the reducing process, which is the proper function of the stomach. It is suggested by Dr. A. Combe, whether the peculiar digestibility of a piece of fat bacon, in certain forms of Dyspepsia, may not be due to the abnormal presence of bile in the stomach. The power of precipitating the proteine-compounds from their acid solutions, which has been shown, by the recent experiments of Platner, to belong to the peculiar principles of bile, fully explains its injurious effects upon the solvent processes, which normally take place in the stomach.—In regard to the *Albuminous* and *Gelatinous* articles of food, there is no evidence that any other change is effected in them, than one of simple solution; and they appear to be absorbed in the same condition as that to which they are reduced by the action of the stomach.

CHAPTER XI.

OF ABSORPTION AND SANGUIFICATION.

1.—*Absorption from the Digestive Cavity.*

672. So long as the Alimentary matter is contained in the digestive cavity, it is as far from being conducive to the nutrition of the system, as if it were in contact with the external surface. It is only when absorbed into the vessels, and carried by the circulating current into the remote portions of the body, that it becomes capable of being appropriated by its various tissues and organs. Among the Invertebrata, we find the reception of alimentary matter into the Circulating system to be entirely accomplished through the medium of the *blood-vessels*, which are distributed upon the walls of the digestive cavity. But in the Vertebrata, we find an additional set of vessels interposed between the walls of the intestine and the sanguiferous system; for the purpose, as it would seem, of taking up that portion of the nutritive matter which is not in a state of perfect solution, and of preparing it for being introduced into the current of the blood. These are the *lacteals*, or absorbents of the intestinal walls. That their special office is to take up the product of the admixture of the chyme with the biliary and pancreatic fluids, appears from the fact, that they are not distributed at all upon the walls of the stomach, nor upon those of the duodenum above the point of entrance of the hepatic and pancreatic ducts; but that they are copiously distributed upon the walls of the remainder of the small intestine, and more sparingly upon those of the large. Each lacteal tube originates in the interior of one of the villous processes of the mucous membrane lining the intestinal tube. The accompanying figure represents the appearance offered by the incipient lacteals, in a villus of the jejunum of a young man, who had been hung soon after taking a full meal of farinaceous food. The trunk that issues from the villus is formed by the confluence of

Fig. 204.



One of the intestinal villi, with the commencement of a lacteal.

several smaller branches, whose origin it is difficult to trace; but it is probable that they form loops by anastomosis with each other, so that there is no proper free extremity in any case. It is quite certain that the lacteals never open by free orifices upon the surface of the intestine, as was formerly imagined. From the researches of Mr. J. Goodsir, already referred to (§ 181), it appears that these loops are imbedded in a mass of cells, which are the real agents in the selection of the materials that are destined to be conveyed into the lacteals. When these cells have distended themselves, by their inherent power of growth, with the materials which are adapted to their selecting function, and have reached their full term of maturity, they appear to yield their contents to the absorbent vessels, either by bursting or by deliquescence.—It is thought by Prof. E. Weber, that the epithelial cells, which cover the villus, perform a preliminary office; the nutrient matter being first absorbed and partially prepared by them; and then being drawn, through the basement membrane of the villus, into the special absorbent cells which form part of its substance. This seems the more likely, as we shall hereafter find that the epithelial cells of the placental tufts appear to perform a like function.

673. The *villi* are also furnished with a minute plexus of blood-vessels; of which the larger branches may be seen with the naked eye, when they are distended with blood, or with coloured injection (Figs. 205, 206). The particular arrangement of the capillaries of which the plexus is formed, varies in different animals; but in all they seem to be most copiously distributed upon the *surface* of the villus. The purpose of these may be partly to afford some of the materials for the development of the absorbent cells; and this would seem probable from the recent experiments of Mr. Fenwick,* which show that the lacteals will not absorb alimentary matter from any part of the intestinal canal, in which the blood is not circulating. But there can be no reasonable doubt, that the blood-vessels of the mucous membrane lining the digestive cavity, and especially those of the villi, perform an important part in the function of Absorption. This is established by the fact, that soluble substances introduced into the stomach, and prevented from passing beyond its pyloric orifice, are absorbed from its walls.

674. In regard to the degree in which the function of Nutritive Absorption is performed by the Lacteals, and by the Sanguiferous System, respectively, considerable difference of opinion has prevailed. When the Absorbent vessels were first discovered, and their functional importance perceived, it was imagined that the introduction of alimentary fluid into the vascular system took place by them alone. A slight knowledge of Comparative Anatomy, however, might have sufficed to correct this error; since no lacteals exist in the Invertebrated animals, the function of Absorption being performed by the Mesenteric blood-vessels only; from which it is evident, that these do possess the power of absorption: and it is scarcely to be supposed that they should not exercise this power in Vertebrated animals also, since their disposition on the walls of the intestinal cavity is evidently favourable to it. On the other hand, the introduction of a new and distinct system of vessels would seem to indicate, that they must have some special purpose; and there can be no doubt that the absorption of certain kinds of nutritive matter is that for which they are peculiarly designed. The fluid found in the lacteals is

* Lancet, Jan. and Feb. 1845.

Fig. 205.

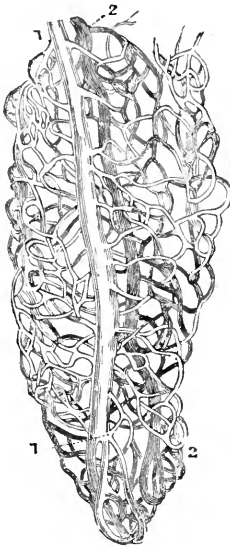

Vessels of an intestinal villus of a *Hare*, from a dry preparation by Döllinger: 1, 1, veins filled with white injection; 2, 2, arteries injected red. Magnified about 45 diameters.

Fig. 206.

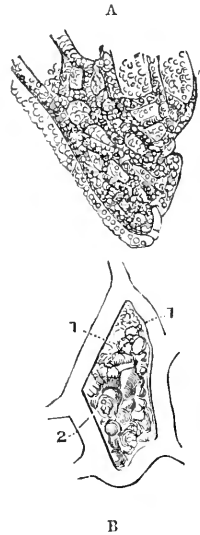

A, apex of intestinal villus from the duodenum of Human female; B, a mesh of the vascular network, 1, 1, filled up with delicate cellular tissue, 2, 2, magnified about 45 diameters.

almost invariably the same; being that to which the name *chyle* has been applied. It appears from the uniformity of its composition, which forms a striking contrast with the diversity of the food from which it is obtained, that the lacteals (or rather the absorbent cells, amongst which they originate) have in some degree the power of *selecting* the particles of which it is composed; and that, whilst they take up such a proportion of each class of alimentary materials as will rightly blend with the rest in the nutritious fluid, they reject not only the remainder, but also (for the most part at least) any other ingredients which may be contained in the fluid of the intestines. Such may be stated as the general result of the experiments that have been made to determine their function; though it is unquestionable that extraneous substances, especially of a saline nature, occasionally find their way into this system of vessels. This may not improbably be due to a correspondence in the size and form of the ultimate particles of such substances, with those of the materials normally absorbed by the lacteals.*

675. On the other hand, the Blood-vessels seem to be less concerned in nutritive absorption, but take up from the alimentary canal a portion of almost any fluid matters which it may contain. This seems to have been established by the carefully-conducted experiments of MM. Tiedemann and Gmelin, who

* Experiments upon the function of Absorption in Plants, whose radical vessels have a corresponding power of *selection*, appear likely to assist in elucidating this interesting subject. By the experiments of Dr. Daubeny it has been ascertained, that if a plant absorb any particular saline compound, it can also be made to absorb those which are *isomorphous* with it, though it will reject most others.—See Princ. of Gen. and Comp. Phys., § 294.

mingled with the food of animals various substances, which, by their colour, odour, or chemical properties, might be easily detected in the fluids of the body. After some time the animal was examined; and the result was, that unequivocal traces of the substances were not unfrequently detected in the venous blood and in the urine; whilst it was only in a very few instances, that any indication of them could be discovered in the chyle. The colouring matters employed were various vegetable substances; such as gamboge, madder, and rhubarb: the odorous substances were camphor, musk, assafœtida, &c.; while, in other cases, various saline bodies, such as muriate of barytes, acetate of lead and of mercury, and some of the prussiates, which might easily be detected by chemical tests, were mixed with the food. The colouring matters, for the most part, were carried out of the system, without being received either into the veins or lacteals; the odorous substances were generally detected in the venous blood and in the urine, but not in the chyle; whilst of the saline substances, many were found in the blood and in the urine, and a very few only in the chyle. A similar conclusion might be drawn from the numerous instances in which various substances introduced into the intestines have been detected in the blood, although the thoracic duct had been tied; but these results are less satisfactory, because even if there is no direct communication (as maintained by many) between the lacteals and the veins in the mesenteric glands, the partitions which separate their respective contents are evidently so thin, that transudation may readily take place through them.—It would seem probable, that substances *perfectly dissolved* in the fluids of the stomach, are taken into the blood-vessels so copiously distributed on its walls, by the simple and necessary process of Endosmose; in this manner we may account for the fact, that saline substances are for the most part readily absorbed into the blood; and there seems reason to believe that the Albuminous portion of the chyme, together with the Saccharine principles or the products of their transformation, may thus be introduced directly into the circulating current, without passing through the lacteals.—On this subject there is much need of further information.

2.—*Absorption from the Body in general.*

676. The Mucous Membrane of the alimentary canal is by no means the only channel, through which nutritive or other substances may be introduced into the circulating apparatus. The *Lymphatic* system is present in all animals which have a *lacteal* system; and the two evidently constitute one set of vessels. The lymphatics, however, instead of commencing on the intestinal walls, are distributed through the greater part of the body, especially on the Skin; their origins cannot be clearly traced; but they seem in general to form a plexus in the substance of the tissues, from which the convergent trunks arise. After passing, like the lacteals, through a series of glandular bodies (the precise nature of which will be presently considered, § 682), they empty their contents into the same receptacle with the lacteals; and the mingled products of both pass into the Sanguiferous system.—We find in the Skin, also, a most copious distribution of capillary blood-vessels, the arrangement of which is by no means unlike that of the blood-vessels of the alimentary canal; and its surface is further extended by the elevations that form the sensory papillæ, which are in many points comparable to the intestinal villi, although their special function is so different.—In the lowest tribes of animals, and in the earliest condition of the higher, it would seem as if Absorption by the *external surface* is almost equally important to the maintenance of life, with that which takes place through the internal reflexion of it forming the walls of the Digestive cavity. In the adult condition of the higher animals, how-

ever, the special function of the latter is so much exalted, that it usually supercedes the necessity of any other supply; and the function of the cutaneous and pulmonary surfaces may be considered as rather that of exhalation, than of absorption. But there are peculiar conditions of the system, in which the imbibition of fluid through these surfaces is performed with great activity, supplying what would otherwise be a most important deficiency. It may take place either through the direct application of fluid to the surface, or even through the medium of the atmosphere, in which a greater or less proportion of watery vapour is usually dissolved. This absorption occurs most vigorously, when the system has been drained of its fluid, either by an excess of the excretions, or by a diminution of the regular supply.

677. It may be desirable to adduce some individual cases, which will set this function in a striking point of view; and those may be first noticed, in which the absorption took place, through the contact of *liquids* with the skin. It is well known that shipwrecked sailors, and others, who are suffering from thirst, owing to the want of fresh water, find it greatly alleviated, or altogether relieved, by dipping their clothes into the sea, and putting them on whilst still wet, or by frequently immersing their own bodies.—Dr. Currie relates the case of a patient labouring under dysphagia in its most advanced stage; the introduction of any nutriment, whether solid or fluid into the stomach, having become perfectly impracticable. Under these melancholy circumstances, an attempt was made to prolong his existence, by the exhibition of nutritive enemata, and by immersion of the body, night and morning, in a bath of milk and water. During the continuance of this plan, his weight, which had previously been rapidly diminishing, remained stationary, although the quantity of the excretions was increased. How much of the absorption, which must have been effected to replace the amount of excreted fluid, is to be attributed to the baths, and how much to the enemata, it is not easy to say; but it is important to remark that “the thirst, which was troublesome during the first days of the patient’s abstinence, was abated, and, as he declared, removed by the tepid bath, in which he had the most grateful sensations.” “It cannot be doubted,” Dr. Currie observes, “that the discharge by stool and perspiration exceeded the weight of the clysters;” and the loss by the urinary excretion, which increased from 24 oz. to 36 oz. under this system, is only to be accounted for by the cutaneous absorption.—Dr. S. Smith mentions that a man, who had lost nearly 3 lbs. by perspiration, during an hour and a quarter’s labour in a very hot atmosphere, regained 8 oz. by immersion in a warm bath at 95°, for half an hour.—The experiments of Dr. Madden* show that a positive increase usually takes place in the weight of the body, during immersion in the warm bath, even though there is at the same time a continual loss of weight by pulmonary exhalation, and by transudation† from the skin. This increase was, in some instances, as much as 5 drachms in half an hour; whilst the loss of weight during the previous half hour had been 6½ drachms: so that, if the same rate of loss were continued in the bath, the real gain by absorption must have been nearly an ounce and a half. Why this gain was much less than in the cases just alluded to, is at once accounted for by the fact that there was no deficiency, in the latter case, of the fluids naturally present in the body.

678. The quantity of water which may be imbibed from the *vapour* of the atmosphere, would exceed belief, were not the facts on which the assertion rests, beyond all question. Dr. Dill relates the case of a diabetic patient,

* Prize Essay on Cutaneous Absorption, pp. 59—63.

† That part of the function of cutaneous transpiration, which consists in simple exhalation, is of course completely checked by such immersion; but that which is the result of an actual secreting process in the cutaneous glands (CHAP. XV., Sect. 8) is increased by heat, even though this be accompanied with moisture.

who for five weeks passed 24 lbs. of urine every twenty-four hours; his ingesta during the same period amounted to 22 lbs. At the commencement of the disease he weighed 145 lbs.; and when he died, 27 lbs. of loss had been sustained. The daily excess of the excretions over the ingesta could not have been less than 4 lbs.; making 140 lbs. for the thirty-five days during which the complaint lasted. If from this we deduct the amount of diminution which the weight of the body sustained during the time, we shall still have 113 lbs. to be accounted for, which can only have entered the body from the atmosphere.—A case of ovarian dropsy has been recorded, in which it was observed that the patient, during eighteen days, drank 692 oz. or 43 pints of fluid, and that she discharged by urine and by paracentesis, 1298 oz. or 91 pints, which leaves a balance of 606 oz. or 38 pints, to be similarly accounted for.*—The following remarkable fact is mentioned by Dr. Watson in his *Chemical Essays*. “A lad at Newmarket, having been almost starved, in order that he might be reduced to a proper weight for riding a match, was weighed at 9 A. M., and again at 10 A. M.; and he was found to have gained nearly 30 oz. in weight in the course of this hour, though he had only drunk half a glass of wine in the interim.”—A parallel instance was related to the Author by the late Sir G. Hill, then Governor of St. Vincent. A jockey had been for some time in training for a race, in which that gentleman was much interested; and had been reduced to the proper weight. On the morning of the trial, being much oppressed with thirst, he took one cup of tea; and shortly afterwards his weight was found to have increased 6 lbs.; so that he was incapacitated for riding.—Nearly the whole of the increase in the former case, and at least three-fourths of it in the latter, must be attributed to cutaneous absorption; which function was probably stimulated by the wine that was taken in the one case, and by the tea in the other.

679. Not only water, but substances dissolved in it, may be thus introduced. It has been found that, after bathing in infusions of madder, rhubarb, and turmeric, the urine was tinged with these substances; and that a garlic plaster affected the breath, when every care was taken, by breathing through a tube connected with the exterior of the apartment, that the odour should not be received into the lungs.† Gallic acid has been found in the urine, after the external application of a decoction of a bark containing it; and the soothing influence in cases of neuralgic pain, of the external application of cherry-laurel water, is well known. Many saline substances are absorbed by the skin, when applied to it in solution; and it is interesting to remark, that, contrary to what happens in regard to the absorption of these from the alimentary canal, they are for the most part more readily discoverable in the absorbents than in the veins. This is probably due to the fact, that the imbibition of them is governed entirely by physical laws; in obedience to which, they pass most readily into the vessels which present the thinnest walls and the largest surface. In the intestines, the vascular plexus on each villus is far more extensive than the ramifying lacteal which originates in it; and as the walls of the veins are thin, there is considerable facility for the entrance of saline and other substances into the general current of the circulation; but in the skin, the lymphatics are distributed much more minutely and extensively than the veins; and soluble matters, therefore, enter them in preference to the veins. The absorbent power of the Lymphatics of the Skin is well shown by the following experiment. A bandage having been tied by Schreger round the hind-leg of a Puppy, the limb was kept for twenty-four hours in tepid milk;

* Madden, *loc. cit.*—In this case, however, something is to be allowed for the quantity of water contained in the solid food ingested.

† Dunglison's *Physiology*, [6th. ed., vol. i. p. 647.]

at the expiration of this period, the lymphatics were found full of milk, whilst the veins contained none. In repeating this experiment upon a young man, no milk could be detected in the blood drawn from a vein. It has been shown by Müller that, when the posterior extremities of a Frog were kept for two hours in a solution of prussiate of potass, the salt had freely penetrated the lymphatics, but had not entered the veins.—It does not follow, however, from these and similar experiments, that in all tissues the lymphatics absorb more readily than the veins; for as the capillary blood-vessels in the lungs are much more freely exposed to the surface of the air-cells, than are the lymphatics, we should, on the principles just now stated, expect the former to absorb more readily. This appears from experiment to be the fact; for when a solution of prussiate of potass was injected by Mayer into the lungs, the salt could be detected in the serum of the blood much sooner than in the lymph, and in the blood of the left cavities of the heart, before it had reached that of the right.

680. Our inferences with regard to the ordinary functions of the Lymphatic system, however, must be rather drawn from the nature of the fluid which it contains, and from the uses subsequently made of it, than from experiments such as the preceding. We shall presently see, that there is a close correspondence in composition between the Chyle of the Lacteals, and the Lymph of the Lymphatics; the chief difference being the presence in the former, of a considerable quantity of fatty matter, and of a larger proportion of the assimilable substances (albumen and fibrine) which are equally characteristic of both (§ 691). This evident conformity in the nature of the fluid which these two sets of vessels transmit, joined to the fact of the fluid Lymph, like the Chyle, being conveyed into the general current of the circulation, just before the blood is again transmitted to the system at large, almost inevitably leads to the inference, that the lymph is, like the chyle, a *nutritious* fluid, and is not of an excrementitious character, as formerly supposed. On the other hand, the close resemblance between the contents of the Lymphatics, and diluted Liquor Sanguinis, seems to indicate that the former are partly derived from the fluid portion of the Blood, which has transuded through the walls of the Capillary vessels; and we shall presently see reason to believe that this transudation is for the purpose of subjecting certain crude materials, that have been taken up direct into the blood-vessels, to an elaborating or preparatory agency, which it seems to be the especial object of the Absorbent system to exert upon certain of the nutritive components of the circulating fluid.

681. But it seems not improbable that there may be another source for the contents of the Lymphatics. We have already had to allude, on several occasions, to the disintegration which is continually taking place within the living body; whether as a result of the limited duration of the life of its component parts; or as a consequence of the decomposing action of Oxygen. Now the *death* of the tissues by no means involves their immediate and complete destruction; and there seems no more reason why an animal should not derive support from its own dead parts than from the dead body of another individual. Whilst, therefore, the matter, which has undergone too complete a disintegration to be again employed as nutrient material, is carried off by the excreting processes that portion which is capable of being again assimilated, may be taken up by the Lymphatic system. If this be the case, we may say, with Dr. Prout, that “a sort of digestion is carried on in all parts of the body.” It may be stated, then, as a general proposition, that the function of the Absorbent System is to take up, and to convey into the Circulating apparatus, such substances as are capable of appropriation to the *nutritive* process; whether these substances be directly furnished by the external world, or be derived from the disintegration of the organism itself. We have seen that,

in the Lacteals, the selecting power is such, that these vessels are not disposed to convey into the system any substances but such as are destined for this purpose; and that extraneous matters are absorbed in preference by the Mesenteric Blood-vessels. The case is different, however, with regard to the Lymphatics; for there is reason to believe, that they are more disposed than the veins to the absorption of other soluble matters; especially when these are brought into relation with the skin, through which the lymphatic vessels are very profusely distributed.

a. Since the time of Hunter, who first brought prominently forward the doctrine alluded to, it has been commonly supposed that the function of the Lymphatics is to remove, by interstitial absorption, the *effete* matter, which is destined to be carried out of the system; and any undue activity in this process (such as exists in ulceration), or any deficiency in its energy (such as gives rise to dropsical effusions, and other collections of the same kind), have been attributed to excess or diminution in the normal operation of the Absorbent System.—From what has been stated, however, it appears that the special function of the Lymphatics, like that of the Lacteals, is *nutritive* absorption;* and that the reception of any other substances into their interior, must be looked upon as resulting simply from the permeability of their walls. This statement applies to the not unfrequent occurrence of the absorption of bile, and other fluids, from the walls of the cavities in which they were collected: with regard to the absorption of pus, however, which has been occasionally noticed to take place, both from internal collections, and from open ulcers, it may be remarked, that the lymphatic vessels were not improbably laid open by ulceration; since in no other way can be understood the entrance of globules so large as those of pus, into their interior.

b. If this view of the function of the Lymphatics be correct, it follows that we must attribute to the Blood-vessels the absorption of the truly *effete* particles; and in this there would seem no improbability. We know that Venous blood contains the elements of two important excretions, that of the lungs and that of the bile, in a far higher amount than does arterial blood; and we shall hereafter see, that there is a certain portion of the fluid, which consists of "ill defined animal principles" that seem ready to be thus thrown off.

c. It may be further remarked, that the reciprocal part which Hunter imagined the Ar-

* The Author, at the time of the publication of the First Edition of this work, believed this view to be altogether novel; he has since learned, however, that a similar doctrine had been put forward by Dr. Moultrie, of South Carolina, in the American Journal of the Medical Sciences, for the year 1827.

[In the American Journal of the Medical Sciences, for 1827, Dr. James Moultrie published an essay on the "Uses of the Lymph," in which, amongst other things attempted to be sustained, will be found the following views.

1. The lacteals and lymphatics do not constitute, as they are supposed to do, the absorbent system of the animal economy; they do not, as the absorbent theory supposes, remove from the organs the "cast off molecules" of which they are composed, or carry out of the body the "effete" particles disintegrated by the act of the assimilative function. The one is engaged in the preparation and introduction of chyle, and chyle only into the blood; the other in elaborating an organizable product—a recrementitious secretion destined to unite with it for objects of a common and nutritious nature. 2. The primary object of the lymph, and that for which it is made to commingle with the chyle in the thoracic duct, is the vitalization of the latter fluid. 3. The truly "effete" matter of the body is the carbonaceous element of the venous blood, to which may be added the urea or azotic element of the urine. Than these, we know of nothing to which that term can be applied. 4. The venous and not the lacteal or lymphatic system, therefore, is the "absorbent system," in any disintegratory or effete sense of the phrase. 5. Nature, in effecting the elimination of excrementitious matter from the constituency of the solid or fluid parts, appears to aim at restoring to the physical universe, the matter temporarily borrowed for subsistence, in a state of elementary simplicity, or an approximation thereto; that is, the carbon as carbon, the azote as azote, and hydrogen and oxygen as hydrogen and oxygen. The lungs she uses as one medium of escape; the kidneys as a second; and the skin as a third, &c. Hence, the carbonic acid gas of respiration; the urea of the kidneys, and the aqueous exhalations of the skin, pulmonary transpiration and urine.

These doctrines have been regularly taught by Dr. M. in his course of lectures on physiology, delivered in the Medical College of the State of South Carolina, since the establishment of the College in 1833. They have also been recently enforced in a *brochure* published by Dr. M., in which he asserts and vindicates his claim to their paternity. *On the Organic Functions of Animals.* By JAMES MOULTRIE, M.D., etc., Charleston, S. C. 1844.—M. C.]

teries and Lymphatics to perform in the function of Nutrition, is quite inconsistent with what is now known of the nature of that process: for, as will subsequently appear, it entirely consists in a reaction between the tissues and the nutritious fluid, in which the vessels have no share save as the channels of supply. When these channels are obstructed, or the supply of new matter is cut off in any other way, the removal of the old by interstitial absorption becomes evident; and that this is accomplished at least as much by the veins as by the lymphatics, appears from the fact that in some tissues, in which it may take place with rapidity, lymphatics do not exist.

3.—Of the Elaboration of the Nutrient Materials.

682. The alimentary substances, taken up by the Absorbent vessels, seem very far from being capable of immediate application to the nutrition of the body; for we find that they are not conveyed by any means directly into the Circulating current, but that they first traverse a long series of tubes, convoluted at intervals into ganglia or knots;* and that, in the course of this passage, they undergo considerable changes, which tend to bring the fluid into closer relationship with the Blood. It seems probable that the materials, which are directly received into the Blood-vessels, are equally far from being immediately applicable to the Nutritive processes; for we find, in connection with the vascular system, certain bodies having the essential structure of glands, but destitute of efferent ducts; which must restore to the circulating current any substances which they withdraw from it; and which there are various reasons (as will presently appear) for placing in the same category with the glandulæ of the Absorbent system.—The Absorbent Glandulæ, whether placed upon the Lacteals in the Mesentery, or upon the Lymphatics in various parts of the body, have the same general structure. They are made up of convoluted knots of absorbent vessels, the simple cylindrical canals of which, however, are usually dilated into larger cavities, or cells; and amongst these, capillary blood-vessels are minutely distributed. These blood-vessels have no direct communication with the interior of the absorbents and the cavities of the glandulæ, being separated from them by the membranous walls of both sets of tubes; but there can be no doubt that transudation readily takes place from one set of canals to the other. The epithelium, which lines the absorbent vessel, undergoes a marked change where the vessel enters the gland; and becomes more like that of the proper glandular follicles in its character. Instead of being flat and scale-like, and forming a single layer in close apposition with the basement-membrane, as it does in the absorbents previous to their entrance into the gland and after their emergence from it, we find it composed of numerous layers of spherical nucleated cells, of which the superficial ones are easily detached, and appear to be identical

Fig. 207.

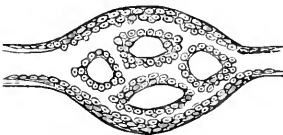
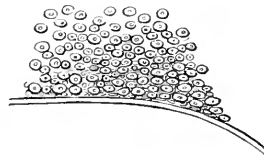

Diagram of a lymphatic gland, showing the intra-glandular network, and the transition from the scale-like epithelia of the extra-glandular lymphatics, to the nucleated cells of the intra-glandular.

Fig. 208.



Portion of intra-glandular lymphatic, showing along the lower edge the thickness of the germinal membrane, and upon it, the thick layer of glandular epithelial cells.

* In Reptiles, in which there are no glands or ganglia in the Absorbent system, the tubes are immensely extended in length.

with the cells found floating in the Chyle.* Their purpose will be considered hereafter.

683. To the class of *Vascular Glands* belong the Spleen, the Thymus and Thyroid Glands, and the supra-Renal Capsules. With the exception of the first, they all have their origin (as recently ascertained by Mr. J. Goodsirt) in involuted portions of the Germinal membrane; and, at an early period of embryonic life, they are in actual continuity with each other. Their original identity of function, therefore, cannot be doubted; and the probability of the inference, which rests on other grounds, that this function is to assimilate or elaborate the nutrient materials (in the manner in which the cells of the leaves of Plants prepare their elaborated sap), is strengthened by its exact conformity with the original function of the Germinal membrane. But there is no improbability that they may severally have some subsidiary or supplementary function to perform; varying according to their respective structure, position, and connections. This seems peculiarly the case in regard to the Spleen; the origin of which body is not the same with that of the other three.

a. According to the account of Dr. Julian Evans,† whose researches appear to have been more successful than those of any other Anatomist, the *Spleen* essentially consists of a fibrous membrane, which constitutes its exterior envelope, and which sends prolongations in all directions across its interior, so as to divide it into a number of minute cavities or lacunæ of irregular form. These *Splenic lacunæ* communicate freely with each other, and with the Splenic vein; and they are lined by a continuation of the lining membrane of the latter, which is so reflected upon itself, as to leave oval or circular foramina, by which each lacuna opens into others, or into the splenic vein. The lacunæ, whose usual diameter is estimated by Dr. Evans at from half to one-third of a line, are generally traversed by filaments of elastic tissue, imbedded in which a small artery and vein may be frequently observed; over these filaments, the lining membrane is reflected in folds; and in this manner each lacuna is incompletely divided into two or more smaller compartments. There is no direct communication between the splenic artery and the interior of the lacunæ; but its branches are distributed through the intercellular parenchyma (which will be presently described); and the small veins, which collect the blood from the capillaries of the organ, convey it into these cavities, from which it is conveyed away by the splenic vein. The lacunæ may be readily injected from the splenic vein with either air or liquid,—provided they are not filled with coagulated blood; and they are so distensible, that the organ may be made to dilate to many times its original size, with very little force. This is especially the case in the Spleen of the Herbivora; for the Spleen of a Sheep, weighing 4 ounces, may be easily made to contain 30 ounces of water. That of Man, however, is less capable of this kind of enlargement.—According to Dr. Evans, the lacunæ of the spleen never contain anything but blood;‡ and he notices that a frequent condition of the Human Spleen after death, which is sometimes described as a morbid appearance, consists in the filling of the lacunæ with firmly-coagulated blood, which gives a granular appearance to the organ.

b. The partitions between the lacunæ are formed, not only by the membranes already mentioned, but by the peculiar parenchyma of the Spleen; which constitutes a larger part of the organ in Man than in the Herbivorous Mammalia. It presents a half fluid appearance to the eye; but when an attempt is made to tear it, considerable resistance is experienced in consequence of its being intersected by what appear to be minute fibres. When a small portion of it is pressed, a liquid is separated; which is that commonly known as the *Liquor Lienis*, or Splenic blood; and which is usually described (but erroneously, according to Dr. E.) as filling the lacunæ of the Spleen. This liquid, when diluted with serum and examined under the Microscope, is found to contain two kinds of corpuscles,—one sort being apparently identical with ordinary blood-corpuscles—and the other with the globules cha-

* See Mr. J. Goodsirt's Anatomical and Pathological Researches, p. 46.

† Proceedings of the Royal Society, 1846.

‡ Lancet, April 6, 1844.

§ "It differs in no respect from venous blood taken out of any other part of the portal system. I have found it fluid or coagulated, as in other parts of the venous system; and I have frequently pulled out from the splenic vein colourless coagula. Occasionally a number of globules may be distinguished in it, resembling those found in the parenchyma; but in these cases the organ appears to have suffered injury, and these matters appear to have got into the cells and vein in consequence." Loc. cit.

characteristic of the lymph and abundant in the lymphatic glands. The remaining fibrous substance consists entirely of capillary blood-vessels and lymphatics, with minute corpuscles, much smaller than blood-corpuscles, varying in size from about 1-6000th to 1-7000th of an inch, of spherical form, and usually corrugated on the surface. These lie in great numbers in the meshes of the sanguiferous capillaries; and the minute lymphatics are described by Dr. E. as connected with the splenic corpuscles, and apparently arising from them.—Lying in the midst of the parenchyma are found a large number of bodies, of about a third of a line in diameter, which are evidently in close connection with the vascular system; these have long been known as the Malpighian bodies of the spleen, after the name of their discoverer; but since his time, their existence has been denied, or other appearances have been mistaken for them. According to Dr. E., they in all respects resemble the mesenteric or lymphatic glands in miniature,—consisting as they do of convoluted masses of blood-vessels and lymphatics, united together by elastic tissue, so as to possess considerable firmness: and they further correspond with them in this,—that the lymph they contain, which was quite transparent in their afferent lymphatics, now becomes somewhat milky, from containing a large number of Lymph-globules.

684. In regard to the functions of the Spleen, great uncertainty exists. It appears from the foregoing account of its structure, that it may be regarded as an organ of duplex character, and probably of double function. The *cellated structure* may be considered as a multilocular reservoir, capable of great distention, and lined with a continuation of the inner membrane of the vein; receiving blood, on the one hand, from the veins of the interior of the organ, and transmitting it onward to the Vena Portæ; and on the other hand, acting as a reservoir for the venous blood of the abdomen, when, from any cause, its passage into the Vena Cava is obstructed. The *splenic parenchyma*, on the other hand, must be regarded as a complex Lymphatic tissue, essentially resembling that of the lymphatic glands, but differently arranged. In those animals in which it predominates, as in Man, the artery is large; on the other hand, where the cellated structure is most developed, as in the Herbivora, the Vein is very large, and the artery comparatively small.—Nothing completely analogous to a Spleen is found in Invertebrated animals; and from the absence of the Lymphatic system in them, it is evident that the *parenchymatous* portion can have no existence as such. Something analogous to the *cellated* portion of the Spleen, however, exists in the venous system of many Cephalopoda; and this circumstance is an additional proof of the *duplicity* of the character of this remarkable organ.

685. Out of the numberless theories of its operation, which have been at different times brought forwards, the one which seems best to account for its *cellated* structure, is that which regards it as a sort of *diverticulum* or reservoir; which may serve to relieve the Portal Venous system from undue distention, under a great variety of circumstances. This system is well known to be destitute of valves; so that the Splenic vein has free communication with the whole of it. Hence the Spleen will be a ready diverticulum for the venous blood, when the secreting action of the Liver is feeble, so that the Portal circulation receives a partial check (§ 832). That any cause of congestion of the Portal system peculiarly affects the Spleen, has been proved by experiment; for after the Portal Vein has been tied, the Spleen of an animal, which previously weighed only 2 ounces, has been found to weigh a pound and a quarter, or ten times as much. Now it is evident that congestion of the Portal system is liable to occur, when the alimentary canal is distended with food; and this from two causes,—the pressure on the Intestinal veins, and the quantity of fluid absorbed by these veins. Hence it may be conceived, that the Spleen, by affording a reservoir into which the superfluous Venous blood may be directed, serves an important purpose in preventing congestion of other organs. From the observations of Mr. Dobson,* it appears that the

* London Med. and Phys. Journal, Oct. 1820.

Spleen has its maximum volume, at the time when the process of chymification is at an end,—namely, about five hours after food is taken; and that it is small and contains little blood seven hours later, when no food has been taken in the interval. Hence he inferred, that this organ is the receptacle for the increased quantity of Blood, which the system acquires from the food, and which cannot, without danger, be admitted into the blood-vessels generally; and that it regains its previous dimensions, after the volume of the circulating fluid has been reduced by secretion. This view is confirmed by the fact noticed by several observers,—that the Spleen rapidly increases in bulk after the ingestion of a large quantity of fluid, which is absorbed rather by the Veins than by the Lacteals. It has been further stated in support of this theory, that animals from which the Spleen has been removed, are very liable to die of apoplexy, if they take a large quantity of food at a time; but that, if they eat moderately and frequently, they do not suffer in this manner. The use of the Spleen as a diverticulum for the internal Venous circulation, is further borne out by its liability to become enlarged in consequence of intermittent fever; during the cold stage of which, a great quantity of blood is driven from the surface towards the internal organs; and it may be easily imagined that, if there were no such reservoir, the congestions in these would be much more dangerous than those which actually do occur. The permanent enlargement of the organ is of course, on this idea of its use, a result of its frequent distention. But besides this safety-valve function, there can be little doubt that the Spleen performs another, in virtue of the *parenchymatous* portion of its structure; and that this function corresponds with that of the Absorbent Glands in general. The identity in structure between its Malpighian bodies and the ordinary Lymphatic glands, is such as clearly points to this inference; which is confirmed by the remarkable fact, determined by the recent experiments of Prof. Mayer, that, after the Spleen has been extirpated, the lymphatic glands of the neighbourhood increase in size, and cluster together as they enlarge, so as to form an organ which at least equals the original spleen in volume.* This circumstance explains the reason of the almost invariable *negative* result of the extirpation of the Spleen; for although the operation has been frequently practised, with the view of determining the functions of the organ by the symptoms presented by animals after its removal, no decided change in the ordinary course of their vital phenomena has ever been observed; and the health, if at all disturbed for a time, is afterwards regained. Now if the functions of the Spleen,—putting aside the safety-valve action of its distensible cavities,—be the same with that of the Lymphatic Glands in general, it is easy to understand, how its loss may be at once compensated by an increased action on their part, and how it may be permanently replaced by an increased development of some of those bodies.—Thus, then, we may fairly regard the Spleen as concurring in function with the glands of the Absorbent system, in the Assimilating process, by which the crude nutritive materials are rendered fit to circulate through the system; the difference between them appearing to be chiefly this,—that, whilst the latter operate upon the nutritive substances taken up by the Lacteals, the Spleen exerts its influence upon those which have been received into the Veins; separating them from the mass of the blood, and delivering them to the lymphatic system to be further elaborated.

686. The *Supra-Renal Capsules* seem to correspond with the Spleen in their general structure, and in their connection with the Lymphatic system; whilst, in the arrangement of their component parts, they bear more resemblance to the Kidney.

* Medical Times, March 29, 1845.

a. In the Supra-Renal Capsules, as in the Kidneys, there is an obvious difference between the *cortical* and the *medullary* substances. The former is of a yellowish colour; and presents an appearance, when cut into, as if it were made up of straight parallel fibres, arranged side by side. Of these straight fibres, however, a part are branches of arteries, which enter this body at every point of its exterior, from a capillary network covering its surface; and others are corresponding branches of veins, that receive the blood from these arteries, and convey it into a venous plexus which forms the centre of the organ. Between the radiating blood-vessels, there are found lying, in the cortical substance, numerous parallel cylinders or elongated cones, formed by closed sacs of basement-membrane, including nuclei and cells in various stages of development, with fat-cells.—The *medullary* substance is partly made up of the venous plexus, dilated into a sort of cavernous texture, together with empty cavities or lacunae, that seem destitute of a lining membrane, and contain only a thick grayish-white fluid; and partly of an intervening parenchyma, consisting of cells in various stages of development. In the Human adult, there is a great predominance of nuclei, which seem as if they did not attain their full development; but in Ruminant animals, and in the Human subject in early life, the cells are more or less developed, and then resemble the ordinary lymph-corpuscles in size and appearance. The Lymphatics are of large size, like those of the Spleen; and probably convey away the matter which has been elaborated by these organs, that it may be mingled with that which is being taken up and prepared by other parts of the Absorbent system. The Supra-Renal capsules attain a very large size early in fetal life, surpassing the true Kidneys in dimension, up to the tenth or twelfth week: but they afterwards diminish relatively to the latter, and are evidently subordinate organs during the whole remainder of life.

It does not seem unlikely that these bodies, like the Spleen, have a double function; and that, besides participating in the general actions of the Absorbent glandular, they may serve as a diverticulum for the Renal circulation, when from any cause the secreting function of the Kidneys is retarded or checked, and the movement of blood through them is stagnated.

687. The *Thymus Gland* is another body which seems referrible to the same group; having all the essential characters of a true gland, save an excretory duct; and its function being evidently connected, during the early period of life at least, with the elaboration of nutritive matter, which is to be re-introduced into the circulating current.

a. Its elementary structure may be best understood from the simple form it presents when it is first capable of being distinguished in the embryo. It then consists of a single tube, closed at both ends, and filled with granular matter; and its subsequent development consists

[Fig. 209.]

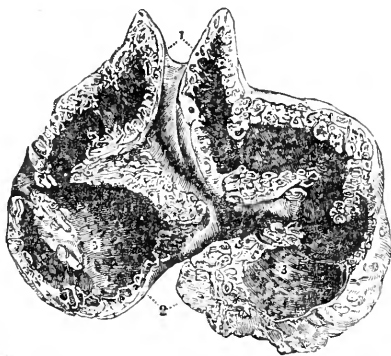

A section of the Thymus gland at the eighth month, showing its anatomy; from a preparation of Sir A. Cooper's; 1, the cervical portions of the gland; the independence of the two lateral glands is well marked; 2, secretory follicles seen upon the surface of the section; these are observed in all parts of the section; 3, 3, the pores or openings of the secretory follicles and pouches; they are seen covering the whole internal surface of the great central cavity or reservoir. The continuity of the reservoir in the lower or thoracic portion of the gland with the cervical portion, is seen in the figure.]

in the lateral growth of branching off-shoots from this central tubular axis. In its mature state, therefore, it consists of an assemblage of glandular follicles, which are surrounded by a plexus of blood-vessels; and these follicles all communicate with the central reservoir, from which, however, there is no outlet. The Lymphatics are large, and communicate directly with the Vena Cava; but their immediate connection with the cavity of the Thymus body has not yet been demonstrated. The cavities of the follicles contain a fluid in which a number of corpuscles are found, giving it a granular appearance. These corpuscles are, for the most part, in the condition of *nuclei*; but fully developed cells are found among them, at the period when the function of this body seems most active. The chemical nature of the contents at this period, closely resembles that of the ordinary proteine-compounds.—It has been commonly stated, that the Thymus attains its greatest development, in relation to the rest of the body, during the latter part of fœtal life; and it has been considered as an organ peculiarly connected with the embryonic condition. But this is a mistake; for the greatest activity in the growth of this organ manifests itself in the Human infant, soon after birth; and it is then, too, that its functional energy seems the greatest. This rapid state of growth, however, soon subsides into one of less activity, which merely serves to keep up its proportion to the rest of the body; and its increase usually ceases altogether at the age of about two years. From that time, during a variable number of years, it remains stationary in point of size; but, if the individual be adequately nourished, it gradually assumes the character of a mass of fat, by the development of the corpuscles of its interior into fat-cells, which secrete adipose matter from the blood. This change in its function is most remarkable in hibernating Mammals; in which the development of the organ continues, even in an increasing ratio, until the animal reaches adult age, when it includes a large quantity of fatty matter. The same is the case, generally speaking, among Reptiles. It is an important fact in the history of this organ, that it is not to be detected in Fishes; and does not appear to exist, either in the tadpole state of the Batrachian reptiles, or in the Perennibranchiate group; so that we may regard it as essentially connected with pulmonic respiration.*

688. Various facts lead to the conclusion, that the function of the Thymus, at the period of its highest development, is that of elaborating and storing up nutritive materials, to supply the demand which is peculiarly active during the early period of extra-uterine life. The elaborating action probably corresponds with that which is exerted by the glands of the Absorbent system; and the product, as in the preceding cases, seems to be conveyed away by the lymphatics. The provision of a store of nutritive matter seems a most valuable one, under the circumstances in which it is met with; the waste being more rapid and variable than in adults, and the supply not constant. Thus it has been noticed that, in over-driven lambs, the thymus soon shrinks remarkably; but that it becomes as quickly distended again, during rest and plentiful nourishment. As the demand becomes less energetic, and as the supplies furnished by other organs become more adequate to meet it, the Thymus diminishes in size, and no longer performs the same function. It then obviously serves to provide a store of material, not for the nutrition of the body, but for the respiratory process, when this has to be carried on for long periods—as in hibernating Mammals and in Reptiles—without a fresh supply of food.—It is possible, that the Thymus gland may further stand in the same relation to the Lungs, as the Spleen to the Liver, and the Supra-Renal capsules to the Kidneys; that is, as a *diverticulum* for the blood transmitted through the bronchial arteries (which are the nutritive vessels of the Lungs), before the Lungs acquire their full development in comparison with other organs, or when any cause subsequently obstructs the circulation through their capillaries.

689. The *Thyroid* Gland bears a general analogy to the Thymus; but its vesicles are distinct from each other, and do not communicate with any common reservoir. They are surrounded, like the vesicles of the true glands, with a minute capillary plexus; and in the fluid they contain, numerous corpuscles are found suspended, which appear to be cell-nuclei, in a state of more or less advanced development. This body is supplied with arteries of considerable size; and with peculiarly large lymphatics. Though propor-

* See Mr. Simon's admirable Prize Essay on the Thymus Gland.

tionably larger in the fœtus than in the adult, it remains of considerable size during the whole of life. It appears, from the recent inquiries of Mr. Simon,* that a Thyroid gland, or some organ representing it in place and office, exists in all Vertebrated animals. It presents its simplest form in the class of Fishes; in some of which it appears to consist merely of a plexus of capillary vessels, connected with the origin of the cerebral vessels, and capable, by its distensibility, of relieving the latter, in case of any obstruction to the proper movement of blood through them. In the higher forms of this organ, the glandular structure,—consisting of closed vesicles over which the capillary plexus is distributed, and of their cellular contents,—is superadded; and the organ then appears, like the Spleen, to be destined for two different uses; namely, to serve as a *diverticulum* to the Cerebral circulation; and to aid in the elaboration of nutritive matter, which is taken up by the Absorbent system, and which is again poured by it into the general current of the circulation.

690. Thus the Spleen, the Supra-Renal Capsules, the Thymus Gland, and the Thyroid Gland, all seem to share in the preparation of the nutritive materials of the blood, along with the ordinary glandulæ of the Absorbent system. In fact, we may regard them all as together constituting an apparatus, which is precisely analogous to that of the ordinary glands, but of which the elementary parts are scattered through the body, instead of being collected into one compact structure. Thus if we could imagine any tubular gland, such as the Kidney or the Testis, to be unravelled, and its convoluted tubuli to be spread through the system, yet all discharging their contents by a common outlet, we should have no unapt representation of the Lymphatic portion of the Absorbent system. Its function appears to be, to separate the crude Albuminous matter from the blood, to subject it to an elaborating action performed by the epithelium-cells lining the tubes, and then to pour forth this elaborated product,—not as an excretion to be carried out of the body,—but (in conjunction with that, which has been newly taken in by the Lacteal portion of the system, and which has undergone elaboration by *its* glandulæ), into the blood-vessels, which are to convey it to the different parts of the body where it is to be appropriated. The four bodies we have been just considering, appear to be, so far as their glandular function is concerned, appendages to this system. Their uses as *diverticula* to the circulation through other organs, render them liable to occasional distention with blood; and it seems determined that this blood shall not lie useless, but shall be subservient to the action in question; the gland-cells that line the cavities of the organ withdrawing certain constituents of the blood, to restore them, through the Lymphatic system, in a state of more complete preparation for the operations of Nutrition. Their function is very probably *vicarious*; that is, the determination of blood is greatest (through the state of the other organs) at one time to one of these bodies, and at another time to another. Hence the effects of the loss of any one of them are not serious; as the others are enabled in great degree to discharge its duty.

4.—*Composition and Properties of the Chyle and Lymph.*

691. The chief chemical difference between the Chyle and the Lymph, consists in the much smaller proportion of solid matter in the latter, and in the almost entire absence of fat, which is an important constituent of the former. This is well shown in the following comparative analyses, performed by Dr. G. O. Rees, of the fluids obtained from the lacteal and lymphatic vessels of a

* Philosophical Transactions, 1844.

donkey, previously to their entrance into the thoracic duct: the animal having had a full meal seven hours before its death.

	CHYLE.	LYMPH.
Water	90.237	95.536
Albuminous matter (coagulable by heat)	3.516	1.200
Fibrinous matter (spontaneously coagulable)	0.370	0.120
Animal extractive matter, soluble in water and alcohol	0.332	0.240
Animal extractive matter, soluble in water only	1.233	1.319
Fatty matter	3.601	a trace.
Salts;—Alkaline chloride, sulphate and carbonate, with traces of alkaline phosphate, oxide of iron	0.711	0.585
	<hr/> 100.000	<hr/> 100.000

The Lymph obtained from the neck of a horse has been recently analyzed by Nasse, with nearly the same result. He found it to contain 95 per cent. of water; and the 5 per cent. of solid matter was chiefly composed of albumen and fibrine, with watery extractive,—scarcely a trace of fat being to be found. The proportions of saline matter were found to be remarkably coincident with those which exist in the serum of the blood; as might be expected from the fact, that the fluid portion of the lymph must have its origin in that which has transuded through the blood-vessels: the absolute quantity, however, is rather less.—A similar analysis of the Chyle of a cat by Nasse, has given results very closely correspondent with that of Dr. Rees; for the proportion of water was 90.5 per cent.; and of the 9.5 parts of solid matter, the albumen, fibrine, and extractive amounted to more than 5, and the fat to more than 3 parts.—Dr. Rees has also analyzed the fluid of the Thoracic duct of Man; and found it to consist of 90.48 per cent. of water, 7.08 parts of albumen and fibrine, 1.08 parts of aqueous and alcoholic extractive, and 0.92 of fatty matter, with 0.44 per cent. of salines. Thus the composition of this fluid would seem to resemble that of the Lymph, rather than that of the Chyle; the proportion of the fatty to that of the albuminous matter being very small. This, however, might have been very probably due to the circumstance, that the subject from which the fluid was obtained (an executed criminal) had eaten but little for some hours before his death.

692. The characters of the Chyle drawn from the larger absorbent trunks, near their entrance into the Receptaculum Chyli, are very different, however, from those of the fluid as first absorbed into the Lacteals; for during its passage through these vessels, and their ganglia or glands, it undergoes important alterations, which gradually assimilate it to Blood. The chyle drawn from the lacteals that traverse the intestinal walls, contains Albumen in a state of complete solution; but it is generally destitute of the power of coagulation, no Fibrine being present in it. The Salts, also, are completely dissolved; but the Oily matter presents itself in the form of globules of variable size.* It is generally supposed, that the milky colour of the chyle is owing to these; but Mr. Gulliver has recently pointed out that it is really due to an immense multitude of far more minute particles, which he describes as forming the *molecular base* of the chyle. These molecules are most abundant in rich, milky, opaque chyle; and in poorer chyle, which is semi-transparent or opaline, the particles float thinly or separately in the transparent fluid, and often exhibit the vivid motions common to the most minute molecules of various substances. Such is their minuteness, that, even with the best instru-

* These oily globules are more abundant in the Chyle of Man and of the Carnivora, than in that of the Herbivora: their diameter has been observed to vary from 1-25,000th to 1-2000th of an inch.

† Dublin Medical Press, Jan. 1, 1840, and Gerber's General Anatomy, Appendix, p. 88.

ments, it is impossible to form an exact appreciation either of their form or their dimensions. They seem, however, to be generally spherical; and their diameter may be estimated at between 1-36,000th and 1-24,000th of an inch. Their chemical nature is as yet uncertain: they are remarkable for their unchangeableness, when subjected to the action of numerous re-agents; which quickly affect the proper Chyle-corpuses; and they are readily soluble in Ether, the addition of which causes the whole molecular base instantly to disappear, not a particle of it remaining; whence it may be inferred that they consist of oily or fatty matter. The milky colour, which the serum of blood sometimes exhibits, is due to an admixture of this molecular base with the circulating fluid; it is most common in young animals that are suckling; but it is not uncommon in adults, and is not to be attributed to an absorption of milk into the chyle, as the physical properties of the two are quite different. (See § 697, *e*.)

693. During the passage of the Chyle through the absorbents on the intestinal edge of the Mesentery, towards the Mesenteric Glands, its character changes in several important particulars. The presence of Fibrine begins to manifest itself, by the slight coagulability of the fluid when withdrawn from the vessels; and while this ingredient increases, the Albumen and the Oil-globules gradually diminish in amount. The Chyle drawn from the neighbourhood of the mesenteric glands exhibits the Corpuses regarded as characteristic of that fluid; these are peculiarly abundant in the fluid drawn from the glands themselves; and they are constantly found in it, through its whole subsequent course. The Chyle-corpuses are much larger than the molecules just described, and an examination of their character presents no difficulty. Their diameter varies from 1-7110th to 1-2600th of an inch; the average being about 1-4600th. They are usually minutely granulated on the surface, seldom exhibiting any nuclei, even when treated with acetic acid; but sometimes three or four central particles may be distinguished within them.—During the passage of the Chyle through the mesenteric glands, a further increase in the proportion of Fibrine takes place; and the resemblance of the fluid to Blood becomes more apparent. The Chyle drawn from the vessels intermediate between these and the central duct, possesses a pale reddish-yellow colour; and, when allowed to stand for a time, undergoes a regular coagulation, separating into *clot* and *serum*. The former is a consistent gelatinous mass, which, when examined with the microscope, is found to include the Chyle-corpuses, each of them being surrounded by a delicate film of oil: the Fibrine of which it is principally composed, differs remarkably from that of the blood, in its inferior tendency to putrefaction; whence it may be inferred that it has not yet undergone its complete vitalization. The serum contains the Albumen and Salts in solution, and a proportion of the Chyle-corpuses suspended in it. It is curious, however, that considerable differences in the perfection of the coagulation, and in its duration, should present themselves in different experiments. Sometimes the chyle sets into a jelly-like mass, which, without any separation into coagulum and serum, liquefies again at the end of half an hour, and remains in this state. This change takes place in the true coagulum also, if it be kept moist for a sufficient length of time. The Chyle from the Receptaculum and Thoracic Duct coagulates quickly, often almost instantaneously; and few or none of the corpuses remain in the serum.—It is to be remembered that the Lacteals are the Lymphatics of the intestinal walls and mesentery; performing that function of Interstitial Absorption which is elsewhere accomplished by vessels that are not concerned in the introduction of alimentary substances from without. During the intervals of digestion, they contain a fluid which is in all respects conformable to the Lymph of the Lymphatic trunks.

a. The fluid drawn from the Thoracic Duct, and from the Absorbent vessels which empty their contents into it, is frequently observed to present a decided red tinge, which increases on exposure to the air. This tinge is due to the presence of true Blood-corpuscles; but these are somewhat modified in form and size, being a little smaller than the ordinary Blood-discs, and frequently angular, granulated, or indented at the edges. By Mr. Lane* it is stated that this intermixture is accidental; and that it results from the absorption of Blood-particles into the Lymphatics, at the points where the latter are divided, in making the sections necessary to expose the centres of the Absorbent system; and he mentions a striking fact in illustration of his view. He considers that the alteration in the character of the corpuscles is due to the action of the Chyle on the Blood, since many other fluids will produce analogous effects; and he states that, shortly after a flow of chyle into the blood, a large number of such altered discs may be seen in the circulating fluid. On the other hand, Mr. Gulliver and several eminent observers, regard these blood-discs as true constituents of the fluid of the absorbents; and suppose that they are in process of formation. Reasons have been given, however, for the belief, that the *red* Blood-discs are not formed from the Chyle-corpuscles; so that Mr. Lane's view is probably the correct one. Even if the Blood-discs are not introduced into the Lymphatics during the operation of exposing the Thoracic Duct, it may not be considered as improbable that, in those animals in which the Lymphatics have several communications with the veins, they should naturally obtain an entrance in various parts of the system. Such communications, according to Gerber, decidedly exist in the Horse; and it is in the Chyle of that animal, that the rosy tint, and the Blood-corpuscles which occasion it, have been chiefly observed.—The following table, slightly modified from that of Gerber, presents in a concise form, a view of the relative proportions of the three chief ingredients in the Chyle, in different parts of the absorbent system, and thus gives an idea of its advance in the process of assimilation.

In the afferent or peripheral Lacteals (from the Intestines to the Mesenteric glands).	{ Fat, in maximum quantity (numerous fat or oil globules). Albumen in minimum quantity. Few or no Chyle-corpuscles. Fibrine almost entire wanting.
In the efferent or central Lacteals (from the Mesenteric glands to the Thoracic Duct).	{ Fat, in medium quantity (fewer oil globules). Albumen, in maximum quantity. Chyle-corpuscles very numerous, but imperfectly developed. Fibrine in medium quantity.
In the Thoracic Duct.	{ Fat, in minimum quantity (fewer or no oil-globules). Albumen, in medium quantity. Chyle-corpuscles numerous, and more distinctly cellular. Fibrine in maximum quantity.

694. The aspect of the *Lymph* greatly differs from that of the Chyle, the former being nearly transparent, whilst the latter is opaque or opalescent; and this difference is readily accounted for, when the assistance of the microscope is sought, by the entire absence from the Lymph of that molecular base which is so abundant in the Chyle. A considerable number of corpuscles are generally present in it; and these seem to correspond in all respects with the *white* or colourless corpuscles of the Blood (§ 151). Their amount, however, is extremely variable; as is also that of the oil-globules, which sometimes occur, whilst in other instances none can be discovered. Lymph coagulates like chyle; a colourless clot being formed, which incloses the greater part of the corpuscles.

695. The fluid drawn from the Thoracic Duct, consisting as it does of an admixture of Chyle and Lymph, will probably vary in its character and composition, according to the predominance of the former, or of the latter, of these fluids. It may be noticed, however, that the floating corpuscles have a more distinctly *cellular* character than have those of the chyle and lymph; and that they are of larger size, their diameter usually ranging from about 1-2600th to 1-2900th of an inch. In these particulars, they correspond with the Colourless corpuscles of the Blood; as also in the change they exhibit on the action of acetic acid, which brings into view three or four large central particles. Some observations have been recently made by Bidder, on the amount of

* Cyclopædia of Anatomy and Physiology, vol. iii. p. 220.

liquid which flows through the Thoracic duct into the venous system; and if any inference can be fairly drawn from the measurement of the quantity delivered in the course of a few minutes, it would appear that the total amount thus transmitted in one day is nearly or quite equal to the entire mass of the blood. At any rate, it so far exceeds the amount of liquid ingested, that we must believe a large portion of it to be derived from the circulating current,—having been withdrawn from it for a time, to be again delivered into its stream, after having undergone the requisite elaboration.

5.—Physical and Vital Properties of the Blood.

696. Having now traced the steps, by which the Blood is elaborated and prepared for circulation through the body, and having formerly inquired into the characters of its chief constituents (Chap. III.), we have now to consider the fluid as a whole, to study the usual proportions of these constituents, and the properties which they impart to it.—The Blood, whilst circulating in the living vessels, may be seen to consist of a transparent, nearly colourless, liquid, termed *Liquor sanguinis*; in which the *Red Corpuscles*, from which the Blood of Vertebrated animals derives its peculiar hue, as well as the *White* or *Colourless* corpuscles, are freely suspended and carried along by the current.—On the other hand, when the Blood has been drawn from the body, and is allowed to remain at rest, a spontaneous coagulation takes place, separating it into *Crassamentum* and *Serum*. The Crassamentum or Clot is composed of a network of Fibrine, in the meshes of which the Corpuscles, both red and colourless, are involved, together with a certain amount of serous fluid: The Serum, which is the same with the Liquor Sanguinis deprived of its Fibrine, coagulates by heat, and is therefore known to contain Albumen; and if it be exposed to a high temperature, sufficient to decompose the animal matter, a considerable amount of earthy and alkaline Salts remains.—Thus we have four principal components in the Blood; namely, *Fibrine*, *Albumen*, *Corpuscles*, and *Saline matter*. In the *circulating* blood, they are thus combined:—

Fibrine	}	In solution, forming Liquor Sanguinis.
Albumen		
Salts		
Corpuscles,—suspended in Liquor Sanguinis.		

But in coagulated blood, they are combined as follows:—

Fibrine	}	Crassamentum or Clot.
Corpuscles		
Albumen	}	Remaining in solution, forming Serum.
Salts		

In the blood of Man and the higher Vertebrata, the Colourless Corpuscles usually bear so small a proportion to the Red, that they have until recently escaped notice. In Reptiles, however, they attract attention, from their marked difference in size and form, even whilst the blood is moving through the capillaries; and they are the more easily watched, owing to the comparatively small number of the Red Corpuscles in those animals. The blood of the Invertebrata is usually pale, and contains very few red corpuscles; indeed they would seem to be absent altogether in the lower Articulata and Mollusca. On the other hand, the colourless corpuscles are frequently very numerous, especially during the periods of most active growth. The blood of these animals may be likened, therefore, in many respects to the Lymph and Chyle of the Vertebrata; and the resemblance is the more close, as there is no

distinction among the Invertebrata between the *absorbent* and *sanguiferous* vessels.

697. The proportion of the several components of Blood is subject to considerable variations, within the limits of health. Some of these variations may be habitual, depending upon the constitution of the individual, his diet, mode of life, &c.; whilst others are probably referrible to the period at which the last meal was taken, and the amount of bodily exertion made within a short time previous to the analysis.

a. The discordance in the results obtained by different experimenters is doubtless owing in part to the diversity in their methods of analysis;* but even where the same method is employed, a wide diversity is apparent; as in the analysis of MM. Becquerel and Rodier. As there is a tolerably constant difference between the Male and the Female, it will be desirable to class them separately; and the results of some of the most recent and trustworthy analyses of each will be brought together for the sake of comparison.—The analyses of M. Lecanu were made on the blood of two stout and healthy men; whilst those of MM. Becquerel and Rodier give the maximum, minimum, and mean amount, of each ingredient in the blood of eleven healthy men, between the ages of 21 and 66 years.

	<i>Lecanu.</i>		<i>MM. Becquerel and Rodier.</i>			<i>Simon.</i>	<i>Nasse.</i>
	I.	II.	Mean.	Maxima.	Minima.		
Water	780.2	785.6	779.0	800.0	760.0	791.9	798.4
Fibrine	2.1	3.6	2.2	3.5	1.5	2.0	2.3
Corpuscles	133.0	119.6	141.1	152.0	131.0	114.3	116.5
Albumen	66.3	71.5	69.4	73.0	62.0	75.6	74.2
Extractive mat- ters, Salts, and loss	14.6	13.1	6.8	8.0	5.0	14.2	6.6
Fatty matters							
	1000.0	1000.0	1000.0			1000.0	1000.0

The following table gives the results of similar analyses on the blood of Females; those of MM. Becquerel and Rodier being made upon eight healthy subjects between the ages of 22 and 58 years.

	<i>MM. Becquerel and Rodier.</i>			<i>Simon.</i>
	Mean.	Maxima.	Minima.	
Water	791.1	813.0	773.0	801.4
Fibrine	2.2	2.5	1.8	2.2
Corpuscles	127.2	137.5	113.0	106.1
Albumen	70.5	75.5	65.0	77.6
Extractive matters and Salts	7.4	8.5	6.2	10.0
Fatty matters	1.6	2.9	1.0	2.7
	1000.0			1000.0

b. Of the *Fatty* matters of the Blood, a portion seems to correspond with the constituents of ordinary Fat; another portion seems identical with the *Cholesterine*, or Biliary Fat; whilst another contains Phosphorus, and seems allied to the fatty acids of Nervous matter (§ 249).

c. Of the nature of the substances classed under the head of *Extractive*, very little is known. It has been lately asserted, that a portion of them consists of binoxide of proteine (§ 116, a); but as to the actual existence of this substance, there is still much doubt. Under the general designation of extractive are arranged the "ill-defined animal principles," which may include various substances in a state of change or disintegration, that are being eliminated from the blood by the processes of Excretion.

d. The *Saline* constituents of the Blood, obtained by drying and incinerating the whole mass, usually amount to between 6 and 7 parts in 1000. More than half their total quantity is composed of the Chlorides of Sodium and Potassium; and the remainder is made up of the tribasic Phosphate of Soda, the Phosphates of Lime and Magnesia, Sulphate of Soda,

* Thus the small amount of Salts, in the analysis of Nasse and of MM. Becquerel and Rodier, as compared with those of MM. Lecanu and Simon, appears due to the fact that the former express only the *free* salts, whilst the latter include those which are in combination with the organic constituents.

and a little Phosphate and Oxide of Iron. Of these, the chief part are dissolved in the Serum; but the Earthy Phosphates, which are insoluble by themselves, are probably combined with the Proteine-compounds (§ 113); and the iron is contained, chiefly or entirely, in the red corpuscles.—It is difficult to speak with certainty, from the examination of the *ashes* of the blood, as to the state of the Saline constituents of the circulating *fluid*. Thus the Serum has an alkaline reaction; and this has been supposed to be due to the presence of alkaline Carbonates. Moreover the presence of the Lactates of potass and soda has been usually asserted. On the other hand, the recent analyses of Enderliu, which have been confirmed by Liebig, would indicate that the alkaline reaction is entirely due to the presence of the tribasic Phosphate of soda; and that no alkaline carbonates or lactates exist in the blood. This discrepancy seems partly due to the mode of analysis employed; for it has been lately pointed out by Dr. G. O. Rees,* that although the ashes of the *entire mass* of blood do not effervesce on the addition of an acid, effervescence takes place when acid is added to the ashes of the *serum*, showing the existence in it, either of alkaline Carbonates, or of Lactates, which have been reduced to the state of Carbonates by incineration.—It appears that, when the entire mass of blood is incinerated, enough phosphoric acid is produced from the phosphorized fats, to neutralize the alkaline carbonates, and thus to prevent their presence from being recognized. There can be no doubt, however, that the tribasic Phosphate of Soda exists as such in the blood, and contributes to its alkaline reaction; and it appears to confer upon the liquid a special power of absorbing Carbonic Acid.

e. Some very interesting observations upon the state of the blood soon after a meal, have been recently made by Drs. Buchanan and R. D. Thompson. They are confirmatory of the belief generally entertained, that the *milky* appearance, sometimes presented by the *Serum*, is due to the admixture of Chyle. When a full meal containing oily matter is taken after a long fast, and a small quantity of blood is drawn previously to the meal and at intervals subsequently, the Serum, though quite limpid in the blood first drawn, shows an incipient turbidity about half an hour afterwards; this turbidity increases for about six hours subsequently, after which it usually begins to disappear. The period at which the discoloration is the greatest, however, and the length of time during which it continues, vary according to the kind and quality of the food, and the state of the digestive functions. Neither starch, nor sugar, nor proteine-compounds, alone or combined, occasion this opacity in the chyle; but it seems entirely dependent upon an admixture of oleaginous matter with the food. There are few ordinary meals, however, from which such matter is altogether excluded. When such milky serum is examined with the Microscope, the opacity is found to be due to the presence of an immense number of exceedingly minute granules, resembling in appearance those which form the “molecular base” of the chyle. They seem to be composed of two chemically-distinct substances; for when the milky serum is agitated with ether, a part is dissolved, whilst another portion remains suspended; and this latter is soluble in caustic potass. The former, therefore, appears to be identical with the “molecular base” of the Chyle, and to be of an oily or fatty nature; whilst the latter belongs to the proteine-compounds. The Crassamentum of such blood often exhibits a pellucid fibrinous crust, sometimes interspersed with white dots; and this seems to consist of an imperfectly-assimilated proteine-compound, analogous to that found in the serum. The quantity of this varies according to the amount of the proteine-compounds present in the food.†—It is evident from these experiments, that the assimilating process is by no means completed, at the time of the passage of the Chyle into the Blood; and it would seem that the return of the transparency of the serum is due to the gradual removal of the superfluous fatty matter through the respiratory process, whilst the proteine-compound, of which part of the granules are composed, is gradually reduced to a state of perfect solution.

f. The occasional presence of *Sugar*, even in healthy blood, when a large quantity of saccharine matter exists in the food, appears to be now well established. But it seems to be commonly transformed, either into lactic acid, or into fatty matter, previously to its reception into the circulating current. This last transformation is partly effected through the agency of the Bile; as will be shown hereafter (§ 835).

698. It cannot be doubted that, upon the due admixture in the Blood of all these elements, the regular performance of its actions is dependent. In regard to its *physical* properties merely, it is easily shown that a slight alteration may produce the most injurious consequences; for a certain degree of viscosity has been found (by the experiments of Pousseuille) to favour the passage of fluid through capillary tubes; and thus, if the viscosity of the blood be diminished by a loss of part of its fibrine, stagnation of the current, and extravasation of a

* On the Analysis of the Blood and Urine, p. 30.

† Medical Gazette, Oct. 10, 1845.

portion of the contents of the vessels, will be the result. This has been fully proved by the numerous experiments of Magendie; and the fact is one of very important Pathological applications (§ 707, *b*). But the *vital* properties of the fluid are still more immediately dependent upon the *Fibrine* it contains; since, as we have seen reason to believe, it is the material which is most completely prepared for organization, and which supplies what is requisite for the nutrition of the larger proportion of the solid tissues of the body. It is, therefore, continually being withdrawn from the blood by the nutritive operations; and the demand appears to be supplied, in part by the influx of *Fibrine* that has been prepared in the Absorbent system, and in part by the continued transformation of *Albumen*, which takes place during the circulation of the Blood, and of which we have seen reason to believe that the Colourless Corpuscles are the instruments (§§ 153—159).—The *Albumen* of the Blood is the raw material, at the expense of which not only the *Fibrine*, but many other substances, are generated during the nutritive process. All the Albuminous compounds of the Secretions, the Horny matter of the Epidermic tissues, the Gelatine of the simple Fibrous tissues, and the *Hæmatine* of the Red Corpuscles, may be regarded as almost certainly produced by the transformation of the *Albumen* of the Blood; and a continual supply of this from the food is therefore requisite to preserve the due proportion in the circulating fluid.—The *Red Corpuscles* appear to be more connected with the function of Respiration than with that of Nutrition (§ 150); and the stimulating action of Arterial blood, especially upon the Nervous and Muscular tissues, appears to depend upon their presence. It is by no means impossible that their peculiar connection with the activity of the latter may be dependent upon an actual Chemical relation between their contents and the red matter of the Ganglionic corpuscles (§ 245); and that a part of their function may be, to prepare the substance which is afterwards to be appropriated as a peculiar nutritive principle, by the active instruments of Nervous operations. It appears from the experiments of Dieffenbach on transfusion, that the Red Corpuscles are more effectual as stimuli to the Heart's action, than is any other constituent of the blood. The rapidity with which they may be decomposed and reconstituted, is made remarkably evident by the experiments of Magendie; who found that, when the Blood of one animal was injected into the veins of another having discs of very different size and form (care being taken to prevent the coagulation of the *Fibrine* during the operation), the original Red particles soon disappeared, and were replaced by those characteristic of the species, in whose veins the fluid was circulating.—The use of the *Saline* matter is evidently in part to supply the mineral materials, requisite for the generation of the tissues, and for the production of the various secretions. It is by the Saline and Albuminous matters in conjunction, that the specific gravity of the *Liquor Sanguinis* is kept up to the point, at which it is equivalent to that of the contents of the Red corpuscles; and it is only in this condition that the latter present their proper characters. Thus it has been shown by Dr. G. O. Rees, that when the quantity of water in the *Liquor Sanguinis* has been reduced by copious perspirations or other similar causes, the corpuscles are thin, and very like those whose contents have exuded by exosmose into a denser liquid around (§ 143). On the other hand, if the *Liquor Sanguinis* be diluted by the withdrawal of blood and the injection of an equivalent quantity of water, the serum speedily becomes tinged with the colouring matter of the corpuscles; apparently in consequence of a rupture of some of the cells, by endosmose from the circumambient liquid, now reduced to a lower specific gravity than that of their contents.—The *Fatty* matters of the Blood are evidently derived from the food, either directly, or by the transformation of its farinaceous ingredients; and they are chiefly appropriated to the maintenance of the com-

bustive process. That which may be superfluous, is either deposited in the cells of Adipose tissue, or it is eliminated by the Liver, the Sebaceous follicles of the Skin, and (in the nursing female) by the Mammary glands. How the peculiar Phosphorized Fats of the Blood are formed,—whether by the continuation of the azotized and phosphorized materials with ordinary fat, or by the metamorphosis of albuminous matter,—cannot be said to be yet determined.

699. When the Blood is drawn from the body, and left to itself, its organic elements speedily undergo a new arrangement. The Fibrine coagulates, and separates itself from the fluid in which it was previously dissolved; and during its coagulation it attracts the Red particles; these are included in areolæ or meshes of the Clot, the substance of which has a tendency to assume a fibrous arrangement (§ 118); and they usually group themselves together in columnar masses, resembling piles of money. The Coagulum or clot becomes dense, in proportion to the amount of the Fibrine it contains; and the Albuminous and Saline matter still dissolved in the water are separated from it, constituting the Serum. This separation will not occur, however, if the coagulation take place in a shallow vessel; nor if the amount of Fibrine should be small, or its vitality low. A homogeneous mass, deficient in firmness, presents itself under such circumstances; though the solid part of this may pass into a state of more complete condensation, after the lapse of a certain time.—That the coagulation is due to the Fibrine, and that the Red particles are merely passive in the process, appears from several considerations. A microscopical examination of the Clot shows, that it has the same texture with Fibrine, when coagulating by itself; the Corpuscles clustering together in the interspaces of the network, and not being uniformly diffused through the whole mass. Their Specific Gravity being greater than that of the Fibrine, they are usually most abundant at the lower part of the clot; and the upper surface is sometimes nearly colourless, especially when the coagulation has taken place slowly; yet this upper part is much firmer than the under, showing that the Fibrine alone is the consolidating agent.—This has been proved to demonstration by an experiment of Müller's. He placed the blood of a Frog, diluted with water (or still better with a very thin syrup) on a paper filter, of sufficiently fine texture to keep back the Corpuscles; and the Liqueur Sanguinis, having passed through the filter completely unmixed with them, presented a distinct coagulum, although from the diluted state of the fluid, this did not possess much consistency. Owing to the more minute size of the Blood-dises of warm-blooded animals, this experiment cannot be so readily performed with their blood. The sole agency of the Fibrine in coagulation is very easily proved in another way. If fresh drawn blood be continually stirred with a stick, the Fibrine will adhere to it in strings during its coagulation; and the Red particles will be left suspended in the serum, without the slightest tendency to coagulate. Moreover, if a solution of any salt, that has the property of retarding the coagulation (such as carbonate of potash or sulphate of soda), be added to the blood, the Corpuscles will have time to sink to the lower stratum of the fluid, before the clot is formed; the greater part of the Coagulum is then entirely colourless, and is found by the microscope to contain few or no red particles.

700. That the Coagulation of the Blood is not, as some have supposed, a proof of its death, but is rather an act of vitality, appears evident from what has been already stated (§ 118) of the incipient organization which may be detected even in an ordinary clot; and still more from the fact that, if the effusion of Fibrine take place upon a living surface, its coagulation is the first act of its conversion into solid tissues possessing a high degree of vitality. It is absurd to suppose that the Blood dies, in order to assume a higher form.

A complete demonstration of the truth of the Hunterian doctrine, that the Blood might become organized, like plastic exudations of "coagulable lymph," has been lately afforded by the researches of Dr. Zwicky, on the changes occurring in the clots of blood which form in blood-vessels, above the points where they have been tied. He has traced the successive stages of the metamorphosis of the coagulum into fibro-cellular tissue, and the formation of vessels in its substance; the whole process taking place exactly as in an inflammatory exudation, and the blood-corpuscles exerting no other influence upon it, than that of slightly retarding it.

701. When the Blood is withdrawn from the body, however, its Coagulation is the last act of its life; for, if not within the influence of a living surface, it soon passes into decomposition. Instances occasionally present themselves, in which the Blood does not coagulate after death; and in most of these, there has been some sudden and violent shock to the Nervous system, which has destroyed the vitality of solids and fluids alike. This is generally the case in men and animals killed by lightning, or by strong electric shocks; and in those poisoned by prussic acid, or whose life has been destroyed by a blow on the epigastrium. It has also been observed in some instances of rupture of the heart, or of a large aneurism near it; and a very interesting phenomenon then not unfrequently presents itself,—the coagulation of the Blood which has been effused into the pericardium (the effusion having taken place during the last moments of life), whilst that in the vessels has remained fluid. In several of the instances in which the blood has been found uncoagulated in the vessels, many hours after death, a portion withdrawn from the body has clotted; and Dr. Polli asserts that the complete absence of coagulability is a phenomenon which has no real occurrence. During a long course of researches on this subject, he has never yet met with an instance, in which the blood, when left to itself, and duly protected from external destructive influences, did not coagulate before becoming putrid. He has even more than once caused blood to coagulate, which had been taken in a fluid state from the veins, thirty-six or forty-eight hours after death.*—It appears that simple *arrestment* of Nervous influence favours the coagulation of the blood in the vessels; clots being found in their trunks, within a few minutes after the Brain and Spinal marrow have been broken down.

702. The length of time which elapses before Coagulation, and the degree in which the clot solidifies, vary considerably; in general, they are in the inverse proportion to each other. Thus, if a large quantity of blood be withdrawn from the vessels of an animal at the same time, or within short intervals, the portions that last flow coagulate much more rapidly, but much less firmly, than those first obtained. In blood drawn during Inflammatory states, again, the coagulation is usually slow, but the clot is preternaturally firm; especially at its upper part, where the Buffy coat (§ 704) or colourless stratum of Fibrine, gradually contracts, and produces the *cup*, which is usually regarded as indicative of a high degree of Inflammation. Except under the peculiar circumstances just stated, the Blood withdrawn from the body always coagulates; † whether it be kept at rest or in motion; whether its temperature be high or low; and whether it be excluded from the air, or be admitted to free contact with the atmosphere. The Coagulation may be accelerated or retarded, however, by variation in these conditions. Thus, if the blood be continually agitated in a bottle, its coagulation is delayed, though it will at last

* Ranking's Half-Yearly Abstract, vol. ii. p. 337.

† Some diseases may perhaps be an exception; non-coagulation of the Blood is said to be characteristic of the Scurvy, but this is erroneous. In very severe forms of Typhus, the same has been stated to occur.

take place in shreds or insulated portions; but that *rest* is not the cause of its coagulation (as some have supposed), is proved by the fact that, if a portion of blood be included between two ligatures in a living vessel, it will remain fluid for a long time. Again, the coagulation is accelerated by moderate heat, and retarded by cold; but it is not prevented by even extreme cold; for, if blood be frozen immediately that it is drawn, it will coagulate on being thawed. Moreover it is accelerated by exposure to air, but it is not prevented by complete exclusion from it, as is proved by its taking place in a vacuum, or in a shut sac within the dead body: complete exclusion from the air, however, retards the change; as has been shown by causing Blood to flow into a vessel containing oil, which will form an impervious coating on its surface, and will occasion the coagulation to take place so slowly, that the Red particles have time to subside, and the upper stratum of the clot is colourless.* A remarkable case has been put on record by Dr. Polli, in which complete coagulation of the blood did not take place until fifteen days after it had been withdrawn from the body; and fifteen days more elapsed before putrefaction commenced. The upper four-fifths of the clot were colourless; the red corpuscles occupying only the lowest fifth. It is additionally remarkable, that the patient (who was suffering under acute pneumonia) being bled very frequently during the succeeding week, the blood gradually lost its indisposition to coagulate.† An extrication of Carbonic acid usually takes place to a slight degree during coagulation; but this is not a constant occurrence; and the process is not prevented, even by agitating Carbonic acid with the Blood.

703. The proportions of Serum and Clot which present themselves after coagulation, are liable to great variation, independently of the amount of the several ingredients characteristic of each; for the Coagulum may include not only the Fibrine and Red particles, but also a large proportion of the Serum, entangled as it were in its substance. This is particularly the case when the coagulation is rapid; and the clot then expels little or none of it by subsequent contraction. On the other hand, if the coagulation be slow, the particles of Fibrine seem to become more completely aggregated, the coagulum is denser at first, and its density is greatly increased by subsequent contraction. When a firm fresh clot is removed from the fluid in which it is immersed, its concretion is found to continue for 24 or even 48 hours, serum being squeezed out in drops upon its surface; and in order, therefore, to form a proper estimate of the relative proportions of Crassamentum and Serum, the former should be cut into slices, and laid upon bibulous paper, that the latter may be pressed from it as completely as possible.—According to the experiments of Mr. Thrackrah, Coagulation takes place sooner in metallic vessels than in those of glass or earthenware, and the quantity of Serum separated is much less; in one instance, the proportion of Serum to Clot was as 10 to 24½, when the blood coagulated in a glass vessel; whilst a portion of the same Blood, coagulating in a pewter vessel, gave only 10 of Serum to 175 of Clot. The Specific Gravity of Blood is no measure of its coagulating power; for a high specific gravity may be due to an excess in the amount of globules, which form the heaviest part of the blood; and may be accompanied by a diminution in the quantity of fibrine, which is the coagulating element.

704. The Crassamentum not unfrequently exhibits, in certain disordered conditions of the Blood, a layer of Fibrine nearly free from colour; and this is known as the *Buffy Coat*. The presence of this has been frequently regarded as a sign of the existence of Inflammation, occasioning an undue predominance of Fibrine; but this idea is far from being correct, since, as will pre-

* Babington in *Medico-Chirurgical Transactions*, vol. xvi.

† Mr. Paget's Report, in *Brit. and For. Med. Rev.*, xix. p. 252.

sently appear (§ 705), it may result from a very opposite condition of the Blood. A similar colourless layer of Fibrine is always observable, when the Coagulation of the blood is retarded by the addition of agents that have the power of delaying it (§ 699); and since, in Inflammatory states of the system, the blood is generally long in coagulating, it has been supposed that the separation of the red particles is due to this cause alone. Dr. Alison,* however, maintains that there must be an absolute tendency to separation between the two components of the clot, in order to account for the phenomena sometimes presented by it; and he adduces the two following reasons in support of this view. "1. The formation of the Buffy coat, though no doubt favoured or rendered more complete by slow coagulation, is often observed in cases where the coagulation is more rapid than usual; and the colouring matter is usually observed to retire from the surface of the fluid in such cases, before any coagulation has commenced. 2. The separation of the Fibrine from the colouring matter in such cases takes place in films of blood, so thin as not to admit of a stratum of the one being laid above the other; they separate from each other laterally, and the films acquire a speckled or mottled appearance, equally characteristic of the state of the blood with the buffy coat itself."—It appears from the observations of Mr. Wharton Jones, that the red corpuscles of Inflammatory Blood have an

Fig. 210.

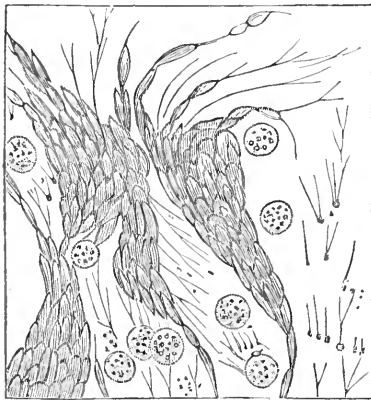

The microscopic appearance of a drop of blood in the inflammatory condition. The red corpuscles lose their circular form and adhere together; the white corpuscles remain apart, and are more abundant than usual.

The fibrous network is frequently extremely distinct; and it commonly includes a large number of White Corpuscles in its meshes. Sometimes, indeed, according to the observations of Mr. Addison, it almost entirely consists of these bodies. In its Chemical Composition, the buffy coat of Inflammatory blood appears to be peculiar; containing a larger or smaller amount of the substance, readily soluble in boiling water, which is considered by Mulder to be the Tritoxide of Proteine (§ 116. a).

705. When the Bull arises from other causes, however, its appearance is less characteristic. It appears from the researches of Andral, that the usual condition of its production is an increase in the quantity of Fibrine in proportion to the Red Corpuscles; and not a simple increase of Fibrine. When the

unusual attraction for each other, which occasions their coalescence in piles and masses; so that by this character, the state of the Blood may be detected, from the examination of no more than a single drop of the fluid. Now if we consider, in connection with this increase in the mutual attraction of the Blood-dises, the increase in the mutual attraction of the particles of Fibrine (which causes the coagulum of Inflammatory blood to be so much firmer and more decidedly fibrous than that of the healthy fluid), we have a cause sufficient to explain the phenomena noticed by Dr. Alison; without the necessity of resorting to the idea of an absolute repulsion being present between the two constituents.—It is in the Buffy Coat of Inflammatory Blood, that we see the clearest indications of organization ever presented by the circulating fluid.

* Outlines of Physiology, 3d edition, p. S9.

Blood contains an excessive quantity of Fibrine, it coagulates slowly; thus the blood of a patient labouring under Rheumatism coagulates more slowly than that of one affected with Typhoid fever. The increase may occur in two ways;—either by an absolute increase in the Fibrine, the amount of the corpuscles remaining unchanged, or not being augmented in the same proportion;—or by a diminution of the Corpuscles, the quantity of Fibrine remaining the same, or not diminishing in the same proportion. Hence in severe Chlorosis, in which the latter condition is strongly developed, the buffy coat may be as well marked, as in the severest Inflammation. Unless the composition of the blood be altered in one of these two ways, it is stated by Andral that the buffy coat is never formed; the influence of circumstances which favour it, not being sufficient to produce it when acting alone. The absence of these circumstances may prevent it, however, when it would otherwise have been formed; thus, when the Blood flows slowly, the *buff* is not properly produced; because the slow discharge gives one portion time to coagulate before another; and only the blood last drawn furnishes the Fibrine at the upper part of the vessel. Again, in a deep narrow vessel, the buff will form much more decidedly than in a broad shallow one; because the thickness of the Fibrinous crust will be greater.

6.—*Pathological Changes in the Blood.*

706. From the part which the Blood performs in the ordinary processes of Nutrition, it cannot be doubted that it undergoes important alterations, when these processes take place in an abnormal manner. These alterations must be sometimes the causes, and sometimes the effects, of the morbid phenomena, which constitute what we term the Disease. Thus, when some local cause, affecting the solid tissues of a certain part of the body, produces Inflammation in them, their normal relation to the blood is altered; the consequence is, that the Blood, in passing through them, undergoes a different set of changes from those for which it is originally adapted; and thus its own character undergoes an alteration, which soon becomes evident throughout the whole mass of the circulating fluid, and is, in its turn, the cause of morbid phenomena in remote parts of the system. On the other hand, the strong analogy between many Constitutional diseases, and the effects of poisonous agents introduced into the Blood, appears clearly to point to the inference, that these diseases are due to the action of some morbid matter, which has been directly introduced into the current of the circulating fluid, and which has affected both its physical and its vital properties.* Here, then, is a wide field for investigation, of which the surface can scarcely be said to be yet broken up, and which must yield an abundant harvest to those who shall cultivate it with intelligence and zeal. The first and most complete series of connected researches, which have been yet published, on the changes which the blood undergoes in disease, are those of MM. Andral and Gavarret;† these are confined

* This doctrine has been brought prominently forward, in a paper on Symmetrical Diseases, read by Dr. William Budd before the Medico-Chirurgical Society, Dec. 16, 1841. The Author ingeniously proves, that the symmetry of many diseases (such as certain forms of cutaneous eruptions, rheumatism, &c.) which do not immediately depend upon external causes, necessarily involves the idea of the conveyance of the morbid agent in the circulating fluid; the palsy produced by lead is a very interesting example, in which the agent is known to be mingled with the blood, and to be deposited in the parts affected, which are generally, if not always, symmetrical.

† An account of these inquiries will be found in the Provincial Medical and Surgical Journal for May, June, and July 1841; in the Annales des Sciences Naturelles, Dec. 1840, and March 1841; and in the Ann. de Chimie, tom. lxxv. They have since been published

to the alterations which take place in the proportions of the Organic elements of the fluid. Another series of researches of great value, and in almost every point confirmatory of the preceding, has been since made by MM. Becquerel and Rodier;* and another by Dr. Karl Popp.† Numerous other less systematic analyses have been made by various Chemists and Pathologists. The following outline contains the general results of these.—It is, of course, necessary to determine, in the first instance, what are the usual or normal proportions; and the following may be estimated as the ordinary quantity of each element, in 1000 parts of healthy Blood:—

Fibrine	from 2 to 3½
Corpuscles	" 110 " 150
Solid matter of Serum	" 72 " 85

707. Before entering upon the consideration of the alterations in the Blood, which are effected by particular morbid states, it is requisite to notice the results of two extraneous causes, usually operating in disease, which may affect the proportions of its components. These are, Abstinence from food, and Loss of Blood, as by Hemorrhage or Venesection. It has been commonly supposed, that these causes have a tendency to diminish the proportion of all the solid elements of the blood; but this is not the case; for they affect the Corpuscles, chiefly or exclusively, the quantity of Fibrine and of the solids of the Serum remaining nearly the same, unless the abstinence has been prolonged, or the loss of blood very considerable.—It is probably to the effects of abstinence, that we are to attribute the general diminution of the solids of the blood, which presents itself in most acute diseases; thus, on the average of 120 cases, MM. Becquerel and Rodier found the average Specific Gravity of defibrinated blood reduced from 1060 (in Men) and 1057·5 (in Women), to 1056 (in Men), and 1055 (in Women). The diminution in the proportion of Corpuscles was well marked; that of the Albumen was much slighter; there was on the whole a slight augmentation of Cholesterine and Phosphorized Fat; and a marked increase in the Phosphates. The increase or diminution of the Fibrine is entirely dependent (as we shall presently see) on the nature of the disease.—The influence of Venesection in impoverishing the blood is well shown in the following table of the mean composition of the fluid, at three successive Venesections in ten persons:—

	First Bleeding.	Second Bleeding.	Third Bleeding.
Specific Gravity of defibrinated Blood	1056	1053	1049·6
Water	793	807·7	823·1
Fibrine	3·5	3·8	3·4
Corpuscles	129·2	116·3	99·2
Albumen	65·0	63·7	64·6
Extractive, free salts, and fatty matters	9·4	8·5	9·5

Thus we see that repeated venesections render the blood more watery; but this, chiefly by the diminution they produce in the amount of Corpuscles. They slightly diminish the albumen and fatty matters; but *they exert no perceptible influence on the amount of Fibrine*;—a point of the highest practical importance.

a. The most important fact substantiated by Andral, is one that had been previously suspected,—the invariable increase in the quantity of Fibrine during acute Inflammatory affections; the increase being strictly proportional to the intensity of the inflammation, and to the

in a separate form, under the title of "Essai d'Hématologie Pathologique." [See Translation by Drs. Meigs and Stillé, Phil. 1844.]

* Gazette Médicale, 1844, Nos. 47—57.

† Ranking's Abstract, vol. iii. p. 306.

degree of symptomatic Fever accompanying it. "The augmentation of the quantity of Fibrine is so certain a sign of Inflammation, that, if we find more than 5 parts of fibrine in 1000, in the course of any disease, we may positively affirm that some local inflammation exists." Several cases are mentioned, in which an increase to 7 or $7\frac{1}{2}$ parts took place, without any apparent cause; but in which it afterwards proved that severe local inflammation was present; and thus we are furnished with a pathognomonic sign of great importance. The average proportion of Fibrine in Inflammation may be estimated at 7; the minimum at 5; the maximum at 13·3. The greatest augmentation is seen in Pneumonia and Acute Rheumatism. It does not appear that in robust athletic persons, the proportion of Fibrine is greater than in those of feeble constitution; in the latter it is the Corpuscles that are deficient; and it is rather from this disproportion, than from an absolute excess of Fibrine, that their greater liability to Inflammatory affections arises. Diseases which commence at the same time as the Inflammation, or co-exist with it, do not prevent the characteristic increase of the Fibrine; thus in Chlorotic females, the proportion rises to 6 or 7, under this influence. The augmentation is observed at the very outset of the affection; the quantity increases with its progress; and a decrease shows itself when the disease begins to abate.* When the disease presents alternations of increase and decline, these are marked by precisely corresponding changes in the quantity of Fibrine. It is a curious fact, that an augmentation is commonly observable during the advanced stage of Phthisis, in spite of the deterioration which the blood must then have undergone; this is probably dependent upon the development of local inflammation around the tubercular deposits. In one of Popp's observations, the proportion of Fibrine in the blood of a Phthisical patient was not less than 10·7. Some experiments performed by M. Andral on the blood of pregnant women, seem to lead to the conclusion that, during the first six months, the Fibrine is below the normal standard; and that it subsequently varies, usually undergoing an augmentation between the sixth and seventh, and the eighth and ninth months. There is also a diminution in the Corpuscles; and these circumstances combined favour the production of the buffy coat (§ 704). These observations are confirmed by those of MM. Becquerel and Rodier.

b. It appears obvious, from what has been just stated, that the increase in the quantity of Fibrine is not dependent upon the febrile condition, which is secondary to the local inflammation, but upon the Inflammation itself. This conclusion is confirmed by the interesting fact that, in idiopathic Fever, the proportion of Fibrine is diminished, instead of undergoing an increase. This diminution was constantly observed by Andral in the premonitory stage of Continued Fever; in some instances the amount was no more than 1·6 parts in 1000. The proportion of Corpuscles was found to have usually, but not constantly, undergone an increase; as had also that of the solid parts of the Serum. In ordinary Continued Fever, in which there was no evident complication from local disease, the quantity of Fibrin varied from 4·2 to 2·2; that of the Corpuscles from 155·1 to 103·6 (excluding a case in which their amount was only 82·5, which was that of a Chlorotic female); that of the solid matter of the Serum, from 98·7 to 90·9; and that of the Water from 725·6 to 851·9. Hence the quantity of solid matter appears to be usually increased; but the peculiar condition of the disease may probably be stated to be, an increase in the proportion of the Corpuscles to the Fibrine. When, however, a local Inflammatory affection develops itself during the course of the Fever, the amount of Fibrine increases; but its augmentation seems to be kept down by the febrile condition.—In Typhoid Fever,† the decrease in the proportion of Fibrine is much more decidedly marked; this does not depend upon abstinence; for it ceases as soon as a favourable change occurs in the disease, long before the effect of food could show itself. In the various cases examined by Andral, the blood furnished a maximum of 3·7 of Fibrine, and a minimum of 0·9; in this last case, the Typhoid condition existed in extreme intensity, yet the patient recovered. The proportion of Corpuscles varies considerably; in an early stage of the disease it is usually found to be absolutely high; and it always remains high relatively to the amount of Fibrine. In Typhoid fever, then, the abnormal condition of the Blood, in regard to the

* By experiments on animals, M. Andral has ascertained that no circumstance of previous debility or privation prevents this characteristic change. Having ascertained the amount of Fibrine in the blood of three dogs to be 2·3, 2·2, and 1·6 (the natural range for these animals), he deprived them, completely or partially, of food. On the fourteenth day, the proportion of fibrine had risen, in the first to 4·5; and in the second, to 4; these animals had no food. In the third dog, which was supplied with a very small quantity of food daily, the same condition developed itself at a later period; the blood on the fourteenth day exhibiting only 1·8 parts of fibrine: but on the twenty-second day presenting 3·3 parts.—In all these instances, the elevation in the proportion of Fibrine was coincident with inflammatory changes in the stomach.

† M. Andral confines this term to the species characterized by ulceration of the mucous follicles of the intestinal canal.

disproportion between the Corpuscles and the Fibrine, is more strongly marked than in ordinary Continued Fever: yet the usual augmentation of Fibrine will take place, if a local inflammation develops itself.—In the Eruptive Fevers, it does not appear that the proportion between the Fibrine and the Corpuscles undergoes so striking a change, as in ordinary Continued Fever; but the number of cases examined was too small to admit of decided conclusions. It was evident, however, that the specific Inflammations proper to, and characteristic of, these Fevers, have not the same effect in occasioning an increase of the Fibrine, as an intercurrent Inflammation of an extraneous character.—By the experiments of Magendie it has been ascertained that one of the effects of a diminution in the proportion of Fibrine, is a tendency to the occurrence of Hemorrhage or of Congestion, either in the parenchymatous tissue, or on the surface of membranes: these conditions are well known to be of frequent occurrence, as complications of febrile disorders. A marked diminution of Fibrine was noticed also in many cases of the disorder termed Cerebral Congestion, which commences with headache, vertigo, and tendency to epistaxis, and not unfrequently passes into coma and apoplexy. In Apoplexy, the diminution of Fibrine was still more striking; and in general, there was found to be an increase of the Corpuscles. In one instance, the quantity of Fibrine on the second day of the attack was found to have fallen to 1·9, whilst that of the Corpuscles had risen to 175·5; but on the third day, when the patient's consciousness began to return the quantity of Fibrine was 3·5, whilst that of the Corpuscles had fallen to 137·7. It would seem from the great change in the character of the Blood, which was noticed in this and in other instances, that the want of due proportion between the Fibrine and the Corpuscles was the cause, rather than the effect, of the Apoplectic attack.

c. The amount of Red Corpuscles seems to be subject to greater variation within the limits of ordinary health, than is that of Fibrine. In the condition which is ordinarily termed a highly sanguineous temperament, or Plethora, it is chiefly the entire mass of the blood that undergoes an increase; but whatever excess there may be in the proportion of its solid constituents, affects the Corpuscles rather than the Fibrine. Plethoric persons are not more prone to Inflammation, than are those of weaker constitution; but they are liable to Congestion, especially of the brain, and to Apoplexy or other Hemorrhage. The effect of Bleeding in diminishing this tendency is now intelligible; since we know that loss of blood reduces the proportion of Corpuscles.—On the other hand, in that temperament,* which, when exaggerated, becomes Anæmia, there is a marked diminution of the Corpuscles; this temperament may lead to two different conditions of the system. In Chlorosis, the Red Corpuscles are diminished, whilst the Fibrine remains the same; so that the clot, though small, is firm, and not unfrequently exhibits the buffy coat; in some extreme cases of this disease, the Corpuscles have been found as low as 27. The influence of the remedial administration of Iron, in increasing the quantity of Corpuscles, was rendered extremely perceptible by Andral's analyses; in one instance, after iron had been taken for a short time, the proportion of Corpuscles was found to have risen from 49·7 to 64·3; whilst in another, in which it had been longer continued, it had risen from 46·6 to 95·7. On the other hand, Bleeding reduced still lower the proportion of Corpuscles; thus in one instance, their amount was found, on a second bleeding, to have sunk from 62·8 to 49. The full proportion of Fibrine in the blood of Chlorotic patients accounts for the infrequency of Hemorrhage in them; whilst it also leads us to perceive that they may be, equally with others, the subjects of acute Inflammation, which we know to be the fact. A diminution of Corpuscles may also co-exist with a diminution in the amount, or in the degree of elaboration, of the Fibrine; and this condition seems to be characteristic of Scrofula. Andral has noticed a diminution in the proportion of Corpuscles in other Cachectic states, resulting from the influence of various depressing causes on the nutritive powers; as in the case of Diabetes Mellitus, in which the patient was much exhausted;—a case of Aneurismal dilatation of the Heart inducing Dropsy;—and in several cases of Cachexia Saturnina.—The increase in the proportion of Colourless Corpuscles, in Inflammatory affections, has been particularly noticed by Popp; he has found them especially abundant in Pneumonia and in Phthisis,—in the former of which diseases the Fibrine is invariably, and in the latter generally, increased.

d. The chief class of cases, in which any marked change has been observed in the amount of solid matter in the Serum, is that of Albuminuria, or Bright's disease of the Kidney. The diminished Specific Gravity of the Serum was long ago pointed out by Dr. Christison; but Andral remarks that this is not an accurate criterion, since, if there be a diminished amount of Corpuscles (as is not unfrequently the case in this disease), the proportion of water in the whole will be increased, and the specific gravity of the serum thus lowered, without any alteration in its proper quantity of solid matter. According to Andral, the diminution in the amount of Albumen in the Serum is exactly proportional to the quantity

* The term *lymphatic* has been applied to this temperament; by which term was meant a predominance of lymph in the absorbent vessels.

contained in the urine. A case is related by him, under this head, which affords an interesting exemplification of the general facts that have been already attained by his investigations. A woman who had been suffering from Erysipelas of the face, and who had lost blood both by venesection and by leeches, became the subject of Albuminuria. The blood drawn at this time exhibited a considerable diminution in the proportion of Corpuscles, as well as of Albumen,—a fact which the previous loss of blood fully accounted for. After a short period, during which she had been allowed a fuller diet, another experimental bleeding exhibited an increase in the proportion of Corpuscles. Some time afterwards, when the Albumen had disappeared from the Urine, some more blood was drawn; and it was then observed that the Albumen of the Serum had returned to its due proportion, but that the Corpuscles had again diminished, whilst there was a marked increase in the quantity of Fibrine. This alteration was fully accounted for by the fact, that, in the interval, several Lymphatic ganglia in the neck had been inflamed and had suppurated; and that the patient had been again placed on very low diet. “Thus,” observes Andral, “we were enabled to give a complete explanation of the remarkable oscillations which were presented, in the proportion of the different elements of the blood drawn at three different times from the same individual; and thus it is that, the more extended are our inquiries, the more easy does it become to refer to general principles the causes of all those changes in the composition of the blood, which, from the frequency and rapidity with which they occur, seem at first sight to baffle all rules, and to take place, as it were, at random. In the midst of this apparent disorder, there is but the fulfilment of laws; and in order to obtain these, it is only necessary to strip the phenomena of their complications, and to reduce them to their simplest form.”

708. That the Blood is subject to a great variety of other morbid alterations, which are sometimes the causes, and sometimes the results, of Disease, cannot be for a moment doubted. But our knowledge of the nature of these changes is as yet very insufficient. The great amount of attention which is being directed by Chemical Pathologists to the subject, however, will doubtless ere long produce some important results.—Among the most frequent causes of depravation in the character of this fluid, we must undoubtedly rank the retention, in the Circulating current, of matters which ought to be removed by the Excreting processes. We shall presently see, that a total interruption to the excretion of Carbonic Acid by the lungs, will occasion death in the course of a very few minutes; and even when only a slight impediment is offered it, so that the quantity of Carbonic Acid always contained in arterial blood is augmented to but a small degree, a feeling of discomfort and oppression, increasing with the duration of the interruption, is speedily produced. The results of the retention of the materials of the Biliary and Urinary excretions will be hereafter considered (Chap. xv.); and at present it will be only remarked, that such retention is a most fertile source of slight disorders of the system, that it is largely concerned in producing many severe diseases, and that if complete it will most certainly and rapidly produce a fatal result.—The most remarkable cases of depravation of the Blood, by the introduction of matters from without, are those in which these substances act as *ferments*,—exciting such Chemical changes in the constitution of the fluid, that its whole character is speedily changed, and its vital properties are altogether destroyed. Of such an occurrence, we have characteristic examples in the severe forms of Typhoid fever, commonly termed *malignant*; in Plague, Glanders, Pusule Maligne, and several other diseases; in some of which we can trace the direct introduction of the poison into the blood, whilst in others we must infer from the similarity of result) that it has been introduced through some obscure channel,—probably the lungs. The final symptoms which are common to all these diseases have been well described by Dr. Williams,* under the title of *Necramia*, or Death by *depravation* of the blood. “Almost simultaneously, the heart loses its power, the pulse becomes very weak, frequent, and unsteady: the vessels lose their tone, especially the capillaries of the most vascular organs, and congestions occur to a great amount;

* Principles of Medicine, [Am. Ed. by Dr. Clymer, p. 373.]

the brain becomes inactive, and stupor ensues; the medulla is torpid, and the powers of respiration and excretion are imperfect: voluntary motion is almost suspended; secretions fail; molecular nutrition ceases; and at a rate much more early than in other modes of death, *molecular* death follows close on *somatic* death,—that is, structures die and begin to run into decomposition as soon as the pulse and breath have ceased; nay, a partial change of this kind may even precede the death of the whole body; and parts running into gangrene, as in the carbuncle of plague, the sphacelous throat of malignant scarlatina, and the sloughy sores of the worst forms of typhus, or the putrid odour exhaled even before death by the bodies of those who are the victims of similar pestilential disease, are so many proofs of the early triumph of dead over vital chemistry.”—“The appearance of petechiæ and vibices on the external surface, the occurrence of more extensive hemorrhage in internal parts, the general fluidity of the blood, and frequently its unusually dark or otherwise altered aspect, its poisonous properties as exhibited in its deleterious operation on other animals, and its proneness to pass into decomposition, point out the Blood as the first seat of disorder; and by the failure of its natural properties and offices as the vivifier of all structure and function, it is plainly the medium by which death begins in the body.”

CHAPTER XII.

OF THE CIRCULATION OF BLOOD.

1.—*Of the Circulation in General.*

709. THE Circulation of nutritive fluid through the body has for its object, on the one part, to convey to every portion of the organism the materials for its growth and renovation, together with the supply of Oxygen which is requisite for its vital actions, especially those of the Muscular and Nervous systems; and at the same time to carry off the particles, which are set free by the disintegration or *waste* of the tissues, and which are to be removed from the body by the Excreting processes. Of these processes, the one most constantly in operation, as well as most necessary for the maintenance of the purity of the blood, is the extrication of Carbonic acid, through the Respiratory organs; and this is made subservient to the introduction of Oxygen into the system. The extent, therefore, to which a Circulating apparatus is developed in the Animal kingdom, is partly dependent upon the degree in which the function of nutritive Absorption is limited to one part of the body; and partly upon the arrangement of the Excreting surfaces, and especially of the Respiratory apparatus. Where the Digestive cavity extends itself through the whole system, so that every part can absorb at once from its parietes,—and where the whole external surface is adapted, by its softness and permeability, to expose the fluids of the body to the aerating medium around,—there is no necessity for any transmission of fluid from one part to another; and accordingly, in the lowest animals, which are thus formed, no true Circulation exists. Again, in the Insect tribes, in whose bodies the absorption of fluids can only take place at fixed points, there is a Circulation, for the purpose of transmitting the absorbed matter to the remote portions of the body; but as every part of the interior is permeated by air, the second of the above-named purposes

is already answered; and the circuit of the blood through the vessels, therefore, is not accomplished with the energy and activity which, from the vigorous movements performed by these little beings, might have been supposed necessary. On the other hand, among the Mollusca, in which the absorption of fluid and the respiratory action are alike limited, we find the circulating apparatus almost as extensive, and the movement of blood as vigorous, as it is in the lower Vertebrata. It is in those animals, in which there is the greatest activity in the other functions,—which *live*, in fact, the *fastest*,—that the Circulation is most energetic; thus the rapid and energetic movement of the blood in Birds contrasts most strongly with its slow and feeble propulsion in Reptiles. The movement may vary considerably, however, in the same animal at different times, according to its state of repose or activity; and in different organs of the same animal, according to the energy with which their functions are being respectively performed.

710. In Man, as in other Vertebrated animals, there is a regular and continuous movement of the nutritive fluid through the vascular system; and upon the maintenance of this, the activity of all parts of the organism is dependent. The course of the Blood may be likened to the figure 8; for there are two distinct circles of vessels, through which it is transmitted; and the Heart is placed at the junction of these. The Systemic and Pulmonary circulations are entirely separate, and might be said to have distinct hearts; for the left and right sides of the heart, which are respectively appropriated to these, have no direct communication with each other (in the perfect adult condition, at least), and are merely brought together for economy of material. At an early period of fetal life, as in the permanent state of the Dugong, the heart is so deeply cleft, from the apex towards the base, as almost to give the idea of two separate organs. Each system has its own set of Arteries or efferent vessels, and Veins or afferent trunks; these communicate at their central extremity by the Heart; and at their peripheral extremity by the Capillary vessels, which are nothing else than the minutest ramifications of the two systems, inosculating into a plexus (§ 219).

Fig. 211.

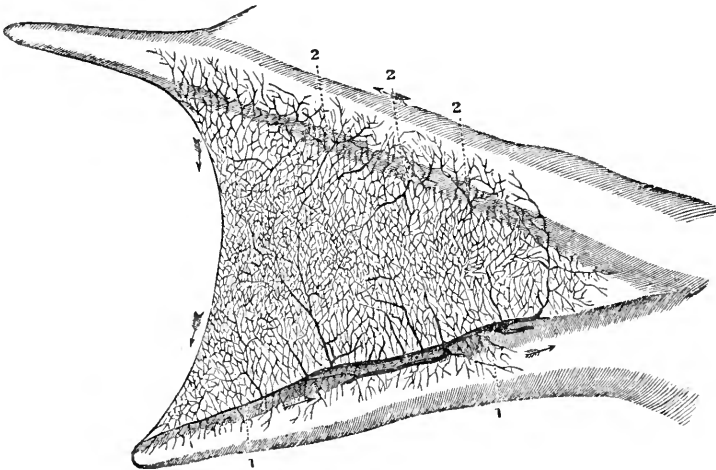

Web of Frog's foot, stretching between two toes, magnified 3 diam; showing the blood-vessels, and their anastomoses: 1, 1, veins; 2, 2, 2, arteries.

a. Although the diameters of the branches, at each subdivision, together exceed that of the trunk, yet there is but little real difference in their size. For, according to a well-known geometrical law, the *areas* of circles are as the *squares* of their *diameters*; and, as the calibre of a tube is estimated by its area, not by its diameter, it follows that, in comparing the size of a trunk with that of its branches, we are to square the diameter of the former, and compare the result with the sum of the squares of the diameters of the branches. When this is done, there is found to be a very close correspondence. The following table gives the result of eight measurements, taken with a view to determine the question. The first three were taken from the mesenteric artery of a Sheep; the next three from the aorta and iliac arteries; the last two from the Horse.*

TRUNK.			BRANCHES.	
DIAMETER.	SQUARE.		DIAMETERS.	SUM OF SQUARES.
I.	9	81	7.5+5	81.25
II.	7.2	51.64	6+4	52
III.	3.5	12.25	3+2	13
IV.	7.0	49	5+5	50
V.	17	289	10+10+9.5	290.25
VI.	10	100	7+7+2	102
VII.	4.5	20.25	3.5+3	21.25
VIII.	8	64	4+7	65

The discrepancy between the two results must be considered extremely small, when it is stated that the *unit*, in the above measurements, is no more than one-fortieth of an inch; and when it is remembered that any error in the measurement is greatly increased in the calculation.

b. From Mr. Paget's observations, however, it appears that there is seldom an exact equality between the area of the trunk and that of its branches, but the area sometimes increases, and sometimes diminishes;—the former being the general rule for the subdivision of the aorta and its principal branches in the upper extremities;—the latter in the lower. The following Table shows the relative areas of several arterial trunks, and of the branches proceeding from them.

	TRUNK.	BRANCHES.
Arch of Aorta	1	1.055
Innominate	1	1.147
Common carotid	1	1.013
External carotid	1	1.190
Subclavian	1	1.055
Abdominal Aorta, to last lumbar art.	1	1.183
_____ , just before dividing	1	.893
Common Iliac	1	.982
External Iliac	1	1.150

711. That the movement of the Blood through the Arterial trunks and the Capillary tubes is, in Man, and in other warm-blooded animals, chiefly dependent upon the action of the Heart there can be no doubt whatever. It can be easily shown by experiment, that, if the Arterial current be checked, the Capillaries will immediately cease almost entirely to deliver the blood into the veins, and the Venous circulation will be instantaneously arrested. And it has also been proved, that the usual force of the Heart is sufficient to propel the blood, not only through the Arterial tubes, but through the Capillaries, into the Veins; since even a less force will serve to propel warm water through the vessels of an animal recently dead.† But there are certain “residual phenomena” even in Man, which clearly indicate that this is not the whole truth; and that forces existing in the Blood-vessels have a considerable influence, in producing both local and general modifications of the effects of the Heart's action. There are also indications of the nature of an influence, in which the blood-vessels do not partake, arising from those changes occurring between the Blood and the Tissues, that constitute the processes of Nutrition, Secretion,

* Ferneley in Medical Gazette, Dec. 7, 1839.

† See Dr. Williams' Principles of Medicine, p. 143, note.

&c. Such, for instance, would appear to be the interpretation of the fact, that whilst any variations in the action of the Heart affect the whole system alike, there are many variations in the Circulation, which, being very limited in their extent, cannot be attributed to such central disturbances, and must therefore be dependent on causes purely local.—Of the nature of these influences, and of the mode of their operation, we shall probably arrive at a more correct knowledge, if we examine the phenomena of the Circulation in those beings, in which the moving power is less concentrated than it is in the higher Animals; for just as we find in the latter, that the development of special absorbent vessels does not exclude the function of absorption from being still performed by the general vascular system (§ 675), so may we here be led to perceive, that there is a generally-diffused force, to which alone the Circulation of the nutritious fluid in the lowest organisms is due, and which is not altogether replaced by the special organ of impulsion, that is developed in the centre of the system in the higher.

712. The ascent of the sap in Vegetables is probably to be regarded as due, in part, to the *vis à tergo* occasioned by the action of Endosmose at the roots; and in part, to the demand for fluid, occasioned by the vital processes taking place in the leaves. For if the stem of the Vine, in which the sap is rising, be cut across, the sap will continue to flow for some time from the top of the lower portion; and its force of ascent may be shown to be very considerable, by tying over the cut surface a piece of bladder, which will be speedily burst.—or by affixing to it a bent tube, containing a column of mercury, which will be raised to the height of forty inches or more. On the other hand, the attractive force of the leaves is shown by the fact, that if the lower end of the upper division be put into water, it will continue to absorb, as long as the vital actions of the leaves are being performed with vigour; but, if the branch be carried into a dark room, the exhalation from the leaves is immediately checked, and absorption is checked also. The influence of the actions at the periphery of the circulating system, in maintaining the flow of fluid towards the part, is further shown by the fact, that, if a shoot of an evergreen species be grafted on a stock of one with deciduous leaves, a continual and unwonted ascent of sap will be kept up in the latter through the winter; this being evidently due to the demand occasioned at its summit. Again, the recommencement of the annual flow of sap in an ordinary tree, has been found to take place in the first instance, not at its roots, but in the neighbourhood of the buds; for their expansion, under the influence of the returning warmth, exhausts the fluid from the vessels of their neighbourhood; this, again, occasions a demand from below; and thus the motion is gradually propagated to the roots. Now it has been experimentally ascertained, that if a branch of a vine growing in the open air be trained into a hot-house, it may be made to vegetate during the winter, and to draw up fluid through the stems and roots, whose condition has not been changed. It is evident, then, that in Plants, the demand for fluid, in the organs to which it is distributed by the vascular system, is one of the chief forces by which the supply is obtained.

713. This is still more evidently the case, in regard to the Circulation of nutritious or elaborated sap, which takes place in the under surface of the leaves and in the bark. The object of this movement is not to convey the fluid in a direct line from one point to another (as in the case with the ascending current), but to supply every part with materials for its growth, or for the production of its peculiar secretions. Hence the vessels in which it takes place, form a minutely-anastomosing net-work, instead of consisting of a system of straight and distinct tubes. Through this net-work, the latex or elaborated sap is seen to move, exactly as does the blood through the capillary vessels of animals. The movement takes place, under favourable circum-

stances, with considerable rapidity; it is accelerated by heat, and retarded by cold; and it is subject to all those minor irregularities (such as the cessation of movement, or change in the direction of the current, in a particular channel), which are so constantly to be noticed by any one who attentively watches the capillary circulation of Animals, and which clearly prove the operation of some causes independent of the heart's action (§ 734). The general direction of the elaborated sap, through this capillary system, is downwards; but that the force of gravity cannot have much to do with the movement, is shown by the fact that, in dependent branches, it has to *ascend* towards the stem, which it will do without interruption from this cause. Moreover it may be noticed that this circulation takes place most actively, in parts which are undergoing a rapid developement; and that its energy corresponds with the vitality of the part. Further; it may be observed to continue for some time in parts that have been completely detached from the rest; and on which neither *vis à tergo*, nor *vis à fronte*, can have any influence. It is evident, then, that the force,—whatever be its nature,—by which this continued movement is kept up, must be developed by the processes to which that movement is subservient; in other words, that the changes involved in the acts of nutrition and secretion are the real source of the motor power. The manner in which they become so, is the next object of our inquiry: and on this subject, some new views have recently been put forth by Prof. Draper,* which seem to account well for the phenomena.

a. It is capable of being shown, by experiments on inorganic bodies, that, if two liquids communicate with each other through a capillary tube, for the walls of which they both have an affinity, and if this affinity is stronger in the one liquid than in the other, a movement will ensue; the liquid which has the greatest affinity being absorbed most energetically into the tube, and driving the other before it. The same result occurs when the fluid is drawn, not into a single tube, but into a net-work of tubes, permeating a solid structure; for if this porous structure be previously saturated with the fluid, for which it has the less degree of attraction, this will be driven out and replaced by that for which it has the greater affinity, when the latter is permitted to enter it. Now if, in its passage through the porous solid, the liquid undergo such a change, that its affinity be diminished, it is obvious that, according to the principle just explained, it must be driven out by a fresh supply of the original liquid; and that thus a continual movement in the same direction would be produced.

b. Now this is precisely that which seems to take place in the organized tissue, permeated by nutritious fluid. The particles of this fluid, and the solid matter through which it is distributed, have a certain affinity for each other; which is exercised in the nutritive changes, to which the fluid becomes subservient during the course of its circulation. Certain matters are drawn from it, in one part, for the support and increase of the woody tissue; in another part, the secreting cells demand the materials which are requisite for their growth,—as starch, oil, resin, &c.; and thus in every portion that is traversed by the vessels, there are certain affinities between the solids and the fluids, which are continually being newly developed by acts of growth, as fast as those which previously existed are satisfied or neutralized by the changes that have already occurred. Thus in the circulation of the elaborated sap, there is a constant attraction of its particles towards the walls of the vessels, and a continual series of changes produced in the fluid as the result of that attraction. The fluid, which has given up to a certain tissue some of its materials, no longer has the same attraction for that tissue; and it is consequently driven from it by the superior attraction then possessed by the tissue for another portion of the fluid, which is ready to undergo the same changes, to be in its turn rejected for a fresh supply. Thus in a growing part, there is a constantly-renewed attraction for the nutritive fluid, which has not yet traversed it; whilst on the other hand, there is a diminished attraction for the fluid, which has yielded up the nutritive materials required by the particular tissues of the part; and thus the former is continually driving the latter before it.

c. But the fluid, which is thus repelled from one part, may still be attracted towards another; because that portion of its contents, which the latter requires, may not yet have been removed from it. And in this manner, it would seem that the flow of sap is maintained

* On the Forces which produce the Organization of Plants, Chap. III.

through the whole capillary net-work, until it is altogether exhausted of its nutritive matter. The source of the movement is thus entirely to be looked for in the changes which take place in the act of growth; and the influence of heat, cold, and other agents, upon the movement is exercised through their power of accelerating or retarding those changes.

714. The fluid which thus descends through the stem and roots, seems to be at last almost entirely exhausted; a portion of it appears to find its way into the ascending current, and to be mingled with it: but all the rest seems to have been entirely appropriated by the different tissues, through which it has circulated. Thus there is no need of any general receptacle, into which it may be collected, and from which it may take a fresh departure;—such as is afforded by the heart of the higher animals. And as the purpose of this circulation is only to supply the nutritive materials, and not to convey oxygen,—this element being but little required in the vegetative processes, and being supplied by other means,—the same energy and rapidity are not required in it, as need to be provided for in the higher animals.

715. In the lowest Animals, the movement of the circulating fluid seems as independent of any central organ of impulsion, as it has been shown to be in Plants. Thus, in the living Sponge, a current of water is continually flowing through the tubes and channels, by which its substance is traversed, the fluid being taken in by the small orifices, and ejected in powerful streams from the large ones; and yet the most attentive examination has not revealed any mechanical cause for this movement. In some of the compound Polypifera, a similar current may be seen; and it is curious that, in many species, its direction undergoes a periodical change; being reversed at intervals of a certain number of seconds. In the Star-Fish and Sea-Urchin tribe, a complex circulation of blood takes place, through regular vessels; and here we find some indication of a contractile cavity, by the power of which it may be, in some degree, kept up; but its feeble pulsations can scarcely be regarded, as having any great share in the movement of the fluid which passes through it.—In the Articulated series, there is, with a few exceptions, an absence of any central organ of impulsion, possessed of power sufficient to carry the blood through the vascular system, by its contractions alone. In many of the aquatic worms and larvæ, the movement of the blood, and the pulsations of the dorsal vessel, may be distinctly seen: and the thinness of the walls of the latter, and the character of its movements, seem clearly to show, that these can scarcely be regarded as propulsive, but that they merely result from the variations in the current which passes through it,—the sides flapping together when there is an outward flow, and bulging out when there is an influx. It is in these Articulata, in which there is a provision for respiration throughout the whole structure, as is especially the case in Insects, that the absence of any central impulsive power is most remarkable.—In the Crustacea, and in the Mollusca in general, the respiration is aquatic, and is restricted to a particular organ; and in these, the heart is found to be more muscular, and the circulation to be more under its control. It is curious to remark, however, that, in some of the lower Mollusca, which exhibit a tendency to aggregation into compound structures, like those of the Polypifera, there is the same want of definiteness in the course of the circulation, as has been just stated to exist in the latter group;—the flow of blood, through their complex apparatus of nutritive organs, being arrested at regular intervals, and then recommencing in the reverse direction.

716. Even in Vertebrated animals, we find indications of the same deficiency of central power, over the peripheral circulation. When we look at the simple, thin-walled heart of Fishes, for example, it seems impossible that it should have much power over the current of blood flowing back to it by the veins; for of this blood, a considerable portion has to pass through *three*

sets of capillaries, between its ejection from the heart, and its return to it. It is first transmitted through the respiratory capillaries, for the purpose of aeration; the confluent vessels, which collect the arterial blood from these, terminate in the general systemic trunk or Aorta, in which, as in the *veins* of Man, there is an absence of pulsation, and by these, it is distributed to the systemic capillaries; and the blood which, after passing through these, returns from the posterior part of the body, and from the viscera, passes through another set of capillaries, those of the liver and kidneys, before it returns to the heart.—Even in the warm-blooded Vertebrata, in which the respiratory circulation is separately performed, the blood which is returned from the intestines, passes into a trunk, the *Vena Portæ*, which again subdivides into capillary ramifications, being transmitted over the plexus of biliary ducts, of which the liver is chiefly composed; and thus the *Vena Portæ*, as Hunter justly observed, should be considered rather in the light of an artery,* resembling as it does the aorta of Fishes. Considering the small amount of pressure which is exerted by the blood, upon the sides of the vessels that are formed by the reunion of capillaries, it seems impossible to imagine that the *vis à tergo* derived from the impulsive action of the Heart, can be alone sufficient to maintain the *portal* circulation.

2.—Action of the Heart.

717. The Heart is endowed in an eminent degree with the property of *irritability*; by which is meant, the capability of being easily excited to movements of contraction alternating with relaxation (§ 574). Thus, after the Heart has been removed from the body, and has ceased to contract, a slight irritation will cause it to execute, not one movement only, but a series of alternate contractions and dilatations, gradually diminishing in vigour until they cease. The contraction begins in the part irritated, and then extends to the rest. It appears from Mr. Paget's experiments,† that it is necessary for the propagation of this irritation, that the parts should be connected by muscular tissue, of which a very narrow isthmus will suffice; and that the propagation will not take place, if the connecting isthmus be composed of tendon, even though this be a portion of the auriculo-ventricular ring, which has been supposed by some to be peculiarly efficacious in this conduction.—That the irritability of the heart is not dependent upon the Cerebro-spinal system, appears not merely from the manifestation of it, when the organ is altogether removed from the body, but also from the fact, that if the flood of blood through the lungs be kept up by artificial respiration, the heart's action will continue for a lengthened period, even after the Brain and Spinal Cord have been removed, and when animal life is, therefore, completely extinct. Hence we see that the Irritability of this organ must be an endowment properly belonging to it, and not derived from that portion of the Nervous System. Like the contractility of other muscles, it can only be sustained for any great length of time, by a supply of Arterial blood to its own tissue (§ 584). It is much less speedily lost in cold-blooded animals, however, than in warm-blooded; the heart of the Frog, for example, will go on pulsating for many hours after its removal from the body; and it is stated by Dr. Mitchell‡ that the heart of a Surgeon, which he had inflated with air, continued to beat, until the auricle

* That it conveys venous blood, is no reason to the contrary; since this is the case with the pulmonary artery. The character of an artery is derived from the division of its current into several divergent streams.

† Brit. and For. Med. Review, vol. xxi. p. 551.

‡ American Journal of the Medical Sciences, vol. vii. p. 58.

had absolutely become so dry, as to rustle during its movements. It has lately been shown by Mr. Todd, that the irritability of the heart is of long duration after death in very young animals : which, as long since demonstrated by Dr. Edwards, agree with the cold-blooded Vertebrata in their power of sustaining life, for a lengthened period, without oxygen.—It is difficult to account for the long continuance of the alternate contractions and relaxations of the muscular parietes of the heart, after all evident stimuli have ceased to act upon it; and many theories have been offered on the subject, none of which afford an adequate explanation. The extraordinary tendency to *rhythmical* action, which distinguishes the heart from all other muscles, is shown by the fact that not only do the entire hearts of cold-blooded animals continue to act, long after their removal from the body, but even separated portions of them will contract and relax with great regularity for a long time. Thus the auricles will persist in their rhythmical action, when cut off above the auriculo-ventricular rings; and the apex of the heart will do the same, when separated from the rest of the ventricle. The stimulus of the contact of blood with the lining membrane of the heart, to which its regular actions have been commonly referred, can have no influence in producing these movements; nor does it appear that the contact of *air* can take its place; since, as Dr. J. Reid has shown, the rhythmical contractions of the heart of a frog will continue *in vacuo*. Nor is there any evidence that the flow of blood through the cavities has the effect of securing the regularity of their successive contractions in the living body; for this regularity is equally marked in the contractions of the excised heart, when perfectly emptied of blood, so long as its movements continue vigorous. But when its irritability is nearly exhausted, the usual *rhythm* is often a good deal disturbed, so that the contractions of the auricles and ventricles do not regularly alternate with each other; and one set frequently ceases before the other.

a. It was formerly supposed, that the movements of the Heart were dependent upon its connection with the centres of the Cerebro-Spinal nervous system; and the experiments of Legallois and others, who found that they were arrested by crushing, or otherwise suddenly destroying, large portions of these centres, appeared to favour the supposition. But it has been shown by Dr. Wilson Phillip and his successors in the same inquiry, that the whole Cerebro-Spinal axis might be *gradually* removed, without any such consequence; which fact harmonizes perfectly with the “experiments prepared for us by Nature,” in the production of monsters destitute of these centres, which nevertheless possessed a regularly-pulsating heart. As already mentioned (§ 416), it is difficult to obtain any distinct evidence, that the actions of the heart are affected by any ordinary irritation of the Par Vagus; but the recent experiments of MM. Weber have shown that its movements may be immediately arrested, by the transmission of the electric current from a rotating magnet, either through the Spinal Cord, or through the Vagi nerves divided at their origin. The same irritation, however, applied to a single one of the Vagi, produced no effect.*

b. It has lately been the fashion with many, however, to attribute the action of the Heart to the Sympathetic system; but of this there is no sufficient evidence. The *possibility* of exciting the action of the heart through the Sympathetic nerve (§ 576), shows that this may have an influence on its movements; whilst the great difficulty with which any evidence to this effect can be procured, seems a sufficient proof, as in the case of the Muscular coat of the intestines (§ 388), that this influence cannot be nearly adequate to the constant maintenance of a function so energetic. Some have more recently maintained, that the movements are of a strictly *reflex* nature, and that they are effected through the agency of certain minute ganglia, belonging to the Sympathetic system, and scattered through the substance of the heart;—in this way endeavouring to account for the persistence of the motions of the organ after its complete removal from the body, and under circumstances which suspend all reflex movements that have their centre in the cerebro-spinal system. But this attempt at explanation affords no aid in the solution of the cause of the continued rhythmical movements of the organ, or of its separated portions, after the withdrawal of all stimuli that can be supposed to operate in exciting them; and the phenomena are just as fully explained by

* Archives d'Anat. Génér. et de Physiol., Janv. 1846.

attributing them to the independent irritability of the muscular fibre, as by supposing the nervous system to be concerned in them.

c. It would appear, however, that changes in the Ganglionic nerves, like strong impressions upon the Cerebro-spinal system (§ 580), may have the effect of impeding or even checking the Heart's action; for a case has lately been recorded, in which the movements were occasionally checked for an interval of from 4 to 6 beats, its cessation of action giving rise to the most fearful sensations of anxiety, and to acute pain passing up to the head from both sides of the chest,—these symptoms being connected, as it proved on a post-mortem examination, with the pressure of an enlarged bronchial gland upon the great cardiac nerve.* It may be surmised, that in many cases of *angina pectoris*, in which no lesion sufficient to account for death could be discovered, some affection of the cardiac plexus might have been traced on a more careful examination.

718. When the Heart is exposed in a living animal, and its movements are attentively watched, they are seen to follow each other with great regularity. In an active and vigorous state of the circulation, however, they are so linked together, that it is not easy to distinguish them into periods. A case has fallen under the notice of Prof. Cruveilhier, in which the heart was exterior to the chest, having escaped from it by a perforation in the superior part of the sternum; and his observations upon it may be perhaps regarded as more satisfactory than such as are made after the very severe operation required for the artificial exposure of the organ; although they are liable to some exception, from the very early age of the subject of them, which had only been born nine hours. His conclusions will be here adopted; with such additional remarks as are suggested by the experimental researches of others, who have made this question a subject of special attention.† It is universally admitted, that both Auricles contract, and also dilate simultaneously; and that both Ventricles do the same:—also that the *systole* or contraction of the ventricles corresponds with the projection of blood into the arteries, causing the pulse; whilst the *diastole* or dilatation of the ventricles coincides with the collapse of the arteries. It is further admitted, that the contraction of the Ventricles, and that of the Auricles, alternate with one another; each taking place (for the most part, at least), during the dilatation of the other. But it is a question whether there is any interval between them. In the case just alluded to, the *contraction* of the Ventricles is stated to have been precisely synchronous with the *dilatation* of the Auricles; and the *dilatation* of the Ventricles to have been performed at the same time with the *contraction* of the Auricles, no period of repose intervening between the two sets of actions. It appears, however, from the concurrent testimony of numerous experimenters, that, whilst the contraction of the Ventricle immediately succeeds that of the Auricle, an interval, which is usually, however, extremely brief, may elapse between the partial dilatation of the Ventricle and the succeeding systole of the Auricles. The Ventricular *dyastole* may be distinguished into two stages, of which the first immediately succeeds its *systole*, and manifests itself in the recession of the Heart's apex from the front of the chest; whilst the second is attended with an enlargement of the heart in all its dimensions, and is synchronous with the Auricular contraction. It is between these two, that the interval of repose occurs, where it can be observed. The following tabular view will, perhaps, make this account more intelligible; it is framed in such a manner as to commence with the Auricular contraction; but, when considering the Sounds of the heart, it will be necessary to commence with the Ventricular systole.

* Muller's Archiv. 1841, heft iii.; and Brit. and For. Med. Rev., Oct. 1841.

† See also another case, recently observed by M. Monod, in *Bullet. de l'Acad. de Med.*, Fevr. 1843; and *Edinb. Med. and Surg. Journ.*, July 1843.

<i>Auricles.</i>	<i>Ventricles.</i>
Contraction.	2d stage of dilatation.
Dilatation.	Contraction.—Pulse.
	1st stage of dilatation.
	Brief interval of Repose.
Contraction.	2d stage of dilatation.
Dilatation.	Contraction.—Pulse.

719. The duration of the Contraction of the Ventricles is, according to Cruveilhier, double that of their Dilatation; and the same holds good of the Auricles. In the Systole of the Ventricles, their surface becomes rugous; the superficial veins swell; the *carneæ columnæ* of the left ventricle are delineated; and the curved fibres of the conical termination of the left ventricle, which alone constitutes the apex of the heart, become more manifest. During their contraction, every diameter of the Ventricles is lessened; their shortening is the most sensible change; but this is owing to the vertical diameter being the greatest. The lower extremity of the left ventricle, or, in other words, the apex of the heart, describes a spiral movement from right to left, and from behind forwards. It is to this slow, gradual, and as it were successive spiral contraction, that the forward movement of the apex of the heart is owing, and its consequent percussion against the thoracic parietes. The ventricular systole is not accompanied by a projection of the entire heart forwards (as some have maintained); for it is exclusively the spiral contraction, which determines the approach of the apex of the heart to the thoracic parietes. The Diastole of the heart, according to Cruveilhier, has the rapidity and energy of an active movement: triumphing over pressure exercised upon the organ, so that the hand closed upon it is opened with violence. This is an observation of great importance; but of the cause to which this active dilatation is due, no definite account can be given. It may partly be explained, perhaps, by the elasticity of the tissue, interwoven with muscular fibre in the substance of the heart; and this may be the cause of the first Ventricular dilatation, the second being produced by the ingress of blood occasioned by the auricular systole. But the dilatation of the Auricles appears to be much greater than can be accounted for by any *vis à tergo* (which, as will hereafter appear, is extremely small in the venous system), or by the elasticity of its substance; for it was observed in this case to be so great, that the right auricle seemed ready to burst, so great was its distension, and so thin were its walls. Moreover, the large Veins near the heart contract simultaneously with the auricular Systole, and not with its Diastole; so that they can have no influence in causing its dilatation. The Ventricular diastole is accompanied with a projection of the heart downwards; this motion was at its maximum when the child was placed vertically, and was very strongly marked.

720. When the ear is applied over the cardiac region, during the natural movements of the Heart, two successive sounds are heard; each pair of which corresponds with one pulsation. The whole interval between one beat of the the Heart, and the next, may be divided into four parts; of which the two first are occupied by what is commonly known as the *first* sound; the third, by the *second* sound; whilst the fourth is a period of *repose*.—The *first* sound is dull and prolonged; it is evidently synchronous with the impulse of the Heart against the parietes of the chest, and also with the pulse, as felt near the heart; it must, therefore, be produced during the Ventricular Systole.—The *second* sound follows so immediately upon the conclusion of the first, that it can scarcely be imagined to take place during the auricular systole as some have supposed, but must be assigned to the period of the first stage of the Ventricular Diastole. This, indeed, may now be regarded as clearly established; for it has been fully demonstrated, that the second sound is due to

the sudden filling-out of the Semilunar valves of the aorta and pulmonary artery, with blood; when the outward current through them has ceased, and the incipient dilatation of the ventricles occasions a vacuum behind them. If one of these valves be hooked back by a curved needle against the side of the artery, so that a reflux of blood is permitted, the sound is entirely suppressed. The *first* sound cannot be so readily or satisfactorily accounted for. That it is partly due to the Impulse of the apex of the Heart, seems proved by the fact, that, when this impulse is prevented, the sound is much diminished in intensity; and also by the circumstance that, when the Ventricles contract with vigour, the greatest intensity of the sound is over the point of percussion. But that it is not entirely due to this cause is also evident from the fact, that a sound may still be heard, when the Heart is contracting out of the body; as in the case observed by Prof. Cruveilhier. This sound has been attributed, by some experimenters, to the flapping-back of the auriculo-ventricular valves; by others to the muscular contraction of the walls of the ventricles; by others again to the rush of blood along the irregular walls of the ventricles, and through the comparatively narrow orifices of the aorta and pulmonary artery. This last is probably the most consistent with truth; as would appear from the following interesting observations made by Cruveilhier. By applying the finger to the origin of the pulmonary artery (which is situated in front of the aorta, and completely conceals it), a perfectly distinct vibratory *frémissement* corresponding with the ventricular diastole, was perceived; but no such vibratory thrill could be felt by the finger, when applied to any part of the base of the ventricles: whence it was evident, that no action takes place in the mitral and tricuspid valves, which can give rise to the same *palpable* effects, as those produced by the semilunar valves. The same was ascertained regarding the valvular *sound*, which could be distinctly heard, by laying the finger against the origin of the pulmonary artery, and applying the ear to it as to a stethoscope: whilst nothing of the kind could be perceived in the region of the auriculo-ventricular valves. Hence it seems quite certain, that the natural first sound cannot be dependent in any way upon the action of the mitral and tricuspid valves. It appeared, on the contrary, that the maximum intensity of the *first* sound was in precisely the same situation as the maximum intensity of the *second*,—namely, at the origin of the large arteries; and that it diminished, as the ear was carried from the base, towards the apex of the heart. Moreover, the *first* sound was observed to be of exactly the same character with the *second* (the complicating effect of the impulse being here withdrawn); except as to its *intensity*, which was *less*,—and its *duration*, which was *greater*.

721. Hence, although these observations do not entitle us to deny the participation of the muscular contraction, and of the movement of the blood over the ventricular walls, in the production of the first sound, they establish (if correct), that the *principal* cause of it exists at the entrances to the arterial trunks; and it does not seem that any other reason can be assigned for it, than the prolonged rush of blood through their orifices, and the throwing back of the Semilunar valves; which, in suddenly flapping down again, produce the second sound.—That an exaggeration of the first sound, not essentially differing from it in character, is often produced by disease of the sigmoid valves, which causes an obstruction of their orifice, has long been known; and in such cases, the character of the second sound is also changed. Indeed, M. Cruveilhier states it as, in his opinion, an uniform occurrence, that disease of the Semilunar valves alters *both* sounds. When this disease is such as to prevent the valves from effectually closing, a reflux of blood takes place into the ventricle at the time of its diastole; causing a rushing sound, more or less prolonged, to be heard in the intervals of the pulse, instead of with it. These considerations appear to prove almost incontestably, that the cause of the first

sound, and that of the second, are very closely allied; and this view, which if correct is of great importance in the explanation of numerous morbid phenomena, harmonizes well with the known effect of a slight obstruction in a tube, through which fluid is being rapidly forced, in producing a prolonged sound, very analogous to the first sound of the heart. The following table may assist the student in connecting the sounds of the Heart with its movements.

FIRST SOUND.	Ventricular Systole, and Auricular Diastole. Impulse of apex against parietes of chest. Pulsation in arteries.
SECOND SOUND.	First stage of Ventricular Diastole.
INTERVAL.	Short repose; then Auricular Systole, and second stage of Ventricular Diastole.

722. The course of the circulating fluid through the Heart, and the action of its different valves, will now be briefly described. The Venous blood, which is returned by the ascending and descending Vena Cava, enters the *right* Auricle during its diastole; and, when it contracts, is forced between the Tricuspid valves, into the Ventricle. The reflux of blood into the veins, during the auricular systole, is prevented by the valves with which they are furnished; but these valves are so formed, as not to close accurately, espe-

[Fig. 212.]

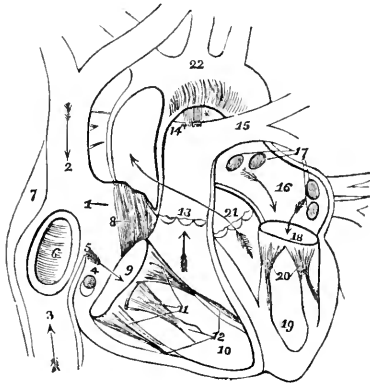

The Anatomy of the Heart; 1, the right auricle; 2, the entrance of the superior vena cava; 3, the entrance of the inferior cava; 4, the opening of the coronary vein, half closed by the coronary valve; 5, the Eustachian valve; 6, the fossa ovalis, surrounded by the annulus ovalis; 7, the tuberculum Low-eri; 8, the musculi pectinati in the appendix auriculæ; 9, the auriculo-ventricular opening; 10, the cavity of the right ventricle; 11, the tricuspid valve, attached by the chordæ tendinæ to the carnæ columnæ (12); 13, the pulmonary artery, guarded at its commencement by three semilunar valves; 14, the right pulmonary artery, passing beneath the arch and behind the ascending aorta; 15, the left pulmonary artery, crossing in front of the descending aorta; *, the remains of the ductus arteriosus, acting as a ligament between the pulmonary artery and arch of the aorta; the arrows mark the course of the venous blood through the right side of the heart; entering the auricle by the superior and inferior cava, it passes through the auriculo-ventricular opening into the ventricle, and thence through the pulmonary artery to the lungs; 16, the left auricle; 17, the openings of the four pulmonary veins; 18, the auriculo-ventricular opening; 19, the left ventricle; 20, the mitral valve, attached by its chordæ tendinæ to two large columnæ carnæ, which project from the walls of the ventricle; 21, the commencement and course of the ascending aorta behind the pulmonary artery, marked by an arrow; the entrance of the vessel is guarded by three semilunar valves; 22, the arch of the aorta. The comparative thickness of the two ventricles is shown in the diagram. The course of the arterial blood through the left side of the heart is marked by arrows. The blood is brought from the lungs by the four pulmonary veins into the left auricle, and passes through the auriculo-ventricular opening into the left ventricle, whence it is conveyed by the aorta to every part of the body.]

cially, when the tubes are distended; so that a small amount of reflux usually takes place, and this is much increased when there is any obstruction to the pulmonary circulation. Whilst the *right* Ventricle is contracting upon the blood that has entered it, the *carneæ columnæ*, which contract simultaneously with its proper walls, put the *chordæ tendinæ* upon the stretch; and these draw the flaps of the Tricuspid valve into the auriculo-ventricular axis. The blood then getting behind them, and being compressed by the contraction of the ventricle, forces the flaps together in such a manner as to close the orifice; but they do not fall suddenly against each other, as is the case with the semilunar valves, since they are restrained by the *chordæ tendinæ*; whence it is, that no sound is produced by their closure. The blood is expelled by the ventricular systole into the Pulmonary Artery, which it distends, passing freely through the Semilunar valves; but as soon as the *vis à tergo* ceases, and reflux might take place by the contraction of the arterial walls, the valves are filled out by the backward tendency of the blood, and completely check the return of any portion of it into the ventricle. The blood, after having circulated through the lungs, returns as Arterial blood, by the Pulmonary Veins, to the *left* Auricle; whence it passes through the mitral valves into the *left* Ventricle, and thence into the Aorta,—in the same manner with that on the other side, as just described.

723. There are, however, some important differences in the structure and functional actions of the two divisions of the Heart, which should be here adverted to.

a. The walls of the *left* Ventricle are considerably thicker than those of the *right*; and its force of contraction is much greater. The following are the comparative results of M. Bizot's recent measurements, taking the average of males from 16 to 89 years.

	BASE.	MIDDLE.	APEX.
Left Ventricle	4½ lines	5½ lines	3¾ lines
Right Ventricle	1½ lines	1¾ lines	1¾ lines

In the female, the average thickness is somewhat less. It will be seen that the point of greatest thickness in the *left* Ventricle is near its middle; while in the *right*, it is nearer the base. The thickness of the former goes on increasing during all periods of life, from youth to advanced age; whilst that of the right is nearly stationary. The *left* Auricle is somewhat thicker than the *right*; the average thickness of the former being, according to Bouillaud, a line and a half; whilst that of the latter is only a line. In regard to the relative capacities of the right and left cavities, much difference of opinion has prevailed. The *right* Auricle is generally allowed to be more capacious than the *left*; and the same is commonly taught of the *right* Ventricle. So much fallacy may arise, however, from the peculiar condition of the animal at the moment of death, that this is not easily proved, and is, indeed, by no means certain.

b. Many eminent Anatomists maintain, that the two cavities are equal. The capacity of each of the cavities may be estimated, in the full-sized Heart, at about two ounces; that of the Auricles being probably a little less; and that of the Ventricles a little greater. That the Ventricles receive more blood from the Auricles, than the latter could transmit to them by simply emptying themselves once, seems, therefore, probable; and may be accounted for by the fact already stated, regarding the slight intermission in the Ventricular Diastole, during which more blood may enter the Auricle from the veins.

c. There is a well-known anatomical difference between the Auriculo-Ventricular valves, on the two sides, which has given rise to the diversity of name. This seems, from the researches of Mr. King,* to be connected with an important functional difference. The Mitral valve closes much more perfectly than the Tricuspid; and the latter is so constructed, as to allow of considerable reflux, when the cavities are greatly distended. Many occasional causes tend to produce an accumulation of blood in the venous system, and in the right side of the Heart; thus, any obstruction to the pulmonary circulation, cold, compression of the venous system by muscular action, &c., are known to favour such a condition. This is a state of peculiar danger, from the liability which over-distension of the Ventricular cavity has, to produce a state of muscular paralysis; and in the structure of the Heart itself, there seems to be a provision against it. For, when the ventricle is thus distended, the Tricuspid

* Guy's Hospital Reports, vol. ii.

valves do not close properly; and a reflux of blood is permitted, not only into the Auricle, but also (through the imperfect closure of their valves under the same circumstances), into the large veins. This is proved by the fact, several times observed by Dr. J. Reid, in his experiments upon Asphyxia, &c., that, when the action of the Right Ventricle had ceased from over-distension, he could frequently re-excite it, not merely by puncturing its walls, but by making an opening in the jugular vein. This fact evidently affords an indication of great importance in the treatment of Asphyxia; and it explains the reflux of blood, or *venous pulse*, which is frequently observed in cases of pulmonary disease, and which, according to Mr. King, always exists, though in a less striking degree.

724. It is not quite certain whether the Ventricles empty themselves completely at each contraction; but it seems probable that the blood which they contain, is not entirely forced into the arteries. The quantity which is propelled by each Ventricle, at every stroke, may be estimated, therefore, at from $1\frac{1}{2}$ oz. to 2 oz. If we adopt the lower of these numbers, we shall find that, reckoning 75 pulsations of the Heart to a minute, 112 oz., or 7 lbs., of blood pass through each ventricle in that time; and, on the higher estimate, 150 oz., or 9 lbs. 6 oz., would pass through in the same period. Now the whole quantity of blood contained in the human body, according to the estimate of Haller (which is considered by Dr. Allen Thomson to be near the truth), is about one-fifth of the weight of the body, or 28 lbs. in a person weighing 140 lbs.* This quantity would pass through the Heart, therefore, in four minutes, on the lower of the two preceding estimates, or in three minutes on the higher; and would circulate afresh, fifteen or twenty times in an hour. It would appear, however, that this estimate of the rapidity of the circulation is very far from the truth; for recent experiments have shown, that substances introduced into the Venous circulation, may be detected in the remotest parts of the Arterial circulation, even in animals larger than Man, in less than half a minute.—The earliest of such experiments were those of Hering,† who endeavoured to ascertain the rapidity of the circulation, by introducing Prussiate of Potash into one part of the system, and drawing blood from another. He states that he detected this salt, in blood drawn from one of the Jugular veins of the Horse, within 20 or 30 seconds after it had been introduced into the other; in which brief space the blood must have been received by the Heart, must have been transmitted through the Lungs, have returned to the Heart again, have been sent through the Carotid artery, and have traversed its capillaries. From experiments of a similar nature upon other veins, he states that the salt passed from the Jugular vein into the Saphena in 20 seconds; into the Masseteric artery in from 15 to 20 seconds; into the External Maxillary artery in from 10 to 25 seconds; and into the Metatarsal artery in from 20 to 40 seconds. An attempt has been made to invalidate the inference which seems inevitably to flow from these experiments, in regard to the rate of the circulation, by attributing the transmission of the salt to the permeability of the animal tissues;‡ but it has never been shown, that even Prussiate of Potash (which is probably more transmissible through this channel than any other salt), can be carried from one part to another, with a rapidity at all proportional to this. The only mode in which this property can be conceived materially to facilitate the transmission of the salt through the vascular system, would be by allowing it to pass through the septum of the auricles, and thus to make its way from the right to the left side of the heart, without passing through the pulmonary circulation; and this it could scarcely do, to the large amount which is evidently transmitted, in so short a time.

725. The experiments of Hering have been recently fully confirmed by

* Valentin's estimate, founded upon different data, closely corresponds with this.

† Tiedemann's Zeitschrift, vol. iii. p. 85.

‡ See Dr. Allen Thomson, *loc. cit.*

those of Mr. Blake;* who varied them by employing different substances, and took other precautions against sources of fallacy. Ten seconds after having injected a solution of Nitrate of Baryta into the Jugular vein of a horse, he drew blood from the Carotid artery of the opposite side; after allowing this to flow for five seconds, he substituted another vessel, which received the blood that flowed during the five ensuing seconds; and the blood that flowed after the twentieth second, by which time the action of the Heart had stopped, was received into a third vessel. These different specimens were carefully analyzed. No trace of Baryta could be detected in the blood, which had escaped from the artery between the tenth and fifteenth second after the injection of the poison; but in that which was drawn between the fifteenth and the twentieth second, the salt was found to be present, and in greater abundance than in the blood which had subsequently flowed. Moreover, the coincidence between the cessation of the Heart's action, and the diffusion of the salt through the arterial blood, bear a striking correspondence; and it may be hence inferred, that the arrestment of its muscular movement is due to the effect of this agent upon its tissue, when immediately operating upon it, through the capillaries of the coronary artery. This conclusion is borne out by a variety of other experiments; which show that the time of the agency of other poisons, that suddenly check the Heart's action (which is the especial property of *mineral* poisons), nearly coincides, in different animals, with that which is required to convey them into the Arterial capillaries. And it seems to derive full confirmation from the fact, that poisons, which act locally on other parts, give the first indications of their operation, in the same period after they have been introduced into the Venous circulation. Thus, in the Horse, the time that is required for the blood to pass from the Jugular vein into the capillary terminations of the Coronary arteries, is 16 seconds; as is shown by the power of Nitrate of Potass to arrest the Heart's action within that time: and Nitrate of Strychnia, injected into a vein, gave the first manifestation of its action on the Spinal Cord, in precisely the same number of seconds. In the Dog, the Heart's action was arrested by the Nitrate of Potass in 11 or 12 seconds; and the tetanic convulsions occasioned by Strychnia, also commenced in 12 seconds. In the Fowl, the former period was 6 seconds, and the latter $6\frac{1}{2}$; in the Rabbit, the first was 4, and the other $4\frac{1}{2}$ seconds. From these experiments, it seems difficult to resist the conclusion, that the rapidity of the Circulation is very much underrated, in any estimate that we found upon the capacity of the Heart, and its number of pulsations in a given time; and that some other force, than its contractions, must have a share in producing the movement of the blood through the vessels.

726. The *force* with which the Heart propels the Blood, may be estimated in two ways;—either by ascertaining the height of the column of that fluid, which its contractile action will support;—or by causing the blood to act upon a shorter column of mercury.—The former method was the one adopted by Hales, who introduced a long pipe into the Carotid artery of a Horse, and found that the blood would sometimes rise in it to the height of 10 feet. From parallel experiments upon Sheep, Oxen, Dogs, and other animals, and by comparing the calibre of their respective vessels with that of the Human aorta. Hales concluded, that the usual force of the Heart in Man would sustain a column of blood $7\frac{1}{2}$ feet high, the weight of which would be about 4 lbs. 6 oz.—The second method is that more recently adopted by Poissonne; and the instrument which he contrived for carrying it into practice (termed by him the Hæmadynamometer) has been the means of aiding many valuable inquiries on the physiology of the Circulation. The result of his experiments is

* Edinb. Med. and Surg. Journal, Oct. 1841.

very nearly the same as that of Hales; his estimate of the force, with which the blood is propelled into the Aorta, being 4 lbs. 3 oz. The backward pressure upon the walls of the Heart, or in other words the force which they have to overcome in propelling the blood, is properly estimated, by multiplying the pressure of blood in the aorta, into the surface of a plane passing through the base and apex of the left ventricle; by which calculation it is found to be about 13 lbs.* The pressure appears, from the experiments of Poisseuille, to be very nearly equal for equal surfaces, throughout the larger arterial branches; since it diminishes regularly in proportion to their calibre; in the radial artery at the wrist, it was estimated by him at 4 drachms.

727. The number of contractions of the Heart in a given time, is liable to great variation, within the limits of ordinary health, from several causes; the chief of these are, diversities of Age, of Sex, of Muscular exertion, of the condition of the Mind, of the state of the Digestive system, and of the Period of the day.

a. Putting aside the other causes of uncertainty, the following table may be regarded as an approximation to the average frequency of the Pulse, at the several ages specified in it.

	BEATS PER MINUTE.
In the fœtus in utero	140 — 150
Newly-born infant	130 — 140
During the First year	115 — 130
During the Second year	100 — 115
During the Third year	90 — 100
About the Seventh year	85 — 90
Age of Puberty	80 — 85
Manhood	70 — 80
Old age	50 — 65

b. The difference caused by sex is very considerable, especially in adult age; it appears from the inquiries of Dr. Guy,† that the pulse of the adult Female exceeds in frequency the pulse of the adult Male, at the same mean age, by from 10 to 14 beats in a minute.

c. The effect of muscular exertion in raising the pulse is well known; as is also the fact, which is one exemplification of it, that the pulse varies considerably with the posture of the body. The amount of this variation has been made the subject of extensive inquiry by Dr. Guy; and the following are his results. In 100 healthy Males, of the mean age of 27 years, in a state of rest, the average frequency of the pulse was, when standing, 79,—when sitting, 70,—and when lying, 67 per minute. Several exceptions occurred, however, to the general law; and when these were excluded, the average numbers were,—standing, 81,—sitting, 71,—and lying, 66; so that the difference between standing and sitting was 10 beats, or 1-8th of the whole; the difference between sitting and lying was 5 beats, or 1-13th of the whole; and the difference between standing and lying was 15 beats, or 1-5th of the whole. In 50 healthy Females, of the same mean age, the average pulse, when standing, was 89,—

* The extreme latitude of the estimates which have been made of this force, has been a subject of not undeserved ridicule. Borelli imagined it to be 180,000 lbs.; whilst by Keill it was supposed to be no more than from 5 to 8 ounces.

† Guy's Hospital Reports, vol. iii. p. 312.

[Fig. 213.]

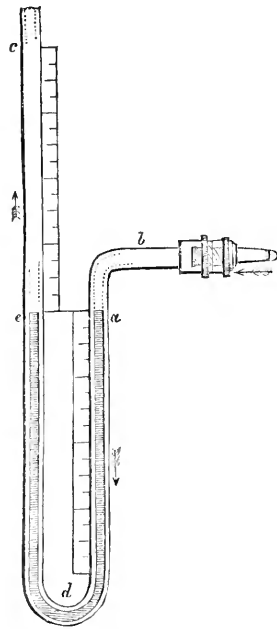

Hemodynamometer of Poisseuille. A bent glass tube, filled with mercury in the lower part, *a d e*. The horizontal part *b*, is provided with a brass head, which fits into the artery. A small quantity of a solution of the carbonate of soda is interposed between the mercury and the blood, to prevent its coagulation. When the blood presses on the fluid in the horizontal limb, the rise of the mercury towards *e*, measured from the level to which it has fallen towards *a*, gives the pressure under which the blood moves.]

when sitting, 81,—and when lying, 80. When the exceptions (which were more numerous in proportion than in males) were excluded, the averages were, standing, 91,—sitting, 84,—lying, 79; the difference between standing and sitting was thus 7 beats, or 1—13th of the whole; that between sitting and lying was 4, or 1—21st of the whole; and that between standing and lying was 11, or 1—8th of the whole. In both sexes, the effect produced by change of posture increases with the usual frequency of the pulse; whilst the exceptions to the general rule are more numerous, as the pulse is less frequent. The variation is temporarily increased by the muscular effort, involved in the absolute change of the posture; and it is only by the use of a revolving board, by which the position of the body can be altered, without any exertion on the part of the subject of the observation, that correct results can be obtained. That the difference between standing and sitting should be greater than that between sitting and lying, is just what we should expect; when we compare the amount of muscular effort required in the maintenance of the two former positions respectively.

d. The Pulse is well known to be much accelerated by Mental excitement, especially by that of the Emotions; it is also quicker during Digestion; but on neither of these points can any exact numerical statement be given.

e. The diurnal variation of the pulse, however, has been made the subject of observation by Dr. Guy;* and, as the results of his inquiries have much interest, although (from having been made only on his own person) they may ultimately require some modification, they will be here stated. "1. The pulse of a healthy male in a state of rest, unexcited either by food or exercise, is most frequent in the morning, and gradually diminishes as the day advances. 2. The pulse diminishes in frequency more rapidly in the evening, than in the morning. 3. The diminution in the frequency of the pulse (after excitement) is more regular and progressive in the evening than in the morning. 4. The effect of food is greater and more lasting in the morning, than in the evening; and in some instances, the same food, which in the morning produces an effect considerable both in amount and duration, has no effect whatever in the evening." It may be hoped that, ere long, this interesting and important subject will receive further elucidation.

[f. Dr. Valleix has recently published a series of interesting observations on the frequency of the pulse in newly-born infants, and in children aged from seven months to six years. He obtained the following results: 1. At birth the pulse is less frequent than at six months; the number of beats in a minute may be stated with considerable exactness to be between 90 and 100. 2. Increase of temperature, even in the slightest degree, invariably produces a notable acceleration of the pulse. The exact ratio between the degree of elevation of temperature and the increase in the frequency of the pulse, is not yet accurately ascertained. 3. Although the observations of Dr. Valleix show a progressive diurnal diminution in the frequency of the pulse, still, he thinks, it would be premature to conclude that these facts support those of Dr. Guy. Dr. Valleix examined his patients in the morning after they had been eating, and to this fact, he thinks, should be attributed the acceleration of the pulse in the early part of the day, and its subsequent diminution towards evening. 4. The slightest muscular effort in children is sufficient to augment considerably the number of pulsations. The same is true of any moral emotion. 5. The influence of sex on the pulse is very marked in young children. The pulse is much more frequent in young girls than in boys of the same age. 6. During sleep there is a decided diminution in the number of beats. 7. Between 7 and 27 months there is no sensible change in the frequency of the pulse. Its mean may be stated at 126 beats in the minute, without distinction of sex. If sex be considered, it would be 121 for males and 128 for females. These numbers express the frequency of the pulse at this age under ordinary circumstances, but if a state of perfect calm is supposed, the numbers would be 119 for the males, and 124 for females. 8. After some observations, not very numerous, however, the pulse would appear to range a little above 100 till six years of age. 9. The mean number of inspirations in a minute in children aged from 7 months to two years and a half, is between 30 and 32, and is to number of pulsations : : 1 : 4.—M. C.]

3.—*Movement of the Blood in the Arteries and Capillaries.*

728. We have next to consider the influence of the Arterial tubes on the flow of Blood through them. This influence is exerted by the middle or fibrous coat, which alone is possessed of contractile properties. We find in this coat, a layer of annular fibres, possessing no small resemblance to that of which the muscular coat of the alimentary canal is composed. On the out-

* Op. cit., vol. iv. p. 69.

side of this, is a layer of yellow elastic tissue, which is much thicker in the larger arteries, in proportion to their size, than in the smaller. To this last tissue is due the simple *elasticity* of the arterial walls, which is a physical property that persists after death, until a serious change takes place in their composition: whilst to the one first mentioned, we are to attribute the property which they unquestionably possess—in common with proper muscular tissue,—of *contracting* on the application of a stimulus, so long as their vitality remains. These two endowments exist, in various proportional degrees, in the different parts of the Arterial system. Thus it was justly remarked by Hunter, that *elasticity*, being the property by which the interrupted force of the Heart is made equable and continuous, is most seen in the large vessels more immediately connected with that organ. On the other hand, the *contractility* is most observable in the smaller vessels, where it is more required for regulating the flow of blood towards particular organs.

729. It is easily shown that the action of the *Elasticity* of the Arterial tubes, is one of a purely physical character; and that its purpose is to convert the intermitting impulses, which the fluid receives from the heart, into a continuous current. The former are very evident in the larger trunks; but they diminish with the subdivision of these, until they entirely disappear in the capillaries, in which the stream is usually equable or nearly so. We may imagine a powerful forcing-pump injecting water, by successive strokes, into a system of tubes with unyielding walls;—the flow of fluid at the farther extremities of these tubes, would be as much interrupted as its entrance into them. But if an air-vessel (like that of a fire-engine) were placed at their commencement, the flow would be in a great degree equalized; since a part of the force of each stroke would be spent upon the compression of the air included in it; and this force would be restored by the elasticity of the air during the interval, which would propel the stream, until directly renewed by the next impulse. A much closer imitation of the natural apparatus would be afforded, by a pipe which had elastic walls of its own; if water were forced by a syringe into a long tube of caoutchouc, for example, the stream would be equalized before it had proceeded far. This effect is found to be accomplished, at any point of the Arterial circulation, in a degree proportionate to its distance from the Heart; and it is another effect of the same cause, that the pressure of the blood upon the wall of the arteries (as shown by the experiments of Poisseuille) is nearly the same all over the system. It is to the distension of the arterial tubes, both in their length and calibre, that their pulsation is due. Their elongation is the more considerable of the two effects; and it causes the artery to be lifted from its seat and to become curved. The transverse dilatation has been denied by some physiologists; but it has been recently proved to take place, by an ingenious experiment of Poisseuille's. The increase of capacity, however, is not more than 1-10th; so that the increase of diameter will not be so much as 1-20th,—a quantity scarcely perceptible to ordinary measurement. The transmission of the pulse-wave through the whole system is not instantaneous, but takes place in an appreciable time. The pulsation of the large arteries near the Heart, is synchronous with the Ventricular systole; but that of other arteries is somewhat later,—the difference varying with their distance, and amounting in some instances to between 1-6th and 1-7th of a second.

730. It has been denied by many Physiologists, that the middle coat of the Arteries possesses any property which can be likened to Muscular *Contractility*; and it will therefore be desirable to enter somewhat in detail into the question. That it cannot be readily stimulated to contraction, through the medium of its nerves, is universally admitted; but the same is the case in regard to the Muscular coat of the alimentary canal, which contracts most

vigorously on the direct application of stimuli to itself; and Valentin and others have recently succeeded in producing evident contractions in the Aorta, by irritation of the Sympathetic nerve, and of certain roots of the Spinal nerves. Further, although many experiments have failed in producing contractions of this tissue, by stimuli directly applied to itself, yet others have distinctly witnessed them; and, in any question of this kind, the positive evidence must be held to outweigh the negative. Thus Verschuier states, that he has seen arteries contract, when stimulated by the mineral acids, by electricity, and by the application of the point of a scalpel. Dr. Thomson also saw them contract, on the application of ammonia, and when punctured with the point of a fine needle, in the living body. It has been ascertained by the direct and careful experiments of Poisseuille, that, when the artery is dilated by the blood injected into it from the heart, it reacts with a force superior to the impressing impulse; and he has also shown that, if a portion of an artery from an animal recently dead (in which the vital contractility seems to be preserved), and one from an animal that has been dead some days (in which nothing but the elasticity remains), be distended with an equal force, the former becomes much more contracted than the latter, after the distending force is removed.

731. Several experiments also indicate the existence of that power of slow contraction in the arteries, which has been distinguished by the appellation *Tonicity*; but which does not seem anything else than a particular manifestation of the general property of vital contractility, and is certainly of a nature quite distinct from ordinary elasticity. Thus, when a ligature is placed upon an artery in a living animal, the part of the artery beyond the ligature becomes gradually smaller, and is emptied to a certain degree, if not completely, of the blood it contained. Again, when part of an artery in a living animal is isolated by means of two ligatures, and is punctured, the blood issues from the orifice, and the inclosed portion of the artery is almost completely emptied of its contents. The exposure of arteries to the air was found by Hunter to occasion their contraction, to such an extent, that obliteration of their tube was the result; and this statement has been subsequently confirmed. Further, every Surgeon knows, that the contraction of divided arteries is an efficient means of the arrest of hemorrhage from them, especially when they are of small calibre; so that, in the case of the temporal artery, for example, the complete division of the tube is often the readiest means of checking the flow of blood from it, when it has been once wounded. This contraction is much greater than could be accounted for by the simple elasticity of the tissue; and is more decided in small, than in large vessels. The empty condition of the arteries, generally found within a short time after death, seems to be in part due to the same cause; since their calibre is usually much diminished, and is sometimes completely obliterated. A remarkable example of the same slow contraction, is that which takes place in the end of the upper portion of an arterial trunk, when the passage of blood through it is interrupted by a ligature; for the current of blood then passes off by the nearest large lateral branch; and the tube of the artery shrivels, and soon becomes impervious, from the point at which the ligature is applied, back to the origin of that branch. This last fact is important, as proving how little influence the *vis à tergo* possesses over the calibre of arterial tubes; since, without any interruption to the pressure of blood occasioned by it, the tube becomes impervious.— It is to the moderate action of the *Tonicity* of arteries, that their contraction upon the stream of blood passing through them (which serves to keep the tubes always full) is due. If the tonicity be excessive, the pulse is hard and wiry; but if it be deficient, the pulse is very compressible, though bounding, and the flow of blood through the arteries is retarded. Dr. Williams has

performed some ingenious experiments, which prove that the force required, to propel fluid through a tube, whose sides are yielding, is very much greater than that which will carry it through a tube of even smaller size, with rigid parietes; consequently, a loss of tonicity in the blood-vessels retards the flow of blood through them; whilst an increase hastens it. The Tonicity of the arteries differs from their ordinary Contractility, in being augmented by cold, and diminished by warmth. Hence cold and heat are two most valuable remedial agents, when this property is deficient or in excess.

732. It is still to be inquired, in what manner the Contractility of the Arteries is to be regarded as influencing the flow of Blood through them. It is at once evident, that any *general* contraction of the arterial tubes would have rather the effect of opposing, than of assisting the flow; but if the fibrous coat of the Arteries is in some degree disposed to the alternate contraction and relaxation, which are so remarkable in the Heart, they *may* exert a force which shall be supplementary to that of the Heart's impulse,—relaxing to receive the blood from it, and contracting upon their contents, with a power superior to that by which they were distended. It is difficult to say whether or not this be the case; though there would certainly appear some evidence in favour of the supposition. The loss of the Heart's power over the currents of blood, in proportion to their degree of subdivision, occasioned by the increased friction to which they will be subjected, would seem to require some compensating power, in order that the perfect equality of pressure may be obtained which has been spoken of as existing in all parts of the arterial system. In no other way than this can the fibrous coat of the Arteries be regarded as having any propulsive power over their contents; except by a peristaltic or vermicular movement, resembling that which takes place in the alimentary canal; and of such there is no evidence whatever.—A very important use may be assigned to this muscular coat, which has been generally overlooked by Physiologists,—that of *regulating* the diameter of the tubes, in accordance with the quantity of blood to be conducted through them to any part; which will depend upon its peculiar circumstances at the time. Such local changes are continually to be observed, in the various phases of normal life, as well as in diseased states; and they will be found to be constantly in harmony with the particular condition of the processes of Nutrition, Secretion, &c., to which the Capillary circulation ministers. Of this kind are the enlargement of the trunks of the Uterine and Mammary arteries, at the epochs of pregnancy and lactation;—the enlargement and strongly-increased pulsation of the Radial artery, when there is any active inflammation in the thumb;—the enormous diameter which the Spermatic artery will attain, when the testicle is greatly increased in size by diseased action; and many other similar phenomena. In such cases, it cannot be the action of the Heart that increases the calibre of the vessels; since this is commonly unaltered, and is itself unable, as we have just seen, even to maintain their permeability. It must, therefore, be by a power inherent in themselves, that their dilatation is effected. The minute distribution of the Sympathetic nerve upon the walls of the arteries,—the known power which this has of producing contractions, alike in their fibrous coat, and in the muscular tunic of the intestinal canal,—and various phenomena, which indicate the power of certain states of mind over the dimensions of the arteries, in particular parts of the body at least,—render it highly probable that the calibre of the arteries is regulated in no inconsiderable degree through its intervention.* The *permanent* dilatation, however, which is seen in the arteries supplying parts that are undergoing

* For Anatomical evidence to this effect, see Henle on the Contractility of the Blood-vessels, in Casper's Wochenschrift, May 1840, and Brit. and For. Med. Rev., vol. x. p. 551.

enlargement, must be due, not to simple dilatation merely, but to increased nutrition; since we find that their walls are thickened as well as extended. And, on the other side, when slow contraction occurs in these tubes, as a consequence of disease, it must be in part occasioned by atrophy; since their nutrition is so much diminished, that in time they almost entirely disappear,—a portion of a large artery occasionally shriveling into a ligamentous band.

733. We now come to the last head of the inquiry into the powers which convey the blood through the capillary system;—that, namely, which concerns the agencies existing in the Capillaries themselves. Many discussions on this subject may be found in Physiological writings; and it has so immediate a bearing on one of the most important questions in Pathology,—the nature of Inflammation,—that it deserves the fullest attention. The chief question in debate, is the degree in which the Capillary circulation is influenced by any other agency than the contractile power of the Heart and Arterial system;—some Physiologists maintaining that this alone is sufficient to account for all the phenomena of the Capillary circulation;—and others asserting that it is necessary to admit some supplementary force, which may be exerted either to assist, retard, or regulate the flow of blood from the Arteries into the Veins. We shall first consider what evidence there is of the existence of any such force; and, when led to an affirmative conclusion, we shall examine into its nature.—No physiological fact is more clearly proved than the existence, in the lower classes of Animals, as well as in Plants, of some power independent of a *vis à tergo*, by which the circulating fluid is caused to move through their vessels (§§ 712—716). This power seems to originate in themselves, and to be closely connected with the state of the Nutritive and Secreting processes: since anything which stimulates these to increased energy, accelerates the circulation: whilst any check to them occasions a corresponding stagnation. It may be convenient to designate this motor force by the name of *capillary power*; it being clearly understood, however, that *no mechanical* propulsion is thence implied. On ascending the Animal scale, we find the power which, in the lower organisms, is diffused through the whole system, gradually concentrated in a single part; a new force, that of the Heart, being brought into operation, and the Circulation placed, in a greater or less degree, under its control. Still there is evidence, that the movement of blood through the capillaries is not entirely due to this; since it may continue after the cessation of the Heart's action,—may itself cease in particular organs when the Heart is still acting vigorously,—and is constantly being affected in amount and rapidity, by causes originating in the part itself, and in no way affecting the Heart. The chief proofs of these statements will now be adverted to.

734. When the flow of blood through the Capillaries of a transparent part, such as the web of a Frog's foot, is observed with the Microscope, it appears at first to take place with great evenness and regularity. But on watching the movement for some time, various changes may be observed, which cannot be attributed to the Heart's influence, and which show that a certain regulating or distributive power exists in the walls of the capillaries, or in the tissues which they traverse. Some of these changes, involving variations in the *size* of the Capillary tubes, have been already referred to (§ 219). Others, however, are manifested in great and sudden alterations in the velocity of the current; which cause a marked difference in the rates of the movement of the blood through the several parts of the area under observation. Sometimes this variation extends even to the entire reversion, for a time, of the direction of the movement, in certain of the transverse or communicating branches; the flow always taking place, of course, from the stronger towards the weaker cur-

rent. Not unfrequently an entire stagnation of the current, in some particular tube, precedes this reversal of its direction. Irregularities of this kind, however, are more frequent when the Heart's action is partially interrupted; as it usually is by the pressure, to which the Tadpole or other animal must be subjected, in order to allow microscopic observations to be made upon its circulation. Under such circumstances, the varieties in the capillary circulation, induced by causes purely local, become very conspicuous; for when the whole current has nearly stagnated, and a fresh impulse from the heart renews it, the movement is not by any means uniform (as it might have been expected to be) through the whole plexus supplied by one arterial trunk, but is much greater in some of the tubes than it is in others; the variation being in no degree connected with their size, and being very different at short intervals.

735. The movement of the blood in the Capillaries of cold-blooded animals, after complete excision of the Heart, has been repeatedly witnessed. In warm-blooded animals, this cannot be satisfactorily established by experiment, since the shock occasioned by so severe an operation much sooner destroys the general vitality of the system; but it may be proved in other ways to take place. After most kinds of natural death, the arterial system is found, subsequently to the lapse of a few hours, almost or completely emptied of blood; this is partly, no doubt, the effect of the tonic contraction of the tubes themselves; but the emptying is commonly more complete than could be thus accounted for, and must, therefore, be partly due to the continuance of the capillary circulation. Moreover, when death has taken place suddenly from some cause (as, for instance, a violent electric shock), that destroys the vitality of the whole system at once, the arterial tubes are found to contain their due proportion of blood. Further, it has been well ascertained that a real process of secretion not unfrequently continues after general or somatic death; urine has been poured out by the ureters, sweat excluded from the skin, and other peculiar secretions formed by their glands; and these changes could not have taken place unless the capillary circulation were still continuing. In the early embryonic condition of the highest animals, the movement of blood seems to be unquestionably due to some diffused power, independent of any central impulsion; for it may be seen to commence in the Vascular Area, before the development of the Heart. The first movement is *towards* instead of *from*, the centre; and even for some time after the circulation is fairly established, the walls of the Heart consist merely of cells loosely attached together, and can hardly be supposed to have any great contractile power.

736. The last of these facts may be said not to have any direct bearing on the question, whether the Capillary power has any existence in the adult condition; but the phenomena occasionally presented by the Fœtus, at a later stage, appear decisive. Cases are of no very unfrequent occurrence, in which the heart is absent during the whole of embryonic life, and yet the greater part of the organs are well developed. In most or all of these cases, however, a perfect twin fœtus exists; of which the placenta is in some degree united with that of the imperfect one; and it has been customary to attribute the circulation in the latter, to the influence of the heart of the former, propagated through the placental vessels. This supposition has not been disproved (however improbable it might seem) until recently; when a case of this kind occurred, which was submitted to the most careful examination by an accomplished anatomist;* and this decisive result was obtained, that it seemed

* See Dr. Houston in the Dublin Medical Journal, 1837. An attempt has been recently made by Dr. M. Hall (Edinb. Monthly Journal, 1843) to disprove Dr. Houston's inferences;

impossible for the heart of the twin fœtus to have occasioned the movement of blood in the imperfect one; and that some cause present in the latter, must have been sufficient for the propulsion of blood through its vessels. It was a very curious anomaly in this case, that the usual functions of the Arteries and Veins must have been reversed; for the Vena Cava, receiving its blood from the Umbilical Vein nearly as usual, had no communication with the Arterial system (the Heart being absent), except through the Systemic Capillaries; to which, therefore, the blood must have next proceeded, returning to the placenta by the Umbilical Artery. This view of the course of the blood was confirmed by the fact, that the veins were everywhere destitute of valves. —It is evident, that a single case of this kind, if unequivocally demonstrated, furnishes all the proof that can be needed, of the existence, even in the highest animals, of a capillary power: which, though usually subordinate to the Heart's action, is sufficiently strong to maintain the circulation by itself, when the power of the central organ is diminished. In this, as in many other cases, we may observe a remarkable power in the living system, to adapt itself to exigencies. In the acardiac Fœtus, the capillary power supplies the place of the Heart, up to the period of birth; after which, of course, the circulation ceases, for want of due aeration of the blood. It has occasionally been noticed, that a gradual degeneration in the structure of the Heart has taken place during life, to such an extent that scarcely any muscular tissue could at last be detected in it; without any such interruption to the circulation, as must have been anticipated, if it furnished the sole impelling force.

737. Further, it is a general principle, unquestioned by any Physiologist, and embodied in the ancient aphorism *Ubi stimulus, ibi fluxus*, that, when there is any local excitement to the processes of Nutrition, Secretion, &c., a determination of blood *towards* the part speedily takes place, and the motion of blood *through* it is increased in rapidity; and although it might be urged, that this increased determination may not be the effect, but the cause, of the increased local action, such an opinion could not be sustained, without many inconsistencies with positive facts. For it is known that such local determinations may take place, not only as a part of the regular phenomena of growth and development (as in the case of the entire genital system at the time of puberty and of periodical heat, the uterus after conception, and the mammæ after parturition), but also as a consequence of a strictly local cause. Thus, the student is well aware that, after several hours' close application, there is commonly an increased determination of blood to the brain, causing a sense of oppression, a feeling of heat, and frequently a diminished action in other parts; and, again, when the capillary circulation is being examined under the microscope, it is seen to be quickened by moderate stimuli, and equally retarded by depressing agents. All these facts harmonize completely with the phenomena, which are yet more striking in the lower classes of organized beings, and which are evidently the results of the same laws.

738. It is equally capable of proof, on the other hand, that an influence generated in the Capillaries may afford a complete check to the circulation in the part; even when the Heart's action is unimpaired, and no mechanical impediment exists to the transmission of blood. Thus, cases of spontaneous gangrene of the lower extremities are of no unfrequent occurrence, in which the death of the solid tissues is clearly connected with a local decline of the circulation; and in which it has been shown, by examination of the limb after its removal, that both the larger tubes and the capillaries were completely

but a most satisfactory reply has been made by Dr. Houston, at the Meeting of the British Association, August 1843, and published in the Dublin Journal, Jan. 1844. See also Edinb. Med. and Surg. Journ. July 1844.

pervious ; so that the cessation of the flow of blood could not be attributed to any impediment, except that arising from the cessation of some power which exists in the capillaries, and which is necessary for the maintenance of the current through them. The influence of the prolonged application of Cold to a part, may be quoted in support of the same general proposition ; for, although the calibre of the vessels may be diminished by this agent, yet their contraction is not sufficient to account for that complete cessation of the flow of blood through them which is well known to occur, and to terminate in the loss of their vitality. The most remarkable evidence on this point, however, is derived from the phenomena of Asphyxia, which will be more fully explained in the succeeding Chapter. At present it may be stated as a fact, which has now been very satisfactorily ascertained, that, if admission of air into the lungs be prevented, the circulation through them will be brought to a stand, as soon as the air which they contain has been to a great degree deprived of its oxygen, or rather has become loaded with carbonic acid ; and this stagnation will, of course, be communicated to all the rest of the system. Yet, if it have not continued sufficiently long, to cause the loss of vitality in the nervous centres, the movement may be renewed by the admission of air into the lungs. Now, although it has been asserted that the stagnation is due to a mechanical impediment, resulting from the contracted state of the lungs in such cases, this has been clearly proved not to be the fact, by causing animals to breathe a gas destitute of oxygen, so as to produce Asphyxia in a different manner ; the same stagnation results as in the other case.

739. If the phenomena which have been here brought together, be considered as establishing the existence, in all classes of beings possessing a circulating apparatus, of a Capillary power, which affords a necessary condition for the movement of the nutritive fluid, through those parts in which it comes into more immediate relation with the solids,—the question still remains open, as to its nature. That the Capillaries possess a contractile power, far higher in degree than that of the large Arteries, and more easily excited than that of the smaller, appears scarcely to admit of doubt ; though to what it is due, may be reasonably questioned. It has been recently asserted by Schwann, that they possess the same kind of fibrous tissue in their walls, as do the large vessels : and this cannot be regarded as improbable. It is not possible, however, that their contractility could have any influence in aiding the continuous motion of blood through them ; unless it were exercised in a very different manner from that of which observation affords us evidence. For, when we are microscopically examining the Capillary circulation of any part, it is at once seen, that the vessels present no obvious movement ; and that the stream, now rendered continuous by the elasticity of the arteries, passes through them, as through unelastic tubes. The only method, in which the contractility of the Capillaries could produce a regular influence on the current of blood, would be an alternate contraction and dilatation, or a peristaltic movement ; and of neither of these can the least traces be discerned. Hence we should altogether dismiss from our minds the idea of any *mechanical* assistance, afforded by the action of the Capillaries, to the movement of the blood. That the contractile coat of the Capillaries has for its office, to regulate the calibre of the vessels, can scarcely be doubted ; but any general permanent contraction would only occasion an obstacle to the circulation,—as is shown by the effects of stimulating injections, which, if thrown into the vessels before their vitality has been lost, will not pass through the capillaries. It would appear, therefore, to be through their action on this coat, that local stimuli occasion a contraction of the capillaries ; their effect, however, is different from what might have been anticipated ; for, instead of the capillary circulation being retarded, it is accelerated, at least until an abnormal condition

results from their continued operation. Here, again, is another evidence, that something different from *mechanical* power must be the agent, that operates in all the foregoing cases.

740. It appears, from the preceding facts, that the conditions, under which the power in question uniformly operates, may be thus simply and definitely expressed:—Whilst the injection of blood *into* the Capillary vessels of every part of the system, is due to the action of the Heart, its rate of passage *through* those vessels is greatly modified by the degree of activity in the processes, to which it should normally be subservient in them;—the current being rendered more rapid by an increase in their activity, and being stagnated by their depression or total cessation.—Thus it seems that “the capillaries possess a *distributive* power over the blood, regulating the local circulation, independently of the central organ, in obedience to the necessities of each part.” If this be true, it is evident that the dilatation or contraction of the Capillaries will only have a secondary influence on the movement of the blood through them. The former condition is usually an indication of diminished vital energy; and when it is observed, it is almost invariably accompanied by a retardation or partial stagnation of the current; on the other hand, the application of a moderate stimulus, which excites the contractility, accelerates for a time the motion of the blood, by rendering more energetic that reaction between the fluids and the surrounding tissues, which is the condition that really has the most influence over the current.—That alterations in the chemical state of the blood (involving, of course, important changes in its vital properties) are capable of exercising a most important effect on the Capillary circulation, is shown, not merely by the stagnation of the *Pulmonary* Circulation in Asphyxia (§ 780), but by the curious fact ascertained by Dr. J. Reid,—that the blood, when imperfectly arterialized, is retarded in the *systemic* capillaries, causing an increased pressure on the walls of the arteries. He found that, when the ingress of air through the trachea of a Dog was prevented, and the Asphyxia was proceeding to the stage of insensibility,—the attempts at inspiration being few and laboured, and the blood in an exposed artery being quite venous in its character,—the pressure upon the Arterial walls, as indicated by the hæmadynamometer applied to the Femoral artery, was much greater than usual. Upon applying a similar test to a Vein, however, it was found that the pressure was proportionably diminished; whence it became apparent, that there was an unusual obstruction to the passage of venous blood through the systemic capillaries. After this period, however, the mercury in the hæmadynamometer applied to the artery began to fall steadily, and at last rapidly, in consequence of the diminished force of the heart, and the retardation of the blood in the pulmonic capillaries; but, if atmospheric air was admitted, the mercury rose very speedily, showing that the renewal of the proper chemical state of the blood, restored the condition necessary for its circulation through the Capillaries.

741. The principles already noticed (§ 713) as put forth by Prof. Draper, seem fully adequate to explain these phenomena.

a. The arterial blood,—containing oxygen with which it is ready to part, and being prepared to receive in exchange the carbonic acid which the tissues set free,—must obviously have a greater affinity for the tissues, than venous blood; in which both these changes have already been effected. Consequently upon mere physical principles, the arterial blood which enters the systemic Capillaries on one side, must drive before it, and expel on the other side of the net-work, the blood which has become venous whilst traversing it. But if the blood which enters the Capillaries have no such affinity, no such motor power can be developed.

b. On the other hand, in the Capillaries of the lungs the opposite affinities prevail. The venous blood and the air in the pulmonary cells have a mutual attraction, which is satisfied by the exchange of oxygen and carbonic acid that takes place through the walls of the capillaries; and when the blood has become arterIALIZED, it no longer has any attraction for the

air. Upon the very same principle, therefore, the venous blood will drive the arterial before it, in the pulmonary capillaries, whilst respiration is properly going on: but if the supply of oxygen be interrupted, so that the blood is no longer aerated, no change in the affinities takes place whilst it traverses the capillary net-work; the blood continuing venous, still retains its need of a change, and its attraction for the walls of the capillaries; and its egress into the pulmonary veins is thus resisted, rather than aided, by the force generated in the lungs.

c. The change in the condition of the blood, in regard to the relative proportions of its oxygen and carbonic acid, is the only one to which the Pulmonary Circulation is subservient; but in the Systemic Circulation, the changes are of a much more complex nature;—every distinct organ attracting to itself the peculiar substances which it requires as the materials of its own nutrition; and the nature of the affinities thus generated being consequently different in each case. But the same law holds good in all instances. Thus the blood conveyed to the liver by the portal vein, contains the materials at the expense of which the bile-secreting cells are developed; consequently the tissue of the liver, which is principally made up of these cells, possesses a certain degree of affinity or attraction for blood containing these materials; and this is diminished, so soon as they have been drawn from it into the cells around. Consequently the blood of the portal vein will drive before it, into the hepatic vein, the blood which has traversed the capillaries of the portal system, and which has given up, in doing so, the elements of bile to the solid tissues of the liver.—The same principle holds good in every other case.

742. It can be scarcely doubted, that it is by some influence exercised over the molecular actions, to which the Blood is subject in the Capillaries, that the Nervous system can operate on the functions of Nutrition, Secretion, &c., in the manner already alluded to (Chap. vii.); and this influence may be not improperly termed *vital*, if by so designating it we merely imply that its nature and mode of operation are unknown, but that it is closely connected with those actions which are altogether peculiar to living beings. The following experiment, made by Dr. Wilson Philip, exhibits in a convincing manner the possibility of such an influence. “The web of one of the hind legs of a frog was brought before the microscope; and while Dr. Hastings observed the circulation, which was vigorous, the brain was crushed by the blow of a hammer. The vessels of the web *instantly* lost their power, the circulation ceasing; an effect which cannot arise, as we have seen, from the ceasing of the action of the heart. [Dr. P. here refers to experiments, by which it was ascertained, that the circulation in the capillary vessels of the frog will continue for several minutes, after the interruption of the heart’s action.] In a short time the blood again began to move, but with less force. This experiment was repeated, with the same result. If the brain is not completely crushed, although the animal is killed, the blow, instead of destroying the circulation, increases its rapidity.”* We are not hence to conclude, however, that the Nervous system supplies any influence, which is essential to the continuance of the Circulation; since it is only by such sudden and severe injuries to the nervous centres, as instantaneously destroy the vitality of the whole system (§ 735), that the movement of the blood is arrested. The experiments of Müller and others satisfactorily prove, that mere action of the Nerves does not produce any direct effect upon the Capillary circulation; and this corresponds with the well-known fact, that the Nutritive processes may continue as usual, after this action has been suspended. All the facts, which bear upon the question of the connection between Nervous agency and the forces maintaining the Capillary Circulation, have an equal relation to the functions of Nutrition and Secretion in general; and as already shown, the Nervous System also influences these, by the control it exerts over the diameter of the blood-vessels (§ 730).

* Experimental Inquiry into the Laws of the Vital Functions, 4th edition, p. 52.

4.—Of the Venous Circulation.

743. The Venous system takes its origin in the small trunks that are formed by the re-union of the Capillaries; and it returns the blood from these to the Heart. The structure of the Veins is essentially the same with that of the Arteries; but the fibrous tissue, of which their middle coat is made up, bears more resemblance to the areolar tissue of the skin, than it does either to muscular fibre, or to the true elastic tissue. The Elasticity of the Veins, however, is shown by the jet of blood, which at first spouts out in ordinary venesection; when, by means of the ligature, a distension has been occasioned in the tubes below it. A slight Contractility on the application of stimuli, and on irritation of the Sympathetic nervous fibres, has been observed; but this is not so decided as in the Arteries. The whole capacity of the Venous system is considerably greater than that of the Arterial; the former is usually estimated to contain from 2 or 3 times as much blood as the latter, in the ordinary condition of the circulation; and when we consider the great proportion, which the Veins in almost every part of the body bear to the arteries, we shall scarcely regard even the larger of these ratios as exaggerated. Of course the rapidity of the movement of the blood in the two systems, will bear an inverse ratio to their respective capacities; thus if, in a given length, the Veins contain three times as much blood as the Arteries, the fluid will move with only one-third of the velocity. Even at their origins in the Capillary plexus, the Veins are larger than the Arteries which terminate in the same plexus; so that, wherever the arterial and venous net-works form distinct strata, they are readily distinguished from each other. The Veins are remarkable for the number of *valves* which they contain, formed of duplicatures or loose folds of the internal tunic, between the component laminae of which, contractile fibres are interposed; and also for the dilatations behind these, which, when distended, give them a varicose appearance. The valves are single in the small veins, the free edge of the flap closing against the opposite wall of the vein; in the larger trunks they are double; and in a few instances they are composed of three flaps. The object of these valves is evidently to prevent the reflux of blood; and we shall presently see that they are of important use in assisting in the maintenance of the venous circulation. They are most numerous in those Veins which run among parts affected by muscular movement; and they are not found in the veins of the lungs of the abdominal viscera or of the brain.

744. The movement of the blood through the Veins is, without doubt, chiefly effected by the *vis à tergo* or propulsive force; which results from the action of the Heart and Arteries, and from the additional power generated in the Capillary vessels. This is shown by the immediate arrestment of it, which takes place when these forces are suspended. There are some concurrent causes, however, which are supposed by some to have much influence upon it, and of which the consideration must not be neglected.

a. One of these is the suction-power attributed to the Heart; acting as a *vis à fronte*, in drawing the blood towards it. It is very doubtful how far the Auricles have such a power of active dilatation, as that which would be required for this purpose; and no sufficient evidence has been given, that the current of blood at any distance from the Heart is affected by it. Indeed, for a reason to be presently stated, this may be regarded as impossible.

b. Another important agency has been found by some Physiologists in the Inspiratory movement; this is supposed to draw the blood of the Veins into the chest, in order to supply the vacuum which is created there, at the moment of the descent of the Diaphragm. That the movement in question has *some* influence on the flow of Venous blood into the chest, is evident from the occurrence of the *respiratory pulse*, long ago described by Haller; which may be seen in the veins of the neck and shoulder in thin persons, and in those especially who are suffering from pulmonary diseases. During Inspiration, the Veins are

seen to be partially emptied; whilst during Expiration they become turgid, partly in consequence of the accumulation from behind, and of the check in front; and partly (it may be) in some cases, through an absolute reflux from the veins within the chest (§ 723, c). The fact that, in the immediate neighbourhood of the chest, the flow of blood towards the heart is aided by Inspiration and impeded by Expiration, is further proved by Sir D. Barry's experiment, which consisted in introducing one extremity of a tube into the Jugular vein of a Horse, and the other into water, which exhibited an alternate elevation and depression with inspiration and expiration; this has been repeated and confirmed by several Physiologists. On the other hand, the expiratory movement, while it directly causes accumulation in the Veins, will assist the Heart in propelling the blood into the Arteries; and by the combined action of these two causes are produced, among other effects, the rising and sinking of the Brain, synchronously with expiration and inspiration, which are observed when a portion of the cranium is removed. Several considerations, however, agree in pointing to the conclusion, that no great efficacy can be rightly attributed to the Respiratory movements, as exerting any general influence over the Venous circulation. The Pulmonary circulation, being entirely within the chest, cannot be affected by variations in atmospheric pressure; and it may be further remarked, that the whole mechanism of respiration is so different in Birds, from that which exists in Mammalia, that no vacuum can ever be said to exist in *their* chests, although the venous circulation is performed as actively as usual. The Venous circulation of the fœtus, also, is independent of any such agency. Again, it has been shown experimentally by Dr. Arnott and others, that no suction-power exerted at the farther end of a long tube, whose walls are so deficient in firmness as are those of the Veins, can occasion any acceleration in a current of fluid transmitted through it; for the effect of the suction is destroyed, at no great distance from the point at which it is applied, by the flapping together of the sides of the vessel.

c. One of the most powerful of the general causes which influence the Venous circulation, is doubtless the frequently-recurring action of the Muscles upon their trunks. In every instance that Muscular movement takes place, a portion of the Veins of the part will undergo compression; and as the blood is prevented, by the valves in the veins, from being driven back into the small vessels, it is necessarily forced on towards the Heart. As each set of muscles is relaxed, the Veins compressed by it fill out again,—to be again compressed by the renewal of the force. That the general Muscular movement is an important agent in maintaining the Circulation, at a point above that, at which it would be kept by the action of the Heart and Capillaries alone, appears from several considerations. The pulsations are diminished in frequency by rest, accelerated by exertion, and very much quickened by violent effort. In all kinds of exercise, and in almost every sort of effort, there is that alternate contraction and relaxation of particular groups of Muscles, which has been just mentioned, as effecting the flow of blood through the Veins; and there can be little doubt, that the increased rapidity of the return of blood through them, is of itself a sufficient cause for the accelerated movements of the Heart. When a large number of Muscles are put in action after repose, as is the case when we rise up from a recumbent or a sitting posture, the blood is driven to the Heart with a very strong impetus; and if that organ should be diseased, it may arrive there in a quantity larger than can be disposed of; so that sudden death may be the result. Hence the necessity for the avoidance of all sudden and violent movements, on the part of those who labour under either a functional or structural disease of the centre of the circulation.

745. The Venous circulation is much more liable than the Arterial, to be influenced by the force of Gravity; and this influence is particularly noticeable, when the tonicity of the vessels is deficient.

a. The following experiments performed by Dr. Williams, to elucidate the influence of deficient firmness in the walls of the vessels, and of gravitation, over the movement of fluids through tubes, throw great light on the causes of Venous Congestion.—A tube with two equal arms having been fitted to a syringe, a brass tube two feet long, having several right angles in its course, was adapted to one of them, whilst to the other was tied a portion of a rabbit's intestine four feet long, and of calibre double that of the brass tube, this being arranged in curves and coils, but without angles and crossings. When the two tubes were raised to the same height, the small metal tube discharged from two to five times the quantity of water discharged in a given time by the larger but membranous tube; the difference being greatest, when the strokes of the piston were most forcible and sudden, by which the intestine was much dilated at its syringe end, but conveyed very little more water. When the discharging ends were raised a few inches higher, the difference increased considerably, the amount of fluid discharged by the gut being much diminished; and when the ends were raised to the height of eight or ten inches, the gut ceased to discharge, each stroke only moving the column of water in it, and this subsiding again, without rising high enough to

overflow. When the force of the stroke increased, the part of the intestine nearest the syringe burst.

b. From these experiments it is easy to understand, how any deficiency of tone in the Venous System will tend to prevent the ascent of the blood from the depending parts of the body, and will consequently occasion an increased pressure on the walls of the vessels, and an augmentation in the quantity of blood they contain. All these conditions are peculiarly favourable to the escape of the watery part of the blood from the small vessels; and this may either infiltrate into the areolar tissue, or it may be poured into some neighbouring serous cavity, producing dropsy. Thus it happens, that such effusions may often be traced to that state of deficient vigour of the system, which peculiarly manifests itself in want of tone of the blood-vessels; and that it is relieved by remedies which restore this. In many young females of leuco-phlegmatic temperament, for example, there is a tendency to swelling of the feet, by œdematous effusion into the areolar tissue, in consequence of the depending position of the limbs; the œdema disappears during the night, but returns during the day, and is at its maximum in the evening. And the congestion which frequently manifests itself in the posterior parts of the body, towards the close of exhausting diseases, in which the patient has lain much upon his back, is attributable to a similar cause; of such congestion, effusions into the various serous cavities are frequent results; and such effusions, taking place during the last hours of life, are often erroneously regarded as the cause of death. To the same cause we are to attribute the varicose state of the veins of the leg, which is so common amongst persons of relaxed fibre, and especially in those whose habits require them to be much in the erect posture; and this distension occasionally proceeds to complete rupture, the causes of which are fully elucidated by the experiments just cited.

5.—*Peculiarities of the Circulation in different Parts.*

746. In several portions of the Human body, there are certain varieties in the distribution and in the functional actions of the Blood-Vessels, which should not be omitted in a general account of the Circulation. Of these, we have in the first place to notice the apparatus for the Pulmonary circulation; the chief peculiarity of which is, that *venous* blood is sent *from* the heart, through a tube which is Arterial in its structure, whilst *arterial* blood is returned *to* the heart, through a vessel whose entire character is that of a Vein. The movement of the blood through these is considerably affected by the physical state of the Lungs themselves; being retarded by any causes, which can occasion pressure on the vessels (such as over-distension of the cells with air, obstruction of their cavity by solid or fluid depositions, or by foreign substances injected into them, &c.); and proceeding with the greatest energy and regularity, when the respiratory movements are freely performed.—The Portal circulation, again, is peculiar, in being a kind of offset from the general or systemic circulation; and also in being destitute of valves; and it may be surmised with much probability, that the purpose of their absence is, to allow of an unusually free passage of blood from one part of that system to another, during the very varying conditions to which it is subjected (§ 685).

747. Another very important modification of the Circulating system, is that which presents itself within the Cranium. From the circumstance of the cranium being a closed cavity, which must be always filled with the same total amount of contents, the flow of blood through its vessels is attended with some peculiarities. The pressure of the atmosphere is here exerted, rather to keep the blood in the head, than to force it out; and it might accordingly be inferred that, whilst the quantity of cerebral matter remains the same, the amount of blood in the cranial vessels must also be invariable. This inference appeared to derive support from the experiments of Dr. Kellie.* On bleeding animals to death, he found that, whilst the remainder of the body was completely exsanguine, the usual quantity of blood remained in the arteries and veins of the cranium; but that, if an opening was made in the skull, these vessels were then as completely emptied as the rest. It is not to be hence

* Edinburgh Medico-Chirurgical Transactions, vol. i.

inferred, however, that the absolute quantity of blood within the cranium is not subject to variation; and that in the states of inflammation, congestion, or other morbid affections, there is only a disturbance of the usual balance of the arterial and venous circulation. The fact in all probability is rather, that the softness of the Cerebral tissue, and its varying functional activity, render it peculiarly liable to undergo alterations in bulk; and that the amount of the cerebro-spinal fluid varies considerably at different times (§ 476); so that the quantity of blood may thus, even in the healthy condition, be continually changing. Moreover, in disordered states of the circulation, the quantity of blood in the vessels of the cranium may be for a time diminished by a sudden extravasation, either of blood or serum, into the cerebral substance; and the amount of interior *pressure* upon the walls of the vessels may also be considerably altered, even when there is no difference in the *quantity* of fluid contained in them.*

748. The *Erectile* tissues constitute another curious modification of the ordinary vascular apparatus. The chief of these are the Corpora Cavernosa in the penis of the male, and in the clitoris of the female; the collection of similar tissues round the vagina, and in the nymphæ, of the female; and the nipple in both sexes. In all these situations, erection may be produced by local irritation; or it may take place as a result of certain emotional conditions of the mind; the influence of which is probably transmitted through the Sympathetic nerve, as it may be experienced even in cases of paraplegia. The erectile tissue appears essentially to consist of a plexus of varicose Veins, inclosed in a fibrous envelope. According to Gerber,† this plexus is traversed by numerous contractile fibres, which are analogous to those that form the dartos; and to the contraction of these is probably to be attributed that obstruction to the return of blood by the Veins, which is the occasion of the turgescence. The proximate cause of the erection of the Penis, has been stated by some to be the action of the Ischio-Cavernosi muscles; and by others it has been attributed to the compression of the Vena dorsalis penis against the Symphysis pubis. But it is obvious that nothing analogous to this can apply to the other erectile organs, especially to the Nipple. In the Penis, according to Müller, there are two sets of arteries; of which one, destined for the nutrition of the tissues, communicates with the veins in the usual way, through a capillary net-work; whilst the others pass off as large branches, and penetrate the cavernous substance in a helicine manner, communicating abruptly with the venous cells. It would seem not improbable, that these last are not ordinarily pervious to blood; but that the same change in the contractile fibres, which impedes the return of the blood by the veins, may also permit it to enter more freely from the helicine arteries. This double communication, however, is denied by Valentin, who gives a different explanation of the appearances described by Müller.—The arteries are protected in such a manner, that, even when the veins are most compressed, and the erection most complete, they are still quite pervious.

* The results of the more recent experiments of Dr. G. Burrows (Med. Gaz., April and May, 1843) fully confirm the views stated above.

† General Anatomy, p. 298.

CHAPTER XIII.

OF RESPIRATION.

1.—*Nature of the Function: and Provisions for its Performance.*

749. IT is obvious that the Nutritive fluid, in its circulation through the capillaries of the system, must undergo great alterations, both in its physical constitution, and its vital properties. It gives up to the tissues with which it is brought into contact, some of its most important elements; and, at the same time, it is made the vehicle of the removal, from these tissues, of ingredients which are no longer in the state of combination, that fits them for their offices in the Animal Economy. To separate these ingredients from the general current of the circulation, and to carry them out of the system, is the great object of the Excretory organs; and it is very evident that the importance of the respective functions of these will vary with the amount of the ingredient which they have to separate, and with the deleterious influence which its retention would exert on the welfare of the system at large. Of all these injurious ingredients, Carbonic Acid is without doubt the one most abundantly introduced into the nutritive fluid; and it is also most deleterious in its effects on the system, if allowed to accumulate.—We find, accordingly, that the provision for the removal of Carbonic Acid from the Blood, is one of peculiar extent and importance, especially in the higher forms of Animals; and further, that instead of being effected by an operation peculiarly *vital* (like other acts of Excretion), its performance is secured by being made to depend upon simple *physical* laws, and is not nearly so susceptible of derangement from disorder of other processes, as it would be if its conditions were less simple. All that is requisite for it, as we shall presently see, is the exposure of the Blood to the influence of the Atmospheric air, or of Air dissolved in water, through the medium of a membrane that shall permit the diffusion of gases; and an interchange then takes place between the gaseous matters on the two sides,—Carbonic acid being exhaled from the Blood, and being replaced by Oxygen. Thus the extrication of Carbonic acid is effected in a manner, that renders it subservient to the introduction of the element which is required for all the most active manifestations of vital power; and it is in these two processes conjointly, not in either alone, that the function of Respiration essentially consists.—We shall now inquire into the sources from which Carbonic acid is produced in the living body; and the causes of the demand for Oxygen.

750. All organized bodies, as already explained, are liable to continual decay, even whilst they are most actively engaged in performing the actions of Life; and one of the chief products of that decay is Carbonic Acid. A large quantity of this gas is set free, during the decomposition of almost every kind of organized matter; the Carbon of the substance being united with the oxygen supplied by the air. Hence we find, that the formation and liberation of carbonic Acid go on with great rapidity after death, both in the Plant and in the Animal; and that they take place, also, to a very great extent, in the period that often precedes the death of the body, during which a general decomposition of the tissues is occurring. Thus in Plants, as soon as they become unhealthy, the extrication of carbon in the form of carbonic acid takes

place in greater amount than its fixation from the carbonic acid of the atmosphere; and the same change normally occurs during the period that immediately precedes the annual fall of the leaves, their tissue being no longer able to perform its proper functions, and giving rise, by its incipient decay, to a large increase in the quantity of carbonic acid set free. The same thing happens in the Animal body, during the progress of many diseases which are attended with an unusual tendency to decomposition in the solids and fluids,—such as eruptive fevers;—the quantity of carbonic acid set free in Respiration is greatly increased, although the body remains completely at rest; and notwithstanding this, the blood frequently exhibits a very dark hue, indicating that it has not been freed from the unusual amount of that substance which it has received from the tissues.—Hence the first object of the Respiratory process, which is common to all forms of organized being, is to extricate from the body the carbonic acid, which is one of the products of the continual decomposition of its tissues. The softness of many of the tissues of Animals, and the large quantity of fluid contained in their bodies, render them more prone than Plants to this kind of decomposition; and in warm-blooded animals, the high temperature at which the fabric is usually maintained, adds considerably to the degree of this tendency, so that the *waste* of their tissues, from this cause alone, is as much greater than that of cold-blooded animals, as the latter is than that of Plants. But when the temperature of the Reptile is raised by external heat to the level of that of the Mammal, its need for respiration increases, owing to the augmented waste of its tissues. When, on the other hand, the warm-blooded Mammal is reduced, in the state of hibernation, to the level of the cold-blooded Reptile, the waste of its tissues diminishes to such an extent, as to require but a very small exertion of the respiratory process to get rid of the carbonic acid, which is one of its chief products. And in those animals which are capable of retaining their vitality, when they are frozen, or when their tissues are completely dried up, the decomposition is for the time entirely suspended, and consequently there is no carbonic acid to be set free.

751. But another source of Carbonic acid to be set free by the Respiratory process, and one which is peculiar to animals, consists in the rapid changes which take place in the Muscular and Nervous tissues, during the period of their activity. It has been already shown (§ 586), that there is strong reason to believe the waste or decomposition of the muscular tissue to be in exact proportion to the degree in which it is exerted; every development of muscular force being accompanied by a change in the condition of a certain amount of tissue. In order that this change may take place, the presence of Oxygen is essential; and one of the products of the union of oxygen with the elements of muscular fibre is carbonic acid. The same may probably be said of the Nervous tissue (§ 292). Hence it may be stated as a general principle, that the peculiar waste of the Muscular and Nervous substances, which is a condition of their functional activity, and which is altogether distinct from the general slow decay that is common to these tissues with others, is another source of the carbonic acid which is set free from the animal body; and that the amount thus generated will consequently depend upon the degree in which these tissues are exercised. In animals which are chiefly made up of the organs of vegetative life, in whose bodies the nervous and muscular tissues form but a very small part, and in whose tranquil plant-like existence there is but very little demand upon the exercise of these structures, the quantity of carbonic acid thus liberated will be extremely small. On the other hand, in animals, whose bodies are chiefly composed of muscle, and whose life is an almost ceaseless round of exertion, the quantity of carbonic acid thus liberated is very considerable.

752. Besides these sources of Carbonic acid, which are common to all Animals, there is another, which appears to be peculiar to the two highest classes, Birds and Mammals. These are capable of maintaining a constantly elevated temperature, so long as they are supplied with a proper amount of appropriate food; and their power of doing so appears to depend upon the *direct* combination of certain elements of the food, with the oxygen of the air, by a process analogous to combustion; these elements having been introduced into the blood for that purpose, but not having formed a part of any of the solid tissues of the body, unless they have been deposited in the form of fat. The nature of these substances has been already noticed (§ 641). It is quite clear that they cannot be applied in their original form, to the nutrition of the tissues that originate in proteine compounds; and it is tolerably certain that, in the ordinary condition of the body, they undergo no such conversion, as would adapt them to that purpose. The Liver seems to afford a channel, by which some of the fatty matters are drawn off from the blood; but even these seem, in part at least, to be reabsorbed (§ 671), and to be thrown off by the respiratory process.

753. The quantity of carbonic acid, that is generated directly from the elements of the food, seems to vary considerably in different animals, and in different states of the same individual. In the Carnivorous tribes, which spend the greater part of their time in a state of activity, it is probable that the quantity which is generated by the waste or metamorphosis of the tissues is sufficient for the maintenance of the required temperature,—and that little or none of the carbonic acid set free in respiration is derived from the direct combustion of the materials of the food. But in Herbivorous animals of comparatively inert habits, the amount of metamorphosis of the tissues is far from being sufficient; and a large part of the food, consisting as it does of substances that cannot be applied to the nutrition of the tissues, is made to enter into direct combination with the oxygen of the air, and thus to compensate for the deficiency. In Man and other animals, which can sustain considerable variations of climate, and can adapt themselves to a great diversity of habits, the quantity of carbonic acid formed by the direct combination of the elements of the food with the oxygen of the air, will differ extremely under different circumstances. It will serve as the *complement* of that which is formed in other ways; so that it will diminish with the increase, and will increase with the diminution of muscular activity. On the other hand it will vary, in accordance with the external temperature; increasing with its diminution, as more heat must then be generated; and diminishing with its increase.—In all cases, if a sufficient supply of food be not furnished, the store of fat is drawn upon: and if this be exhausted, the animal dies of cold (§ 896).

754. To recapitulate, then, the sources of Carbonic Acid in the animal body are threefold.—*i.* The continual decay of the tissues; which is common to all organized bodies; which is diminished by cold and dryness, and increased by warmth and moisture; which takes place with increased rapidity at the approach of death, whether this affect the body at large, or only an individual part; and which goes on unchecked when the actions of nutrition have ceased altogether.—*ii.* The Metamorphosis, which is peculiar to the Nervous and Muscular tissues; which is the very condition of their activity, and which therefore bears a direct relation to the degree in which they are exerted.—*iii.* The direct conversion of the carbon of the food into carbonic acid; which is peculiar to warm-blooded animals; and which seems to vary in quantity, in accordance with the amount of heat to be generated.—We shall now examine into the manner in which this compound is set free, in the principal groups of the Animal kingdom.

755. Notwithstanding their diversity in external form, the organs of Re-

spiration are always formed upon the same general plan; being essentially composed of a membranous prolongation of the external surface, adapted, by its vascularity and permeability, to bring the blood into close relation with the surrounding medium. But as this medium may be either air or water, we find two principal forms of the apparatus; one of them adapted for each kind of respiration. In aquatic animals, the membrane is usually prolonged externally into tufts or fringes, which are so arranged as to expose the greatest amount of surface to the water; each filament of which these are composed, includes an afferent and efferent capillary vessel; and it is whilst the fluid is passing through them, that its aeration is accomplished. The collection of tufts or fringes constitutes what are known as *gills*; and though their arrangement varies considerably, their essential character is but little different, throughout the classes of animals that possess them. On the other hand, in air-breathing Animals, the aerating surface is reflected inwardly, forming passages or chambers into which the air is received, and on the walls of which the blood is distributed in a minute capillary net-work. Such a conformation is found even among some of the lower Articulata, which have a series of air-sacs disposed along each side of the body, one for every segment. In Insects we find, instead of the sacs, a system of prolonged tubes, ramifying through the body, and carrying air into its minutest portions. Even in some Mollusca, such as the Snail and other terrestrial Gasteropods, we find a provision for aerial respiration; a large cavity being formed in the back, communicating with the air, and having a beautifully-reticulated plexus of blood-vessels on its walls. In none of the Invertebrata, however, does the respiratory apparatus communicate with the mouth; which is an organ solely appropriated, in them, to the ingestion of food. In the Mollusca, indeed, the channel through which the water, that has passed over the aerating surface, leaves the chamber (formed by a fold of the mantle or general envelope) which contains the gills, is the same as that through which the excrementitious matter is discharged from the intestine; and the gills themselves are very commonly situated in the neighbourhood of the anal orifice. This fact is interesting in regard to the character of the temporary respiratory apparatus of the Human embryo. In Fishes and the larvæ of Batrachia, which are the highest animals that breathe by gills, these organs are so disposed in connecting with the cavity of the mouth, that fresh currents of water are continually being forced over them by its muscles; and thus the energy of their action is greatly increased. Moreover the whole blood, which is propelled from the heart, proceeds first to the respiratory organs; instead of passing through them on its return from the systemic circulation, as in most of the aquatic Invertebrata. Still, as the quantity of oxygen which the blood can obtain in this manner is very small, being limited to that contained in the atmospheric air dissolved in the water, the amount of aeration must be considered as low.

756. In the lowest Vertebrata that possess anything like a pulmonary cavity, this has a structure as simple as that of the air-sac of the Snail. This is the case in many Fishes, where it is known as the air-bladder; it is frequently single in this class, and communicates with the intestinal canal near the stomach, or is altogether destitute of outlet. In others, however, it is double, and its duct opens into the œsophagus near the mouth; so that its analogy to the lungs of higher animals is very evident. The Batrachia begin life as

Fig. 214.

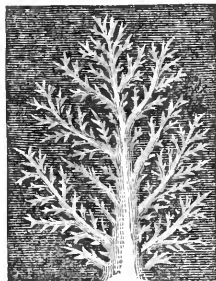

One of the arborescent processes, forming the gills of *Doris Johnstoni*, separated and enlarged.

Fishes, breathing by gills during their tadpole state; but at the time that the legs are developed and the tail has decreased, the pulmonary organs also are evolved, and the course of the blood is altered, so that it is no longer transmitted through the gills, which speedily shrivel and disappear (§ 31). There are some species, however, whose metamorphosis is checked, so that in their permanent condition both lungs and gills are present; but the former are then present in a very rudimentary form, not being more developed than the air-sacs of many Fishes. The lungs of Reptiles are, for the most part, simple sacs; into which the bronchial tubes open freely; and on the walls of which, the pulmonary vessels are distributed. The extent of surface is considerably increased, however, by the formation of a number of little pits or sacculi on the inner wall of the cavity, especially at its upper part; and between these, we observe a sort of cartilaginous frame-work, which is continuous with the cartilage of the bronchus on either side. The Turtles and their allies are the only Reptiles, in which the cavity of the lung is itself divided by membranous partitions; and thus it happens that, excepting in these, the net-work of pulmonary capillaries, in the class of Reptiles, is exposed only on *one* side to the influence of the air. The general distribution of these vessels is shown in the accompanying figures. It will be seen that the trunk of the pulmonary artery runs along one side of the sac, and that of the pulmonary vein along the other (Fig. 215); and that numerous branches arise from the former, which subdivide into capillaries that ramify over the whole surface, and then reunite into small veins which terminate in the latter. The islets of parenchyma left between the capillary vessels, are seen to be much smaller than those which are usually to be observed in the systemic circulation (Figs. 216, 217); so that the membrane is more copiously traversed by vessels, than

Fig. 215.



Lung of *Triton cristatus*, magnified about 3 diameters; *a*, pulmonary artery; *b*, pulmonary vein.

[Fig. 216.]

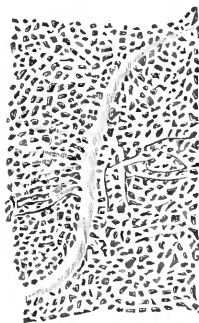

Portion of the lung of the same animal, more highly magnified; the vessels, finely injected with size and vermilion, form a net-work so minute, that the parenchyma is only seen in small islets in its interstices.

any other that is known. The walls of the capillaries, moreover, are much less distinct than those of the systemic circulation. These two conditions are obviously favourable to the exposure of the largest possible quantity of blood to the influence of the air; but as the surface is not an extensive one, the amount which can be thus exposed at any one time is very limited; and the pulmonary artery is in fact one of the smaller branches of the aorta, which conveys a mixed fluid to the system at large.

Fig. 217.

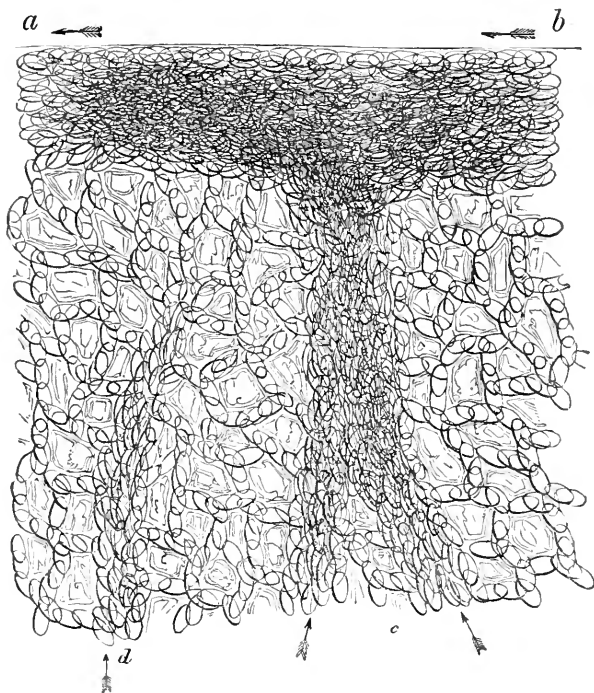

Portion of the lung of a living *Triton*, as seen under the microscope with the power of 150 diam.; *a*, *b*, pulmonary vein, receiving blood from the large trunk *c*, and a smaller vessel *d*.

757. In the warm-blooded Vertebrata, which have a complete double circulation,—namely, Birds and Mammalia,—a much larger extent of surface is provided for the aeration of the blood; the whole current of which is transmitted to the lungs, before circulating again through the system. This increase is provided in Birds, partly by the greater extension of surface in the lungs themselves,—these cavities being subdivided by partitions into numerous smaller chambers, each having pitted walls, and resembling the entire lung of a Reptile;—and partly by the addition of a number of large air-sacs, which are disposed in various parts of the body, and even in the interior of the long bones. Hence it happens, that the amount of Respiration is greater in this class than in any other; although the form of the apparatus is not nearly so concentrated as in the Mammalia; nor is the mechanism of the chest so well adapted to a constant exchange of the air contained in its cavities (§ 37). In Mammalia the lungs are proportionally smaller; and the whole respiratory

apparatus is restricted to the thorax: but the minute subdivision of their cavity, and the mechanism by which a continual interchange of air is provided for, render them very efficient for their designed purpose.—The following, according to the latest researches, especially those of Mr. Rainey,* appears to be the nature of the ultimate structure of the lungs in Man and the Mammalia in general. The bronchial tubes divide and subdivide, like the branches of a tree, still retaining their ordinary characters, until they are no more than from 1-50th to 1-30th of an inch in diameter; and in these the longitudinal and annular fibres, together with the ciliated epithelium, come to an abrupt termination. Beyond this boundary, the tubular form of the air-passages continued from the bronchi is retained for some distance; but it is gradually changed by the irregular branching of the passages, and by the increase of the number of apertures in their walls, which lead to the air-cells. Thus, at last, each minute division of the air-passages becomes quite irregular in form; air-cells opening into every part of it, and almost constituting its walls; until it terminates, almost without dilatation, in an air-cell. This terminal portion of the air-passage, with its surrounding cluster of air-cells, may be regarded as forming a sort of lobule, and as representing the entire lung of a Frog or

[Fig. 218.]

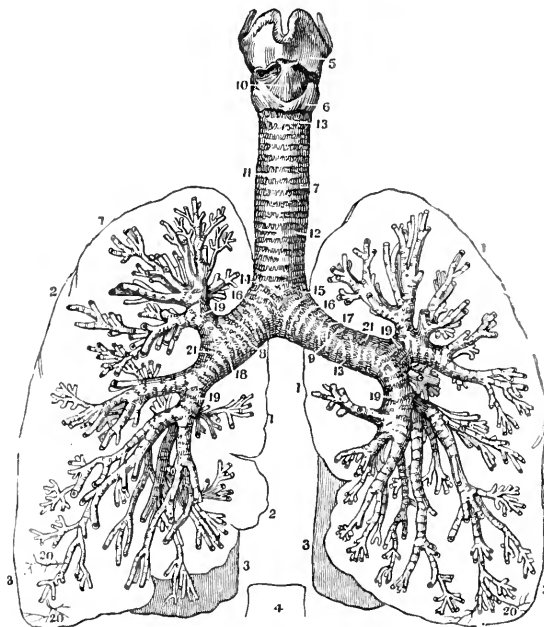

The Larynx, Trachea and Bronchiae, deprived of their fibrous covering, and with the outline of the Lungs; 1, 1, outline of the upper lobes of the lungs; 2, outline of the middle lobe of the right lung; 3, 3, outline of the inferior lobes of both lungs; 4, outline of the ninth dorsal vertebra, showing its relation to the lungs and the vertebral column; 5, thyroid cartilage; 6, cricoid cartilage; 7, trachea; 8, right bronchus; 9, left bronchus; 10, crico-thyroid ligament; 11, 12, rings of the trachea; 13, first ring of the trachea; 14, last ring of the trachea, which is corset-shaped; 15, 16, a complete bronchial cartilaginous ring; 17, one which is bifurcated; 18, double bifurcated bronchial rings; 19, 19, smaller bronchial rings; 20, 20, depressions for the course of the large blood-vessels.]

* Medico-Chirurgical Transactions, vol. xxviii.

[Fig. 219.]

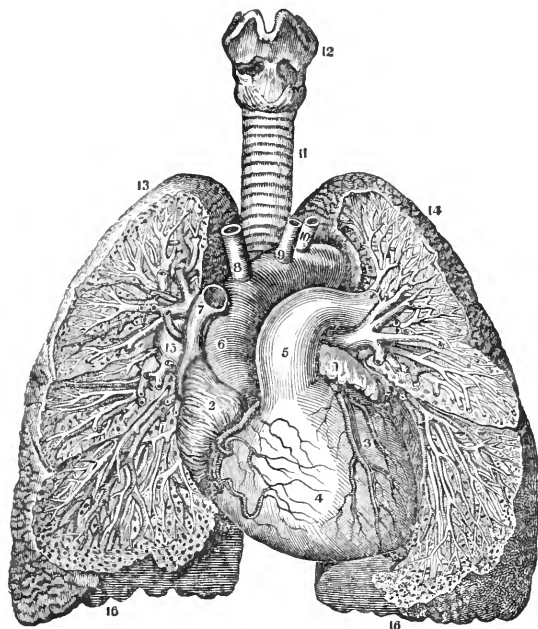

A view of the Bronchiæ and Blood-Vessels of the Lungs as shown by dissection, as well as the relative position of the Lungs to the Heart; 1, end of the left auricle of the heart; 2, the right auricle; 3, the left ventricle with its vessels; 4, the right ventricle with its vessels; 5, the pulmonary artery; 6, arch of the aorta; 7, superior vena cava; 8, arteria innominata; 9, left primitive carotid artery; 10, left subclavian artery; 11, the trachea; 12, the larynx; 13, upper lobe of the right lung; 14, upper lobe of the left lung; 15, trunk of the right pulmonary artery; 16, lower lobes of the lungs. The distribution of the bronchia and of the arteries and veins, as well as some of the air-cells of the lungs, is also shown in this dissection.]

other Reptile; the whole lung of the Mammal being made up of a multitude of such lobules, which are almost exact repetitions of each other. There is, however, this difference;—that the air-cells in the lung of the Reptile are mere sacculated depressions in the walls of the cavity, opening very freely into it:—whilst the air-cells of each lobule of the lung of the Mammal are arranged around the central passage in such numbers, that the outer ones can only communicate with this passage through the medium of those which are nearer the middle of the cluster. Those cells which communicate directly with the bronchial tubes and intercellular passages, open into them by large circular apertures; and they are themselves similarly opened into by other cells, which again communicate with others beyond them; so that each of the openings in the air-passage leads to a *series* of air-cells, extending from it to the surface of the lobule. These cells have also lateral communications with each other. The walls of the air-cells are formed of a very thin and transparent membrane, which is folded sharply at the orifices of communication, so as to form a very definite border to them; and the capillary plexus is so placed between the two layers, which form the walls of two adjacent air-cells, as to expose one of its surfaces each; by which provision, the full influence of the air upon it is secured.

a. It appears from the researches of M. Bourgeri,* that the development of the air-cells continues in the human subject up to the age of thirty, at which time the capacity for respiration is the greatest; it subsequently decreases, especially in persons who suffer from cough,—the violence of which expiratory effort frequently causes rupture of the air-cells, and thus gradually produces that emphysematous state of the lungs, which is so common in elderly persons. The power of increasing the volume of air taken in, by a forced inspiration, is much less in the old person than in the child, though the average amount of air inspired may be the same; hence the young person possesses a greater capacity of respiration, as it were, in reserve; whilst the old man has little, and is, therefore, unfit for great exertion.

b. The Lungs are developed, in the first instance, as diverticula from the œsophageal tube. In the Chick, about the fourth day, a little sacculus is described as shooting forth at its posterior and inferior part; and this soon subdivides at its lower part into two; at the same time becoming more separated from the tube, by a constriction around the neck, which soon elongates so as to form the trachea. On the fifth or sixth day, the lung of one side is completely distinct from that of the other, and each is attached to the common pedicle by a peculiar branch, the future bronchus. The upper portion has much thicker walls than the lower; and these appear to contain a large quantity of vesicular parenchyma, in which the ramifications of the bronchial tubes subsequently extend themselves. About the tenth or eleventh day of incubation, these ramifications possess nearly their permanent character and situation. The first trace of the Glottis appears about the fifth day; it is then a mere slit in the walls of the œsophagus, resembling that by which the ductus pneumaticus of some Fishes, opens into the alimentary canal. The

Fig. 220.



First appearance of the lungs: *a.* in a *Fowl* at four days; *b.* in a *Fowl* at six days; *c.* termination of bronchus in a very young *Pig*.

formation of the cartilaginous rings of the trachea does not commence until after the twelfth day, when they first appear as transverse striae on the median line of the front only; they gradually become solid, and extend themselves on either side, until they nearly meet at last on the median line on the back or vertebral side of the tube.

c. The history of the process in the Human embryo, appears to be very nearly the same. The first appearance of the Lungs takes place about the sixth week, at which time they are simple vesicular prolongations of the œsophageal membrane. Their surface, however, soon becomes studded with numerous little wart-like projections; and these are caused by the formation of corresponding enlargements of their cavity. These enlargements soon become prolonged, and develop corresponding bud-like enlargements from their sides; and in this manner, the form of the organs is gradually changed, a progressive increase in their bulk taking place from above downwards, in consequence of the extension of the bronchial ramifications from the single tube at the apex. At the same time, however, a corresponding increase in the amount of the parenchymatous tissue of the lung is taking place; for this is deposited in all the interstices between the bronchial ramifications, and might be compared with the soil filling up the spaces amongst the roots of a tree. It is in this parenchyma that the pulmonary vessels are distributed; and the portion of it which extends beyond the terminations of the bronchial tubes, seems to act as the nidus for their further extension. It can be easily shown that, up to a late period of the development of the lungs, the dilated terminations of the bronchi constitute the only air-cells (Fig. 220, *c*): but, as already mentioned, the parenchyma subsequently has additional cavities formed within it.—It is a fact of some interest, as an example of the tendency of certain diseased conditions to produce a return to forms which are natural to the fetal organism, or which present themselves in other animals,—that up to a late period in the development of the Human embryo, the lungs do not nearly fill the cavity of the chest, and the pleura of each side contains a good deal of serous fluid.

758. The network of vessels on the walls of the air-cells is so minute, that the diameter of the meshes is scarcely so great as that of the capillary vessels which inclose them. According to Mr. Addison, the capillaries in the lung of a *Toad* admit, in their natural state, no more than one, or at most two rows of blood-corpuscles; and the islets of tissue between them are compa-

* Archives Générales de Médecine, Mars 1843.

ratively large; whilst, if the lung be congested or inflamed, five or six rows of corpuscles are seen in the vessels; and the islets of tissue are almost entirely obliterated.—The diameter of the Human air-cells is about twenty times greater than that of the capillaries which are distributed upon their parietes; varying (according to the measurement of Weber) from the 1-200th to the 1-70th of an inch. It has been calculated by M. Rochoux, that as many as 17,790 air-cells are grouped around each terminal bronchus; and that their total number amounts to no less than 600 millions.

Fig. 221.

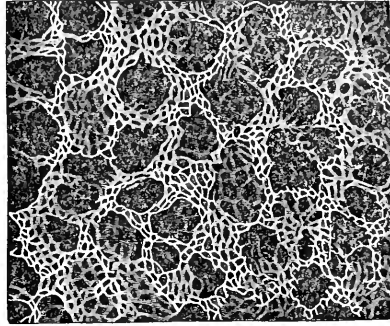

Arrangement of the Capillaries of the air-cells of the Human Lung.

759. The fibrous coat of the bronchial tubes possesses a considerable amount of contractility, which can scarcely be regarded as otherwise than muscular. From the experiments of Dr. C. B. Williams,* it appears that all the air-tubes are endowed with a considerable amount of contractility, which may be excited by electrical, chemical, or mechanical stimuli, applied to themselves; but this is not so readily excitable through their nerves, although the experiments of Volkmann and Longet have clearly shown the possibility of thus calling it into action (§ 410). This contractility resembles that of the intestines or arteries, more than that of the voluntary muscles or heart; the contraction and relaxation being more gradual than that of the latter, though less tardy than that of the former. It is chiefly manifested in the smaller bronchial tubes; since, in the trachea and the larger bronchi, the cartilaginous rings prevent any decided diminution in the calibre of the tube. Wedemeyer did not succeed in producing any distinct contraction of the fibres of the trachea and larger bronchi; but he states that tubes of less than a line in diameter could be perceived to contract gradually under the stimulus of galvanism, until their cavity was nearly obliterated. It is remarked by Dr. Williams, that the contractility of the bronchial muscles is soon exhausted by the action of a stimulus; but that it may in some degree be restored by rest, even when the lung is removed from the body. When the stimulation is long continued, however, as by intense irritation of the mucous membrane during life, the contractile tissue passes into a state which resembles that of the tonic contraction of muscular fibre (§ 593). The contractility is greatly affected by the mode of death, and is remarkably diminished by the action of vegetable narcotics, particularly stramonium and belladonna; whilst it seems to be scarcely at all affected by hydrocyanic acid.—These facts are very important, as throwing light upon certain diseased conditions. It has long been suspected, that the dyspnoea of Spasmodic Asthma depends upon a constricted state of the smaller bronchial tubes, excited through the nervous system, frequently by a stimulating cause at some distance; and there can now be little doubt that this is the case. The peculiar influence of stramonium and belladonna, in diminishing the contractility of these fibres, harmonizes remarkably with the well-known fact of the relief frequently afforded by them in this distressing malady.

760. The Lungs themselves are to be regarded as quite passive in the

* Athenæum Report of the Meeting of the British Association, 1840, p. 802.

movements of respiration; the renewal of their contained air being accomplished by the action of the muscles external to the thorax, or partly forming its parietes. The lung completely fills the cavity of the pleura, in the healthy state at least; so that, when this is enlarged, a vacuum is produced, which can only be filled by a corresponding enlargement of the lung; and to produce this, the air rushes down the trachea, and passes to the remotest air-cells.

a. The distension of the whole tissue of the lung, which is effected in this manner, is much more complete than that, which could be occasioned by simple insufflation from the trachea;—a fact of which it has been proposed to take advantage in juridical inquiries in regard to suspected cases of Infanticide, where the lungs are found to float, and the defence is set up that the child was still-born, and that air was blown into the chest for the purpose of resuscitating it. It has been ascertained by the experiments of Mr. Jennings,* that if a piece of lung, which has been filled with air by insufflation, be exposed to great pressure, the air may be expelled from it sufficiently to cause it to sink in water; but that no pressure can produce the same effect upon that which has been filled by a natural inspiratory effort. It is a serious objection to the use of this test of juridical investigations, however, that the early inspiratory efforts of the infant are often so feeble, as to produce but a very imperfect dilatation of the air-cells; so that the lung of an infant which has naturally inspired cannot, by such means, be distinguished from one that has been artificially inflated. The fact ascertained by Mr. J., however, is one of much physiological interest.—Owing to the freedom with which the air enters the lungs, when there is no abnormal obstruction, the external surface is always in contact with the walls of the chest, so that the pulmonary and costal pleura glide over one another with every inspiration and expiration. The smooth and moistened character of their surface prevents the movement from producing any sound; but it becomes evident when the friction is increased, either by the dryness that is commonly one of the early changes produced by inflammation, or by the rough deposit that subsequently appears.

b. The complete dependence of the expansion of the Lungs upon the production of a vacuum in the chest, is well shown by the effect of admission of air into the pleural cavity. When an aperture is made on either side, so that the air rushes in at each inspiratory movement, the expansion of the lung on that side is diminished, or entirely prevented, in proportion to the size of the aperture. If air can enter through it more readily than through the trachea, an entire collapse of the lung takes place; and by making such an aperture on each side, complete asphyxia is produced. But if it be too small to admit the very ready passage of air, the vacuum produced by the inspiratory movement is more easily filled by the distension of the lungs, than by the rush of air into the pleural cavity; so that a sufficient amount of change takes place for the maintenance of life. This is frequently observed in the case of penetrating wounds of the thorax, in the surgical treatment of which, it is of great importance to close the aperture as completely as possible; when this has been accomplished, the air that had found its way into the cavity is soon absorbed, and the lung resumes its full play. When one lung is obstructed by tubercular deposit, or is prevented in any other way from rightly discharging its function, an opening that freely admits air into the pleural cavity of the other side, is necessarily attended with an immediately fatal result; and in this manner it not unfrequently happens, that chronic pulmonary diseases suddenly terminate in Asphyxia, a communication being opened by ulceration between a bronchial tube and the cavity of the thorax.

761. The dilatation of the chest during Inspiration, is chiefly accomplished by the contraction of the Diaphragm, which, from the high arch that it previously formed, becomes nearly plane; in this change of figure, it presses on the abdominal viscera, so as to cause them to protrude, which they are enabled to do by the relaxation of the abdominal muscles. In ordinary tranquil breathing, the action of the diaphragm is alone nearly sufficient to produce the necessary exchange of air; but, when a full inspiration is required, the cavity of the chest is dilated laterally, as well as inferiorly. This is accomplished by the Intercostal muscles, the Sceleni, Serrati, and others; which, by elevating the ribs, bring them and their cartilages more nearly into the same direction, and thus separate them more widely from the median line. Expiration is chiefly effected by the contraction of the abdominal muscles, which at the same time force up the diaphragm by their pressure on the vis-

* Transactions of the Provincial Medical and Surgical Association, vol. ii.

cera, and depress the ribs; in the latter movement they are aided by the Longissimus Dorsi, Sacrolumbalis, &c., and also by the elasticity of the cartilages of the ribs, with that of the air-cells and air-tubes themselves.

762. It is difficult to form an estimate by observations on one's self, of the usual number and degree of the respiratory movements; since the direction of the attention to them is certain to increase their frequency and amount. In general it may be stated, that from 14 to 18 alternations usually occur in a minute; of these the ordinary inspirations involve but little movement of the thorax; but a greater exertion is made at about every fifth recurrence. The average numerical proportion of the respiratory movements, to the pulsations of the heart, is about 1 to 5 or $4\frac{1}{2}$; and when this proportion is widely departed from, there is reason to suspect some obstruction to the aeration of the blood, or some disorder of the nervous system. Thus in Pneumonia, in which a greater or less amount of the lung is unfit for its office, the number of respirations increases in a more rapid proportion than the acceleration of the pulse; so that the ratio becomes as 1 to 3, or even 1 to 2, in accordance with the degree of engorgement.* In Hysterical patients, however, a similar increase, or even a greater one, may take place without any serious cause; thus Dr. Elliottson† mentions a case, in which the respiratory movements of a young female, through nervous affection, were 98 or even 106, whilst the pulse was 104. On the other hand, the respirations in certain typhoid conditions and in narcotic poisoning become abnormally slow, owing to the torpid condition of the nervous centres, the proportion being 1 to 6, or even 1 to 8; and in such cases, the lungs not unfrequently become œdematous, from the cause formerly mentioned (§ 411).

763. The amount, also, of the Respiratory Movements is affected by various morbid conditions; thus when dislocation of the spine takes place above the origin of the intercostal nerves, but below that of the phrenic, so that the former are paralyzed, the respiratory movement is confined to the diaphragm; and as this is insufficient, serum is effused into the lungs, and a slow Asphyxia supervenes, which usually proves fatal in from three to seven days. Even where the muscles and nerves are all capable of action, the full performance of the inspiratory movements is prevented, by the solidification or engorgement of any part of the lung, which interferes with its free distension; or by adhesions between the pleural surfaces, which offer a still more direct impediment. When these adhesions are of long standing, they are commonly stretched into bands, by the continual tension to which they are subjected. If the impeding cause affect both sides, the movements of both will be alike interfered with; but if one side only is affected, its movements will be diminished, whilst those of the other remain natural; and the physician hence frequently derives an indication of great value, in regard to the degree in which the lung is incapable of performing its functions. It is to be remembered, however, that the action both of the diaphragm and of the elevators of the ribs may be prevented, by pain either in the muscles themselves or in the parts which they move; thus the descent of the diaphragm is checked by inflammation of the abdominal viscera or of the peritoneum; and that of the intercostals by rheumatism, pleuritis, pericarditis, or other painful disorders of the parts forming the parietes of the thorax (§ 431).

764. The capacity of the Lungs for air varies considerably in different individuals; and as the most complete expiration does not by any means empty

* See a Paper by Dr. Hooker, on the Relation between the Respiratory and Circulating Functions, in the Boston (N. E.) Medical and Surgical Journal; an abstract of which will be found in British and Foreign Medical Review, vol. vi. p. 263.

† Physiology, p. 215, note.

them, it is not possible to ascertain it with accuracy. But the amount which can be expelled by a forcible expiration, after a full inspiration, may be taken as a measure of the comparative "capacity of respiration" in different individuals; and the researches of Mr. Hutchinson have shown that, in the state of health, this bears a very constant proportion to the height. Thus he found that the average capacity of men of 5 ft. 7 in. is about 224 cubic inches, whilst that of men of 5 ft. 2 in. is about 173 cubic inches, and that of men of 6 feet, about 255 cubic inches. The size of the chest affords no good indication of the capacity of expiration. The results of such examinations are so nearly uniform, that disease may be suspected in any man, who cannot blow out nearly so many cubic inches as the average of those of the same height; the only exceptions among healthy subjects, being in the case of fat men, whose capacity is always low.—It is obvious from these facts, that the amount of air ordinarily respired will vary greatly in different individuals; and this is doubtless one source of the discrepancy of the results of the various experiments, which have been made to determine this point. Some of the most recent experiments on the subject are those of Mr. Coathupe,* in which the Author has much reason to feel confidence. According to his estimate, about $266\frac{1}{3}$ cubic feet, or 460,224 cubic inches of air, pass through the lungs of a middle-sized man in 24 hours; reckoning the average number of inspirations at 16 per minute, this would give 20 cubic inches as the amount inhaled at each.

2.—*Effects of Respiration on the Air.*

765. We naturally pass from the foregoing inquiries, to those that relate to the alterations in the Air, which are effected by Respiration. These mainly consist in the removal of a portion of the Oxygen, and the substitution of a quantity of Carbonic Acid, rather less in bulk than the Oxygen which has disappeared. The proportion of the air thus changed appears to vary according to the frequency of the respirations. Thus Vierordt found that, if he only respired *six* times in a minute, the quantity of Carbonic acid was 5·5 per cent. of the whole air exhaled; with *twelve* respirations, it was 4·2; with *twenty-four*, it was 3·3; with *forty-eight*, it was 3·0; and with *ninety-six*, it was 2·6 per cent. In some of the experiments of Messrs. Allen and Pepys, it was as much as 8 per cent. Probably about 4 per cent. may be taken as the average, at the ordinary rate of respiration.—It appears, however, from the researches of the last-named experimenters, that if the air be already charged in some degree with Carbonic acid, the quantity exhaled is much less; for when 300 cubic inches of air were respired for *three minutes*, only $28\frac{1}{2}$ cubic inches ($9\frac{1}{2}$ per cent.) of Carbonic acid were found in it; although the previous rate of its production, when fresh air was taken in at every respiration, was 32 cubic inches in a minute. Knowing, then, the necessity of a free excretion of carbonic acid, we are led by this fact to perceive the high importance of ventilation; for it is not sufficient for health, that a room should contain the quantity of air requisite for the support of its inhabitants during a given time; since after they have remained in it but a part of that time, the quantity of carbonic acid which its atmosphere will contain, will be large enough to interfere greatly with the due aeration of their blood, and will thus cause oppression of the brain and the other morbid affections that result from the accumulation of carbonic acid in the circulating fluid.—On the other hand, it has been ascertained by the recent experiments of Dr. Boswell Reid that, if the carbonic acid be removed as fast as it is formed, an animal may remain in a limited quantity of air, without much inconvenience, until nearly the whole of its

* Athenæum Report of Meeting of the British Association, 1839; p. 707.

oxygen is exhausted;—thus showing that the respirability of air does not depend so much upon the proportion of oxygen it contains, as upon its freedom from contamination with carbonic acid or other poisonous gases.

766. The reaction which thus takes place between the Air and the Blood, is easily explained upon physical principles. If the Blood come to the Lungs charged with Carbonic acid, and is exposed in their cells to the influence of atmospheric air, which is a mixture of Oxygen and Nitrogen, an endosmose and exosmose of gases will take place, according to certain fixed laws.* The Carbonic acid of the blood will pass out, to be replaced by Oxygen and Nitrogen; and the quantity of the former which enters will be much greater than that of the latter, on account of the superior facility with which oxygen passes through porous membranes. If the venous blood also contain Nitrogen as well as carbonic acid, this also will pass out, to be replaced by the Oxygen of the air. Thus, there will be a continual Exosmose of Carbonic acid and Nitrogen, and a continual Endosmose of Oxygen and Nitrogen. The exhalation and absorption of Nitrogen appear usually to balance each other; so that the amount of this gas in the respired air undergoes little or no change. But the case is different in regard to the exchange of Carbonic acid and Oxygen. According to the law of mutual diffusion of gases, the volume of Oxygen that is taken in, should exceed that of the Carbonic acid which passes out, in the proportion of 1174 to 1000. This calculation, deduced from the relative densities of the two gases, corresponds so closely with the actual results of experiments upon the respiration of Man, that the interchange may be regarded as always taking place in accordance with the law of mutual diffusion; so that, from the amount of Carbonic acid exhaled, the quantity of Oxygen absorbed may be readily calculated.† Now as Carbonic acid contains its own bulk of Oxygen, it follows that the amount of Oxygen absorbed exceeds that which is given off, by 174 parts in every 1000; so that a quantity of oxygen, equal to more than one-sixth of that which is converted into Carbonic acid, is employed in the system for other purposes. It appears probable that a part of this additional Oxygen is made to combine with Hydrogen furnished by the food or by the disintegration of the tissues; and that the water thus generated forms part of that exhaled from the lungs; whilst another part will be applied to the oxidation of the Sulphur and Phosphorus, which are taken in as such in the food, and which, after forming part of the solid tissues, are excreted in the condition of Sulphuric and Phosphoric acids,—chiefly through the kidneys.

767. The absolute quantity of Carbonic Acid exhaled from the Lungs is liable to variation from so many sources, that no fixed standard can be assigned for it. The mean of a great number of observations, however, made in different modes, and under different circumstances, would give about 160 grains of Carbon per hour as the amount set free by a well-grown adult man, under ordinary circumstances. Taking this as the average of the twenty-four hours, the total quantity of Carbon thus daily expired from the Lungs would be 3840 grains, or 8 oz. Troy. The chief causes of variation are,—the Temperature of the surrounding medium, Age, Sex, Development of the body, state of Health or Disease, Muscular Exertion or Repose, Sleep or Watchfulness, Period of the Day, and state of the Digestive process. These will now be considered in detail.

a. Temperature of surrounding Medium.—The amount of Carbonic Acid exhaled by warm-blooded animals is greatly increased by external Cold, and diminished by Heat; as is shown by the following results of comparative experiments upon the quantity set free by the same animals, at low, medium, and high temperatures, in periods of an hour (Letellier).

* See Principles of General and Comparative Physiology, §§ 437—9.

† Valentin's Lehrbuch der Physiologie, vol. i., pp. 507—580.

	Temp. about 32°.	Temp. 59°—68°.	Temp. 86°—106°.
	Grammes.	Grammes.	Grammes.
A Canary - - -	0·325	0·250	0·129
A Turtle-Dove - - -	0·974	0·684	0·336
Two Mice - - -	0·531	0·498	0·268
A Guinea-Pig - - -	3·006	2·080	1·453

From this table it appears that the quantity of carbonic acid exhaled by Mammals between 86° and 106° is less than *half* that set free near the freezing-point; whilst that which is exhaled between 59° and 68° is but little more than *two-thirds* of the same amount. The diminution occasioned by heat is still more remarkable in Birds; which exhaled at the highest temperature scarcely more than one-third of that set free at the lowest. The observations of Vierordt upon himself show that the same is true of the Human subject; a difference of 10° Fabr., according to him, producing a variation of rather more than two cubic inches in the amount of Carbonic Acid hourly expired.

b. Age.—The amount of Carbonic Acid exhaled increases in both sexes up to about the thirtieth year; it remains stationary until about the forty-fifth; and then diminishes. The following are the comparative results of experiments upon males of different ages, and of a moderate degree of muscular development (Andral and Gavarret).

Age.	Carbon exhaled per hour.	Age.	Carbon exhaled per hour.
8 years - - -	77·0 grains	37 years - - -	164·7 grains.
12 " - - -	113·9 "	48 " - - -	161·7 "
14 " - - -	126·2 "	59 " - - -	154·0 "
20 " - - -	166·3 "	68 " - - -	147·8 "
26 " - - -	169·4 "	76 " - - -	92·4 "

c. Sex.—At all ages beyond eight years, the exhalation is greater in Males than in Females. Nearly the same proportionate increase takes place, however, in females, up to the time of puberty; when the quantity abruptly ceases to increase, and remains stationary so long as they continue to menstruate. When, however, menstruation has ceased, the exhalation of carbonic acid begins again to augment; and then again diminishes, with the advance of years, as in men. Should menstruation temporarily cease at any time, the exhalation of carbonic acid immediately undergoes an increase, precisely as at the final cessation of the function. And during pregnancy, the exhalation increases in like manner. The following table of the comparative respiration of females at different ages, will serve at the same time for comparison with the preceding, so as to exhibit the general difference between the two sexes, at ages nearly corresponding; and also to indicate the peculiar modifications induced by the operations of the genital system (Andral and Gavarret).

Age.	Carbon exhaled per hour.	After Cessation of Catamenia.	
10 years - - -	92·4 grains	Age.	Carbon exhaled per hour.
13 " - - -	97·0 "	38 years - - -	120·3 grains.
<i>During Menstrual life.</i>		49 " - - -	113·9 "
15½ years - - -	97·0 grains.	52 " - - -	115·5 "
26 " - - -	97·0 "	56 " - - -	119·3 "
32 " - - -	95·4 "	66 " - - -	104·7 "
45 " - - -	95·4 "	76 " - - -	101·4 "
<i>During Pregnancy.</i>		82 " - - -	92·4 "
22 years - - -	129·3 grains.		
32 " - - -	126·7 "		
42 " - - -	120·3 "		

d. Development of the Body.—The more robust the individual, *ceteris paribus*, the more Carbonic Acid is exhaled; and the variation is much more influenced by the development of the muscular system, than by the height, or weight, capacity of the chest, &c. Thus, a very strong man of twenty-six years of age exhaled at the rate of 217·1 grains per hour; when a man of moderate muscular power set free but 169·4 grains in the same time. Another robust man of sixty years of age exhaled at the rate of 209·4 per hour; another of similar constitution, and sixty-three years of age, at the rate of 190·9 grains per hour; and an old man of 92 years, who still preserved an uncommon degree of energy, and who in his younger days had boasted of extraordinary muscular powers, exhaled at the rate of 135·5 grains per hour. So also, a remarkably vigorous young woman of nineteen years exhaled at the rate of 107·8 grains per hour; another of twenty-two years, rather less powerful, at the rate of 103·1 grains; and a strong woman of forty-four years (who had ceased to menstruate) 152·4 grains.—On the other hand, a slender man of forty-five years, in the enjoy-

ment of good health, only exhaled at the rate of 132·4 grains per hour (Andral and Garret).

c. State of Health or Disease.—Upon this very important cause of variation, few accurate researches have yet been made. The *per centage* of carbonic acid in the expired air has been found to be unusually great in the Exanthemata, and in chronic skin diseases (Macgregor); and it has been stated to be diminished in typhus (Malcolm).—Thus, the average proportion in health being about 3·96 per cent. (Prout), it has been seen at 8 per cent. in confluent small-pox, at 5 per cent. in measles, and at 7·2 per cent. in a severe case of ichthyosis which terminated fatally; whilst in Typhus the per centage has been found to range from 1·18 to 2·50. But these statements do not indicate the total quantity exhaled in each case.—The remarkable increase of the exhalation in cases of Chlorosis, has been already noticed; in four cases recorded by Hannover, the hourly expiration was 123·6, 118·6, 116·9, and 106·3 grains,—the absolute quantity diminishing as the respirations increased in rapidity.—In chronic diseases of the respiratory organs, as might be anticipated, the amount of Carbonic acid exhaled undergoes a sensible diminution (Nysten and Hannover).—Further researches are much needed on this subject; but, for obvious reasons, they cannot be readily made in severe forms of disease.

f. Muscular Exertion or Repose.—The effect of bodily exercise, in moderation, is to produce a considerable increase in the amount of carbonic acid exhaled, both during its continuance, and for some little time subsequently to its cessation. According to the observations of Vierordt, the increase amounts to one-third of the quantity exhaled during rest; and it lasts for more than an hour afterwards, being manifested in the greater quantity of air respired, and in the larger per centage of carbonic acid contained in it. If the exercise be prolonged, however, so as to occasion fatigue, it is succeeded by a diminished exhalation.—The connection between muscular exertion and the exhalation of carbonic acid, is most remarkably shown in Insects; in which animals we may witness the rapid transition between the opposite conditions of extreme muscular exertion, and tranquil repose; and in which the effects of these upon the respiratory process are not masked by that exhalation of carbonic acid, which is required in warm-blooded animals simply for the maintenance of a fixed temperature. Thus a Humble-Bee has been found to produce one-third of a cubic inch of carbonic acid, in the course of a single hour, during which its whole body was in a state of constant movement, from the excitement resulting from its capture; and yet, during the whole twenty-four hours of the succeeding day, which it passed in a state of comparative rest, the quantity of carbonic acid generated by it was absolutely less.

g. Sleep or Watchfulness.—The amount of carbonic acid exhaled during sleep is considerably less than that set free in the waking state. This is particularly shown by the experiments of Scharling; who confined the subjects of them in an air-tight chamber, within which they could sleep, take their meals, &c. Thus in one case, the hourly exhalation sank from 160 to 100, in another from 194·7 to 122·3, and in another from 99 to 75·1. The cause of this result is partly to be sought in the cessation of all muscular exertion (save that concerned in the maintenance of the respiration); and partly in the diminution in the dissipation of the heat of the body itself.

h. State of the Digestive Process.—It is well established, that the exhalation of carbonic acid is greatly increased by eating, and that it is diminished by fasting. Thus Prof. Scharling states the hourly exhalation to have increased in one instance from 145 to 190, after breakfast and a walk; in another from 140 to 177 after breakfast alone; and in another from 111·9 to 188·9, after dinner. It is remarkable that alcoholic drinks have a tendency to *diminish* the exhalation of carbonic acid, especially when taken into an empty stomach; and strong tea is said to have the same effect (Prout, Vierordt).—The quantity is also increased by exhilarating emotions, and decreased by depressing affections of the mind (Prout).

i. Period of the Day.—Independently of these variations, which have their source in the condition of the individual, there appears to be a slight tendency to increase in the quantity of carbonic acid exhaled during the early part of the day, and a steady decrease during the afternoon; so that, in the evening the quantity is decidedly less than in the morning. It is very difficult to separate the effects of this influence, however, from those of the causes previously adverted to.

768. The aeration of the blood may take place, not only by means of the Lungs, but also through the medium of the Cutaneous surface. In some of the lower tribes of animals, indeed, this is a very important part of their respiratory process; and even in some Vertebrata, the cutaneous respiration is capable of supporting life for a considerable time. This is especially the case in the Batrachia, whose skin is soft, thin, and moist; and the effect is here the greater, since the blood which circulates through the system is, from

the small proportion of it that has passed through the lungs, very imperfectly arterialized. By the experiments of Bischoff it was ascertained that, even after the lungs of a Frog had been removed, a quarter of a cubic inch of carbonic acid was exhaled from the skin, during eight hours. Experiments which have been made on the Human subject leave no room for doubt, that a similar process is effected through the medium of his general surface; for, when a limb has been inclosed for some hours in an air-tight vessel containing atmospheric air freed from carbonic acid, a sensible amount of this gas has been found to be generated. Moreover, it has been observed not unfrequently, that the livid tint of the skin which supervenes in Asphyxia, owing to the non-arterialization of the blood in the lungs, has given place after death to the fresh hue of health, owing to the reddening of the blood in the cutaneous capillaries by the action of the atmosphere upon them. We have no means of ascertaining the usual amount of carbonic acid excreted through the Skin, except by determining the whole quantity disengaged from the body, and subtracting the portion exhaled from the lungs; and no sufficiently precise experiments upon this subject have yet been made. The only way to separate the results of the pulmonary and cutaneous exhalation of carbonic acid, would be to confine the body in a close chamber, into which the product of the cutaneous respiration might freely pass; whilst the pulmonary respiration during the same period should be measured by a distinct apparatus. It is not improbable that, in cases of obstruction to the due action of the lungs, the exhalation of carbonic acid through the skin may undergo a considerable increase; for we find a similar disposition to vicarious action in other parts of the excreting apparatus. Moreover, there is evidence, that the interchange of gases between the air and the blood, through the skin, has an important share in keeping up the temperature of the body (Chap. xvi., Sect. 2); and we find the temperature of the surface much elevated in many cases of pneumonia, phthisis, &c., in which the lungs seem to perform their function very insufficiently.

3.—*Effects of Respiration on the Blood.*

769. That an important change is effected in the character of the Blood, by exposure to Atmospheric air in the lungs, has been known, from the time when it was first ascertained that it is regularly transmitted to those organs. The most obvious part of this change is the alteration in its colour, from the dark purple of the venous fluid, to the rich crimson of the arterial. But this alteration is only the index of changes far more important, which occur in its chemical constitution. Respecting the nature of these changes, there has been, as formerly stated, much difference of opinion; some maintaining that the carbonic acid exhaled is formed in the lungs; and others, that it is contained in the venous blood, and is truly excreted from it. The latter opinion, which was long since brought forward by La Grange and Hassenfratz, has recently obtained such full confirmation, from the experiments of Spallanzani, Edwards, Müller, Bischoff, Magnus, and others, as to have a full claim for adoption as a physiological truth. These experiments are of two kinds; first, those which show that an exhalation of carbonic acid may continue for a long time, when the animal is breathing an atmosphere in which no oxygen exists; and, secondly, those which prove that much more carbonic acid exists in an uncombined state in venous blood than in arterial, whilst more oxygen exists in a similar condition in arterial blood than in venous. The results of these will now be briefly stated.—It was shown by Spallanzani, that Snails might be kept for a long period in Hydrogen, without apparent injury to them; and that during this period they disengaged a considerable amount of Carbonic acid. Dr. Edwards subsequently ascertained that, when Frogs were kept in

hydrogen for several hours, the quantity of carbonic acid exhaled was fully as great as it would have been in atmospheric air, or even greater; this latter fact, if correct, may be accounted for, by the superior displacing power, which (on the laws of the diffusion of gases) hydrogen possesses for carbonic acid. Collard de Martigny repeated this experiment in nitrogen, with the same results. In both sets of experiments, the precaution was used of compressing the flanks of the animal, previously to immersing it in the gas, so as to expel from the lungs whatever mixture of oxygen they might contain. These experiments have been since repeated by Müller and Bergemann, who took the additional precaution of removing, by means of the air-pump, all the atmospheric air that the lungs of the frog might previously contain, together with the carbonic acid that might exist in the alimentary canal. They found in one of their experiments, that the quantity of carbonic acid exhaled in hydrogen was nearly a cubic inch in $6\frac{1}{2}$ hours; and in another, that nearly the same amount was given off in nitrogen; but this required rather a longer period. It appears from the table of their results,* that the amount was not ordinarily greater in the experiments which were prolonged for twelve or fourteen hours, than in those which were terminated in half the time; hence it may be inferred, that the quantity which the blood is itself capable of disengaging is limited, and that the absorption of oxygen is necessary to enable carbon to be set free from the tissues.—It is impossible, however, for an adult Bird or Mammal to sustain life for any considerable time, in an atmosphere deprived of oxygen; since the greatly-increased rapidity and energy of all their vital operations, necessitate a much more constant supply of this vivifying agent, than is needed by the inferior tribes; and, as we shall presently see, the capillary action necessary for the passage of the blood through the lungs will not take place without it. But Dr. Edwards has shown, that young Mammalia can sustain life in an atmosphere of hydrogen or nitrogen, for a sufficient length of time to exhale a sensible amount of carbonic acid; so that the character of the process is clearly proved to be the same in them, as in Reptiles and Invertebrata.

770. That the changes which Venous Blood undergoes in the lungs, are to be explained upon principles of a purely chemical and physical nature, is evident from the fact, that the same changes will take place when it is exposed to the air out of the body, even through the medium of a thick membrane, such as a bladder. Such changes, however, only affect the surface of the fluid; but this is exactly what we should expect, since the air has no access to the part beneath. The Blood, whilst circulating through the capillaries of the Lungs, is divided into an innumerable multitude of minute streamlets, each so small as to admit but a single layer of its corpuscles; and in these, therefore, the surface which is placed in contact with the air is so enormously extended, as to be almost beyond calculation. Hence, then, we can at once understand how such a change may be instantaneously effected in it, as would occupy several hours, when the blood is less advantageously exposed to the influence of oxygen.—In studying the nature of these alterations, it is very necessary to ascertain whether Oxygen and Carbonic Acid exist in a free state in the Blood; and to what extent their proportions differ in Venous and Arterial blood. The late researches of Professor Magnus have shown that Blood possesses a very remarkable absorbing power for these gases, especially for Carbonic acid. By freely exposing it to the latter gas, it was found that it could take up as much as $1\frac{1}{2}$ times its bulk; and that after all its Oxygen and Nitrogen had been thus displaced, it could still absorb as much as 16 per cent. of its volume of Oxygen, and 6·3 of Nitrogen, on being exposed to those gases respectively. The usual quantity of Oxygen present in *arterial* blood

* Müller's Physiology, p. 341.

is, according to the experiments of Magnus, about 10 per cent.; but while passing through the systemic capillaries, this is diminished about one-half, so that Venous blood does not contain more than 5 per cent. of its volume of Oxygen. On the other hand, the Carbonic acid of Arterial blood is about 20 per cent. of its volume; and this proportion is increased in Venous blood to nearly 25 per cent. The amount of Nitrogen varies considerably, being sometimes as little as 1.7 per cent. of the volume of the blood, and sometimes nearly double that proportion; it does not appear to differ, according to any constant law, in arterial and venous blood.*

771. There can be little doubt, then, that the changes which the function of Respiration effects in the Blood have reference in great part to the relative proportions of the different gases, which it holds in solution. And although it might appear that the change of colour, which the Red Corpuscles undergo, is a proof of a change of composition in the Hæmatine which they contain, yet such a supposition is not borne out by experiment; for no difference of composition has been detected, between the Hæmatine of Venous and that of Arterial blood; and it appears from the researches of Peligot on the action of the protoxide of nitrogen upon solutions of the salts of the protoxide of iron, that liquids may have their colour changed by the absorption of gases, which form no chemical union with them.—There seems reason to conclude, however, from the statements formerly quoted (§ 115) in regard to the difference between the Fibrine of Venous and that of Arterial blood, that Oxygen derived from the inspired air enters into actual combination with this element; and the same may very probably be true of other constituents of the blood:—so that we are to regard the influence of Respiration as partly exerted in modifying the proportions of the gases *dissolved* in the blood, substituting Oxygen for a portion of its Carbonic Acid; and partly in enabling the ingredients of the liquid to enter into new combinations with the Oxygen of the air. For the reasons formerly stated (§ 150) it appears probable that, whether or not their Hæmatine be chemically affected by the change, the Red Corpuscles are the chief *carriers* of the two gases to be interchanged, between the pulmonary and systemic capillaries.

772. Although the alteration in the relative proportions of Oxygen and Carbonic acid which it contains, is doubtless the *essential* change effected in the Blood by the Respiratory process, the alteration in its *colour* is the most obvious; and this is, under ordinary circumstances, an indication that the other change has taken place. Thus, if Arterial blood be exposed, out of the body, to carbonic acid, it will acquire the dark hue of venous blood; and Venous blood exposed to it becomes darker still. On the other hand, if Venous blood be exposed to Oxygen, it acquires the Arterial hue. The presence of a certain amount of saline matter appears, from the experiments of Dr. Stevens and others, to be a condition necessary for the due influence of oxygen upon the colour of the blood; since, if it be deficient, the contact of oxygen will not produce its usual effect. On the other hand, the addition of saline matter (especially nitre) will occasion a decided change of hue in venous blood, without any extrication of carbonic acid or absorption of oxygen.

* For the latest researches of Prof. Magnus, which have had their origin in the objections of M. Gay Lussac to those previously published by him, see the *Annalen der Physik und Chemie*, vol. lxxvi., p. 177, and an Abstract in the *Philosophical Magazine*, Dec. 1845, Suppl. In these researches, far greater success was obtained in removing the gases from the blood, than in any previous experiments; and the account of their proportions, therefore, is more satisfactory. It is extremely difficult to avoid all sources of error, in such researches; but the constancy of the results obtained by Magnus indicates that we may place much confidence in them.

a. It has recently been attempted, by Mulder and others, to account for the change of hue under the influence of carbonic acid, oxygen, and saline matter, by a change of *form* in the red corpuscles; which are supposed to be bi-concave and reflecting in bright coloured blood, and bi-convex and refracting in blood presenting the venous tint. But the supposition is not borne out by minute and careful observations on the forms of the corpuscles, nor by varied experiments on the effects of re-agents. As Dr. G. O. Rees has shown, the blood-corpuscles may be changed in form, without any consequent change of colour; whilst, on the other hand, the blood is reddened by saline solutions, whether they produce endosmose or exosmose in the red corpuscles, thus either filling or emptying them, and rendering them either bi-convex or bi-concave.

773. *Exhalation and Absorption by the Lungs.*—The alteration in the proportions of its usual gaseous ingredients, is by no means the only change which the Blood undergoes in the Lungs. It parts also, with a considerable amount of water, in the form of vapour; this usually contains a certain proportion of animal matter; and it is sometimes charged with volatile substances, which have been elsewhere introduced into the blood, or which have been formed during its assimilation. It may also absorb from the atmosphere volatile matter diffused through it. Both these changes are probably to be explained upon simple physical principles; being dependent on the exposure of the blood to the atmosphere, over a very extensive surface, and through a membrane of great permeability. Of the fluid ordinarily exhaled with the breath, a part doubtless proceeds from the moist lining of the nostrils, fauces, &c.; but it is indisputable that the greater proportion of it comes from the lungs, since, when the respiration is entirely performed through a canula introduced into the trachea, the amount of watery vapour which the breath contains, is still very considerable. The quantity which thus passes off is by no means trifling; probably between 16 and 20 ounces in the twenty-four hours. It is not so liable to variation under the influence of temperature, the movement of the surrounding air, and other similar causes, as is the cutaneous transpiration; for air, which has found its way into the air-cells of the lungs, is, under almost all circumstances, nearly the same in regard to such conditions, and becomes charged with that amount of watery vapour which saturates it at the temperature of the body. It is considered by Dr. Prout, that the principal source of this vapour is not the blood properly so called, but the chyle and lymph which have just been introduced into it from the thoracic duct; a loss of a portion of their fluid being required, to give them sufficient concentration. A process very analogous takes place in Plants; for a very large proportion of the water taken up in the crude sap, is parted with in the leaves. But it is probable that a part, at least, of the water thrown off by the lungs is generated by the union of Oxygen and Hydrogen during the course of the Circulation.

774. The fluid thrown off from the Lungs is not pure water. It holds in solution, as might have been expected, a considerable amount of carbonic acid, and also some animal matter; the exact nature of the latter, which, according to Collard de Martigny, constitutes about 3 parts in 1000, has not been ascertained. If the fluid be kept in a closed vessel, and be exposed to an elevated temperature, a very evident putrid odour is exhaled by it. Every one knows that the breath itself has, occasionally in some persons, and constantly in others, a fetid taint; when this does not proceed from carious teeth, ulcerations in the air-passages, disease in the lungs, or other similar causes, it must result from the excretion of the odorous matter, in combination with watery vapour, from the pulmonary surface. That this is the true account of it seems evident, from the analogous phenomenon of the excretion of turpentine, camphor, alcohol, and other odorous substances, which have been introduced into the venous system, either by natural absorption, or by direct injection; and also from the suddenness with which it manifests itself, when the digestive apparatus is slightly disordered.

775. The Lungs are capable, under peculiar circumstances, of absorbing fluid from the atmosphere. Thus Dr. Madden* has shown that, if the vapour of hot water be inhaled for some time together, the loss by exhalation is found to be so much less than usual, as to indicate that the cutaneous transpiration is partly counterbalanced by pulmonary absorption; the pulmonary exhalation being at the same time entirely checked. It is probable that, if the quantity of fluid in the blood had been previously diminished by excessive sweating, or by other copious fluid secretions, the pulmonary absorption would have been much greater. Still in the cases formerly mentioned (§ 678), in which a large increase in weight could only be accounted for on the supposition of absorption of water from the atmosphere, it seems probable that the cutaneous surface was chiefly concerned: for it can only be when the air introduced into the lungs is *saturated* with watery vapour, that the usual exhalation will be checked, or that any absorption can take place.

776. That absorption of other volatile matters diffused through the air is, however, continually taking place by the lungs, is easily demonstrated. A familiar example, is the effect of the inhalation of the vapour of Turpentine upon the urinary excretion. It can only be in this manner that those gases act upon the system, which have a noxious or poisonous effect, when mingled in small quantities in the atmosphere. Of these, Sulphuretted Hydrogen is one of the most powerful in its action; for it has been found that air impregnated with 1-1500th part of it, will kill a bird in a very short time; and that a quantity but little more than double, namely 1-800th part, will soon kill a dog. This gas is exhaled in large quantities from many forms of decomposing animal and vegetable matter; and it has recently been shown (by Professor Daniell) to be absorbed by the water of the estuaries of those African rivers, whose mouths are regarded as among the most pestilential spots upon the surface of the globe.—Carburetted hydrogen is another gas whose effects are similar; but a larger proportion is required to destroy life.—Carbonic acid gas, also, appears to be absorbed by the lungs, when a large proportion of it is contained in the atmosphere. The accumulation of this gas in the blood, when the respired air is charged with it even to a moderate amount, might be attributed to the impediments thus offered to its ordinary exhalation: but the following experiment appears to prove, that it may be actually absorbed into the blood; and that it will thus exert a real poisonous influence, and not merely produce an asphyxiating effect. It was found by Rolando, that the air-tube of one lung of the land-tortoise may be tied, without apparently doing any material injury to the animal, as the respiration performed by the other is sufficient to maintain life for some time; but, having contrived to make a tortoise inhale carbonic acid by one lung, whilst it breathed air by the other, he found that the animal died in a few hours.†—Cyanogen is another gas which has an actively-poisonous influence upon animals, when absorbed into the lungs; its agency, also, is of a narcotic character.

777. It is singular that the effects of the respiration of pure Oxygen should not be dissimilar. At first, the rapidity of the pulse and the number of the respirations are increased, and the animal appears to suffer little or no inconvenience for an hour; but symptoms of coma then gradually develop themselves, and death ensues in six, ten, or twelve hours. If the animals are

* Prize Essay on Cutaneous Absorption, p. 55.

† The fatal result of breathing the fumes of charcoal is, therefore, not simple asphyxia, such as would result from breathing hydrogen or nitrogen. Other volatile products are set free in the combustion of charcoal, besides carbonic acid. Mr. Coathupe (loc. cit.) states these to be Carbonate, Muriate and Sulphate of Ammonia, Carbonic Oxide, Oxygen, Nitrogen, Watery vapour, and Emphyreumatic Oil: to these Sulphurous acid may appear to be properly added.

removed into the air before the insensibility is considerable, they then quickly recover. When the body is examined, the heart is seen beating strongly while the diaphragm is motionless; the whole blood in the veins, as well as in the arteries, is of a bright scarlet colour; and several of the membranous surfaces have the same tint. The blood is observed to coagulate with remarkable rapidity; and it is to the alteration in its properties, occasioned by the hyper-arterialization, and indicated by this condition, that we are probably to attribute the fatal result. There can be no doubt that in this instance an undue amount of oxygen is absorbed; and it does not seem unlikely that one cause of the fatal result, is a stagnation of the blood in the systemic capillaries, consequent upon the want of sufficient change in its condition.—When Nitrogen or Hydrogen is breathed, for any length of time, death results from the deprivation of Oxygen, rather than from any deleterious influence which these gases themselves exert.—Death is also caused by the inhalation of several gases of an irritant character, such as Sulphurous, Nitrous, and Muria-tic acids: but it is doubtful how far they are absorbed; or how far their injurious effects are due to the abnormal action, which they excite in the lining membrane of the air-cells and tubes.—It cannot be doubted, that mias-mata and other morbid agents diffused through the atmosphere, are more readily introduced into the system through the pulmonary surface than by any other; and our aim should therefore be directed to the discovery of some counteracting agents, which can be introduced in the same manner. The pulmonary surface affords a channel for the introduction of certain medicines that can be raised in vapour, when it is desired to affect the system with them speedily and powerfully; such are iodine, mercury, tobacco, stramonium, &c.

4.—*Effects of Suspension of Respiration.*

778. We have now to consider the results of the cessation of the Respiratory function, and the consequent retention of carbonic acid in the blood. If this be sufficiently prolonged, a condition ensues, to which the name of Asphyxia has been given; the essential character of which is the cessation of muscular movement, and shortly afterwards of the circulation; with an accumulation of blood in the venous system. The time which is necessary for life to be destroyed by asphyxia varies much, not only in different animals, but in different states of the same. Thus Warm-blooded animals are much sooner asphyxiated than Reptiles or Invertebrata; on the other hand, a hibernating Mammal supports life for many months, with a respiration sufficiently low to produce speedy asphyxia if it were in a state of activity. And among Mammalia and Birds, there are many species which are adapted, by peculiarities of conformation, to sustain a deprivation of air for much more than the average period.* Excluding these, it may be stated as a general fact, that, if a warm-blooded animal in a state of activity be deprived of respiratory power, its muscular movements (with the exception of the contraction of the heart) will cease within five minutes, often within three; and that the circulation generally fails within ten minutes. Many persons, however, are capable of sustaining a deprivation of air for three, four, or even five minutes, without insensibility or any other injury; but this power, which seems possessed to

* Thus, the Cetacea contain far more blood in their vessels, than do any other Mammalia; and these vessels are so arranged that both arteries and veins are in connection with large reservoirs or diverticula. The reservoirs belonging to the former are usually full; but when the Whale remains long under water, the blood which they contain is gradually introduced into the circulation, and, after becoming venous, accumulates in the reservoirs connected with the venous system. By means of this provision, the Whale can remain under water for more than an hour.

the greatest degree by the divers of Ceylon, can only be acquired by habit. The period during which remedial means may be successful in restoring the activity of the vital and animal functions, is not, however, restricted to this. Cases are not unfrequent, of the revival of drowned persons after a submersion of half an hour; and more than one has been credibly recorded, in which above three-quarters of an hour had elapsed. It is not improbable, however, that in some of these cases a state of Syncope had come on at the moment of immersion, through the influence of fear or other mental emotion, concussion of the brain, &c.; so that, when the circulation was thus enfeebled, the deprivation of air would not have the same injurious effect, as when this function was in full activity. The case would then closely resemble that of a hibernating animal; for in both instances the being might be said to live very slowly, and would therefore not require the usual amount of vital stimuli. The condition of the still-born infant is in some respects the same; and re-animation has been successfully attempted, when nearly half an hour had intervened between birth and the employment of resuscitating means, and when probably a much longer time had elapsed from the period of the suspension of the circulation.

779. It has now been sufficiently proved, both by experiment and by pathological observation, that the first effect of the non-arterialization of the blood in the lungs, is the retardation of the fluid in their capillaries (§ 738); of which the accumulation in the venous system, and the deficient supply to the arterial, are the necessary consequences. It is some time, however, before a complete stagnation takes place from this cause: since, as long as the proportion of oxygen which remains in the air in the lungs is considerable, and that of the carbonic acid is small, so long will some imperfectly-artierialized blood find its way back to the heart, and be transmitted to the system. This blood will have a depressing influence upon the functions of the brain and of the muscular system; which influence is aided by the diminution that gradually takes place, in the quantity of blood propelled through the aorta; and the actions of the respiratory muscles and of the heart will therefore soon become enfeebled. The cessation of the heart's contraction is due to two distinct causes, acting on the two sides; for on the right side it is the result of the over-distension of the walls of the ventricle, owing to the accumulation of venous blood; and on the left to deficiency of the stimulus necessary to excite the movement. The property of contractility is not finally lost, nearly as soon as the movements cease; for the action of the right ventricle may be renewed, for some time after it has ceased, by withdrawing a portion of its contents,—either through the pulmonary artery, their natural channel,—or, more directly, by an opening made in its own parietes, in the auricle, or in the jugular vein (§ 723, *c*). On the other hand, the left ventricle may be again set in action, by renewing its appropriate stimulus of arterial blood. Hence, if the stoppage of the circulation have not been of too long continuance, it may be renewed by artificial respiration: for the replacement of the carbonic acid by oxygen in the air-cells of the lungs, restores the circulation through the pulmonary capillaries; and thus at the same time relieves the distension of the right ventricle and conveys to the left the due stimulus to its actions.

780. Of the mode in which the pulmonary circulation is stagnated by the want of oxygen, and renewed by its ingress into the lungs, no other explanation can be given, than that which has been heretofore offered of the capillary circulation in general;—namely, that the performance of the normal reaction between the blood and the surrounding medium (whether this be air, water, or solid organized tissue) is a condition necessary to the regular movement

of the blood through the extreme vessels.* This view has recently obtained additional support from the experiments of Dr. J. Reid on the Respiration of Azote.† He found that, when the ordinary respiration of an animal is interrupted, and the Asphyxia is proceeding to the stage of insensibility, the first effect upon the arterial system is an increased distension (as indicated by the hæmadynamometer), even although the blood is at that time nearly venous in its character; this indicates that the fluid, now so perverted, is unable to pass with facility through the systemic capillaries, in consequence of its not being in a state fit for the performance of its normal actions. As the stagnation in the pulmonary capillaries becomes more complete, however, less and less blood is returned from the lungs to the heart; and, the systemic arteries being gradually unloaded without being refilled, the pressure of the blood upon their walls diminishes, and is at last no longer experienced. Its diminution is not arrested by causing the animal to breathe nitrogen, although the respiratory movements are renewed,—thus proving that the stagnation of the blood in the capillaries of the lungs is not due (as some have supposed) to a mechanical impediment: but the pressure is immediately increased by the admission of atmospheric air, which occasions the renewal of the pulmonary circulation, and the consequent increase in the supply of aerated blood to the systemic arteries.—It has been shown by Mr. Wharton Jones,‡ that the capillary circulation in a frog's foot is retarded or even checked, by the direction of a stream of carbonic acid gas against the membrane; and he attributes this stagnation to the disposition thus produced in the red corpuscles, to aggregate together and to adhere to the walls of the vessel, so as to choke up its calibre.

CHAPTER XIV.

OF NUTRITION.

1.—*General Considerations.—Selective Power of Individual Parts.*

781. THE function of Nutrition, considered in the widest acceptance of the term, includes the whole series of processes, by which the fluid alimentary materials,—prepared by the Digestive process, introduced into the system by Absorption, and carried into its penetralia by the Circulation,—are converted into Organized tissue; by which conversion it is caused to manifest a set of properties altogether new, which, being neither Physical nor Chemical, are termed Vital. Thus Albumen, which is a perfectly dead or inert substance, and of which the distinguishing properties are entirely attributable to its peculiar composition, is transformed by the Nutritive process into Muscular Fibre, possessed of the remarkable Vital property of Contractility.—But this process of conversion commences in the nutritive materials whilst they are still in a fluid condition, and are moving through the vessels; for we have seen that, at this stage of the operation, the unorganizable Albumen is transformed into

* For a fuller discussion of the Pathology of Asphyxia, see the Author's essay on the subject in the Library of Practical Medicine, vol. iii.

† Edinb. Med. and Surg. Journal, April 1841.

‡ British and Foreign Medical Review, vol. xiv., p. 600.

Fibrine,—a substance which possesses a tendency to spontaneous organization, and which must be regarded as endowed with Vital properties. It is convenient to speak of it, therefore, under a distinct designation; and the term *Assimilation* has been applied to it. In its more restricted sense, the term *Nutrition* is applied to the growth of the various tissues of the body, at the expense of the materials prepared by the Assimilating process, and supplied by the Circulating current.

782. It appears evident, from what has been formerly stated (Chap. III.), that the process of Nutrition mainly consists in the growth of the individual *cells* composing the fabric; and that these derive their support from the organic compounds with which they are supplied by the blood, just as the cells composing the simplest Plants derive theirs from the inorganic elements which surround them. And as different species of the latter select and combine these in such modes and proportions as to give rise to organisms of very diversified forms and properties, so is it easily intelligible that the different parts of the fabric of the highest Animals should exercise a similar selective power, in regard to the materials with which the blood supplies them. The structure composing every separate portion of the body has (what may be termed) an *elective affinity* for some particular constituents of the blood; causing it to abstract from that fluid, and to convert into its own substance, certain of its elements. The property by which the cells of the Animal or Vegetable structure are enabled to perform it, is one of which we are not likely soon to know more. It will probably long remain an ultimate fact in Physiology, that cells have the power of growing from germs, of undergoing certain transformations, and of producing germs that will develop other cells similar to themselves;—just as it is an ultimate fact in Physics, that masses of matter attract each other; or in Chemistry, that the molecules of different substances have a tendency to unite, so as to form a compound different from either of the elements. It is of such ultimate facts as these, that the science of Vitality essentially consists: since the Physical and Chemical phenomena which occur in living bodies, are not strictly removable from the laws of Inorganic Nature. The conditions under which this appropriating power operates, however, are freely open to our investigation; and it is a great step in the progress of the inquiry, to become aware that these are so closely conformable, throughout the organized world, as they have been shown to be. It may be stated, as a general fact, that in assimilating, or converting into its own substance, matter which was previously unable to exhibit any of the manifestations of life, every cell thereby participates in the process of organization and vitalization; for, by the new circumstances in which the matter is placed, its properties undergo a change,—or, to speak more correctly, properties which were previously dormant are caused to manifest themselves. No matter, that is not in a state of Organization, can exhibit those properties, which, from their being peculiar to living bodies, and altogether different from Physical and Chemical, are termed *Vital*; and it may also be asserted that no matter, which exhibits perfect organization, is destitute of the peculiar vital properties belonging to its kind of structure.* As a corollary to this general fact, it may be stated, that no organism can be produced by any fortuitous combination of inorganic matter; since, even for the generation of the simplest cell, there is required a cell previously existing, to furnish the germ.

* For a fuller consideration of this question, and the grounds upon which this view is supported, the reader is referred to the Article *Life* in the *Cyclopedia of Anatomy and Physiology*; and to the Chapter on the "Nature and Causes of Vital Actions," in his *Principles of General and Comparative Physiology*.

783. We have seen that, in some cases, the germs are prepared by previously-existing cells of the same kind; thus the Red and colourless corpuscles of the Blood, the Cartilage-cells, the cells of Vesicular Nervous matter, and those of many other tissues, appear to be the offspring of parents exactly similar to themselves. In other cases, however, the germs seem to be furnished by certain "nutritive centres," which appear to be constantly engaged in the preparation of them, deriving their materials from the blood.* Thus the Epidermic and Epithelial cells are produced, not from preceding cells of a similar character (for these are thrown off without performing any such reproductive act), but from germs derived from the basement or primary-membrane beneath; and, in like manner, the minute cells, of which the ultimate *fibrillæ* of Muscle are composed, appear to originate in nuclei or germinal centres, belonging to the tubular Myolemma. But even these germinal centres may probably be considered as nothing else than the nuclei of certain parent-cells, which, instead of producing their like, give origin to a new generation having different properties. Thus, the basement or primary-membrane has been already stated (§ 135) to exhibit not unfrequently the indications of a cellular constitution; the germinal centres which it contains being the nuclei of its component cells: and its character is particularly well seen where it is inverted so as to form secreting follicles; for, as we have seen (§ 174), each of these follicles may be regarded as a single parent-cell, which opens at the extremity farthest from the nucleus, and continues to discharge from its orifice successive generations of cells, having their origin in its nucleus, which thus acts as a permanent "germinal centre." And in like manner, the germinal centres of Muscular Fibre may be regarded as the nuclei of the cells, of which it was originally composed.

784. The Selecting power, which is possessed by the germs of each kind of tissue, and which enables them to draw from the Blood the materials which they severally require for their development, manifests itself also in the mode in which substances, that are abnormally present in the Blood, affect the condition and development of the solid tissues. Thus we find that the presence of a certain quantity of Arsenic in the Blood, will produce a state of irritation of all the Mucous membranes in the body. The continued introduction of Lead into the circulating system, occasions a modification in the nutrition of the extensor muscles of the forearm, producing the form of partial paralysis commonly termed wrist-drop; and the existence of this modification is shown by the fact (disclosed by Chemical analysis) of the actual presence of lead in the palsied muscles.—Here we have to remark the *Symmetrical* nature of the affection, consequent upon the occurrence of the same disorder in the corresponding parts of the two sides of the body; for these muscles appear to have the same kind of tendency to attract Lead from the circulating current, in a degree that is equal on the two sides, as they have to draw from the blood the materials of their regular growth, and to develop themselves in an exactly similar manner. In like manner, the cutaneous eruptions, which are occasionally produced by the internal exhibition of iodide of potassium, are found to be almost precisely symmetrical; the presence of the medicine in the blood being the occasion of a disordered nutrition of certain parts of the skin; and the selecting power of particular spots being evinced by the exact correspondence of the parts affected on the two sides.

785. The same appears to be the case with regard to substances, whose presence in the blood is rather the result of a disordered condition of the digestive and assimilating processes, than of their direct introduction from without. Thus in Lepra and Psoriasis,—chronic diseases of the Skin, which

* See Goodsir's Anatomical and Pathological Observations, Chap. I.

seem to have their origin in a disordered state of the Blood, rather than in the solid tissues affected,—we find a remarkable tendency to the repetition of the patches, on the two sides of the body, or on the corresponding parts of the limbs; and this we must attribute to the peculiar attraction subsisting between the solid tissues of those parts, and the morbid matter circulating through them.—So in those chronic forms of Gout and Rheumatism, which modify the nutrition of the joints, producing a deposit of “chalk stones,” or permanent distortion and stiffening from an alteration of the tissues, of the joint, we almost invariably find the corresponding joints of the two sides affected.—The chief exceptions to the general principle, that the presence of morbid or extraneous matters in the blood affects all parts alike, are found to occur where there is much febrile disturbance, or where local causes produce a peculiar tendency to disorder of a single part. The nearer the approach presented by the morbid process, in point of rate and character, to the ordinary nutritive operations of the part, the more does it tend to approach these, in the *symmetry* with which it develops itself.*

2.—*Varying Activity of the Nutritive Processes.—Reparative Operations.*

786. Without any change in the *character* of the Nutritive processes, there may be considerable variations in their *degree of activity*; and this, either as regards the entire organism, or individual parts, though most commonly the latter. These variations may be so considerable as to constitute Disease; though there are some which take place as part of the regular series of Physiological phenomena. Thus, the Nutritive processes should have a degree of activity more than sufficient to supply the Waste of the body during the whole period of infancy, childhood and adolescence, until, in fact, its full dimensions are obtained; whilst, on the other hand, they are usually less rapid than the disintegrating processes in old age, so that the bulk of the body diminishes. Now as the Waste of the body, so far from being *more* rapid in old age than in childhood, is much *less* so, it follows that the difference in the activity of the Nutritive processes in these two states must be very considerable; and this is manifested, not only in the greater demand for food which exists in the child (relatively to the bulk of its body), but also in the greater quickness and facility with which injuries are repaired. Local variations may also occur, as part of the regular train of vital actions in the adult; thus we perceive an enormous increase in the amount of tissue contained in the Uterus and Mammary glands during pregnancy, and a decrease in the bulk of the Thymus gland after the period of infancy. Now in these cases we see, that increased Nutrition is invariably connected with increased Functional activity; and diminished nutrition with diminished functional activity: and this we shall find to be the constant rule, in regard also to those variations which must be considered as abnormal.

787. Increased Nutrition, or *Hypertrophy*, is never known to affect the *whole* body, to a degree sufficient to constitute disease. It cannot be produced as a consequence of the ingestion of an undue supply of food: for this does not increase the formative activity of the tissues, but merely renders the blood richer in nutritive materials; a part of which the excreting organs are called on to be continually removing, without its being rendered subservient to the wants of the body (§ 819); whilst another part may be employed in the nutrition of one particular tissue, the Adipose, which has a tendency to increase with the superfluity of non-azotized food, provided that the requi-

* See Dr. W. Budd's valuable paper on the “Symmetry of Disease,” in vol. xxv. of the Medico-Chirurgical Transactions.

site amount of cellular tissue be generated to hold the fatty matter (§ 184). But examples of Hypertrophy of *particular tissues or organs* are very common. Thus any particular set of Muscles, which is subjected to frequent and energetic use, acquires a great increase in bulk; as we see in the arms of a Blacksmith or Waterman, the legs of an Opera-dancer, &c. The hypertrophy of *these* muscles is a consequence of their increased functional activity; which, being produced by an exertion of the will, and unaccompanied with any injurious effects on the system, can scarcely be regarded as morbid. But there are many instances, in which the involuntary muscles acquire a greatly-increased strength, in consequence of an obstruction to their action, which results from disease. Thus we see the right ventricle of the Heart become hypertrophied (and dilated at the same time), where chronic pulmonary disease produces a difficulty in the propulsion of the blood through the vessels of the lungs; the muscular fibres of the Bladder become enormously hypertrophied, when stricture, diseased prostate, or other causes produce a demand for increased expulsive force on the part of that organ; and those of the Stomach also become so, in cases of stricture of the pylorus. As an instance of hypertrophy of a Secreting organ in consequence of an undue excitement of its function, we may notice the enlargement which usually takes place in the Kidney, when its fellow is incapacitated by disease. And the Nervous system presents us with a very remarkable case of hypertrophy of a part, resulting from over-excitement of its function; for if young persons, who naturally show precocity of intellect, are encouraged rather than checked in the use of their brain, the increased nutrition of the organ (which grows faster than its bony case) occasions pressure upon its vessels, it becomes indurated and inactive, and fatuity and coma are the result.

788. Local hypertrophy may be induced also by local congestions; but in such cases it will usually be found, that the form of tissue produced is of the lowest kind, unless the functional activity of the part be increased by the congestion. Thus, when disease of the Heart produces long-continued congestion of the Lungs, Liver, Spleen, &c., the bulk of these organs increases; but chiefly by the production of an additional amount of interstitial Areolar tissue, which may result (as we have seen) from the simple consolidation of Fibrine; and partly also (in the case of the spleen especially) by the gorging of their distensible veins with blood.—One of the least explicable cases of Hypertrophy, is that which takes place in the Thyroid gland, causing Bronchocele. So little is known of the normal office of this organ, that it cannot be determined, whether its increased size be due to an increased activity of its functional operations, or to an unusual formative activity in its tissue, depending on some hidden cause. The connection of this disorder with causes which affect the whole constitution rather than individual parts, would seem to indicate the former.

789. When the Waste of the Tissues is more rapid than their replacement by Nutrition, *Atrophy* is said to take place; and this may affect either the whole body, or individual parts. General Atrophy, Marasmus, or emaciation, may result from an insufficient supply of plastic matter, from want of formative power in the tissues themselves, or from their too rapid disintegration. The insufficiency of the supply of nutritive matter may depend either on deficiency in the azotized substances ingested as food, or on imperfect performance of those processes by which they are converted into the plastic element,—Fibrine. Hence, even when there is an ample supply of food, atrophy may take place to a very severe extent, in consequence of disordered digestion, or a want of vital power in the fibrine-elaborating cells. Again, we have reason to believe that the formative power in the tissues themselves may be diminished, so as to check the process of Nutrition, even when the plastic

material is supplied; thus there seems to be a complete stoppage of this action in Fever, and a diminution of it in that irritable state of the system, which results from excessive and prolonged bodily exertion or anxiety of mind, especially when accompanied by want of sleep. It is difficult to separate this cause, however, from mal-assimilation on the one hand, or from too rapid decay of the tissues on the other: for we know that, in such states, there is a tendency to imperfect elaboration of the Fibrinous element, and at the same time an unusually rapid disintegration, as manifested by the increased amount of Urea in the urine. The influence of excessive waste in causing Atrophy of the body, is well shown in the cases of Diabetes mellitus and colliquative Diarrhœa; in both these, the increase and depravation of the secretions are undoubtedly to be regarded as the effects, and not the causes, of the textural changes with which they are associated. Colliquative Diarrhœa is a constant occurrence on the last day or two of life, in animals reduced by Starvation; and is accompanied by that fetid odour of the body, which indicates that decomposition is already going on throughout the system. The same thing occurs as the ordinary termination to many diseases of exhaustion; in which Inanition is unquestionably the immediate cause of death.

790. Partial Atrophy may occur in consequence of disuse of the organ affected, occasioning inactivity in its formative processes; or as a result of a deficiency of nutriment, occasioned by an obstruction to the circulation. Of the operation of the former cause, we have many examples in the ordinary processes of the economy. Thus the Uterus is atrophied, relatively to its previous condition, as soon as parturition has taken place; and the Mammary glands, when lactation has been discontinued. It is probably in part to this cause, and in part to the diversion of the blood into other channels, that we are to attribute the atrophy of many parts, as the development of the system advances, which at an earlier period were of large comparative size,—such as the Corpora Wolffiana, the Suprarenal capsules, and the Thymus gland. Many instances might be adverted to, of the influence of suspension of functional activity, as a result of disease or injury, in producing local atrophy. One of the most common cases, is the atrophy of Muscles which is consequent upon their disuse. This disuse will produce the same effect, whether it be occasioned by paralysis, which prevents the nervous centres from exciting the muscles to contraction; or by ankylosis, which interposes a mechanical impediment to their use; or by fractures or other accidents, the reparation of which requires the limb to be kept at rest. Or even if, without having suffered from any injury, a limb be fixed during some time in one posture, its muscles will become atrophied, as is seen in the case of the Indian Fakirs. (See § 588). Similar facts may be adduced, in regard to Atrophy of Nerves, from interruption of their normal function. Thus when the Cornea has been rendered so opaque by accident or disease, that no light can penetrate to the interior of the eye, the Retina and the Optic nerve lose, after a time, their characteristic structure; so that scarcely a trace of the peculiar globules of the former, or of the nerve-tubes of the latter, can be found in them. These and similar facts are readily understood, when connected by the general principle formerly laid down,—that every proper *vital* operation involves an act of nutrition; in such a manner that, whilst the vital properties of any part are dependent upon its due nutrition, the amount of its nutrition will in return depend upon the degree in which these properties are exercised.

791. Partial Atrophy may depend, however, upon causes of a purely mechanical nature; such, for example, as produce an interruption of the current of Blood through the part. This may result from changes in the Arteries supplying it; such as ossification, or other forms of obstruction. Or it may be consequent upon disease in the part itself; as when the deposits produced

by Inflammation tend to contract, and thus to press upon the vascular structure, which frequently happens in the lungs, liver, and kidneys; or when the inflammation occurs in the vessels themselves, causing adhesion of their walls, and obliteration of their tubes; or when a new growth absorbs into itself all the nutritive materials which the Blood supplies.*

792. The nutritive operations take place, with extraordinary energy and rapidity, in the process of *Reparation*; by which losses of substance, occasioned by injury or disease, are made good. In its most perfect form, this process is exactly analogous to that of the *first development* of the corresponding parts; and its results are as complete in the one case as in the other. In fact, among the lowest tribes of Animals, we find these two conditions blended, as it were, together; for the process of reparation may be carried in them to such an extent, as to regenerate the whole organism from a very small portion of it. In the Hydra, or Fresh-water Polype, there would seem to be scarcely any limit to this power; for, if the body of the animal be minced into the smallest possible fragments, every one of these can produce a new and perfect being. In this manner no less than forty have been artificially generated from a single individual.—In ascending the Animal scale, we find this reparative power less conspicuous, because exercised with regard to smaller parts only of the body; but the greater complexity of the changes involved in the process, renders it in reality not less considerable than in the lower classes. Thus, the restoration of a Bone destroyed by Necrosis is a much more extraordinary operation, than the growth of an entire Polype from a single fragment; since it involves a far greater amount and variety of actions. Numerous and well-authenticated instances are on record, of the reunion of parts that had been entirely separated from the body, and of the restoration of all their vital properties: and this could only take place, through the perfect reproduction of a large number of very different structures. The reappearance of Fungous growths, whose organization is of a low character, is a fact with which every surgeon is familiar; and cases occasionally, though rarely, present themselves, in which reproduction of a whole member takes place even in the Human subject.†

793. It is the general opinion among British surgeons (founded upon what they believe, but erroneously, to have been the doctrine of Hunter), that Inflammation is essential to the process of Reparation. There is no doubt that, as usually conducted, the healing of wounds is attended by a greater or less degree of Inflammation; but it does not thence follow that this morbid condition is essential to the renewal of the healthy state; and in fact it can be shown that, in the majority of cases, the Inflammation is injurious rather than beneficial. The following important conclusions are drawn by Dr. Macartney‡ from a very philosophical comparative survey of the operations of Reparation and Inflammation, as performed in the different classes of animals:—"That the powers of Reparation and Reproduction are in proportion to the indisposition or incapacity for Inflammation;—that Inflammation is so far from being necessary to the Reparation of parts, that, in proportion as it exists, the latter is impeded, retarded, or prevented;—that, when Inflammation does not exist, the Reparative power is equal to the original tendency to produce and maintain organic form and structure;—and that it then becomes a natural function, like the growth of the individual, or the reproduction of the species."

794. Guided chiefly by Dr. Macartney's views, which have derived im-

* See on this subject Dr. Williams' Elements of Medicine, chap. iv.; to which the Author is partly indebted for the preceding paragraphs.

† See, on the whole of the subject of the comparative powers of Reparation in the Animal series, the Author's Principles of Gen. and Comp. Physiol. §§ 586, 587.

‡ Treatise on Inflammation, p. 7.

portant confirmation from recent observations, we shall treat of the reparative processes under three distinct heads:—*First*, the adhesion of the sides of a wound by a medium of coagulable lymph, or of a clot of blood. *Second*, reparation without any medium of lymph or granulations, the cavity of the wound being filled by a natural process of growth from its walls. *Third*, reparation by means of a new, vascular, and organized substance, termed Granulations.—The first of these modes of Reparation, is that which is ordinarily termed *union by the first intention*; of this kind of adhesion, the healing of the incision made in venesection, which usually takes place almost without consciousness on the part of the patient, and with scarcely any Inflammation, is a characteristic example: the white line of cicatrix which is left, marks the formation of new substance; and is the result of the want of that perfect approximation of the lips of the wound, which may frequently be obtained in parts, where pressure can be more firmly applied, and where the space to be filled up is proportionably thinner. This mode of union is ordinarily considered by British Surgeons to be the result of an *adhesive inflammation*. In so regarding it, they conceive that they are following out the views of Hunter; but he expressly states that wounds may heal without any pain or constitutional disturbance, the reunion proceeding “as if nothing had happened;” so that he in effect admits, that reparation of this kind may take place without Inflammation. It is well known that if a slight wound, which is thus healing, be provoked to an increased degree of Inflammation, its progress is interrupted; and all the means which the Surgeon employs to promote union, are such as tend to prevent the accession of this state. The doctrine that the effusion of Lymph for the Reparation of the tissues, is not to be regarded as necessarily a result of the Inflammatory process, is not so novel as its opponents have regarded it; since it has been maintained by many eminent observers, even from the earliest times. The only case in which the occurrence of Inflammation can be regarded as salutary, is that in which there is a deficiency of Fibrine in the blood, causing a deficient *organizability* of the lymph. It has been seen that the amount of Fibrine is rapidly increased by inflammation; and the Surgeon well knows that a wound with pale flabby edges, in a depressed state of the system, will not heal, until some degree of Inflammation has commenced.

795. When the Liquor Sanguinis of the Blood, known as Coagulable Lymph, is effused between the two edges of a wound, or upon the surface of a membrane lining a closed sac, the following appears to be the history of its organization. The new matter, which is poured out in a fluid state, and which seems to have been subjected to the peculiar influence of the Colourless Corpuseles that rapidly collect in large numbers at the injured spot, undergoes a Coagulation resembling that of Blood; the Serum, being set free by the concretion of the Fibrine, is absorbed; and the fibrinous coagulum speedily attains an almost membranous density. If examined with a Microscope at the commencement of the process of organization, it is seen to contain a large number of cells, which sometimes closely resemble the Colourless Corpuseles of the Blood; and in other instances (especially where there has been active Inflammation) present greater similarity to Pus-corpuseles; these cells, which are known as exudation-corpuseles, probably originate in granules set free from the Colourless Corpuseles of the circulating blood, and exuded with the Liquor Sanguinis. In a short time, these corpuseles present the appearance of regular cells, disposed in layers, and adhering together by an intermediate unorganized substance; bearing, in fact, a strong resemblance to the cells of tessellated epithelium. Some hours later, the mass exhibits an evidently-fibrous character; which is probably due to the further elaboration of the plastic material, by the cells just mentioned. Between the fibres, a

considerable amount of unorganized substance yet remains; and they may be readily separated, or torn in any direction. A vascular rete next makes its appearance, in connection with the vessels of the subjacent surface; the first appearance of this network is in the form of transparent arborescent streaks, which push out extensions on all sides; these encounter one another, and form a complete series of capillary reticulations, the distribution of which very nearly resembles that which has been seen in the villi of the intestines (Fig. 204).—From the observations of Mr. Travers* it appears, that isolated globules enter these capillary tubes, and perform an oscillatory motion in them for some hours, before any series of them passes into it; so that we cannot regard the new channel as burrowed out by a string or file of red corpuscles, pushed out from the nearest capillary by *vis à tergo*, as some have maintained. And he has further established two important facts, in the history of the Reparation of Tissues, which correspond with the observation just cited:—1. That the Liquor Sanguinis first effused is not sufficiently organizable to become an entirely *new and permanent* tissue; although adequate both to afford nutrition to the old, and to form a new tissue of temporary character:—and, 2. That the generation of the new tissues is preceded by the collection of a large number of white corpuscles, in a nearly stationary condition, in the blood-vessels immediately subjacent; and by the appearance of a large number of similar cells in the newly-forming tissue; the two together constituting what Mr. T. has aptly called “the new lymph-bed of organization.” The views formerly advanced (§§ 154–159) respecting the function of the Colourless Corpuscles, are thus strikingly confirmed.—This process of Reparation appears to be conformable, in all essential particulars, with that which has been observed in the first Development of new parts,—such as the toes of the larva of the Water-Newt.

796. Although many have doubted whether effusions of *Blood* could thus become organized, there seems no valid reason to think that its Fibrine would comport itself in any other way, when Red particles are included in its coagulum, than when they are absent. That large masses of extravasated Blood should exhibit little or no tendency to organization, will not be considered surprising; when it is remembered that only their surface can be in that relation with a living membrane, which has been stated to be essential to the further vitalization of the effused Fibrine (§ 119). It has been proved in many instances, however, that Coagula of Blood completely inclosed within the body possess an incipient vascularity, being capable of injection from the surface beneath (§ 700);† and there is no valid reason to deny that the thin layer of Blood which remains between the lips of an incised wound, when these are closely brought together, is the medium of their reunion. It is unquestionable, however, that the Fibrine of an ordinary Blood-clot is less highly-elaborated, and consequently less susceptible of organization, than that of the Liquor Sanguinis, which is poured forth after an injury, and which has been subjected to the local action that is its immediate result.

797. To the *second* mode of Reparation, attention has recently been strongly directed by Dr. Macartney; and as this, too, is a strictly Physiological action, and is one which the Surgeon should aim at producing, it will be here discussed somewhat in detail. The Surgeon has, until recently, regarded the processes of Granulation and Suppuration, which are attended with much local Inflammation, and with a considerable amount of Constitutional disturbance when the surface is large, as the only means by which an open wound

* Physiology of Inflammation and the Healing Process.

† For well-established cases of this sort, see communications by Mr. Dalrymple in the Medico-Chirurgical Transactions, vol. xxiii.; and in Lancet, March 23, 1844.

can be filled up. Occasional instances, however, have not been wanting, in which large open wounds have closed up under the dry clot of blood, by which they were at first covered over, without any suppuration, or other symptom of inflammation; and in these it has been found, that the new surface much more nearly resembles the ordinary one, than does the Cicatrix which follows granulation. To Dr. Macartney, however, is due the merit of explaining the *rationale* of this action; which is precisely analogous to that which is concerned in the ordinary processes of growth, and to that reproduction of whole parts which takes place in the lower animals without Inflammation. It is termed by him the *modelling* process; and he remarks as characteristic of it that, when it goes on perfectly, and without Inflammation, the patients are so completely free from uneasy sensations, as only to be aware of the extent of the injury by their own examination. In this process, the surfaces of the wound do not unite by vascular connection, even when they lie in contact; nor is the space between them filled up with coagulable lymph; but they are smooth and red, moistened with a fluid, and presenting the appearance of one of the natural mucous membranes. "It might be anticipated that, as this mode of reparation bears so strong a resemblance to the natural formation and development of parts, it is the slowest mode; but this is of little account, when compared with its great advantages in being unattended with pain, inflammation, and constitutional sympathy, and leaving behind it the best description of cicatrix." In the case of large burns on the trunk in children, the difference between the two modes of Reparation will frequently be that of life and death; for it often happens that the patient sinks under the great constitutional disturbance occasioned by a large Suppurating surface, although he has survived the immediate shock of the injury.

798. The most effectual means of promoting this kind of Reparative process, and of preventing the interference of Inflammation, vary according to the nature of the injury. The exclusion of air from the surface, and the regulation of the temperature, appear the two points of chief importance. By Dr. Macartney, the constant application of moisture is also insisted on.* He states that the immediate effects of injuries, especially of such as act severely upon the sentient extremities of the nerves, are best abated by the action of "steam at a high but comfortable temperature, the influence of which is gently stimulant, and at the same time extremely soothing. After the pain and sense of injury have passed away, the steam, at a lower temperature, may be continued; and, according to Dr. M., no local application can compete with this, when the Inflammation is of an active character. For subsequently restraining this, however, so as to promote the simple Reparative process, Water-dressing will, he considers, answer sufficiently well; its principal object being the constant production of a moderate degree of Cold, which diminishes, whilst it does not extinguish, sensibility and vascular action, and allows the Reparative process to be carried on as in the inferior tribes of animals. The reduction of the heat in an extreme degree, as by the application of ice or iced water, is not here called for, and would be positively injurious; since it not only renders the existence of Inflammation in the part impossible, but, being a direct sedative to all vital actions, suspends also the process of restoration. The efficacy of Water-dressing in injuries of the severest character, and in those which are most likely to be attended with violent Inflammation (especially wounds of the large joints) has now been established beyond all question; and its employment is continually becoming more general.†—Other plans have been proposed, however, which

* Treatise on Inflammation, p. 178.

† See an account of the results of this treatment by Dr. Gilchrist, in Brit. and For. Med. Rev., July 1846, p. 242.

seem in particular cases to be equally effectual. To Dr. Greenhow, of Newcastle, for instance, it was accidentally suggested, a few years since,* to cover the surface of recent burns with a liquefied resinous ointment; and he states that in this manner Suppuration may be prevented, even where large sloughs are formed; the hollow being gradually filled up by new tissue, which is so like that which has been destroyed, that no change in the surface manifests itself, and none of that contraction, which ordinarily occurs even under the best management, subsequently takes place. A plan has, moreover, been proposed for preventing suppuration, and promoting reparation by the modelling process, which consists in the application of *warm dry air* to the wounded surface. The experiments made on this have not been entirely satisfactory, but they seem to show that, though the process of healing is much slower under treatment of this kind, it is attended with less constitutional disturbance than is unavoidable in the ordinary method; and it may, therefore, be advantageously put in practice in those cases in which the condition of the patient requires every precaution against such an additional burthen,—as after amputation in a strumous subject. But of the superiority of this treatment to the water-dressing, no evidence has yet been adduced.

799. The *third* method of Reparation,—that by *Granulation*—appears to be a means employed by Nature for the purpose, under the unfavourable circumstances of Irritation or a continuance of Inflammation; proving that parts previously in a healthy state, are disposed to heal, in despite of many impediments thrown in their way. The Granulation-structure is a special one, formed for a temporary purpose. It is endowed with higher vascularity and a more rapid power of growth, than is possessed by any modification of ordinary tissue; but it is very easily destroyed by injury, or by a higher degree of inflammation. The existence of Granulations has been supposed to be necessary to fill up deficiencies; this, however, is not altogether true; as we occasionally find very considerable vacancies filled with lymph, which gradually becomes organized, without being converted into granulations; and the void may be also supplied by the process of natural growth just described. Moreover, it is only in the beginning that granulations take the place of the natural structure; for the approximation of the edges of a wound filled with them, requires that they should be removed by interstitial absorption; so that wounds healed by this process do not exhibit any remains of the new medium. This approximation somewhat resembles that which occurs in open wounds that have never inflamed, being the result of the natural processes of growth; and it does not take place until the Inflammation has in great degree subsided: but it differs from the modelling processes in this,—that, as the wound is occupied by granulations, its closure takes place prematurely, as it were; so that, when the granulations are subsequently absorbed altogether, a contracted cicatrix is the result.—It will be presently seen that the formation of the Granulation-structure is intimately connected with the elaboration of Pus; and this process, accompanied as it is with such great constitutional disturbance, and involving such a loss of nutritious material, cannot but be regarded as an action to be altogether avoided, if possible.

800. We shall now consider, more in detail, the nature of the process of Granulation, and of the Suppuration which usually accompanies it. Its commencement is exactly conformable to the first stage of ordinary reunion by the first intention; for *Liquor Sanguinis* is thrown out, in which *Exudation-corpuscles* present themselves in large numbers. According to Gerber, the transformation of these into a sort of imperfect *Epithelium* may be seen to take place within half an hour. New layers are in the mean time developed; and

* Medical Gazette, Oct. 13, 1838.

the most superficial of the Exudation-corpuscles, which are exposed to the contact of air, change their character (in the mode to be presently described, § 805), and become Pus-globulés; whilst those in close contact with the subjacent surface take a share in the process of reparation. A new layer of exudation-corpuscles is next deposited over this: of which the outer portion degenerates as before into pus-globules, whilst the inner part gives origin to a kind of areolar tissue, forming Granulations. These Granulations are themselves extremely vascular; and, as recently shown by Mr. Liston,* the vessels of the subjacent tissue are much enlarged, and assume a varicose character. The bright red colour of the Granulations, however, does not depend on their vascularity alone; for the cells themselves, especially those most recently evolved, are of nearly as deep a colour as the blood-globules; and the superficial bleeding which follows even the slightest touch of the granulating surface, does not proceed from blood shed from the newly-formed vessels only; for the red fluid shed in this manner contains, besides blood-discs, newly-developed red cells, ruddy cytoblasts, pale granules and reddish serum. It is a common property of animal cytoblasts, that they present a red colour on their first formation, when in contact with oxygen; but this hue they lose again, whether they advance to perfect development and become integral parts of a living tissue, or die and degenerate.

801. The process of Granulation and Suppuration appears to differ from that of simple Reparation (the *modelling process* of Dr. Macartney) in this,—that a large part of the Exudation-corpuscles deposited on the wounded surface degenerate into Pus in the former case, whilst none are thus wasted in the latter;—but that the existence of Inflammation occasions a more copious supply of Fibrine in the former case, and increases its tendency to become organized; the filling-up of a wound with Granulations being thus a much more rapid process than that renewal of the completely-formed Tissues, which may take place in the absence of Inflammation. The imperfect character of the Granulation-structure is shown, by the almost complete disappearance of it after the wound has closed over. The portion of it in immediate contact with the subjacent tissue, however, appears to undergo a higher organization; for it becomes the medium by which the Cicatrix is made to adhere to the bottom of the wound. It is very liable to undergo changes which end in its disintegration; as is evident from the known tendency to re-opening, in wounds that have been closed in this manner.

3.—*Abnormal Forms of the Nutritive Process.*

802. Under the preceding head, we have considered the chief variations in the degree of activity, that are witnessed in the ordinary or normal conditions of the Nutritive process,—that is, those conditions in which the products are adapted, by their similarity of character, to replace those which have been removed by disintegration. But we have now to consider those forms of this process,—in which the products are *abnormal*,—being different from the tissues they ought to replace. We shall confine ourselves to a brief examination of the two most important of these states;—that which is termed Inflammation;—and that which gives rise to Tubercular deposit. The former results from an *excess* of the plastic element in the blood; the latter from a *depraved* condition of it, whereby its plasticity is impaired or destroyed.—Notwithstanding all the attention which has been given to the state of the *vessels* in Inflammation, a careful consideration of its phenomena, with the light which recent investigations have thrown upon these, leads us to attach

* Medic-Chirurgical Transactions, vol. xxiii.

comparatively little importance to this, and to seek for the essential character of the process elsewhere. The researches of Addison, Williams, Barry, Gulliver, Andral, and others, all seem to point to the following conclusions:—1. That there is a peculiar afflux or determination of the White Corpuscles of the Blood towards the inflamed part. 2. That the total amount of these corpuscles in the circulating blood undergoes a great increase. 3. That the quantity of Fibrine in the Blood augments, in proportion to the extent and intensity of the Inflammation; and this, even when it was previously, from the influence of some other morbid condition, below the usual standard. With its quantity, its plasticity, or tendency to organization, also increases in a healthy subject.—Now when these facts are compared together, and are connected with those formerly adduced, in regard to the probable function of the White Corpuscles of the blood, they lead almost irresistibly to the conclusion, that the process of Inflammation essentially consists in an undue stagnation of these corpuscles in the vessels of the part, an excessive multiplication of them by the ordinary process of generation, and a consequent over production of Fibrine. By these changes, and by the results which follow them, Inflammation may be distinguished from the various forms of Hyperæmia and Congestion. To the results, then, we shall next direct our attention.

803. It may be inferred from various phenomena, that whilst the formative power of the *Blood* is increased in Inflammation, that of the *Tissues* is diminished. Certainly this is the case in regard to the system at large, when febrile irritation has been established; for, notwithstanding the increased Plasticity of the Blood, we see the body wasting, instead of increasing in vigour. And it may be inferred also, in regard to the tissues of the part affected, from the tendency to Atrophy and Disintegration which they exhibit; and which is greater (leading even to the death of whole parts) in proportion as the inflammation is more intense, and as the tendency to the deposit of new products is the more decided. That a Stagnation of Blood takes place in the vessels of the inflamed part, is another general fact, which throws some light upon the nature of the process; for this stagnation is obviously favourable to the transudation of the fluid Plasma of the blood, through the walls of the vessels, into the surrounding tissue, or upon a neighbouring surface. This deposition of the Fibrinous element, possessing a high degree of plasticity, and capable of spontaneously passing into simple forms of tissue (which may be gradually replaced by higher forms, when penetrated by vessels from the surrounding parts), may be regarded as the first characteristic result of Inflammation. It is by the deposition, and subsequent organization, of plastic matter in the *substance* of organs, that their tissues become consolidated; and by its deposition and subsequent organization upon their free *surfaces*, that false membranes and adhesions are formed. It appears probable, from the recent inquiries of Mr. Robinson,* that this deposition may be attributed to physical causes. It is well known, that simple Congestion will occasion transudation of the *serous* portion of the Blood; and if the return of the Blood by the veins of a part be completely prevented, a greater or less proportion of *fibrine* also may be poured forth. Now when the quantity of Fibrine in the blood is greatly augmented, and the firmness of the walls of the vessels in the inflamed part is diminished by the alterations taking place in their tissue, it is easy to understand that the disposition to the effusion of Fibrine will be much increased. Sometimes the Fibrine is diluted with a large quantity of Serum; and is poured into a cavity (as that of a serous sac) in the form of a liquid, which afterwards separates into clot and serum.

* Medico-Chirurgical Transactions, vol. xxvi. p. 51.

804. Should the Inflammation increase in intensity, a complete stagnation of blood in the tissue most affected, or even in an entire organ, will be the result; and this will occasion its *death*. If a large part be thus entirely destroyed at once, the process is termed *Gangrene*; and it separates from the living part, at a line where the Inflammation is less intense, and where there is a deposit of Fibrine, which serves the important purpose of closing the mouths of the blood-vessels that are laid open by the process. If the destruction of tissue, however, be *interstitial*, the dead parts are not thus thrown off, but are taken up by the absorbent process; and thus the cavity of an *Abscess*, or of an *Ulcer* is formed. This cavity is usually bounded by tissue, that has been consolidated by the effusion of Fibrine;—a fact readily accounted for on the principles just stated. For the death and removal of tissue take place, where the Inflammation has been most intense and the stagnation most complete, which is in the centre of the inflamed spot; and the fibrinous effusion, the result of moderate inflammation, is poured into the surrounding tissue. The elements of *Liquor Sanguinis* are poured into the central, as well as the peripheral, portion of the inflamed tissue; but they assume a different form—that of Pus. It would appear as if the influence of the surrounding death and decay produces a *degradation* of their character; so that they become entirely *aplastic* or unorganizable, although immediately derived from Blood highly charged with Fibrine.

805. Between Coagulable Lymph and Purulent effusions, there are many degrees of transition; the very same deposit being frequently organizable at one part,—presenting the character of a tough fibrous membrane, interspersed with corpuscles,—whilst it is friable in another, from want of complete fibrillation in the fluid portion of the effusion,—and is entirely destitute of tenacity in a third portion, especially the superficial part, or free surface, of the deposit. When examined by the Microscope, Pus is found to be characterized by the presence of a number of cells of a peculiar aspect, having a very tuberculated or mulberry surface; these are seen floating in a fluid, termed *liquor puris*, which is of an albuminous or low fibrinous character, being entirely destitute of organizability. Now the production of Pus in an inflamed part, or in other words, the act of Suppuration, may be due to one of three causes, viz.—the intensity of the inflammation; the presence of air, which becomes a source of irritation; and a previously vitiated state of the blood. Various attempts have been made to show that the Pus-globule is a degenerated red or white corpuscle of the Blood; it seems more probable, however, that it does not escape from the vessels as a complete cell, but as a cell-germ, which may have had its origin in a white corpuscle of the blood; and which, under favourable circumstances, might have produced an Exudation-corpuscle (§ 800). At any rate, it must be regarded as a *degenerated* form of cell; and the *liquor puris* must be considered as analogous to the plasma of the Blood in a degenerated state.

806. In what manner the Inflammatory process determines the formation of the Pus-cell, and the consequent degradation of the product, we are at present unable to state; but that the degree of irritation in the part has an influence upon it, is evident from the effects of the contact of air upon inflamed surfaces, causing those elements to take the form of Pus, which would otherwise have been thrown out as a plastic deposit. This circumstance would seem to indicate, beyond all doubt, that the Exudation and Pus-corpuscles, the plastic Lymph and the aplastic *Liquor puris* have the same origin; but that their character is determined by local circumstances. There is great reason to believe, that when Pus is introduced into the Blood, it may induce such a change in the character of the fluid, as speedily to impair its vital properties; so that the Pus-corpuscles will rapidly propagate themselves in the

Blood, and the plasticity of the *Liquor Sanguinis* will be diminished. In this manner the whole system will be seriously affected, and there will be a tendency to deposits of Pus in various organs—especially in those which, like the Lungs and Liver, serve as emunctories to the system—without any previous inflammatory changes in these parts. It has been ascertained by Mr. Addison, that if a drop of Pus be treated with *Liquor Potassæ*, it entirely loses its opaque character, and becomes clear and transparent, like Mucus,—with whose tenacity and elasticity also it becomes endowed. If it be then treated with acetic acid, it recovers somewhat of its former opacity; and, when pressed into a thin film, exhibits a distinct fibrillation.

807. In persons of that peculiar constitution, which is termed *Scrofulous* or *Strumous*, we find an imperfectly-organizable or *Caco-plastic* deposit, or even an altogether *aplastic* product, known by the designation of *Tubercular* matter, frequently taking the place of the normal elements of Tissue; both in the ordinary process of Nutrition, and still more when Inflammation is set up. From an examination of the Blood of Tuberculous subjects it appears, that the Fibrinous element is not deficient in amount, but that it is not duly elaborated; so that the coagulum is loose, and the red corpuscles are found to bear an abnormally low proportion to it. We can understand, therefore, that such a constant deficiency in Plasticity must affect the ordinary nutritive process; and that there will be a liability to the deposit of cacoplastic products, without Inflammation, instead of the normal elements of tissue. Such appears to be the history of the formation of Tubercles in the lungs and other organs, when it occurs as a kind of metamorphosis of the ordinary Nutritive process; and in this manner it may proceed insidiously for a long period, so that a large part of the tissue of the lungs shall be replaced by an amorphous deposit, without any other ostensible sign than an increasing difficulty of respiration. It is in the different forms of Tubercular deposit, that we see the gradation most strikingly displayed between the plastic and the aplastic formations. In the semi-transparent, milky, gray, and tough yellow forms of Tubercle, we find traces of organization in the form of cells and fibres, more or less obvious; these being sometimes almost as perfectly formed as those of Plastic Lymph, at least on the superficial part of the deposit, which is in immediate relation with the living structures around; and sometimes so degenerated, as scarcely to be distinguishable. In no instances do such deposits ever undergo further organization; and therefore they must be regarded as *caco-plastic*. But in the opaque, crude, or yellow Tubercle, we do not find even these traces of definite structure; for the matter of which it consists is altogether granular, more resembling that which we find in an albuminous coagulum. The larger the proportion of this kind of matter in a tubercular deposit, the more is it prone to soften, whilst the semi-organized tubercle has more tendency to contraction. This is entirely *aplastic*.

808. Now although Tubercular matter may be slowly and insidiously deposited, by a kind of degradation of the ordinary Nutritive process, yet it cannot be doubted that Inflammation has a great tendency to favour it; so that a larger quantity may be produced in the lungs, after a Pneumonia has existed for a day or two, than it would have required years to generate in the previous mode. But the character of the deposit still remains the same; and its relation to the plastic element of the blood is shown by the interesting fact, of no unfrequent occurrence,—that, in a Pneumonia affecting a Tuberculous subject, Plastic Lymph is thrown out in one part, whilst Tubercular matter is deposited in another. Now Inflammation, producing a rapid deposition of Tubercular matter, is peculiarly liable to arise in organs, which have been previously affected with chronic Tubercular deposits, by an impairment of the process of textural Nutrition; for these deposits, acting like foreign bodies,

may of themselves become sources of irritation; and the perversion of the structure and functions of the part renders it peculiarly susceptible of the influence of external morbidic causes.—These views, at which several recent Physiologists and Pathologists have arrived on independent grounds, seem to reconcile or supersede all the discordant opinions which have been upheld at different times regarding the nature of Tubercle; and lead to the soundest views with respect to the treatment of the Diathesis.

809. We frequently meet with abnormal growths of a Fatty, Cartilaginous, Fibrous, or even Bony structure; which result from the development of these tissues in unusual situations, and appear to originate in some perverted action of the parts themselves.—But there is another remarkable form of disordered Nutrition, which is concerned in producing what have been termed *heterologous* growths,—that is, masses of tissue, differing in character from any which is normally present in the body. Most of these are included under the general designation of *Cancerous* or *Fungous* structures; and it has been shown by Müller and others, that the new growth consists of a mass of cells; which, like the Vegetable Fungi, develope themselves with great rapidity; and which destroy the surrounding tissues by their pressure, as well as by abstracting from the Blood the nourishment which was destined for them. These parasitic masses have a completely independent power of growth and reproduction; and it seems difficult to refuse them the character of distinct existences. They can be propagated by inoculation, which conveys into the tissues of the animal operated on, the germs of the peculiar cells that constitute the morbid growth; and these soon develope themselves into a new mass. It seems to be by the diffusion of the germs produced in one part, through the whole fabric, by the circulating current, that the tendency to re-appearance (which is one great feature in the *malignant* character of these diseases) is occasioned. Yet there is no evidence, that the first production of a Cancerous growth is due to germs introduced from without; in fact, as it appears to the Author, the history of its origin, as well as the analogy of similar cases, makes it far more probable, that the Cancer-cell is but an abnormal form of the ordinary tissue-cells of the body,—being, in fact, a cell which possesses to an unusual degree the power of *reproduction*, instead of undergoing those *transformations* by which it would be converted into other kinds of tissue.

a. Several instances have been recently published, of the occurrence of Vegetable organisms as parasites upon the Animal body. That in some of these a true Plant, possessing a regular apparatus of nutrition and reproduction, has arisen from a germ introduced from without, there can be little question; but in other instances (as in the case of the crusts of *Porrigo favosa*), it has been assumed that the organization is Vegetable, merely because it consists of a mass of cells capable of extending themselves by the ordinary process of multiplication. But it must be remembered, that the cellular organization is common to Animals as well as to Plants; being the only form that manifests itself at an early period of development in either kingdom, and remaining throughout life in those parts which have not undergone a metamorphosis for special purposes. Hence to speak of *Porrigo favosa*, or any similar disease, as produced by the growth of a Plant within the Animal body, appears to the Author a very arbitrary assumption; the simple fact being, in regard to this and many other structures of a low type, that they present the simplest or most general kind of organization. Their nature must be decided by their Chemical constitution; and this, in the case of the *Porrigo favosa*, appears to be unquestionably Animal.

b. There seems a strong probability in the idea, that the propagation of many diseases by inoculation, essentially consists in the transplanting of cell-germs from the body of one animal to that of another. Thus the Vaccine Vesicle appears to be made up of an aggregation of distinct cells, to which we may very fairly attribute an origin of this kind. But this seems rather true of diseases which manifest themselves by a local development of cellular structures,—such as Cancer and Cow-pox,—than of such as Hydrophobia, Plague, Poisoning by Serpents, &c., in which the symptoms are referrible, more or less clearly, to an alteration in the character of the Blood, by the introduction of a substance acting as a ferment (§ 708).

4.—*Varying duration of different parts of the Organism.*

810. From the foregoing details the obvious inference results,—that each part of the organism has an individual Life of its own, whilst contributing to uphold the general Life of the entire being. This Life, or state of Vital Action, depends upon the due performance of the functions of all the subordinate parts, which are closely connected together. The lowest classes of organized beings are made up of repetitions of the same elements; and each part, therefore, can perform its functions in great degree independently of the rest. But, in ascending the scale, we find that the lives of the individual parts become gradually merged (so to speak) in the general life of the structure; for these parts gradually become more and more different in function, and therefore more and more dependent on each other for their means of support; so that the activity of all is necessary for the maintenance of any one.

811. The doctrine of Development from Cells gives us a clearer idea of the nature of the continual process of decay and renewal, which take place in the Animal body. Every Cell has, to a certain degree, an individual life of its own. This individuality is much more decided in the lower forms of organized being, where each cell can maintain an independent existence, than it is in the higher, in whose fabric a large number having different functions are united into one structure, the combined activity of the whole of which is necessary to the life of any one. But, even in the highest, it is evident that each cell will possess a certain *duration* of its own; and that, from its first period of development, all the changes which it undergoes are governed by laws peculiar to it. In the various parts of the Vegetable, as in those of the Animal, we find a great difference in the duration of the existence of the cells composing them. These differences may be reduced to five heads.

i. Cells may be generated, which have a very transient existence, and which disappear again, without undergoing any transformation. This may be seen in the Vegetable ovule, and in the Germinal Vesicle of the Animal Ovum; as well as in many other parts. Thus we have *Absorbent Cells* (§ 181), *Secreting Cells* (§ 179), and probably *Assimilating* or Fibrine-elaborating Cells (§ 154); all of which originate in pre-existing germs, attain their full development (in the course of which they perform their allotted function), and then disappear by rupture or liquefaction. In such instances it is obvious that, from their first origin, the cells are subject to a law of *limited duration*, and that their death and decay are as much the result of their inherent constitution, as are those of each entire Animal or Vegetable organism.

ii. The contrary extreme to this may be found in those Cells, of which the function, instead of being transient, is to be indefinitely prolonged; such are those of which the organs of *mechanical support* are usually formed. Here the cell, instead of changing its form, or of giving origin to new cells within itself, becomes the subject of an internal deposit of hard matter, which lines its walls, and cuts it off, more or less completely, from the general course of Vital Action. When this is the case, and the hard matter is not itself liable to decomposition, the duration of the cell-walls, which are protected by their peculiar aggregation from exposure to decomposing agents, may undergo little or no change for an almost indefinite period. Thus the heart-wood of Plants, the Bones of Animals, and still more their Hair, Hoofs, Horns, &c., may remain unaltered through a long series of years. Of some of these parts it can scarcely be said that they are less alive, when removed from the organism to which they belonged, than when included in it. In the heart-wood of a Plant, for example, no vital change takes place, from the time that the woody tubes and cells are once consolidated by internal deposition; it may decay, whilst

still forming part of the stem, without interfering with the nutritive operations of the tree; and if we could possibly remove it entirely, without doing injury by the operation to the rest of the structure, its absence would be productive of no other evil consequences than those which would necessarily result from the withdrawal of the mechanical support afforded by it. The same may be said of the Epidermic Appendages of Animals, and of the External Skeletons of many Invertebrata; which remain equally unchanged from the time of their first formation.—Now as long as these structures hold together, it is evident that the organized part of them must have undergone little change from the condition in which it existed in the living fabric; and that *their* death takes place, in reality, only when the structures decay,—this decay being, in fact, the consequence of it. The law of existence of such cells, therefore, is that of *indefinitely-prolonged* duration; this law must have been impressed upon them from their origin; and the power by which their walls secrete and deposit the consolidating materials, appears to be the chief means of keeping it in operation.

iii. In all the higher forms of Animal structure, the Cells originally composing it are only the means of generating tissues of other kinds, in which the Cellular character is less obvious. Thus the Muscular and Nervous tissues have their origin in cells, which at first appear in no respect different from others, but which subsequently undergo a peculiar metamorphosis, and themselves no longer exist as such. Upon all these primordial cells, therefore, a law of *transformation* is impressed, from the time of their first production. In their original aspect, they cannot be distinguished from the cells which are not destined to undergo any such metamorphosis; but, just as the first cell of the embryo, from which Man is produced, must have some real though not apparent difference from that in which the Polype originates, so must the cell which is afterwards developed into Muscular Fibre, be inherently different from that which is subsequently converted into Nervous tissue.

iv. The tissues, thus formed by the transforming processes to which certain Cells are subject, are evidently governed by the same laws of Nutrition as those which regulate ordinary Cell-growth; these are modified in their action, however, by the conditions in which they are placed, in regard to the activity of the function which the Tissue is called upon to perform. In all instances, however, these Tissues have a *limited* period of existence. They are generated, they grow from the alimentary materials with which they are supplied, they arrive at maturity, they decline, they die, and they decay; just as do the isolated vesicles constituting the humblest forms of vegetation. For all of them there is an appointed duration of life, just as there is for the entire Man.—Now on this view we can explain many physiological phenomena, which cannot otherwise be very satisfactorily accounted for. It is owing to the continual death and decay of its component cells, that the process of decomposition goes on with such constancy and uniformity in the living body; whilst, on the other hand, it is by the continual reproduction of new cells, in the place of those which have disappeared, that the normal organization is maintained. The limited duration of the life of the cells composing the various tissues is further made evident, by the rapid disappearance of the normal organization, and by the loss of the functional power of those tissues, when the cessation of their activity prevents the development of the new cells, by which alone their character can be maintained. Of the change of structure and loss of power which result from disuse and consequent want of nutrition in Muscular and Nervous tissues, instances have already been given (§§ 588 and 790). The ordinary processes of Decomposition and Interstitial Absorption are probably less rapid than usual under such circumstances; so that the length of time required for the disappearance of the characteristic structure, and the

consequent loss of functional power, affords us some idea of the limit to the duration of the life of the tissue. It may be stated, then, as a general proposition, that the interstitial change, which the whole structure of the body is continually undergoing, in its normal or physiological condition, is due to the regularly-occurring death and reproduction of its component cells, of which every one has its own limit of duration. We uniformly find that those Tissues, in which the most active vital changes are going on (such as the Nervous and Muscular), are those in which the duration of the individual component portions is the least; as is shown by the rapidity of the changes of removal and reposition, which are continually taking place in them. The converse holds good also. Further it may be remarked,—and this is a matter of much practical importance,—that anything which increases the functional activity of any particular tissue, thus causing it to live faster, diminishes the duration of its life; as is shown in the increased rapidity of disintegration, which results from the continued exercise of the Muscular and Nervous systems.

v. There is yet another phase, under which Cellular life presents itself as a natural condition in the lower organisms, and in the early condition of the higher; but which constitutes a morbid state in the adult condition of the latter. This is when cells reproduce themselves with extreme rapidity,—neither the primary nor secondary cells undergoing any further transformation,—and the duration of each individual being limited by the development of its progeny within it, causing its own distension and final rupture or disappearance. The growth of the lower Fungi offers a striking example of this in the Vegetable kingdom; and the early processes of development in the Ovum of the highest Animals, exhibit the same character. Every cell, as it is generated, proceeds at once to the work of multiplication, for which it seems specially destined; and thus it is subject from the first to the law of *Reproduction*. It is this which distinguishes the Fungoid diseases; which derive the character designated by the Surgeon as *malignancy*, simply from their tendency to propagation, and his want of power to control it. It seems probable that many other changes of structure are due to a corresponding cause.

812. The duration of the existence of the individual Cells in corresponding parts, is further subject to variation, in accordance with the period of life of the entire organism. Thus all the tissues, even those most consolidated, are undergoing continual changes in the young animal, in which the processes of decay and renewal go on much faster than in the adult; and in the adult, than in the aged person. Even the cells of the Bony structure, which in the adult are almost permanent, and in the aged person are subject to extremely little change, are liable in the infant to an early decomposition; their places being filled up by others, of which the form adapts itself to the growth of the structure. This may be partly accounted for by the imperfect degree, in which, so long as the entire organism is undergoing rapid increase, the normal structure is developed in any one portion of it; for the degree of consolidation being less, the tendency to decay will naturally be greater. But this explanation is not in itself sufficient; and we must be content for the present to regard it as a general law (which may ultimately prove to be but a result of some more general principle) that the duration of the existence of individual cells increases, *cæteris paribus*, with the advance of life. At the same time, their functional activity diminishes. They may be said to live more slowly. The dull perceptions, and slow and feeble movements, of the aged man, form a striking contrast with the acute sensibility, and the rapid and vigorous muscular actions, of the child; and the same change may be noticed in the organic functions. Hence it may be stated as a general law, that the vital activity of

the Cells (and of the tissues produced by their transformation) diminishes in proportion to the prolongation of the general life of the system; and this law exactly corresponds with what has just been observed, as to the comparison of the tissues of different kinds, which are present in the same body.

5.—Of Death, or Cessation of Nutrition.

813. It is a necessary consequence of that intimate mutual dependence of the several operations, which is characteristic of the higher organisms, that the interruption of the function of any one important part is followed by the Death of the whole structure; because it interferes with the elaboration, circulation, or depuration of that nutritive fluid, which supplies the *pabulum* for the growth and reproduction of each portion of the system. But the lives of individual parts may be prolonged for a greater or less duration, after the suspension of the regular series of their combined operations; hence it is that *Molecular Death* is not always an immediate result of *Somatic Death*.—But, on the other hand, if the function of the part have no immediate relation to the indispensable actions just alluded to, it may cease without affecting them; so that *Molecular death* may take place to a considerable extent (as in entire limbs, or in the muscles and integuments of the head and trunk) without *Somatic death* necessarily resulting.

814. The permanent and complete cessation of the Circulating current, is that which essentially constitutes *Somatic Death*; and this may be traced to several distinct causes.—In the *first* place, it may be due to failure in the propulsive power of the Heart, which constitutes *Syncope*; and this may result from a variety of causes, which cannot be here particularized.—*Secondly*, it may be occasioned by an obstruction to the flow of blood through the capillaries of the lungs, constituting *Asphyxia*; and this, as we have seen, may be consequent upon disordered states of the lungs themselves, or upon suspension of the respiratory movements, through affections of the Nervous centres. It is in this mode that most fatal disorders of the Nervous System produce death; except when a sudden and violent impression (as from concussion of the brain, or a blow on the epigastrium) occasions a cessation of the heart's power. Thus in Apoplexy, Narcotic Poisoning, &c., death results from the paralyzed condition of the Medulla Oblongata; whilst in the convulsive diseases, the fatal result ensues upon a spasmodic fixation of the respiratory muscles.—*Thirdly*, *Somatic death* may be occasioned by a disordered condition of the Blood itself, which at the same time weakens the power of the Heart, impairs the activity of the Nervous system, and prevents the performance of those changes in the systemic capillaries, which afford a powerful auxiliary to the circulation. This is *Death by Necræmia*.—*Fourthly*, *Somatic death* may result directly from the agency of Cold, which stagnates *all* the vital operations of the system. Where the cooling is due to the agency of an extremely low external temperature, which acts first upon the superficial parts, there is reason to think that the congestion of the internal vessels thereby induced, occasions a torpid condition of the nervous centres, and that the cessation of the Circulation is immediately due to *Asphyxia*. But when the cooling is gradual, and the loss of heat is nearly equally rapid throughout, it is obvious that the stagnation will be universal, and that no cessation of activity in any one part is the occasion of the stagnation in the functions of the remainder. It is in this manner that death results from Starvation; and not by the weakening of the heart's action, as commonly supposed. The proofs of this will be stated hereafter (§ 896).

815. That *Molecular death* should speedily follow *Somatic death*, is not surprising; when it is borne in mind how constant is the dependence of all

those functional operations, in which vital activity consists, upon the due supply of the circulating fluid. And as a general rule we find, that the more active the changes which normally take place in any tissue during life, the more speedily is its complete loss of activity, or Death, when the requisite conditions of its vital action are no longer supplied to it. We may observe that, in Cold-blooded animals, the supervention of Molecular upon Somatic death is much less speedy than it is in Birds and Mammals. This seems due to two causes. In the first place, the tissues of the former, being at all times possessed of a lower degree of vital activity than those of the latter, are disposed to retain it for a longer time; according to the principle already laid down. And, secondly, as the maintenance of a high temperature is an essential condition of the vital activity of the tissues of warm-blooded animals, the rapid cooling of the body after Somatic death is calculated to extinguish it speedily; and that this cause has a real operation, is evinced by the influence of artificial warmth in sustaining the vital properties of separated parts.—The rapidity with which Molecular death follows the cessation of the general circulation, will be influenced by a variety of causes; but especially by the degree in which the condition of the solids and fluids of the body has been impaired by the mode of death. Thus in *Neeræmia*, and in death by gradual cooling, Molecular and Somatic death may be said to be simultaneous; and the same appears to be true of death by sudden and violent impressions on the Nervous System. But in many cases of death by causes, which suddenly operate in producing *Syncope* or *Asphyxia*, the tissues and blood having been previously in a healthy condition, Molecular death may be long postponed. We cannot be quite certain that it has supervened, until signs of actual decomposition present themselves.

816. When Molecular death takes place in an isolated part, it must result from some condition peculiar to that part, and not primarily affecting the body in general. Thus we may have *Gangrene* or *Mortification* of a limb as a direct result of the application of severe cold, or of an agent capable of producing chemical changes in its substance, or of violent contusions occasioning mechanical injury; or, again, from an interruption to the current of nutritive fluid; or, further, from some ill-understood stagnation of the nutritive process, which manifests itself in the spontaneous death of the tissues without any assignable cause, as in some cases of *Senile Gangrene*. Sometimes we are enabled to trace this stagnation to some disordered condition of the circulating fluid; as in the *Gangrene* resulting from the continued use of the *Ergot* of Rye or Wheat; but we can give no other account of the almost invariable commencement of such gangrene in the extremities, than we can of the selection of *Lead*, introduced into the blood, by the extensors of the fore-arm.—When *Mortification* or *Molecular Death* is once established in any part, it tends to spread, both to contiguous and to distant portions of the body.—Thus we have continually to witness the extension of *Gangrene* of the lower extremities, resulting from severe injury or from the use of the *Ergot*, from the small part first affected, until the whole limb is involved; and this extension is easily accounted for by our knowledge of the tendency of organic substances in the act of decomposition, to produce a similar change in other organic substances subjected to their influence. And the propagation of the *Gangrenous* tendency to other parts, is obviously due to the perversion of the qualities of the Blood, which results from a similar cause. It is not, however, until some organ is affected, whose action is essential to the due maintenance of the *Vegetative* functions, that *Molecular death* becomes a cause of *Somatic death*; and very extensive ravages may thus take place without the extinction of the sufferer's life.

CHAPTER XV.

OF SECRETION.

1.—*Of Secretion in General.*

817. The literal meaning of the term Secretion is *separation*; and this is nearly its true acceptation in Physiology. We have seen that the Nutritive materials, which are received into the living body, are combined in a certain proportion in the circulating fluid; and that they are carried in its current to every part of the structure. Of the elements of the Blood, some are being continually separated from it, to be introduced into the solid textures, of which they become constituents; forming, as it were, the organized frame-work, in the interstices of which various other matters (also separated from the blood) are deposited in an inorganic condition. *This* separation, the object of which is to build up a living fabric, has been already considered under the head of Nutrition; but it may be here remarked, that the deposition of Calcareous matter in the Bones and Teeth, of Chondrine and Gelatine in the Bones and Cartilages, and of Horny matter in the cells of the Epithelium and its appendages (Hair, Nails, Hoofs, &c.), is accomplished by a process analogous in all respects to that concerned in the separation of those other products which are ordinarily considered as Secretions. The same may be said of the Serous fluid, which distends the interspaces of Areolar tissue, the Oily matter contained in the Fat-cells, the Albuminous fluid of the Humours of the Eye, and other analogous constituents of the living fabric.

818. But we have chiefly to consider under the present head, the nature and origin of those products which are continually being cast forth from the living body; the amount of which is usually equal, in the adult animal, to that of the solids and fluids ingested, after allowance has been made for the portion rejected, in the form of *fæces*, as indigestible. The experiments of Dr. Dalton* on his own person, give the following as the proportional quantities discharged through the principal channels of excretion. The mean quantity of solid and liquid Aliment taken into the system daily (during 14 days in spring) being 91 oz., or about $5\frac{3}{4}$ lbs., the average amount of *Fæces* (including part of the solid matter of the bile) was 5 oz.; the average amount of Urine was $48\frac{1}{2}$ oz. daily; and, as the total weight of the body remained the same, the quantity of fluid and solid matter excreted by the Skin and the Lungs must have been $37\frac{1}{2}$ oz. At other periods of the year, a variation was observed; especially in the relative amount of fluid passing off by the Urine, and by Cutaneous exhalation.

819. It can scarcely be questioned, that the chief source of the Excretions is to be found in the continued Decomposition of the various tissues of the body, which has been several times alluded to (§§ 275 and 811); and it is probable, from considerations heretofore adduced, that they are derived, not so much from the fluid returned into the blood by the Lymphatics (as formerly supposed), as from the Blood itself (§ 680). It has been pointed out by Liebig, that there is a remarkable correspondence between the elements of the Blood, and those of the Bile and Urine taken together; so that the Tissues,

* Edinburgh New Philosophical Journal, 1832, 1833.

which are all formed from the nutritive fluid, may be regarded as resolving themselves, by their ultimate decomposition, into these two excretions. Moreover, the Blood, during its circulation, gives up one portion of its constituents in one part of the body—another at a different situation,—and so on. Thus, the elaboration of Gelatine, which is deposited so largely in the solid tissues, must occasion a considerable alteration in the blood: since, in its production from Albumen, a certain residuum must be left (§ 141, *b, c*). This residuum is probably another important source of the products of Excretion. The same may be remarked in regard to the Nutrition of the Nervous System (§ 249). In several other instances, peculiarities of action in different parts will deprive the Blood that passes through them, of its due proportion of certain of its constituents; these are partly restored by its admixture in the Heart, with the Blood that has returned from other parts; but still a general alteration in the character of the Blood is the result of its Circulation; and for this alteration, it is the province of the Excretory function to compensate. A striking illustration may be found, in the change of the colour, and of the proportional amount of free Oxygen and Carbonic Acid, which takes place in the Systemic capillaries, and which is reversed in the passage of the Blood through the Lungs (§ 766).—Moreover it appears that two, at least, of the Excreting organs have for their function to prevent the accumulation, in the Blood, of matters which have been taken in as food, but for which there is no demand in the economy. Thus the *Liver* appears to be the peculiar channel for the elimination of superfluous *non-azotized* matter (§ 833); and the *Kidney* of these *azotized* compounds, which cannot be worked up (so to speak) into tissue (§ 842). Particular sources for the respective contents of other Excretions will be pointed out, when they are considered in detail.

820. A distinction has already been drawn (§ 278) between the proper *Excretions*, the retention of which in the Blood would be positively injurious, and those *Secretions* which are destined for particular purposes within the system, and the cessation of which has no immediate influence on any but the function to which they are destined. This distinction is one of great importance, especially when it is considered with reference to the Chemical Elements, that are found in the two classes of fluids respectively. The solid matter dissolved in those of the latter class, is little else than a portion of the constituents of the Blood, either pure, or but slightly altered; thus, in the Lachrymal fluid, the Saliva, the Pancreatic juice, the Serous fluid of areolar tissue and of serous and synovial membranes, we find little else than Albuminous and Saline matter, derived at once from the blood. The Caseine, which is the most characteristic ingredient of Milk (§ 854 *b*), is but a slightly-altered form of Albumen; and some curious evidence has recently been obtained, that this alteration commences in the Blood, and goes on during pregnancy as a preparation for lactation.* On the other hand, the characteristic ingredients of the Excretions are very different in character from the normal elements of the Blood. They are all of them completely unorganizable; and they possess, for the most part, a simple atomic constitution. Some of them also, have a tendency to assume a crystalline form; which is considered by Dr. Prout to indicate their unfitness to enter into the composition of organized tissues. With regard to some of the chief of these, there is sufficient evidence of their existence, in small quantity, in the circulating Blood; but it is also clear, that they exist there as products of decomposition, and that they are destined to be separated from it as speedily as possible. If their separation be prevented, they accumulate, and communicate to the circulating fluid a positively deleterious character. Of this, we have already seen a striking example in the

* See Dr. G. Bird, in Guy's Hospital Reports, vol. v.

case of Asphyxia (§ 779); and the history of the other two principal Excretions, the Bile and Urine, will furnish evidence to the same effect.—As a general fact, then, it may be stated, that the materials of the Secretions pre-exist in the Blood, in a state nearly resembling that in which they are thrown off by the secreting organs: but that the materials of those secretions, which are only destined to perform some particular function in the economy, are derived from the substances which are appropriated to its general purposes; whilst those of the excretions are the result of the changes that have taken place in the system, and cannot be retained in it without injury.

821. Of the reason why certain compounds forming part of the circulating Blood, are separated from it by one organ, and others by a different one, no other account can be given, than that which refers them to the special endowments of the *cells*, which are the real instruments of the process. When the ultimate structure of Glands is considered, it is found to be neither more nor less than a vascular membrane, covered with epithelium-cells, and made up into various forms for convenience of packing. Of such a membrane, in its most expanded state, that which composes the walls of the Serous cavities, or of the Synovial capsules, affords a good example. Of Mucous membrane (§ 178), the structure is in some instances almost equally simple; but in general the secreting surface is extended, by the inversion of the membrane, into a large number of little open sacs or follicles (Fig. 45), which are lined with epithelium-cells, and copiously supplied with blood-vessels, and which are equally concerned with the external superficies, in the elaboration of the protective secretion that covers these membranes. In the most complex form of gland, we find nothing but a very obvious modification of this structure. Either the sacs are prolonged into cœca or blind tubes, as is the case in the Human Kidney or Testis; or they are very greatly multiplied, and are clustered together (just like currants upon a stalk) upon efferent ducts common to several of them, as is seen in the Parotid. Now, that the particular modification of structure, which the Gland may present, has no essential connection with the character of the Secretion it is destined to form, is evident from this circumstance,—that almost every gland may be found under a variety of forms, in different parts of the Animal series. The Secreting system, like every other, is far simpler in the lower classes of Animals than in the higher; the number of effete compounds, to be excreted from the circulating fluid, is much smaller; and the variety of purposes, for which special secretions are required, is much less. Hence, for almost every Gland, there is a part of the Animal scale below which it does not exist; and when it makes its first appearance, it almost invariably presents a character nearly as simple, as that of the least complex granular structures in the higher animals. Thus the Pancreas in Fishes (Fig. 257), the Mammary Gland in the Ornithorhynchus (Fig. 222), the

Fig. 222.



Mammary Gland of Ornithorhynchus.

Salivary glands in the Echinodermata, and the Urinary organs of Insects, are nothing more than follicles more or less extended, and having separate orifices. Again, in Insects, we find that all the glands,—the Liver and Salivary glands, as well as the Kidneys and Testes,—have the form of prolonged tubes; whilst in Mollusca, all the secreting organs,—the Urinary and Genital, as well as the Biliary and Salivary,—

consist of multiplied vesicles connected with a ramifying duct. Moreover, it is a well-ascertained fact that, even in the highest organisms, the functions of Glandular structures (especially of those concerned in Excretion) are to a

certain degree vicarious with each other; so that, when the secretion from one of them is checked, the system makes an effort to throw off, by another channel, the injurious products that would otherwise accumulate in the Blood. What is the nature of the change in any secreting organ, that causes it thus to take upon itself a new function, is a question upon which we can at present only speculate; we have no more certain knowledge of it, than we have of the cause which occasions their normal actions.

822. It has been recently proved, beyond all reasonable doubt, that in all secreting organs, the Cells which cover the membranous surfaces, and line the follicles and tubes, constitute the really operative part. The simplest condition of a Secreting Cell, in the Animal Body, is that in which it exists in Adipose tissue; every cell of which possesses the power of secreting or separating Fatty matter from the Blood. In this case, the secreted product remains stored up in the cavity of the cell, as it usually does in the Cellular tissue of Plants;—not being poured forth, as it generally is elsewhere, by the subsequent bursting or liquefaction of the cell. But when the Secreting Cells are disposed on the surface of a membrane, instead of being aggregated in a mass, it is obvious that, if they burst or dissolve away, their contents will be poured into the cavity bounded by that membrane; and this is the case in the ordinary Secreting processes. Thus the Mucus, which covers the surface of the Mucous membranes, and which is being continually renewed, is the product of the elaboration performed by the Epithelium-cells, which cover their free surfaces, and line their follicles. These cells are being continually cast off, and replaced by a fresh growth, which has its origin in germs supplied by the subjacent membrane; and thus it is by the act of Cell-growth, that the Secreting process is accomplished. For just as the cells at the extremities of the Intestinal Villi select, from the contents of the alimentary tube, the nutritious portion which is to be introduced into the absorbent vessels,—so do the cells of the Secreting Tubuli or Follicles select from the Blood those effete particles which it is *their* peculiar province to assimilate, and then discharge them into the canals by which they will be carried out of the system.* Hence, as Mr. Goodsir justly remarks, “there are not, as has been hitherto supposed, two vital processes going on at the same time, viz., *growth* and *secretion*; but only one, viz., *growth*. The only difference between this kind of growth, and that which occurs in other organs is, that a portion of the product is, from the anatomical condition of the part, thrown out of the system.”

823. From the study of the changes which take place in the Glandular organs, during their first development and their continued activity, Mr. Goodsir has arrived at the conclusion, that the *follicles* may be considered as *parent-cells*; and that the *secreting cells* in their interior may be regarded as a *second generation*, developed from the nuclei or germinal spots on the walls of the first. Now the successive production and development of the latter, in which the process of secretion essentially consists, may take place on two different plans.

a. In one class of Glands, the parent-cell, having begun to develop new cells in its interior, gives way at one point, and bursts into the excretory duct, so as to become an open follicle, instead of a closed cell; its contained or secondary cells, in the progress of their own growth, draw into themselves the matters to be eliminated from the blood, and, having attained their full term of life, burst or liquefy, so as to discharge their contents into the cavity of the follicle, whence they pass by its open orifice into the excretory duct; and a continual new production of secondary cells takes place from the germinal spot or nucleus at the extremity of the follicle, which is here a permanent structure. In this form of gland, we may frequently observe the secreting cells existing in various stages of development, within a

* We shall hereafter meet with an instance (§ 829) in which, from the position of the cells secreting it, Adipose matter is discharged from the body as an Excretion.

single follicle; their size increasing, and the character of their contents becoming more distinct, in proportion to their distance from the germinal spot (which is at the blind termination of the follicle), and their consequent proximity to the outlet (Fig. 41). In some varieties of such glands, however, especially when the follicles are extended into prolonged tubes, the production of new cells does not take place from a single germinal spot at the extremity of the follicle, but from a number of points scattered through its entire length.

b. In the second type of Glandular structures, the parent-cell does not remain as a permanent follicle; but, having come to maturity, and formed a connection with the excretory duct, it discharges its entire contents into the latter, and then shrivels up and disappears, to be replaced by newly-developed follicles. In each parent-cell of a gland formed upon this type, we shall find all its secondary or secreting cells at nearly the same grade of development; but the several parent-cells, of which the parenchyma of the gland is composed, are in very different stages of growth at any one period—some having discharged their contents, and being in progress of disappearance, whilst others are just arriving at maturity, and connecting themselves with the excretory duct; others exhibiting an earlier degree of development in the secondary cells; others presenting the latter in their incipient condition; whilst others are themselves just starting into existence, and as yet exhibit no traces of the second generation, which they are destined subsequently to develop.

c. The former of these seems to be the usual type of the ordinary glands; the latter is chiefly, if not entirely, to be met with among the Spermatic Glands.*

824. It is important to bear in mind, that an essential difference exists between the *vital* power concerned in the true Secreting process, and the *physical* property which occasions fluid Exhalation or Transudation. This difference is precisely the same as that which exists between the *vital* act of Selective Absorption, and the *physical* operation of Endosmose or Imbibition. By Imbibition and Transudation, certain fluids may pass through organic membranes, in the dead as well as in the living body; and this passage depends merely upon the physical condition of the part, in regard to the amount and the nature of the fluid it contains, and the permeability of its tissues. Not only does water thus transude, but various substances that are held in complete solution in it, especially albumen and saline matter: it is in this manner that the Blood absorbs fluids from the digestive cavity (§ 675), and pours out the serous fluid which occupies the interspaces of the areolar tissue and the serous cavities. The transudation of the watery portion of the blood is much increased by any impediment to its flow through the vessels, as in Congestion and Inflammation; and also by any causes that produce a diminished resistance in their walls.—We shall hereafter see, in examining the Physiology of the Urinary secretion, a very striking example of the contrast between *physical* Transudation and *vital* Secretion (§ 840).

2.—The Liver.—Secretion of Bile.

825. The *Liver* is probably more universally found, throughout the Animal scale, than any other gland. Its form varies so greatly, however, in different tribes, that, without a knowledge of its essential structure, we should be disposed to question whether any identity of character exists amongst the several organs which we include under this designation.

a. In the higher Polypes, for example, we find it to consist of a number of distinct follicles, lodged within the walls of the stomach, and pouring their secretion into its cavity by as many separate orifices; and it is more by the peculiar character of their secretion, than by any other distinction, that these follicles are recognized as Hepatic.—In the lower Articulata, a very similar conformation is met with; but in the higher classes of this series, such as Insects, the follicles are prolonged into tubes of considerable extent. It is very curious to observe, in animals of such complex structure, that a few long tubes, closed at one end, and opening at the other into the alimentary canal, are all which they have to represent a Liver; but the wonder is readily accounted for by keeping in view the extremely active

* See Goodsir's Anatomical and Pathological Researches, Chap. v.

Respiration of these beings, which renders unnecessary any other complex apparatus for elaborating carbon from the system.

b. On the other hand, among the Mollusca, the Liver attains a much greater development. Instead of the follicles being prolonged into tubes (which is the usual form of the glandular system in Insects), they are very much increased in number, and arranged on the sides of canals or efferent ducts, which either separately pour their fluid into the intestine, or partially unite with each other before doing so. The Liver thus acquires a lobulated character, each lobe consisting of a duct with its branching follicles; and the whole organ forms a considerable proportion of the mass of the viscera, and is evidently of great importance in the economy of the animal.—It is interesting to compare this complex structure with the very simple condition presented by the Liver in insects; and, when we keep in view the relative amount of Respiration in the two groups of animals, we are at once struck with the fact, that the development of the Liver bears an inverse proportion to the opportunity afforded by the Respiratory organs for the aeration of the blood; it being peculiarly extended, when these, either from their small size, or from their employment in an aquatic medium, cannot perform their function with great activity. This conclusion is confirmed in an interesting manner by the fact, that the Crustacea, which have the general organization of Insects, but which inhabit the water and breathe by gills instead of by a complex system of air-tubes,

Fig. 223.

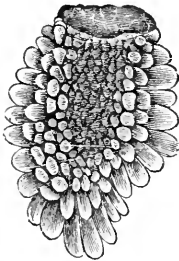

Lobule of Liver of Squilla Mantis; exterior.

Fig. 224.



Lobule of Liver of Squilla Mantis cut open.

possess a Liver corresponding in form and in degree of development with that of the Mollusca.

c. In the Vertebrated Sub-kingdom, we may trace the operation of the same principle; but the internal structure of the Liver, in the adult condition at least, is less easily demonstrated, than it is in the lower classes; owing to its increased complexity of structure, and the closer union between its different parts. In Fishes and Reptiles, the Liver is of considerable size, and seems to perform a very important part in the decarbonization of the blood; its form is adapted to that of the cavity in which it is lodged, sometimes one lobe only being developed. In Birds, on the other hand, whose respiration is so much more active, it is much smaller, but is placed on the median line, in conformity with the general symmetry of their internal as well as external organs (§ 40). In Mammalia, also, it is comparatively small; but, though reduced in proportional size, it is at the same time much more compact and firm than in the lower Vertebrata.

d. The Liver of Man is much less developed than that of many other Mammalia; and presents, as rudimentary indications, certain organs which are elsewhere fully developed. The whole mass, which we are accustomed to describe as consisting of a *right* and *left* lobe, does in reality form but one (there being no real division between its two portions), which must be regarded as the *Central* lobe; the *Lobulus Spigelii* is the rudiment of a second or *right* lobe, and the *Lobulus Caudatus* is a Lobule developed from it. In the Carnivora and Rodentia, which present the most complex form of Liver that we meet with among Mammalia, there are five distinct parts;—a central or principal lobe, corresponding with the principal part of the liver of Man; a right lateral lobe with a lobular appendage, corresponding to the *Lobulus Spigelii* and *Lobulus Caudatus*; and a similar lobe and lobule on the left side.

e. The Gall-bladder is an appendage to the Liver, of which we find no traces in the Invertebrata. It may be regarded as simply a dilatation of the efferent duct, more or less prolonged from it, adapted to store up the hepatic-secretion against the time when it may be required. In Fishes it frequently, but by no means constantly, presents itself; in Reptiles, on the other hand, it invariably exists. In Birds it is occasionally absent, even in species

[Fig. 225.

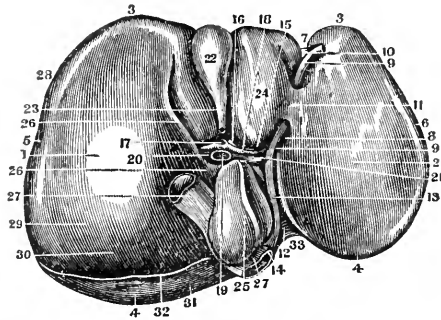

The inferior or concave surface of the Liver, showing its subdivisions into lobes; 1, centre of the right lobe; 2, centre of the left lobe; 3, its anterior, inferior or thin margin; 4, its posterior, thick or diaphragmatic portion; 5, the right extremity; 6, the left extremity; 7, the notch in the anterior margin; 8, the umbilical or longitudinal fissure; 9, the round ligament or remains of the umbilical vein; 10, the portion of the suspensory ligament in connection with the round ligament; 11, pons hepatis, or band of liver across the umbilical fissure; 12, posterior end of longitudinal fissure; 13, 14, attachment of the obliterated ductus venosus to the ascending vena cava; 15, transverse fissure; 16, section of the hepatic duct; 17, hepatic artery; 18, its branches; 19, vena portarum; 20, its sinus, or division into right and left branches; 21, fibrous remains of the ductus venosus; 22, gall-bladder; 23, its neck; 24, lobulus quartus; 25, lobulus spigelii; 26, lobulus caudatus; 27, inferior vena cava; 28, curvature of liver to fit the ascending colon; 29, depression to fit the right kidney; 30, upper portion of its right concave surface over the renal capsule; 31, portion of liver uncovered by the peritoneum; 32, inferior edge of the coronary ligament in the liver; 33, depression made by the vertebral column.]

closely allied to others that possess it, and without any marked difference in the food, habits, &c. of the two. In Mammalia, again, it is frequently absent, especially among herbivorous animals; sometimes, on the other hand, two are present, a second or accessory gall-bladder

[Fig. 226.

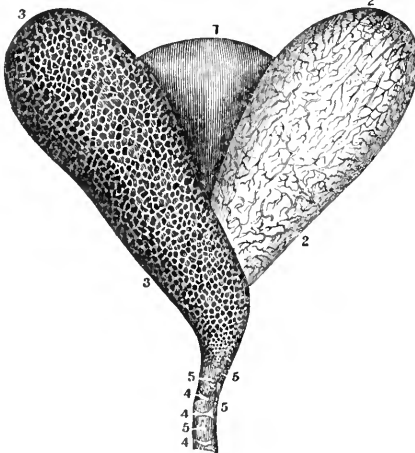

Shows the three coats of the Gall-Bladder separated from each other; 1, the external or peritoneal coat; 2, the cellular coat with its vessels injected; 3, the mucous coat covered with wrinkles; 4, 4, valves formed by this coat in the neck of the gall-bladder; 5, 5, orifices of the mucous follicles at this point.]

being formed upon the Ductus communis choledochus, which elsewhere not unfrequently presents a dilatation in the same situation. In the first Giraffe dissected by Mr. Owen, no gall-bladder was found; in the second there were two.

f. In the Human species the gall-bladder is rarely absent, except in cases of malformation depending upon general arrest of development, in which several organs are involved. The Excretory Ducts of the Liver and Gall-bladder have three coats,—an internal or *mucous*, a middle or *fibrous*, and an external or *areolar*. The internal coat is continuous with the Mucous membrane of the intestinal tube, into which it opens; and the whole glandular structure may indeed be considered as a complex prolongation of this, copiously supplied with blood-vessels, and packed into the smallest possible compass. The middle or fibrous coat bears a considerable resemblance in aspect to that of the Arteries; in its properties, however, it is still more nearly allied to true muscle, being capable of exhibiting contraction on the application of

stimuli to the Sympathetic nerves supplying it; and in some instances of obstruction, it has presented an appearance very closely resembling that of the muscular coat of the alimentary canal.* Dr. Davy has pointed out, that the mucous coat of the Ductus communis is disposed in valve-like folds; in such a manner, as to prevent the reflux of the bile, or of the contents of the intestine.

826. The Liver may be regarded as essentially consisting of a mass of cells, in connection with the ramifications of the Hepatic Duct; and these are in close relation with the ramifications of the Portal Vein and Hepatic Artery, that serve to convey blood to the minutest parts of this organ; and with those of the Hepatic Vein, which return it to the heart, after it has been subservient to the Nutrition of the structure and to the elaboration of the Secretion. Besides these, the Liver contains Lymphatics and Nerves; the latter are chiefly derived from the Sympathetic system, and are distributed on the walls of the vessels and ducts. These various portions of the structure are connected together by a fibrous tissue, to which the name of Glisson's Capsule has been given. For our present knowledge of their ultimate arrangement, we are almost entirely indebted to Mr. Kiernan,† whose account of them will be here followed,—his researches having been confirmed, in all essential particulars, by other Anatomists.

a. When a Liver is closely examined with the naked eye, it is seen to be made up of a great number of small granular bodies, about the size of a millet seed, of an irregular form, and presenting a number of rounded projecting processes upon their surfaces. These are commonly termed *lobules*, although by some Anatomists they are spoken of as *acini*. When divided longitudinally, they have a somewhat foliated appearance (Fig. 229), arising from the distribution of the Hepatic Vein; which, passing into the centre of each division, is termed the *intra-lobular vein*. The exterior of each Lobule is covered by a process of the capsule of Glisson; which is very dense in the Pig and other animals; but which is so thin as to be almost undistinguishable in the Human liver. Its substance is composed of the minute ramifications of the before-mentioned vessels, arranged in the manner presently to be described; the spaces between which are filled up with a parenchyma, composed of nucleated cells, like those shown in Fig. 232. The structure of each lobule, then, gives us the essential characters of the whole gland.

b. The Lobules, when transversely divided, are usually found to present somewhat of a pentagonal or a hexagonal shape; the angles being generally somewhat rounded, so as to form a series of passages, or *inter-lobular spaces*: in these lie the branches of the Vena Porte, and of the Hepatic Artery and Duct, from which are derived the plexuses that compose the lobules. Each Lobule, when examined with the microscope, is found to be apparently composed of numerous minute bodies of yellowish colour, and of various forms, connected together by vessels; to these the name of *acini* was given by Malpighi; and to these, if they deserve a name, it ought to be restricted. They will be presently shown, however, to be nothing else than the irregular islets, left between the meshes of the plexus formed by the ultimate ramifications of the Portal Vein. The Vena Porte, it will be recollected, is formed

[Fig. 227.]

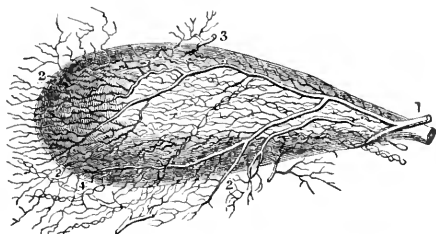

A view of the Gall-Bladder distended with air, and with its vessels injected; 1, cystic artery; 2, the branches of it which supply the peritoneal coat of the liver; 3, the branch of the hepatic artery which goes to the gall-bladder; 4, the lymphatics of the gall-bladder.]

[Fig. 228.]



1, Nucleated cells composing the parenchyma of the gland; 2, lobules of human liver with ramifications of the hepatic vein.]

* In the Horse and Dog this coat is clearly muscular.

† Philosophical Transactions, 1833.

by the convergence of the veins, which return the blood from the chylopoietic viscera; and there is reason to believe that it also receives the blood, which is conveyed to the Liver for

Fig. 229.

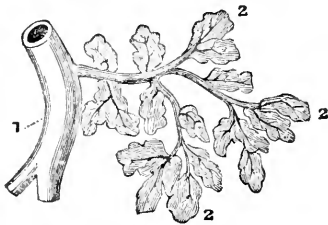

Connection of the lobules of the liver with the hepatic vein; 1, a trunk of the vein; 2, 2, lobules depending from its branches, like leaves on a tree; the centre of each being occupied by a venous twig,—the Intra-lobular Vein.

Fig. 230.

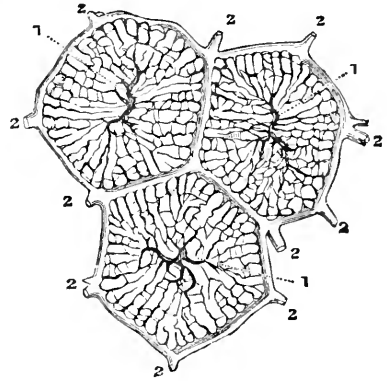

Horizontal section of three superficial lobules, showing the two principal systems of Blood-Vessels; 1, 1, *intra*-lobular veins, proceeding from the Hepatic veins; 2, 2, *inter*-lobular plexus, formed by branches of the Portal veins.

the purposes of Nutrition, by the Hepatic Artery. As it is an afferent, not an efferent vessel, it has a strong claim to the character of an Artery; even although it conveys Venous blood. Like an artery, it gradually subdivides into smaller and yet smaller branches; and at last forms a plexus of vessels, which lie in the inter-lobular spaces, and spread with the freest inosculation, throughout the entire Liver. To these vessels, the name of *inter*-lobular Veins is given by Mr. Kiernan. They ramify in the capsules of the lobules, covering with their ramifications the whole external surface of these; and then enter their substance. When they enter the Lobules, they are termed *lobular* veins; and the plexus formed by their convergence, from the circumference of each lobule towards its centre (where their ultimate ramifications terminate in those of the intra-lobular or hepatic vein), is designated as the *Lobular Venous plexus*. In the islets of this plexus (the acini of Malpighi) the ramifications of the hepatic duct are distributed in the manner next to be described.

c. The Hepatic duct forms, by its subdivision and ramification, an Interlobular plexus of a very similar character; but the anastomosis between the branches going to the different lobules

Fig. 231.

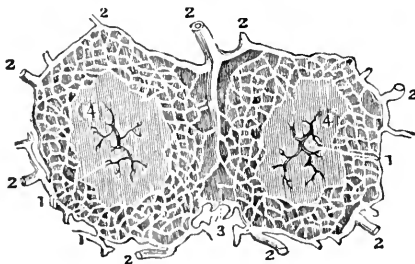

Horizontal section of two superficial Lobules, showing the interlobular plexus of biliary ducts; 1, 1, intra-lobular veins; 2, 2, trunks of biliary ducts, proceeding from the plexus which traverses the lobules; 3, interlobular tissue; 4, parenchyma of the lobules.

is less intimate than that of the interlobular veins, and cannot be directly demonstrated; although Mr. Kiernan thinks that his experiments leave but little doubt of its existence,—a communication (which cannot be seen to be established by any nearer channel) being proved to exist between the right and left primary subdivisions of the duct. The Interlobular Ducts ramify upon the capsular surface of the lobules, with the branches of the Portal Vein and Hepatic Artery; they then enter its substance, and subdivide into minute branches, which anastomose with each other, and form a reticulated plexus, termed by Mr. K., the *Lobular Biliary plexus*. This plexus constitutes the principal part of the substance of the lobule; and when seen through the meshes of the Portal plexus, gives rise to the ap-

pearance of cœcal terminations of ducts. The ultimate terminations of these ducts have not, however, been traced in the adult Liver of any of the higher animals, although they are sufficiently evident in the embryonic condition. From the analogy of other organs, there would seem good reason to believe, that the ultimate ramifications of the hepatic ducts anastomose freely together, and that they form a network, in which their terminations are lost, as it were, without forming true cœca. This view of the matter finds confirmation in the curious fact pointed out by Mr. Kiernan, that, in the *left lateral ligament*, the essential parts of a lobe are found in the simplest form and arrangement. From the edge of the liver next to the ligament, numerous Ducts emerge, which ramify between the two layers of peritoneum of which the ligament is composed. They are accompanied by branches of the Portal and Hepatic Veins, and of the Hepatic Artery; which also ramify in this ligament, especially around the parietes of the ducts. These Ducts, of which some are occasionally of considerable size, divide, subdivide, and anastomose with each other; and the meshes formed by the network of larger or excreting Ducts, are occupied by minute plexuses of their ultimate ramifications or secreting Ducts.

d. The Hepatic Artery sends branches to every part of the Liver, supplying the walls of the Portal and Hepatic Veins, and of the Hepatic Ducts, as well as Glisson's capsule. The principal distribution of its branches, however, is to the Lobules, which they reach, in the same manner with the Portal vessels and Biliary Ducts, by spreading themselves through the interlobular spaces. There they ramify upon the interlobular ducts, and upon the capsular surface of the lobules, which they then penetrate; their minuteness prevents their distribution within the lobules from being clearly demonstrable; but, as they enter along with the biliary ducts, there can be little doubt that, here as elsewhere, they are principally distributed upon the walls of these. As to the ultimate termination of the capillaries of the Hepatic Artery,—whether they enter the Portal plexus, or the Hepatic Vein,—there is a difference of opinion amongst anatomists; the former view being upheld by Kiernan, the latter by Müller. The question is a very interesting one in a physiological point of view; since, if the former account be the true one, the Blood which is brought to the Liver by the Hepatic Artery becomes subservient to the secretion of Bile, only by passing into the Portal plexus; whilst, if the latter be the correct statement, either the arterial Blood is not at all subservient to the formation of Bile, or the secretion can be elaborated from the arterial capillaries. The experiments of Mr. Kiernan have satisfactorily proved, that the Intralobular or Hepatic Veins cannot be filled by injection from the Hepatic Artery, though they may be readily filled from the Portal plexus; whilst, on the other hand, there is reason to believe, that a very fine injection into the Hepatic arteries, will find its way into the Portal plexus.* It is certain that all the branches of the Hepatic artery, of which the termination *can* be ascertained, end in the Vena Portæ; a free capillary communication existing between their two systems of branches, on the walls of the larger blood-vessels and ducts. According to Müller, there is an ultimate plexus of capillary vessels, with which all the three systems freely communicate; but for this idea there is no adequate foundation; and it is inconsistent with the fact just stated, that injection into the Hepatic Artery does not return by the Hepatic vein. And the views of Mr. Kiernan have lately received important confirmation from the researches of Mr. Bowman on the circulation in the Kidney (§ 841).

e. It now only remains to describe the Hepatic Veins, the branches of which occupy the interior of the Lobules, and are termed *intra-lobular veins* (1, 1, Figs. 230 and 231). On making a transverse section of a lobule, it is seen that the central vessel is formed by the convergence of from four to six or eight minute venules, which arise from the processes upon the surface of the lobule. In the superficial lobules, (by which term are designated those lobules which lie upon the exterior of the glandular substance, not only upon the surface of the Liver, but also against the walls of the larger vessels, ducts, &c.) the Intralobular Veins commence directly from their surface; and the minute venules of which each is composed may be seen in an ordinary injection, converging from the circumference towards the centre, as in the transverse section of other lobules. The Intralobular Veins terminate in the larger trunks, which pass along the bases of the lobules, collecting from them their venous blood; these are called by Mr. Kiernan *sublobular veins*. The main trunk of the Hepatic Vein terminates in the ascending Vena Cava.

f. In regard to the mode in which the nucleated Cells, that are the real agents in the Secreting process, are arranged in the Liver of Man and the higher animals, there is much uncertainty; owing especially to our want of acquaintance with the mode in which the Hepatic Ducts terminate. They would seem to form the greatest part of the Parenchyma, which fills up the interstices between the reticulations of the Blood-vessels and Ducts; but it is obvious, from their functional operation, that they must have a more

* This is stated to have been the case in the injections of Lieberkühn, although Mr. Kiernan has not succeeded in effecting it.

Fig. 232.

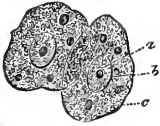

Glandular cells of Liver; *a*, nucleus; *b*, nucleolus (?); *c*, adipose particles.

close relation to the latter than to the former. Their diameter is usually from 1-1500th to 1-2000th of an inch; and they are consequently easily recognized, whenever a portion of the substance of the Liver is torn up and examined with the higher powers of the Microscope. Their shape is usually spheroidal. They have a distinct biliary tinge; and contain a granular amorphous matter, with a few small adipose globules.

g. In regard to the Embryonic Development of the Human Liver, a considerable part of our information must necessarily be derived from the study of that of other animals; and this not so much from Mammalia, as from Birds; since the development of this organ commences so early in the former, its phases are so rapidly hurried through, and its evolution is so soon completed, that the process cannot be continuously watched.—In the Chick, the rudiments of the Liver are found at the commencement

Fig. 233.

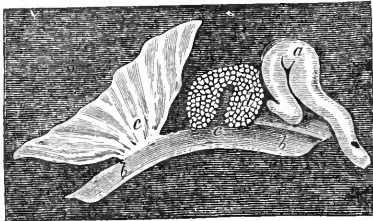

Origin of the Liver from the intestinal wall, in the embryo of the Fowl, on the fourth day of incubation:—*a*, heart; *b*, intestines; *c*, everted portion giving origin to the liver; *d*, liver; *e*, portion of yolk-bag.

about the third week of intra-uterine existence; the organ is from the first of very large size, when compared with that of the body; and between the third and the fifth week, it is one-half the weight of the entire embryo. It is at that period divided into several lobes. By the third lunar month, the liver extends nearly to the pelvis, and almost fills the abdomen; the right side now begins to gain upon the left; the gall-bladder begins to appear at this time. The subsequent changes chiefly consist in the consolidation of the viscera, and the diminution of its proportional size. Up to the period of birth, however, the bulk of the Liver, relatively to that of the entire body, is much greater than in the adult; the proportion being as 1 to 18 or 20 in the new-born child, whilst it is about 1 to 36 in the adult; and the difference between the right and left sides is still inconsiderable. During the first year of extra-uterine life, however, a great change takes place; the right lobe increases a little or remains stationary, whilst the left lobe undergoes an absolute diminution, being reduced nearly one-half; and as, during the same period, the bulk of the rest of the body has been rapidly increasing, the proportion is much more reduced during that period, than in any subsequent one of the same length. According to Meckel, the liver of the newly-born infant weighs one-fourth heavier than that of a child of eight or ten months old; and as the weight of the whole body is more than doubled, during the same time, it is obvious that the change in the proportion of the two must be principally effected at this epoch.

827. The knowledge of the distribution of the Biliary ducts, and of the two chief systems of Blood-vessels, in the Lobules of the Liver, has enabled Mr. Kiernan to give a most satisfactory explanation of appearances, by which Pathological anatomists had been previously much perplexed. When the Liver is in a state of Anæmia (which rarely happens as a natural condition, although it may be induced by bleeding an animal to death), the whole substance of the lobules is pale, as represented in Fig. 234. In general, however, the Liver is more or less congested at the moment of death; and this congestion may manifest itself in several ways. The whole substance may be congested; in which case the lobules present a nearly uniform dark colour throughout their substance, their centres being usually more deeply-coloured

Fig. 234.

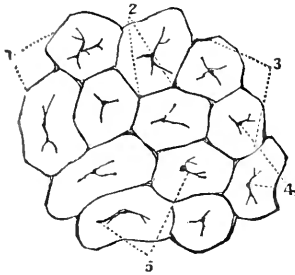

1, angular lobules in a state of Anæmia, as they appear on the external surface of the liver; 2, interlobular spaces; 3, interlobular fissures; 4, interlobular veins, occupying the centres of the lobules; 5, smaller veins, terminating in the central veins.

Fig. 235.

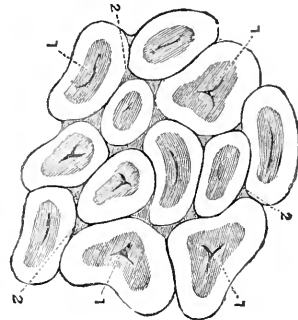

1, rounded lobules in *first* stage of Hepatic Venous congestion, as they appear on the surface of the liver; 2, interlobular spaces and fissures.

than the margins. An appearance more frequently offered after death, however, is that represented at Fig. 235, and termed by Mr. Kiernan the *first* stage of *Hepatic Venous* congestion. In this, the isolated centres of the Lobules alone present the colour of sanguineous congestion; and the surrounding substance varies from a yellowish-white, yellow, or greenish colour, according to the quantity and quality of the Bile which it contains. This accumulation of the blood in the Hepatic Veins, and the emptiness of the Portal plexus, seem due to the continuance of capillary action after the general circulation has ceased; —a circumstance to which we find an exact parallel, in the emptiness of the systemic arteries, and the fulness of the veins, after most kinds of death. In the *second* stage of Hepatic Venous congestion, the accumulation of blood is found not only in the Intralobular Veins, but even in parts of the Portal or Lobular Venous plexus. The parts which are freest from it are those sur-

Fig. 236.

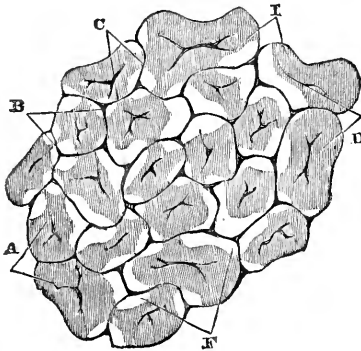

A, lobules in the *second* stage of Hepatic Venous congestion; B, and C, interlobular spaces; D, congested intralobular veins; E, congested patches, extending to the circumference of the lobules; F, non-congested portions of lobules.

Fig. 237.

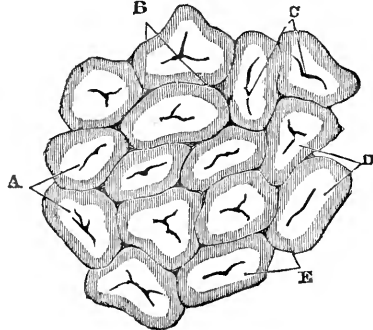

A, lobules as they appear on the surface in a state of Portal Venous congestion; B, interlobular spaces and fissures; C, intralobular hepatic veins, containing no blood; D, the central portions in a state of anæmia; E, the marginal portions in a congested state.

rounding the interlobular spaces; so that the non-congested substance here appears in the form of circular or irregular patches, in the midst of which the spaces and fissures are seen (Fig. 236).^{*} Although the Portal as well as the Hepatic venous system is thus involved in this form of congestion, yet, as the obstruction evidently originates in the latter, the term given by Mr. Kiernan is still applicable; and it is important to distinguish this appearance from that next to be described. The second stage of Hepatic venous congestion very commonly attends disease of the heart, and other disorders in which there is an impediment to the venous circulation; and in combination with accumulation in the biliary ducts, it gives rise to those various appearances, which are known under the name of dram-drinkers' or nutmeg liver. The other form of partial congestion arises from an accumulation of blood in the Portal veins, with a reverse condition of the Hepatic or intralobular veins; in this condition, which Mr. K. designates as *portal venous congestion*, the marginal portions of the lobules are of deeper colour than usual, and form a continuous network, the isolated spaces between which are occupied by the non-congested portions (Fig. 237). This is a very rare occurrence; having been seen by Mr. K. in children only.—These differences fully explain the diversity of the statements of different anatomists, as to the relative position of the so-called *red* and *yellow* substances; for it now appears, that the *red* substance is the *congested* portion of the lobules, which may be either interior or exterior, or irregularly disposed; whilst the *yellow* is the *non-congested* part, in which the Biliary plexus shows itself more or less distinctly.

828. Another very interesting form of Pathological change in the aspect of the Liver, which the knowledge of the structure of the Lobules enables us to comprehend, is that to which the name of *Cirrhosis* has been given. This has been erroneously attributed to the presence of a new deposit, analogous to that of Tubercular matter; but it is really due to Atrophy and partial Congestion in the Liver itself. It is described by Laennec as usually presenting itself in small masses, varying in size from a cherry-stone to a millet-seed, and scattered through the substance of the Liver. When these are minute, and closely set, they impart what appears at first to be a uniform brownish-yellow tint to the divided surface of the Liver; but when the tissue is more attentively examined, their separation becomes evident. These small masses are not distinct lobules in a variable state of hypertrophy (as supposed by Cruveilhier); but small uncongested patches, composed of parts of several adjoining lobules, and having one or more interlobular spaces for a centre; and the biliary plexuses of these, being filled with bile, give them their yellow colour. On the other hand, there is an atrophy, more or less complete, of the portions of the substance of the liver intervening between them; so that the bulk of the whole organ is much diminished, very commonly to one-half, and sometimes to one-third, of its original size.

829. The application of the Microscope to the Hepatic Cells, in various states of disease, has afforded many facts of great interest. The *fatty liver*, which is often found in the bodies of persons who have died from diseases obstructing the pulmonary circulation, has been shown by Mr. Bowman† to depend upon the presence of a large quantity of fatty matter in the interior of the cells; which frequently appear as if gorged with it. This would seem to be occasioned by the want of elimination of the fatty matter through the respiratory process; and the consequent accumulation of it in the Blood, by

* This very common aspect of the Liver, which presents numerous modifications, has been a source of great perplexity to those who have studied the minute anatomy of this organ, and has even led Anatomists of the highest eminence into serious errors. See Cyclop. of Anat. and Physiol., vol. iii. pp. 185, 186.

† Medical Gazette, January 1842.

which the burden of separating it is thrown upon the Liver.—Dr. Williams* mentions, that, in a case of obstruction of the ductus choledochus by malignant disease,—which occasioned complete interruption to the passage of bile, and consequent jaundice,—scarcely an entire nucleated cell could be discovered by attentive examination of a large part of the organ. Nothing more than minute free particles of fat, and free floating amorphous granular matter, could be detected. He further states that, in a case of fever, the hepatic cells were found to be almost entirely destitute of fatty particles; and that in what is known as “granular liver,” the granules (which have much the appearance of tubercles) consist of cells, which strongly resemble the ordinary cells of the parenchyma of the Liver in every respect, except that they are almost or completely destitute of yellow contents. Similar observations have been also recorded by Dr. G. Budd.—In two cases of jaundice examined by Mr. Gulliver, the hepatic cells were gorged with biliary matter; some of them to such an extent, that they had become nearly opaque. Perhaps if this condition had continued, these cells would have been all ruptured, and the state of the organ would have resembled that described by Dr. Williams.

830. Previously to birth, the Liver is the only decarbonizing organ in the system, the Lungs being at that time inert; but as soon as the latter come into play, they separate from the Venous blood a large proportion of the carbon with which it is charged, and less blood is transmitted to the Liver for this purpose. The diminution in the quantity of the Blood circulating through this organ, is extremely rapid; and it is usually very evident within a short time after birth, in the comparative paleness of the substance of the gland. It has been proposed to give this fact a practical bearing, in those judicial inquiries which are directed to the determination of the question, whether or not an Infant has respired after birth; it having been conceived, that the diversion of the current of the Blood from the Liver to the Lungs, consequent upon the first inspiration, would be sufficient to make a certain difference in their relative weights, if that inspiration had taken place. More careful and extended observations, however, have satisfactorily proved that, although an increase in the weight of the Lungs, and a diminution of that of the Liver, are generally found to exist after respiration has been fully established, they are not by any means constantly produced when the inspirations have been feeble, as they frequently are for some hours or days after birth; whilst, on the other hand, it is not uncommon to meet, in infants that have not breathed, with Lungs as heavy, and Livers as light, as in the average of those which have respired.†

831. We have now to consider the conditions, under which the secretion of Bile takes place; and one of the most important of these, is the character of the Blood with which the organ is supplied. We have seen that there is anatomical reason for the belief, that the blood supplied by the Hepatic Artery is not directly concerned in the Secretion; but that it first serves for the Nutrition of the organ, and then, passing into the Portal system (in the same manner as does the blood of the mesenteric and other arteries), forms part of the mass of Venous Blood, from which the secreting cells elaborate their product. This view is borne out by the results of Experiment, and of Pathological observation. Thus, if the Vena Portæ be tied, the secretion of bile still continues, though in diminished quantity; and several cases are on record, in which, through a malformation, the Vena Portæ terminated in the Vena Cava

Fig. 238.



Hepatic Cells gorged with Fat: a, atrophied nucleus; b, adipose globules.

* Guy's Hospital Reports, 1843.

† See Dr. Guy, in Edinb. Med. and Surg. Journal, vols. lvi. and lvii.

without ramifying through the liver, and in which secretion of Bile took place,—evidently from the blood of the Hepatic Artery, which had become venous by circulating through the substance of the Liver; and this blood appears* to have passed into the ramifications of the Umbilical Vein, which formed a plexus in the lobules, exactly resembling the ordinary portal plexus. It must be remembered, however, that in all these instances, the *arterial* Blood will become abnormally charged with the elements of Bile; since the blood of the chylipoietic viscera, from which it ought to have been separated, returns to the heart without undergoing any such purification: and the secretion of Bile from the blood supplied by the Hepatic Artery under such circumstances cannot, therefore, be considered as proving that the arterial blood is ordinarily concerned in the secretion to the same degree.

832. That the proximate elements of the Bile accumulate in the Blood, when from any cause the secretion is suspended, is a fact now well ascertained; and this satisfactorily accounts for the disturbance of the other functions, especially those of the Nervous system, which then ensues. When the suppression is complete, the patient suddenly becomes jaundiced, the powers of that system are speedily lowered (almost as by a narcotic poison), and death rapidly supervenes.† When the secretion is diminished, but not suspended, the same symptoms present themselves in a less aggravated form. It is probable that much of the disorder in the functions of the Brain, which so constantly accompanies deranged action of the Digestive system, is due to the less severe operation of the same cause,—the partial retention within the Blood, of certain constituents of the Bile, which should have been eliminated from the circulating fluid. In such a condition, we derive great benefit from the use of mercurial medicines; which, by stimulating the Liver to increased action, cause the removal of the morbid agent from the blood. Deficient secretion of the Liver may be recognized as the cause of this and of other diseases, by the paleness of the alvine evacuations, the diffused yellowness of the surface of the body, the yellowish-brown fur upon the tongue, and the congestion of the portal system; this last results from the same cause, as that which stagnates the blood in the Lungs when there is deficient Respiration (§ 738), and frequently occasions Ascites, and other disorders of the contents of the abdomen. An abnormal accumulation of the elements of the Bile in the Blood, is habitual in some persons; and it produces a degree of indisposition to bodily or mental exertion, which it is difficult to counteract. It may often be recognized by the accumulation of dark mucus having distinctly the taste of bile, on the surface of the tongue, especially during the night; this secretion being apparently eliminated by the mucous membrane of the tongue, when the function of the liver is not duly performed.

833. Much discussion has taken place among Chemists, in regard to the proximate principles of the Biliary secretion; a large number of analyses having been made, amongst the results of which there is great want of conformity. The discrepancies principally arise from this source,—that the secretion is acted on with great facility by chemical reagents; so that many of the component parts which have been enumerated, are not true *educts*; but are *products* of the operations, to which the fluid has been subjected. The proportion of solid matter is usually from 9 to 12 per cent.; and nearly the whole of this consists of substances peculiar to Bile.

a. The following are the general results of the analyses made by Berzelius, of Human Bile, and of that of the Ox:—

* This, at least, was found to be the case, in the only instance in which the liver was examined with sufficient care.

† See Dr. Alison in Edinburgh Medical and Surgical Journal, vol. xlv. p. 287.

	MAN.	OX.
Water	90.44	92.84
Biliary matter	8.00	5.00
Mucus30	.23
Alkali (in combination with fatty acids)41	
Chloride of sodium, and extractive74	1.50
Phosphates and sulphates of soda and lime11	.43
	<hr/>	<hr/>
	100.00	100.00

In the Biliary matter, we are to distinguish at least three distinct substances; Cholesterine, Bilic acid, and Colouring matter.—In healthy bile, the proportion of *Cholesterine* appears to be very small; but in many disordered states of the secretion, and especially in disease of the Gall-bladder, this substance is present in much larger amount; and it usually forms the principal, if not the sole, ingredient in biliary concretions. It is a white crystallizable fatty matter, somewhat resembling Spermaceti; free from taste and odour; not soluble in water, but dissolving freely in alcohol, from which it is deposited on cooling in pearly scales. It is almost entirely composed of Carbon and Hydrogen; its constitution being 36 Carbon, 32 Hydrogen, 1 Oxygen. It may be obtained by a chemical process of no great complexity, from the Serum of the Blood; and it is not unfrequently deposited as a result of diseased action in other parts of the body, especially in the fluids of local Dropsies, as hydrocele, ovarian dropsy, &c.

b. The principal constituent of Bile is a compound of soda with a peculiar organic body; which is now generally regarded in the light of a fatty acid, and named *Bilic acid*. According to Platner, this bilic acid and the bililate of soda may be obtained in a pure crystalline state from fresh bile; a yellowish-brown syrup being left, which seems principally to consist of colouring matter diffused through the water. No analysis has yet been made of bilic acid thus purified; that of Dr. Kemp, made upon an impure bilic acid, gives as its ultimate composition 48 Carbon, 42 Hydrogen, 13 Oxygen, and 1 Nitrogen. This is the substance described by different Chemists (doubtless under various modifications, according to the process used to obtain it), as Choleic acid, Bilin, Pieromel, &c. It is very readily altered by reagents, especially by acids; and a great variety of products may be formed by its decomposition. Some of these appear to present themselves in the living body, as results of disordered conditions of the secreting process.

c. The colouring matter of the bile is now termed *Biliverdin*. That of the Ox contains no azote; and appears to be identical with the Chlorophyl of plants. That of Man, however, contains about 7 per cent. of Azote, with 68 parts of Carbon, $7\frac{1}{2}$ of Hydrogen, and $17\frac{1}{2}$ of Oxygen; and it cannot be derived so directly from the food. When exposed to the air, it becomes of a deep green absorbing oxygen; and the same change is produced by nitric acid,—the liquor soon passing, however, to a red hue. This frequently takes place within the body, in cases of Jaundice; but more especially in the urine. Though the colouring matter is usually present but in small quantity during health, it sometimes accumulates in disease, so as to produce solid masses, which include little else.

834. The amount of the secretion of Bile appears to bear some proportion to that of the Food digested. That its formation is continually going on to a certain degree appears unquestionable; but that its quantity is greatly increased during the solution of food in the stomach, appears also to be well established. In those animals which are most constantly ingesting food, we find no Gall-bladder: for in them, the Bile may be poured into the Intestine as fast as it is formed. In those which only take food occasionally, on the other hand, and which are provided with a Gall-bladder, the Bile, when not required in the Intestine, flows back into that reservoir. This reflex would appear due to the valve-like termination of the Ductus Choledochus in the walls of the Intestine; by which a certain resistance is offered to the entrance of the fluid, unless it be propelled by some decided force. The flow of Bile into the Intestinal tube, when its action is needed there, is commonly imputed to the pressure of the distended Duodenum against the Gall-bladder; it may be doubted, however, whether the contractile power of the Duct itself does not afford important aid in the process; and it is easy to understand, from the known influence of the Sympathetic system of nerves upon it (§ 825, *f*), that peristaltic movements may be thus excited at the time when they are needed.—It is an interesting fact, proving how completely the passage of Bile into the Intestine is depend-

ent upon the presence of aliment in the latter, that the Gall-bladder is almost invariably found turgid in persons who have died of starvation; the secretion formed at the ordinary slow rate having gradually accumulated, for want of demand. This fact is important in juridical inquiries.

835. The Bile, as already shown (§ 660), has an important operation to effect in the Digestive process;—that of reducing the oily matter of the food to a state in which it may be taken up by the Absorbent vessels. This it effects by means of its *soapy* character; which, notwithstanding the doubts of Chemists, seems to be proved by familiar facts. Thus, Ox-Gall is commonly employed to remove grease spots; and the bile of the Sea-Wolf (*Anarhicas lupus*) is ordinarily used as soap by the Icelanders. Moreover, the small quantity of Cholesterine contained in healthy Bile, is certainly in a state of complete solution; the biliary soap having the same action upon it, as upon the oleaginous constituents of the chyme.—From the recent experiments of H. Meckel, however, it appears that the Bile may perform another very important office,—the transformation of sugar into fatty matter. He found that, when bile was mingled with grape-sugar, and allowed to remain in contact with it for some time, a much larger quantity of fatty matter existed in the mixture, than could have been present in the bile; and that the transformation is much aided by heat. Thus, the amount of fat, contained in an equal amount of the bile employed, having been ascertained from parallel experiments to be from '48 to '54 grammes, the amount obtained from the mixture of bile and grape-sugar, after five hours' exposure to the warmth of an incubating machine, was '87 grammes; and after twenty-four hours' exposure, 1'84 grammes.* It seems probable that this transformation may take place in the Liver itself; for in animals fed upon grape-sugar, this substance has been detected in the blood of the *portal* vein, but not in that of the hepatic vein. It will take effect, not merely upon the Sugar introduced as such in the food, but also upon the amylaceous substances, which have been converted into sugar by the action of the Salivary and Pancreatic fluids (§ 670).

836. There can be no doubt, however, that the Bile is partly an excrementitious fluid; a portion of it being destined to be at once carried out of the system, by the intestinal canal, although another portion is destined to be re-absorbed, for the purpose (as it would seem) of being ultimately carried off by the respiratory process. The former part probably includes the whole of the colouring matter; the presence of which in the *faeces* is sufficiently obvious. The latter seems usually to comprise the fatty or soapy portion; no distinct indications of which can be generally found in the *faeces*, unless they have rapidly passed through the alimentary canal (§ 662). But in particular states of the system, the *faeces* may contain a very large quantity of bile; the presence of which almost unchanged, may be recognized in the evacuations in bilious diarrhœa, and in the stools which follow mercurial purgatives. Hence the Bile *may* be a completely excrementitious product; and the idea of the action of the Liver, as one of the great purifiers of the body from the results of its decay, is not at all invalidated by the observation, that a large part of its secretion is ordinarily destined for immediate re-absorption. The composition of the secretion clearly indicates, that it is especially intended to eliminate from the blood its superfluous Hydro-Carbon,—whether this have been absorbed as such from the aliment, or have been taken up by the Blood as effete matter, during the course of the circulation.

a. If more non-azotized food be taken into the system, than can be got rid of by the Respiratory process, and if there be not a sufficiently rapid production of Adipose tissue to admit of its being deposited as Fat, it would accumulate in the Blood, unless separated by

* Mr. Paget's Report, in Brit. and For. Med. Rev., July 1846, p. 261.

the Liver. If too much work be thrown upon this organ, its function becomes disordered, from its inability to separate from the Blood, all that it should draw off: the injurious substances accumulate in the Blood, therefore, producing various symptoms that are known under the general term of *bilious*. This is particularly liable to happen in warm climates, in consequence of the diminished excretion through the Lungs,—occasioned by the warmth of the surrounding air, and the small quantity of exercise usually taken. To remove these symptoms, medicines are required, which shall stimulate the liver to increased action. The constant use of such, however, has a very pernicious effect upon the constitution; and careful attention to the regulation of the diet,—especially the avoidance of a superfluity of oily or farinaceous matter,—together with the employment of an increased amount of exercise, will probably answer the same end in a much better manner.

Besides the source of Biliary matter already pointed out in the decomposition of the Fibrinous tissues (§ 819), it seems probable that there is another very important one in the continual waste of Nervous matter, which more nearly approaches Bile in composition (§ 249); especially if, as asserted by Fremy, the peculiar acids of the Brain may be detected in the Liver. In cases of slow Asphyxia, the amount of the Biliary secretion is much increased; as might be expected, from what has just been stated of its purpose.

837. It would not seem improbable, that the Liver acts towards the absorbed matters which enter the blood by the Mesenteric Veins, the same part which the Lungs perform for those which are introduced through the Lymphatic system; namely, the affording an opportunity for the excretion of superfluous or injurious substances contained in the absorbed fluid, before it enters the general current of the Circulation. There is every reason to believe, that the conversion of Chyle into Blood is a slow process, requiring the prolonged influence of the latter fluid upon the former; during this influence many chemical changes take place, which are almost certain to be attended with an extrication of Carbon and Hydrogen, these being the ingredients of which the Chyle contains most when compared with blood; and for the extrication of these, the Lungs and Liver afford ready means. Hence we see why the Lacteal system should terminate in a Venous trunk near the Heart, so that the fluid discharged by it will proceed at once to the Lungs; and why the Liver, wherever it has a distinct circulation, should receive the blood from the walls of the Intestines. Among the Mollusca, in which the chyle is absorbed by the mesenteric veins, (there being no separate lacteal system,) these veins, instead of returning to the heart through the liver, terminate in the branchial vessels; and the process of depuration is effected by the gills. Their liver is supplied only by the hepatic artery.

a. This view derives interesting confirmation from the experiments of Cruveilhier, on the artificial production of purulent deposits by injection of Mercury into the veins. He found that, when the mercury was introduced into any part of the general venous system, abscesses in the Lungs were induced; each inclosing a globule, the irritation occasioned by which was the cause of the purulent deposit. When the mercury was introduced into one of the Intestinal veins, on the other hand, similar purulent deposits occurred in the Liver. It is well known that abscesses in the Lungs and Liver are very common sequelæ of wounds of the head, and of surgical operations, especially those involving bones; and there seems good reason to believe, that in such cases Pus (or some of its elements, which may act the part of a ferment in exciting suppuration elsewhere), is actually carried along with the current of blood in the Lungs and Liver; and that, like the globules of mercury, not being susceptible of elimination by these two great excretories, it acts as a disturbing cause, and occasions disease of their tissue. The fact that a considerable amount of Copper may be detected in the substance of the Liver, after the prolonged introduction of its salts into the system, seems to add weight to this view of its function. It is yet to be ascertained, however, why some substances should be arrested in this organ, whilst others are allowed to pass.

3.—*The Kidneys.—Secretion of Urine.*

838. The *Kidneys* cannot be regarded as inferior in importance to the *Liver*, when considered merely as excreting organs; but their function only consists in separating from the blood certain effete substances, which are to be thrown off from it; and has no direct connection with any of the nutritive operations, concerned in the introduction of aliment into the system. Organs destined to the elaboration of a *Urinary* secretion may be traced very low down in the *Animal* scale. Among many of the *Mollusca* we find a small sac, filled with a semi-fluid secretion which has been shown to contain uric acid, opening into the intestine, near its anal orifice. In *Insects*, we often meet with prolonged tubes, resembling the biliary vessels in form, but terminating in a lower part of the intestinal tube; in some species these are dilated near their extremity into a receptacle for their secretion, or a urinary bladder. Throughout the *Vertebrated* classes, they exist in a still more evident form. They are uniformly composed of a congeries of prolonged tubes, subdividing and ramifying more or less; which spring from the ureter or efferent duct, and terminate either in blind extremities, or in a plexus formed by their inoculation. There are considerable variations in the arrangement of these tubes, however, in different tribes of animals. In *Fishes*, the *Kidneys* very commonly extend the whole length of the abdomen; and they consist of tufts of uniform-sized tubules, which shoot out transversely at intervals from the long ureter. These tubes frequently divide into pairs, but without any great alteration in their diameter. They appear to terminate in cœcal extremities, without any inoculation; the number of bifurcations, and the degree of convolu-

[Fig. 239.

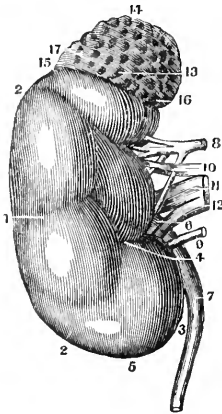

A view of the *Right Kidney* with its *Renal Capsule*; 1, anterior face of the kidney; 2, external or convex edge; 3, its internal edge; 4, hilum renale; 5, inferior extremity of the kidney; 6, pelvis of the ureter; 7, ureter; 8, 9, superior and inferior branches of the emulgent artery; 10, 11, 12, the three branches of the emulgent vein; 13, anterior face of the renal capsule; 14, its superior edge; 15, its external edge; 16, its internal extremity; 17, the fissure on the anterior face of the capsule.]

[Fig. 240.

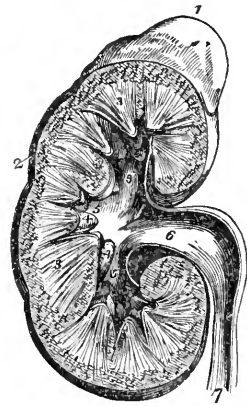

A section of the *Kidney*, surmounted by the *Supra-Renal Capsule*; 1, the supra-renal capsule; 2, the vascular portion; 3, 3, its tubular portion, consisting of cones; 4, 4, two of the calices receiving the apex of their corresponding cones; 5, 5, 5, the three infundibula; 6, the pelvis; 7, the ureter.]

[Fig. 241.]

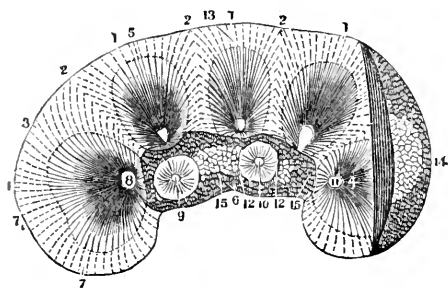

A view of half a Kidney divided vertically from its convex to its concave edge; one of its extremities is perfect; 1, 1, the lobes which form the kidney; 2, 2, the lines of separation of these lobes; 3, the cortical substance; 4, 5, the pyramids of Malpighi; 6, the hilum renale split up and cleared of its vessels; 7, 7, points to the tubes of Bellini; 8, one of the papillae; 9, 10, two other papillae, uncut, but deprived of the calices that surrounded them; 11, one of the foveolae in the papilla; 12, 12, the vascular circle surrounding the papillae; 13, circumference of the tubular portion; 14, external surface of the kidney; 15, the portion of its external surface on a line with its fissure.]

[Fig. 242.]

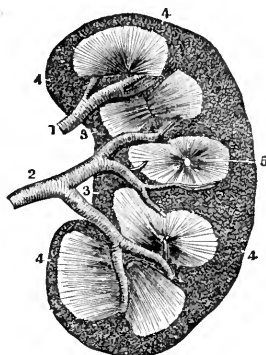

Represents the half of a Kidney divided vertically, and with its arteries injected; the matter has also passed into the excretory ducts; 1, 2, branches of the emulgent artery; 3, 3, hilum renale; 4, 4, cortical substance, as essentially formed by the capillary terminations of the vessels of the kidney; 5, medullary or tubular portion.]

tion, vary greatly in different species. The uriniferous tubes are connected together by a very loose areolar web.—The structure of the gland in Reptiles appears to be essentially the same; its form, however, varies considerably in the different tribes, being greatly prolonged in the Serpents, and abbreviated in the Tortoises. In the Crocodile, the distinction between the cortical and medullary portion begins to show itself; the tubes being nearly straight where they issue from the ureter, and being convoluted near the surface only of the lobes. The Corpora Malpighiana (§ 839, *b*), however, where they exist in this class, are scattered through the whole substance; not being confined, as in higher animals, to the cortical portion.—In Birds, the urinary tubes, forming the several clusters, are more closely united together; they frequently ramify to a considerable degree.—In the Mammalia, as in Man, there is an evident distinction between the straight and the convoluted portions of the system of tubes; the former character is seen in the *medullary* substance; the latter in the *cortical*. In nearly all below the Mammalia, the kidneys present externally a lobulated aspect; resulting from the want of union between the different bundles of tubes, which arise from separate parts of the ureter. In the kidney of the Mammalia, however, the ureter dilates into a capacious receptacle, towards which the several bundles of uriniferous tubes converge, so that they open into it in close proximity with each other; and the lobules formed by these bundles are so closely brought together, that no appearance of a division presents itself, until a section of the gland is made. Among some Mammalia, however, the lower form is still retained; and it is presented in the Human species also, at an early period of its foetal development.

839. The following is an account of the structure of the Kidney, according to the most recent investigations.*

* See Bowman in Philosophical Transactions, 1842; also Gerlach, in Müller's Archiv, Heft 4, 1845, and in Ranking's Abstract, vol. iii. p. 307.

a. The distinction between the *cortical* and *medullary* parts of the Kidney essentially consists in this,—that the former is by far the most vascular, and the plexus formed by the tubuli uriniferi seems to come into the closest relation with that of the sanguiferous capillaries, so that it is probably the seat of the greater part of the process of secretion; whilst the latter is principally composed of tubes, passing in a straight line from the former towards their point of entrance into the ureter. In this respect there is a considerable analogy of structure and comparative function, between the two parts of the kidney and the two parts of the brain. The adjoined figure represents the appearances presented by a portion of an

Fig. 243.

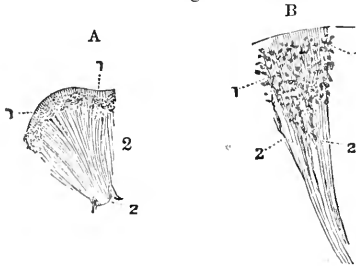
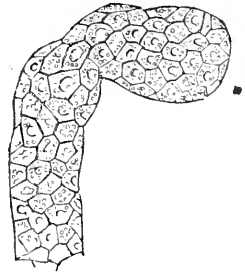

Fig. 244.



Portion of the Kidney of a new-born infant; A, natural size; 1, 1, corpora Malpighiana, as dispersed points in the cortical substance; 2, 2, papilla; B, a smaller part magnified; 1, 1, corpora Malpighiana; 2, 2, tubuli uriniferi.

Portion of one of the tubuli uriniferi, from the kidney of an adult; showing its tessellated epithelium. Magnified 250 diameters.

injected kidney, as seen by the naked eye, and under a low magnifying power. The tubuli uriniferi, in passing outwards from the calices, increase in number by divarication, to a considerable extent, as shown in Fig. 246; but their diameter remains the same. When they arrive in the cortical substance, their previously straight direction is departed from, and they become much convoluted. The closeness of the texture formed by their interlacement with the blood-vessels, renders it difficult to obtain a clear view of their mode of termination. They seem to inosculate with each other, forming a plexus, with a free extremity, or more probably a loop, here and there (Fig. 246); the number of these free extremities, however, does not appear to be nearly equal to that of the uriniferous tubes themselves.

b. Scattered through the plexus formed by the blood-vessels and uriniferous tubes, a number of little dark points may be seen with the naked eye, to which the designation of Corpora Malpighiana has been given, after the name of their discoverer. Each one of these, when examined with a high magnifying power, is found to consist of a mass of minute blood-vessels (Fig. 246, 7); somewhat resembling those convoluted masses of Absorbents, termed Lymphatic Glands. Each of these is included in an offshoot from one of the tubuli uriniferi, which swells into a flask-like dilatation to receive it (Fig. 247); and every tube may have several such lateral offshoots. The Epithelium which elsewhere lines the tube (whose usual character is shown in Fig. 244) is altered in appearance, where the tube is continuous with this capsular dilatation (Fig. 247, 2''); being there more transparent, and furnished with cilia (as shown at 2''), which in the Frog may be seen, for many hours after death, in very active motion, directing a current down the tube. Further within the capsule, the Epithelium is excessively delicate; but it may be clearly seen to cover the convoluted knot of vessels, which constitutes the Malpighian body.*—The Renal Artery, on entering the Kidney, divides itself into minute twigs, which are the *afferent* vessels of the Malpighian tufts (Fig. 248, *af*). After it has pierced the capsule, the twig dilates; and suddenly divides and subdivides itself into several minute branches, terminating in convoluted capillaries, which are collected in the form of a ball (*m. m*); and from the interior of the ball, the solitary *effluent* vessel, *c f*, arises, which passes out of the capsule by the side of the single *afferent* vessel. This ball seems to lie loose and bare in the capsule, being attached to it only by its *afferent* and *effluent* vessels (Fig. 248, *m*); but it appears in reality to be enveloped in a reflexion of the membrane that forms the capsule; and from this are probably generated the epithelium-cells, by which it is covered. The *effluent* vessels, on leaving the Malpighian bodies, separately enter the plexus of capillaries, *p*, surrounding the tubuli uriniferi, *st*, and supply that plexus with blood: from this plexus the Renal vein arises.—In Mr. Bowman's

* On this point, which is one of difference between Mr. Bowman and Dr. Gerlach, the Author's own observations lead him unhesitatingly to concur with the latter.

[Fig. 245.]

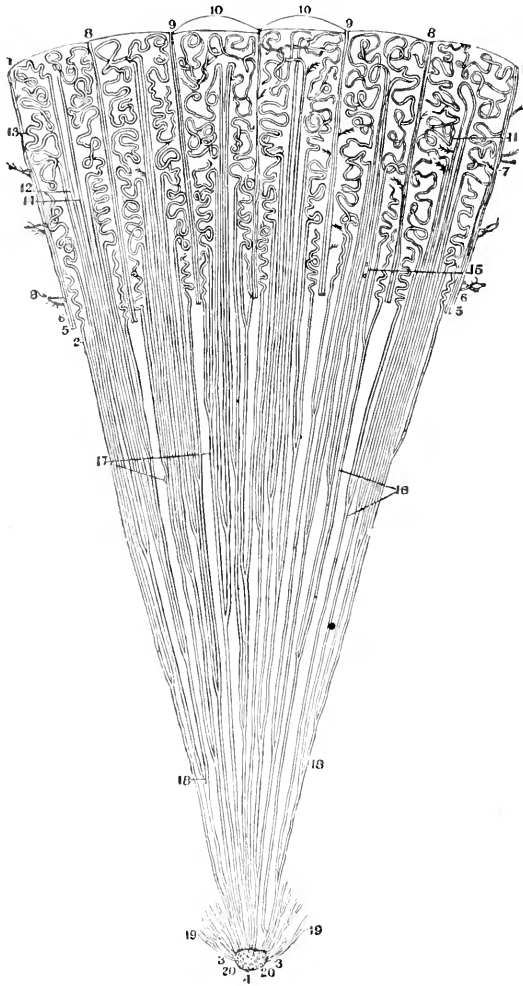

A section of one of the Pyramids of Malpighi, and of its corresponding cortical substance, as seen under the microscope; 1, portion of the surface of the kidney; 2, from this figure up to 1, is the cortical substance of the kidney; 3, from 2 to this number is the tubular portion; 4, the foveola; 5, 6, arteries and veins ramifying through the kidney; 7, arteries to the acina of the kidney; 8, capillary extremities of veins anastomosing with corresponding arterioles; 9, tortuous extremities of the arteries directed into the interior of the gland; 10, bases of the cones of the cortical and pyramidal substance of the kidney; from 10 to 4 is a collection of these cones; 11, the envelop of the cortical layer; 12, prolongations of the tubular portion; 13, tortuous tubes, or those of Ferrièr; 14, straight tubes, or those of Bellini; 15, vessels which wind between them; 16, course of the uriniferous tubes in the tubular portion; 17, the matter between these tubes; 18, bifurcation of the straight tubes; 19, sections of these tubes; 20, their orifices.]

opinion, *all* the free extremities of the tubuli uriniferi thus include Corpora Malpighiana; and the appearance of caecal terminations, such as those represented at *a* and *c*, Fig. 246, he regards as an optical illusion, caused by a change in the direction of the tubuli, which occasions them to dip away suddenly from the observer.

Fig. 246.

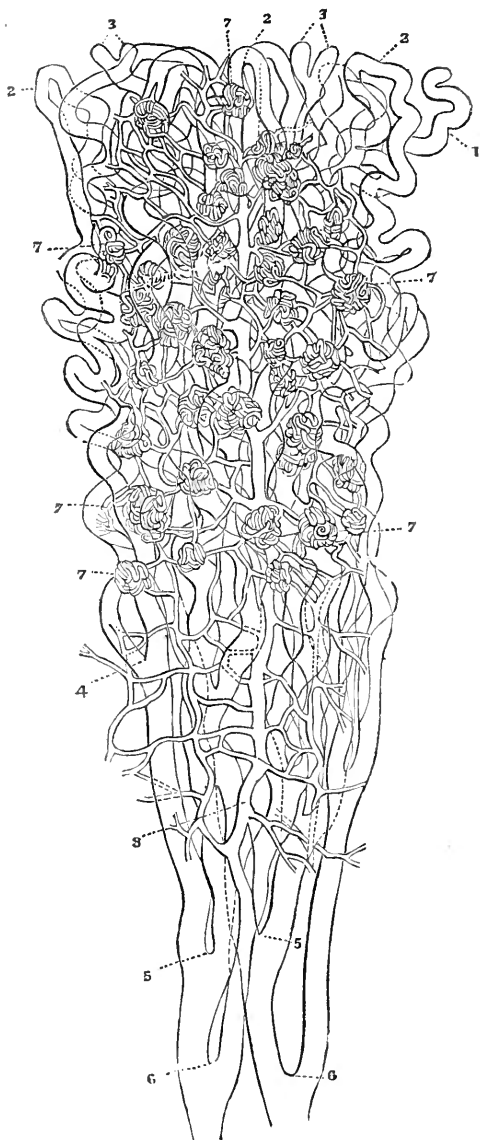

A small portion of the Kidney, magnified about 60 times; 1, supposed cæcal extremity of a tubulus uriniferus; 3, 3, recurrent loops of tubuli; 5, 5, bifurcations of tubuli; 4, 5, 6, tubuli converging towards the papilla; 7, 7, 7, Corpora Malpighiana, seen to consist of plexuses of blood-vessels, connected with a capillary net-work; 8, arterial trunk.

c. The Embryological Development of the Urinary organs in Vertebrated animals is a subject of peculiar interest; owing to the correspondence which may be traced between the transitory forms they present in the higher classes, and their permanent condition in the lower. In this respect there is an evident analogy with the Respiratory system. The first

appearance of anything resembling a Urinary apparatus in the Chick, is seen on the second half of the third day. The form at the time presented by it is that of a long canal, extending on each side of the Spinal Column, from the region of the heart, towards the Allantois; and the sides of this present a series of elevations and depressions, indicative of the commencing development of cœca. On the fourth day, the *Corpora Wolffiana*, as they then are termed, are distinctly recognized, as composed of a series of cœcal appendages, which are attached along the whole course of the first-mentioned canal, opening into its outer side. On the fifth day these appendages are convoluted; and the body which they form acquires increased breadth and thickness. They evidently then possess a secreting function; and the fluid which they separate is poured by the long straight canal into the cloaca. Between their component shut sacs, numbers of small points appear, which consist of little clusters of convoluted vessels, exactly analogous to the *Corpora Malpighiana* of the kidney.—The

Fig. 247.

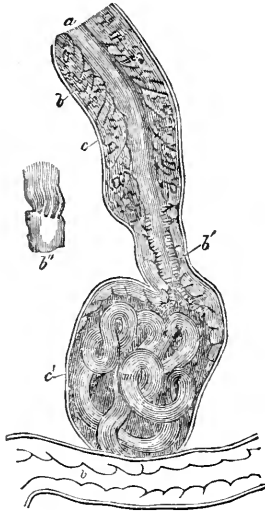

Urineriferous Tube, Malpighian Tuft, and Capsule, from Kidney of Frog: *a*, cavity of the tube; *b*, epithelium of the tube; *b'*, ciliated epithelium of the neck of the capsule; *b''*, detached epithelium scale; *c*, basement membrane of tube; *c'*, basement membrane of capsule. Magnified about 320 diam.

Fig. 248.

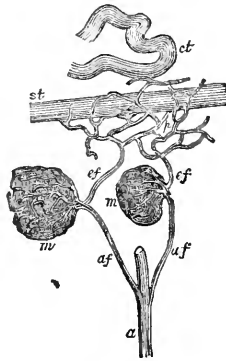

Distribution of the Renal vessels; from Kidney of Horse; *a*, branch of Renal artery; *af*, afferent vessel; *m*, *m*, Malpighian tufts; *ef*, *ef*, efferent vessels; *p*, vascular plexus surrounding the tubes; *st*, straight tube; *ct*, convoluted tube. Magnified about 30 diam.

Fig. 249.

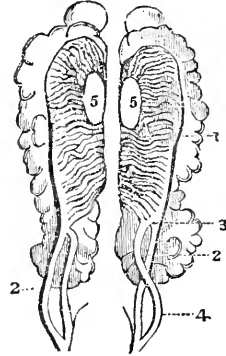

Corpora Wolffiana, with kidney and testes, from embryo of Bird; 1, kidney; 2,2, ureters; 3, corpus Wolffianum; 4, its excretory duct; 5, 5, testicles; at the summit are seen the supra-renal capsules.

Corpora Wolffiana, however, have only a temporary existence in the higher Vertebrata; although it seems that, in Fishes, they constitute the permanent kidney.* The development of the true Kidneys commences in the Chick about the fifth day. They are seen on the sixth, as lobulated grayish masses, which sprout from the outer edges of the Wolffian bodies; and they gradually increase, the temporary organs diminishing in the same proportion. The sexual organs, as will be hereafter explained (§ 866, *b*), also originate in the Wolffian bodies; and at the end of foetal life, the only vestige of the latter is to be found as a shrunk rudiment situated near the testes of the male.—The progress of development in the Human embryo seems closely conformable to the foregoing account. The Wolffian bodies begin to appear towards the end of the first month; and it is in the course of the seventh week, that the true Kidneys first present themselves. From the beginning of the third month the diminution in the size of the Wolffian bodies goes on *pari passu* with the increase of the Kidneys; and at the time of birth scarcely any traces of them can be found. At the end of the third

* See Principles of General and Comparative Physiology, § 659.

month, the kidneys consist of seven or eight lobes, the future pyramids; their excretory ducts still terminate in the same canal, which receives those of the Wolffian bodies and of the sexual organs; and this opens, with the rectum, into a sort of cloaca, or sinus urogenitalis, analogous to that which is permanent in the oviparous Vertebrata. The Kidneys are at this time covered by the Supra-Renal Capsules, which are very large; about the sixth month, however, these have decreased, whilst the kidneys have increased, so that their proportional weight is as 1 to 4½. At birth the weight of the Kidneys is about three times that of the Supra-Renal Capsules; and they bear to the whole body the proportion of 1 to 80; in the adult, however, they are no more than 1 to 240. The Corpora Wolffiana are, when at their greatest development, the most vascular parts of the body next to the liver; four or five branches from the aorta are distributed to each, and two veins are returned from each to the vena cava. The upper veins and their corresponding arteries are converted into the Renal or emulgent vessels; and the lower into Spermatic vessels. The lobulated appearance of the kidney gradually disappears; partly in consequence of the condensation of the areolar tissue, which connects the different parts; and partly through the development of additional tubuli in the interstices. The Urinary Bladder is formed quite independently of the secreting apparatus, being a part of the *allantois*, which is first developed as a large cœcum or diverticulum from the lower extremity of the alimentary canal (Chap. XVII.). The part of the tube below this forms the Cloaca, or common termination of the intestinal and vesical apparatus. The sides of this cloaca, however, gradually approach one another, so as to form a transverse partition, which separates the Rectum from the Genito-urinary canal; and the urethra of the female is afterwards separated from the Vagina by a similar process.

840. The researches of Mr. Bowman on the structure of the Malpighian bodies, and on the vascular apparatus of the Kidney, have thrown great light upon the mode in which the Urinary secretion is elaborated. One of the most remarkable circumstances attending this excretion, in the Mammalia particularly, is the large but variable quantity of *water*, which is thus got rid of,—the amount of which bears no constant proportion to that of the solid matter dissolved in it. The Kidneys, in fact, seem to form a kind of regulating valve, by which the quantity of water in the system is kept to its proper amount. The Exhalation from the Skin, which is the other principal means of removing the superfluous liquid from the blood, is liable to great variations, from the temperature of the air around (§ 870): hence, if there were not some other means of adjusting the quantity of fluid in the Blood-vessels, it would be liable to continual and very injurious variation. This important function is performed by the Kidneys; which allow such a quantity of water to pass into the urinary tubes, as may keep the *pressure* within the vessels nearly at a uniform standard. The quantity of water which is passed off by the kidneys, therefore, will depend in part upon that exhaled by the Skin; being greatest when this is least, and *vice versâ*: but the quantity of solid matter to be conveyed away in the secretion has little to do with this; being dependent upon the amount of *waste* in the system, and upon the quantity of surplus azotized aliment which has to be discharged through the channel.—The Kidney contains two very distinct provisions for these purposes. The *cells* lining the Tubuli Uriniferi are probably here, as elsewhere, the instruments by which the *solid* matter of the secretion is elaborated; whilst it can scarcely be doubted that the office of the Corpora Malpighiana is to allow the transudation of the superfluous fluid through the thin-walled and naked capillaries of which they are composed. “It would, indeed,” Mr. Bowman remarks, “be difficult to conceive a disposition of parts more calculated to favour the escape of water from the blood, than that of the Malpighian body. A large artery breaks up in a very direct manner into a number of minute branches; each of which suddenly opens into an assemblage of vessels of far greater aggregate capacity than itself, and from which there is but one narrow exit. Hence must arise a very abrupt retardation in the velocity of the current of blood. The vessels in which this delay occurs are uncovered by any structure. They lie bare in a cell, from which there is but one outlet, the orifice of the tube. This orifice

is encircled by cilia, in active motion, directing a current towards the tube. These exquisite organs must not only serve to carry forward the fluid which is already in the cell, and in which the vascular tuft is bathed; but must tend to remove pressure from the free surface of the vessels, and so to encourage the escape of their more fluid contents."

841. There is a striking analogy between the mode in which the Tubuli Uriniferi are supplied with Blood, for the purpose of elaborating their secretion, and the plan on which the Hepatic circulation is carried on. The secretion of the Liver is formed from blood conveyed to it by one large vessel, the Vena Portæ, which has collected it from the Venous capillaries of the chylopoietic viscera, and which subdivides again to distribute it through the liver. The secretion of the Kidney, in like manner, is elaborated from blood which has already passed through one set of capillary vessels,—those of the Malpighian tufts; this blood is collected and conveyed to the proper *secreting* surface, not by one large trunk (which would have been a very inconvenient arrangement), but by a multitude of small ones,—the *effluent* vessels of the Malpighian bodies, which may be regarded as collectively representing the Vena Portæ, since they convey the blood from the systemic to the secreting capillaries. Hence the Kidney may be said to have a *portal* system within itself.—This ingenious view of Mr. Bowman's finds support from the fact, that in Reptiles (in which, as in Fishes, the Portal trunk receives the blood from the whole posterior part of the body, and supplies the Kidneys as well as the Liver), the *effluent* vessels of the Malpighian bodies—which receive their blood, as elsewhere, from the Renal Artery—unite with the branches of the Portal vein, to form the secreting plexus around the Tubuli Uriniferi. Here, therefore, the blood of the secreting plexus has a double source; the vessels which supply it receiving their blood in part from the capillaries of the organ itself, and in part from those of viscera external to it; just as, in the Liver, the secreting plexus is supplied in part by the blood conveyed from the chylopoietic viscera through the Vena Portæ, and in part by the nutritive capillaries of the organ itself, which receive their blood from the Hepatic Artery.

842. The nature and purposes of the Urinary secretion, and the alterations which it is liable to undergo in various conditions of the system, are much better understood than are those of the Bile; this is owing, in great part, to the circumstance, that it may be readily collected in a state of purity; and that its ingredients are of such a nature, as to be easily and definitely separated from each other by simple chemical means. There can be no doubt that the chief purpose of this excretion, is to remove from the system the effete azotized matters which the blood takes up in the course of the circulation, or which may have been produced by changes occurring in itself. This is evident from the large proportion of Nitrogen which is contained in the solid matter dissolved in it; and from the crystalline form presented by this solid matter when separated,—a form which indicates that its state of combination is such, as to prevent it from conducing to the nutrition of the system. The injurious effects of the retention in the Blood, of the components of the Urinary secretion, are fully demonstrated by the results of its cessation; whether this be made to take place experimentally (as by tying the renal artery), or be the consequence of a disordered condition of the kidney. Symptoms of great disorder of the nervous centres, analogous to those produced by many narcotic poisons, soon exhibit themselves; and the patient dies comatose, if the secretion be not restored. In such cases, Urea (the characteristic ingredient of the urine) is found to have accumulated in the Blood; and it may even be detected by the smell, in the fluid effused into the Ventricles of the Brain. The conclusion which may be drawn from this circumstance, regarding the pre-exist-

ence of the components of the secretion in the Blood, is strengthened by the fact that, even in the healthy state, Urea may be detected in the blood; it only exists there normally, however, in very small quantity; but, when there is any impediment to its excretion, it goes on accumulating, and produces consequences more or less serious in proportion to its amount. It is not improbable that, as in the case of the retention of Bile in the Blood (§ 832), many of the minor as well as of the severer forms of sympathetic disturbance, connected with disordered secretion from the Kidney, are due to the directly poisonous operation of the elements of the Urine, upon the several organs whose function is disturbed; and that many complaints, in which no such agency has been until recently suspected,—especially Convulsive affections arising from a disordered action of the Nervous centres,—are due to the insufficient elimination of Urea from the Blood.

843. In order to form a correct opinion of the state of the Urinary secretion in morbid conditions of the system, it is desirable to be acquainted with every leading particular regarding its healthy characters.—The average Quantity, during 24 hours, has been variously estimated: it differs, of course, with the amount of fluid ingested, and it is influenced also by the external temperature,—a much smaller amount of the superfluous fluid of the body being set free from the skin in winter than in summer, and a larger proportion being carried off by the kidneys. Probably we shall be pretty near the truth, in estimating the amount at from about 30 oz. in summer, to 40 oz. in winter, for a person who does not drink more than the simple wants of nature require.—The Specific Gravity comes to be a very important character, in various morbid conditions of the urine: and it is therefore desirable to estimate it correctly. This also is, of course, liable to the same causes of variation; since, when the same amount of solid matter is dissolved in a larger or smaller quantity of water, the specific gravity will be proportionably lower or higher. The average, according to Dr. Prout, in a healthy person, taking the whole year round, is about 1020; the standard rising in summer (on account of the greater discharge of fluid by perspiration) to 1025; and being lowered in winter to 1015. Simon, however, states the average specific gravity at no more than 1012. It will depend, in each individual case, upon the amount of fluid habitually ingested, as compared with that dissipated by cutaneous exhalation; and it will also vary with the period that has elapsed since the last introduction of liquid into the stomach. From these and other causes, the proportion of solid matter in 1000 parts of Urine may vary from 20 to 70. The following table expresses the relative amounts of the different components, in every 100 parts of this solid matter; according to the analyses of different Chemists.

	Berzelius.	Lehmann.	Simon.	Marchand.
Urea	45·10	49·68	33·80	48·91
Uric Acid	1·50	1·61	1·40	1·59
Extractive matter, Ammonia-salts, and Chloride of sodium }	36·30	28·95	42·60	32·49
Alkaline Sulphates	10·30	11·58	8·14	10·18
Alkaline Phosphates	6·88	5·96	6·50	4·57
Phosphates of Lime and Magnesia	1·50	1·97	1·59	1·81

We shall presently find the causes of some of these variations in the nature of the ingesta, and in the amount of exercise taken by the individual.—The Urine in health usually exhibits an *acid* reaction; this depends, however, upon certain conditions furnished by the aliment; and may be altered (as will presently appear) by a change in the ingesta.

844. The most important of the above ingredients (constituting from one-third to one-half of the whole solid matters of the Urine) is evidently that which, from its being the principal cause of the characteristic properties of the

secretion, is termed *Urea*. This may be readily separated from Urine, in the form of transparent colourless crystals; which have a faint and peculiar, but not urinous odour: and, as already mentioned, it is distinctly traceable in the Blood, where it rapidly accumulates, if its continual elimination be in any way interfered with. It is very soluble in water, and combines with acids without neutralizing them. In its chemical composition, it is identical with cyanate of ammonia; this composition being 2 Carbon, 4 Hydrogen, 2 Nitrogen, and 2 Oxygen,—a formula much more simple than that of almost any other organic substance. The amount of Urea excreted in twenty-four hours has been made the subject of examination by Lecanu;* and the following are his results, as deduced from a series of 120 analyses:—

	Minimum.	Mean.	Maximum.
By men	357·51 grs.	433·13 grs.	510·36 grs.
By women	153·25	295·15	437·06
By old men (84 to 86 years)	61·08	125·22	295·15
By children of eight years	161·78	207·99	254·20
By children of four years	57·28	69·55	81·83

It is very interesting to perceive, in this table, how large an amount of Urea is excreted by children; and how small a quantity, in proportion to their bulk, by old men. This corresponds precisely with the rapidity of interstitial change at different periods of life. (See § 812.) Moreover, as this continual disintegration is very much accelerated by increased vital activity of the Tissues, the amount of Urea undergoes a like augmentation; so that—other circumstances being equal—the amount of Urea excreted may fairly serve as a measure of the *waste* of the tissues, and consequently of the degree in which they have been exercised. This will be especially the case in regard to the Muscular Tissue; which constitutes so large a part of the fabric. In some experiments recently made on the influence of various causes upon the constitution of Urine, Dr. Lehmann found that, by the substitution of *violent* for *moderate* exercise, the quantity of Urea was raised from $32\frac{1}{2}$ to $45\frac{1}{2}$ parts; and Simon found that, by two hours' violent exercise, the proportion of the urea in the urine passed half an hour subsequently was double that contained in the morning urine. If such increased *waste* be not compensated by increased *nutrition*, a diminution in the bulk of the body is the necessary consequence.

845. The next important ingredient, *Uric* or *Lithic* Acid, exists much more largely in the Urine of the lower Vertebrata, than in that of Mammalia; thus the nearly solid urinary excretion of Serpents, and the semi-fluid urine of Birds, is almost entirely composed of this acid, in combination with Ammonia. Its presence has not yet been detected in healthy blood; but when it is imperfectly eliminated, we are assured of its accumulation in the circulating fluid, by its deposition, in combination with Soda, in the neighbourhood of the joints,—forming Gouty concretions, or Chalk-stones. Pure Lithic acid crystallizes in fine scales of a brilliant white colour, and silky lustre; it is tasteless and inodorous, and is so sparingly soluble in water, that at least 10,000 times its own weight is required to dissolve it. As it exists in a state of perfect solution in healthy Urine, it must be in combination with some base; and that this is the case, is at once proved by the fact, that it is precipitated immediately on the addition of a small quantity of any acid, even the Carbonic. It is generally believed, that the base is Ammonia; but it has recently been affirmed by Liebig,† that the Uric acid (with the Hippuric) is held in solution by the Phosphate of Soda,—which, from being bibasic or alkaline, is rendered acid, by yielding up a part of its soda to these organic

* Journal de Pharmacie, tom. xxv.

† Lancet, June 8, 1844.

acids, which are thereby rendered soluble. It is in this manner that he partly explains the usually *acid* reaction of healthy urine; the other causes of which will be presently noticed.—If there be an undue proportion of Lithic acid in the urine, it will be precipitated on cooling; because it is less soluble in a cold than in a warm solution of phosphate of soda; and the same result will happen, if there be a predominance of other acids in the urine, which will seize upon its base, as soon as its own affinity for it is diminished by the lowering of its temperature. By Dr. Prout it is believed that Lactic acid, existing in the Blood or in the Urine in excess, is an ordinary source of this deposit; but the presence of this acid is altogether denied by Liebig (§ 846).—The composition of Lithic Acid is as follows:—10 Carbon, 4 Hydrogen, 4 Nitrogen, 6 Oxygen. The amount of it usually excreted in the Urine of Man is but very small; it is occasionally, however, considerably increased; but the circumstances under which this increase takes place have not yet been exactly determined.

a. Uric acid is replaced in the Herbivorous animals by the *Hippuric*; the composition and properties of which are very different from those presented by that substance. When pure, it forms long transparent four-sided prisms; it is soluble in 400 parts of cold water, and dissolves readily at a boiling heat; and it has a strong acid reaction, and bitterish taste. Its formula is 18 Carbon, 8 Hydrogen, 1 Nitrogen, and 5 Oxygen, with 1 equiv. of Water. It has very curious relations with Benzoic acid; which it yields, together with Benzoate of Ammonia, when acted upon by a high temperature, or during the putrefaction of the urine of which it forms a part. According to Liebig, the Hippuric acid in the urine of the Horse and Ox is replaced by Benzoic acid, when the animal is subjected to hard labour.—It appears from his recent experiments,* that we are to regard Hippuric acid as a normal element of Human urine; for he has detected Benzoic acid among the products of its putrefaction; and as we know that the latter does not exist in the Urine of Man, and as there is no other substance at the expense of which it can be formed during the putrefactive process, we can scarcely hesitate to admit that such must be the case. It is a very curious fact, that the introduction of Benzoic acid into the system causes a large increase in the amount of Hippuric acid in the Urine; and if this be formed at the expense of the elements, which would otherwise have produced Uric acid, an easy method is pointed out for the elimination of the latter substance from the blood, when it has accumulated there,—the salts of Hippuric acid being so much more soluble than those of the Uric. According to Keller,† whose experiments were made upon himself, both Urea and Uric acid existed in normal quantity in his urine, though a large quantity of Hippuric acid was being excreted; whilst Mr. Alexander Ure states,‡ that he has succeeded, by the administration of Benzoic acid, in preventing the deposition of Gouty concretions, and even in removing them when they had been formed.

b. Many remarkable changes are effected in Lithic acid, by the operation of other chemical agents; and these changes are very important, in their bearing on pathological conditions of the Urine. When Uric acid is subjected to the action of Oxygen, it is first resolved into Urea and a compound termed *Alloxan*. Now this Alloxan, when acted on by a new supply of Oxygen, is resolved into Urea and Oxalic acid; or, with a still further amount of Oxygen, into Urea and Carbonic acid—a fact, which has a very important bearing on the production of Calculi composed of Uric and Oxalic acids, and which explains the remarkable alternations which are often observed in the layers of these concretions. It is affirmed by Liebig, that the calculi which are composed of Urate of Ammonia, or of Oxalate of Lime, occur in persons, in whom, from want of exercise, or from other causes, the quantity of Oxygen introduced into the system is beneath what it ought to be. When patients suffering under Uric acid Calculi take more exercise, the Urates are replaced by Oxalates, in consequence of the larger amount of Oxygen introduced into the system; and if the oxygenation could be carried still further, the latter would cease to be deposited, their elements passing off in the form of Urea and Carbonic acid. These views are borne out by the results of Lehmann's experiments upon himself; for he found that the violent exercise, which raised the proportion of Urea in the urine by more than one-third (§ 844) brought down the amount of Uric acid from 1.18 to .642, or nearly one-half.

c. Another change is that which gives rise to the peculiar compound termed *Allantoin*; which naturally exists in the fluid of the Allantois of the fetal calf. This may be formed artificially by boiling Uric acid with peroxide of lead; from which process there result an

* Loc. cit.

† Liebig's Animal Chemistry, p. 327.

‡ Medico-Chirurgical Transactions, vol. xxiv.

Oxalate of the protoxide of lead, Urea and Allantoin; the composition of which last substance is very different from that of urea or uric acid, being 8 Carbon, 5 Hydrogen, 4 Nitrogen, and 5 Oxygen.

d. By the operation of Nitric Acid upon Uric acid, several new products are generated, some of which are of much practical interest. To one of these the name of *Murexid* has been given, on account of its reddish purple colour (resembling that of the Tyrian dye which was obtained from a species of Murex); this is a crystalline substance, sparingly soluble in cold water, but copiously soluble in warm, imparting to it its vivid colour. By Dr. Prout it was long since described as consisting of a peculiar acid, the *Purpuric*, in combination with Ammonia; this view of its composition is not generally received by German Chemists; but it has lately been supported by Fritzehe, who has shown the real existence of the acid, by obtaining Purpurates of other bases. This substance is one source of the colours of the pink and lateritious sediments which so often present themselves in the Urine; these hues partly depend, however, on the influence of nitric acid upon the peculiar Colouring principles of the urine, the nature of which principles is not yet fully understood.

846. It was supposed until recently, that *Lactic* acid is a normal constituent of Human Urine. It appears to have been demonstrated by the experiments of Liebig, however, that this is not the case; and that another organic substance, which forms a crystalline compound with zinc, very similar to the lactate, has been mistaken for it. The composition of this substance, which usually forms about one part in 200 of Urine, has been recently determined to be 8 Carbon, 8 Hydrogen, 3 Nitrogen, and 3 Oxygen. It thus differs from Lactic acid in containing Nitrogen; as well as in proportion of its other components.

847. It has been shown (§ 843), that the Urine contains a considerable amount of Saline matter; the excretion of which from the system appears to be one of the principal offices of the Kidney. Various saline compounds, and the bases of others, are being continually introduced with the food (§ 648); and these, after performing their part in the organism, must be eliminated from the circulating fluid, in order to prevent injurious accumulation. Of these we shall now examine the chief sources.—The mode in which the *Muriates* find their way into the Urine is easily understood. Of the Common Salt ingested, a considerable part is decomposed into Muriatic Acid and Soda; the former being found uncombined in the Gastric juice; and the latter in the Bile. By the mixture of the Bile with the Chyme, a re-union of these two constituents takes place; and Salt is again formed, which is received into the Circulation that it may be eliminated (its part in the economy having been now performed) by the Kidney.—The quantity of the *Sulphates* present in the Urine, appears to have no relation with that of the amount of Sulphuric acid ingested; for it much surpasses what could be thus accounted for,—being often considerable, when no Sulphate whatever can be detected in the food. But most of the azotized compounds employed as food have *Sulphur* in combination with them; and there can be no doubt, that this undergoes oxidation within the system, and thus generates *Sulphuric acid*, which unites with any free or weakly-combined bases it may meet with, to form the Sulphates present in the Urine.—The *Phosphates* are probably derived in part from the Phosphates taken in with the food, and in part from the free Phosphorus, which its elements contain. Of the latter, great use is made in the production of Nervous matter (§ 249); the continual *waste* of which must set it free again. When thus set free, there is obviously no channel for its elimination, save by its conversion into Phosphoric acid, and its union with an alkaline base.* That this is really the case, would appear from the fact noticed by Dr. Prout, and confirmed by many others,—that mental or bodily labour which involves

* This circumstance has been entirely overlooked by Liebig, in his late discussion (*loc. cit.*) of the Constitution of the Urine; the Phosphates being regarded by him as having their sole origin in the Phosphates of the ingesta.

much *waste* of the Nervous System, is followed by an increase in the quantity of the alkaline Phosphates in the Urine (§ 295). This increase cannot proceed from the waste of the Muscular system; for this would set free Phosphate of Lime, which chiefly passes off by the *fæces*.

848. The *alkaline* or *acid* reaction of the Urine, therefore, will not only depend upon the quantity of *alkaline* Phosphates converted into *acid* Phosphates by the Uric and Hippuric acids (§ 845); but also upon the amount of the *bases* in the ingesta, compared with that of the permanent Acids introduced into the system or generated within it. The Urine of animals which live chiefly or entirely upon Vegetable food, is almost invariably *alkaline*; because this food contains a large quantity of alkaline bases, in combination with Citric, Tartaric, Oxalic, and other acids, which are decomposed within the system; and the amount of Sulphuric and Phosphoric acids produced is not sufficient to neutralize them. On the other hand, the food of Carnivorous animals contains no free or weakly-combined bases; and as its Sulphur and Phosphorus, when oxidized in the system, produce a considerable quantity of free acids, which share the bases with the Muriatic acid already there, the Urine must necessarily have an *acid* reaction. The character of the Urine of Man, in this respect, is considered by Liebig to depend entirely upon that of the food ingested.

a. Proceeding upon his determination that no Lactic acid is ever present in the Urine, he remarks: "The acid, neutral, or alkaline reaction of Urine of healthy individuals, does not depend on any difference in the processes of digestion, respiration, or secretion, in the various classes of animals, but upon the constitution of the aliments, and upon the alkaline bases which enter the organism through the medium of these aliments. If the amount of these bases is sufficiently large to neutralize the acids formed in the organism, or supplied by the aliments, the urine is neutral; whilst it manifests an alkaline reaction, when the amount of alkaline bases thus supplied to the organism is more than sufficient to neutralize the acids; but in all these cases, the urine accords with the nature of the aliments taken." The varying amount of Uric Acid,—which, on Prof. Liebig's own showing, is very much influenced by the respiration,—is altogether left out of consideration in this sweeping generalization.

849. The amount of Azotized matter in the Urine, also, is greatly influenced by the nature of the food ingested, whilst the constitution of the Animal frame remains nearly the same; hence it appears, that a certain portion of it must be derived from the unassimilated materials which have been taken into the blood, and which, being superfluous, are injurious. It is well known that the ingestion of an over-supply of azotized matter does not occasion an increased production of the fibrinous or gelatinous tissues; and it may be hence inferred that, as there is no means by which the superfluous amount can be stored up in the system (in the mode that non-azotized matter is stored up as Fat), it *must* be continually eliminated from the Blood. And there can be no doubt that the Kidneys are the principal channel by which this is effected; the amount of azote thrown off in a given time, in the various compounds which they excrete, being equal to 10-11ths of the whole quantity ingested.—The following are the results of the most satisfactory inquiries that have yet been made, in regard to the influence of various kinds of Aliment upon the amount of the solid matters in the Urine. These experiments were performed by Dr. Lehmann of Leipsig, upon himself. In the *first* series, Dr. L. adopted an ordinary mixed diet; but he took no more solid or liquid aliment than was needed to appease hunger or thirst, and abstained from fermented drinks. Every two hours he took exercise in the open air, but he avoided immoderate exertion of every kind. The average result of the examination of the Urine passed under these circumstances, for fifteen days, is given in the first line of the subsequent Table.—In a *second* series of experiments, Dr. L. lived for twelve days on an exclusively Animal diet; and for

the last six of these, it consisted solely of eggs. He took 32 eggs daily; which contained 189·7 grammes of dry albumen, and 157·48 of fatty matters; or about 228·75 grammes of carbon, and 30·16 of azote. The amount of Urea is shown, in the second line of the Table, to have undergone a very large increase; and it contained more than five-sixths of the whole azote ingested.—In a *third* series of experiments, Dr. L. lived for twelve days on a Vegetable diet; and its effect upon the solid matter of the Urine is shown in the third line of the Table.—In a *fourth*, he lived for two days upon pure farinaceous and oleaginous substances, without azotized food of any kind; and the azotized matter of the Urine must, therefore, have been solely the result of the disintegration of the tissues. It is seen to undergo a very marked diminution under this regimen, as is shown in the fourth line of the Table. His health was so seriously affected, however, by this diet, that he was unable to continue it longer.

	Solid Matters.	Urea.	Uric Acid.	Lactic Acid (?) and Lactates.	Extractive Matters.
I. Mixed diet . . .	67·82	32·498	1·183	2·257	10·480
II. Animal diet . . .	87·44	53·198	1·478	2·167	5·145
III. Vegetable diet . . .	59·24	22·481	1·021	2·669	16·499
IV. Non-Azotized diet . . .	41·68	15·408	0·735	5·276	11·854

850. The following inferences are drawn by Dr. Lehmann, from these experiments:—“1. Animal articles of diet augment the solid matters of the Urine. Vegetable substances, and still more such as are deprived of azote, on the contrary, diminish it.—2. Although Azote be a product of decomposition of the organism, yet its proportions in the urine depend also on the food, for we find a richly-azotized diet augment considerably the quantity of Urea. In the above experiments, the proportion of the Urea to the other solid matters was as 100 to 116 in a mixed diet; as 100 to 63 in an animal diet; as 100 to 156 in a vegetable diet; and as 100 to 170 in a non-azotized diet.—3. The quantity of Uric Acid depends less on the nature of the diet, than on other circumstances; the differences observed in it being too slight to warrant us in ascribing them to the former cause.—4. The combinations of Proteine, and consequently the azote of the food, are absorbed in the intestinal canal; and what is not employed in the formation of the tissues, is thrown off by the Kidneys in the form of Urea or Uric acid,—these organs being the chief if not the sole, channel through which the system frees itself of its excess of azote.—5. The urine contains quantities of Sulphates and Phosphates proportional to the azotized matters which have been absorbed; and the proportion of these salts is sensibly increased under the use of a large amount of those.—6. In the same circumstances, the Extractive matters diminish, while their quantity is increased by the use of vegetable diet,—a fact which proves the influence of vegetable aliment over the production of these matters in the urine.—7. Under an animal diet, the quantity of Lactic acid diminishes; but the greater part of this acid is free. It is the reverse under a vegetable diet; there is more lactic acid, but it is united to bases. The largest production of lactic acid is under a non-azotized diet; and most of it is then combined with ammonia. Therefore the lactic acid eliminated with the urine, is in great part the product of non-azotized substances not entirely assimilated; but it results also in part from the decomposition of the azotized substances entering into the composition of the body and the food.—8. The Kidneys not only separate certain constituent parts of the organs, which have become inadequate for the maintenance of life, but they also expel the superfluous nutritive matters that may have been absorbed.”* It must be remarked, with regard to these

* L'Experience, Dec. 7, 1843; and Edinb. Monthly Journal, March, 1844.

inferences, that the statements concerning the amount of Lactic acid and the Lactates, must be considered as invalidated by the discoveries of Liebig already referred to (§ 846). The most unequivocal facts determined by Dr. Lehmann's inquiries, are those which relate to the influence of Diet on the amount of Urea excreted. The experiments upon a purely non-azotized diet were not continued long enough for a satisfactory result to be obtained; but it is evident that, so long as the ingesta contain no azote, the whole of that element in the Urine must be attributed to the disintegration or waste of the tissues, and may be fairly taken as a measure of its amount.

851. The fact of the pre-existence of the chief constituents of Urine in the Blood, is important as explaining the facility with which the secreting function appears to be transferred to other membranes, in some of the cases in which the Kidney does not perform its function. Doubtless there has been much error on this subject, arising out of deceptions practised by impostors; but a sufficient number of indubitably genuine cases are on record, to put it beyond doubt that such transferences have taken place,—urinous fluid being secreted from the stomach, mammæ, umbilicus, nose, &c.*—On the other hand, the Kidney may serve as the channel for the elimination of substances which are usually drawn off by other organs. Thus, when the secreting action of the Liver has been gradually impaired by structural disease, the Kidneys appear to have performed its function, in separating some (at least) of the elements of Bile. And a case has recently been mentioned, in which the urine of a parturient female, who did not suckle her infant, was found to contain a considerable amount of Butyric acid, during several days. The elimination of Kiesteine by the Kidney during pregnancy will be presently noticed (§ 859).

852. The facility with which substances taken into the current of the Circulation pass into the Urinary secretion, varies extremely; and no general law can be stated in regard to it. It appears from Wöhler's elaborate researches on this subject, that the salts which are most readily excreted are those which excite the action of the kidneys.† The rapidity with which absorption and elimination take place is often extremely remarkable; Prussiate of Potash having been detected in the urine, within two minutes after it had been introduced into the stomach. The variations in this respect would appear to depend chiefly on the degree of concentration of the saline solution, which will affect the rapidity of its absorption, according to the laws of Endosmose;—its reception into the blood being more rapid, in proportion as its density is lower, in comparison with that of the circulating fluid. Pure water, or water containing but a small admixture of saline matter, is readily absorbed into the blood-vessels of the Intestinal villi; but it is as readily drawn off through the Kidneys (by the agency, as it would seem, of the Malpighian bodies, § 840); and consequently a large amount may be ingested in a short time. But if the water contain an amount of saline matter *equal* to that of the Serum, no absorption of it takes place; it remains in the intestinal tube; and it is voided by the rectum. Further, if the quantity of saline matter in the solution be *greater* than that of the Serum, not only will no absorption take place, but there will be an endosmose of the water of the blood towards the solution; so that a large quantity of fluid is discharged by the Intestinal canal. This simple explanation, first offered by Liebig,‡ accounts well for the diuretic effect of most weak saline solutions, and the purgative qualities of stronger ones.—For the transit of the peculiar principles of Vegetables, however, it appears that from one to two hours are usually required. The effect

* For a scientific explanation of this fact, see Princ. of Gen. and Comp. Phys., § 539.

† See Müller's Physiology, p. 589.

‡ Chemistry applied to Agriculture and Physiology, Part ii.

of Oil of Turpentine, and probably of other *volatile* agents, is produced much more rapidly; the characteristic odour of violets being perceptible in the Urine passed but a few minutes after the vapour of the oil had been received into the lungs.

4.—Mammary Glands.—Secretion of Milk.

853. We now come to those Glands, whose action is rather to elaborate from the Blood certain products, which are destined for special uses in the economy, than to eliminate matters, whose retention in the circulating current would be injurious. Pre-eminent amongst these in size and importance, at least during their period of activity, are the Mammary Glands; which are found only in the animals of the Class Mammalia, and which present themselves in an almost rudimentary state in some of the non-placental subdivisions of the class (§ 44).

a. The structure of the Human Mammary Gland, which has been recently investigated fully by Sir A. Cooper, is very simple, and easily described. It consists of a series of ducts passing inwards from their termination in the nipple, and then ramifying like the roots of a tree, their ultimate subdivisions terminating in minute follicles. The mamillary tubes are usually about ten or twelve in number; they are straight ducts, of somewhat variable size; and their orifices, which are situated in the centre of the nipple, and are usually concealed by the overlapping of its sides, are narrower than the tubes themselves. At the base of the nipple, these tubes dilate into reservoirs, which extend beneath the areola and to some distance into the gland, when the breast is in a state of lactation. These are much larger in many of the lower Mammalia than they are in the Human female; their use is to supply the immediate wants of the child when it is first applied to the breast, so that it shall not be disappointed, but shall be induced to proceed with sucking until the draught be occasioned (§ 626). From each of these reservoirs commence five or six main branches of the lactiferous tubes, each of which speedily subdivides into smaller ones; and these again divaricate, until their size is very much reduced, and their extent greatly increased. The proportional size of the trunk and of its branches, appears to follow the same law which governs that of the blood-vessels. The breast is not formed into regular lobes by the ramifications of the ducts; because they ramify between, and intermix with each other so as to destroy

[Fig. 250.

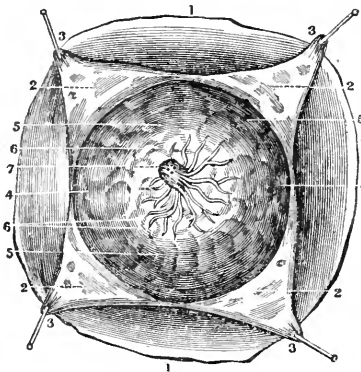

The Mammary Gland after the removal of the skin, as taken from the subject three days after delivery; 1, the surface of the chest; 2, subcutaneous fat; 3, the skin covering the gland; 4, circumference of the gland; 5, its lobules separated by fat; 6, the lactiferous ducts converging to unite in the nipple; 7, the nipple slightly raised and showing the openings of the tubes at its extremity.]

[Fig. 251.

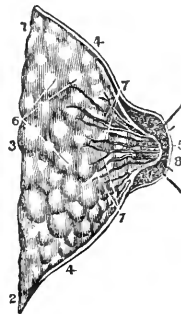

A vertical section of the Mammary Gland, showing its thickness and the origins of the lactiferous ducts; 1, 2, 3 its pectoral surface; 4, section of the skin on the surface of the gland; 5, the thin skin covering the nipple; 6, the lobules and lobes composing the gland; 7, the lactiferous tubes coming from the lobules; 8, the same tubes collected in the nipple.]

Fig. 252.

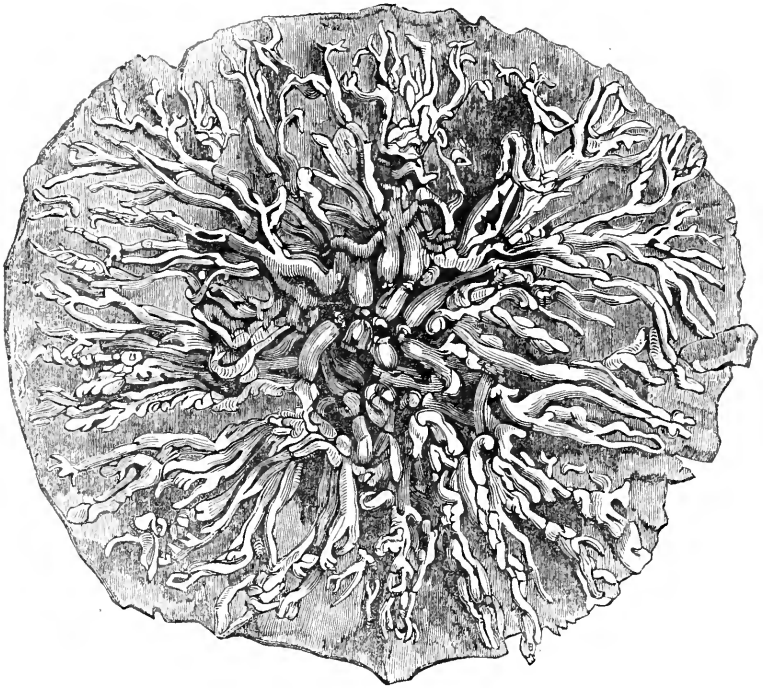

Distribution of the milk-ducts in the Mamma of the Human female, during lactation; the ducts injected with wax.

the simplicity and uniformity of their divisions. It is very rarely, however, that they inosculate. The mammary ducts are composed of a fibrous coat lined by a mucous membrane; the latter is highly vascular, and forms a secretion of its own, which sometimes collects in considerable quantity when the milk ceases to be produced.

b. The gland itself is composed of the union of a number of glandules, which are connected by means of the fibrous or fascial tissue of the gland; it is between these, that the mammary tubes may be observed to ramify; and from them their branches spring. When the glandules are filled with injection, and for a long time macerated in water and unravelled, they are found to be disposed in lobuli; and when a branch of mammary tube is separated, with the glandules attached, the part appears like a bunch of fruit hanging by its stalk. When the lactiferous tube proceeding from a glandule is minutely injected, the latter will be found to be composed of numerous follicles, in which the ultimate ramifications of the former terminate, or rather originate. Their size, in full lactation, is that of a hole

Fig. 253.



Termination of portion of milk-duct in a cluster of follicles; from a mercurial injection; enlarged four times.

Fig. 254.

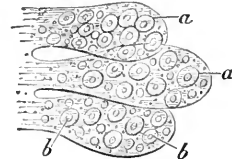

Ultimate follicles of Mammary gland, with their secreting cells, *a, a*;—*b, b*, the nuclei.

pricked in paper by the point of a very fine pin; so that the follicles are, when distended with quicksilver or milk, just visible to the naked eye. At other times, however, the follicles do not admit of being injected, though the lactiferous tubes may have been completely filled. They are lined by a continuation of the same membrane, with that which lines the ducts; and this possesses a high vascularity. The arteries which supply the glandules with blood, become very large during lactation; and their divisions spread themselves minutely on the follicles. From the blood which they convey, the milk is secreted and poured into the follicles, whence it flows into the ducts. From the researches of Mr. Goodsir it appears, that, in common with other glandular structures, the inner surface of the milk-follicles is covered with a layer of epithelium-cells; which, being seen to contain milk-globules, may be without doubt regarded as the real agents in the secreting process. Absorbent vessels are seen to arise in large numbers in the neighbourhood of the follicles; their function appears to be, to absorb the more watery part of the milk contained in the follicles and tubes, so as to render it more nutrient than it is as first secreted; and also to relieve the distention which would occur, during the absence of the child, from the continuance of the secreting process.

c. The Mammary gland may be detected at an early period of fetal existence; being easily distinguishable from the surrounding parts, by the redness of its colour and its high vascularity, especially when the whole is injected. At this period it presents no difference in the male and female; and it is not until near the period of puberty, that any striking change manifests itself,—the gland continuing to grow, in each sex, in proportion to the body at large. About the age of thirteen, however, the enlargement of the gland commences in the Female; and by sixteen years, it is greatly evolved, and some of the lactiferous tubes can be injected. At about the age of twenty, the gland attains its full size previous to lactation; but the milk follicles cannot even then be injected from the tubes. During pregnancy, the mammæ receive a greatly-increased quantity of blood. This determination often commences very early, and produces a feeling of tenderness and distention, which is a valuable sign (where it exists in connection with others) of the commencement of gestation. The Areola at this time becomes darker in its colour, and thicker in substance, and more extended; its papillæ become more developed, and the secretion from its follicles increased. The vascularity of the gland continues to increase during pregnancy; and at the time of parturition, its lobulated character can be distinctly felt. The follicles are not, however, developed sufficiently for injection, until lactation has commenced. After the cessation of the catamenia from age, so that pregnancy is no longer possible, the lactiferous ducts continue open, but the milk follicles are incapable of receiving injection. The substance of the glandules gradually disappears, so that in old age only portions of the ducts remain, which are usually loaded with mucus; but the place of the glandules is commonly filled up by adipose tissue, so that the form of the breast is preserved. Sir A. Cooper notices a curious change, which he states to be almost invariable with age,—namely, the ossification of the arteries of the breast, the large trunks as well as the branches; so that their calibre is greatly diminished, or even obliterated.

d. The Mammary gland of the Male is a sort of miniature picture of that of the female. It varies extremely in its magnitude, being in some persons of the size of a large pea; whilst in others it is an inch, or even two inches in diameter. In its structure it corresponds exactly with that of the female, but is altogether on a smaller scale. It is composed of lobules containing follicles, from which ducts arise; and these follicles and ducts are not too minute to be injected, although with difficulty. The evolution of the gland goes on *pari passu* with that of the body, not undergoing an increase at any particular period; it is sometimes of considerable size in old age. A fluid, which is probably mucus, may be pressed from the nipple in many persons; and this in the dead body, with even more facility than in the living. That the essential character of the gland is the same in the male as in the female, is shown by the instances, of which there are now several on record, in which infants have been suckled by men. The following is given by Dr. Dunglison.* “Professor Hall, of the University of Maryland, exhibited to his Obstetrical class, in the year 1837, a coloured man, fifty-five years of age, who had large, soft, well-formed mammæ, rather more conical than those of the female, and projecting fully seven inches from the chest; with perfect and large nipples. The glandular structure seemed to be exactly like that of the female. This man had officiated as wet-nurse, for several years, in the family of his mistress; and he represented that the secretion of milk was induced by applying the children entrusted to his care to the breasts during the night. When the milk was no longer required, great dif-

* Dunglison's Physiology, [sixth ed., vol. ii. p. 480.] See also the case described by the Bishop of Cork, in the Philosophical Transactions, vol. xli. p. 813; one mentioned by Captain Franklin (Narrative of a Journey to the Polar Sea, p. 157); and one which fell under the notice of the celebrated traveller Humboldt (Personal Narrative, vol. iii. p. 58).

difficulty was experienced in arresting the secretion. His genital organs were fully developed."—Corresponding facts are also recorded of the male of several of the lower animals

854. The secretion of Milk consists of Water holding in solution Sugar, various Saline ingredients, and a peculiar albuminous substance termed Caseine; and having Oleaginous particles suspended in it. The constitution of this fluid is made evident by the ordinary processes, to which it is subjected in domestic economy. If it be allowed to stand for some time, exposed to the air, a large part of the oleaginous globules come to the surface, being of less specific gravity than the fluid through which they are diffused. At the same time there is reason to believe that they undergo a change which will be presently described. The *cream* thus formed does not, however, consist of oily particles alone; but includes a considerable amount of caseine, with the sugar and salts of the milk. These are further separated by the continued agitation of the cream; which, by rupturing the envelopes of the oil-globules, separates it into *butter*, formed by their aggregation, and *butter-milk*, containing the caseine, sugar, &c. A considerable quantity of caseine, however, is entangled with the oleaginous matter; and this has a tendency to decompose, so as to render the butter rancid. It may be separated by melting the butter at the temperature of 180° ; when the caseine will fall to the bottom, leaving the butter pure, and much less liable to change.—The milk, after the cream has been removed, still contains the greatest part of its caseine and sugar. If it be kept long enough, spontaneous change takes place in its composition; the sugar is converted into lactic acid, and this coagulates the caseine, precipitating it in small flakes. The same precipitation may be accomplished at any time, by the addition of an acid; all the acids, however, which act upon albumen, do not precipitate caseine, as will presently be pointed out in detail; the most effectual is that contained in the dried stomach of a calf, known as *rennet*. This exerts so powerful an influence over it, that, according to the experiments of Berzelius, a piece of the membrane coagulated the caseine of 1800 times its weight of milk, with the loss of only 1·17th part of its own weight; so that the active principle, dissolved from the rennet, must have collected the caseine of about 30,000 times its weight of milk. The whey left after the curd has been separated, contains a large proportion of the saccharine and saline matter, entering into the original composition of the milk. This may be readily separated by evaporation.*

a. When Milk is examined with the Microscope, it is seen to contain a large number of particles of irregular size and form, suspended in a somewhat turbid fluid; these particles (according to the measurement of Donné†) vary in size from about the 1-12,700th to the 1-3040th of an inch; and they are termed milk-globules. They are not affected by the mere contact of ether or alkalis; but if these reagents are shaken with them, an immediate solution is the result. The same effect happens, if they are first treated with acetic acid. Hence it is evident, that the globules consist of oily matter, inclosed in an envelope of some kind; and an extremely delicate pellicle may, in fact, be distinguished after the removal of the oily matter by ether; or, after the globules have been ruptured, and their contents pressed out, by rubbing a drop of milk between two plates of glass. No proof of the organization of this pellicle has, however, been detected; and it is probably to be regarded as the simple result of the contact of oil with albuminous matter, which is known to give rise to a membranous film.—Besides these milk-globules, other globules of much smaller size are seen in milk; and these present the peculiar movement, which is exhibited by molecules in general. Most of them seem to consist of oily matter, not inclosed in an envelope, as they are at once dissolved, when the fluid is treated with ether; but, according to the statements of Donné, it would seem that a portion of them are composed of caseine, suspended, not dissolved, in the fluid. It may be reasonably doubted, however, whether these were not in

* A considerable quantity is thus obtained for household purposes in Switzerland.

† Cours de Microscopie, Douzième Leçon.

a state of change; whether from their own decomposition, or from incipient coagulation; either of which might have taken place during the processes of filtration, &c., that were required to determine their nature. In addition to the foregoing particles, there are found in the *Colostrum*, or milk first secreted after delivery, large yellow granulated corpuscles, which are described by *Donné* as composed of a multitude of small grains aggregated together, and frequently including a true globule of milk in their centre: these are for the most part soluble in ether; but traces of some adhesive matter, probably mucus, holding together the particles, are then seen. They are considered by some as exudation-corpuscles; to which they certainly bear a close resemblance. Lamellæ of epithelium are also found in the milk.—All the larger globules may be removed by repeated filtration; and the fluid is then nearly transparent. This, in fact, is the simplest way of separating the oleaginous from the other constituents of the milk; as little caseine then adheres to the former. That the transparent fluid which has passed through the filter contains nearly the whole amount of the caseine of the milk, appears a sufficient proof that this is, for the most part, truly dissolved in the fluid.

b. We shall now consider the chemical characters of each of the foregoing ingredients.—The *Oleaginous* matter of milk principally consists, like fatty matter in general, of the two substances, elaine and stearine; which are converted in the process of saponification into the elaic, stearic, and margaric acids: but it also contains another substance peculiar to it, which yields in saponification three volatile acids, of strong animal odour, to which *Chevreul* has given the names of butyric, caproic, and capric acids; whilst the fatty substance itself, to which the peculiar smell and taste of butter are due, is designated as *butyrine*. The peculiar acids are not only formed when the butyrine is treated with alkalis; but are produced by the ordinary decomposition of this principle, which is favoured by time and moderate warmth.—The *Caseine* or cheesy matter of milk, which is obtained with some slight admixture of fatty matter in the production of cheese from skimmed milk, is chiefly distinguished from Albumen, by the peculiar readiness with which it is precipitated by feeble organic acids, such as the lactic and acetic; and by its non-coagulability by heat alone. The Caseine of Human milk, however, is much less precipitable by acids, than is that of the Cow; very commonly resisting the action of the mineral acids, and even that of the acetic; but being always coagulated by rennet, though the curd is long in collecting. It is remarked by *Dr. G. O. Rees*,* that the caseine of human milk thus bears somewhat the same relation to that of the cow, that the albumen of chyle bears to that of the blood.—The *Sugar* of milk, which may be obtained by evaporating whey to the consistency of a syrup and then setting it aside to crystallize, contains a large proportion (12 per cent.) of water, so that it may be considered as really a hydrate of sugar; it is nearly identical in its composition with starch, and may, like it, be converted into true sugar by the action of sulphuric acid; and when in contact with a ferment, or decomposing azotized compound, it is extremely prone to be converted into lactic acid, by appropriating to itself the elements of water. It is, in fact, through this process, that the coagulation of the caseine is effected, by means of rennet; for as soon as a very minute quantity of lactic acid is generated, it withdraws from the caseine the free alkali which kept it in solution, and the caseine is consequently precipitated. The same effect will be produced by incipient decomposition of the caseine itself; which will soon occasion lactic acid to be generated from the sugar, in sufficient quantity to give to the milk a distinctly acid reaction.—The *Saline* matter contained in milk, appears to be nearly identical with that of the blood; with a larger proportion of the phosphates of lime and magnesia, which amount to 2 or 2½ parts in 1000. These phosphates are held in solution chiefly by the Caseine; which seems to have a power of combining with them, even greater than that of Albumen: the presence of a minute proportion of free alkali, also, assists their solution. A small portion of iron in the state of phosphate, together with the chlorides of potassium and sodium, may also be detected in milk.†

855. The proportion of these different constituents is liable to great variation, from several causes. Thus, the whole amount of the solid constituents may vary from 86 to 138·6 parts in 1000; the difference being partly due to individual constitution, but in great part, also, to the amount and character of the ingesta. The average seems to be between 100 and 120 parts. The following are the results of the analyses of *Simon*; the first column being the average of fourteen observations upon the same woman; the second giving the maximum of each ingredient; and the third the minimum:—

* *Art. MILK*, in the *Cyclopædia of Anatomy and Physiology*.

† *Haidlen*, in *Annalen der Chemie und Pharmacie*, xlv. p. 263.

	I.	II.	III.
Water	883·6	914·0	861·4
Butter	25·3	54·0	8·0
Caseine	34·3	45·2	19·6
Sugar of Milk and Extractive Matters	48·2	62·4	39·2
Fixed salts	2·3	2·7	1·6

It also appears from the analyses of Simon, that the proportion of the different ingredients is liable to variation, according to the time which has elapsed since parturition. The quantity of Caseine is at its minimum at the commencement of lactation, and then gradually rises until it attains a nearly fixed proportion. The quantity of Sugar, on the contrary, is at its maximum at first, and gradually diminishes. The amount of Butter (as appears from the wide extremes shown in the above tables) is more variable than that of any other constituent—That some of the variations are due, moreover, to the character of the ingesta, and others to the external temperature, amount of exercise, and other circumstances affecting the individual, is proved by the recent inquiries of Dr. Playfair upon the Milk of the Cow. He has shown that the amount of butter depends in part upon the quantity of oily matter in the food; and in part upon the amount of exercise which the animal takes, and the warmth of the atmosphere in which it is kept. Exercise and cold, by increasing the respiration, eliminate part of the oily matter in the form of carbonic acid and water; whilst rest and warmth, by diminishing this drain, favour its passage into the milk.—The proportion of Caseine, on the other hand, is increased by exercise; which would seem to show that this ingredient is derived from the disintegration of Muscular tissue,—and thus adds strength to the Author's view (§ 681) that of the matter thus set free, a part only is destined to immediate excretion, and that a part may again be subservient to the operations of Nutrition. Dr. Playfair's experience on this head seems to correspond with the results of common observation in Switzerland, where they pasture cattle in very exposed situations, and are obliged to use a great deal of muscular exertion. The quantity of Butter yielded by them is very small; whilst the Cheese is in unusually large proportion. But these very cattle, when stall-fed, give a large quantity of Butter and very little Cheese.

856. The change which naturally takes place, from the condition of Colostrum to that of true Milk, during the first week of lactation, is a very important one. The Colostrum has a purgative effect upon the child, which is very useful in clearing its bowels of the meconium that loads them at birth; and thus the necessity of any other purgative is generally superseded. Occasionally, however, the *colostric* character is retained by the milk, during an abnormally long period; and the health of the infant is then severely affected. It is important to know that this may occur, even though the milk may present all the usual appearances of the healthy secretion; but the microscope at once detects the difference.* The return to the character of the early milk, which has been stated to take place after the expiration of about twelve months, seems to indicate that Nature designs the secretion no longer to be encouraged. The mother's milk cannot then be so nutritious to the child as other food;† and every medical man is familiar with the injurious consequences, to which she renders herself liable by unduly prolonging lactation.‡

* See Donn , "Du Lait, et en particulier celui des Nourrices;" and Brit. and For. Med. Review, vol. vi. p. 181.

† On the whole subject of Infant Nutrition, the Author would strongly recommend the excellent little work of Dr. A. Combe, formerly referred to.

‡ One of these, which has particularly fallen under the Author's notice, is debility of the

857. It is very interesting to observe that Milk contains the three classes of principles which are required for human food,—the Albuminous, Oleaginous, and Saccharine; and it is the only secreted fluid, in which these all exist in any considerable amount. It is, therefore, the food most perfectly adapted for the young animal; and is the only single article supplied by nature, in which such a combination exists. Our artificial combinations will be suitable to replace it, just in proportion as they imitate its character; but in none of them can we advantageously dispense with milk, under some form or other. It should be remembered that the saline ingredients of Milk, especially the phosphates of lime, magnesia, and iron, have a very important function in the nutrition of the infant,—affording the material for the consolidation of its bones, and for the production of its red blood-corpuscles; and any fluid substituted for milk, which does not contain these, is deficient in essential constituents. It is very justly remarked by Dr. Rees, that of all the secreted fluids, Milk is most nearly allied in its composition to blood.

858. The proportion of the different ingredients in the Milk of different animals, is subject to considerable variation: and this fact is of much practical importance in guiding our selection, when good Human milk cannot be conveniently obtained for the nourishment of an infant. The first point to be inquired into, is the quantity of solid matter contained in each kind; this may be determined either by evaporation, or by the specific gravity of the fluid. The Specific Gravity of Human milk is stated by Dr. Rees to vary between 1030 and 1035; others, however, have estimated it much lower. That of the Cow appears to be usually about the same; that of the cream, however, being 1024, and that of the skimmed milk about 1035. The variation will in part depend (as in the case of the urine) upon the quantity of fluid ingested, and in part, it is probable, upon the manner in which the milk is drawn; for it is well known to milkers, that the last milk they obtain is much richer than that with which the udder is distended at the commencement. The quantity of solid matter, obtainable from Human and from Cow's Milk by evaporation, seems, like the specific gravities of the fluids, to be nearly the same. In the relative proportion of the ingredients, however, there is a considerable difference; there being much more sugar, and less caseine in Human Milk than in that of the Cow. The following table exhibits the relative proportion of the different ingredients, in the Milk of various animals, from which it is commonly obtained:—

	Cow.	Goat.	Sheep.	Ass.	Mare.
Water	861.0	868.0	856.2	907.0	896.3
Butter	38.0	33.2	42.0	12.10	traces
Caseine	68.0	40.2	45.0	16.74	16.2
Sugar of Milk and Extractive Matters	29.0	52.8	50.0	62.31	87.5
Fixed Salts	6.1	5.8	6.8		

It appears from this, that, whilst the milk of the Cow, Goat, and Sheep do not differ from each other in any very prominent degree, that of the Ass and Mare is a fluid of very dissimilar character, containing a comparatively small proportion of caseine and butter, and abounding in sugar. Hence it is, that it is much more disposed to ferment than other milk; indeed the sugar of Mare's milk is so abundant, that the Tartars prepare from it a spirituous liquor, to which they give the name of *koumiss*. It appears from these details that no milk more nearly approaches that of the Human female, than that of the Sheep and Goat; these both possess, however, a larger proportion of caseine, which forms a peculiarly dense curd; and the milk of the Goat

retina, sometimes proceeding to complete amaurosis; this, if treated in time, is most commonly relieved by discontinuance of lactation, generous diet, and quinine.

is tainted with the peculiar odour of the animal, which is more intense if the individual be dark-coloured. The milk of the Cow will usually answer very well for the food of the infant; care being taken to dilute it properly, according to the age of the child, and to add a little sugar. It is an interesting circumstance, lately ascertained, that the milk of Carnivorous Mammals, fed exclusively on animal diet, contains scarcely a trace of sugar, whilst the caseine and butter are abundant.

859. From what has been stated of the close correspondence between the elements of the Blood and those of the Milk, it is evident that we can scarcely expect to trace the existence of the latter, as such, in the circulating fluid. To what degree the change, in which their elaboration consists, is accomplished in the Mammary gland, or during the course of the circulation, there is no certain means of ascertaining. The recent discovery of the usual presence of the organic compound named *kiesteine* (which is nearly related to caseine), in the urine of pregnant women, seems to indicate that the conversion of albumen into caseine takes place in the blood,—this curious excretion being the means of preventing its accumulation in the circulating fluid, previously to the time when it is secreted by the mammæ.* It is evident that this secretion cannot serve as the channel for the deportation of any element, the accumulation of which would be injurious to the system; since it does not occur in the male at all; and is present in the female at particular times only. Yet there is reason to believe that if, whilst the process is going on, it be suddenly checked, the retention of the material in the blood, or the reabsorption of the secreted fluid, is attended with injurious consequences. Thus if, when the milk is first secreted, the child be not put to the breast, an accumulation takes place, which, if not relieved, occasions great general disturbance of the system. The narrowness of the orifice of the milk-tubes obstructs the spontaneous exit of the fluid, especially in *primiparæ*; the reservoirs and ducts become loaded; further secretion is prevented; and a state of congestion of the vessels of the gland, tending to inflammation, is induced. The accompanying fever is partly due, no doubt, to the local disturbance; but in part also, there seems reason to believe, to the reabsorption of the milk into the blood; this cannot but be injurious, since, although but little altered, the constitution of milk is essentially different, especially in regard to the quantity of crystallizable matter (sugar) which it contains. The instances of the vicarious secretion of milk are not numerous; and in no instance is there any proof that the elements of the fluid were pre-existent in the blood. Some of the most curious are those in which it has been poured out from a gland in the groin; but it is probable that this was in consequence of the existence of a real repetition, in that place, of the true mammary structure,—this being the situation of the mammæ of many of the inferior animals, of which the analogues in Man are usually undeveloped.

a. The following is a more unequivocal case of vicarious secretion; and it is peculiarly interesting as exhibiting the injurious effects of the re-absorption of the secretion, and the relief which the system experienced when it was separated from the blood by the new channel. “A lady of delicate constitution (with a predisposition to pneumonia) was prevented from suckling her child, as she desired, by the following circumstance. Soon after her delivery she had a severe fever, during which her breasts became very large and hard; the nipples were swollen and firm; and there was evidently an abundant secretion of milk; but neither the sucking of the infant, nor any artificial means, could draw a single drop of fluid from the swollen glands. It was clear that the milk-tubes were closed; and as the breasts continued to grow larger and more painful, purgatives and other means were employed to check the secretion of milk. After three days the fever somewhat diminished, and was replaced by a constant cough, which was at first dry, but soon after was followed

* See Dr. Golding Bird, in *Guy's Hosp. Rep.*, vol. v.

by the expectoration of simple mucus. After this, the cough diminished in severity, and the expectoration became easy; but the sputa were no longer mucous, but were composed of a liquid, which had all the physical characters of genuine milk. This continued for fifteen days; the quantity of milk expectorated amounting to three ounces or more in the twenty-four hours. The breasts gradually diminished in size: and by the time that the expectoration ceased, they had regained their natural dimensions. The same complete obstacle to the flow of milk from the nipples recurred after the births of four children successively, with the same sequelæ. After the sixth, she had the same symptoms of fever, but this time they were not followed by bronchitis or the expectoration of milk; she had in their stead copious sweatings, which, with other severe symptoms, reduced her to a cachectic state, and terminated fatally in a fortnight.*

860. Of the quantity of Milk ordinarily secreted by a good Nurse, it is impossible to gain any definite idea; as the amount which can be artificially drawn, affords no criterion of that which is secreted at the time of the *draught* (§ 626). The quantity which can be squeezed from either breast at any one time, and which, therefore, must have been contained in its tubes and reservoirs, is about two ounces. The amount secreted is greatly influenced by the mental and physical condition of the female, and also by the quantity and character of the ingesta. In regard to the influence of the mental state upon this secretion, ample details have already been given (Chap. ix.). With respect to the physical state most favourable to the production of an ample supply of this important fluid, it may be stated generally, that sound health, a vigorous but not plethoric constitution, regular habits, moderate but not fatiguing exercise, and an adequate but not excessive amount of nutritious food, furnish the conditions most required. It is seldom that stimulating liquors, which are so commonly indulged in, are anything but prejudicial; but the unmeasured condemnation of them in which some writers have indulged, is certainly injudicious; as experience amply demonstrates the improvement in the condition both of mother and infant, which occasionally results from the moderate employment of them.

861. The influence of various Medicines upon the Milk, is another important question, which has not yet been sufficiently investigated. As a general rule, it appears that the most soluble saline compounds pass into the milk as into other secretions; but there are many exceptions. Common salt, the sesqui-carbonate of soda, sulphate of soda, iodide of potassium, oxide of zinc, tris-nitrate of bismuth, and sesqui-oxide of iron, have been readily detected in the milk, when these substances were experimentally administered to an ass; and ordinary experience shows, that the human infant is affected by many of these, when they are administered to the mother. The influence of mercurial medicines taken by the mother, in removing from the infant a syphilitic taint possessed by both, is also well known. The vegetable purgatives, especially castor oil, senna, and colocynth, have little effect upon the milk; hence they are to be preferred to the saline aperients, when it is not desired to act upon the bowels of the child.

5.—*Salivary Glands and Pancreas.*

862. The structure of the *Salivary Glands* and *Pancreas* in Man, bears considerable resemblance to that of the Mammary glands. In some of the lower tribes, however, they are much simpler. Thus, in the Echinodermata and in Insects, the Salivary glands have the character of prolonged cœca, more or less convoluted; and the Pancreas of Fishes presents itself in the form of a cluster of short cœca round the pyloric extremity of the stomach, and opening into it by distinct orifices. The accompanying figure will give

* *Bulletino delle Scienze Mediche*, Apr. 1839; and *Brit. and For. Med. Review*, Jan. 1840.

Fig. 255.

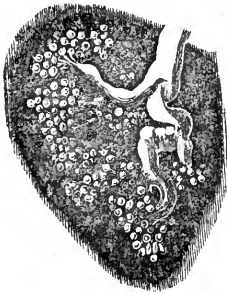

Lobule of Parotid gland of a new-born infant injected with mercury. Magnified 50 diam.

Fig. 256.

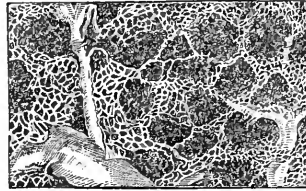

Distribution of Capillaries around the follicles of Parotid Gland.

a sufficient idea of the structure of these glands in Man; the follicles are very minute, having a diameter only about three times greater than that of the capillary blood-vessels. Their development commences from a simple canal, sending off bud-like processes, which opens from the mouth, and lies amidst a cellular blastema. As development proceeds, the canal becomes more and more ramified, and communicates with the enlarged parent-cells of the blastema, which remain as the terminal follicles of the branches of the gland-duct (§ 823).

Fig. 257.

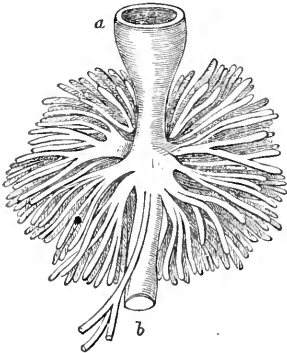

Rudimentary Pancreas from Cod:—
a, pyloric extremity of stomach; b, intestine.

863. The Salivary secretion is by no means necessarily constant; being almost or completely suspended by cessation of the movement of the masticator muscles and tongue, if unexcited by any nervous stimulus. Hence it is, that the secretion is checked during sleep; so that, if the mouth be kept open, its surface is almost dried up by the atmosphere. The mode in which the secretion is excited through

the influence of the nervous system has already been considered (§§ 625, 626). The quantity of Saliva formed during the twenty-four hours has been estimated at about 15 or 20 ounces; but on this point it is evidently impossible to speak with certainty. The fluid obtained from the mouth is of a more viscous character than the true saliva secreted by the glands; being mingled with mucus. The salivary fluid varies as to its chemical reaction; being sometimes slightly acid, and sometimes slightly alkaline; but it is seldom precisely neutral. According to Huenefeld, it will at the same time strike a blue colour with reddened litmus-paper; and turn blue litmus-paper red; but the saliva examined directly before, and during, the act of eating, is always alkaline. It seems probable that the acid reaction is due to the mucus of the mouth; which, at times when only a small amount of saliva is excreted, is not neutralized by its alkali. The specific gravity of Saliva varies from 1·006 to 1·009. It contains a small number of corpuscles, which seem to be partly epithelium-cells from the mucous surface of the mouth, and partly the secreting cells of the salivary vesicles. The solid matter contained in Saliva amounts to from 10 to 13 parts in 1000. The animal principles of which

this is composed are Albumen, Mucus, and a peculiar substance termed Ptyalin, which is soluble in water, insoluble in alcohol, and yet is different either from albumen or gelatin. A considerable proportion of saline and earthy matter exists in the solid residue of saliva; this is nearly of the same character as that which the blood contains, being chiefly composed of the phosphate of lime and soda, the chlorides of sodium and potassium, and the lactates of soda and potash. One remarkable property of the salivary secretion, is its formation of a rust-red precipitate when mixed with a solution of persalt of iron. This is supposed to be due to the presence in it of the principle termed sulpho-cyanogen. The tartar which collects on the human teeth consists principally of the earthy phosphates, the particles of which are held together by about 20 per cent. of animal matter; and nearly the same may be said of the salivary concretions which occasionally obstruct the ducts.—It appears from various recent experiments, that the peculiar animal matter of the Saliva has a decided effect in metamorphosing certain alimentary substances, and thus performs the first part of the digestive process. Starch may be converted into sugar, and sugar into lactic acid, by its agency; and if acidulated, it has a solvent power for caseine, animal flesh, and other albuminous substances (§ 669).

864. The Pancreatic Secretion of Man cannot, of course, be readily obtained for analysis; that which is procured from the lower animals, however, probably gives a sufficiently correct idea of its character. It seems to be of a nearly similar nature with saliva, but usually contains a much larger proportion of solid matter; in that of the Dog as much as 87 parts in 1000 have been found; and in that of the Sheep, 40 parts. The probable offices of this secretion in the digestive process, have been already noticed (§§ 669, 670).

6.—*Lachrymal Gland.*

865. The *Lachrymal* glands and their secretion may be next mentioned; but neither require any lengthened description. The gland in Man is formed very much on the plan of the Parotid, being composed of branched canals terminating in follicles, the ultimate ramifications of the several branches forming lobules or divisions of the glands. The lachrymal fluid has not recently undergone any accurate analysis; and all that can be stated respecting it is the general fact, that the quantity of solid matter in it is extremely small, and that this consists chiefly of saline, and either mucous or albuminous compounds. It seems probable that the secretion of the lachrymal gland itself is very little else than the serum of the blood, deprived of a great part of its albumen; and that the mucus of the tears is secreted from the surface of the conjunctival membrane. This secretion has a slightly alkaline reaction. It is being constantly formed in moderate amount, for the purpose of cleansing the surface of the eye from the impurities which would otherwise rest upon it; and it is then absorbed by the open orifices of the nasal duct, and carried into the nose, as fast as it is poured out. The cause of this absorption does not seem very clear. Capillary attraction is probably in part concerned; and it has been thought that the momentary partial vacuum, occasioned by the inspiratory effort in all the air-passages, will cause the emptying of the nasal duct below, and a consequent in-draught above. The influence of the nervous system upon this secretion has been already adverted to (§§ 625, 626).

7.—*The Testis.—Spermatic Fluid.*

866. In the Testes we return to the tubular form of glandular structure, which so remarkably distinguishes the Kidney from all the other glands

hitherto mentioned. The external forms presented by these glands throughout the Animal kingdom, are extremely various; but their composition is for the most part very uniform. The object is sometimes attained by a simple but much elongated canal; sometimes by shorter branched tubes; and in other instances, again, by numerous aggregated cœca, which are often rounded into cells. In regard to this, as to many other glands, it may be stated that, whilst its general form in Insects is that of prolonged tubes, the required extension of surface is given in the Mollusca by the multiplication of cells, so that the structure has a compact spongy character. It is interesting to remark that, in some of the lowest Fishes, this organ consists of a mass of vesicles which have no efferent duct; and that the secretion formed within these escapes by the rupture of the vesicles, allowing it to escape into the abdominal cavity, whence it passes by openings that lead directly to the exterior. In these Fishes, the ova are discharged from the ovarium in a very similar manner; a modification of which plan is followed in all the higher Vertebrata,—the ovum being in them also discharged, by the rupture of its containing vesicle or ovisac, into the abdominal cavity, but being immediately received and conveyed away by the funnel-shaped internal prolongation of the external orifice, which is known as the fimbriated extremity of the Fallopian tube.*

a. The Testis in Man has in every respect, however, a distinctly glandular character. It consists of several lobules, which are separated from each other by processes of the tunica albuginea that pass down between them, and also by an extremely delicate membrane (described by Sir A. Cooper under the name of tunica vasculosa) consisting of minute ramifications of the spermatic vessels united by areolar tissue. Each lobule is composed of a mass of convoluted Tubuli Seminiferi, throughout which blood-vessels are minutely distributed.

[Fig. 258.

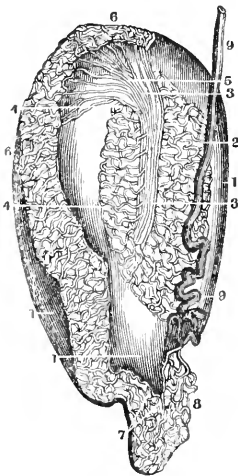

The Testicle injected with mercury; 1, tunica albuginea; 2, seminiferous tubes; 3, the rete vasculosum testis; 4, a globule of mercury which has ruptured the tubes; 5, the vasa efferentia which form the coni vasculosi, 6, coni vasculosi forming the head of the epididymis; 7, epididymis; 8, globus minor of the epididymis; 9, vas deferens.]

[Fig. 259.

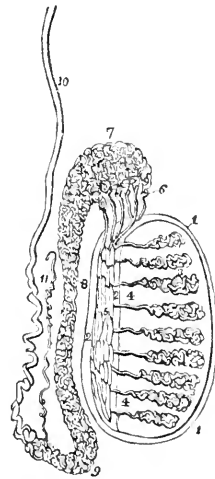

A view of the minute structure of the Testis; 1, 1, tunica albuginea; 2, 2, corpus highmorianum; 3, 3, tubuli seminiferi convoluted into lobules; 4, 4, vasa recta; 5, rete testis; 6, vasa efferentia; 7, coni vasculosi constituting the globus major of the epididymis; 8, body of the epididymis; 9, its globus minor; 10, vas deferens 11, vasculum aberrans or blind duct.]

* See Principles of General and Comparative Physiology, § 641.

The lobules differ greatly in size, some containing one, and others many of the tubuli; the total number of the lobules is estimated at about 450 in each testis, and that of the tubuli at 840. The convolutions of the tubuli are so arranged, that each lobule forms a sort of cone, the apex of which is directed towards the Rete Testis. It is difficult to trace the free extremities of the Seminiferous tubes, owing to the frequency of their anastomoses with each other; in this respect, therefore, the structure of the testis accords closely with that of the

Fig. 260.

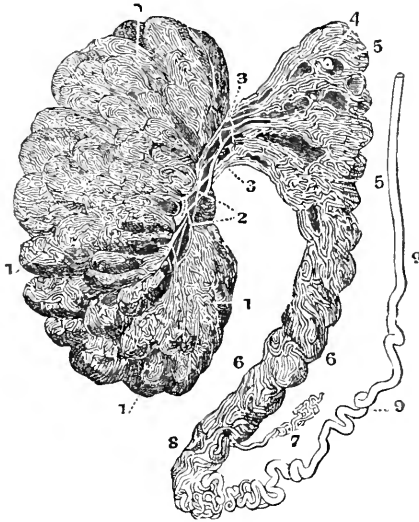

Human Testis, injected with mercury as completely as possible; 1, 1, lobules formed of the seminiferous tubes; 2, rete testis; 3, vasa efferentia; 4, flexures of the efferent vessels passing into the head, 5, 5, of the epididymis; 6, body of the epididymis; 7, appendix; 8, cauda; 9, vas deferens.

Fig. 261.

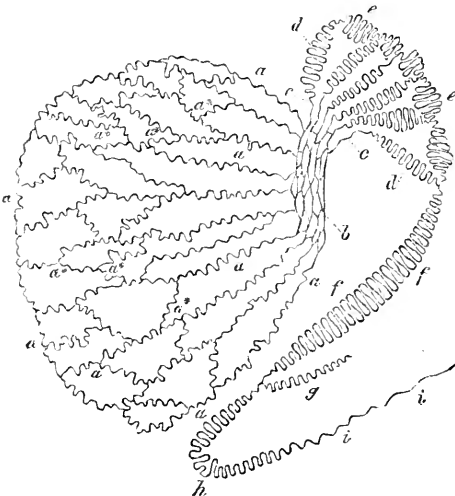

Plan of the structure of the Testis and Epididymis; a, a, seminiferous tubes; a*, a*, their anastomoses; the other references as in the last figure.

Kidney. The diameter of the Tubuli is for the most part very uniform; in the natural condition they seem to vary from about the 1-195th to the 1-10th of an inch; but when injected with mercury they are distended to a size nearly double the smaller of these dimensions. When they have reached to within a line or two of the Rete Testis, they cease to be convoluted, several unite together into tubes of larger diameter, and these enter the rete testis under the name of *tubuli recti*. The *rete testis* consists of from seven to thirteen vessels, which run in a waving course, anastomose with each other, and again divide, being all connected together. The *vasa efferentia* which pass to the head of the epididymis are at first straight, but soon become convoluted, each forming a sort of cone, of which the apex is directed towards the rete testis, the base to the head of the epididymis. The number of these is stated to vary from nine to thirty; and their length to be about eight inches. The *epididymis* itself consists of a very convoluted canal, the length of which is about twenty-one feet. Into its lower extremity, that is, the angle which it makes where it terminates in the vas deferens, is poured the secretion of the *vasculum aberrans* or appendix; which seems like a testis in miniature, closely resembling a single lobule in its structure. Its special function is unknown.

b. The Testicles originate, in the Embryo, from the lower part of the Corpora Wolffiana (§ 839, c); arising from their lower and inner sides, whilst the Kidneys spring from their upper and outer parts. They make their first appearance in the Chick about the fourth day, as delicate striæ on the Wolffian bodies; and at this period no difference can be detected between the Testes and the Ovaria, which originate in precisely the same manner. Like the kidneys, the germ-preparing organs increase in proportion with the diminution in the temporary structures, at first their efferent ducts open into those of the Wolffian bodies, but they are subsequently separated by the formation of a partition, like that which separates the rectum from the cloaca. In the Human embryo, the rudiments of the sexual organs,—whether testes or ovaria,—first present themselves soon after the kidneys make their appearance, that is, towards the end of the seventh week. They are at first much prolonged, and seem to consist of a kind of soft, homogeneous blastema, in which the tubular structure subsequently develops itself. The Ovary at that period has the same aspect and texture; but its subsequent course of development is different. The Testis gradually assumes its permanent form; the epididymis appears in the tenth week; and the gubernaculum, (a membranous process from the filamentous tissue of the scrotum, analogous to the round ligament arising from the labium, and attached to the ovary, of the female,) which is originally attached to the vas deferens, gradually fixes itself to the lower end of the testis or epididymis. The Testes begin to descend at about the middle period of pregnancy; at the seventh month they reach the inner ring; in the eighth they enter the passage; and in the ninth they usually descend into the scrotum. The cause of this descent is not very clear. It can scarcely be due merely, as some have supposed, to the contraction of the gubernaculum; since that does not contain any fibrous structure, until after the lowering of the testes has commenced. It is well known that the testes are not always found in the scrotum at the time of birth, even at the full period. Upon an examination of 97 new-born infants, Wrisberg found both testes in the scrotum in 67,—one or both in the canal in 17,—in 8 one testis in the abdomen,—and in 3 both testes within the cavity. Sometimes one or both testes remain in the abdomen during the whole of life; but this circumstance does not seem to impair their function. This condition is natural, indeed, in the Ram.

867. The fluid secreted by the Testes is thick, tenacious, and of a greyish or yellowish colour. It is mingled, during or before emission, with fluid secreted by the Prostate, Cowper's glands, &c.; and it cannot, therefore, be obtained pure, but by drawing it from the testicle itself; hence no accurate analysis can be made of it in the Human subject. The so-called Spermatozoa and Seminal Granules, which form the most important and characteristic parts of the Semen, are so intimately connected with the Reproductive Function, that they will be more appropriately described under that head. It may be here remarked, however, that they correspond most exactly with other Secretions, in their mode of production; for, as will be shown hereafter, they are elaborated by cells, which lie within the tubuli, and which rupture so as to set them free, when they are mature (§ 902). The peculiar odour which the Semen possesses, does not appear to belong to the proper spermatic fluid; but is probably derived from one or other of the secretions with which it is mingled. The chemical analyses which have been made of this fluid are all defective, inasmuch as they do not distinguish the real secretion of the testes from the mucus, prostatic fluid, &c., with which it is mingled. It may be stated, however, that

it has an alkaline reaction, and contains albumen, with a peculiar animal principle termed Spermatine; and also saline matter, consisting chiefly of muriates and phosphates, especially the latter, which form crystals when the fluid has stood for some little time.

8.—*Cutaneous and Mucous Follicles.*

868. Having now described the structure and functions of the principal Glands, which are composed of aggregated masses of secreting cells or tubes, we may proceed to those in which the *glandulæ* are more scattered, but are still, in their aggregate amount, of sufficient importance to claim particular notice. This is especially the case in the Skin, and its internal prolongations, forming Mucous Membranes. The Skin is the seat of various secretions; for each of which it is provided with special organs. Of these the most important is the Perspiration; which is formed in small glandular organs seated just beneath the cutis, and diffused over the whole surface of the body. The efferent ducts of these *Glandulæ* open by minute pores in the Epidermis, which are seen in elevated lines on the skin of the palm of the hand and the sole of the foot; they penetrate the epidermis rather obliquely, so that a sort of little valve is formed by it, which is lifted up by the excreted fluid as it issues. The ducts pass through the Epidermis and Cutis in a spiral direction; and then enter the glands, which consist of the convolutions of the ducts, more or less subdivided, on which blood-vessels are distributed. Where the Epidermis is thin, the canal is straighter.—On the palm of the hand, the sole of the foot, and the extremities of the fingers, the apertures of the perspiratory ducts are visible to the naked eye; being situated at regular distances along the little ridges of sensory papillæ, and giving to the latter the appearance of being crossed by transverse lines. According to Mr. Erasmus Wilson,* as many as 3528 of these *glandulæ* exist in a square inch of surface on the palm of the hand; and as every tube, when straightened out, is about a quarter of an inch in length, it follows that, in a square inch of skin from the palm of the hand, there exists a length of tube equal to 883 inches, or 73½ feet. The number of *glandulæ* in other parts of the skin, is sometimes greater, but generally less than this; and according to Mr. Wilson, about 2800 may be taken as the average number of pores in each square inch throughout the body. Now the

Fig. 262.

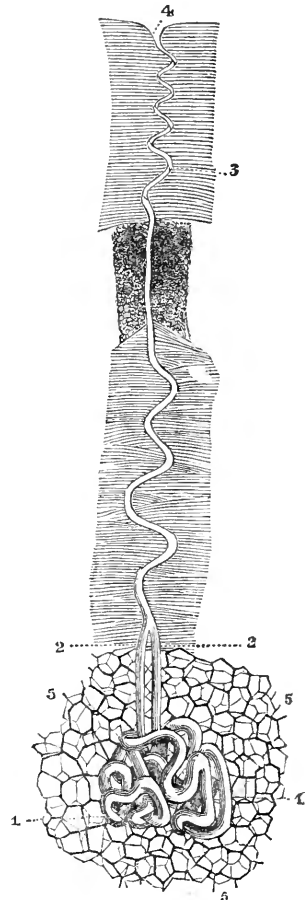

Sudoriferous Gland from the palm of the hand, magnified 40 diameters; 1. 1. contorted tubes, composing the gland, and uniting into two excretory ducts, 2. 2, which unite into one spiral canal, that perforates the epidermis at 3, and opens on its surface at 4; the gland is imbedded in fat-vesicles, which are seen at 5, 5.

* Practical Treatise on Healthy Skin, p. 42.

[Fig. 263.]

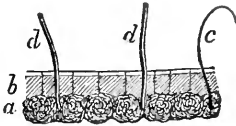

Vertical section of the skin and sweat-glands of the axilla;—*a*. Layer of glands with their ducts traversing *b*, the cutis and cuticle. *c*. Small hair. *d*, *d*. Portions of larger hairs.—Magn. one and a half diam.]

[Fig. 264.]

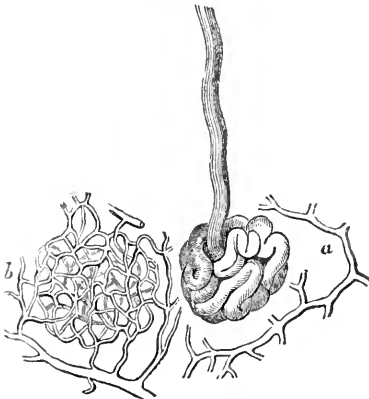

Sweat-gland and the commencement of its duct:—*a*. Venous radicles on the wall of the cell in which the gland rests. This vein anastomoses with others in the vicinity. *b*. Capillaries of the gland separately represented, arising from their arteries, which also anastomose. The blood-vessels are all situated on the outside or deep surface of the tube, in contact with the basement-membrane.—Magn. 35 diam.]

[Fig. 265.]

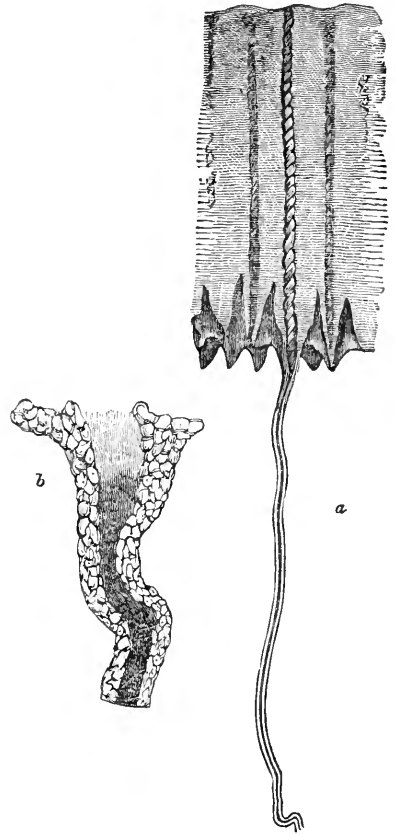

a. Vertical section of the cuticle from the heel, detached by maceration. The epithelium of the sweat-duct, continuous with the cuticle, has been drawn out of the tube of basement-membrane, as far as the gland, where it begins to be contorted. The cavity of the duct is seen dilating as it enters the cuticle, and then stretching up to the surface through the epidermic lamina. The deep surface of the duct is continuous with the surface of the cavities in which the papillæ are lodged.—Magn. 35 diameters.

b. Duct at its entrance into the cuticle.—More highly magnified.]

number of square inches of surface, in a man of ordinary stature, is about 2500; the total number of pores, therefore, may be about *seven millions*; and the length of the perspiratory tubing would thus be 1,750,000 inches, or 145,833 feet, or 48,611 yards; or nearly 28 miles.

869. The Secretion of fluid by these Glands is continually taking place; but this fluid, being usually carried off in the form of vapour as fast as it is separated, does not accumulate and become sensible. If, however, from the increased amount of the secretion, or from the condition of the surrounding air, the whole fluid thus poured out should not evaporate, it accumulates in

minute drops upon the surface of the skin. Thus the Sudoriferous excretion may take the form either of *sensible* or *insensible* transpiration; the latter being constant, the former occasional. It is difficult to obtain enough of this secretion for analysis, free from the sebaceous and other matters which accumulate on the surface of the skin; and its character can only, therefore, be stated approximately. It has usually an acid reaction, which seems due to the presence of acetic acid; and to this, or to lactic acid, we are probably to attribute the sour smell which it has, especially in some disordered states of the system. The proportion of solid matter, according to Anselmino, varies between 5 and 12.5 parts in 1000. The greatest part of it consists of animal matter, which is apparently a proteine-compound in a state of incipient decomposition. The remainder consists of saline compounds; of which the chlorides of potassium and sodium appear to be pretty constantly present; whilst the muriate of ammonia, free acetic acid, and acetate of soda, have also been said to occur in it.—The proportion of these ingredients would probably be found larger in the fluid of the Sudoriferous glands, if we had the means of collecting it separately; for of the whole fluid which passes off from the surface of the skin, only a small proportion can be properly said to be *secreted* by the Sudoriferous glands; the greater part, under ordinary circumstances, being the product of simple Evaporation, by which, of course, nothing but pure watery vapour is dissipated.

870. The entire amount of fluid which is insensibly lost from the Cutaneous and Pulmonary surfaces, is estimated by Seguin at 18 grains per minute; of which 11 grains pass off by the skin, and 7 by the lungs. The maximum loss by Exhalation, cutaneous and pulmonary, during twenty-four hours, (except under very peculiar circumstances,) is 5 lbs.; the minimum $1\frac{3}{4}$ lb. It varies greatly, according to the condition of the atmosphere, and that of the body itself. The manner and degree in which it is influenced by atmospheric conditions, will be better discussed under the head of Animal Heat (§ 897); since this influence has a most important effect in the regulation of the temperature of the body. As already pointed out, the Urinary excretion is in great degree vicarious with it, in regard to the amount of fluid discharged,—the urine being more watery in proportion as the Cutaneous Exhalation is diminished in amount,—and *vice versa* (§ 840). But we are also to look at these two excretions as vicarious, in regard to the deportation (or getting rid) of the products of the *waste* of the system. The share which the Skin has in this office has probably been generally under-rated. There is reason to believe that at least 100 grains of azotized matter are excreted from it daily; and any cause which checks this excretion, must throw additional labour on the kidneys, and will be likely to produce disorders of their function.

871. The Exhalant action of the Skin is influenced by general conditions of the vascular and nervous systems; which are as yet ill understood. It is quite certain, however, that through the influence of the latter the secretion may be excited or suspended; this is seen on the one hand in the state of syncope, and the effects of depressing emotions, especially fear, and its more aggravated condition, terror; and on the other in the dry condition of the skin during states of high nervous excitement. It is very probable that, in many forms of fever, the suppression of the perspiration is a cause, rather than an effect, of disordered vascular action; for there are several morbid conditions of large parts of the surface, in which the suppression of the transpiration appears to be one of the chief sources of danger, having a tendency to produce congestion and inflammation of internal organs. From the recent experiments of Dr. Fourcault,* it appears that complete suppression of the Perspiration in animals,

* Comptes Rendus de l'Academie, May, 1844; and Lancet, June 8, 1844.

by means of a varnish applied over the skin, gives rise to a state termed by him Cutaneous Asphyxia; which is marked by imperfect arterialization of the blood, and considerable fall of temperature (§§ 768, 891); and which, as it produces death in the lower animals, would probably do the same in Man. A partial suppression by the same means gives rise to Febrile symptoms, and to Albuminuria.

872. The Skin is likewise furnished with numerous *Sebaceous* glands, also distributed more or less closely throughout the whole surface of the body. By these an Adipose secretion is poured forth, which keeps the skin from being dried and cracked by the action of the sun and air. It is especially abundant in the races which are formed to inhabit warm climates. Some of these glan-

[Fig. 266.

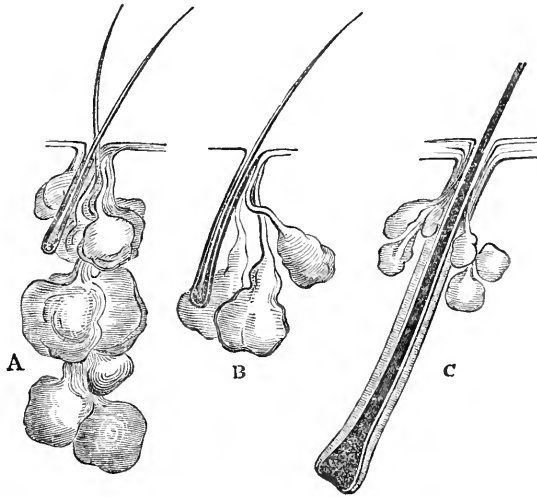

Sebaceous glands, showing their size and relation to the hair-follicles:—A and B from the nose; c from the beard. In the latter the cutis sends down an investment of the hair-follicle.—Magn. 18 diam.]

dulæ are simple follicles lined with secreting cells, and contained in the substance of the Skin itself; whilst others are formed out of similar follicles, more or less branched, elongated, and convoluted; and others, again, seem to consist of little else than clusters of Fat cells, from one part of which an excretory duct arises: these last commonly open into the passage, by which the Hair makes its way outwards. Besides these there are other glands situated in particular parts of the body, and having special functions. Such are the Ceruminous glands situated beneath the skin of the auditory meatus; these are closely analogous in form to the sudoriferous glands, as the accompanying figure shows; but their secretion is very different, being nearly solid, and having somewhat of a resinous character.—A peculiar series of glandulæ, bearing a general resemblance to the sudoriferous glands, but of larger size, have lately been discovered by Prof. Horner* and M. Robin to exist in the human axillæ; where they probably serve to secrete the peculiar odorous matter, characteristic of that part. In many of the lower animals, such glands may be detected, having a structure of considerable complexity. The odorous secretion would appear to be elaborated from the blood by a simple chemical change; for it may be made evident even in blood that has been dried up, by

* [Am. Journ. Med. Science, Jan. 1846, p. 13.]

Fig. 267.

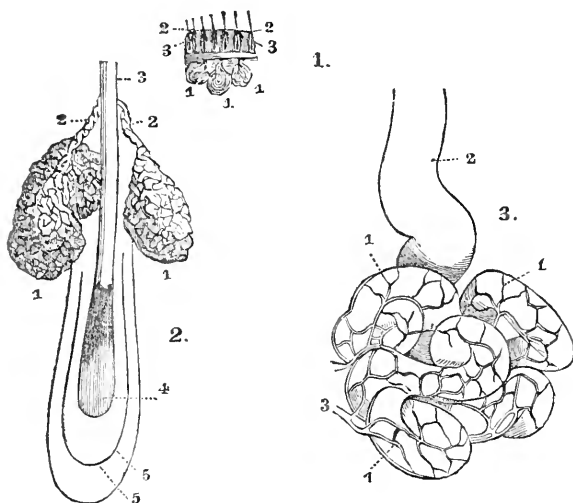

Cutaneous glands of external meatus auditorius.—1. Section of the skin, magnified three diameters : 2, 2, hairs ; 3, 3, superficial sebaceous glands ; 1, 1, larger and deeper-seated glands, by which the cerumen is secreted.—2. A hair, perforating the epidermis at 3 ; 1, 1, sebaceous glands, with their excretory ducts 2, 2 ; 4, base of the hair, in its double follicle 5, 5.—3. Cerumen-gland, formed by the contorted tube, 1, 1, of the excretory duct, 2 ; 3, vascular trunk and ramifications.—The last two figures highly magnified.

[Fig. 268.

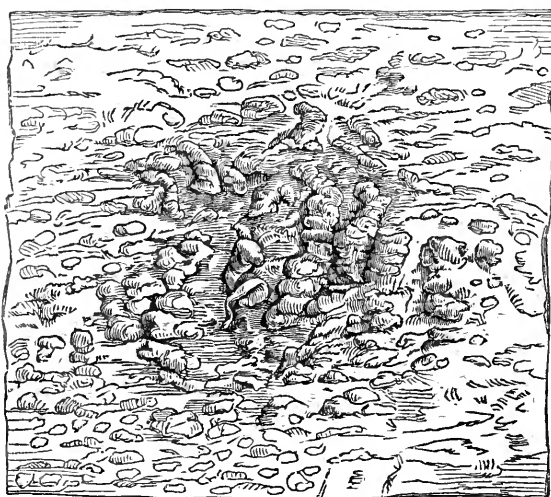

Cutaneous Follicles or Glands of the Axilla, magnified one-third.—(Horner.)]

treating it with sulphuric acid. This aromatic principle differs sufficiently in the blood of different animals, to enable a person with a delicate sense of smell to determine from what animal any specimen has been procured ; and this fact has been applied with success to juridical investigations. It has even

been stated that the blood of the human Male may be distinguished from that of the Female, by its more powerful odour; but this does not appear to be the case,—at least with sufficient certainty for medico-legal inquiries.*

873. Besides the *crypts* or follicles, which have been spoken of as generally existing in Mucous Membranes (§ 178), there exist, in that of the Intestinal Canal, numerous glandulæ in various parts, for the elaboration of particular secretions. In the Stomach, for example, a large number of these secreting organs, some of them possessing rather a complex structure, are included in the thickness of its walls, composing, indeed, the greater part of the mucous membrane. If this be divided by a section perpendicular to its surface, it is seen to be made up of a number of tubuli closely applied to each other, their blind extremities being in contact with the submucous tissue, and their open ends being directed towards the cavity of the stomach. In some situations, these tubuli are short and straight; in other parts they are longer, and present an appearance of irregular dilatation or partial convolution. This, indeed, is their usual character, especially towards the cardiac orifice of the

Fig. 269.

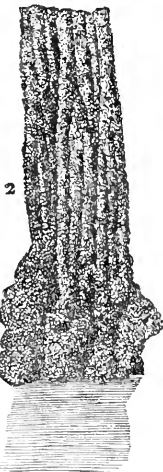

Section of the coats of the stomach, near the pylorus, showing the gastric glands, 1, magnified three times. 2, magnified twenty times.

[Fig. 270.

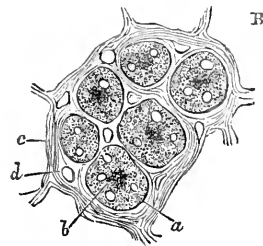
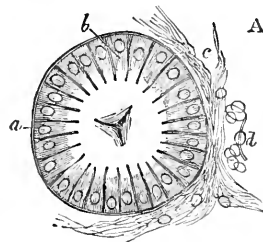

A. Horizontal section of a stomach-cell, a little way within its orifice. *a*. Basement-membrane. *b*. Columnar epithelium. All but the centre of the cavity of the cell is occupied by transparent mucus, which seems to have oozed from the open extremities of the epithelial particles. *c*. Fibrous matrix surrounding and supporting the basement-membrane. *d*. Small blood-vessel.

B. Horizontal section of a set of stomach tubes proceeding from a single cell. The letters refer to corresponding parts. The epithelium is glandular; the nuclei very delicate; the cavity of the tubes very small, and in some cases not visible.

From the dog, after twelve hours' fasting. Magnified 200 diameters.]

* See *Annales d'Hygiene*, vol. i. pp. 267 and 548; vol. ii. p. 217; vol. x. p. 160, &c.

stomach. On the other hand, towards the pyloric extremity, they have a much more complex structure. Between the tubuli, blood-vessels pass up from the sub-mucous tissue, and form a vascular net-work on its surface. From the examination of these horizontal sections of the mucous membrane at various depths, Dr. Todd* has ascertained that the tubuli are arranged in bundles or groups, surrounded and bound together by a fine areolar membrane; the size of the bundles, and the number of tubules contained in them, vary considerably. The tubes do not, in general, open directly upon the surface, but into the bottom of small depressions or pits, which may be seen to cover the membrane. These pits are more or less circular in form, and are separated from one another by partition-like elevations of the membrane, which vary in depth; and sometimes even by pointed processes, that have been mistaken by some anatomists for villi. The diameter of these pits varies from about 1-100th to 1-250th of an inch; it is always greatest near

[Fig. 271.

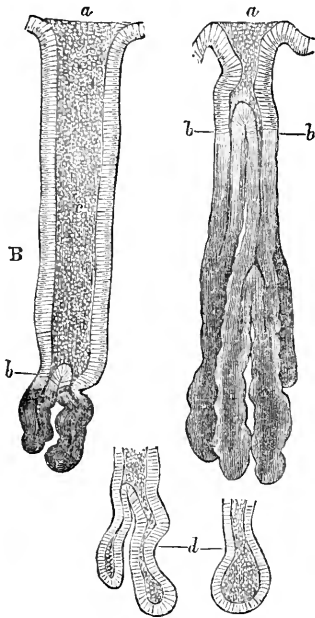

Vertical section of a stomach cell, with its tubes: A in the middle region, B in the pyloric region. *a a*. Orifices of the cells on the inner surface of the stomach. *b b*. Different depths at which the columnar epithelium is exchanged for glandular. *c*. Pyloric tube, or prolonged stomach cell. *d*. Pyloric tubes, terminating variously, and lined to their extremities with sub-columnar epithelium.

From the dog, after twelve hours' fasting. Magnified 200 diameters.]

Fig. 272.

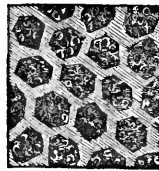

Portion of the mucous membrane of the stomach, showing entrances to the secreting tubes, in pits upon its surface. A

[Fig. 273.

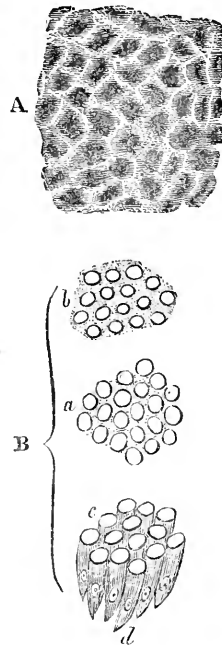

A. Inner surface of the stomach, showing the cells after the mucus has been washed out. Magnified 25 diameters.

B. Columnar epithelium of the inner surface and cells of the stomach:—*a*. Free ends of the epithelial particles, seen on looking down upon the membrane. *b*. Nuclei visible at a deeper level. *c*. The free ends seen obliquely. *d*. Deep or attached ends of the same. The oval nuclei are seen near the deeper ends.

From the dog. Magnified 300 diameters.]

* Gulstonian Lectures on the Physiology of the Stomach, in Medical Gazette, 1839. See also Dr. Sprott Boyd's Inaugural Dissertation on the Mucous Membrane of the Stomach, in Edinb. Med. and Surg. Journal, vol. xlvi.

the pylorus. When the surface of the membrane, cleansed from mucus and epithelium-scales, is examined with a sufficient magnifying power, it is seen that from three to five perforations exist in the bottom of each pit; and these are the openings of the secreting tubes. The Gastric fluid, elaborated by this apparatus, having been already made a subject of special consideration (§ 664) need not be here described.

[Fig. 274.]

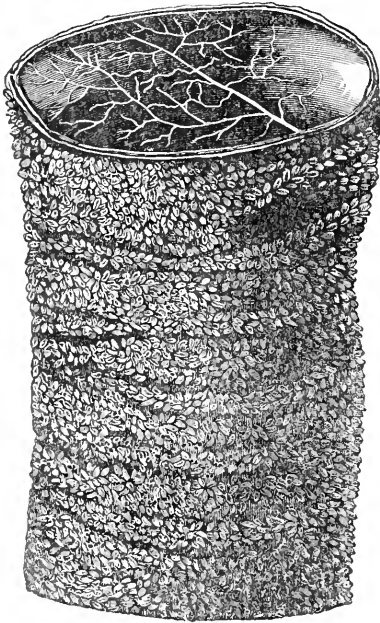

A section of the Ileum, inverted so as to show the appearance and arrangement of the villi on an extended surface, as well as the follicles of Lieberkühn; the whole seen under the microscope. A close examination of this cut will show a great number of black points in the spaces between the projections of villi: these are the follicles of Lieberkühn.]

villi: in the fœtus and newly-born child, they are so abundant as to be almost

874. The whole Mucous surface of the Intestinal canal is furnished with glandular follicles of a very similar character; of which some approach those of the stomach in complexity of structure; whilst others evidently correspond with the *crypts* of ordinary Mucous Membrane. An innumerable multitude of pores are easily seen, by the aid of a simple lens, to cover the whole internal surface of the large Intestine; and these are the entrances to tubular follicles, closely resembling those of the stomach, but more simple in structure. Their cœcal extremities abut against the sub-mucous tissue: towards the end of the Rectum, however, they are much prolonged, and constitute a peculiar layer between the mucous and muscular coats; the tubes which are there visible to the naked eye, being erect, parallel, and densely crowded. These glands probably form the peculiarly thick and tenacious mucus of the large intestine. In the small intestine, on the other hand, the cœca are less deep and their apertures are smaller. These apertures are, for the most part, situated around the bases of the

Fig. 275.

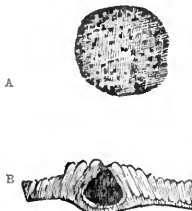

One of the glandulæ majores simplices, viewed from above at A, and seen in section at B; from the large intestine.

Fig. 276.

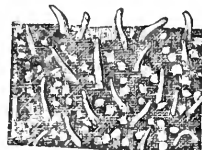

Mucous coat of small intestines as altered in fever; the follicles of Lieberkühn filled with tenacious white secretion.

in contact; but in the adult, the intervals increase, so as to occupy more space than the apertures. The glandulæ of the small intestines have long been known under the name of the follicles of Lieberkühn; they become particularly evident (Fig. 275) when the mucous membrane is inflamed, being then filled with an opaque whitish secretion, which is absent in the healthy state.

—Besides the foregoing descriptions of solitary glandulæ, the Cæcum and the lower part of the Rectum contain a number of simple and large follicles, which produce slight rounded elevations on the surface of the mucous membrane; the centre of each of these elevations is perforated by an aperture of the follicle; and around this are seen the orifices of the tubular cæca, which closely envelope the globular follicle (Fig. 270). These seem most abundant where the largest quantity of mucus is required. They have been confounded with the glands of Brunner; but are rather analogous to the solitary Peyerian glands, presently to be noticed.

875. The true glands of Brunner are chiefly situated in the Duodenum; and they lie not in the mucous but in the sub-mucous tissue, where they form a continuous layer of white bodies surrounding the whole intestine. Their size, unless diseased, is scarcely that of a hemp-seed; each consists of numerous minute lobules, of which the ducts open into a common excretory tube; and in the lobules may be distinguished the minute ramifications of these ducts, with clusters of follicles forming acini, of which about six hundred are computed to exist in each. Hence these glands are of complex structure, much resembling that of the Salivary glands and Pancreas, and entirely differing from all the other glandulæ of the walls of the alimentary canal. Of the peculiar nature of their secretion nothing is known.

876. The so called Peyerian glands constitute, when aggregated together, large patches on the mucous membrane of the small intestine, where they are known as the *glandulæ agminatæ*; and it is to these alone that Peyer's name is usually applied. Similar bodies, however, known as the *glandulæ solitariæ*, exist separately in the lower part of the small intestines; where they have been confounded with the glands of Brunner, which do not extend beyond the commencement of the Jejunum. The glands of Peyer, when examined in a healthy mucous membrane, present the appearance of circular white slightly-raised spots, about a line in diameter, over which the membrane is usually less set with villi, and very often entirely free from them. Each of these white spots, of which a large number are contained in the agminated glands, is surrounded by a zone of openings like

[Fig. 277.]

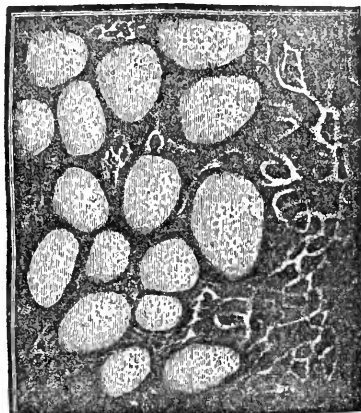

A section of the small Intestine containing some of the glands of Peyer, as shown under the microscope. These glands appear to be small lenticular excavations, containing, according to Boehm, a white, milky and rather thick fluid, with numerous round corpuscles of various sizes, but mostly smaller than blood-globules. The meshes seen in the cut are the ordinary tripe-like folds of the mucous coat, and not the venous texture spoken of under the follicles.]

Fig. 278.



Conglomerate gland of Brunner, from commencement of duodenum; magnified a hundred times.

those of the follicles of Lieberkühn, which lead (as do those) into tubular cæca. On rupturing the surface of one of the white bodies, there is found a

Fig. 279.

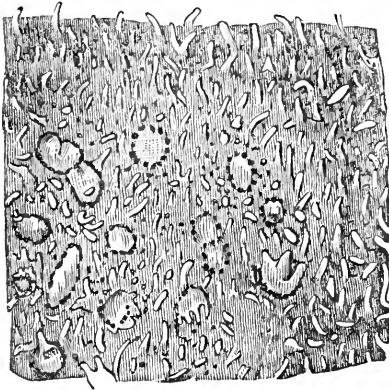

Portion of one of the patches of Peyer's glands, from the end of the Ileum, highly magnified; the villi are also displayed.

cavity, corresponding in extent with the spot, and of considerable extent; but this cavity has usually no excretory opening, and the tubular follicles by which it is surrounded, have no connection with it. In its interior is found a grayish-white mucous matter, interspersed with cells in various stages of development. There is reason to believe that, at a certain period of the existence of each of these glandulæ, an excretory orifice is formed, by a sort of dehiscence in the wall of the cavity; and that, through this, the product secreted by the contained cells may be poured forth. Each of them may be compared, on this view, to one of the ultimate follicles, which constitutes the secreting portion of any one of the larger glands (§ 823); the only difference being, that the latter are situated at the extremities of the ramifying ducts, by which their product is collected and conveyed away; whilst the former pour their secretion at once into the cavity of the intestine.—The membrane which covers in the cavity is extremely thin, and is very liable to be destroyed by ulceration; hence it is, that, after inflammation of the enteritic mucous membrane, the patches of Peyer are often to be seen as a congeries of shallow open cells or follicles.

877. Although the particular use of each variety of the Intestinal glandulæ cannot yet be determined, there seems little doubt that their general function is, to eliminate from the Blood those *putrescent* matters which would otherwise accumulate in it; whether as one of the results of the normal *waste* of the system, or as produced by various morbid causes, which act as *ferments*, and thus occasion an unusual tendency to decomposition in the solids and fluids of the body. That the putrescent elements of the feces are not immediately derived from the food taken in, so much as from the excreting action of the Intestinal Glandulæ, appears from this consideration, among others;—that faecal matter is still discharged, even in considerable quantities, long after the intestinal tube has been completely emptied of its alimentary contents. We see this in the course of many diseases, when food is not taken for many days, during which time the bowels have been completely emptied of their previous contents by repeated evacuations; and whatever then passes, in addition to the biliary and pancreatic fluids, must be derived from the intestinal walls themselves. Sometimes a copious flux of putrescent matter continues to take place spontaneously; whilst it is often produced by the agency of purgative medicine. The “*colliquative diarrhœa*,” which frequently comes on at the close of exhausting diseases, and which usually precedes death by starvation, appears to depend, not so much upon a disordered state of the intestinal glandulæ themselves, as upon the general disintegration of the solids of the body, which calls them into extraordinary activity for the purpose of separating the decomposing matter.

CHAPTER XVI.

GENERAL REVIEW OF THE NUTRITIVE PROCESSES.—ANIMAL HEAT.

1.—*Review of the Nutritive Processes, with Practical Applications.*

878. THE detailed survey which has been now taken, of the different Functional operations concerned in maintaining the life of the individual, may suggest to us some general views that have important practical applications. In the first place, it has been shown, that the province of the Animal is not to combine Inorganic elements into Organic compounds, fit to be applied to the purposes of Nutrition; but to use those which are prepared for it by the Plant. The nutritive materials thus obtained may be divided into two great classes, the *azotized* and the *non-azotized*. The former have been shown (§ 642) to be so nearly identical in composition with the proximate principles of which the Animal body is composed, that no great amount of *chemical* transformation can be required to prepare them for being appropriated by it. The latter are altogether different in character; and whether or not they can, by any process of transformation, be made subservient to the nutrition of the Azotized tissues, it is unquestionable that their *ordinary* use is to serve as the materials for the Respiratory process, and for the maintenance of Animal heat. The demand for these several articles in the system will depend, in regard to the former, upon the amount of Tissue which has been disintegrated and needs repair; and with respect to the latter, upon the amount of Heat which it is necessary to generate, to keep up the temperature of the body to its regular standard. Hence a highly-azotized diet is most required when the greatest amount of muscular exertion is being used; whilst a diet, in which non-azotized substances are predominant, will serve to sustain the Animal Heat in a cold atmosphere. The adjustment of the diet to the wants of the system, is a matter of the greatest importance for the preservation of health. If too great an amount of azotized food be ingested, and the superfluity be thrown upon the Kidneys to eliminate (§ 850), disorder of the Urinary Secretion is almost certain, sooner or later, to manifest itself. The quantity of Lithic Acid, in particular, undergoes considerable increase; and, by the removal of its bases through the increased production of other acids, it is very likely to pass out in an insoluble state, giving rise to Gravelly deposits. Or it may accumulate in the Blood, and there combine with Soda; forming a salt which is deposited in various parts (especially in the neighbourhood of the smaller joints), forming concretions, which are commonly known under the name of "chalk-stones." These deposits usually take place, however, after severe attacks of a peculiar Inflammation, known as Gout; and this inflammation seems to be connected with the accumulation of Lithate of Soda in the Blood.—Over this disease a careful regulation of the diet exercises a powerful control. A patient affected with the "Lithic Acid diathesis," may palliate, if not altogether cure his disorder, by rigorously abstaining from the use of any superfluous amount of azotized compounds as food; and by subsisting as much as possible upon those belonging to the Farinaceous group. It is by no means every case, however, that is capable of alleviation by treatment of this sort; in fact, it can seldom be rigorously

enforced, except in early life, or at any rate when the constitution is unbroken by disease or intemperance. Not unfrequently it will be found, that the persistence in a diet of this kind, occasions so much disorder of the stomach, as to be quite out of the question.—On the other hand, in the “Strumous diathesis,” there would seem to be a low condition of those vital powers, which are concerned in the conversion of the Albuminous materials prepared by the Digestive process, into the Fibrinous matter which is ready for assimilation; so that, by a perversion of the ordinary nutrient actions, Albuminous Tubercle is deposited in the interstices of the tissues, instead of these tissues being themselves regenerated by Organizable Fibrine; and the same may take place in a more rapid manner, in consequence of that disturbance of the nutrient processes, which is known in healthy constitutions as Inflammation (§ 802). It is obvious, then, that the treatment of the Strumous Diathesis should be directed towards the invigoration of the general powers of the system; and although, when disease of the Chest has once established itself, a warm moist atmosphere may be necessary as a preventive of inflammatory affections, it is a great mistake to imagine that such a plan is applicable to those in whom there is merely a strumous predisposition; for this should be combated by such means as are calculated rather to brace than to relax the system,—especially out-door exercise, a nutritious diet in which easily-digested proteine-compounds should predominate, and a dry and well-ventilated habitation. There can be no doubt that the Tuberculous Cachexia is encouraged, and developed, by injudicious management during the early ages of life, in many cases where it might have been avoided.*

879. Equally important is the regulation of the diet, in regard to its non-azotized constituents. If these are in excess, the elimination of them from the Blood falls especially upon the Liver (§ 836); and a continued excess gives rise to disorders in its function, which a diminution in the quantity of Farinaceous or Oleaginous matter ingested would prevent or cure. This is especially liable to happen to Europeans proceeding to warm climates; who are not warned by their decrease of appetite, that there is no longer a necessity for the same supply; but force themselves to eat much more than they have any real occasion for.—There is a very remarkable condition of the system, in which there is a tendency to the presence of a large amount of Sugar within the vessels; either through the absence of power to convert that which has been taken in; or through the actual production of that compound, as a result of the *waste* of the system. We have seen that *Sugar* may be detected in the Serum of *healthy* blood, drawn soon after a meal; but that it soon becomes untraceable,—probably in consequence of its being carried off by the respiratory process (§ 697). In the disease termed Diabetes, or the “saccharine diathesis,” there is a much larger amount of Sugar in the Blood: and this appears to be *constantly* present, as if, from some cause, its elimination by the usual channel were retarded. The Sugar makes its appearance, also, in the Urine; the Kidneys taking-on the unusual office of separating this compound, that it may not accumulate in the Blood.—Some late researches on the exclusive employment of azotized principles as articles of diet, in the treatment of the Saccharine diathesis, have given very favourable results. The plan was long since proposed by Dr. Rollo; and when the diseased condition has been uncomplicated by other maladies (as is not unfrequently the case), the rigorous enforcement of such a diet has been attended with success in numerous instances. One of the greatest difficulties in the application of the system, however, has arisen from the longing which the patients experience

* See the excellent works of Sir James Clark, in which the importance of Hygienic treatment is strongly insisted on.

for Vegetable food; since this tempts them to gratify their appetites, to the complete prejudice of the remedial system,—a very small amount of farinaceous matter being sufficient to cause the re-appearance of the Sugar, after it had seemed to be entirely got rid of. It has been proposed, however, by M. Bouchardat to gratify this longing to a certain degree, by allowing the use of bread made of wheaten flower, from which nearly all the *Fecula* has been separated,—the *Gluten* only being left, with such a small amount of *Fecula* as may serve to make it *rise* in fermentation; so that it is as free from unazotized constituents, as the average of animal substances. This plan has been very successfully practiced; having frequently kept the disease in complete check, where, from the advanced period of life, the duration of the morbid state, and other circumstances, a perfect cure could not be reasonably expected.

880. From what has been stated in Chap. XII. respecting the nature of the Function of Circulation, it is evident that primary disorders of that function are not nearly so frequent as they are ordinarily supposed to be; and that the proximate cause of morbid phenomena is seldom to be found in them. By the action of the Heart and Blood-vessels, the nutrient fluid, which has been prepared from the alimentary materials submitted to the digestive apparatus, is conveyed to the tissues which it is to nourish; but the true process of Nutrition is independent of this, and may take place after the motion of the fluid has ceased, just as it commences before any movement shows itself. For the tissue which exists in the Embryo during the early period of its development, and also in any newly-forming part, is destitute of *vessels*, consisting only of *cells*; and these grow and reproduce themselves at the expense of the nutritive materials supplied to them from without, just as does the whole mass of a Cellular Plant. Moreover it has been shown (§ 740), that the activity of the nutrient processes has much to do with the movement of the fluid through the smaller vessels, and is a cause rather than a consequence of it. If the action of the Heart cease, the whole circulation must obviously come to a stand ere long; but in many animals the Capillary movement may continue for some time after the general circulation has been checked; and, so long as blood is supplied to the parts, so long may their nutrition continue, provided other circumstances be favourable. It is unquestionably true, that the cessation of the Circulation is usually the immediate cause of *Death*; and that, when the suspension is permanent, the loss of the vitality of the system, considered both as a whole, and as made up of distinct parts, is a necessary consequence. But still, we find that the cause of this cessation seldom originates in the Circulating apparatus itself; and in general, a disturbed state of the Circulation is to be looked upon rather as a result, than as a cause, of diseased action. An extreme case of such a disturbance, which, when sufficiently prolonged, is attended with fatal results, is to be found in *Asphyxia*; in which the cessation of the action of the Lungs induces a stagnation of the Blood in their capillaries; and as, in warm-blooded animals, the whole current of Blood has to pass through the Lungs, before proceeding again to the system, a total suspension of the Circulation necessarily results from this interruption (§§ 738 and 779). Now if we take this (which it appears reasonable to do) as a type of a great number of morbid conditions of different organs, we are led to see why a serious disturbance of the movement in any one part should affect the entire circulating apparatus, and should thus influence its flow through almost every other organ. There are no other organs, however, in which a stagnation can be so serious as in the Lungs; since there are none through which the whole current flows. The Liver ranks next in importance, since all the venous blood collected from the Chylopoietic viscera passes through it; and every practical man is aware how frequently derangement of

the circulation through the Liver, originating in an unhealthy state of the gland itself, is a cause of serious disorders in the abdominal viscera.—Minor irregularities in the Circulation, in various parts, not unfrequently become causes of serious inconvenience. Thus, few conditions are more common, especially amongst persons of active minds but inert habits, than undue determination of blood to the Head, conjoined with torpor of the circulation through the Skin, especially that of the extremities, which are ordinarily cold. The obvious indication here is, to endeavour to restore the balance of the Circulation; and excitement of the flow of blood through the Skin, by frictions, moderately-stimulating applications, exercise, &c., will commonly prove of great utility.

881. There are many disorders commonly regarded as affections of the Circulation, which evidently consist in reality of a morbid alteration in the Nutritive processes: among these there can be little doubt that we are to rank local Determinations and Congestions, which result from an exalted or diminished activity of the formative actions; and Inflammation, in which these actions are perverted. Much has been said and written, to very little purpose, respecting the essential nature of this process; it has been attributed by some to disordered action of the vessels, and by others to an injurious impression on the nerves,—the fact, that Inflammation may occur in tissues which contain neither vessels nor nerves, having been entirely overlooked. The only view of the character of Inflammation that seems likely to account for its phenomena, is that which regards it as essentially consisting in a disturbance of the due relation between the living Tissue and the nutrient materials contained in the Blood; in other words, as an abnormal form of the ordinary nutritive process (§§ 802—806). A similar remark may be made, in regard to those productions formerly termed “Heterologous transformations” of tissue; which are rather to be regarded as new growths, that have appropriated the nutriment designed for the support of the proper tissues, and have therefore become developed at the expense of these. It is quite as absurd to attempt to account for the growth of Scirrhus, Carcinoma, &c., by any peculiar action of the *vessels* of the part, as it would be to attribute the secretion of fatty matter by the cells of one tissue, or of phosphate of lime by those of another, to the peculiar distribution of their vessels. The progress of research obviously leads to the conclusion, that in every part of the living body there is an inherent and independent vitality, which enables it to grow and maintain its normal structure and constitution, so long as it is supplied with the requisite materials; and that changes in the character of the tissue can be referred to nothing else than to alterations in its properties, resulting from external agencies, or to alterations in the materials supplied for its renewal. Of these two morbid causes, the latter is undoubtedly the most frequent; and the tendency which is now gaining ground, to seek in the Blood for indications of pathological changes, when there is no obvious general disturbance of the system, will probably lead to a greatly-increased knowledge of the real nature of diseased states; in spite of the opposition which any return to the Humoral Pathology is sure to excite, in the minds of those who regard it as an exploded and pernicious system.

882. The Sympathy between different parts of the system, which especially manifests itself in the tendency to simultaneous affection with the same Disease, affords an excellent illustration of this principle. Of those Sympathetic actions, which result from the Nervous connections of the various organs, this is not the place to speak; since we are at present concerned with those perversions of the Nutritive processes, which give rise to Inflammatory and other diseases. Where a certain tissue, throughout the body, is similarly affected, there is strong reason to presume that the morbid cause is conveyed to it in the Blood; this is the case, for example, with regard to

the Mucous membranes, which all manifest a tendency to Inflammation, when Arsenic has been received into the system: and certain forms of the disease commonly termed Influenza, are marked by a similar disposition. The same may be said in regard to Inflammation of the Fibrous membranes, Areolar tissue, Serous membranes, and other structures. It has been considered a sufficient account of these consentaneous affections, to say that they result from Sympathy,—a mere verbal quibble, which explains nothing. If, on the other hand, we regard the disease as a perversion of the ordinary processes of Nutrition, Secretion, &c., and as dependent upon an abnormal condition of the Blood (such as is induced by the introduction of a poison into it), the rationale of the sympathetic disturbance becomes apparent;—since all the tissues of the same kind will of necessity be similarly affected, although some local cause may occasion one to suffer more severely than another. In the ingenious paper by Dr. W. Budd, already referred to (§ 785), the perfect correspondence, which not unfrequently manifests itself between the diseased actions on the two sides of the body, is adduced in support of the same view, to which it is made to afford very striking confirmation. The fact that this kind of Sympathy not unfrequently manifests itself between tissues having an analogous structure, but very different function, is another argument in favour of the same view; of this fact, the sympathy of which every practical man is aware, between the Skin and Mucous Membranes, is a very good example. The sympathy of the different tissues forming any individual organ, by which disease in one becomes a cause of disorder in the rest, is, however, to be very differently explained. We have examples of this in Inflammatory affections of the Mucous membranes, which usually extend themselves to the remaining constituents of the organs of which they form a part; and in those of the Serous membranes, which almost always follow inflammation of the organs they invest. Here the local disturbance of one part appears sufficient to account for the extension of it to another, that is closely connected with it by vessels and nerves; this has been termed the Sympathy of Contiguity. The Fibrous membranes are less liable to be affected in this manner, than are most other tissues; and the reason appears simply this,—that there is usually less vascular connection between them and the adjacent parts, than there is in the case of the Serous membranes. Hence the Fibrous membranes frequently act as insulators, preventing the spread of disease to adjacent parts.

883. The general characters of the processes of Nutrition and Secretion are so nearly allied, that what has been stated of the Pathological states of the former, is nearly as applicable to those of the latter. Although it is unquestionable that disordered Secretion may result from a purely local cause, acting on the solid tissue of the part affected, yet there is also increasing reason to believe, that in a large number of cases, the abnormal character of the product is in reality a result of the abnormal state of the Blood from which it is separated; and that the organ itself is still performing a healthy function, in separating from the blood that which would be injurious to it. This leads us to refer such disorders to causes much more remote than those which were formerly supposed to operate; but they are undoubtedly nearer the true ones. Such a view has been prosecuted by Dr. Prout in regard to the abnormal conditions of the Urine, with great success; and there can be little doubt that it is also applicable to the Biliary secretion, on the true chemical nature of which there is scarcely yet an agreement among Chemists, and whose pathological conditions, therefore, are, and must long remain, comparatively obscure. It is obvious that, if the Assimilation of Nutritive matter be in any respect wrongly performed, the products of the Decomposition of the Tissues (in which these excretions probably originate, § 819), must also be different; and our remedial measures must often be directed, therefore, not so much to the Secreting organ, as towards the previous operations.

884. These considerations are of the highest importance in the treatment of Disease; the success of which will greatly depend upon the degree in which the Physician follows the indications of Nature, instead of putting himself in antagonism to her course of operation. If we pay but a slight attention to those phenomena which result from the introduction of poisons into the system, we perceive that there is almost invariably an increased excretion of some kind, which tends to eliminate them from the blood. Even where there is no other obvious means for their removal, we can have little doubt that the Respiratory function gives important aid in their separation; when we keep in view that from five to eight ounces of solid carbon, to say nothing of the hydrogen, are thrown off from the lungs in the course of every twenty-four hours. It is important to bear this circumstance in mind; since it enables us to understand how, if *time* be given, the system frees itself from such noxious substances; and it points out the duty of the medical attendant to be rather that of supporting the powers of the body by judiciously-devised means, and of aiding in the elimination of the noxious matter by a copious supply of pure air, than of interfering more actively to promote that which Nature is already effecting in the most advantageous manner. We see the results of this operation in the case of Narcotic poisoning; in which, if the Respiratory process can be artificially kept up for a sufficient length of time, the powers of the nervous system are gradually restored, even after what seemed to be their complete and final cessation.—There can be no doubt that, in like manner, the system makes an effort to rid itself of other noxious substances, the presence of which in the blood results from morbid processes going on in the body itself, and which, if retained, would produce the most serious consequences. Thus a copious discharge of Lithic acid by the Urine will frequently avert or curtail an attack of Gout. The copious acid perspirations, which occur in certain forms of Rheumatism, are the means by which the Lactic acid (which seems to be the *materies morbi* of this disease) is separated from the blood. And there can be no doubt that an attack of Diarrhea often prevents more serious disease, by removing an unusual accumulation of the elements of bile, or by eliminating an undue amount of putrescent matter, the continued presence of which in the circulating fluid would induce the most serious disorders in the nervous system.—There can be no doubt that a due regulation of the Excreting processes is one of the most important means, by which the Physician can counteract the results of disordered actions in the system. They may frequently require to be gently stimulated, in order to remove some morbid elements from the blood. But it will be seldom that it will be desirable to check them, even when apparently excessive, unless there be strong reason to believe, that the excess proceeds from a disordered state of the organ itself, produced by local causes only.

2.—*Animal Heat.*

885. All the vital actions that have been considered in the preceding pages, require a certain amount of Heat as a condition of their performance; and in the more elevated tribes of animals, in which (for the very purposes of their creation) a high degree of constancy and regularity is required in these actions, there is a provision within themselves for the maintenance of their temperature at a certain standard. We shall inquire, in the first place, into the amount of Heat thus generated by Man; and then into the sources of its production.

886. Our present knowledge of the Temperature of the Human body under different circumstances, is chiefly due to the investigations of Dr. J. Davy. Much additional information may be expected, however, from inquiries which

are at present in progress. Dr. Davy's observations* have included 114 individuals of both sexes, of different ages, and among various races, in different latitudes, and under various temperatures; the external temperature, however, was in no instance very low, and the variations were by no means extreme. The mean of the ages of all the individuals was 27 years. The following is a general statement of the results, the temperature of the body being ascertained by a thermometer placed under the tongue.

Temperature of the air	60°	Average temperature of the body	91.28°
" " "	69°	" " "	98.15°
" " "	78°	" " "	98.85°
" " "	79.5°	" " "	99.21°
" " "	80°	" " "	99.67°
" " "	82°	" " "	99.9°
Mean of all the experiments	74°	Mean of all the experiments	100°
Highest temperature of air	82°	Highest temperature of body	102°
Lowest temperature of air	60°	Lowest temperature of body	96.5°

From this we see that the variations noted by Dr. Davy, which were evidently in part the consequence of variations in external temperature, but which were also partly attributable to individual peculiarities, amounted to $5\frac{1}{2}$ degrees; the lower extreme would probably undergo still further depression, if the inquiries were carried on in very cold climates.—The Temperature of the body may be affected by internal as well as by external causes; thus in diseases which involve an accelerated pulse and an augmented respiration, the temperature is generally higher than usual, even though a large portion of the lung may be unfit for its function. This is often remarkably seen in the last stages of Phthisis, when the inspirations are extremely rapid, and the pulse so quick as scarcely to admit of being counted; the skin, in such cases, often becomes almost painfully hot. On the other hand, in diseases of the contrary character, such as Asthma and the Asiatic Cholera, the temperature of the body falls, sometimes, to the extent of 20 degrees. The following observations have been made on this subject by M. Donné;† it is much to be desired, however, that fuller data could be collected on the subject. In a case of Puerperal Fever, the pulse being 168, and the respiration 48 per minute, the temperature was 104°. In a case of Hypertrophy of the Heart, the pulse being 150 and the respirations 34, the temperature was 103°. In a case of Typhoid Fever, the pulse being 136, and the respirations 50, the temperature was 104°. And in a case of Phthisis, the pulse being 140, and the respirations 62, the temperature was 102°. On the other hand, in a case of Jaundice, in which the pulse was but 52, the temperature was only 96.40°; but the same temperature was observed in a case of Diabetes, in which the pulse was 84. The limited results of Mons. D.'s experiments, whilst they clearly indicate that a *general* relation exists between the temperature of the body and the rapidity of the pulse, also show that this relation is by no means invariable, but that it is liable to be affected by several causes, of which our knowledge is as yet very limited. Dr. Dunglison speaks of having frequently seen the thermometer at 106° in Scarlatina and Typhus; and Dr. Edwards mentions a case of Tetanus, in which it rose to 110 $\frac{3}{4}$.‡

* Phil. Trans., 1814; republished in Anatomical and Physiological Researches.

† Archives Générales, Oct. 1835; and Brit. and For. Med. Rev., vol. ii. p. 248.

‡ [An extensive series of observations has been made by M. Roger* on the temperature of children in health and various diseases.

In nine examinations of infants from one to twenty minutes after birth, the temperature (observed in these and in all the other cases, in the axilla), was from 99.95 to 95.45. Im-

* Arch. Gén. de Médecine, Juillet, Août, &c., 1844.

887. Although there appears to be, for all species of animals, a distinct limit to the variations of bodily temperature, under which their vital operations can be carried on, this limitation does not prevent animals from existing in the midst of great diversities of external conditions; since they have within themselves the power of compensating for these, in a very extraordinary degree. This power seems to exist in Man to a higher amount than in most other animals; since he can not only support, but enjoy, life under extremes, either of which would be fatal to many. In many parts of the tropical zone, the thermometer rises every day through a large portion of the year to 110° ; and in British India it is said to be seen occasionally at 130° . On the other hand, the degree of cold frequently sustained by Arctic voyagers, and quite endurable under proper precautions, appears much more astonishing; by Capt. Parry, the thermometer has been seen as low as -55° , or 87° below the freezing point; by Capt. Franklin at -58° , or 90° below the freezing point; and by Capt. Back at -70° , or 102° below the freezing point. In both cases, the effect of the atmospheric temperature on the body is greatly influenced by the condition of the air as to motion or rest; thus, every one has heard of the almost unbearable oppressiveness of the sirocco or hot wind of Sicily and Italy, the actual temperature of which is not higher than has often been experienced without any great discomfort, when the air is calm: and, on the other side, it may be mentioned that, in the experience of many Arctic voyagers, a temperature of -50° may be sustained, when the air is perfectly still, with less inconvenience than is caused by air in motion at a temperature fifty degrees higher. This is quite conformable to what might be anticipated on physical principles.

888. Again, the degree of moisture contained in a heated atmosphere, makes a great difference in the degree of elevation of temperature, which may be sus-

mediately after birth the temperature was at the highest; but it quickly fell to near the lowest of those above stated; but, by the next day, it was again completely or nearly what it was before. The rapidity of the pulse and of respiration appeared to have no certain relation to the temperature.

In thirty-three infants of from one to seven days old, the most frequent temperature was 98.6 ; the average was 98.75 ; the maximum (in one case only) 102.2 ; the minimum (also observed only once) 96.8 . All the infants were healthy. The frequency of respiration had no evident or constant relation to the temperature. A few of the infants were of a weakly habit; their average was 97.7 : the others were strong, and their average temperature was 99.534 . The age of the infant (in this short period) had no influence on its temperature; neither had its sex, nor its state of sleep or waking, nor the period after suckling.

In twenty-four children, chiefly boys, from four months to fourteen years old, the most frequent temperature was above $98^{\circ}.6$; the average was $98^{\circ}.978$, the minimum was $98^{\circ}.15$; the maximum $99^{\circ}.95$. The average temperature of those six years old or under, was $98^{\circ}.798$; of those above six years old, $99^{\circ}.158$. The average number of pulsations in the minute was in those under six years old 102 ; in those above that age 77 ; yet the temperature of the latter was higher than that of the former, or of younger infants. There was no evident relation between the temperature and the frequency of respiration; nor in a few examinations, was the temperature affected in a regular way, by active exercise for a short time, or by the stage of digestion.

As already said, in all the examinations from which these results were obtained, the thermometer was held in the axilla; comparative examinations proved that the temperature of the axilla (though lower than that of internal organs), was higher than that of any other part of the surface of the skin. Of the other parts examined, the warmest was the abdomen, then in succession, the cavity of the mouth, the bend of the arm, the hands, the feet; of which last, the average temperature, in four examinations, was only $87^{\circ}.35$. (These results correspond sufficiently with those obtained by Dr. John Davy.)

In diseased states, (to the illustration of which the greater part of the memoir is devoted,) the temperature of the skin in children may descend to $74^{\circ}.3$, and may ascend to $108^{\circ}.5$. Its range of variation is therefore much greater than in adults, in whom M. Andral found it to vary in different diseases not more than from 95° to $107^{\circ}.6$.—M. C.]

tained without inconvenience. Many instances are on record, of a heat of from 250° to 280° being endured in dry air for a considerable length of time, even by persons unaccustomed to a particularly high temperature; and persons whose occupations are such as to require it, can sustain a much higher degree of heat, though not perhaps for any long period. The workmen of the late Sir F. Chantrey have been accustomed to enter a furnace in which his moulds were dried, whilst the floor was red-hot, and a thermometer in the air stood at 350° ; and Chabert, the "Fire-king," was in the habit of entering an oven, whose temperature was from 400° to 600° . It is possible that these feats might be easily matched by many workmen who are habitually exposed to high temperatures; such as those employed in Iron-foundries, Glass-houses, and Gas-works. In all these instances, the dryness of the air facilitates the rapidity of the vaporization of the fluid, of which the heat occasions the secretion by the Cutaneous glands; and the large amount of caloric which becomes latent in the process, is for the most part withdrawn from the body, the temperature of which is thus kept down. Exposure to a very elevated temperature, however, if continued for a sufficient length of time, does produce a certain elevation of that of the body; as might be expected from the statements already made in regard to the variation in the heat of the body with changes in atmospheric temperature (§ 886). In the experiments of MM. Berger and Delaroche, it was found that, after the body had been exposed to air of 120° during 17 minutes, a thermometer placed in the mouth rose nearly 6 degrees above the ordinary temperature; it may be remarked, however, that as the body was immersed in a close box, from which the head projected (in order to avoid the direct influence of the heated air on the temperature of the mouth), the air had probably become charged with the vapour exhaled from the surface, and had therefore somewhat of the effects of a moist atmosphere. At any rate, the temperature of the body does not appear to rise, under any circumstances, to a degree very much greater than this. In one of the experiments of Drs. Fordyce and Blagden, the temperature of a Dog, that had been shut up for half-an-hour in a chamber of which the temperature was between 220° and 236° , was found to have risen from 101° to about 108° . MM. Delaroche and Berger tried several experiments on different species of animals, in order to ascertain the highest temperature to which the body could be raised without the destruction of life, by inclosing them in air heated from 122° to 201° , until they died: the result was very uniform, the temperature of the body at the end of the experiment only varying in the different species between 11° and 13° above their natural standard: whence it may be inferred, that an elevation to this degree must be fatal. This elevation would be attained comparatively soon in a moist atmosphere; partly because of the greater conducting power of the medium; but principally on account of the check which is put upon the vaporization of the fluid secreted by the skin. Even here, however, custom and acquired constitution have a very striking influence; for whilst the inhabitants of this country are unable to sustain, during more than 10 or 12 minutes, immersion in a vapour-bath of the temperature of 110° or 120° , the Finnish peasantry remain for half-an-hour or more in a vapour-bath, the temperature of which finally rises even to 158° or 167° .—Accurate experiments are yet wanting, to determine the influence of humidity on the effects of cold air. From experiments on young Birds incapable of maintaining their own temperature, of which some were placed in cold dry air, and others in cold air charged with moisture, it was found by Dr. Edwards that the loss of heat was in both instances the same; the effect of the evaporation from the surface in the former case, being counter-balanced in the latter by the depressing influence of the cold moisture. This influence, the existence of which is a mat-

ter of ordinary experience, is probably exerted directly upon the nervous system.

889. Having thus considered the general facts which indicate the faculty possessed by the living system, in the higher Animals, of keeping up its temperature to an elevated standard, and of preventing it from being raised much beyond it by any degree of external heat, we have next to inquire to what this faculty is due. We shall be more likely to arrive at accurate results in such an inquiry, the more comprehensive is our survey of the phenomena to which it relates.*

a. The most recent experiments on the temperature of Plants (those made by MM. Becquerel and Breschet with the thermo-multiplier) have demonstrated, that in those parts in which the vital processes are taking place with activity, a sensible amount of caloric is being constantly evolved. The amount of this evolution of heat is generally very low, not more, in fact, than a single degree (Fahr.); and as it does not more than counterbalance the effect of the evaporation, which is continually taking place from the surface, there is no sensible difference between the temperature of the plant and that of the surrounding air. At the time of Flowering, however, a much greater degree of heat is generated in many plants, especially in those in which a large number of flowers are crowded together, as in the case of the Arum tribe: thus a thermometer placed in the midst of twelve spadixes has been seen to rise to 121°, whilst the temperature of the air was only 66°. During the Germination of seeds, again, a considerable development of heat takes place; this, which is soon carried off from a single seed, becomes very sensible when a large number are heaped together, as in malting; the thermometer plunged into a heap of germinating barley having been seen to rise to 110°.

b. These facts are of more importance than might appear at first sight; for they indicate unequivocally, that the source of the heat is to be looked for in the Organic functions, not in those of Animal life. The evolution of Caloric has been attributed by many physiologists to the Nervous system; the influence which this system evidently possesses over the function, being mistaken for the efficient cause of it. As has been remarked on several former occasions, however,—the fact that *any* change takes place in Vegetables, to the same degree (under certain conditions,) with that in which it ever presents itself in Animals, is a sufficient proof that it cannot be *dependent* upon nervous agency, although it may be *influenced* by it. Moreover, it may be remarked that the production of Heat is an operation of an entirely *physical* character, and that it may be referred to physical causes; whilst the operations in which the Nervous system is concerned, are such as we cannot liken in any degree to physical phenomena, and are of a purely *vital* character.—In our inquiry into the sources of the Heat evolved by living beings, we are limited, therefore, to those which can operate in the Vegetable kingdom; and on examining into the phenomena which present any relation to this, we are at once struck with the fact, that an absorption of Oxygen from the air, with an excretion of Carbonic acid, is continually taking place (constituting the true Respiratory process of Plants, § 750); and that these changes occur with excessive activity, at the very periods at which the evolution of Heat is most remarkable,—those, namely, of germination and flowering. The quantity of Oxygen consumed by flowers is enormous—those of the Arum Italicum having been found to convert 40 times their own bulk of that gas into Carbonic acid, between the periods of their first appearance and their final decay; and of this, the far larger proportion is consumed by the sexual apparatus, which has been found to consume 132 times its own bulk of Oxygen in 24 hours. That this change is a condition necessary for the production of Heat, is fully proved by the fact, that no caloric is evolved when the flowers are excluded from the contact of Oxygen; whilst the substitution of pure oxygen for atmospheric air occasions the elevation of temperature to be more rapid and considerable than usual.† The same may be said of the heat liberated by seeds in the act of Germination: a large amount of oxygen is absorbed, and of carbonic acid given out, during this process; and the evolution of Heat may be easily shown to be as dependent upon this change, as in the instance just quoted.

c. When the phenomena of Calorification in Animals are carefully examined, they are found to harmonize completely with this view. Throughout the whole kingdom, an exact conformity may be perceived between the amount of Oxygen consumed and of Carbonic acid given off, and the degree of Heat liberated. In the cold-blooded animals, whose tem-

* This subject is more fully treated in the Author's Principles of General and Comparative Physiology, §§ 548—567.

† See the very interesting experiments of MM. Vrolik and Vriese, in the Ann. des Sci. Nat., N. S. Botan., tom. xi, p. 551.

perature is almost entirely dependent upon that of the surrounding element, the respiration is feeble, being carried on, for the most part, through the medium of water. In the warm-blooded Vertebrata, however, which have the power of keeping up the heat of their bodies to an elevated standard, even when that of the surrounding air is far beneath it, the quantity of oxygen consumed is very large; and that required by Birds is more, in proportion to their size, than that employed by Mammalia; as we should expect from the more elevated temperature of the former. In the class of Insects, we have a very remarkable illustration of the same general fact. It appears, from the researches of Mr. Newport, that Insects, during their larva and pupa states, and even in their perfect condition when at rest, are to be regarded as truly cold-blooded animals; their temperature rising and falling with that of the surrounding medium, and being at no time more than a degree or two above it. In a state of activity, however, the temperature of the body attains a considerable elevation,—frequently as much as 10° or 15° above that of the air. It must be remembered that, owing to their larger extent of surface in proportion to their bulk, small animals are cooled much more rapidly than large ones; and the temperature of Insects would probably rise much higher, if it were not for the loss they are thus continually experiencing, which is greatly increased by the action of the wings. In one of Mr. N.'s experiments, a single Humble-bee, in a state of violent excitement, communicated to three cubic inches of air as much as 4° of heat within five minutes; its own temperature being raised 7° in the same time. When several individuals in a state of excitement, however, are clustered together, so that the loss of heat is prevented, the elevation of temperature is much more considerable; thus a thermometer introduced among seven "Nursing-Bees" stood at $92\frac{1}{2}^{\circ}$, whilst the external air was only 70° ; and the temperature of a hive was raised by disturbing it, during winter, from $48\frac{1}{2}^{\circ}$ to 102° , the temperature of the air being only $34\frac{1}{2}$ at the time! In all these instances, the amount of Oxygen consumed bears an exact proportion to that of the Heat evolved.

890. In the higher animals, as in the lower, exercise has a considerable effect in producing an elevation of temperature; and, that this is not merely due to the acceleration of the circulation, is shown by the very curious fact, that the exercise of a particular muscle will cause an increase in the heat liberated from it, as shown by needles plunged in its substance, and connected with the thermo-multiplier.* It may, indeed, be stated as a general proposition, applicable as well to different parts of the same being, as to different individuals, that the development of Heat is proportional to the activity of the molecular processes which constitute the functions of Nutrition, Secretion, &c.; increasing with their activity, and diminishing with their torpor. It is very easy to explain, on this principle, the known influence of the Nervous system on the calorific function: since, although the molecular changes in the organized fabric are not dependent upon the agency of that system, they are very much influenced by it; and thus we can readily understand how a state of nervous excitement may produce an elevation of temperature, whilst a depression of nervous power occasions a cooling of the body. The experiments of Sir B. Brodie, Chossat, and others,—in which a greater or less portion of the nervous centres was removed, and the animal cooled notwithstanding the maintenance of the circulation,—by no means prove that the Nervous system is directly concerned in the production of heat; since in all such experiments, there is a gradual loss of those other vital powers, which are concerned in the function of calorification. From the experiments of Dr. W. Philip and Dr. Hastings, it appears that an animal whose nervous centres have been removed, cools much faster when left to itself, than when Artificial Respiration is practised; and that, if the cooling have made much progress before the artificial respiration is caused to commence, the temperature may be raised;—and this, too, in spite of the very imperfect manner in which natural Respiration is replaced by movements artificially effected.

891. That the maintenance of Animal Heat is due in part to those molecular changes, to which the Cutaneous Respiration is subservient, appears from

* See the experiments of MM. Becquerel and Breschet, in *Ann. des Sci. Nat. N. S. Zool.*, tom. vi.

the following experiments recently performed by MM. Becquerel and Breschet. The hair of Rabbits was shaved off, and a composition of glue, suet, and resin, forming a coating through which air could not pass, was applied over the whole surface. It might seem natural to suppose that, by preventing the evaporation of the sweat, the temperature of the tissues would be very sensibly increased; and that, by this increase of the temperature of the whole body, a high state of fever would be engendered, with the symptoms of which the animal would at last die. But the contrary occurred. In the first Rabbit, which had a temperature of 100° before being shaved and plastered, it had fallen to $89\frac{1}{2}^{\circ}$ by the time the material spread over him was dry. An hour after, the thermometer placed in the same parts (the muscles of the thigh and chest) had descended to 76° . In another Rabbit, prepared with more care, by the time that the plaster was dry, the temperature of the body was not more than $5\frac{1}{2}^{\circ}$ above that of the surrounding medium, which was at that time $69\frac{1}{2}^{\circ}$; and in an hour after this, the animal died. These experiments place in a very striking point of view the importance of the Cutaneous surface as a respiratory organ, even in the higher animals: and they enable us to understand how, when the secreting power of the Lungs is nearly destroyed by disease, the heat of the body is kept up to its natural standard by the action of the Skin. A valuable therapeutic indication, also, is derivable from the knowledge which we thus gain, of the importance of the Cutaneous Respiration; for it leads us to perceive the desirableness of keeping the skin moist, in those febrile diseases in which there are great heat and dryness of the surface, since secretion cannot properly take place through a dry membrane. Of the relief afforded by cold or tepid sponging in such cases, experience has given ample evidence.

892. All the foregoing facts point to the formation of Carbonic Acid, by the union of the Oxygen absorbed from the air with Carbon set free from the body, as the main source of the evolution of Heat within the Animal system. The precise mode in which this union is accomplished, is not yet known; but it is certain that, in whatever manner the combination may take place, a certain measure of caloric *must* be generated. The combustion of from 5 to 10 oz. of Carbon per day, however, would be by no means sufficient to keep up the temperature of the Human body to its proper standard; for it has been experimentally ascertained, that the amount of Caloric set free by a warm-blooded animal in a given time is more than can be thus accounted for. It does not hence follow, however, that we are to look to any other than Chemical processes, for the explanation of this most important function; since there can be no doubt that there are many other changes of composition, continually taking place in the living body, which have their share in the production of the effect. These take place, for the most part, at the expense of the *surplus* of Oxygen absorbed over that which is given out in the form of Carbonic Acid; this surplus amounting to as much as 15 per cent. of the whole (§ 766). Of the manner in which this surplus is employed, no precise account can be given; but there can be little doubt that part of it is expended in uniting with Hydrogen, to form a portion of the watery vapour which is exhaled from the lungs; and that another part unites with the Phosphorus and Sulphur which are taken in as food (forming part of the proteine-compounds (§ 114), to be excreted as Phosphates and Sulphates (§ 847). These and other changes, in which the absorbed Oxygen participates, will be attended with the evolution of Caloric; and thus we are probably to account for the excess of Heat generated by a warm-blooded animal in a given time, above that which would be produced by the combustion of the amount of Carbon exhaled by it during the same period; as shown in the experiments of Dulong

and Despretz.* Although, therefore, the Chemical doctrine of Calorification cannot be regarded as yet perfected as to its details, there can be no reasonable doubt that it is altogether sufficient to account for the phenomena in question. And it may be stated as a general fact, that the production of Animal Heat is due to the various changes in Chemical composition, that are continually taking place within the system; of which changes, the absorption of Oxygen, and the disengagement of Carbonic Acid, are the two chief external manifestations:—and that the degree of Caloric liberated bears a close relation to the activity of these changes, either in regard to the body at large, or to any portion of it.

893. The researches of Dr. Edwards upon Animal Heat have brought to light some very interesting facts, regarding the diversity which exists as to the power of generating heat, in the same species of animal, at different ages, and at different periods of the year.

a. It appears to be a general fact, that the younger the animal, the less is its independent calorifying power. The development of the embryo of oviparous animals is entirely dependent upon the amount of external warmth supplied to it; and there are many kinds of Birds, which, at the time they issue from the egg, are so deficient in the power of generating heat, that their temperature rapidly falls, when they are removed from the nest and placed in a cold atmosphere. It was shown by collateral experiments, that the loss of heat was not to be attributed to the absence of feathers, nor to the extent of surface exposed in comparison with the bulk of the body; and that nothing but an absolute deficiency in the power of generating it, would account for the fall of temperature. This is quite conformable to facts well ascertained in regard to Mammalia. The fetus, during intra-uterine life, has little power of keeping up its own temperature; and in many cases it is much dependent on external warmth, for some time after birth. The degree of this dependence, however, differs greatly in the various species of Mammalia, as among Birds: being less, in proportion as the general development is advanced. Thus, young Guinea pigs, which can run about and pick up food for themselves almost as soon as they are born, are from the first independent of parental warmth; whilst, on the other hand, the young of Dogs, Cats, Rabbits, &c., which are born blind, and which do not, for a fortnight or more, acquire the same development with the preceding, rapidly lose their heat when withdrawn from contact with the body of the mother.

b. In the Human species it is well known, that external warmth is necessary for the Infant; but the fact is too often neglected (under the erroneous idea of hardening the constitution) during the early years of childhood. It is to be carefully remembered, that the development of Man is slower than that of any other animal; and that his calorifying power is closely connected with his general bodily vigour. In the case of children born very prematurely, the greatest attention must be given to the sustenance of the heat of the body (§ 932); and though the infant becomes more independent of it as development advances, it is many years before the standard can be maintained without assistance, throughout the ordinary vicissitudes of external temperature. The calorifying power, which is fully possessed by adults, decreases again in advanced age. Old people complain that their “blood is chill;” and they suffer greatly from exposure to cold, the temperature of their whole body being lowered by it.

c. These facts have a very interesting connection with the results of statistical inquiries, as to the average number of deaths at different seasons, recorded by M. Quetelet.†

* It has been recently shown by Liebig, that the discrepancy between the actual amount of heat generated, and the amount which was calculated to have been produced by the union of Carbon and Hydrogen with Oxygen, to form the Carbonic Acid and Water exhaled, in these experiments, may be nearly reconciled by adopting a more correct estimate of the heat generated by combustion of given quantities of Carbon and Hydrogen respectively. But all these calculations proceed upon the supposition, that the whole amount of Oxygen absorbed, which is not exhaled as Carbonic acid, is exhaled in combination with Hydrogen, as Water; and thus no account is taken of other combustion-processes going on in the body, by which a greater amount of heat may be generated, than by the combustion of Hydrogen. We have no means whatever of ascertaining how much of the watery vapour thrown off by the lungs and skin is actually formed within the body, and how much is the mere superfluity of the liquid ingested.

† *Essai de Physique Sociale*, tom. i. p. 197.

	First Month.	2—3 Years.	8—12 Years.	25—30 Years.	50—65 Years.	90 Years and above.
January	1·39	1·22	1·08	1·05	1·30	1·58
February	1·28	1·13	1·06	1·04	1·22	1·48
March	1·21	1·30	1·27	1·11	1·11	1·25
April	1·02	1·27	1·34	1·06	1·02	0·96
May	0·93	1·12	1·21	1·02	0·93	0·84
June	0·83	0·94	0·99	1·02	0·85	0·75
July	0·78	0·82	0·88	0·91	0·77	0·64
August	0·79	0·73	0·82	0·96	0·85	0·66
September	0·86	0·76	0·81	0·95	0·89	0·76
October	0·91	0·78	0·76	0·93	0·90	0·74
November	0·93	0·91	0·80	0·97	1·00	1·03
December	1·07	1·01	0·96	0·97	1·15	1·29

We see from this table that, during the first month of infant life, the external temperature has a very marked influence; for the average mortality during each of the three summer months being 80, that of January is nearly 140, and the average of February and March is 125. This is confirmed by the result obtained by MM. Villermé and Milne-Edwards, in their researches on the mortality of the children conveyed to the Foundling Hospitals in the different towns in France; for they not only ascertained that the mortality is much the greatest during the first three months in the year, but also that it varies in different parts of the kingdom, according to the relative severity of the winter. As childhood advances, however, the winter mortality diminishes, whilst that of the spring undergoes an increase; this is probably due to the greater prevalence of certain epidemics at the latter season; for the same condition is observed, in a still more remarkable degree, between the ages of 8 and 12 years,—the time when children are most severely affected by such epidemics. As the constitution acquires greater vigour, and the bodily structure attains its full development, the influence of the season upon mortality becomes less apparent; so that at the age of from 25 to 30 years, the difference between the summer and winter mortality is very slight. This difference reappears, however, in a very marked degree, at a later period, when the general vigour, and the calorifying power, undergo a gradual diminution. Between the ages of 50 and 65 it is nearly as great as in early infancy; and it gradually becomes more striking, until, at the age of 90 and upwards, the deaths in January are 158, for every 64 in July (a proportion of $2\frac{1}{2}$ to 1); and the average of the three winter months is 145, whilst that of the three summer months is only 68, or less than one-half.

894. Not only does the same individual possess different degrees of calorifying power, at different periods of his life, but also at different seasons of the year.

a. Dr. Edwards found that Sparrows, when exposed for some time to a temperature of 32° during the summer, rapidly lost heat, the refrigeration during 3 hours being from 6 to 21 degrees; but that, when they were placed in the same circumstances during winter (after having been accustomed to a warm temperature) the refrigeration was much less, not being in any instance more than 2° in 3 hours. Although it would be difficult to prove the fact experimentally in regard to Man, there can be little doubt that he shares with the other Mammalia in this variation. It is well known that the general vigour of the system is less in summer than in winter; in hot climates than in moderately cold. Moreover, we continually experience the great discomforts of a cold day in summer; when, our system not being prepared for it, we can less readily maintain our temperature at its normal standard. The practical inference,—that we should be much on our guard against exposure to low temperatures during summer,—is one of much importance; and its value has been fully confirmed by experience. The same principle may also be applied to the explanation of the well-known fact, that those who have been long resident in warm climates feel the cold acutely; whilst those who have been inured to cold are able to resist it much better, than those who are exposed to it for the first time. The former have a continued *summer* constitution; and their system not being called upon by its external conditions to produce much heat, the power is after a time partially lost. On the other hand, those who live in cold climates have a perpetual *winter* constitution (as it were) established; and the amount of heat generated by them is much greater. It will be obvious that this must be the case, if Man's capability of living under the greatest varieties of climate be sufficiently considered. From Dr. E.'s experiments it appears, that every month makes an evident difference in the

seasonal degree; the heat lost by Sparrows in August being much less than that lost by birds of the same species in July.

895. Our knowledge of the dependence of all the vital processes in warm-blooded animals, upon the Heat of their bodies,—and of the dependence of their Calorifying power upon the due supply of material for the Chemical changes which generate Heat,—has lately received some very remarkable additions from the experiments of M. Chossat.* He found that Birds, when totally deprived of food and drink, suffered a progressive, though slight, daily diminution of temperature. This diminution was not so much shown by a fall of their maximum heat, as by an increase in the diurnal variation, which he ascertained to occur even in the normal state. The amount of this variation, in Birds properly supplied with food, is about $1\frac{1}{2}^{\circ}$ Fahr. daily; the maximum being about noon, and the minimum at midnight. In the *inanitated* state, however, the average variation was about 6° , gradually increasing as the animal became weaker: moreover, the gradual rise of temperature, which should have taken place between midnight and noon, was retarded; whilst the fall subsequently to noon commenced much earlier than in the healthy state; so that the *average* of the whole day was lowered by about $4\frac{1}{2}^{\circ}$ between the *first* and the *penultimate* days of this condition. On the *last* day, the production of Heat diminished very rapidly, and the thermometer fell from hour to hour, until death supervened; the whole loss on that day being about 25° Fahr., making the *total* depression about $29\frac{1}{2}^{\circ}$. This depression appears, from the considerations to be presently stated, to be the *immediate* cause of Death.—On examining the amount of loss sustained by the different organs of the body, it was found that 93 per cent. of the *Fat* had disappeared,—all, in fact, which *could* be removed; whilst the Nervous Centres scarcely exhibited any diminution in weight. The loss of weight of the *whole body* averaged about 40 per cent.; and that of the various other component tissues was very much what might have been anticipated. From the constant coincidence between the entire consumption of the Fat, and the depression of Temperature,—joined to the fact that the duration of life under the inanitating process evidently varied (other things being equal) with the amount of Fat previously accumulated in the body,—the inference seems irresistible, that the Calorifying power depended chiefly, if not entirely, on the materials supplied by this substance. The maintenance of the normal amount of matter in the Nervous centres, is a very remarkable fact; and seems to countenance the idea, that the substances peculiar to Nervous tissue may be formed from Fatty matter, rather than from a Proteine-compound (§ 249).

896. Whenever, therefore, the store of combustible matter in the system was exhausted,—whether by the Respiratory process alone, or by this in conjunction with the conversion of Adipose matter into the materials for the Nervous or other tissues,—the inanitated animals died, by the cooling of their bodies consequent upon the loss of Calorifying power. That this is the real explanation of the fact, is shown by the results of a series of very remarkable experiments performed by M. Chossat, with a view of testing the correctness of this view. When inanitated animals whose death seemed impending (in several instances death actually took place, whilst the preliminary processes of weighing, the application of the thermometer, &c., were being performed), were subjected to artificial heat, they were almost uniformly restored from a state of insensibility and want of muscular power to a condition of comparative activity; their temperature rose, their muscular power returned, they flew

* Recherches Expérimentales sur l'Inanition, Paris, 1843. See, also, the Brit. and For. Med. Rev. for April, 1844.

about the room and took food when it was presented to them ; and, if the artificial assistance was sufficiently prolonged, and they were not again subjected to the starving process, most of them recovered. If they were left to themselves too early, however, the digestive process was not performed, and they ultimately died. Up to the time when they began to take food, their weight continued to diminish ; the secretions being renewed, under the influence of artificial heat, sometimes to a considerable amount. It was not until Digestion had actually taken place (which, owing to the weakened functional power, was commonly many hours subsequently to the ingestion of the food), that the animal regained its power of generating heat ; so that, if the external source of heat was withdrawn, the body at once cooled : and it was not until the quantity of food actually *digested* was sufficient to support the wants of the body, that its independent power of Calorification returned. It is to be remembered that, in such cases, the resources of the body are on the point of being completely exhausted, when the attempt at re-animation is made ; consequently it has nothing whatever to fall back upon ; and the leaving it to itself *at any time* until fresh resources have been provided for it, is consequently as certain a cause of death, as it would have been in the first instance.—It can scarcely be questioned, from the similarity of the phenomena, that Inanition, with its consequent depression of temperature, is the immediate cause of death in various Diseases of Exhaustion ; and it seems probable that there are many cases, in which the depressing cause is of a temporary nature, and in which a judicious and timely application of artificial Heat might prolong life until it has passed off,—just as artificial Respiration is serviceable in cases of Narcotic Poisoning (§ 885). It is especially, perhaps, in those forms of Febrile disease, in which no decided lesion can be discovered after death, that this view has the strongest claim to reception ; but many other cases will occur to the intelligent Practitioner.*

897. Having thus considered the means, by which the degree of Heat necessary for the performance of the functions of the Human system is generated, we have to inquire how its temperature is prevented from being raised too high ; in other words, what *Frigorifying* means there are, to counter-balance the influence of causes, which in excess would otherwise be fatal, by raising the heat of the body to an undue degree. How is it, for example, that, when a person enters a room whose atmosphere is heated to one or two hundred degrees above his body, the latter does not partake of the elevation, even though exposed to the heat for some time ? Or, since the inhabitants of a climate where the thermometer averages 100° for many weeks together, are continually generating additional heat in their own bodies, how is it that this does not accumulate, and raise them to an undue elevation ? The means provided by Nature for cooling the body when necessary, are of the simplest possible character. From the whole of its soft moist surface, simple *Evaporation* will take place at all times, as from an inorganic body in the same circumstances ; and the amount of this will be regulated merely by the condition of the atmosphere as to warmth and dryness. The more readily watery vapour can be dissolved in atmospheric air, the more will be lost from the

* The beneficial result of the administration of Alcohol in such conditions, and the large amount in which it may be given with impunity, may probably be accounted for on this principle. That it is a specific stimulus to the Nervous system, cannot be doubted from its effects on the healthy body ; but that it serves as a *fuel* to keep up the Calorifying process, appears equally certain. Now its great efficacy in such cases seems to depend upon the readiness with which it will be taken into the Circulation, by a simple act of Endosmotic Imbibition, when the special Absorbent process dependent upon the peculiar powers of the cells of the villi (§ 181), is in abeyance. There is no other combustible fluid, whose density, relatively to that of the Blood, will permit of its rapid Absorption by the simple physical process adverted to.

surface of the body in this manner. In cold weather, very little is thus carried off, even though the air be dry; and a warm atmosphere, already charged with dampness, will be nearly as ineffectual. But simple evaporation is not the chief means by which the temperature of the body is regulated. The Skin, as already mentioned (§ 868), contains a large number of glandulæ, the office of which is to secrete an aqueous fluid; and the amount of this *Exhalation* appears to depend solely or chiefly upon the *temperature* of the surrounding air. Thus, when the external heat is very great, a considerable amount of fluid is transuded from the skin; and this, in evaporating, converts into latent heat a large quantity of the free caloric, which would otherwise raise the temperature of the body. If the atmosphere be hot and dry, and also be in motion, both *Exhalation* and *Evaporation* go on with great rapidity. If it be cold, both are checked,—the former almost entirely so; but if it be dry, some evaporation still continues. On the other hand, in a hot atmosphere, saturated with moisture, *Exhalation* continues, though *Evaporation* is almost entirely checked; and the fluid poured out by the exhalant glands accumulates on the skin. There is reason to believe that the secretion continues, even when the body is immersed in water, provided its temperature be high.—We learn from these facts the great importance of not suddenly checking *Exhalation*, by exposure of the surface to cold, when the secretion is being actively performed; since a great disturbance of the circulation will be likely to ensue, similar to that which has been already mentioned, as occurring when other important secretions are suddenly suspended.

CHAPTER XVII.

OF REPRODUCTION.

1.—*General Character of the Function.*

898. THE Function of Reproduction has been commonly regarded as so entirely different in character from the ordinary Nutritive processes, that no analogy can be drawn between them. The results of late inquiries, however, leave no doubt that the difference between them is extremely small,—having, in fact, a relation rather to the *object* of the action, than to the mode in which it is performed. In the ordinary function of Nutrition, there is a continual regeneration or reproduction of the tissues and organs of the body; but the new parts are destined still to constitute the same *whole*. On the other hand, in Reproduction, the newly-formed parts are destined from the first to be cast off from the parent structure, and to become new individuals. Still, their origin is essentially the same in both instances; as appears from the mode in which the multiplication of the lower Plants and Animals takes place. Thus in the simplest Cryptogamia, such as the Yeast Fungus,* every single cell may be regarded as a distinct individual; since it is capable of living by itself, and of generating new cells; and thus the production of a new cell, in connection with the original one, may be regarded as alike an act of Nutrition and of Reproduction. So again, in the Hydra and other Polypes, the remarkable power of reparation which is manifested in their Nutritive operations,

* See Principles of General and Comparative Physiology, § 98.

may be employed in generating new individuals; since, when the body is divided into numerous parts, each one of these has the power of developing all the rest of the structure, and thus of becoming a complete animal (§ 9). Still we find in most Plants, and in all Animals, some portion of the structure specially designed to form and to set free germs, which are destined to become new individuals; and it is in the liberation and development of these, that the function of Reproduction essentially consists.

899. In Plants it is very evident that these germs differ but little from those which elsewhere produce new cells (§ 122); and that the first aspect of the new being is neither more nor less than a single cell, in which all the other cells of the structure subsequently originate. In the Cryptogamia, the cell-germs are contained in what is termed the *spore*; and, when liberated from the parent, they are developed into cells without any further assistance than that which they derive from the air, moisture, &c., that surround them. In Flowering Plants, on the other hand, the cell-germs are conveyed into a new set of organs, in which they are supplied with nutriment previously elaborated for them by the parent; and, in this manner, they are enabled to attain an ultimate development which is much higher than that of the Cryptogamia. It is now well established, that the *pollen-grain* of Phanerogamia is analogous to the spore of Cryptogamia; since it contains the reproductive granules, which are the germs of the first cells of the new individual. When the pollen-grains are cast upon the stigmatic surface, they project one or more long tubes, which insinuate themselves down the soft loose tissue of the style, and reach the ovarium. Into these tubes, the granules which the pollen-grain contained are seen to pass; and they are thus conveyed into the ovules, the foramina of which are penetrated by the extremities of the pollen-tubes. The ovules previously contained nothing but starchy matter; but from the time that the pollen-tubes have thus implanted (as it were) their contents in their cavity, they may be considered as fecundated. The subsequent growth of the embryo from the first-formed cells, takes place according to the principles already stated, under the head of Nutrition; and thus it is seen, that the mysterious process of Reproduction evidently consists, in Flowering Plants, of nothing else than the implantation of a cell-germ prepared by the *male* organs, in a nidus or receptacle adapted to aid its early development, which nidus constitutes the essential part of the *female* system.

900. There is now good reason to believe that, in no Animals, is the Reproductive apparatus less simple than it is in the higher Plants;—that is to say, in every instance, two sets of organs, a *germ-preparing*, and a *germ-nourishing*, are present. These organs differ much in form and complexity of structure in the various tribes of Animals; but their essential function is the same in all. Those which are termed Male organs prepare and set free certain bodies, which, having an inherent power of motion, have been supposed to be independent Animalcules, and have been termed Spermatozoa; there is but little reason, however, to regard them in this light, since ciliated epithelium-cells may exhibit as much activity; and there is no evidence that their function is any higher than that of the pollen-tube of Plants, which conveys into the ovulum the germs of the first cells of the embryo. This view of the character of the Spermatozoa rests alike upon the nature of their movements, and the mode of their production.* Dr. Barry's observations on the history of the Ovum, and on the nature of the act of Fecundation (which will be presently given in some detail) have left scarcely any doubt, that this act consists in the introduction of some new element into the Ovule, through the medium of the Spermatozoa; the arrival of which at the surface of the ovary

* See Principles of General and Comparative Physiology, § 606.

had been more than once previously seen, and the penetration of which to the Ovum there was good reason to suspect: and these have been confirmed by the observations of Dr. A. Farre on the Ovum of the Earth-worm, which he has distinctly seen to be penetrated by Spermatozoa. The act of Fecundation is evidently analogous, therefore, in Animals, to the process which has been described as taking place in the Flowering Plants. In many of the lower tribes of Animals, the spermiatic fluid effused by an individual of one sex, comes into direct contact with the ova previously deposited by the other; but in all the higher tribes, as in Man, the act of fecundation is performed before, or shortly after the ova quit the ovarium. With these general views, we shall now be prepared to consider the share which each sex has in the Function of Reproduction.

2. *Action of the Male.*

901. The Spermiatic fluid secreted by the Testes of the Male (§ 867), differs from all other secretions, in containing a large number of very minute bodies, only discernible with a high power of the Microscope; and these, in ordinary cases, remain in active motion for some time after they have quitted the living body. The Human Spermatozoon (of which representations are given in Plate I., Fig. 18), consists of a little oval flattened body from the 1-600th to the 1-800th of a line in length, from which proceeds a long filiform tail gradually tapering to the finest point, of 1-50th or at most 1-40th of a line in length. The whole is perfectly transparent; and nothing that can be termed structure can be satisfactorily distinguished within it.* The movements are principally executed by the tail, which has a kind of vibratile undulating motion. They may continue for many hours after the emission of the fluid; and they are not checked by its admixture with other secretions, such as the urine and the prostatic fluid. Thus, in cases of nocturnal emission, the Spermatozoa may not unfrequently be found actively moving through the urine in the morning; and those contained in the seminal fluid collected from females that have just copulated, are frequently found to live many days. Their presence may be readily detected by a Microscope of sufficient power, even when they have long ceased to move, and are broken into fragments; and the Physician and the Medical Jurist will frequently derive much assistance from an examination of this kind. Thus, cases are of no uncommon occurrence, especially among those who have been too much addicted to sexual indulgence, in which seminal emissions take place unconsciously and frequently, and produce great general derangement of the health; and the true nature of the complaint is obscure, until the fact has been detected by ocular examination. Again, in charges of rape, in which evidence of actual emission is required, a microscopic examination of the stiffened spots left on the linen will seldom fail in obtaining proof, if the act have been completed: in such cases, however, we must not expect to meet with more than fragments of Spermatozoa; but these are so unlike anything else, that little doubt need be entertained regarding them. It has been proposed to employ the same test, in juridical inquiries respecting doubtful cases of death by suspension: seminal emissions being not unfrequent results of this kind of violence: but there are many obvious objections which should prevent much confidence being placed in it.†

* It has been asserted that distinct oral and anal orifices, with appearances of internal organs, have been seen in the Spermatozoa of certain Mammalia; but these observations have not been confirmed; and they are not borne out by the attentive examination of the larger Spermatozoa of other animals.

† See the Author's Article "Asphyxia," in the Library of Practical Medicine, and the authorities there referred to.

902. The mode of Evolution of Spermatozoa, which has been recently discovered by Wagner, is so different from the ordinary method of production amongst Animalcules, as of itself to indicate that the former cannot be referred to the same category with the latter. It may be best studied in those animals which only have a periodical fertility; and the Passerine Birds are among the most convenient subjects for the purpose. During the winter, the testes are small and almost bloodless, and no trace of Spermatozoa can be detected within them; on the return of spring, however, they undergo great enlargement and become almost gorged with blood, and the gradual steps of the evolution of the Spermatozoa may be easily observed. The fluid drawn from them is first seen to contain a number of granular corpuscles, resembling those known as the Seminal Granules in the human semen (delineated at *a*, Fig. 18, Plate I.); and in a short time there are seen, in addition to these, numerous rounded transparent vesicles, at first having but one nucleus, and afterwards presenting several. These nuclei bear a close resemblance to the granular corpuscles just mentioned; and it is probable that the former are to be regarded as cytoblasts, from which the Spermatoferous cells (shown, as existing in the human semen, in Fig. 19, Plate I.) are evolved. The nuclei seem afterwards to resolve themselves into a fine granular matter, which is diffused through the whole vesicle or "cyst of evolution;" and in this, a linear arrangement soon becomes perceptible. The lines become more and more distinct, and are at last seen to be evidently produced by the arrangement of the Spermatozoa, which lie side by side within the vesicle; and the form of this changes from a sphere to a long oval. After a time they break forth, but still adhere to each other for a short period, forming bundles, such as may often be met with in the human semen, when taken directly from the testis (Fig. 20, Plate I.).* That the Spermatozoa are the essential elements of the spermatic fluid, has been reasonably inferred from several circumstances, such as their absence or imperfect development in hybrid animals, which are nearly or entirely sterile; and the fact that Fecundation essentially consists in the direct communication of one of them with a certain point in the Ovum, appears too well established to admit of further doubt. Regarding the uses of the other constituents of the Semen, no sufficient account can be given.

903. The power of procreation does not usually exist in the Human Male, until the age of from 14 to 16 years; and it may be considered probable that no Spermatozoa are produced until that period, although a fluid is secreted by the testes. At this epoch, which is ordinarily designated as that of Puberty, a considerable change takes place in the bodily constitution: the sexual organs undergo a much-increased development; various parts of the surface, especially the chin and the pubes, become covered with hair; the larynx enlarges, and the voice becomes lower in pitch, as well as rougher and more powerful; and new feelings and desires are awakened in the mind. Instances, however, are by no means rare, in which these changes take place at a much earlier period; the full development of the generative organs, with manifestations of the sexual passion, having been observed in children of but a few years old. The procreative power may last, if not abused, during a very prolonged period. Undoubted instances of virility at the age of more than 100 years are on record; but in these cases, the general bodily vigour was preserved in a very remarkable degree. The ordinary rule seems to be, that sexual power is not retained by the male in any considerable degree, after the age of 60 or 65 years. To the use of the sexual organs for the continuance of his race,

* For a fuller account, with illustrations, of the development of the Spermatozoa, and its analogy with the formation of other tissues, see *Princ. of Gen. and Comp. Phys.*, §§ 430 and 607.

Man is prompted by a powerful Instinctive desire, which he shares with the lower animals. This Instinct, like the others formerly alluded to (§ 428—430), is excited by sensations; and these may either originate in the sexual organs themselves, or may be excited through the organs of special sensation. Thus in Man it is most powerfully aroused by impressions conveyed through the sight or the touch: in many other animals, the auditory and olfactive organs communicate impressions which have an equal power; and it is not improbable that, in certain morbidly-excited states of feeling, the same may be the case in ourselves. That local impressions have also a very powerful effect in exciting sexual desire, must have been within the experience of almost every one; the fact is most remarkable, however, in cases of Satyriasis, which disease is generally found to be connected with some obvious cause of irritation of the generative system, such as pruritus, active congestion, &c. That some part of the Encephalon is the seat of this as of other instinctive propensities, appears from the considerations formerly adduced; but that the Cerebellum is the part in which this function is specially located, cannot be regarded as by any means sufficiently proved (§§ 466—470). The instinct, when once aroused (even though very obscurely felt), acts upon the mental faculties and moral feelings; and thus becomes the source, though almost unconsciously so to the individual, of the tendency to form that kind of attachment towards one of the opposite sex, which is known as *love*. This tendency cannot be regarded as a simple passion or emotion, since it is the result of the combined operations of the reason, the imagination, and the moral feelings; and it is in the engraftment (so to speak) of the psychical attachment, upon the mere corporeal instinct, that a difference exists between the sexual relations of Man and those of the lower animals. In proportion as the Human being makes the temporary gratification of the mere sexual appetite his chief object, and overlooks the happiness arising from spiritual communion, which is not only purer but more permanent, and of which a renewal may be anticipated in another world,—does he degrade himself to the level of the brutes that perish. Yet how lamentably frequent is this degradation!

904. When impelled by sexual excitement, the Male seeks intercourse with the Female, the erectile tissue of the genital organs becomes turgid with blood (§ 748), and the surface acquires a much-increased sensibility; this is especially acute in the Glans penis. By the friction of the Glans against the rugous walls of the Vagina, the excitement is increased; and the impression which is thus produced at last becomes so strong, that it produces, through the medium of the Spinal Cord, a reflex contraction of the muscles which surround the Vesiculæ Seminales (§ 393). These receptacles discharge their contents (partly consisting of semen and partly of a secretion of their own) into the Urethra; and from this they are expelled with some degree of force, and with a kind of convulsive action, by its own Compressor muscles. Now although the sensations concerned in this act are ordinarily most acutely pleasurable, there appears sufficient evidence that they are by no means essential to its performance; and that the impression which is conveyed to the Spinal Cord need not give rise to a sensation, in order to produce the reflex contraction of the Ejaculator muscles (§ 372). The high degree of nervous excitement which the act of coition involves, produces a subsequent depression of corresponding amount; and the too frequent repetition of it is productive of consequences very injurious to the general health. This is still more the case with the solitary indulgence, which (it is to be feared) is practised by too many youths; for this, substituting an unnatural degree of one kind of excitement, for that which is wanting in another, cannot but be still more trying to the bodily powers. The secretion of seminal fluid being, like other secretions, very much under the control of the nervous system, will be increased by the

continual direction of the mind towards objects which awaken the sexual propensity (§ 626, *note*); and thus, if intercourse be very frequent, a much larger quantity will altogether be produced, although the amount emitted at each period will be less. The formation of the secretion seems of itself to be a much greater tax upon the corporeal powers, than might have been supposed *à priori*: and it is a well-known fact, that the highest degree of bodily vigour is inconsistent with more than a very moderate indulgence in sexual intercourse; whilst nothing is more certain to reduce the powers, both of body and mind, than excess in this respect. These principles, which are of great importance in the regulation of the health, are but results of the general law, which prevails equally in the Vegetable and Animal kingdoms,—that the Development of the Individual, and the Reproduction of the Species, stand in an inverse ratio to each other.

3.—Action of the Female.

905. The essential part of the Female Generative system is that in which the Ova are prepared; the other organs are merely accessory, and are not to be found in a large proportion of the Animal kingdom. In many of the lower animals, the Ovaria and Testes are so extremely like each other, that the difference between them can scarcely be distinguished; and the same has already been stated, regarding the condition of these organs in Man, at an early period of development (§ 866 *b*). The fact is one of no small interest. In the lower animals, the Ovarium consists of a loose tissue containing many cells, in which the Ova are formed, and from which they escape by the rupture of the cell-walls; in the higher animals, as in the Human female, the tissue of the Ovarium is more compact, forming what is known as the *stroma*; and the Ova, except when they are approaching maturity, can only be distinguished in the interstices of this, by the aid of a high magnifying power. We owe to Dr. Barry the discovery of the earliest stages in the production of the Ovum and its accessory parts, in Mammalia and other Vertebrata. In order to understand his account, however, it will be necessary that the parts of which the ovum consists should be previously understood.—Taking the Fowl's Egg as a familiar illustration, it must be remarked, in the first place, that neither the albumen which forms the *white*, nor the shell-membrane with its testaceous covering, exist in the Ovarian Ovum; these portions being added during its passage along the oviduct. The parts which we have to analyze, are the Yolk-membrane and its contents. Within the Yolk-membrane, we find in the first place, the Yolk itself; a substance consisting in part of albuminous granules, and in part of oily globules. Towards the centre, the character of the Yolk in some degree changes; its colour being lighter, and the granules presenting more the appearance of cells, with minuter globules in their interior. The central portion is termed the *discus vitellinus*. Occupying the centre of the yolk (in the immature ovulum) is a large cell, very distinct in aspect from the rest, and having a well-marked nucleus upon its walls. This is termed the *germinal vesicle*; and the nucleus, the *germinal spot*.—The Mammalian Ovum contains exactly the same parts; but the yolk is much smaller in proportion, and corresponds in character rather with the *discus vitellinus*, than with the whole yolk of the Bird's egg. The Ovum in all Vertebrated animals is produced within a capsule or bag, the exterior of which is in contact with the stroma of the ovarium; this has been termed in Mammalia, the *Graafian follicle*, after the name of its first discoverer; but the more general and appropriate designation of *Ovisac* has been given to it by Dr. Barry, who has shown that it exists in other classes of Vertebrata. Between the Ovum and the Ovisac, in Oviparous animals, there is scarcely any interval; but in the

Mammalia, a large amount of granular matter is present; and this arranges itself into some peculiar structures discovered by Dr. Barry, and presently to be described. The membrane which surrounds the yolk in Mammalia has received, on account of its thickness and peculiar transparency, the designation of *zona pellucida*.—The several parts of the Ovum now described are shown in Fig. 5, Plate I.

906. From the researches of Dr. Barry on the early development of the Ovum, it appears that the Germinal Vesicle is the part which can first be distinctly traced. In Fig. 1 (Plate I.) is seen a representation of one of its incipient stages in the Rabbit; there is nothing here visible, but a collection of very transparent vesicles, surrounded by a mass of dark granules. In the succeeding stage, represented in Fig. 2, some of the vesicles have enlarged, and the granules immediately surrounding them have become developed into cells. A more advanced condition is represented (on a smaller scale) in Fig. 3; in which a distinct spot (*b*) is seen on the central vesicle (*a*), marking it as the Germinal Vesicle; whilst many of the granules surrounding it have become cells, and have taken on a very regular arrangement. After a time, a membrane forms around each cluster of granules, separating it from the stroma of the ovarium; this is the Ovisac. At a later period, a separation takes place between the inner and outer portions of the mass of granular matter, included between the ovisac and the germinal vesicle; and the separation is completed by the development of a membrane, which envelops the inner stratum. This stratum becomes the Yolk, and includes most of the oil-particles which previously existed within the ovisac; whilst the portion of the granular mass, exterior to this, gives origin in Mammalia to certain structures of a very peculiar character, which seem to be concerned in the liberation of the ovum from the Graafian follicle or Ovisac. The appearance of the Human Ovisac and its contents is seen in Fig. 4. The granules immediately surrounding the Ovum assume the appearance of cells; and these unite to form a sort of membrane, to which the name of *tunica granulosa* has been given. This is seen at *t g* (Fig. 7). The granules lining the Ovisac also combine themselves into a membranous structure; to which Dr. Barry has given the designation of *membrana granulosa* (*g g*, Fig. 6). These are connected by four band-like extensions of the same cellulo-membranous structure, which seem to suspend the ovum in its place; and these are called *retinacula* (*r r*, Figs. 6 and 7). The space between the Tunica Granulosa and the Membrana Granulosa, which is not occupied by the Retinacula, is filled with fluid, in which few or no cells can be seen. The uses of this structure, so far as they are apparent, will be described, when the processes by which the Ovum escapes from the Ovary are detailed.

907. The Ovisac does not form the entire structure which has been described as the Graafian follicle; for this consists of two layers, of which the inner one is the true Ovisac, whilst the outer results from a thickening and condensation of the surrounding layer of the Stroma of the Ovarium. It is the outer layer only which is vascular; the inner presents no trace of structure; and the increase of the ovum must take place by simple imbibition, through it, of the supply of nutritive matter brought into contact with its exterior. The Ovarium may be seen, even in the fetal animal, to contain immature Ova; in which the several parts can be clearly distinguished. At a later period, however, the number of Ova greatly increases; and the development of some advances, whilst others degenerate. According to the recent valuable inquiries of Dr. Ritchie,* it appears that, even during the period of childhood, there is a continual rupture of Ovisacs, and discharge of Ova, at the surface of the

* London Medical Gazette, 1844.

Ovarium. The Ovaria are studded with numerous minute copper-coloured maculæ; and their surface presents delicate vesicular elevations, which are occasioned by the most matured ovisacs: the debiscence of these takes place by minute punctiform openings in the peritoneal coat; and no cicatrix is left. At the period of puberty, the stroma of the ovarium is crowded with Ovisacs; which are still so minute, that in the Ox (according to Dr. Barry's computation) a cubic inch would contain 200 millions of them. The greatest advance is seen in those which are situated nearest the surface of the Ovarium; and in these, the Graafian follicle with its two coats, may be distinctly traced. It is curious that the outer wall (which is itself a part of the condensed stroma of the ovarium) should contain an immense number of minute ovisacs; so that this, in the adult animal, is the most convenient situation in which to view them: these ovisacs have been termed by Dr. Barry "parasitic ovisacs." In those animals whose aptitude for conception is periodical, the development of the Ova, to such a degree that they become prepared for fecundation, is periodical also. This development becomes evident, when the parts are examined in an animal which is "in heat," by the projection of the Graafian follicles from the surface; and it consists not merely in an increase of size, but in certain internal changes presently to be described.

908. In the Human female, the period of Puberty, or of commencing aptitude for procreation, is usually between the 13th and 16th year; it is earlier in warm climates than in cold;* and in densely-populated manufacturing towns, than in thinly peopled agricultural districts. The mental and bodily habits of the individual have also a considerable influence upon the time of its occurrence; girls brought up in the midst of luxury or sensual indulgence, undergoing this change earlier than those reared in hardihood and self-denial. The changes in which Puberty consists, are for the most part connected with the Reproductive system. The external and internal organs of generation

[* It has been stated, by almost all physiological writers, that women reach maturity, and that menstruation commences much earlier in hot climates, particularly between the tropics, than in temperate and very cold countries. Haller states that in the warm regions of Asia, the catamenia appear from the 8th to the 10th year; and in Switzerland, Britain, and other temperate regions, at the age of 12 or 13, and later the farther we ascend towards the north. The same view has been held by nearly all subsequent writers on the subject, and they infer that animals, like plants, reach maturity sooner in hot than in cold climates. Dewees says that menstruation occurs later in our northern than in our southern states. From many elaborate and interesting papers which have been published within a few years, especially from those of Mr. Robertson of Manchester, it would seem that the natural period of puberty in women occurs in a much more extended range of ages, and is much more equally distributed through that range than others have alleged, and that, in other countries, the parallel between plants and fruits does not hold good.

At Gottingen, Oslander ascertained the ages at which 137 women began to menstruate. In 21 of these the catamenia appeared at 14; in 32 at 15; in 24 at 16; 9 at 12; and 1 not before the 24th year. The Indian girls in Canada, and in our north-western states and territories, begin to menstruate frequently at 12, 13 and 14. From the statement of Baron Humboldt, the same is equally true of the Korraies, and the tribes of northern Asia, where girls of 10 years are sometimes found mothers. The notion that women in Lapland do not menstruate till 20, and then only during summer, is founded on a mistake in Linnæus's *Flora Lapponica*. Tooke states that the Slavonian, or native Russians, reach puberty at an early age; and Dr. Robert Lee, who was in the Crimea, and all the Russian provinces along the Black Sea, and in the Ukraine, and whose opportunities of observation were extensive, says that his conviction is, that over the whole south of Russia the period of puberty is the same as in Great Britain; and that women cease to bear children at the same age. The same would appear to hold good in Java, and in all the islands of the Indian Archipelago, and in Sierra Leone; and the difference said to exist in Arabia in this respect is due to the early marriages, and universal licentiousness and depravity of morals in that country. It would appear from observations made in the West India Islands, that menstruation occurs there about the same period, and that the alleged difference in this respect between the negress and the white female does not exist.—M. C.]

undergo a considerable increase of size; the mammary glands enlarge; and a deposition of fat takes place in the mammae and on the pubes, as well as over the whole surface of the body,—giving to the person that roundness and fullness, which are so attractive to the opposite sex, at the period of commencing Womanhood. The first appearance of the Catamenia usually occurs whilst these changes are in progress, and is a decided indication of the arrival of the period of Puberty; but it is not unfrequently delayed much longer; and its absence is by no means to be regarded as a proof of the want of aptitude for procreation, since many women have borne large families, without having ever menstruated. The Catamenial discharge appears normally to consist of blood deprived of its fibrine; the fluid being composed of serum, in which red corpuscles are suspended, and being readily distinguishable from true blood by its want of power to clot. When clots are found in it, therefore, a morbid condition of the secreting surface must be inferred. The interval which usually elapses between the successive appearances of the secretion, is about four weeks; and the duration of the flow is from three to six days. There is, however, great variety in this respect among the inhabitants of different climates, and among individuals; in general, the appearance is more frequent, and the duration of the flow greater, among the residents in warm countries, and among individuals of luxurious habits and relaxed frame, than among the inhabitants of colder climes, or among individuals inured to bodily exertion. The first appearance of the discharge is usually preceded and accompanied by considerable general disturbance of the system; especially pain in the loins and a sense of fatigue in the lower extremities; and its periodical return is usually attended with the same symptoms, which are more or less severe in different individuals.

909. Much discussion has taken place respecting the causes and purposes of the Menstrual flow; and recent inquiries have thrown much light upon them. The state of the Female Generative system, during its continuance, appears to be analogous to the *heat* of the lower animals; many of which have a sero-sanguinolent discharge at that period. There is good reason to believe that in Women the sexual feeling becomes stronger at that epoch; and it is quite certain that there is a greater aptitude for Conception, immediately before and after Menstruation, than there is at any intermediate period. Observations to this effect were made by Hippocrates, and were confirmed by Boerhaave and Haller; indeed coitus immediately after menstruation appears to have been frequently recommended as a cure for sterility, and to have proved successful. It is well known that, among many of the lower animals, the Ova are entirely extruded by the Female, before the Spermatic fluid of the Male reaches them; and that even in Birds, this occasionally takes place. This question has been recently made the subject of special inquiry by M. Raciborski; who affirms that the exceptions to the rule—that Conception occurs immediately before or after, or during, Menstruation—are not more than 6 or 7 per cent. Indeed, in his latest work on this subject,* he gives the details of 15 cases, in which the date of Conception could be accurately fixed, and the time of the last appearance of the Catamenia was also known; and in all but one of them, the correspondence between the two periods was very close. Even in the exceptional case, the Catamenia made their appearance shortly after the Coitus; which took place at about the middle of the interval between the two regular periods. When Conception occurs immediately before the Menstrual period, the Catamenia sometimes appear, and sometimes are absent; if they appear, their duration is generally less than usual. The fact that Conception often takes place immediately *before* the last appearance

* Sur la Ponte des Mammifères. Paris, 1844.

of the Catamenia (and not *after* it, as commonly imagined), is one well known to practical men. Numerous cases have been collected by Mr. Girdwood, Dr. Robert Lee, MM. Gendrin, Negrier, Raciborski, and others, in which the Menstrual period was evidently connected with the maturation and discharge of Ova; but the most complete observations yet made upon this subject, are those of Dr. Ritchie (*loc. cit.*) He states that about the period of Puberty a marked change usually takes place in the mode in which the Ovisacs discharge their contents; but that this change does not necessarily occur simultaneously with the first appearance of the Catamenia; as in some cases the conditions, which obtain in the period before puberty, are extended into that of menstruation. The Ovaries now receive a much larger supply of blood; and the Ovisacs show a great increase in bulk and vascularity; so that, when they appear at the surface of the ovary, they present themselves as pisiform turgid elevations; and the discharge of their contents leaves a much larger cicatrix, and is accompanied by an effusion of blood into their cavity, with other subsequent changes, to be presently described. It would appear, however, that although such a discharge takes place *most frequently* at the Menstrual period, yet that the two occurrences are not necessarily co-existent; for menstruation may take place without any such rupture; whilst, on the other hand, the maturation and discharge of mature ova may occur in the intervals of Menstruation, and even at periods of life when that function is not taking place. The essential condition of Menstruation itself would appear to be the increased turgescence of the vessels of the Uterus; and the appearance, on its internal surface, of a meshwork of deciduous villous vessels, which may remain for at least two weeks. It is evident that this is a preparation for the formation of the Decidua (§ 919).

910. The duration of the period of aptitude for procreation, as marked by the persistence of the Catamenia, is more limited in Women than in Men; usually terminating at about the 45th year; it is sometimes prolonged, however, for ten or even fifteen years longer; but cases are rare in which women above 50 years of age have borne children. There is usually no Menstrual flow during Pregnancy and Lactation; in fact, the cessation of the Catamenia is generally one of the first signs, indicating that Conception has taken place. But it is by no means uncommon for them to appear once or twice subsequently to Conception; and in some women, there is a regular monthly discharge, though probably not of the usual secretion, through the whole period. Some very anomalous cases are recorded, in which the Catamenia never appeared at any other time than during Pregnancy; and were then regular. The absence of the Catamenia during Lactation is by no means constant, especially if the period be prolonged; when the Menstrual discharge recurs, it may be considered as indicating an aptitude for Conception; and it is well known that, although Pregnancy seldom recurs during the continuance of Lactation, the rule is by no means invariable.

911. The function of the Female, during the coitus, is entirely of a passive character. When the sexual feeling is strongly excited, there is a considerable degree of turgescence in the erectile tissue surrounding the vagina, and composing the greater part of the nymphæ and the clitoris; and there is also an increased secretion from the mucous follicles.* But these changes are by

[* The glands of Duverney have been lately (1840) very accurately described by Professor Tiedemann, his attention having been directed to these organs by the late Dr. Fricke, of Hamburg. These glands are situated at either side of the entrance of the vagina, beneath the integument covering the inferior part of the vagina, as well as the superficial perineal fascia, and the constrictor vaginae muscle. The space they occupy lies between the lower end of the vagina, the ascending ramus of the ischium, the crus clitoridis, and the erector clitoridis muscle. Superiorly are the fibres of the levator ani which are attached to the

no means necessary for effectual coition; since it is a fact well established, that fruitful intercourse may take place, when the female is in a state of narcotism, of somnambulism, or even of profound ordinary sleep. It has been supposed by some, that the os uteri dilates, by a kind of reflex action, to receive the semen; but of this there is no evidence. The introduction of a small quantity of the fluid just within the Vagina, appears to be all that is absolutely necessary for conception; for there are many cases on record, in which pregnancy has occurred, in spite of the closure of the entrance to the vagina by a strong membrane, in which but a very small aperture existed. That the Spermatozoa make their way towards the Ovarium, and fecundate the Ovum either before it entirely quits the Ovisac or very shortly afterwards, appears to be the general rule in regard to the Mammalia; and the question naturally arises,—by what means do they arrive there. It has been supposed that the action of the cilia, which line the Fallopian tubes, might account for their transit; but the direction of this is *from* the Ovaria towards the Uterus, and would therefore be opposed to it. A peristaltic action of the Fallopian tubes themselves may generally be noticed in animals killed soon after sexual intercourse; and in those which have a two-horned membranous Uterus, such as is evidently but a dilatation of the Fallopian tube, this partakes of the same movement, as may be well seen in the Rabbit: in animals, however, which have a single Uterus with thicker walls (as in the Human female), it must evidently be unavailable. Among the tribes whose Ova are fertilized out of the body, the power of movement inherent in the Spermatozoa is obviously the means by which they are brought in contact with the Ova: and it does not seem unreasonable to suppose, that the same is the case in regard to the higher classes; and that the transit of these curious particles, from the Vagina to the Ovaries, is effected by the same kind of action as that which causes them to traverse the field of the microscope.—We shall now consider the changes in the Ovum and its appendages, by which it is prepared for fecundation.

912. Up to the period when the Ovum is nearly brought to maturity, it remains in the centre of the Ovisac or inner layer of the Graafian follicle; and it is supported in its place by the Retinacula, which connect its Tunica Granulosa with the Membrana Granulosa that lines the ovisac. (See Fig. 6,

ischium, and behind these are the transversiperinei muscles. They are surrounded by very loose cellular tissue. They are rounded, but somewhat elongated, being flat and bean-shaped. Their long diameter is from 5 to 10 lines; their transverse diameter $2\frac{1}{2}$ to $4\frac{1}{4}$ lines, and they are from $2\frac{1}{4}$ to 3 lines thick. The excretory duct is at the anterior edge of the superior part of the gland, and runs beneath the constrictor vaginae, horizontally forwards and inwards, to the inner face of the nymphæ, opening in front of the carunculæ myrtiformes, in the midst of a number of small mucous follicles. These glands were first discovered by Duverney in the cow, about the middle of the seventeenth century. Bartholinus subsequently found them in the human female, and his observations were confirmed by Duverney, Morgagni, Santorini, Peyer, &c. Haller denied their existence; and such structure seems to have been forgotten until they were again described by Mr. Taylor (Dublin Journal, vol. xiii. 1838). They are analogous to Cowper's glands in the male, according to Tiedemann, and like them are sometimes wanting, and differ in size. In advanced age they are said to diminish in size, and even disappear. They are present in the females of all animals, where Cowper's glands exist in the males. They secrete a thick, tenacious, grayish-white fluid, which is emitted in large quantities, at the termination of the sexual act, most likely from the spasmodic contraction of the constrictor vaginae muscle, under which they lie. Its admixture with the male semen is supposed to probably have some connection with impregnation, and it has been suggested that it may be the vehicle of the fecundating principle of the semen. These glands were probably known to the ancients, and it is doubtless their secretion which Hippocrates and others describe as the female semen.—(1843.) These glands have lately been described by Huguier of Paris, in the *Archives d'Anatomie*. His description corresponds in every respect with that given above.—(1847.)—M. C.]

Plate I.) The Ovum then begins to move towards the periphery of the Graafian follicle; and always towards that point of it which is nearest the surface of the Ovary. This movement appears to be due, in the first instance, to the shortening of the Retinacula in that direction; and whilst the Ovum lies against the membrane of the Ovisac, a gradual thinning of the latter seems to take place. At the same time an important change is occurring in the outer wall of the Graafian follicle, especially at the part most deeply imbedded in the Ovary; its vascularity is greatly increased, and its substance appears thickened. This thickening is probably due to the deposition of blood in a state ready to become more highly organized, upon the exterior of the Ovisac; and the consequence of it is, that considerable pressure is made upon the contents of the follicle, the effect of which is, of course, exerted most upon the thinnest part of it. Thus, a sort of *vis à tergo* is exercised against the Ovum and the Disc (consisting of the tunica granulosa and the central part of the retinacula) in which it is imbedded; and the whole is forced, by the rupture of the Graafian follicle, into the funnel-shaped entrance of the Fallopian tube, —the Retinacula being gradually detached from the Membrana Granulosa, which is left behind. This action is represented in Fig. 8, Plate I. What becomes of the Ovisac is not certain. Dr. Barry affirms that he has sometimes known it to be subsequently expelled from the ovary; but it appears more commonly to coalesce with the surrounding envelope, and to constitute, together with it, the lining of the cavity, which is usually found in the *Corpus Luteum*. The substance known under this name is found in the Ovary, after the Ovum has escaped from it; and the importance of the question, how far its presence may be regarded as an indication that Conception has taken place, requires that we should have clear ideas respecting its nature.

913. The term *Corpus Luteum* has been usually applied to a reddish-yellow substance, glandular in aspect, friable in consistence, and very vascular; which occupies the part of the Ovary from which the germ has escaped, and is larger or smaller according to the length of time that has elapsed since conception. At first it is usually so large as to occasion a considerable projection on the surface of the Ovary; its form is oval, or resembles that of a bean. When cut across, its dimensions are usually found to be from 4 to 5-8ths of an inch in its long diameter, and from 3 to 4-8ths in its short; and it thus occupies from a fourth to a half of the whole area of the ovarium; but these dimensions are not unfrequently exceeded. The centre of this substance is hollow; and by a proper acquaintance with this character, the true *Corpus Luteum* may be distinguished from substances, bearing a general resemblance to it, but very different in their character. The following is Dr. Montgomery's account of it. "Its centre exhibits either a cavity, or a radiated or branching white line, according to the period at which the examination is made. If within the first three or four months after conception, we shall, I believe, always find the cavity still existing, and of such a size as to be capable of containing a grain of wheat at least, and very often of much greater dimensions; this cavity is surrounded by a strong white cyst; and as gestation proceeds, the opposite parts of this cyst approximate, and at length close together, by which the cavity is completely obliterated, and in its place there remains an irregular white line, whose form is best expressed by calling it radiated or stelliform. This is visible as long as any distinct trace of the *Corpus Luteum* remains."* The true *Corpus Luteum* is further distinguished by its capability of being injected from the vessels of the Ovary; which is not the case with Tubercular deposits, or other substances which may stimulate it. After Delivery, the size of the *Corpus Luteum* rapidly diminishes;

* Signs of Pregnancy, p. 226.

and in a few months it ceases to be recognizable as such. The cicatrix by which the Ovum has escaped is visible for some time longer; but this too, according to the careful researches of Dr. Montgomery, cannot be distinguished at a subsequent period. Hence there is no correspondence between the number of Corpora Lutea found in the ovaries of a woman, or of Cicatrices on their surface, and the number of children she may have borne. The number of Corpora Lutea must always be less, when there have been many conceptions; but the number of Cicatrices may be greater; for several causes, such as the escape of unimpregnated ova, or the bursting of little abscesses, may give rise to such appearances.

914. Much discussion has taken place amongst Embryologists, as to whether the substance of the Corpus Luteum is deposited *within* the Graafian follicle, *externally* to it, or *between* its layers. The first is the opinion of Baer, Bischoff, and others; who regarded it as a growth from the inner layer of the Graafian follicle. The second is the opinion of Dr. R. Lee and Mr. Wharton Jones. The third is the doctrine taught by Drs. Montgomery and Barry; the former regarding it, however, as deposited between the two layers, of which the cellulo-vascular layer of the Graafian follicle (which are *both* derived from the condensed stroma of the ovarium) consist; whilst the latter maintains that the deposit takes place between the true Ovisac and its Ovarian envelopes. The recent inquiries of Dr. Ritchie* throw great light on this question; by showing that a great variety of changes may take place, after the discharge of the Ovum from the Ovisac; amongst which may be included all the appearances described by the several writers just quoted. The following is an abstract of the results of Dr. R.'s researches.

a. The appearances presented by the Ovaries, Graafian follicles, and by the blood which is contained in the latter subsequent to their rupture, vary according to the time at which they are examined, and the absorbing power of the individual.—In cases of the recent discharge of an Ovum, the Peritoneal coat of the Ovary is marked by a jagged slit or opening, having a florid vascular areola; in those of longer standing, the opening is covered over,—with the exception of a minute circular foramen in the centre, (or where the slit has been of great length) of two such openings,—with new tissue, surrounded by a claret-coloured margin; and in those still more ancient, the whole is healed up into a cicatrix, which is more or less superficial and free from discoloration, according to its age.

b. With respect to the Blood, which is generally contained in the ruptured follicles, it is seen first as a florid coagulum; next, having only its centre scarlet-coloured, and its periphery more or less black, and perhaps furrowed; frequently the clot has a gamboge colour from the decomposition of its red corpuscles, or has become pale from their absorption; and lastly, the clot is found in different stages of absorption. But it sometimes also happens,—and that indifferently in every variety of the uterine state,—that the ruptured follicles are found empty, or containing only an aqueous fluid.

c. The coats of the ruptured Follicles have been found in *four* different general conditions, apparently dependent on their relative degree of organization; and each class presenting, also, modifications of their respective characteristics, proceeding in part from the same cause, and in part also from changes connected with the period of their progress in which they were examined.

i. The first class was distinguished by the attenuated state of the coats of the ruptured Follicle; and by the total absence of any organic changes in these, different from their condition previous to their discharge. The only alterations observable resulted from the mechanical dyeing of their coats of an inky-black, or of a yellow colour, proceeding from their contact with decomposed blood.—The first class of appearance was found indifferently in all ages and states, subsequent to puberty.

ii. The second general class of ruptured Follicles was characterized, in addition to the appearances just described, by organic changes in their coats; consisting, progressively, of an increased vascularity, a thickening, a whitening of the colour, and finally, a corrugation of their tissue. The white bodies thus formed, to which Dr. R. has given the designation of *Corpora Albida*, may exist under two distinct forms:—1. As *soft* bodies of a yellowish fatty aspect, having the outer coat much thickened, whilst their inner remains as a delicate dia-

* Medical Gazette, 1844.

phanous pellicle; these, after a lengthened period, present themselves as yellowish-white, and generally globular bodies, more or less fissured from their contraction, and sometimes in process of absorption, having a granular-looking structure, and seldom being divisible into laminae by simple dissection:—and 2. As *dense* bodies of a whitish, shining, firm structure, their inner coat being the seat of these changes, and their outer adhering loosely as a transparent peculiar layer; the inner layer presents itself as a thick, opaque, deeply-wrinkled or corrugated, and rocky cyst, or is sometimes partially diaphanous, and of a shining pearly aspect, and very white colour; and it sometimes contains a yellow, greenish, transparent fluid, or a clot of blood, either unchanged, or converted into a yellow or black pigment. This second variety appears to be the *Corpus Luteum* of Baer.—These white bodies, or *Corpora Albida*, were found by Dr. R. in every variety of uterine condition, subsequent to the establishment of menstruation, but never before it; and the dense kind, especially, were persistent for a long period. They had no necessary connection with the gravid condition; but they were occasionally (especially the dense variety) the only specialty observable in the ovaries of the puerperal female, some time after delivery.

III. The third class was characterized by the presence of an organized yellow-coloured brain-like, granular matter; forming bodies to which Dr. R. has given the name of *Corpora Cephaloidea*. These differed, according as the cerebriform matter was deposited between the layers of ruptured Follicles, having transparent pellicular walls, as in Class I., or having either their inner or outer coat thickened, as in Class II.;—or according as the cerebriform matter was deposited externally to the two inner layers of the Follicle.—The former of those varieties was found by Dr. Ritchie in menstruating females; also during the first months of the gravid state; and sometimes even in the period of lactation. In some instances, only one or two of the cerebriform bodies were found; but in others, five or six. Their structure, especially in the more perfectly-organized specimens, presented a striking resemblance to the convoluted reddish-yellow surface of the brain, covered by its inner membranes, and painted with its scarlet-coloured and dark vessels. These cephaloid bodies undergo diminution in proportion to their age, and the absorbing power of the female. In those possessed of only thin coats, or having the outer layer as the seat of the thickening, the inner walls of the cysts speedily contracted and coalesced; so that their centres exhibited a delicate opaque streak; or, in those better developed, a serrated, curved, and well-marked white line, according as the cyst was of elliptical or of a globular form. This variety of cerebriform cyst was met with in a recent state as well in immediate connection with the existence of menstruation, as during the first seven months of pregnancy; and in this latter case, by undergoing a conversion in its form presently to be noticed (IV), they constituted the *Corpora Lutea* of Dr. Montgomery.—In the second variety of Cephaloid bodies, the two inner layers of the Graafian Follicle were converted into a dense white body, surrounded by an envelope of yellow matter. Such cysts (the *Corpora Lutea* of Dr. Lee) were never observed as an effect of menstruation simply, but were met with exclusively in the gravid female; although two were seen (as were also the cephaloid bodies of the preceding order) to be present in some cases of single conception. This form of Cephaloid bodies was generally distinguished by large, persistent, white, glistening cavities. The granular cephaloid matter was sometimes found quite absorbed within a few days after parturition; but in other instances it underwent the metamorphosis characteristic of the next class.

IV. The fourth general state of the ruptured Graafian follicle was peculiar to the impregnated and lactating female, in the period between the 8th and 13th months after conception; and appeared to be a conversion of the *Corpora Cephaloidea* already described, arising out of a higher and more perfect organization. Down to the 7th month of pregnancy, the cysts contained in the Ovaries did not differ in any respect from the cerebriform bodies found in the unimpregnated state; except that they were sometimes plumper, more vascular, better developed, and had their inner layer more frequently thickened. A change in the hue of the granular matter then commences, which becomes more decided as time elapses; so that by the end of the 1st month after delivery, it becomes of a decided rose colour, changing to a still more florid hue on exposure to air. Its cavity also contracts, so as to leave but a stellated point, or a curved groove; and a fibrous appearance (probably dependent on the traction thus exercised) is seen in the surrounding substance. Although these bodies, termed by Dr. Ritchie *Corpora Rubra*, are found exclusively in the later months of pregnancy, or in the puerperal state, yet they are not always present in those conditions.

The number of cases examined by Dr. Ritchie is not, perhaps, sufficient to enable us to found any positive statements upon the results of his examination of them; but the following inductions appear highly probable:—I. That the presence of *Corpora Rubra* may be regarded as indicative, not only of conception, but also of an advanced state of pregnancy, or of recent delivery; but that their absence is not to be regarded as any proof to the contrary.—2.

That the presence of *Corpora Cephaloidea* of the second order is to be regarded as indicative of conception.—3. That the presence of the *Corpora Cephaloidea* of the first order, or of *Corpora Albida*, cannot be regarded as in the least degree indicative of Conception; as they may result from the simple discharge of an Ovum, in the ordinary course of those changes to which the Ovarium is subject.—The excess of *Corpora Albida* above every other appearance is due, not merely to their being an ordinary result of the discharge of unimpregnated Ova; but also to the frequency of their production as degenerated forms (so to speak) of the *Corpora Cephaloidea* and *Corpora Rubra* of the gravid female; and also to their occasional existence as, from the first, the only Ovarian change following upon Conception.

915. The object of the changes which have been already described, is to bring the Ovum within reach of the fecundating influence; and to convey it into the Uterus after it has been fertilized. We have now to consider the changes in the Ovum itself, which take place during the same epoch. At about the same period that the Ovum moves towards the periphery of the Graafian follicle, the Germinal Vesicle moves towards the periphery of the yolk-bag; and it always takes up its position at the precise point of the Zona Pellucida which is nearest the Ovisac, and which is closest, therefore, to the surface of the Ovary. Moreover, the Germinal Spot is always on that part of the Germinal Vesicle, which is in closest contact with the Zona Pellucida. (See *a*, Figs. 9 and 10, Plate I.) Thus, the Germinal Spot is very near the exterior of the Ovary; but is separated from it by the peritoneal coat of the latter, by a thin layer of its stroma forming the external layer of the Graafian follicle, by the ovisac forming its internal membrane, and by the zona pellucida. We have already seen how the obstacle interposed by the three former to the entrance of the Spermatozoon, is overcome; we shall presently find that the Zona Pellucida undergoes a similar change.

916. Whilst the Ovum is being prepared for fecundation, a series of very important actions takes place in the Germinal Vesicle. The exterior or peripheral portion of the Spot, which previously consisted of a collection of very minute granules, begins to develop itself into a ring of new cells of extreme delicacy (Fig. 9, *a*); these gradually enlarge, and a second ring of cells is developed within it, pushing the first-formed cells further away from the centre. Many successive rings of cells are thus formed; and at last the whole Germinal Vesicle is filled with them, as shown at *b*, Fig. 10. Still there remains a pellucid space in the centre of the Germinal Spot (resembling that seen at *a*, Fig. 12); in which no cells are developed. The first-formed cells that have been pushed outwards, are so much compressed by those subsequently formed, as frequently to undergo liquefaction; and during the time that the Ova are being matured for fertilization, there is a continual new production of cells at the centre, and a degeneration at the circumference.—At the same time, the Yolk undergoes changes somewhat analogous; for it ceases to contain separate oil-globules; and large elliptical discs or cells are seen in it, especially just beneath the Zona Pellucida (Fig. 9, *c*).^{*} Here, too, the formation of new cells takes place from the periphery towards the centre; the peripheral ones gradually undergo liquefaction, as is seen in the outer layer of those in Fig. 10, which are becoming indistinct; and they are replaced by a new layer pushed outwards from the centre. The same process subsequently continues in the Yolk, for some time after fecundation; and this not only in regard to the yolk as a whole, but in respect to its individual cells,

* It is to be remembered that the observations of Dr. Barry, here quoted, were made on the Rabbit: and are, therefore, probably applicable equally to other Mammalia, but not to Oviparous Animals.

as is shown in Fig. 11, where concentric rings of new cells are seen in each of the parent vesicles. Even in the most advanced of these secondary cells, another generation may be seen, and these are developed upon the same plan with those of the Germinal Vesicle: thus in Fig. 12, the pellucid centre of the original nucleus of the parent disc is seen at *a*, and is surrounded by several concentric rings of cells, increasing in size from within outwards; and at *b* is represented the condition of the outer and older cells, in which the same process is undergoing repetition. (Although the figure only represents one secondary cell as in the act of producing others, the others of the same age are alike engaged in the process of multiplication.)—The foregoing history is equally applicable to the cells, from which the Embryo subsequently originates; and it is probably the general mode in which the process takes place.

917. At the time when the interior of the Germinal Vesicle is being prepared for the reception of the fecundating influence, the portion of the Zona Pellucida against which it lies becomes attenuated; and a chink then forms in it, just above what was the pellucid centre of the Germinal Spot. Through this chink, the Spermatozoon can reach the Germinal Vesicle; and that it does so, we are now entitled to affirm, not only from analogy, but also from actual observation (§ 900). What is the nature of the influence communicated by it is less certain; but from the known character of the process of fecundation in Plants, we shall have little difficulty in concluding, that it deposits in the Germinal Vesicle the rudiments of the first cells, which are subsequently to be developed into the Embryonic structure. It is certain that none of the cells previously contained in the Germinal Vesicle subsequently form part of it; in fact, they all liquefy after a time, and disappear entirely. But in the previously pellucid centre of what was the Germinal Spot, two new cells are seen after fecundation; these enlarge at the expense of the rest; and from them, all the permanent structures originate. This pair of cells is seen at *a*, Figs. 13 and 14; in the former some of the cells of the Germinal Vesicle are still left; in the latter, they have been all absorbed. The Germinal Vesicle returns after fecundation to the centre of the Yolk, being at first entirely concealed by its discs (Fig. 11); and the cleft in the Zona Pellucida soon closes, so as to be no longer distinguishable. The two new cells and the other contents of the Germinal Vesicle, undergo such a rapid increase in size, that they soon fill the whole interior of the Zona Pellucida; and the cells of the Yolk being reduced by the pressure into a liquid form, their elements are absorbed by the new cells of the Embryonic structure. This, at least, is the case in the Mammalia; among which the Yolk performs but a very subordinate part, having only to serve for the development of the Embryo during a very brief period.—In each of the two primary Germ-cells (as they may be called) a series of changes takes place, exactly conformable to that already described as occurring in the Germinal Vesicle;—that is to say,—a ring of new cells originates in the margin of its nucleus,—this increases in size, and is pushed outwards by another ring nearer the centre, this again by another, and so on,—and at last, two cells appear in the pellucid central space, which are developed at the expense of all the rest, and are to be regarded as the real permanent offspring of the parent. These changes may be seen in progress in Figs. 13 and 14; in the former, the original cells of the Germinal Vesicle have not quite disappeared, although their liquefaction is in progress; in the latter, no vestige of them is left, the whole cavity being occupied by the twin-cells.

918. These changes commence during the passage of the Ovum along the Fallopian tube; and during its transit to the Uterus, it acquires a sort of gelatinous envelope, which is inclosed in a membrane of fibrous texture, termed the *Chorion*. The gelatinous envelope is probably of an *albuminous* nature in reality, corresponding with the *white* of the Bird's egg; whilst the fibrous

texture of Chorion seems to be produced, like the membranous basis of the egg-shell of the Bird (§ 118), by the exudation of Fibrine from the lining membrane of the Fallopian tube or Oviduct. The outer layer of this envelope, in the egg of the Bird, is consolidated by the deposition of particles of Carbonate of Lime in its areolæ; but it undergoes no higher organization. The Chorion of the Mammal, on the other hand, subsequently undergoes changes of a much higher order; which adapt it for participating, to a most important degree, in the nutrition of the included embryo.—The first of these changes consists in the extension of the surface of the membrane into a number of villous prolongations, which give it a spongy or shaggy appearance. These serve as absorbing radicles, and form the channel through which the embryo is nourished by the fluids of the parent, until a more perfect communication is formed, in the manner to be presently explained.

919. We have now to speak of the changes in the Uterus, which take place in consequence of Conception, and which prepare it to receive the Ovum. Of these the most important is the formation of the *Membrana Decidua*, so called from its being cast off at each parturition. This membrane has been usually supposed to be a new formation; and has been described as originating in coagulable lymph thrown out on the inner surface of the Uterus, into which vessels are prolonged from the subjacent surface. It appears, however, from the late researches of Dr. Sharpey and Prof. Weber,* that this is not the true account of it; and that the Decidua is really composed of the inner portion of the Mucous membrane itself, which undergoes a considerable change in its character. The Mucous membrane of the Uterus had been observed by Dr. J. Reid to possess, on its free surface, a tubular structure; not very unlike that which has been described as existing in the lining membrane of the stomach (§ 873 and Fig. 269). This tubular portion becomes thickened and increased in vascularity, within a short time after conception; and when the inner surface of a newly-impregnated Uterus is examined with a low magnifying power, the orifices of its tubes (Plate I., Fig. 17, *b, b*) are very distinctly seen, being lined with a white epithelium. The blood-vessels (*c, c*) form a very minute net-work, which extends in loops from the subjacent portion of the membrane. According to the recent observations of Mr. J. Goodsir,† the interfollicular spaces (*a, a, a*) also are crowded with nucleated particles; and it is to the development of this interfollicular substance, as well as to the enlargement of the follicles themselves, and the copious development of epithelial cells in their interior, that the mucous membrane in this condition owes its increased thickness. At a later period, the Decidua may be found to consist of two distinct layers; the *Decidua vera*, lining the uterus; and the *Decidua reflexa*, covering the exterior of the ovum. It was formerly supposed that the latter is a portion of the former, which has been pushed before the ovum at its entrance into the uterus; but the two layers are so different in texture, that they cannot be supposed to have the same origin. The difficulty appears to be solved by the observations of Mr. Goodsir. “From what has now been stated,” he remarks, “it appears that the Decidua consists of two distinct elements; the mucous membrane of the uterus, thickened by a peculiar development; and a non-vascular cellular substance, the product of the uterine follicles. The former constitutes, at a later period, the greater part of the *decidua vera*; the latter, the *decidua reflexa*. This view of the constitution of the Decidua clears up the doubts which were entertained regarding the arrangement of these membranes at the os uteri and entrances of the Fallopian tubes. It is evident that these orifices will be open or closed, just as the

* Müller's Physiology, pp. 1574-1580.

† Anatomical and Pathological Observations, Chap. ix.

cellular secretion is more or less plentiful, or in a state of more or less vigorous development.”—“When the ovum enters the cavity of the uterus, the cellular decidua surrounds it, and becomes what has been named the decidua reflexa, by a continuation of the same action, by which it had been increasing in quantity before the arrival of the ovum. The cellular decidua grows around the ovum by the formation of new cells, the product of those in whose vicinity the ovum happens to be situated.”

920. When the Ovum has arrived in the Uterus, therefore, and the villous tufts of the Chorion are developed, these come into contact, in the first instance, with the layer of *cellular* decidua, which intervenes between them and the vascular decidua. Through this cellular membrane, therefore, the ovum must derive its nutriment from the vascular surface; and it cannot be deemed improbable, that the office of its component cells is to draw from the subjacent vessels the materials which are to serve for the nutrition of the ovum, and to present it to the villous tufts of the chorion. Each of these is composed (according to the observations of Mr. J. Goodsir) of an assemblage of nucleated cells, which are found in various stages of development; and these are always inclosed within a layer of basement-membrane, which seems to be itself composed of flattened cells united by their edges. At the free extremity of each villus, is a bulbous expansion, the cells composing which are arranged round a central spot; and it is at this point that the most active processes of growth take place, the villus elongating by the development of new cells from its germinal spot, and (like the spongiole of the plant) drawing in nutriment from the soil in which it is imbedded.—In its earliest grade of development, the chorion and its villi contain no vessels; and the fluid drawn in by the tufts is communicated to the embryo, by the absorbing powers of the germinal membrane of the latter. But when the tufts are penetrated by blood-vessels, and their communication with the embryo becomes more direct, the means by which they communicate with the parent are found to be still essentially the same;—namely, a double layer of nucleated cells, one layer belonging to the fœtal tuft, and the other to the vascular maternal surface. It is from these elements that the *Placenta* is formed, in the manner next to be described.

921. The first stage in this process consists in the extension of the fœtal vessels into the villi of the Chorion over its entire surface, in the manner hereafter to be detailed (§ 941); so that the nutriment which these villi imbibe, instead of being merely added to the albuminous fluid surrounding the yolk-bag, is now conveyed directly to the embryo. This,—the earliest and simplest mode by which the Fœtus effects a new connection with the parent,—is the only one in which it ever takes place in the lower Mammalia, which are hence properly designated as “non-placental,” rather than as ovo-viviparous (§ 44). In the higher Mammalia, however, there soon occurs a great extension of the vascular tufts of the fœtal Chorion, at certain points; and a corresponding adaptation, on the part of the Uterine structure, to afford them an increased supply of nutritious fluid. These specially-prolonged portions are scattered, in the Ruminantia and some other Mammalia, over the whole surface of the Chorion, forming what are termed the Cotyledons; but in the higher orders, and in Man, they are concentrated in one spot, forming the Placenta. In some of the lower tribes, the maternal and the fœtal portions of the Placenta may be very easily separated; the former consisting of the thickened Decidua; and the latter being composed of the prolonged and ramifying vascular tufts of the Chorion, dipping down into it. But in the Human Placenta, the two elements are mingled together through its whole substance.

922. On looking at the Fœtal surface of the Human Placenta, we perceive that the umbilical vessels diverge in every direction from the point at which

they enter it; and their subdivisions ramify very minutely, forming a large part of its substance. The terminal ramifications are represented by Dr. J. Reid* as having the digitated aspect represented in Fig. 23, (Plate I.); but this is one of the more complex forms. In its simplest character, each villus is cylindrical or nearly so; and the digitated villi are only solitary villi grouped together at the extremity of a primary branch. Each villus contains a capillary vessel, which forms a series of loops, communicating with an artery on one side and with a vein on the other; but the same capillary may pass into several villi, before re-entering a larger vessel. The vessels of the villi are covered, as in the Chorion, by a layer of cells (Fig. 280 *f*), inclosed

Fig. 280.

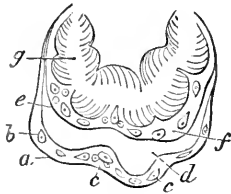

Extremity of a placental villus:—*a*, external membrane of the villus, continuous with the lining membrane of the vascular system of the mother; *b*, external cells of the villus, belonging to the placental decidua; *c*, *e*, germinal centres of the external cells; *d*, the space between the maternal and fetal portions of the villus; *e*, the internal membrane of the villus, continuous with the external membrane of the chorion; *f*, the internal cells of the villus, belonging to the chorion; *g*, the loop of umbilical vessels.

Fig. 281.

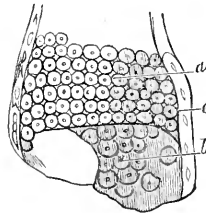

Portion of the external membrane, with the external cells, of a placental villus:—*a*, cells seen through the membrane; *b*, cells seen from within the villus; *c*, cells seen in profile along the edge of the villus.

in basement-membrane (*e*); but the fetal tuft thus formed is inclosed in a second series of envelopes (*a*, *b*, *c*), derived from the maternal portion of the Placenta,—a space (*d*) being left, however, between the two, at the extremity of the tuft.

923. Whilst the fetal portion of the Placenta is thus being generated by the extension of the vascular tufts of the Chorion, the Maternal portion is formed by the enlargement of the vessels of the decidua, between which they dip down. “These vessels assume the character of sinuses; and at last swell out (so to speak) around and between the villi; so that finally the villi are completely bound up or covered by the membrane which constitutes the walls of the vessels, this membrane following the contour of all the villi, and even passing to a certain extent over the branches and stems of the tufts. Between this membrane, or wall of the enlarged decidual vessels, and the internal membrane of the villi, there still remains a layer of the cells of the decidua.”† In this manner is formed the Maternal portion of the Placenta, which may be regarded in its adult state (as was well pointed out by Dr. J. Reid) in the light of a large sac formed by a prolongation of the inner coat of the Uterine vessels; against the fetal surface of which sac, the tufts just described may be said to push themselves, so as to dip down into it, carrying before them a portion of its thin wall, which constitutes a sheath to each tuft. Now as every extension

* Edinb. Med. and Surg. Journal, Jan. 1841.

† Goodsir's Anatomical and Pathological Observations, p. 60.

of the uterine vessels carries the decidua before it, every one of the vascular tufts that dips down into it will be covered with a layer of the cellular structure of the latter; and the fetal portion of each tuft will thus be inclosed in a layer of *maternal* cells and basement-membrane (Fig. 280, *a, b, c*; and Fig. 281, *a, b, e*). In this manner, the whole interior of the placental cavity is intersected by numerous tufts of fetal vessels, disposed in fringes, and bound down by reflections of the delicate membrane that forms its proper wall; just as the intestines are held in their places by reflections of the peritoneum that covers them. This view was suggested to Dr. R. by the very interesting fact, that the tufts of fetal vessels not unfrequently extend beyond the uterine surface of the Placenta, and dip down into the uterine sinuses; where they are still covered, and held in their places, by reflections of the same membrane (Plate I., Fig. 24). All the bands which connect and tie down the tufts (Fig. 282, *g*), are formed of the same elements as the envelopes of the tufts themselves; namely, a fold of the lining membrane of the decidual sinuses, and a layer of the cellular decidua.

Fig. 282.

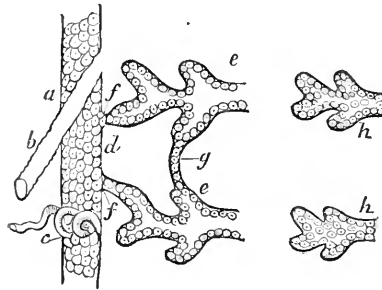

Diagram illustrating the arrangement of the placental decidua:—*a*, decidua in contact with the interior of the uterus; *b*, venous sinus passing obliquely through it by a valvular opening; *c*, a curling artery passing in the same direction; *d*, the lining membrane of the maternal vascular system, passing in from the artery and vein, lining the bag of the placenta, and covering *e, e*, the fetal tufts, passing on to them from their stems from the fetal side of the cavity, also by the terminal decidual bars *f, f*, from the uterine side, and from one tuft to the other by the lateral bar, *g*; *h, h*, separated fetal tufts, showing the internal membrane and cells, which, with the loops of umbilical vessels, constitute the true fetal portion of the tufts.

924. The blood is conveyed into the Placental cavity by the “curling arteries” of the Uterus; and is returned from it by the large veins, that are commonly designated as sinuses. The fetal vessels, being bathed in this blood, as the branchiæ of aquatic animals are in the water that surrounds them, not only enable the fetal blood to exchange its venous character for the arterial, by parting with its carbonic acid to the maternal blood, and receiving oxygen from it; but they also serve as rootlets, by which certain nutritious elements of the maternal blood (probably those composing the liquor sanguinis) are taken into the system of the Fœtus. In this they closely correspond with the villi of the Intestinal canal; and there is this further very striking analogy,—that the nutrient material is selected and prepared by two sets of cells, one of which (the maternal) transmits it to the other (the fetal), in the same manner as the epithelial cells of the intestinal villi seem to take up and prepare the nutrient matter, which is destined to be still further assimilated by the special absorbing cells of their interior (§ 672). There is no more direct communication between the Mother and Fœtus than this; all the observations which have been supposed to prove the existence of real vascular continuity,

having been falsified by the extravasation of fluid, consequent upon the force used in injecting the vessels. Moreover, the different size of the blood-corpuscles in the Fœtus and in the Parent (§ 149) shows the non-existence of any such communication.

925. The formation of the Placenta, in the manner just described, commences in the latter part of the second month; during the third, it acquires its proper character; and it subsequently goes on increasing, in accordance with the growth of the ovum. Towards the end of the term of gestation, however, it becomes more dense and less vascular; owing, it would seem, to the obliteration of several of the minuter vessels, which are converted into hard fibrous filaments. The vessels of the Uterus undergo great enlargement throughout, but especially at the part to which the Placenta is attached; and the blood in moving through them produces a peculiar murmur, which is usually distinctly audible at an early period of Pregnancy, and may be regarded (when due care is taken to avoid sources of fallacy), as one of its most unequivocal positive signs. The Placental bruit is thus described by Dr. Montgomery.* “The characters of this phenomenon are, a low murmuring or somewhat cooing sound, resembling that made by blowing gently over the lip of a wide-mouthed phial, and accompanied by a slight rushing noise, but without any sensation of impulse. The sound is, in its return, exactly synchronous with the pulse of the mother at the time of examination; and varies in the frequency of its repetitions, with any accidental variation which may occur in the maternal circulation. Its situation does not vary during the course of the same pregnancy; but in whatever region of the uterus it is first heard, it will in future be found, if recognized at all,—for it is liable to intermissions,—at least we shall occasionally be unable to hear it where we have already heard it a short time before, and where we shall shortly again recognize it. According to my experience, it will be most frequently heard about the situation of the Fallopian tube of the right side; but it may be detected in any of the lateral or anterior parts of the uterus.” That the cause of this sound exists in the Uterus itself, is distinctly proved by the fact, that it has been heard when that organ was so completely *anteverted*, that the fundus hung down between the patient’s thighs. A sound so much resembling this, as to be scarcely distinguishable from it, may be occasioned, however, by a cause of a very different nature,—namely, an abdominal tumour, pressing upon the aorta, iliac arteries, or enlarged vessels of its own; and, in doubtful cases, it is necessary to give full weight to the possibility of such an explanation. The sound may be imitated at any time, by pressing the stethoscope on the iliac arteries. The Placental bruit has been not unfrequently heard in the 11th week; but it cannot generally be detected before the fourth month, when the fundus uteri rises above the anterior wall of the pelvis.

926. The amount of the peculiar tissue of the Uterus (§ 234) greatly increases during pregnancy. At the same time, the Mammary gland and its appendages undergo a fuller development; and from this a valuable, but not unequivocal, indication of pregnancy may be drawn. Occasional shooting pains in the Mammæ are not unfrequently experienced within a short period after conception; and more continued tenderness is also not unusual. A sense of distension is very commonly experienced at about the end of the second month; and from that time a distinct “knottiness” usually begins to present itself, increasing with the advance of Pregnancy. In many instances, however, these mammary sympathies are entirely absent; and they may be simulated by changes that take place in consequence of various affections of the Uterus. A change of colour in the areola is a very common, but not an

* Op. cit., p. 121.

invariable, occurrence in the early months of pregnancy; but another sign is afforded by the areola and nipple, which is of more value because more constant,—namely, a puffy turgescence, and an increased development of the little glandular follicles, or tubercles, which commonly secrete a dewy moisture.—The presence or absence of *kiesteine* in the Urine (§ 859) also may probably be regarded as a valuable diagnostic sign. This substance appears on the surface of the fluid, after it has stood for two or three days, in the form of a thin pellicle of a somewhat fatty aspect; it is preceded by a sediment which has very much the appearance of cotton wool; and it disappears when the urine is decomposing, at the same time emitting an odour like that of putrid cheese.*—Many other changes in the constitution take place during Pregnancy; indicated by the buffiness of the blood, the irritability of the stomach, and the increased excitability of the mind. All these, however, are discussed with sufficient amplification, in works on Obstetric Medicine.

927. The act of Conception, being one of a purely organic nature, is not attended with any consciousness on the part of the mother; but there are some women, in whom it is attended with certain sympathetic affections, such as faintness, vertigo, &c., that enable them to fix upon the particular time at which it has taken place. From that period, however, the Mother has no direct consciousness of the change going on in the Uterus (save by the effects of its increasing pressure on other parts), until the occurrence of what is termed "Quickening." This is generally described as a kind of fluttering movement, attended with some degree of syncope or vertigo. After it has once occurred, and has strongly excited attention, it is occasionally renewed once or twice, and then gives place to the ordinary movements of the fœtus. Not unfrequently, however, no movement whatever is felt, until near the end of the term of gestation, or even through the whole of it. As to the cause of the sensation, Obstetricians are much divided; and no satisfactory account has been given of it. It has been vulgarly supposed to be due to the first movement of the Fœtus, which was imagined then to become possessed of an independent life: and the English law recognizes the truth of this doctrine, in varying the punishment of an attempt to procure Abortion, according to whether the woman be "quick with child" or not; and in delaying execution when a woman can be proved to be so, though it is made to proceed if she is not, even if she be unquestionably pregnant. Whether or not the first *sensible* motions of the Fœtus are the cause of the peculiar feeling in question, there can be no doubt that the Embryo has as much independent vitality before, as after, the quickening. From the time that the Ovum quits the Ovary, it ceases to be a part of the Parent, and is dependent on it only for a due supply of nourishment, which it converts, by its own inherent powers, into its proper fabric. This dependence cannot be said to cease at the moment of quickening; for the connection must be prolonged during several weeks, before the Fœtus can be said to be capable of living without such assistance. The earliest period at which this may occur, will be presently considered (§ 932).

928. At the conclusion of about nine (solar) months from the period of conception, the time of Parturition arrives. The Uterus, by its own efforts, and by the assistance of the muscles of Expiration, expels its contents; and the membranes of the Ovum being usually ruptured before it is entirely discharged, the Fœtus comes at once into the world. Although there can be no doubt that, as already stated (§ 393), the contractile fibres of the Uterus may be called into effectual action without Nervous influence, yet it is equally certain that Uterine contractions may be induced through the Spinal system of

* [See an excellent paper on this subject in Am. Journ. of Med. Sci., vol. iv., N. S., by Elisha Kane, M. D.—M. C.]

nerves. For in no other way can we account for many phenomena which are obviously of a reflex character; such as the sudden contraction of the Uterus, previously distended and inactive, when cold is applied to the external surface of the body, or when the child is applied to the nipple. In the first stage of labour, the Uterine contractions appear to be alone concerned; and it is not until the head of the child is passing through the Os Uteri, and is entering the Vagina, that the assistance of the Expiratory muscles is called in. The *excitor* fibres, which convey to the Spinal Cord the stimulus that calls them into action, must originate, therefore, rather in the Vagina than in the Uterus itself. Whilst the fibres of the fundus and body of the Uterus are in powerful contraction, those of the Cervix Uteri and Vagina must be in a state of dilatation; and this dilatation appears to be in some respects different from the mere yielding to the pressure of the child's head. A slow contraction of the fibres of the fundus and body of the Uterus, and a yielding of those of the cervix, usually take place during some days previous to Parturition; so that the child lies lower, and the size of the abdomen diminishes.*

929. As to the reason why the period of Parturition should be just nine months after that of Conception, we know nothing more than we do of that of similar facts in the physical history of Man—such as the periodical return of the Catamenia,—the renewal of the Teeth,—the recurrence of the tendency to Sleep, &c. That it is immediately dependent upon some state of the constitution, rather than upon the condition of the Uterus, appears from the fact that, in cases of Extra-uterine pregnancy, contractions resembling those of labour take place in its walls. Moreover, various states of the constitution, especially that which is designated as irritability, may induce the occurrence of the parturient efforts at an earlier period; and this constitutes Abortion, or Premature delivery, according to the *viability* of the child. There are some women, in whom this regularly happens at a certain month, so that it seems to be an action natural to them; but it is always to be prevented, if possible, being injurious alike to the mother and child; and this prevention is to be attempted by rest and tranquillity of mind and body, and by a careful avoidance of all the exciting causes, which may produce Uterine contractions by their operation on the Nervous system. For it is to be remembered that, although the muscular fibres of the Uterus are capable, like those of the alimentary canal, of an independent action, they are likely to be excited to operation through the Nervous system, and especially through the Sympathetic (§ 393). The same action which expels the Fœtus, also detaches the Placenta; and if the Uterus contract with sufficient force after this has been thrown off, the orifices of the vessels which communicated with it are so effectually closed, that little or no hemorrhage takes place. If, however, the Uterus does not contract, or relaxes after having contracted, a large amount of blood may be lost in a short time from the open orifices. For some little time after Parturition, a sero-sanguineous discharge, termed the Lochia, is poured out from the Uterus; and this commonly contains shreds of the Deciduous membrane, which had not been previously detached. Within a few weeks after delivery, the Uterus regains (at least in a healthy subject) its previous condition; and it is probable that the portion of its mucous Membrane, which had been thrown off as Decidua, is very early reproduced.

930. Although the duration of Pregnancy is commonly stated at nine solar months, it would be more correct to fix the period at 40 weeks, or 280 days; which exceeds nine months by from 5 to 7 days, according to the months included. This, at least, is the average result of observation, in cases

* See some interesting Papers on the Physiology of Parturition, by Dr. W. Tyler Smith, in the *Lancet*, July 6 and 13, 1844.

in which the period of Conception could be fixed from peculiar circumstances, with something like certainty. The mode of reckoning customary among women, is to date from the middle of the month after the last appearance of the Catamenia; but it is certain that Conception is much more likely to take place *soon* after they have ceased to flow, or even before their access, than at a later period (§ 909); so that, in most instances, it would be most correct to expect Labour at forty weeks and a few days after the last recurrence of the Menses. The period of Quickening may be relied on in some women, in whom it occurs with great regularity in a certain week of Pregnancy; but there is in general great latitude as to the time of its occurrence. The usual or average time is probably about the 18th week.

931. The question of the extreme limits of Gestation, is one of great importance both to the Practitioner and to the Medical Jurist; but it is one which cannot yet be regarded as satisfactorily decided. Many persons, whose experience should give much weight to their opinion, maintain that the regular period of 40 weeks is never extended for more than two or three days; whilst, on the other hand, there are numerous cases on record, which, if testimony is to be believed at all, (and in many of these, the character and circumstances of the parties placed them above suspicion,) furnish ample evidence that Gestation may be prolonged for at least three weeks beyond the regular term.* The English law fixes no precise limit; and the decisions which have been given in our courts, when questions of this kind have been raised, have been mostly formed upon the collateral circumstances. The law of France provides that the legitimacy of a child born within 300 days after the death or departure of the husband, shall not be questioned; and a child born after more than 300 days is not declared a bastard, but its legitimacy may be contested. By the Scotch law, a child is not declared a bastard, unless born after the tenth month from the death or departure of the husband.

a. The analogical evidence drawn from observations on the lower animals is extremely strong. The observations of Tessier, which were continued during a period of forty years, with every precaution against inaccuracy, have furnished a body of results, which seems quite decisive. In the Cow, the ordinary period of gestation is about the same as in the Human female; but out of 577 individuals, no less than 20 calved beyond the 298th day, and of these, some went on to the 321st, making an excess of nearly six weeks. Of 447 Mares, whose natural period of gestation is about 335 days, 42 foaled between the 359th and the 419th day, the greatest protraction being thus 84 days, or just one-fourth of the usual term. Of 912 Sheep, whose natural period is about 151 days, 96 yeaned beyond the 153d day; and of these, 7 went on until the 157th day, making an excess of 6 days. Of 161 Rabbits, whose natural period is about 30 days, no fewer than 25 littered between the 32d and 35th; the greatest protraction was here one-sixth of the whole period, and the proportion in which there was a manifest prolongation was also nearly one-sixth of the total number of individuals. In the incubation of the common Hen, Tessier found that there was not unfrequently a prolongation to the amount of three days, or one-seventh of the whole period.

b. In regard to Cows, the observations of Tessier have been recently confirmed by those of Earl Spencer, who has published† a table of the period of gestation as observed in 764 individuals; he considers the average period to be 284 or 285 days: but no fewer than 310 calved after the 285th day; and of these, 3 went on to the 306th day, and 1 to the 313th. It is curious that, among the calves born between the 290th and 300th days, there was a decided preponderance of males,—these being 74, to 32 females; whilst all of those born after the 300th day were females.

c. It appears, however, from some recent statements published on the authority of Earl Spencer, that the Male parent may exert an important influence on the period of gestation. Of 75 Cows in calf by a particular bull, the average period was 288½ days, or four days more than the usual period. Of the 764 cows previously mentioned, 185 (nearly one-fourth) went less than 281 days; whilst not one of the cows in calf to this bull did so. On the

* A good collection of such cases will be found in Dr. Montgomery's excellent work on the Signs of Pregnancy.

† Journal of the English Agricultural Society, 1839.

other hand, of the 764 cows first mentioned, 111 (rather more than one-seventh) went above 289 days; while, of the cows in calf by this bull, 29 out of 75 (nearly two-fifths) went above 289 days.*

d. Another series of observations has recently been published by Mr. C. N. Bement of Albany, U.S.,† who has recorded the period of gestation of 62 Cows. The longest period was 336 days; the shortest, 213 days. The average period for male calves was 288 days; and for females, 282 days.

These variations are probably to be regarded as due, not so much to a prolongation of the period of *Utero*-gestation, as to various circumstances which may have a retarding influence on the process of Fecundation, and on the transmission of the Ovum through the Fallopian tube. These have been well pointed out by Dr. Montgomery.‡ It may be added that, in Dr. Barry's observations on the early changes that take place in the Ovum of Rabbits, he has noticed several irregularities of this description.—On the whole, it may be considered that, in regard to the Human female, the French law is a very reasonable one. It is probable, from the circumstances alluded to in the preceding paragraph, that Gestation is protracted to the extent of a week, ten days, or a fortnight, much more frequently than is commonly supposed. In several of the cases in which the protraction appeared indubitable, the Infant was unusually large and vigorous.

932. In regard to the shortest period at which Gestation may terminate, consistently with the viability of the Child, there is a still greater degree of uncertainty. Most practitioners are of opinion, that it is next to impossible for a Child to live and grow to maturity, which has not nearly completed its seventh month; but it is almost unquestionable that Infants, which have been born at a much earlier period, have lived for some months. It is rare in such cases, however, that the date of Conception can be fixed with sufficient precision to enable a definite statement to be given. Of the importance of the question, a case which recently occurred in Scotland affords sufficient proof. A vast amount of contradictory evidence was adduced on this trial; but, on the general rule of accepting positive in preference to negative testimony, it seems that we ought to consider it possible, that a child may live for some months, which has been born at the conclusion of 24 weeks of gestation. In the case in question, the Presbytery decided in favour of the legitimacy of an Infant born alive within 25 weeks after marriage.§

a. A very interesting case is on record,|| in which the mother (who had borne five children) was confident that her period of gestation was less than 19 weeks; the facts stated respecting the development of the child are necessarily very imperfect, as it was important to avoid exposing his body, in order that his temperature might be kept up; but at the age of three weeks, he was only 13 inches in length, and his weight was no more than 29 oz. At that time, he might be regarded, according to the calculation of the mother, as corresponding with an infant of 22 weeks or 5½ months; but the length and weight were greater than is usual at that period, and he must have been probably born at about the 25th week. It is an interesting feature in this case, that the calorific power of the Infant was so low, that artificial heat was constantly needed to sustain it; but that, under the influence of the heat of the fire, he evidently became weaker, whilst the warmth of a person in bed rendered him lively and comparatively strong. During the first week, it was extremely difficult to get him to swallow; and it was nearly a month before he could suck. At the time of the report, he was four months old, and his health appeared very good.

b. Another case of very early viability has been more recently put on record by Mr. Dodd:¶ in this, as in the former instance, the determination of the child's age rests chiefly on the opinion of the mother; but there appears no reason for suspecting any fallacy. The

* Dr. J. C. Hall, in *Medical Gazette*, May 6, 1842.

† *American Journal of the Medical Sciences*, October, 1845.

‡ *Op. cit.*, p. 272.

§ Report of Proceedings against the Rev. Fergus Jardine, *Edin.*, 1839.

|| *Edinb. Med. and Surg. Journal*, vol. xi.

¶ *Provincial Medical and Surgical Journal*, vol. ii. p. 474.

child seems to have been born at the 26th or 27th week of gestation; and having been placed under judicious management, it has thriven well.

c. One of the most satisfactory cases on record, is that detailed by Dr. Outrepoint (Professor of Obstetrics at Wurtzburgh), and stated by Dr. Christison in his evidence on the case just alluded to. The evidence is as complete as it is possible to be in any case of the kind; being derived not only from the date assigned by the Mother to her Conception, but also from the structure and history of the Child. The Gestation could have only lasted 27 weeks, and was very probably less. The length of the child was 13½ inches, and its weight was 24 oz. Its development was altogether slow; and at the age of eleven years, the child seemed no more advanced in body or mind, than most other lads of seven years old. In this last point, there is a very striking correspondence with the results of other observations upon very premature children, made at an earlier age: and these all harmonize with the general principle already more than once alluded to,—that the shorter the period during which the early development of the embryo takes place at the expense of nourishment supplied by the parent, the lower is the degree of development it will ultimately attain (§ 45).

d. To these may be added another case of recent occurrence in America: in which a woman, who believed herself to be in the sixth month of pregnancy, was prematurely delivered in consequence of a fall. The child seemed barely alive, showing scarcely any motion, and being too feeble to cry. It had no nails on its hands or feet, nor hair on the scalp; and the cranium was imperfectly ossified. At the end of seven weeks it was weighed for the first time, and found to weigh only 26 oz. When ten months old, it was playful, lively, and healthy; and weighed 10½ lbs. The reporter of this case regrets that he did not take more particular notice of the state of the Child at birth, which he was prevented from doing by the daily expectation of its death.*

933. There is another question regarding the Function of the Female in the Reproductive act, which is of great interest in a scientific point of view, and which may become of importance in Juridical inquiries;—namely, the possibility of *Superfetation*, that is, of two distinct conceptions at an interval of greater or less duration; so that two fœtuses of different ages, the offspring perhaps of different parents, may exist in the Uterus at the same time.—The simplest case of Superfetation, the frequent occurrence of which places it beyond reasonable doubt, is that in which a female has intercourse on the same day with two Males of different complexions, and bears twins at the full time; the two infants resembling the two parents respectively. Thus, in the slave-states of America, it is not uncommon for a black woman to bear at the same time a black and a mulatto child; the former being the offspring of her black husband, and the latter of her white paramour. The converse has occasionally though less frequently, occurred; a white woman bearing at the same time a white and a mulatto child. There is no difficulty in accounting for such facts, when it is remembered that nothing has occurred to prevent the Uterus and Ovaria from being as ready for the second conception as for the first; since the orifice of the former is not yet closed up; and, at the time when one ovum is matured for fecundation, there are usually more in the same condition. But it is not easy thus to account for the birth of two children, each apparently mature, at an interval of five or six months; since it might have been supposed that the uterus was so completely occupied with the first Ovum, as not to allow of the transmission of the seminal fluid, necessary for the fecundation of the second. In cases where two children have been *produced* at the same time, one of which was fully-formed, whilst the other was small and seemingly premature, there is no occasion whatever to imagine that the two were *conceived* at different periods; since the smaller fœtus may have been “blighted,” and its development retarded, as not unfrequently happens in other cases. Nor is it necessary to infer the occurrence of Superfetation in every case, in which a living child has been produced a month or two after the birth of another; since the latter may have been premature, whilst the former has been carried to the full term. But such a difference can scarcely be, at the

* American Journal of the Medical Sciences, April 1843.

most, more than $2\frac{1}{2}$ or three months; and there are several cases now on record, in which the interval was from 110 to 170 days, whilst neither of the children was premature in appearance; so that the possibility of a second Conception, when the Uterus already contains an Ovum of several months, can scarcely be denied, however improbable it may seem.

4.—*Development of the Embryo.*

934. Under this head it is intended to state, not so much the *details* of the process of Development, as those leading facts, the knowledge of which is desirable in itself, as well as essential to the due comprehension of the former. It is difficult to see what practical benefit can result from a minute acquaintance with all the steps of the evolution of the Embryo, however interesting these may be in a scientific point of view; and the time of the ordinary Student, on which there are so many pressing calls, may be much better occupied than in committing them to memory. In the following sketch, little will be said respecting the latter stages of the process, or the development of particular organs, since these have been already noticed under their severally distinct heads. Our attention will first be given to the formation of the Embryonic mass, and of the membranes surrounding the Yolk-bag; and then to the origin of the Vertebral column, Digestive organs, and Circulating apparatus.

935. The Ovum, when it quits the Ovarium, has been stated to contain within the Germinal Vesicle, two cells which did not exist there previously to fecundation; and from each of these, two new cells are subsequently produced, which in their turn give birth to eight others (§ 917). In this manner, the number of vesicles originating in the twin-cells of the Germ is continually increased, until at last they become too numerous to be counted, and form a cluster resembling a Mulberry in appearance; this mulberry-like structure may be conveniently termed the *Germinal Mass* (Plate I., Fig. 15, *a*). In the centre of this mass there is found a peculiar Cell, differing from the rest in its greater size, and in possessing a very well-defined annular nucleus, with a pellucid cavity in its centre (Fig. 16, *a, b*). From this peculiar Cell, all the parts which enter permanently into the composition of the Embryo are developed; the vesicles forming the exterior of the germinal mass being subservient to a merely temporary purpose. This central or Embryonic Cell is gradually brought to the surface of the Germinal Mass, by the formation of a cavity *c* in the interior of the latter; for the layer of cells within which this cavity is formed, progressively extends itself, until it comes into contact with the inner surface of the Yolk-bag, having absorbed the yolk into the hollow thus left. Thus out of the periphery of the Mulberry-mass, appears to be formed the *exterior* layer of what is termed the *Germinal Membrane*: this membrane is first seen as an epithelium-like layer of cells, covering the Yolk; but beneath this layer, which is afterwards known as the *serous* lamina of the Germinal membrane, two others are subsequently produced from the central portion of the Germinal mass. Now it is highly interesting to observe, that this Germinal Membrane, which in the higher animals is a mere temporary structure, subservient only to a temporary function, forms, in the lower tribes, the greater part of the permanent fabric of the body. Thus, in the Polypes, the cavity in which the Yolk is inclosed becomes a Stomach; the *external* layer of the Germinal Membrane becomes the integument; whilst the *internal* forms the lining of the Digestive cavity, of which the mouth is formed by absorption of its wall at one point. Here the Yolk is directly absorbed and assimilated by the surrounding membrane. In the higher Oviparous animals, the Germinal Membrane serves to absorb nutritious matter from the Yolk, and to prepare it for the use of the Embryo itself, by converting it into Blood

(§ 938); but, after the Yolk has been exhausted, the Yolk-bag is taken into the body, and is gradually removed by absorption. In Mammalia, these structures are of less importance. The store of Yolk, laid up for the nutrition of the Embryo, is comparatively inconsiderable; being only destined to serve for the short time that elapses, before the Ovum forms its new connection with the Parent, through the medium of the Chorion; and the Yolk-bag is ultimately separated from the Embryo, and thrown off as useless. Still the early processes are the same in Mammiferous, as they are in Oviparous animals; and the Development of Man, of a Bird, of a Reptile, or of a Fish, takes place, up to a certain point, upon the same general plan.

936. The Embryonic Cell, and the cluster of cells that surrounds it, having arrived on the surface of the Yolk by the movement just described, constitute what is known in the Bird's egg under the name of the *Cicatricula*. This is a semi-opaque disc, composed of numerous flattened cells; and in the midst of it is seen a round transparent space, termed the *Area Pellucida*, which is nothing else than the place occupied by the large Embryonic Cell, now become flattened, and still retaining its clearness. In the centre of this is seen a very faint line, which is termed the *Primitive Trace*; and this is the large annular Nucleus (Plate I., Fig. 16, *b*) of the Embryonic Cell, now become elongated, and itself beginning to be developed into cells. The same process then takes place within the Embryonic Cell, which has been described as occurring within the Germinal Vesicle (§ 916); the granules forming the periphery of the nucleus are first developed into cells, and these are pushed outwards by a new series subsequently generated near the centre. From the mass of cells thus formed, a hollow process passes down into the Yolk; and this gradually extends itself in the same manner as did that formed from the Mulberry-mass, until it includes the whole Yolk, and comes into contact with the inner surface of the layer of cells already mentioned as forming the *serous* or external lamina of the Germinal Membrane. This second layer of cells is probably that which forms the *vascular* lamina of the Germinal Membrane. A third process seems to be afterwards sent down, from a part of the nucleus somewhat interior to that from which the last proceeded: and this becomes the *mucous* or internal lamina of the Germinal Membrane.

937. The cell-germs forming the periphery of the Nucleus having been thus developed, those nearer the centre then begin to exhibit a corresponding activity. Their evolution follows exactly the same plan as that which has been described in regard to the contents of the Germinal Vesicle (§ 916); with the exception that these are arranged in an elongated and not in a circular form. The shape of the nucleus at this time may be compared to that of a pear; the large end marking the situation of the Head; whilst the prolonged portion is the rudiment of the body. On the median line is seen a groove, occupying the situation in which the Nervous Centres are to be subsequently evolved (Fig. 25, Plate II.). These, when first developed, are surrounded by a tubular structure, which has but a temporary existence in the higher Vertebrata, but which is permanent in the lower Fishes: this structure, termed the *Chorda Dorsalis*, is found, wherever it exists, to be entirely composed of nucleated cells. From the cells which are exterior to these, is produced the Vertebral Column; and the mode in which this originates is somewhat as follows. The cells on either side of the central space (in which the elements of the nervous system are not yet developed) rise up in a ridge, so that the central space becomes a groove; these two ridges gradually rise up and approach one another, and they are then observed to contain, in what subsequently becomes the thoracic region, a few pairs of small opaque plates. The ridges (termed *plicæ dorsales*, or dorsal laminae) continue inclining towards each other, until they coalesce, so that a complete tube is formed; and in this

tube an indication is soon perceived of a division into vertebræ, of which the plates just mentioned are the incipient arches (Fig. 26, Plate II.). Towards the anterior extremity, however, the dorsal laminae do not at once close in; and the large cells, in which the great divisions of the Encephalon originate (§ 358), may be seen between them. From the Dorsal Lamina on either side, a prolongation passes outwards and then downwards, forming what is known as the *ventral lamina*; in this are developed the Ribs and the transverse processes of the Vertebræ; and the two have the same tendency to meet on the median line, and thus to close in the abdominal cavity, which the dorsal laminae have to inclose the spinal cord. At the same time the layers of the Germinal Membrane, which lie beyond the extremities of the Embryo, are folded in, so as to make a depression on the yolk; and their folded margins gradually approach one another under the abdomen. In these two modes, a cavity is formed beneath the Embryonic mass, which is separated from the general cavity of the Yolk by the folds just described; but these still leave a passage which, in the Bird, remains of considerable size until a much later period, but which, in the Mammiferous Ovum, is soon obliterated. For the sac which contains the yolk, and from which the abdominal cavity is pinched off (as it were) at a very early period, is destined, in the Mammiferous animal, to be entirely cast away; the purpose which it has to serve being one of a very temporary character.

938. Whilst these new structures are being produced, a very remarkable change is taking place in that part of the Serous lamina, which surrounds the Area Pellucida. This rises up on either side in two folds; and these gradually approach one another, at last meeting in the space between the general envelope and the embryo, and thus forming an additional investment to the latter. As each fold contains two layers of membrane, a double envelope is thus formed; of this, the outer lamina adheres to the general envelope; whilst the inner remains as a distinct sac, to which the name of *Amnion* is given. (See Figs. 284, 285, and 286.) This takes place during the third day in the Chick; the period at which it occurs in the Human Ovum is difficult to be ascertained, owing to the small number of normal specimens which have come under observation at a sufficiently early stage.—During the same

Fig. 283.

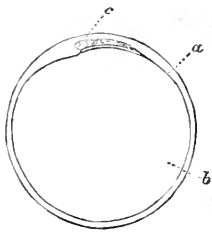

Plan of early uterine Ovum. Within the external ring, or zona pellucida, are the serous lamina, *a*; the yolk, *b*; and the incipient embryo, *c*.

Fig. 284.

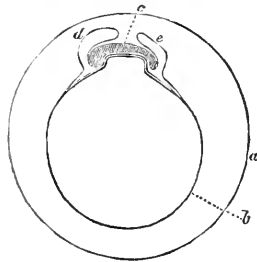

Diagram of ovum at later stage; the digestive cavity beginning to be separated from the yolk-sac, and the amnion beginning to be formed; *a*, chorion; *b*, yolk-sac; *c*, embryo; *d*, and *e*, folds of the serous layer rising up to form the Amnion.

period, a very important provision for the future support of the Embryo begins to be made; by the development of Blood-vessels and the formation of Blood. Hitherto, the Embryonic structure has been nourished by direct absorption of

the alimentary materials supplied to it by the Yolk; in the same manner as the simplest Cellular plant is developed at the expense of the carbonic acid, moisture, &c., which it obtains for itself from the surrounding elements. But its increasing size, and the necessity for a more free communication between its parts than any structure consisting of cells alone can permit, call for the development of Vessels, through which the nutritious fluid may be conveyed. These vessels are first seen in that part of the Vascular lamina of the Germinal Membrane, which immediately surrounds the embryo; and they form a network, bounded by a circular channel, which is known under the name of the *Vascular Area* (Fig. 27, Plate II.). This gradually extends itself, until the vessels spread over the whole of the membrane containing the yolk. The first blood-discs appear to be formed from the nuclei of the cells, whose cavities have become continuous with each other to form the vessels (§ 222); and from these, all subsequent blood-discs are probably generated. This network of blood-vessels serves the purposes of absorbing the nutritious matter of the Yolk, and of conveying it towards the embryonic structures, which are now in process of rapid development. The first movement of the fluid is towards the embryo; and this can be witnessed before any distinct heart is evolved. The same process of absorption from the Yolk, and of conversion into blood, probably continues as long as there is any alimentary material left in the sac.

939. The Yolk-sac is early separated in the Mammalia, by a constriction of the portion which is continuous with the abdomen of the Embryo; and it is known from that time under the name of the *Umbilical Vesicle*. The communication, however, remains open for a time through the constricted portion, which is termed the Vitelline Duct; and even after this has been cut off, the trunks which connected the circulating system of the Embryo with that of the Vascular Area, are still discernible; these are called *Omphalo-Mesenteric*, *Meseraic*, or *Vitelline* vessels. It was formerly believed, that the nutrient matter of the yolk passes directly through the Vitelline duct, into the (future) digestive cavity of the Embryo, and is from it absorbed into its structure; but there can now be little doubt, that the Vitelline vessels are the real agents of its absorption, and that they convey it to the tissues in process of formation. They do, in fact, correspond to the Mesenteric veins of Invertebrated animals, which are the sole agents in the absorption of nutriment from their digestive cavity (§ 674); and the yolk-bag, as already remarked, is the temporary stomach of the Embryo,—remaining as the permanent stomach in the Radiated tribes. Previously to the ninth day of incubation (in the Fowl's egg), a series of folds are formed by the lining membrane of the yolk-bag, which project into its cavity; these become gradually deeper and more crowded, as the bag diminishes in size by the absorption of its contents. The Vitelline vessels, that ramify upon the yolk-bag, send into these folds (or valvulae conniventes) a series of inosculating loops, which immensely increase the extent of this absorbing apparatus. But these minute vessels are not in immediate contact with the yolk; for there intervenes between them a layer of nucleated cells, which is easily washed away. It was from the colour of these, communicated to the vessels beneath, that Haller termed the latter *vasa lutea*; when the layer is removed, the vessels present their usual colour. There seems good reason to believe, that these cells, like those of the Intestinal Villi in the adult (§ 672), are the real agents in the process of absorbing and assimilating the nutritive matter of the yolk; and that they deliver this up to the vessels, by themselves undergoing rupture or dissolution, being replaced by new layers.

940. The formation of the Heart takes place in the Vascular layer, beneath the upper part of the Spinal Column; it at first appears as a mere cavity in its substance, surrounded only by cells; but its walls gradually acquire firmness

and distinctness, and become sufficiently powerful to propel the blood through the vessels of the Embryo and those of the Vascular Area. The first appearance of the Heart in the Chick is at about the 27th hour; the time of its formation in Mammalia has not been distinctly ascertained. In its earliest form, it has the same simple character, which is presented by the central impelling cavity of the lower Invertebrata; being a mere prolonged canal, which at its posterior extremity receives the veins, and at its anterior sends forth the arteries. After a short time, however, it becomes bent upon itself (Plate II., Fig. 27, *d*); and it is soon subdivided into three cavities, which exist in all Vertebrata,—a simple *auricle* or receiving cavity, a simple *ventricle* or propelling cavity, and a *bulbus arteriosus* at the origin of the aorta. The circulation is at first carried on exactly upon the plan, which is permanently exhibited by Fishes. The Aorta subdivides into four or five arches on either side of the neck; and these are separated by slits or fissures, much resembling those which form the entrances to the gill-cavities of Cartilaginous Fishes. These arches reunite to form the descending aorta, which transmits branches to all parts of the body. Such is the first phase or aspect of the Circulating Apparatus, which is common to all Vertebrata during the earliest period of their development, and which may, therefore, be considered as its most general form. It remains permanent in the class of Fishes; and in them the vascular system undergoes further development on the same type, a number of minute tufts being sent forth from each of the arches, which enter the filaments of the gills, and serve for the aeration of the blood. In higher Vertebrata, however, the plan of the circulation is afterwards entirely changed, by the formation of new cavities in the heart, and by the production of new vessels; these changes will be presently described. It is incorrect, therefore, to speak of the vascular arches in *their* necks as *branchial* arches; since no branchiæ or gills are ever developed from them. The clefts between them may be very distinctly seen in the Human Fœtus towards the end of the first month; during the second, they usually elose up and disappear.

941. With the evolution of a Circulating apparatus, adapted to absorb nourishment from the store prepared for the use of the Embryo, and to convey it to its different tissues, it becomes necessary that a respiratory apparatus

Fig. 285.

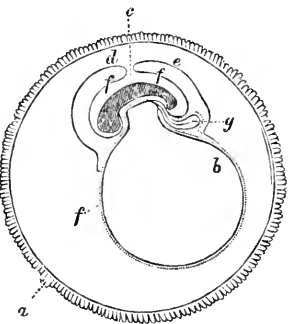

The Amnion in process of formation, by the arching over of the serous lamina; *a*, the chorion; *b*, the yolk-bag, surrounded by serous and vascular laminae; *c*, the embryo; *d*, *e*, and *f*, external and internal folds of the serous layer, forming the amnion; *g*, incipient allantois.

Fig. 286.

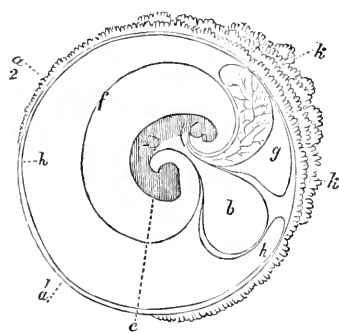

Diagram representing a Human Ovum in second month; *a. 1*, smooth portion of chorion; *a. 2*, villous portion of chorion; *k, k*, elongated villi, beginning to collect into Placenta; *b*, yolk-sac or umbilical vesicle; *c*, embryo; *f*, amnion (inner layer); *g*, allantois; *h*, outer layer of amnion, coalescing with chorion.

should also be provided, for unloading the blood of the carbonic acid with which it becomes charged during the course of its circulation. The temporary Respiratory apparatus now to be described, bears a strong resemblance in its own character, and especially in its vascular connections, with the gills of the Mollusca; which are prolongations of the external surface (usually near the termination of the intestinal canal), and which almost invariably receive their vessels from that part of the system. This apparatus is termed the *Allantois*. It consists at first of a kind of diverticulum or prolongation of the lower part of the Digestive cavity, the formation of which has been already described. This is at first seen as a single vesicle, of no great size (Fig. 285, *g*); and in the Fœtus of Mammalia, which is soon provided with other means of aerating its blood, it seldom attains any considerable dimensions. In Birds, however, it becomes so large as to extend itself around the whole Yolk-sac, intervening between it and the membrane of the shell; and through the latter it comes into relation with the external air. The preceding diagram (Fig. 286) will serve to explain its origin and position in the Human ovum. The chief office of the Allantois in Mammalia is to convey the vessels of the

[Fig. 287.]

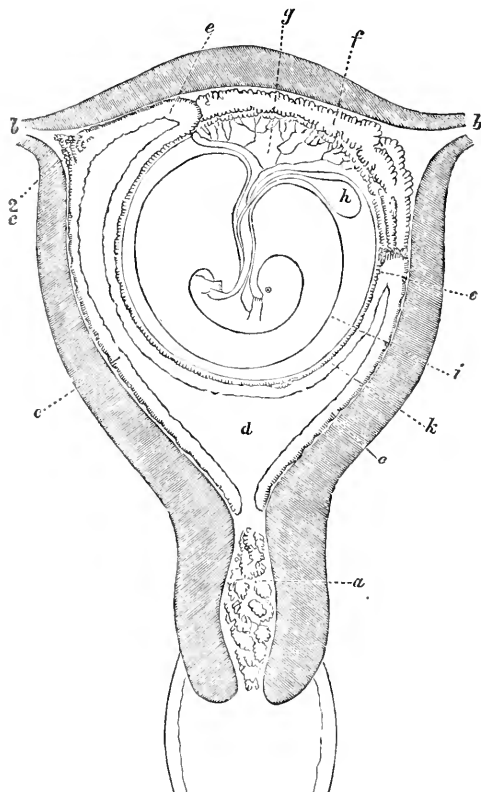

Diagram of Human Ovum, at the time of formation of Placenta; *a*, mucogelatinous substance, blocking up os uteri; *b, b*, Fallopian tubes; *c, c*, Decidua vera, prolonged at *c 2*. into Fallopian tube; *d*, cavity of uterus, almost completely occupied by ovum; *e, e*, angles at which Decidua vera is reflected; *f*, Decidua serotina; *g*, allantois; *h*, umbilical vesicle; *i*, amnion; *k*, chorion, lined with outer fold of serous tunic.

embryo to the Chorion; and its extent bears a pretty close correspondence with the extent of surface, through which the Chorion comes into vascular connection with the Decidua. Thus, in the Carnivora, whose Placenta extends like a band around the whole Ovum, the Allantois also lines the whole inner surface of the Chorion, except where the Umbilical Vesicle comes in contact with it. On the other hand, in Man and the Quadrumana, whose Placenta is restricted to one spot, the Allantois is small, and conveys the fœtal vessels to one portion only of the Chorion. When these vessels have reached the Chorion, they ramify in its substance, and send filaments into its villi; and in proportion as these villi form that connection with the uterine structure, which has been already described, do the vessels increase in size. They then pass directly from the Fœtus to the Chorion; and the Allantois, being no longer of any use, shrivels up, and remains as a minute vesicle, only to be detected by careful examination. The same thing happens in regard to the Umbilical vesicle, from which the entire contents have been by this time exhausted; and from henceforth the Fœtus is completely dependent for the materials of its growth, upon the supply it receives through the Placenta, which is conducted to it by the vessels of the Umbilical Cord. This state of things is represented in the preceding diagram.—The Allantois has a correspondence in situation with the Urinary Bladder; but it is only the lower part of it, pinched off, as it were, from the rest, that remains as such. The duct by which it is connected with the abdomen gradually shrivels; and a vestige of this is permanent, forming the Urachus or suspensory ligament of the Bladder, by which it is connected with the Umbilicus. Before this takes place, however, the Allantois is the receptacle for the secretion of the Corpora Wolffiana, and of the true Kidneys, when they are formed.

942. It will be seen from the preceding diagram, that the Umbilical Cord receives an investment from the Amnion, which forms a kind of tubular sheath around it; it is continuous at the Umbilicus with the integument of the fœtus; and at the point where the cord enters the Placenta, it is reflected over its internal or fœtal surface. The Amnion (which thus forms a shut sac, like that of the Pleura, Arachnoid, &c.) contains a fluid known as the *liquor amnii*; this consists of water holding in solution a small quantity of albumen and saline matter, and resembling, therefore, very diluted serum. During the first two months of gestation, the Amnion and the inner surface of the Chorion (which is really the reflected layer of the Amnion, just as the lining of the abdominal cavity is formed by the peritoneum) are separated by a gelatinous-looking substance; which may perhaps be considered as representing the white of the egg in Birds; and which probably aids in the nutrition of the Embryo, previously to the formation of the Placenta (§ 918). This is absorbed during the second month; and the Amnion is then found immediately beneath the Chorion.—In the Umbilical Cord, when it is completely formed, the following parts may be traced. 1. The tubular sheath afforded by the Amnion. 2. The Umbilical Vesicle, with its pedicle, or Omphalo-Enteric duct. 3. The Vasa Omphalo-Mesenterica, or mesenteric vessels of the Embryo, by which the Yolk was absorbed into the body of the Fœtus; these accompany the pedicle. 4. The Urachus, and remains of the Allantois. 5. The Vasa Umbilicalia, which, in the later period of gestation, constitute the chief part of the Cord. These last vessels consist in Man of two Arteries and one Vein. The Arteries are the main branches of the Hypogastric; and they convey to the Placenta the blood which has to be aerated and otherwise revived, by being brought into relation with that of the Mother. The Vein returns this to the Fœtus, and discharges a part of it into the Vena Portæ, and a part directly through the Ductus Venosus into the Aorta.

943. A change in the type of the Circulating system of the fœtus, from that at first presented by it (§ 940), takes place at a very early period. At about the 4th week, in the Human Embryo, a septum begins to be formed in the Ventricle; and by the end of the 8th week it is complete. The Septum Auriculorum is formed at a somewhat later period, and it remains incomplete during the whole of fœtal life; it is partly closed by the valvular fold covering the Foramen Ovale, which fold is developed during the third month. During the same period, a transformation takes place in the arrangement of the large vessels proceeding from the Heart; which ends in their assumption of the form they present until the end of Fœtal life; and this undergoes but a slight alteration, when the plan of the circulation is changed at the moment of the first inspiration. The number of Aortic arches on each side, which was five at first, soon becomes reduced in the Mammalia to three, by the obliteration of the two highest pairs. The Bulbus Arteriosus is subdivided, by the adhesion of its walls at opposite points, into two tubes, of which one becomes the Aorta and the other the Pulmonary Artery; and of the three pairs of (branchial) arches, the highest, being connected with the Aortic trunk, contributes to the formation of the Subclavian and Carotid arteries; whilst of the middle pair, the arch on the right side is obliterated, the other becoming the Arch of the Aorta. The lowest pair arises from the Pulmonary trunk, and forms the Pulmonary artery on each side; that on the left side, however, goes on to join the descending Aorta as before, and thus constitutes the Ductus Arteriosus.

944. The following is the course of the circulation of the blood in the Fœtus. The fluid brought from the Placenta by the Umbilical Vein is partly conveyed at once to the Vena Cava ascendens, by means of the Ductus Venosus, and partly flows through the Vena Portæ into the Liver, whence it reaches the ascending Cava by the Hepatic Vein. Having thus been transmitted through the two great depurating organs, the Placenta and the fetal Liver, it is in the condition of arterial blood; but, being mixed in the vessels with that which has been returned from the trunk and lower extremities, it loses this character in some degree by the time that it arrives in the Heart. In the right Auricle, which it then enters, it would be also mixed with the venous blood conveyed by the descending Cava; were it not that a very curious provision exists, to prevent (in great degree, if not entirely) any such further dilution. The Eustachian valve has been found, by the experiments of Dr. J. Reid,* to serve the purpose of directing the *arterial* blood, which flows upwards from the *ascending* Cava, through the Foramen Ovale, into the *left* Auricle, whence it passes into the Ventricle; whilst it also directs the Venous blood, that has been returned by the *descending* Cava into the *right* Ventricle. When the Ventricles contract, the Arterial blood which the left contains is propelled into the ascending Aorta, and supplies the branches that proceed to the head and upper extremities, before it undergoes any admixture; whilst the Venous blood, contained in the right Ventricle, is forced through the Pulmonary artery and Ductus Arteriosus into the descending Aorta, mingling with the arterial current which that vessel previously conveyed, and passing thus to the trunk and lower extremities. Hence the Head and superior extremities, whose development is required to be in advance of that of the lower, are supplied with blood nearly as pure as that which returns from the Placenta: whilst the rest of the body receives a mixture of this, with what has previously circulated through the system; and of this mixture a portion is transmitted to the Placenta, to be renovated by coming into relation with the maternal fluid. At birth, the course of the current is entirely

* Edinb. Med. and Surg. Journal, vol. xliii.

[Fig. 288.]

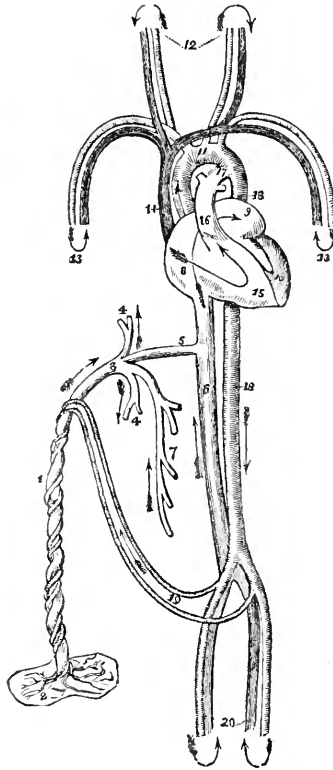

The Fœtal Circulation; 1, the umbilical cord, consisting of the umbilical vein and two umbilical arteries; proceeding from the placenta (2); 3, the umbilical vein dividing into three branches; two (4, 4) to be distributed to the liver; and one (5) the ductus venosus, which enters the inferior vena cava (6); 7, the portal vein, returning the blood from the intestines, and uniting with the right hepatic branch; 8, the right auricle; the course of the blood is denoted by the arrow, proceeding from 8 to 9, the left auricle; 10, the left ventricle; the blood following the arrow to the arch of the aorta (11), to be distributed through the branches given off by the arch to the head and upper extremities. The arrows, 12 and 13, represent the return of the blood from the head and upper extremities through the jugular and subclavian veins, to the superior vena cava (14), to the right auricle (8), and in the course of the arrow through the right ventricle (15), to the pulmonary artery (16); 17, the ductus arteriosus, which appears to be a proper continuation of the pulmonary artery—the offsets at each side are the right and left pulmonary artery cut off; these are of extremely small size as compared with the ductus arteriosus. The ductus arteriosus joins the descending aorta (18, 15), which divides into the common iliacs, and these into the internal iliacs, which become the umbilical arteries (19), and return the blood along the umbilical cord to the placenta; while the other divisions, the external iliacs (20), are continued into the lower extremities. The arrows at the termination of these vessels mark the return of the venous blood by the veins to the inferior cava.]

changed by its diversion into the Lungs; which takes place immediately on the first inspiration. The Ductus Venosus and Ductus Arteriosus soon shrivel into ligaments; the Foramen Ovale becomes closed by its valve; and the circulation, which was before carried on upon the plan of that of the higher Reptiles, now becomes that of the complete Bird or Mammal. It is by no means infrequent, however, for some arrest of development to prevent the

completion of these changes; and various malformations, involving an imperfect discharge of the function, may hence result.*

945. The Alimentary Canal has been shown to have its origin in the Yolk-sac or Umbilical Vesicle; being a portion pinched off (as it were) from that part of it, which is just beneath the Spinal Column of the Embryo (§ 937). At first it is merely a long narrow tube, nearly straight, and communicating with the Umbilical Vesicle at about the middle of its length; thus it may be regarded as composed of the union of two, an upper and a lower division. At first, neither Mouth nor Anus exists; but these are formed early in the second month, if not before. The tube gradually manifests a distinction into its special parts, Oesophagus, Stomach, Small Intestine, and Large Intestine; and the first change in its position occurs in the Stomach, which, from being disposed in the line of the body, takes an oblique direction. The curves of the large and small intestines present themselves at a later period. It is at the lower part of the small Intestine, near its termination in the large, that the entrance of the Omphalo-Enteric duct exists; and a remnant of this canal is not unfrequently preserved throughout life, in the form of a small pouch or diverticulum from that part of the intestine. The various Glandular structures connected with the alimentary canal, originate in diverticula from its walls, in the manner already described in regard to the Liver (§ 826, *g*). The Lungs and Respiratory apparatus are formed in like manner, as diverticula from the Oesophagus (§ 757, *b, c*).

946. The mode in which the chief organs of the Human embryo originate having been thus described, and sufficient particulars in regard to their subsequent development having been already given under distinct heads, it is unnecessary here to add more on this very interesting but complex subject; because for practical purposes there is little or no advantage to be gained from the most perfect acquaintance with it. The most important of all the facts that have come under our review, is that which has been stated as in the highest degree probable, if not yet absolutely proved, in regard to the relative offices of the Male and Female in this hitherto mysterious process. According to the view here given, the Male furnishes the *germ*; and the Female supplies it with Nutriment, during the whole period of its early development. There is no difficulty in reconciling such a doctrine with the well-known fact, that the offspring commonly bears a resemblance to both parents (of which the production of a hybrid between distinct species is the most striking example); since numerous phenomena prove that, in this earliest and simplest condition of the organism, the form it will ultimately assume very much depends upon circumstances external to it; among which circumstances, the kind of nutriment supplied will be one of the most important.† Upon the same principle we may account for the influence of the mental condition of the Mother upon her Offspring, during a later period of pregnancy. That such influence may occur, there can be no reasonable doubt. "We have demonstrative evidence," says Dr. A. Combe,‡ "that a fit of passion in a nurse vitiates the quality of the milk to such a degree, as to cause colic and indigestion [or even death] in the suckling infant. If, in the child already born, and in so far independent of its parent, the relation between the two is thus strong, is it unreasonable to suppose that it should be yet stronger, when the infant lies in its mother's womb, is nourished indirectly by its mother's blood, and is, to all intents and purposes, a part of her own body? If a sudden and powerful emotion of her own mind exerts such an influence upon her stomach as to excite immediate

* See Principles of General and Comparative Physiology, Chap. vi.

† See Principles of General and Comparative Physiology, § 665.

‡ On the Management of Infancy, p. 76.

vomiting, and upon her heart as almost to arrest its motion and induce fainting, can we believe that it will have no effect on her womb and the fragile being contained within it? Facts and reason, then, alike demonstrate the reality of the influence: and much practical advantage would result to both parent and child, were the conditions and extent of its operations better understood." Among facts of this class, there is, perhaps, none more striking than that quoted by the same Author from Baron Percy, as having occurred after the siege of Landan in 1793. In addition to a violent cannonading, which kept the women for some time in a constant state of alarm, the arsenal blew up with a terrific explosion, which few could hear with unshaken nerves. Out of 92 children born in that district within a few months afterwards, Baron Percy states that 16 died at the instant of birth; 33 languished for from 8 to 10 months, and then died; 8 became idiotic, and died before the age of 5 years; and 2 came into the world with numerous fractures of the bones of the limbs, caused by the cannonading and explosion. Here, then, is a total of 59 children out of 92, or within a trifle of 2 out of every 3, actually killed through the medium of the Mother's alarm and the natural consequences upon her own organization,—an experiment (for such it is to the Physiologist) upon too large a scale for its results to be set down as mere "coincidences." No soundly-judging Physiologist of the present day is likely to fall into the popular error of supposing that marks upon the Infant are to be referred to some *transient* though strong impression upon the imagination of the Mother; but there appear to be a sufficient number of facts on record, to prove that *habitual* mental conditions on the part of the Mother *may* have influence enough, at an early period of gestation, to produce evident bodily deformity, or peculiar tendencies of the mind. But whatever be the nature and degree of the influence thus transmitted, it must be such as can act by modifying the character of the nutritive materials supplied by the Mother to the Fœtus; since there is no other channel by which any influence can be propagated. The absurdity of the vulgar notion just alluded to, is sufficiently evident from this fact alone; as it is impossible to suppose that a sudden fright, speedily forgotten, can exert such a continued influence on the nutrition of the Embryo, as to occasion any personal peculiarity.* The view here stated is one which ought to have great weight, in making manifest the importance of careful management of the health of the Mother, both corporeal and mental, during the period of pregnancy: since the constitution of the offspring so much depends upon the impressions then made upon its most impressible structure.

947. It is frequently of great importance, both to the Practitioner and to the Medical Jurist, to be able to determine the age of a Fœtus, from the physical characters which it presents; and the following table has been framed by Devergie† in order to facilitate such determination. It is to be remarked, however, that the absolute Length and Weight of the Embryo are much less safe criteria, than its degree of Development,—as indicated by the relative evolution of the several parts, which make their appearance successively. Thus it is very possible for one child, born at the full time, to weigh less than another, born at 8 or even at 7 months; its length, too, may be no greater; but the position of the middle point of the body will usually afford sufficient ground

* For some valuable observations on this subject, see Montgomery on the Signs of Pregnancy. Numerous cases have been recorded, during the last few years (especially in the *Lancet* and *Provincial Medical Journal*) in which malformations in the Infant appeared distinctly traceable to strong impressions made on the mind of the Mother, some months previously to parturition; these impressions having been persistent during the remaining period of pregnancy, and giving rise to a full expectation on the part of the Mother, that the child would be affected in the particular manner which actually occurred.

† *Médecine Légale*, vol. i. p. 495.

for the determination; since, during the two latter months of pregnancy, the increasing development of the lower extremities throws it lower down.

Embryo 3 to 4 weeks.—It has the form of a serpent;—its length from three to five lines; its head indicated by a swelling; its caudal extremity (in which is seen a white line, indicating the continuation of the medulla spinalis), slender, and terminating in the umbilical cord;—the mouth indicated by a cleft;—the eyes by two black points; the members begin to appear as nipple-like protuberances;—the liver occupies the whole abdomen;—the bladder is very large. The chorion is villous, but its villousities are still diffused over the whole surface.

Embryo of 6 weeks.—Its length from 7 to 10 lines;—its weight from 40 to 75 grains;—face distinct from cranium;—aperture of nose, mouth, eyes, and ears perceptible;—head distinct from thorax;—hands and fore-arms in the middle of the length, fingers distinct;—legs and feet situated near the anus;—clavicle and maxillary bone present a point of ossification;—distinct umbilicus for attachment of cord, which at that time consists of the omphalo-meseric vessels, of a portion of the urachus, of a part of the intestinal tube, and of filaments which represent the umbilical vessels. The placenta begins to be formed;—the chorion still separated from the amnion;—the umbilical vesicle very large.

Embryo of 2 months.—Length from 16 to 19 lines; weight from 150 to 300 grains; the elbows and arms detached from the trunk;—heels and knees also isolated;—rudiments of the nose and of the lips;—palpebral circle beginning to show itself;—clitoris or penis apparent; anus marked by a dark spot; rudiments of lungs, spleen, and supra-renal capsules;—cæcum placed behind the umbilicus;—digestive canal withdrawn into the abdomen;—urachus visible;—osseous points in the frontal bone and in the ribs.—Chorion commencing to touch the amnion at the point opposite the insertion of the placenta; placenta begins to assume its regular form;—umbilical vessels commence twisting.

Embryo of 3 months.—Length from 2 to 2½ inches;—weight from 1 oz. to 1½ oz. (Troy);—head voluminous;—eyelids in contact by their free margin; membrana pupillaris visible;—mouth closed;—fingers completely separated;—inferior extremities of greater length than rudimentary tail;—clitoris and penis very long;—thymus as well as supra-renal capsules present;—cæcum placed below the umbilicus;—cerebrum 5 lines, cerebellum 4 lines, medulla oblongata 1½ line, and medulla spinalis ¾ of a line, in diameter;—two ventricles of heart distinct.—The decidua reflexa and decidua uterina in contact;—funis contains umbilical vessels and a little of the gelatine of Warthon;—placenta completely isolated;—umbilical vesicle, allantois, and omphalo-mesenteric vessels have disappeared.

Fetus of 4 months.—Length 5 to 6 inches;—weight 2½ to 3 oz.;—skin rosy, tolerably dense;—mouth very large and open;—membrana pupillaris very evident; nails begin to appear;—genital organ and sex distinct;—cæcum placed near the right kidney;—gall-bladder appearing;—meconium in duodenum; cæcal valve visible; umbilicus placed near pubis;—ossicula auditoria ossified;—points of ossification in superior part of sacrum;—membrane forming at point of insertion of placenta on uterus;—complete contact of chorion with amnion.

Fetus of 5 months.—Length 6 to 7 inches; weight 5 to 7 oz.;—volume of head still comparatively great;—nails very distinct;—hair beginning to appear;—skin without sebaceous covering;—white substance in cerebellum; heart and kidneys very voluminous;—cæcum situated at inferior part of right kidney;—gall-bladder distinct;—germs of permanent teeth appear;—points of ossification in pubis and calcaneum;—meconium has a yellowish-green tint, and occupies commencement of large intestine.

Fetus of 6 months.—Length 9 to 10 inches;—weight 1 lb.;—skin presents some appearance of fibrous structure;—eyelids still agglutinated, and membrana pupillaris remains;—sacculi begin to appear in colon;—funis inserted a little above pubis;—face of a purplish red;—hair white or silvery;—sebaceous covering begins to present itself;—meconium in large intestines;—liver of dark red;—gall-bladder contains serous fluid destitute of bitterness;—testes near kidneys;—points of ossification in four divisions of sternum;—middle point at lower end of sternum.

Fetus of 7 months.—Length 13 to 15 inches; weight 3 to 4 lbs.;—skin of rosy hue, thick, and fibrous;—sebaceous covering begins to appear;—nails do not yet reach extremities of fingers;—eyelids no longer adherent;—membrana pupillaris disappearing;—a point of ossification in the astragalus;—meconium occupies nearly the whole of large intestine;—valvula conniventes beginning to appear;—cæcum placed in right iliac fossa;—left lobe of liver almost as large as right;—gall-bladder contains bile;—brain possesses more consistency;—testicles more distant from kidneys;—middle point at a little below end of sternum.

Fetus of 8 months.—Length 14 to 16 inches;—weight 4 or 5 lbs.;—skin covered with well-marked sebaceous envelope; nails reach extremities of fingers;—membrana pupillaris becomes invisible during this month;—a point of ossification in last vertebra of sacrum;—cartilage of inferior extremity of femur presents no centre of ossification;—brain has some

indications of convolutions;—testicles descend into internal ring;—middle point nearer the umbilicus than the sternum.

Fetus of 9 months, the full term.—Length from 17 to 21 inches;—weight from 5 to 9 lbs., the average probably about 6½ lbs.;—head covered with hair in greater or less quantity, of from 9 to 12 lines in length;—skin covered with sebaceous matter, especially at bends of joints;—membrana pupillaris no longer exists;—external auditory meatus still cartilaginous;—four portions of occipital bone remain distinct;—os hyoides not yet ossified; point of ossification in the centre of cartilage at lower extremity of femur;—white and grey substances of brain become distinct;—liver descends to umbilicus;—testes have passed inguinal ring, and are frequently found in scrotum;—meconium at termination of large intestine;—middle point of body at umbilicus, or a little below it.

948. Even at Birth, there is a manifest difference in the physical conditions of Infants of different sexes; for, in the average of a large number, there is a decided preponderance on the side of the Males, both as to the Length and the Weight of the body.

a. The Length of the body in fifteen new-born infants of each sex, as ascertained by Quetelet,* was as follows:—

	Males.	Females.	Total.
From 16 to 17 inches† (French)	2	4	6
- 17 to 18	8	19	27
- 18 to 19	28	18	46
- 19 to 20	12	8	20
- 20 to 21	0	1	1

From these observations, the mean and the extremes of the Lengths of the Male and Female respectively, were calculated to be,—

	Males.	Females.
Minimum . . . 16 inches, 2 lines	16 inches, 2 lines	16 inches, 2 lines
Mean . . . 18 6	18	1½
Maximum . . . 19 8	20	6

Notwithstanding that the maximum is here on the side of the Female (this being an accidental result, which would probably have been otherwise, had a larger number been examined), the average shows a difference of 4½ lines in favour of the Male.

b. The inequality in the Weight of the two is even more remarkable; the observations of M. Quetelet‡ were made upon 63 male and 56 female infants.

Infants weighing from	Males.	Females.	Total.
1 to 1½ kilog§	0	1	1
1½ to 2	0	1	1
2 to 2½	3	7	10
2½ to 3	13	14	27
3 to 3½	28	23	51
3½ to 4	14	7	21
4 to 4½	5	3	8

The extremes and means were as follows:—

	Males.	Females.
Minimum	2.34 kilog.	1.12
Mean	3.20	2.91
Maximum	4.50	4.25

c. The average weight of infants of both sexes, as determined by these inquiries, is 3.05 kilog. or 6.7 lbs.; and this corresponds almost exactly with the statement of Chaussier, whose observations were made upon more than 20,000 infants. The mean obtained by him, without reference to distinction of sex, was 6.75 lbs.; the maximum being 11.3 lbs., and the minimum 3.2 lbs.¶ The average in this country is probably rather higher; according to Dr. Joseph Clarke,¶ whose inquiries were made on 60 males and 60 females, the average of

* Sur L'Homme, tom. ii. p. 8.

† The French inch is about one-fifteenth more than the English.

‡ Op. cit., tom. ii. p. 35.

§ The kilogramme is equal to 2½ lbs. a voidrupois.

¶ These numbers have been erroneously stated in many Physiological works; owing to the difference between the French and English pound not having been allowed for.

¶ Philosophical Transactions, vol. lxxvi.

Male children is $7\frac{1}{2}$ lbs.: and that of Females $6\frac{3}{4}$ lbs. He adds that children which at the full time weigh less than 5 lbs. rarely thrive; being generally feeble in their actions, and dying within a short time. Several instances are on record, of infants whose weight at birth exceeded 15 lbs. It appears that healthy females, living in the country, and engaged in active but not over-fatiguing occupations, have generally the largest children; and this is what might be expected *à priori* from the superior activity of their nutritive functions.

949. Notwithstanding that, in any ordinary population, there is a decided preponderance in the number of Females, the number of Male *births* is considerably greater than that of females. Taking the average of the whole of Europe, the proportion is about 106 Males to 100 Females. It is curious, however, that this proportion is considerably different for legitimate and for illegitimate births; the average of the latter being only $102\frac{1}{2}$ to 100, in the places where that of the former was $105\frac{3}{4}$ to 100. This is probably to be accounted for by the fact, which is one of the most remarkable contributions that have yet been made by Statistics to Physiology, that the Sex of the offspring is influenced by the relative *ages* of the parents. The following table expresses the average results obtained by M. Hofacker* in Germany, and by Mr. Sadler† in Britain; between which it will be seen that there is a manifest correspondence, although both were drawn from a too limited series of observations. The numbers indicate the proportion of Male births to 100 Females, under the several conditions mentioned in the first column.

	Hofacker.		Sadler.
Father younger than Mother	90·6	Father younger than Mother	86·5
Father and Mother of equal age	90·0	Father and Mother of equal age	94·8
Father older by 1 to 6 years	103·4	Father older by 1 to 6 years	103·7
. 6 to 9	124·7 6 to 11	126·7
. 9 to 18	143·7 11 to 16	147·7
. 18 and more	200·0 16 and more	163·2

From this it appears, that the more advanced age of the Male parent has a very decided influence in occasioning a preponderance in the number of Male infants; and as the state of society generally involves a condition of this kind in regard to marriages, whilst in the case of illegitimate children the same does not hold good, the difference in the proportional number of male births is accounted for. We are not likely to obtain data equally satisfactory in regard to the influence of more advanced age on the part of the Female parent; as a difference of 10 or 15 years on that side is not so common. If it exist to the same extent, it is probable that the same law would be found to prevail in regard to Female children born under such circumstances, as has been stated with respect to the Male;—namely, that the mortality is greater during embryonic life and early infancy, so that the preponderance is reduced.

950. There appears to be, from the first, a difference in the *viability* (or probability of life) of Male and Female children; for, out of the total number born dead, there are 3 Males to 2 Females: this proportion gradually lessens, however, during early infancy; being about 4 to 3 during the first two months, and about 4 to 5 during the next three months; after which time the deaths are nearly in proportion to the numbers of the two sexes respectively, until the age of puberty. The viability of the two sexes continues to increase during childhood; and attains its maximum between the 13th and 14th years. For a short time after this epoch has been passed, the rate of mortality is higher in Females than in Males; but from about the age of 18 to 28, the mortality is much greater in Males, being at its maximum at 25, when the viability is only half what it is at puberty. This fact is a very striking one; and shows most forcibly that the indulgence of the passions not only weakens the health, but in a great number of instances is the cause of a very premature

* Annales d'Hygiène, Oct. 1829.

† Law of Population, vol. ii. p. 343.

death. From the age of 28 to that of 50, the mortality is greater, and the viability less, on the side of the Female; this is what would be anticipated from the increased risk, to which she is liable during the parturient period. After the age of 50, the mortality is nearly the same for both.

a. These facts have been expressed by Quetelet in a form which brings them prominently before the eye (Fig. 289). The relative viability of the Male at different ages is represented by a curved line; the elevation of which indicates its degree, at the respective periods marked along the base line. The dotted line which follows a different curve, represents the viability of the Female. Starting from *a*, the period of birth, we arrive at the maximum of viability for both at *b*; from this point, the Female curve steadily descends towards

Fig. 289.

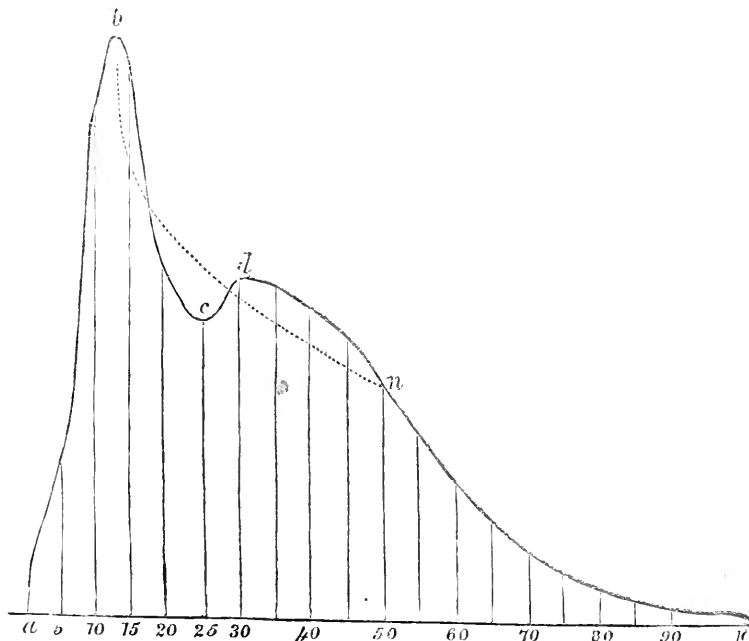

Diagram representing the comparative Viability of the Male and Female at different Ages.

n, at first very rapidly, but afterwards more gradually; whilst the Male curve does not descend quite so soon, but afterwards falls much lower, its minimum being *c*, which corresponds with the age of 25 years. It afterwards ascends to *d*, which is the maximum of viability subsequently to the age of puberty; this point is attained at the age of 30 years, from which period, up to 50, the probability of life is greater in the Male than in the Female. In the decline of life there seems little difference for the two sexes.

951. Similar diagrams have been constructed by Quetelet, to indicate the relative Heights and Weights of the two sexes (Fig. 290).

a. In regard to Height it may be observed, that the increase is most rapid in the first year, and that it afterwards diminishes gradually; between the ages of 5 and 16 years, the annual increase is very regular. The difference between the Height of the Male and Female, which has been already stated to present itself at birth, continues to increase during infancy and youth; it is not very decided, however, until about the 15th year, after which the growth of the Female proceeds at a much diminished rate, whilst that of the Male continues in nearly the same degree, until about the age of 19 years. It appears, then, that the Female comes to her full development in regard to Height, earlier than does the Male. It seems probable, from the observations of Quetelet, that the full height of the Male is not

generally attained until the age of 25 years. At about the age of 50, both Male and Female undergo a diminution of their stature, which continues during the latter part of life.

b. The proportional Weight of the two sexes at different periods, corresponds pretty closely with their height. Starting from birth, the predominance then exhibited by the Male gradually increases during the first few years; but towards the period of puberty, the proportional weight of the Female increases; and at the age of 12 years, there is no difference between the two sexes in this respect. The weight of the Male, however, then increases much more rapidly than that of the Female, especially between the ages of 15 and 20 years; after the latter period, there is no considerable increase on the side of the Male, though his maximum is not attained until the age of 40; and there is an absolute diminution on the part of the Female, whose weight remains less during nearly the whole period of child-bearing. After the termination of the parturient period, the weight of the Female again undergoes an increase, and its maximum is attained about 50. In old age, the weight of both sexes undergoes a diminution in nearly the same degree. The average Weights of the Male and Female, that have attained their full development, are twenty times those of the new-born Infant of the two sexes respectively. The Height, on the other hand, is about $3\frac{1}{2}$ times as much.

Fig. 290.

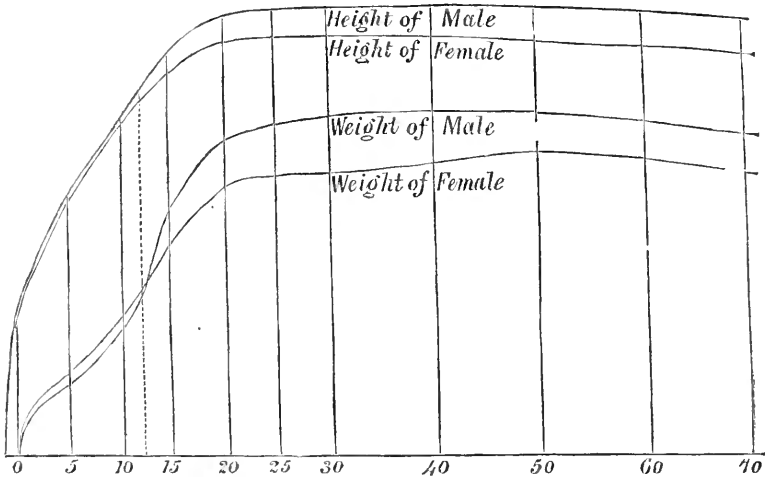

952. The chief differences in the Constitution of the two sexes manifest themselves during the period, when the Generative function of each is in the greatest vigour. Many of these distinctions have been already alluded to; but there are others of too great importance to be overlooked; and these chiefly relate to the Nervous System and its functions. There is no obvious structural difference in the Nervous System of the two sexes (putting aside the local peculiarities of its distribution to the organs of generation); save the inferior size of the Cerebral Hemispheres in the Female. This difference, which is not observed in other parts of the Encephalon, is readily accounted for on the principles formerly stated; when we compare the physical character of Woman, with that of Man. For there can be no doubt that—putting aside the exceptional cases which now and then occur—the intellectual powers of Woman are inferior to those of Man. Although her perceptive faculties are more acute, her capability of sustained mental exertion is much less; and though her views are often peculiarly distinguished by clearness and decision, they are generally deficient in that comprehensiveness which is necessary for their stability. With less of the *volitional* powers than Man possesses, she has the *emotional* and *instinctive* in a much stronger degree. The emotions therefore predominate; and more frequently become the leading

springs of action, than they are in Man. By their direct influence upon the bodily frame, they produce changes in the organic functions, which far surpass in degree anything of the same kind that we ordinarily witness in Man; and they thus not unfrequently occasion symptoms of an anomalous kind, which are very perplexing to the Medical practitioner, but very interesting to the Physiological observer. But they also act as powerful motives to the Will; and, when strongly called forth, produce a degree of vigour and determination, which is very surprising to those who have usually seen the individual under a different aspect. But this vigour, being due to the strong excitement of the Feelings, and not to any inherent strength of Intellect, is only sustained during the persistence of the motive, and fails as soon as it subsides. The feelings of Woman, being frequently called forth by the occurrences she witnesses around her, are naturally more disinterested than those of Man; *his* energy is more concentrated upon one object; and to this his intellect is directed with an earnestness that too frequently either blunts his feelings, or carries them along in the same channel,—thus rendering them selfish. The *intuitive* powers of Woman are certainly greater than those of Man. Her perceptions are more acute, her apprehension quicker; and she has a remarkable power of interpreting the feelings of others, which gives to her, not only a much more ready sympathy with these, but that power of guiding her actions so as to be in accordance with them, which we call *tact*. This *tact* bears a close correspondence with the *adaptiveness* to particular ends, which we see in Instinctive actions. In regard to the inferior development of her Intellectual powers, therefore, and in the predominance of the Instinctive, Woman must be considered as ranking below Man; but in the superior purity and elevation of her Feelings, she is as highly raised above him. Her whole character, Psychological as well as Corporeal, is beautifully adapted to supply what is deficient in Man; and to elevate and refine those powers, which might otherwise be directed to low and selfish objects.

APPENDIX.

I.—ON PHRENOLOGY.

WITHOUT entering into a general discussion of the merits of the system of Phrenology at present in vogue, which would be misplaced in a Treatise like the present, the Author feels it desirable to express the opinion, which a recent careful examination of the chief questions at issue between Phrenologists and their opponents have led him to entertain.

That the different portions of the Cerebral mass should have different parts to perform in that wonderful series of operations, by which the Brain as a whole becomes the instrument of the Mind, does not seem to him in the least improbable. Nor, if we duly consider the general plan of construction of the nervous centres in Vertebrated animals, is it a legitimate objection to such a view, that there is no mechanical distinction of "organs" either upon the surface or in the interior of the Cerebrum; for in the Spinal Cord and Medulla Oblongata, there is a continuous tract of grey matter, which is really made up of an assemblage of ganglia having dissimilar functions, although there are no external indications of the distinctness of these ganglia. Further, it appears to be quite legitimate to judge of the comparative powers of different parts of the Cerebrum, or of the same portions in different individuals, by their comparative sizes; due allowance being made for other circumstances of difference. And if the development of a particular part of the Cerebrum were constantly found to be in harmony with the manifestation of a certain feature of psychical character, there would be strong ground for regarding such a part as the instrument of the mental operation in question. The attempt to establish a system of Cerebral Physiology by comparative observations of this nature, appears to the Author, therefore, a most legitimate one; and his objections to the *present system* of Phrenology are based only on the very imperfect manner in which it has been constructed; the foundations on which it rests being (in his opinion) of a very insecure character; and the superstructure having been built up of the slightest possible materials. The following are the chief points on which he feels called upon to express his dissent.

1. The present system of Phrenology is founded only on comparative observation of the psychical character and cerebral conformation in different individuals of the Human species alone; evidence derived from Comparative Anatomy being admitted only so far as it corresponds with the system thus constructed. When the fundamental importance of the study of Comparative Anatomy in the determination of the functions of all other organs, and of other parts of the Nervous System itself, is duly considered, the Author cannot regard any system of Cerebral Physiology as having a claim to a place in a scientific treatise, which is not founded on this basis.

2. The present system of Phrenology is altogether inconsistent with well-ascertained facts, regarding the Comparative Anatomy and Embryological Development of the Cerebrum. It is clearly established by anatomical research, that the *posterior* lobes of the Cerebrum are relatively much smaller in the Quadrumana than they are in Man, and that they disappear altogether in the Carnivora, not a vestige of them being discoverable in any of the lower Mammalia; and that the *middle* lobes, though they may be traced in the lowest of the Mammalian Class, are altogether wanting in Birds, Reptiles, and Fishes. The Cerebrum of these animals, therefore, is the rudiment of the *anterior* lobe only of that of Mammalia.—Further, it has been lately shown by Prof. Retzius (whose researches on this head are confirmatory of those of Tiedemann, at the same time being more full and precise), that the development of the Cerebrum of the Human Embryo takes place on the same plan. In the first period, which corresponds with the second and third months, only the anterior lobes form; in the second period which is comprised in the end of the third month, in the fourth, and in a small portion of the fifth, the two middle lobes appear; and it is not until the latter part of the fifth month, that the development of the posterior lobes properly commences. They sprout, as it were, from the posterior extremity of the middle lobes; from which they are divided, on the brain of the mature fœtus, as well as occasionally in that of adults, by a distinct furrow.—The exact mutual confirmation afforded by these two sources of knowledge,

proves the complete inadmissibility of the ordinary Phrenological interpretation of the increased development of the posterior lobes in Man,—namely, that they are present in all Vertebrata, but that they are pushed backwards in the higher forms by the increased development of the anterior portion of the Cerebrum. Now as the Instincts and Propensities are located, according to the present system of Phrenology, in the posterior and middle lobes of the Cerebrum, which are altogether wanting in the Oviparous Classes in which these Instincts and Propensities most strongly manifest themselves, it would appear that some fundamental error must exist in the allocation.

3. The present system of Phrenology takes no account whatever of the series of ganglionic masses, which lie at the base of the Cerebrum in Man, and which are thrown into the shade (as it were) by its excessive development; but which increase in relative size and importance as we descend the scale, until, in the lower Fishes and Invertebrata generally, they come to constitute the whole Brain. We have seen that, in the Cod, the rudiment of the Cerebrum is much smaller than a single pair of these ganglia,—the Optic; and as this rudiment does not possess a ventricle (which is present in the Sharks, &c., dividing the rudiment of the hemisphere which arches over it, from the corpus striatum which lies at its base), it is probably to be regarded as not really analogous to any part of the Cerebrum strictly so called, but to the Corpus Striatum, which (with the Thalamus) constitutes an independent organ. Thus we have the Cerebrum entirely disappearing in the Osseous Fishes; and the whole Brain made up of the Sensory Ganglia and the Cerebellum.—In the Invertebrata, not the rudiment of a Cerebrum can be discovered; the cephalic masses of nervous matter being made up of ganglia in immediate connection with the organs of sense and motion. It is obvious, therefore, that these organs must be of primary importance as centres of nervous action; and that the functions of the Cerebrum, whatever be their nature, must be of a *super-added*, and of a *non-essential* character.—The view which the Author takes of these phenomena will be found at large in the Text. He regards the Sensory Ganglia as the seat of Sensation (each kind of sensation being communicated through its own ganglion) and of the simple feelings of pleasure and pain connected with those sensations; and also as the instrument of those *consensual* movements, which follow immediately and necessarily upon sensations. To this category he would refer the purely *Instinctive* actions, which are immediately prompted by sensations, which seem to involve no *idea* of the purpose towards which they are directed, and which cannot be said (the idea of the object being deficient) to spring from a desire or propensity. Probably all or nearly all the actions of Invertebrata and of the lower Fishes are of this class. The emotions and propensities of Man and of the higher Mammalia, which form the chief springs of action in them, may be regarded as involving the combined operation of the Sensory Ganglia and the Cerebrum; the latter affording the *ideas*, whilst the former invest these ideas with the pleasure or pain, which gives them the form of passions, desires, or propensities, and which causes them to become the moving springs of a great part of the intellectual operations, which are purely Cerebral. The action of the Cerebrum in the passions, emotions, &c., is limited, therefore, on this view of their nature, to its instrumentality in furnishing the several *classes of ideas* to which those emotions respectively relate. If the Phrenological system be thus modified, there will no longer be the same difficulty in reconciling it with the facts of Comparative Anatomy; since in those animals which are unpossessed of the posterior lobes, the actions, which in Man and the higher Mammalia result from desires or propensities involving a distinct idea or conception of the object, may be purely instinctive, and may thus be performed through the medium of the Sensory Ganglia alone, without the participation of the Cerebrum.

4. The present system of Phrenology leaves undetermined a very large proportion of the Cerebral surface in Man,—probably not less than one-half; namely the whole series of convolutions covering the opposing median surfaces of the hemispheres, the convolutions of nearly the whole of the base of the Cerebrum, and those of the fissure of Sylvius. Yet not the slightest ground can be adduced for the supposition that these unappropriated portions have any less participation in the operations of the intellect, the exercise of the moral feelings, or the influence of the animal propensities, than have the external and superior portions of the respective lobes. No admission of the imperfection of the present system of Phrenology can be a sufficient explanation of this fact, which would seem to indicate some fundamental error in the method employed; since one of the great claims which is set up in behalf of that system is the completeness of the system of Psychological philosophy which it presents; so that, if there were every facility for observing the relative development of the parts of the Cerebral surface in question, there would seem to be no “organs” left to distribute over it.

5. If it be urged, however, that none of these objections are sufficient to overthrow the position, now established by a long course of observation, that a constant correspondence exists in Man between the development of certain parts of the Cerebrum, and particular Psychological characteristics, and that the present system *must* consequently be true, in spite of its inconsistency with the facts of Comparative Anatomy, it becomes necessary to inquire in

more detail into the character of the evidence adduced in its behalf.—The following objections may be urged upon this subject. The greater part of the observations upon which the present system of Phrenology rests, have been made upon crania alone, or upon casts of crania; not upon the cerebrum itself. In this method of observation there are many fallacies; especially those arising from the indisputable fact, that the cerebrum may be moulded in such a manner as to undergo considerable alteration in form, without any change in its internal structure or in the relative development of its several parts. And an extensive comparison of the crania of different nations shows that their differences of form have in many instances no relation whatever to their psychical character. That the form of the cranium is to a certain extent independent of that of the brain, and may impress itself upon its contents, appears further from a comparison between the cerebral and cranial conformations of different species of animals. It is found that, even when closely-allied species are compared together, *similar* projections of the cranium may cover *different* convolutions; the general form of the cranium being modified by its instrumentality in other functions, especially in mastication, and by its position upon the trunk and its mode of muscular connection with it. There is a peculiar uncertainty attending all estimates of the comparative size of the Cerebellum, from inspection of the exterior of the cranium; for the observations of Prof. Retzius upon the varieties of form which the cranium presents in different races, have indicated this fact among others,—that the position of the cerebellum may vary considerably, being much more horizontal in one case and more vertical in another; so that cerebella of the same size may exist in crania having very different amounts of occipital protuberance; and *vice versa*.—Further, after dismissing the sources of error already mentioned, there yet remain many, arising from want of precision in the cranioscopic observations, and want of opportunity of forming a correct estimate of the characters of the individuals whose “developments” have been examined. The difficulty of precisely estimating the relative sizes of different organs by any system of measurement, which has been acknowledged and regretted by candid phrenologists, often leads to the formation of very different inferences from the same data, as the Author can vouch from his own knowledge. And when the estimate of the character has been formed from craniological indications, there are many difficulties in the way of a faithful comparison with the real character of the individual, of which the manifestation in his ostensible conduct can generally reveal but a small part. Now there can be little doubt, that the habit of attending to and of recording *coincidences* between cerebral developments and psychical manifestations, without due regard to the cases in which there is *no* coincidence, has been far too prevalent amongst professed phrenologists. Unless the failures are duly chronicled with the successes, no value can be attached to any series of observations, however numerous and satisfactory. Many such failures, upon points in regard to which there could be no misapprehension or evasion, have come under the Author’s knowledge; and have tended to prevent his reception of the present phrenological system; but they find no place in formal treatises on Phrenology, which lead their readers to suppose that the coincidences are invariable. The connection of the Sexual propensity with the Cerebellum has been usually regarded by Phrenologists as one of the best-ascertained of its whole series of dogmata; and yet we have seen how little this determination can stand the test of a careful scrutiny.

Those who are desirous of studying the Phrenological system at present in vogue, as expounded by an intelligent and unfettered partisan, may be referred to Mr. Noble’s recent treatise, entitled “The Brain and its Physiology;” whilst the objections summed up in this Appendix are stated more at large in a critique on that work in the British and Foreign Medical Review, for October, 1846.

II.—ON ARTIFICIAL SOMNAMBULISM AND MESMERISM.

It appears to the Author that the time has now come, when a tolerably definite opinion may be formed regarding a large number of the phenomena commonly included in the term “Mesmerism.” Notwithstanding the exposures of various pretenders, which have taken place from time to time, there remains a considerable mass of phenomena, which cannot be so readily disposed of, and which appear to him to have as just a title to the attention of the scientific Physiologist, as that which is possessed by any other class of well-ascertained facts.

Passing over, for the present, the inquiry into the manner in which these effects may be induced, the Author may briefly enumerate the principal phenomena which he regards as having been veritably presented in a sufficient number of instances, to entitle them to be considered as genuine and regular manifestations of the peculiar bodily and mental condition under discussion.

1. A state of complete Coma or perfect insensibility, analogous in its mode of access and departure to that which is known as the “Hysteric Coma,” and (like it) usually distin-

guishable from the Coma of Cerebral oppression by a constant twinkling movement of the eyelids. In this condition, severe surgical operations may be performed, without any consciousness on the part of the patient; and it is not unfrequently found that the state of torpor extends from the Cerebrum and Sensory Ganglia to the Medulla Oblongata, so that the respiratory movements become seriously interfered with, and a state of partial asphyxia supervenes.

2. A state of Somnambulism or Sleep-waking, which may present all the varieties of the natural Somnambulism, from a very limited awakening of the mental powers, to the state of complete double Consciousness (§ 500), in which the individual manifests all the ordinary powers of his mind, but remembers nothing of what has passed when restored to his natural waking state. This state of Somnambulism, in the form which it commonly takes, is characterized by the facility with which the thoughts are directed into any channel which the observer may desire, by the principle of "suggestion;" and by the want of power, on the part of the Somnambulist, to apply the teachings of ordinary experience to the correction of the erroneous ideas which are thus made to occupy the mind. In these particulars, this condition closely corresponds with that of Dreaming; and differs from it chiefly in the readiness with which ideas are excited through the ordinary channels of sensation, and with which the bodily powers are called into action to give effect to the ideas thus aroused. The emotional states are more easily brought into play, than the purely intellectual operations. It is a peculiar characteristic of this condition, that the whole attention may be so completely fixed upon one object, that there is an insensibility to all impressions unconnected with it, although every thing which bears upon it is fully appreciated. In this respect there is a complete correspondence with the phenomena of ordinary somnambulism; but there is this difference,—that, from the greater subjection of the mind to external influences, it may be more readily played upon (so to speak) by the observer, and may thus be exclusively fixed upon any object which he may direct. In this manner, a state of insensibility to pain may be brought about, nearly as complete as that which occurs in the comatose state, by causing the mind to be strongly and exclusively directed towards another object. This condition finds its parallel in that of Reverie; in which strong impressions upon the body may be unfelt, so long as the mind is engrossed upon some different train of thought.

3. A frequent phenomenon of this condition, and one which has its parallel in Natural Somnambulism, is a remarkable exaltation of one or more of the Senses, so that the individual becomes susceptible of influences, which, in his natural condition, would not be in the least perceived. The Author has referred to a case (§ 532, *note*) in which such an exaltation of the sense of Smell was manifested; and in the same case, as in many others, there was a similar exaltation of the sense of Temperature. The exaltation of the Muscular Sense, by which various actions that ordinarily require the guidance of vision, are directed independently of it, is a common phenomenon of the Mesmeric or Artificial, as of the Natural, Somnambulism.

4. The Muscular system may also be excited to action in unusual modes, and with unusual energy. Notwithstanding the fallacy of many of the cases of Cataleptic rigidity which have been publicly exhibited, the Author is satisfied, from investigations privately made, of the possibility of artificially inducing this condition. A slight irritation of the muscles themselves, or of the skin which covers them,—as by drawing the points of the fingers over them, or even wafting currents of air over the surface,—is sufficient to excite the tonic muscular contraction, which may continue in sufficient force to suspend a considerable weight, for a longer period than it could be kept up by any conceivable effort of voluntary power. Further, by directing the attention exclusively to any set of muscles, and by impressing the mind of the Somnambulist with the facility of the action to be performed, a very extraordinary degree of muscular power may be called forth, even in very feeble individuals. Thus the Author has seen a man of extremely low muscular development and small stature, not only lift up a 28 lb. weight upon his little finger, but even swing it round his head with the greatest apparent facility,—having been previously assured that it was as light as a feather. Upon taking up the same weight upon their own little fingers, the Author and his friends were very glad to lay it down after raising it a foot from the ground; and the subject of the experiment (a respectable middle-aged man, who was not a regular "exhibitor," and upon whom no suspicion of any kind rested) declined, when in his waking state, even attempting to lift the weight, on the ground that it would strain him too much.

These are the principal phenomena of Artificial Somnambulism, in regard to which the Author feels his mind made up. He does not see why any discredit should be attached to them, since they correspond in all essential particulars with those of states, which naturally or spontaneously occur in many individuals, and which he has had opportunities of personally observing, in cases in which the well-known characters of the parties placed them above suspicion. When the facility with which the mind of the Somnambulist is played on by suggestions conveyed either in language or by other sensations which excite associated ideas, and the absence of the corrective power ordinarily supplied by past experience, are

duly kept in view, many of the supposed "higher phenomena" of Mesmerism may be accounted for, without regarding the patient on the one hand as possessed of extraordinary powers of divination, or on the other as practising a deception. Thus, bearing in mind that Somnambulism is an acted dream, the course of which is governed by external impressions, it is easy to understand how the subject of it may be directed by leading questions to enter buildings which he has never seen, and to describe scenes which he has never witnessed, without any intentional deceit. The love of the marvellous so strongly possessed by many of the witnesses of such exhibitions, prompts them to grasp at and to exaggerate the coincidences in all such performances, and to neglect the failures; and hence reports are given to the public, which, when the real truth of them is known, prove to have been the results of a series of guesses, the correctness of which is in direct relation to the amount of guidance afforded by the questions themselves. In like manner the manifestations of the excitement of the "phrenological organs" seem to depend upon the conveyance of a suggestion to the patient, either through his knowledge of their supposed seat, or through the anticipations expressed by the by-standers. Many instances are recorded, in which the intention has been stated of exciting one organ, whilst the finger has been placed upon or pointed at another; and the resulting manifestation has always been that which would flow from the former. It does not hence follow that intentional deception is being practised by the Somnambulist; since the condition of mind already referred to, causes it to respond to the suggestion which is most strongly conveyed to it. Many of the emotional states are readily excitable, by placing the muscles in the position which naturally expresses them; thus the combative tendency may be called forth by gently flexing the fingers, so as to double the fist; a cheerful hilarious mood may be induced by drawing outwards the corners of the mouth as in laughter; and this may be exchanged for the reverse state of gloom and ill-temper, by drawing the eyebrows downwards and towards each other, as in frowning. In like manner, on putting the hand upon the vertex, the Somnambulist draws himself up, and shows the manifestation of self-esteem; whilst the depression of the head into the position of humility calls forth the corresponding emotion. Those who have carefully observed the habits of infants and young children, must perceive the accordance of these phenomena with those which continually present themselves at that early period of life, when the condition of the mind is so completely under the government of suggestions received from without.

In regard to the alleged powers, which are said to be possessed by many Somnambulists, of reading with the eyes completely covered, or of discerning words enclosed in opaque boxes, the Author need only here express his complete conviction that no case of this description has ever stood the test of a searching investigation.

The modes in which the Artificial Somnambulism may be induced, are extremely various. The experiments of Mr. Braid have shown, that one of the most effectual is the continued convergence of the eyes upon a bright object, held at a small distance above and in front of them, and gradually approximated towards them. The mere steady direction of the eyes towards a distant object, in persons who have often practised the former method, frequently serves to induce the state. All the phenomena described in the preceding paragraphs, have been witnessed by the Author in individuals thus "hypnotized;" and he considers that this curious class of observations cannot be better prosecuted than by the employment of that method. He is not yet satisfied that, in the ordinary "Mesmeric" process, any other influence than this is really exerted; but the patient is sent to sleep with the dominant idea that some special influence is exerted by the Mesmerizer, and this idea affects all the subsequent phenomena,—producing, for example, in some cases, insensibility to everything but what is said by the mesmerizer or by an individual placed by him *en rapport* with the Somnambulist. It will generally be found, that the degree of this supposed connection depends upon the notions of it previously formed by the individual Mesmerized. In the hypnotic state, there is an entire absence of any such peculiar influence; the Somnambulist being equally conscious of what is said or done by every bystander.

The Author may refer to an Article in the British and Foreign Medical Review for April, 1845, as on the whole expressing (although not written by himself) his opinions upon this curious and interesting subject.

INDEX.

The Numbers refer to the Paragraphs.

A.

- ABERRATION, spherical, 535; chromatic, 535
 Abnormal forms of nutritive process, 802—809
 Abortion, 929
 Abscess, 804
 Absorbent cells, 181, 182
 _____ vessels, see Lacteals, and Lymphatics
 ABSORPTION
 Nutritive, general account of, 107, 271; by intestinal surface, 672—675; by lacteals, 672, 674; by blood-vessels, 673, 675; by general surface, 676—681; by skin, 676—679; by lungs, 678, 775, 776
 Interstitial, by lymphatics, 680, 681; by veins, 681 *b*
 Of gases and vapours by lungs, 775, 776
 Abstinance, cases of, 653
 Actinia, nervous system of, 312, 313
 Activity, varying, of nutritive processes, 786—791
 Adaptiveness of movements, no proof of sensation, 306
 Addison, Mr., his observations on blood-corpuscles referred to, 151, 158, 159; on fibrillation of liquor sanguinis, 136; on blood-vessels of lungs, 758; on pus, 806
 Adhesion, 793, 794
 Adipose tissue, see Fat-cells
 Aeration, 107; see Respiration
 Afferent nerves, 289, 344
 Age, influence of, on pulse, 727 *a*; on excretion of carbonic acid, 767 *b*; on excretion of urea, 844; on activity of nutritive processes, 786, 812; on power of calorification, 893
 Air, influence of respiration on, 765—768
 Air-cells of lungs, 757, 758
 Albinoism, 80
 Albumen, 112; composition of, 114; properties of, 113—115; conversion of into fibrine, 114, 117, 153—158; proportion of in blood, 697, 706; purposes of, 698; diminution of in blood, 707 *d*; predominance of in tubercular deposits, 878
 Albuminous principles of food, 640, 857; application of in the animal body, 642
 Albuminuria, 707 *d*
 Alcock, Dr., his experiments on nerves of taste, 407
 Alcohol, use of in supporting heat, 896 *note*
 Alfourous, 105
 Aliment, causes of demand for, 629—635; see Food
 Alimentary materials, 640; see Food
 Allantoin, 845 *c*
 Allantois, origin and uses of, 839 *c*
 Allen and Pepys, their researches on respiration, 765
 American nations, 101
 Amphibia, 31
 Amphioxus, 110, 180; nervous centres of, 425
 Anæmia, 707 *c*
 Andral, M., on amount of carbonic acid excreted, 767; on pathological changes in blood, 706, 707
 Animal Heat, see Heat
 Animal kingdom, primary subdivisions of, 5
 Animal magnetism, *Appendix II.*
 Animals, distinguished from Plants, 1—4
 _____ early development of, 3
 Anselmino, on solid matters of cutaneous exhalation, 869
 Aplastic deposits, 804, 807
 Aplysia, 12, 15; nervous system of, 321
 Apoplexy, decrease of fibrine in, 707 *c*; death by, 814
 Arabian nations, 94
 Arciform fibres of medulla oblongata, 353
 Area pellucida, 936
 Areolar tissue, 138, 139
 Areas, comparative, of arteries, 710
 Arnott, Dr., on stammering, 619; on the venous circulation, 744 *b*
 Arteries, distribution of, 710; area of, 710; structure and properties of, 728—732; elasticity of, 729; their contractility, proofs of, 730; its influence in regulating the circulation, 732; their tonicity, 731; influence of nerves upon, 623, 732
Articulata, 5, 16—19; segmental division of, 16; animal powers of, 17; nutrition of, 18; bi-lateral sympathy of, 16; respiration and heat of, 18; nervous system of, 324—334
 Articulate sounds, 612—619; vowels, 613—615; consonants, 616, 617
 Articulation, movements of, guided by sensation, 611, 617
 Asphyxia, nature of, 778; phenomena of, 779; 780; referred to, 738, 740, 814, 820
 Assimilation in Plants, 107; in Animals, 271, 781
 Asthma, spasmodic, 504, 759
 Atrophy, 789—791

The Numbers refer to the Paragraphs.

- Attention, effects of, on sensations, 519—521
 Auditory ganglia, in Fishes, 357; in Man, 422
 Auditory nerve, 446; terminations of, in ear, 559
 Auricles of heart, action of, 718, 719; capacity of, 723 *b*
 Automatic actions, 438 *a*
 Azote, absorption and exhalation of, 766; excretion of, in urine, 819, 842—850; respiration in, 769, 780
- B.
- BARRY, Dr. M., his researches on the blood-corpuscles referred to, 148; his embryological researches referred to, 130, 900—918
 Barry, Sir D., his experiments on the venous circulation, 744 *b*
 Basement-membrane, 135
 Bat, peculiar sensibility of, 526
 Batrachia, 31, 32; metamorphosis of, 32
 Beaumont, Dr., his experiments and observations on digestion, 637, 649, 657—660, 664—666
 Becquerel on the heat of Plants, 889 *a*; on the heat of Animals, 891; on the heat of Muscle, 890
 Bee, perfection of instinct of, 336; construction of hexagonal cell by, 336 *note*; uneducability of, 429 *b*; temperature of, 889 *c*
 Bell, Sir C., his discoveries referred to, 344, 349, 351, 376, 377, 433
 Bell, Mr. T., on the development of the teeth, 217 *i*; on secretion after death, 624
 Bellingieri, on the Spinal Cord, 349
 Berger and Delaroché, their experiments on Animal Heat, 888
 Berber race, 94
 Bernard, M. Ch., his researches on digestion, 658 *b*, 664 *b*, 669
 Bibra, Von, his analyses of Bone, 196; of Teeth, 212
 Bile, secretion of, 831—837; composition of, 833; amount of, 834; formed from venous blood, 831; partly an excrementitious fluid, 836; effects of non-elimination of, 836; sources of, 836; purposes of, in digestive process, 660, 670, 671, 835
 Birds, 33—41; skeleton of, 37, 38; respiration and heat of, 33, 757, 889 *c*; covering of, 36; instinctive powers and intelligence of, 39, 479, nutritive system in, 40; bi-lateral symmetry in, 40; development of young in, 41; blood-corpuscles of, 146 *b*, 149; brain of, 361
 Bischoff, his experiments on respiration, 768
 Bladder, contraction of, 390
 Blake, Mr., his experiments on the Circulation, 725
 Blind persons, acuteness of touch in, 525
 Blondlot, M., his researches on digestion, 658 *b*, 664 *b*
 BLOOD,
 Physical and vital properties of, 696—708; composed of liquor sanguinis and corpuscles, 696; proportion of components of, in health, 697; purposes of, 698; total amount of in body, 724
 Structure of Red Corpuscles, 143, 144; form of corpuscles, 145, 146; size of corpuscles, 146; chemical constitution of corpuscles, 147; origin of, from each other, 148; first production of, in embryo, 149; purposes of, in animal economy, 150
 Colourless corpuscles, 151, 152; their uses in the economy, 153—159
 Serum, composition of, 697; milky, 697 *e*
 Coagulation of, 699—705; due to fibrine alone, 117, 118, 699; an act of vitality, 118, 700, 701; causes influencing, 701, 702; proportions of serum and clot, 703; buffy coat, causes of, 704, 705; composition of, 116 *a*; artificially producible, by retarding coagulation, 699
 Pathological changes in, 706—708; normal proportion of chief constituents, 706; influence of abstinence and hemorrhage, 707; increase of fibrine in inflammation, 158, 707 *a*, 802; deficiency of fibrine in fever and hemorrhagic diseases, 707 *b*; increase of corpuscles in plethora, 707 *c*; diminution in chlorosis, anæmia, &c., 707 *c*; decrease of albumen in Bright's disease, 707 *d*; general depravation of, 708; imperfect elaboration of, in tuberculous cachexia, 807
 Changes produced in, by respiration, 769—772; difference of arterial and venous blood, 769; excretion of carbonic acid from, 769; absorption of oxygen by, 766; gases extracted from, 770; change of colour, causes of, 771, 772; aeration of, by general surface, 768
 Organization of, 118, 700, 796
 Movement of through vessels, see Circulation
 Blood-discs, see Corpuscles
 Blood-vessels, see Arteries, Capillaries, and Veins
 Bone, 192—207; structure of, 192—196; formation of, in membrane, 197; in cartilage, 198—200; chemical composition of, 196; growth of, 201—203; regeneration of, 204—207
 Bouchardat, M., his researches on digestion, 670
 Bovista giganteum, 153 *a*
 Bourgerie, M., his observations on air-cells of lungs, 757 *a*
 Bowman, Mr., his observations on muscular fibre, 226, 228, 231, 232, 590 *a*; on mucous membrane, 176; on structure of the kidney, 839—841; on fatty liver, 929
 Brain, see Encephalon, Cerebrum, Cerebellum, &c.
 Brewster, Sir D., his law of visible direction, 543
 Bright's disease of the Kidney, 707 *d*
 Brodie, Sir B., his experiments on the Par Vagum, 414, *a*; on animal heat, 890
 Bronchial tubes, contractility of, 410, 759
 Brunner's glands, 875
 Buchanan, Dr., his researches on the blood referred to, 697 *e*
 Budd, Dr. W., his cases of reflex action referred to, 365—369; his observations on symmetrical diseases referred to, 785, 882
 Buffy coat, 704, 705
 Bulbus arteriosus, 940, 943
 Bushmen, 70

The Numbers refer to the Paragraphs.

C.

- CACOPLASTIC deposits, 807
 Callus, formation of, 206
 Cancer, 809, 881
 Capacity of respiration, 764
Capillary vessels, distribution and size of, 219, 220; origin of, 221, 222; properties of their walls, 739; absent in some tissues, 220; independent movement of blood in, 733; proofs of, 734—739
 Capillary circulation, 733—742; phenomena of, 734; continues after cessation of heart's action, 735; in acardiac fœtus, 736; stagnation of, in Asphyxia, &c., 738; influence of local excitement on, 737; laws regulating, 739—741; connection of, with nervous influence, 742
 Carbonic acid, excretion of, 749; sources of, 750—754; amount of, 765—767; made subservient to introduction of oxygen, 766; effected through the skin, 768; contained in venous blood, 770; expiration of, in hydrogen, 769; influence of on colour of blood, 771, 772; effects of its retention in the system, 778—780
 ———, absorption of, by lungs, 776
 Carnivorous animals, nutrition of, 644
 Cartilage, structure of, 187—191; composition of, 177, a; nutrition of, 188, 191; ulceration and reparation of, 191; ossification of, 198—200
 Catamenia, 908, 909
 Caucasian race, 93
Cells, the types of Organization, 259; compose bulk of fabric of Vegetables, 106—109; origin of, 122—124; transformations of, 120, 121
 Origin of animal structures in, 110; individual growth of, in animals, 126, 127; history of development of, 128—131; transformations of, 132, 133, 223; individual life of, 126, 811; continual death of, in living body, 108, 261, 811; varying duration of, 811, 812
 Functions of, general, 110, 126, 132, 259; in Absorption, 181, 182, 271, 672; in Assimilation, 153, 154, 271; in Secretion, 174, 179, 278, 821—823; in Reproduction, 174, 281, 902
 Persistence of, in animal tissues, 180; in pigment, 163, 164; in fat, 184; in shell, 192; in epidermis and epithelium, 160—174; in cartilage, 187; in muscle, 230; in nerve, 245
 Replacement of by Fibres, 134, 136
 Cellular Plants, 106
 Cellular tissue, see Areolar tissue
 Cellulose, Vegetable, 4, 111
 Cementum of teeth, structure of, 208, 211; composition of, 212; development of, 216
 Centipede, nervous system and actions of, 326—329
Cerebellum, 340, 457—470; of Fishes, 357; of Reptiles, 360; of Birds, 361; of Mammalia, 362; of Human embryo, 358, 359, 361; relative dimensions of, 457, 458, 461; experiments on, 459, 460, 463; observations on size of, in castrated animals, 468, 469; connection of, with motor power, 459—465; with sexual instinct, 466—470; pathological changes in, 464, 465, 467; phrenological account of, 470
Cerebro-spinal fluid, 476, 477
Cerebrum, 340, 471—495; general structure of, 472—474; of Fishes, 357; of Reptiles, 360; of Birds, 361; of Mammalia, 362; of Human embryo, 358, 359, 361; general functions of, 478—480; relative dimensions of, 481—484; experiments on, 485; pathological changes in, 486; connection of, with intelligence, 485—495; with the will, 487, 494; distinct functions of several parts of, *Appendix I.*; peculiar conditions of, in sleep, somnambulism, &c., 499, 500, *Appendix II.*
 Ceruminous glands, 872
 Chætonodon rostratus, 490
 Change, involved in idea of life, 254
 Cheselden's case of cataract, 541
 Chimpanzee, 51—59
 Chlorosis, 707 c
 Chondrine, composition and properties of, 141, 187 a
 Chorda dorsalis, 180, 937
 Chordæ vocales, 603, 605, 607
 Chorea, 504 note
 Chorion, production of, 918; subsequent changes in, 918, 920—923
 Chossat, his experiments on inanition, 652, 895, 896
Chyle, 674; formation of, in intestines, 660; absorption of, 181, 672; analysis of, 691; aspect of, 692; changes of, in progress through lacteals, 692, 693; globules contained in, their nature and source, 155, 693; their destination, 154—159, 693; chyle from thoracic duct, 693, 695; relative constitution of, 691
 Chyme, formed by digestive process, 657—660
 Chymification, 663—669; a chemical action, 667
 Cicatricula, 936
 Cilia, 171—173
 Cineritious matter, 246
 CIRCULATION
 General account of, 272; objects of, 709; course of, in Man, 710; arterial trunks, 710; capillaries, 219, 710; veins, 710
 In Plants, 712—714; in lower Animals, 715, 716
 Action of *Heart*, 719—727; connection of, with nervous system, 416, 576, 580, 717; rhythmical movements of, 717—719; sounds of, 720, 721; course of blood in, 722; differences of two sides, 723; quantity of blood impelled by, 724, 725; force of contractions, 726; number of contractions, 727
 Action of *Arteries*, 728—732; their elasticity and contractility, 728; influence of their elasticity, 729; proofs of their contractility, 730; their tonicity, 731; influence of their contractility, 732
 Independent motion in capillaries, 733—742; proofs of, 734—735; stagnation in, 738, 740; influence of capillaries in regulating amount of flow, 740; contractility of capillaries, 739; general principles of their action, 751; influence of nerves on capillary circulation, 742

The Numbers refer to the Paragraphs.

- Motion of Blood in Veins, 743—745; structure and properties of veins, 743; causes of flow of blood through, 744; influence of gravity upon, 745
- Peculiarities of circulation, in lungs, 746; in portal system, 685, 746; in cranium, 476, 747; in erectile tissue, 748; in fœtus, early state of, 938—940; subsequent condition of, 943—944
- Disorders of circulation, 881
- Civilization, influence of, on development of human body, 87—90
- Clot, of Blood, see Crassamentum
- , organization of, 118, 119, 700, 796
- Coagulable lymph, see Liquor Sanguinis
- Coagulation, of blood, 699—705; due to fibrine alone, 117, 118, 699; an act of vitality, 118, 700, 701; circumstances influencing, 701, 702; proportion of serum and clot, 703; of chyle, 117, 693; of lymph, 694; of fibrine, 117—119
- Coahupe, Mr., his experiments on respiration, 776; on products of combustion of charcoal, 776 *note*
- Coccochloris, 125
- Cochlea, 566
- Cockchafer, 19
- Cœcilia, 31
- Coition, act of, in Male, 904; in Female, 911
- Cold, degree of, endurable by Man, 987; death by, 814, 895, 896; means of producing, in the living body, 897; influence of, on young animals, 893, 894
- Collard de Martigny, his experiments on respiration, 769, 774
- Colostrum, 854 *a*, 856
- Colour of Skin, 79—81 (see Pigment-cells)
- Colourless corpuscles in blood, 151—158
- Colours, impressions made by, 552; complementary, 552; deficiency of power of distinguishing, 553
- Combe, Dr. A., quoted from, 658 *a*, 666, 671
- Commissures of Brain, 474; deficiency of, 474 *a*
- Complementary colours, 552
- Conception, aptitude for, 909; act of, 911, 927
- Conchifera, nervous system in, 317, 318
- Concussion of brain, effects of, 580, 625
- Consciousness, double, 500
- Consensual movements, 335; of Articulata, 336; of Vertebrata, 337, 430—436; of Eye-balls, 450—456
- Consonants, 616
- Contractility of Muscle, 573; two forms of, 574; of arteries, 730, 731; of Capillaries, 739; of bronchial tubes, 410, 759 (see Irritability)
- Contraction of Muscle, mode of, 230, 575, 576; causes of, 575, 576; alternating with relaxation, 575, 577; after death, 578, 595—597; dependent on arterial blood, 583, 584; power of, the same at different degrees of extension, 592; energy of, in Man, 598; in Insects, 599; rapidity of, 600
- Convulsions of Brain, 472
- Convulsive diseases, 502—504
- Cooling power of cutaneous exhalation, 897
- Cooper, Sir A., his experiments on circulation through cranium, 290; his researches on mammary gland and its secretion, 853
- Coral, 6
- Corallines, 4
- Cornaro, his diet, 653
- Cornea, structure and nutrition of, 189
- Corpora Albida, 914
- Cephaloidea, 914
- Lutea, 912—914
- Malpighiana, of Spleen, 683; of Kidney, 539 *b*
- Olivaria, 352, 353
- Pyramidalia, 352, 353
- Quadrigemina, 422, 436
- Restiformia, 352, 353
- Rubra, 914
- Striata, 423, 424
- Wolfiana, 26, 839 *c*
- Corpus Callosum, 474
- Corpuscles, Red, of Blood, 143—150; structure of, 143, 144; form of, 145, 146; size of, in Mammalia, 146 *a*; in Birds, 146 *b*; in Reptiles, 146 *c*; in Fishes, 146 *d*; chemical constitution of, 147; origin of, 148; production of in embryo, 149; large in fœtus, 149; uses of, in animal economy, 150, 698; proportion of in Blood, 697; increase of, in plethora, 707 *c*; diminution of, in chlorosis, 707 *c*
- , Colourless, of Blood, 151—159; characters of, 151; movement of, 152; uses of, 153—159
- of Chyle, 155
- of Lymph, 155
- of Spleen, 684 *b*
- of Supra-Renal Capsules, 686
- Cortical Substance, of Brain, 472
- , of Kidney, 839 *a*
- Convulsive diseases, 501—504
- Cotyledons of Ruminants, 921
- Coughing, act of, 381
- Cranium, circulation in, 476, 747; forms of in different races of Men, 81—87
- Crassamentum of Blood, 696
- Crowing inspiration of infants, 504
- Crusta petrosa of teeth, 208, 211, 212, 216
- Cruevilhier, M., his observations on heart, 718—722; on purulent deposits, 837 *a*
- Crying, act of, 380
- Cryptogamia, reproduction in, 899
- Crystalline lens, 190
- Currie, Dr., case of dysphagia related by, 677
- Cutaneous follicles, perspiratory, 868—870; sebaceous, 872
- Cuttle-fish, nerves of arms in, 322, 323; ejection of ink by, 438
- Cutis anserina, 234
- Cyclostome Fishes, 22
- Cylinder-epithelium, 170
- D.
- DARTOS, contractility of, 234
- Davy, Dr. J., his researches on animal heat, 886
- Death, somatic and molecular, 813—816, 880; death of individual cells, 811, 812; by asphyxia, 814; by cold, 814, 895; by syncope, 814; by necræmia, 814; by retention of secretions, 278, 832, 842

The Numbers refer to the Paragraphs.

- Decay, constant in Animal body, 268, 632, 633, 750 (see Disintegration)
- Decidua, formation of, 919
- Decomposition, continual, in living beings, 268, 632, 633 (see Disintegration)
- Decussation, of optic nerves, 445
- Defecation, movements concerned in, 391, 392
- Degeneration, of nervous structure, 263, 292—296; of muscular fibre, 239, 263, 586; of elements of blood into pus, 800, 805; into tubercle, 807, 808
- Deglutition, 382—386; a reflex action, 382, 383; nerves concerned in, 384, 385; actions preceding, 386 *a-c*; in Polyypes, 382
- Delaroche and Berger, their experiments on Animal Heat, 888
- Dental groove, 217
- Dentine, 208; structure of, 210; composition of, 212; development of, 213, 214
- Dermo-skeleton, 20
- Despretz, M., his researches on animal heat, 892
- Devergie, M., his table of development of fœtus at different ages, 947
- Diabetes, 879
- Diaphragm, movements of, 761
- Diathesis, gouty, 878, 884; saccharine, 879; tubercular, 878
- Diet-scale, see Food
- DIGESTION,**
 General account of, 270; in lower Animals, 655; alimentary materials, 641; their respective destinations, 642—647; inorganic substances, 648; relative digestibility of different kinds of food, 666; importance of bulk, 666
 Processes of, 656—662; mastication and insalivation, 656; deglutition, 656; condition of stomach in, during health, 657; disorder of, 658; entrance of food into stomach, 659; movements of stomach, 659; expulsion into duodenum, 660; passage along intestines, 661; discharge of fœces, 662
 Chemical phenomena of, 663—671; composition and properties of gastric juice, 664; its chemical action, 665, 667; artificial solution of food, 668; Wasmann's researches on pepsin, 668; Bernard and Barreswill's researches, 669; conversion of saccharine and oleaginous principles, 670, 671
 Influence of nerves upon, 387, 413—415
 Interstitial, according to Dr. Prout, 681
 Digestive cavity in lower animals, 655; origin and formation of, 937, 945
 Direction, law of visible, 543
 Discs, of Blood, see Corpuscles
 Disintegration of Muscular tissue, 239, 263, 586; of Nervous tissue, 263, 292—296
 Distance, adaptation of eye to, 536; estimate of, 548
 Diving animals, 778
 Dobson, Mr., his experiments on the Spleen, 685
 Domesticability of Animals, 39, 42
 Donné, M., his observations on Milk, 854 *a*, 856; on temperature in disease, 886
 Doris, gills of, 755
 Dormant Vitality, 255
 Dorsal vessel of Articulata, 18
- Double consciousness, 500
 Draper, Professor, on Capillary Circulation 713, 741
 Dreaming, 499
 Dugong, heart of, 710
 Dulong, M., his researches on animal heat, 892
 Dumas, his analysis of fibrine, 114
 Duration of life in individual parts, 810—812
 Dytiscus, experiments on, 328
 Dzondi, on deglutition, 656
- E.
- EAR, general action of, 556; comparative structure of, 557, 558; distribution of auditory nerve in, 559; uses of membrana tympani, 563; of tympanic cavity, 564; of labyrinth, 565, 566; of external ear and meatus, 567, 568
 Echinodermata, 7—10; shell of, 192
 Educability, of Birds, 39, 479; of Mammalia, 42, 480; of Man, 60
 Edwards, Dr., his experiments on respiration, 769; on animal heat, 888, 893, 894
 Efferent nerves, 289, 344
 Egg, see Ovum
 Egg-shell, Membrane of, 118
 Ehrenberg, on limits of vision, 540
 Eighth Pair of Nerves, see Glosso-pharyngeal, Par Vagus, and Spinal Accessory
 Ejaculatio seminis, 372, 393, 904
 Elaboration of fibrine, 116, 154—159
 Elasticity of arterial walls, 728, 729
 Elastic tissues, 138, 139
 Electricity, not identical with nervous power, 297
 Embryo, early development of, 915—917, 934—945; formation of germinal mass, 935; of germinal membrane, 935, 936; of vertebral column, 937; of amnion, 938; of vascular area and umbilical vessels, 938, 939; of heart and branchial arches, 940; of allantois, 941; of umbilical cord, 941, 942; later circulation in, 943, 944; influence of mother on, 946; table of development, 947; size and weight of at birth, 948; proportion of males and females, 949; relative viability of, 950
 Embryonic cell, 935, 936
 Embryonic development, of brain, 358, 359, 361; of cephalic nerves, 420, 421; of lungs, 757 *b, c*; of blood-corpuscles, 149; of liver, 826 *g*; of kidney, 839 *e*; of heart, 940; of circulating apparatus, 940, 943, 944; of digestive cavity, 945
 Emissio seminis, 372, 393
 Emotions, influence of on Intelligence and Will, 440; on nutrition and secretion, 625—628
 Emotional actions, 437—440
 Enamel, 208; structure of, 209; composition of, 212; development of, 215
 Endosmose, 271, 675
Encephalon, 356; comparative anatomy of, 357—362; weight of, in proportion to entire body, 475; proportions of different parts, in Fishes, 357—359; in Reptiles, 360; in Birds, 361; in Mammalia, 362; in Human

The Numbers refer to the Paragraphs.

- embryo, 358, 359, 361; supply of blood to, 476, 477
- Epidermic tissues, 160—174; epidermis, 161, 162; hair, 166—168; nails, 162, 165; epithelium, 169—174; nutrition of, 135, 161, 174; functions of, 162, 174
- Epilepsy, 503
- Epithelium, 169—174; the real secreting structure, 174; cylindrical, 170; tessellated, 170; ciliated, 171—173
- Erect vision, 543
- Erectile tissue, 748
- Ethiopian nations, 97—99
- Eustachian tube, uses of, 564
- Eustachian valve, uses of, 944
- Evans, Dr. Julian on the structure of the Spleen, 683, 684
- EXCRETION,
Objects of, 275; of carbon, 275, 833; of nitrogen, 276, 842; result of decomposition, 275, 819; elements of, previously in blood, 820, 832, 842
- Excretions, outlets of, guarded by spinal cord, 391
- Exhalation, in Plants, 107; by lungs, 773, 774; influenced by mental state, 774; from skin, 870, 871
- Experiments on nerves, fallacies of, 302—306
- Expiration, act of, 761
- External Ear, uses of, 567
- Exudation corpuscles, 800, 805
- Eye, general action of, 536; an optical instrument, 536; adaptation of, to distance, 536, 537; defects of, 538; optical powers of, 540; consensual movements of, 450—456
- F.
- FACIAL nerve, 406
- Fæces, composition of, 662
- Fallopian tubes, passage of Spermatozoa through, 911; passage of ova along, 911, 918; contractions of, produced by nervous agency, 393
- Falsetto notes, how produced, 609
- Faraday, Mr., optical illusion discovered by, 551
- Farre, Dr. A., discovery of Spermatozoa in Ovum, 900
- Fat-cells, 184; contents of, 185; uses of, 186; formation of, 186
- Fatty livers, 829
- Feathers, 166
- Fecundation in Plants, 899; in Animals, 900
- Fever, state of blood in, 707 *b*
- Penetra ovalis, 557, 558
——— rotunda, 558
- Fenwick, Mr., his experiments on absorption, 673
- Ferments, action of, in digestion, 669; in blood, 708, 877
- Ferneley, Mr., on areas of arteries, 710 *a*
- Fibres, origin of, 118, 119, 136; white, 138, 140; yellow, 138, 142; mixture of in areolar tissue, 138; in serous and synovial membranes, 175; in mucous membrane and skin, 176, 177
——— of Muscle and Nerve, see Muscular Fibre, and Nervous tissue
- Fibrillæ, ultimate of Muscle, cellular nature of, 230
- Fibrine, composition of, 114; properties of, 114, 115; coagulation of, 117—119; elaboration of, 117, 158, 159; in chyle, 693; in blood, 696—705; increase of, in inflammation, 158, 707 *a*, 802; diminution of, in fever and hemorrhagic diseases, 707 *b*; imperfect elaboration of, in strumous diathesis, 807, 878; formed at expense of albumen, 114—117; effusion of, 803; organization of, 119, 700, 795, 796
- Fibro-cartilage, 187
- Fibrous tissues, simple, 138—142; origin of, 118, 119, 136
- Fifth Pair of nerves, 403, 404; lingual branch of, 404, 407; development of, 421; influence of, on organic processes, 625
- Fishes, 26, 27; skeleton of, 26; respiration of, 27, 755; air-bladder of, 27, 755; kidneys of, 838, 839 *c*; encephalon of, 357, 358; circulation in, 27, 716; blood-corpuscles of, 146, *d*
- Flourens, M., his experiments on the nervous system, 432, 435, 436, 459
- Fluids, absorption of, by intestinal surface, 674, 675; by general surface, 676, 677; by veins, 675, 676; by lacteals, 674, 675; by lymphatics, 679
- Fly-catcher, incubation of, 41
- Fœtus, table of development of, 947; circulation in, 940, 943, 944; brain of, compared with that of lower animals, 358, 359, 361; see Embryo
- Follicles of Lieberkühn, 874
- Food, causes of demand for, 629—635; different kinds of, 640, 648; relative amount of azote in each, 647; destination of, 641—646; desire for, 636—639; relative digestibility of different kinds of, 666; mechanical reduction of, 656; action of stomach upon, 657—659; passage of, into intestine, 660; passage of, through intestinal canal, 661; ejection of insoluble portion of, 662; mode of solution of, 663—671; smallest quantity of, on which life can be supported, 653; greatest quantity that can be devoured, 654; supply of, required by Man, 650, 651; sufficiency of, indicated by satiety, 649; allowance of, in Navy, 650; in Milbank Penitentiary, 651; in Edinburgh House of Refuge, 651; in Convict-ship, 651; effects of insufficient supply of, 651, 652
- Form, mode of acquiring knowledge of, by touch, 523; by sight, 541, 542, 546, 547
- Fourth pair of nerves, 405
- Fourth ventricle, 346, 355
- Foville, Dr., his observations on brain, 486
- Freckles, 164
- Fremy, M., his analysis of Nervous matter, 249
- Frog, metamorphoses of, 31; excitable state of spinal cord in, 401 *a*
- Functions, 260; division of, into organic and animal, 261, 262; connection of, 263—267; of Animal life, 283—288; of Organic life, 268—282
- Fungous growths, 809

The Numbers refer to the Paragraphs.

G.

- GALL, Dr., his statements respecting the Cerebellum, 468
 Gall-bladder, 825 *e, f*
 Ganglia, structure of, 252, 245—247
 ——— of Special sense in Vertebrata, 422—425
 ——— of Sympathetic, 314, 342
 Gangrene, 804
 Gases, contained in blood, 770; absorption of, by lungs, 775—777
 Gasteropoda, Nervous System of, 319—321
 Gastric fluid, composition and properties of, 664; action of, 665; secretion of, proportional to wants of the system, 657; not dependent on nervous influence, 414, 415; but affected by it, 626, 637
 Gelatine, composition of, 141
 ———, of cartilage, 187 *a*; of bone, 196
 Gelatinous principles of food, 640; application of, in the animal body, 642
 Gerber, Prof., referred to, 693 *a*
 Germinal mass, 935
 ——— membranc, 935; serous layer, 936; mucous and vascular layers, 936
 ——— spot, 905, 915
 ——— vesicle, 905, 906, 915—917
 Gestation, signs of, 926; ordinary duration of, 928—930; protracted, 931; shortest period of, 932
 Gills, respiration by, 755
 Glands, general structure of, 821—823
 ———, lymphatic, 682
 ———, vascular, 683—690
 Globules, see Corpuscles
 Globuline, composition of, 147
 Glosso-pharyngeal nerve, functions of, 384, 407; development of, 420, 421
 Glycerine, composition and properties of, 185 *a*
 Glyceoll, 141 *c*
 Goodsir, Mr., his observations on primary membrane, 135; on the Teeth, 217; on Bone, 194; on ulceration of Cartilage, 191; on Absorption, 181, 672; on Vascular Glands, 683; on Secretion, 822, 823; on Milk-cells, 853 *b*; on formation of Decidua, 919; on structure of Placenta, 921—923
 Gouty diathesis, 878, 884
 Graafian follicle, 905, 912—914
 Grainger, Mr., referred to, 345, 367
 Granulation, process of, 799—801
 Gravity, influence of on Circulation, 745
 Greenhow, Dr., his plan of treating burns, 798
 Grey matter of Nervous system, 245, 246; of Brain, 472
 Gryllotalpa, nervous system of, 332
 Gulliver, Mr., his observations on blood-corpuscles referred to, 146, 149, 151, 156, 158; on reparation of bone, 206; on chyle, 692
 Guy, Dr., his researches on the Pulse, 727

H.

- HABITUAL movements, 438
 Hæmatine, 147
 Hæmatococcus, 125
 Hair, characters of, in different human races,

- 82; structure, growth, and composition of, 166—168
 Hales, Dr., his experiments on the circulation, 726
 Hall, Dr. M., his discoveries on the Nervous system, 307, 345, 363, 365, 374, 375, 383, 386, 392, 394, 398, 400, 505; his views on muscular irritability, 585, 589 *b*
 Haller, his doctrine of muscular irritability, 591
 Hastings, Dr., his experiments on capillary circulation, 717 *a*; on animal heat, 890
 Haversian canals, 193; formation of, 197, 199, 201
 Hearing, sense of, 556—572; physical conditions of, 557, 560—562; use of tympanum, 563; tympanic cavity and Eustachian tube, 564; chain of bones, 565; labyrinth, 566; external ear, 567; auditory nerve, 559; tones produced by succession of sounds, 569; estimate of degree, direction, and distance of sounds, 570; rapidity of perception by, compared with sight, 571; uses of, in regulating voice, 572, 611
 Heart, 717; muscular fibre of, 234; inherent contractility of, 717; rhythmical movements of, 717—719; influence of nerves on, 416, 576, 717 *a-c*; sounds of, 720, 721; course of blood through, 722; differences of structure in two sides of, 723; difference of valves, 723 *c*; quantity of blood propelled by, 724, 725; force of contraction of, 726; number of contractions of, 727; various causes influencing, 727 *a-e*; origin of, 940; subsequent development of, 943
 Heat, Animal, amount of, developed by Man, 885, 886; in disease, 886; dependence of on formation of carbonic acid, 889—892; development of, in Plants, 889 *a, b*; in lower animals, 889, *c*; effect of exercise on, 890; partly maintained by artificial respiration, 896; dependent in part on cutaneous respiration, 891; chemical theory of, 892; heat of young animals, 893; variations in power of generating, at different seasons, 894; loss of, during inanition, 895, 896; provisions against excess, 897
 Heat, external, influence of, on incubation of Birds, 41; influence of, on vital actions in general, 885; extremes of, endurable by Man, 887, 888; power of resisting, 887, 888, 897
 Heat, sexual, 909
 Helmholtz, his observations on composition of muscle, 238 *b*, 586
 Hemioptia, 545 *note*
 Hepatic artery, 826 *d*
 ——— cells, 183, 826 *f*
 ——— duct, 826 *c*
 ——— vein, 826 *a, e*
 Herbivorous animals, nutrition of, 645
 Hering, experiments of, on circulation, 724
 Heterologous growths, 809, 881
 Hiccup, act of, 380.
 Hippuric acid, 845 *a*
 Holland, Dr., referred to, 521
 Horny matter, composition of, 162
 Horses, cerebella of, 468.
 Hottentots, 100
 Houston, Dr., on acardiac fœtus, 736

The Numbers refer to the Paragraphs.

Hunger, sense of, 412, 636—638
 Hunter, John, on muscular tonicity, 593, 594; on functions of lymphatics, 681 *a*, *c*; on contractility of arteries, 731; on union by adhesion, 794
 Hutchison, Mr., on capacity of respiration, 764
 Hydra, 9; movements of, 313; reproduction of parts in, 9, 792
 Hydrophobia, 502
 Hymenoptera, nerves of wings of, 298; instincts of, 336, 429
 Hypertrophy, 787, 788
 Hypoglossal nerve, functions of, 418, 419; development of, 420, 421
 Hysteria, 503; remarkable abstinence in, 653

I.

IDEAS, formation of, 488.
 Idiots, actions of, 428, 474, 478, 484
 Improbability of Man, 60
 Inanition, Chossat's experiments on, 895, 896
 Incontinence of urine, 401, 504
 Indo-European nations, 95
 Indian nations, 95
 Infants, inferior calorifying power of, 893, 932 *a*
 Inflammation, increase of fibrine of blood in, 707 *a*, 802; diminished vitality of the tissues in, 803; results of, 804—806; generally unfavourable to repairation, 793, 799—801; prevention of, after injuries, 798; how far concerned in deposition of tubercle, 808
 Ingestion of food, actions concerned in, 382, 656
 Insalivation, 656
 Insects, Muscular apparatus of, 19; strength of, 599; instincts of, 17, 429, 479; heat developed by, 889 *c*; nervous system of, 325—336; reflex actions of, 328, 329; consensual actions of, 336; circulation in, 715; respiration in, 755
 Inspiration, act of, 761
 Instinctive actions, characters of, 428
 Instincts, of Articulata, 17, 336, 429, 479; of Birds, 479; of Mammalia, 42, 480; of Man, 428, 437—440, 484; of Cuttlefish, 438; of Infants and Idiots, 428, 484
 Intelligence, of Vertebrata, 23, 482; of Birds, 479; of Mammalia, 480; of Man, 484; general absence of, in Invertebrata, 429; seat of, in the Cerebrum, 478
 Intercellular passages, 218
 Intervertebral nerves, 421
 Intestines, peristaltic movements of, 388, 389; passage of food through, 660, 661; glandulæ of, 661, 874—876; secretions of, 661, 877
 Intuitive perceptions, 490
 Invertebrata, general absence of red corpuscles in, 150; character of blood of, 155
 Iron, contained in food, 648; in blood-discs, 147; administration of, in chlorosis, 707 *c*
 Irritability, of muscular fibre, see Muscle
 Iulus, nervous system and actions of, 326, 329

J.

JENNINGS, Mr., on artificial insuflation of lungs, 760 *a*

Jewish nation, 80, 94
 Jones, Dr. Bence, his observations on phosphatic deposits, 295 *note*
 Jones, Mr. Wharton, his observations on blood-corpuscles, 152, 159 *a*; on effects of inflammation, 704; on capillary circulation, 780

K.

KELLIE, Dr., his experiments on circulation in cranium, 747
 Kidneys, general function of, 276, 819; structure of, 838, 839; cortical and medullary substances, 839 *a*; tubuli uriniferi, 839 *a*; Malpighian bodies in, 839 *b*; circulation in, 840; embryological development of, 839 *c*; see Urine.
 Kiernan, Mr., on the liver, 826, 827
 Kiesteine, in urine of pregnant women, 859, 926
 Knight, Mr., observation on incubation of Fly-catcher, 41
 Kronenberg, Dr., on roots of spinal nerves, 304, 344

L.

LACHRYMAL gland, 865
 ———— secretion, 865; influence of nervous system on, 625, 626
 Lacteals, origin and distribution of, 672; functions of, 674, 675
 Lactic acid, present in stomach during digestion, 664 *b*; not a constituent of urine, 846
 Lacunæ of bone, 193, 194
 Lamina spiralis, 559
 Lamprey, 22
 Lane, Mr., his investigations on chyle, 693 *a*
 Language, indication of affinity of races, 95 *a*
 Laryngeal nerves, 378
 Larynx, structure of, 602—604; action of, 604—611; muscles of, 604, 605
 Laughing, act of, 380
 Lecanu, M., his analysis of blood, 697 *a*; his observations on urine, 844
 Lehmann, his experiments on composition of urine, 844, 849, 850
 Letellier, M., his researches on respiration, 767 *a*
 Leuret, M., his observations on Cerebellum, 468, 469
 Liebig, Prof., on digestive process, 669; on red corpuscles of blood, 150 *a*; on composition of urine, 845—848; on uric acid, 845
 Life, idea of, involves change, 254, 255; duration of, in individual parts, 259, 810—812
 Ligaments, structure of, 140; vocal, 140
 Ligamentum nuchæ, 140
 Light, laws of refraction of, 533—535; rapidity of perception of, compared with sound, 571; influence of, on metamorphosis, 32; effect of, on pupil, 395, 443; influence of, on pigment-cells, 164
 Lime, an element of animal structures, 648
 Lingual branch of fifth pair, 407
 Lintott, Mr., his observations on the teeth, 217 *c*
 Liqueur sanguinis, 696; organization of, 117—119, 795, 796

The Numbers refer to the Paragraphs.

- Liver*, general function of, 275, 819; universally present in Animal Kingdom, 825; size and form of, in Vertebrata, 825 *c, d*; general structure of, 826; component cells of, 183, 826 *f*; distribution of portal vessels, 826 *b*; of hepatic artery, 826 *d*; of hepatic vein, 826 *a, e*; of hepatic ducts, 826 *c*; congestion of, 827; cirrhosis of, 828; embryonic development of, 826 *g*; proportional size of, before and after birth, 826 *g*, 830; secretion of bile by, 831—836, see Bile; other depurating actions of, 837
- Lizards, 29
- Locomotive actions, 397
- Looped terminations of Nerves, 240, 248
- Lungs*, structure of, in lower Vertebrata, 756; in Man, 737; development of, 757 *a-c*; action of, in respiration, 760; capacity of, 764; chemical changes in, 765—767; exhalation by, 773, 774; absorption by, 775, 776
- Lymph, composition of, 691; elaboration of, 682; globules in, 155, 694; purposes of, 154—159
- Lymph, coagulable, see Liquor Sanguinis
- Lymphatic glands, structure of, 682
- Lymphatics, distribution of, through the body, 676; function of, 679, 680; specially concerned in nutritive absorption, 680, 681
- M.
- MACARTNEY, Dr., his views on the reparative processes, 793—801
- Macleod, Dr., on first production of blood-corpuscles, 149 *a*
- Madden, Dr., his experiments upon absorption, 677, 775
- Madder, effect of, on bones, 202; on teeth, 210
- Magnetism, Animal, *Appendix II.*
- Magnus, his experiments on the blood, 770
- Malayo-Polynesian race, 103
- Malignant growths, 809, 881
- Mammalia*, 42—50; sub-classes of, 44; skeleton of, 46; respiration and heat of, 47, 757; subdivisions of, 48; brain of, 362; intelligence of, 42, 485; blood-corpuscles of, 146 *a*
- Mammary gland*, 853; structure of glandulæ, 853, *a, b*; development of, 853, *c*; structure of in male, 853 *d*; secretion of, 854—861; see Milk
- Man*, characteristics of, 51—61; erect attitude of, 51—57; hand of, 57; other distinctive characters of, 58; sensibility and locomotive power of, 59; intelligence of, 60; soul of, 61; psychical operations in, 283—286; subdivision of into races, 62, 63, 78—105; common origin of, 91; extremes of variation amongst races of, 72; proper food of, 646
- Mantis, nervous system of, 328
- Margarine, composition and properties of, 185 *a*
- Mastication, 656
- Matteucci, his experiments on Electricity, 297
- Mayer, Prof., his experiments on the Spleen, 685
- Median nations, 95
- Medulla Oblongata*, 350; structure and connections of, 351—355; ganglionic character of, 355; general functions of, 370, 374, 384; centre of respiratory movements, 374; centre of acts of deglutition, 384, 385
- Medullary matter of nervous system, structure of, 243, 246; functions of, 248
- Melolontha vulgaris*, 19
- Membrana granulosa, 906, 912
- Membrana tympani, uses of, 563
- Membrane, basement or primary, 135; fibrous, 140; mucous, 176—179; serous and synovial, 175
- Membrane, development of bone in, 197
- Memory, 491
- Menstruation, 908, 909
- Metamorphosis of Batrachia, &c., 32, 630 *a*
- Milk*, peculiarity of as alimentary substance, 642, 647; general composition of, 854, 857; microscopic characters of, 854 *a*; constituents of, 854 *b*; proportion of constituents in human milk, 855; in milk of different animals, 858; quantity of, 860; change in character of, during nursing, 856; consequences of retention of, 859; transference of secretion, 859 *a*; foreign substances entering, 861; influence of emotions on, 627; secretion of, in male, 853 *c*
- Milky aspect of Chyle, 692
- serum, 697 *e*
- Milbank Penitentiary, 651
- Mind, elementary operations of, 487—495; influence of, on nutrition and secretion, 625—628
- Mineral ingredients of Food, 648
- Mitchell, James, case of, 532
- Modelling process, 797, 798
- Molecular base of Chyle, 692
- Molecular death, 813, 815, 816
- Mollusca*, 5, 11—15; deficiency of symmetry in, 11—13; organs of locomotion in, 13; organs of nutrition in, 14; blood and respiration of, 15; shells of, 192; nervous system in, 315—322; circulation in, 715; respiration in, 755
- Mongolian nations, 96
- Montgomery, Dr., on Corpus luteum, 913, 914; on placental bruit, 925
- Mother, influence of, on fœtus, 946
- Motions of Plants, 1, 230
- Motor influence, laws of propagation of, 299
- Motor linguæ, 418, 419
- oculi, 405
- nerves, determination of, 300—303
- tract of Sir C. Bell, 351
- Mucous layer of germinal membrane, 936
- Mucous Membrane, 176—179; of stomach, appearance of, in health, 657; in disease, 658; intestinal, structure of, 661; glandulæ of, in stomach, 873; in intestines, 874—877
- Mucus, properties of, 179
- Mulder, his analysis of albumen and fibrine, 114; of proteine and its oxides, 116; of gelatine, 141 *a*
- Müller, Prof., his researches on vision referred to, 519, 537, 543, 552; on hearing, 561, 562, 564; on blood, 699; on voice, 606—610; on respiration, 769; on cancer, 809
- Muscular Fibre*, 223—240; chemical composition of, 238
- Structure of, 224, 225; in muscles of Animal life, 225—233; arrangement of, in fasci-

The Numbers refer to the Paragraphs.

- culi, 226; composed of fibrillæ, 226; enveloped in sheath, 227; form and comparative dimensions of, 228, 229; structure of ultimate fibrillæ, 230; state of, in contraction, 231, 233; origin of, 235, 236; reparation of, 237; supply of blood-vessels to, 239; supply of nerves to, 240; structure of, in Muscles of Organic life, 234; development of, 235, 236; disintegration of, from use, 239, 263, 586
- Contractility of, 573, 574; irritability of, 575; contraction alternating with relaxation, 576, 577; persistence of after death, 578; depressed by sedatives, 579; by violent nervous impressions, 580, 581; increased by stimuli, 582; dependent on arterIALIZED blood, 583—585; increased by habitual employment of particular muscles, 587; diminished by want of action, 588; influence of nerves on, 589—591; loss of, from section of nerves, 589 *b, c*; restored after exhaustion, 589 *d*; an independent endowment, 591; difference of, on two sides of heart, 585; the same at different degrees of contraction, 592; power generated by, in Man, 598; in Insects, 599
- Tonicity of, 593—597; effect of heat and cold upon, 593, 594
- Contraction of, after death, 595—597
- Muscular Contraction, influence of, on Circulation, 744 *c*
- Muscular Sense, 433, 434
- Tension, maintained through Spinal Cord, 398, 399
- Musk-deer, blood-corpuscles of, 146 *a*, 151; hair of, 166
- Myolemma, 227, 235
- Myopia, 538
- Myxinoid fishes, 180
- Myriapoda, nervous system of, 326; development of head of, 426 *a*
- N.
- Nails, 162, 165
- Næcræmia, 708
- Negro races, 97—99
- Nerves, origin of, in ganglia, 246, 247; terminations of, in muscles, 239; in skin and sensory organs, 248; mode of determining functions of, 300—306
- Nervous agency, hypothesis on its nature, 297; laws of its transmission, 298, 299; not essential to Nutrition and Secretion, 620, 624; influence of, on organic functions, 625—628
- Nervous circle, 433
- Nervous System, general functions of, 289, 307; elementary structure of, 241—253; fibrous matter of, 242—244; vesicular matter of, 245, 246; arrangement of fibres in ganglia, 246, 247; afferent and efferent fibres of, 289, 344; use of plexuses in, 298; isolated course of single fibres, 298; general purposes of, 307—309; dependence of its activity upon supply of blood, 290, 291; functional activity of, involves disintegration, 292—296; nature of changes in, 297; existence of in lowest Animals, 311, 312; general recapitulation of functions, 496—498; peculiar conditions of, 499—501; pathological states of, 501—505
- Nervous system of Radiata, 313, 314; of Mollusca, 315—323; of Articulata, 324—336; of Vertebrata, 337—362
- Nervous tissue, 241—253; fibrous element of, 242—244; cellular element of, 245, 246; relation of two structures in, 246—248; composition of, 249; nutrition of, 250, 251; first development of, 252; regeneration of, 253; disintegration of, with use, 292—296; decay of, when not employed, 442
- Neuro-skeleton, 20
- Newport, Mr., his observations on the blood-corpuscles of Insects, 156; on their nervous system, 325—330; on their temperature, 889 *c*; on development of head of Myriapoda, 426 *a*
- Nitrogen, proportion of, in different articles of food, 647; exhalation and absorption of, 766; respiration in, 769, 780; amount of, in blood, 770
- Nostoc, 125
- Nucleus, 124; its offices and metamorphosis, in Plants, 124, 125; in Animals, 128—133
- Nucleus-filaments, 138
- NUTRITION,
- General account of, 273, 274, 781; connection of, with nervous system, 279; not dependent upon nervous agency, 624; but influenced by it, 624, 625
- Essential nature of, 782; a continuous process of cell development, 782, 783; selecting power of individual parts, 784, 785
- Varying activity of, 786—791; affected by age, 786; hypertrophy, 787, 788; atrophy, 789—791
- Reparative processes, 792—801; reproduction of parts in lower Animals, 792; union by first intention, 793, 794; organization of liquor sanguinis, 119, 795; organization of blood, 700, 796; modelling process of Dr. Macartney, 797; circumstances favourable to, 798; granulation, 799—801
- Abnormal forms of Nutritive processes, 802—809; inflammation, 802—804; suppuration, 805, 806; tubercular deposit, 807, 808; cancerous growths, 809
- Varying duration of different parts, 810—812; limited term of existence of cells, 811; variation of, with period of life, 812
- Death, or Cessation of Nutrition, 813—816; somatic and molecular, 813; somatic, by Syncope, 814; by Asphyxia, 814; by Cold, 814; Molecular, consequent upon somatic, 815; dependent on local change, 816
- O.
- Oblique muscles of orbit, 451
- Oceanic races, 102
- Octopus, nerves of, 298
- Odoriferous glandulæ, 872
- Odorous matter in blood, 872
- Odours, sensibility to, 531, 532
- Oesophagus, descent of food through, 386, 656
- Oleaginous principles of food, 640, 641; destination of, in Animal body, 643—646, 671

The Numbers refer to the Paragraphs.

- Oleine, composition and properties of, 185 *a*
 Olfactory lobes, in Fishes, 357—359; in Reptiles, 360; in Birds, 361; in Mammalia, 362; in Man, 422
 Olfactive nerves, functions of, 331
 Olivary bodies, 350—354
 Omphalo-Meseraic vessels, 939
 Optic lobes, in Fishes, 357—359; in Reptiles, 360; in Birds, 361; in Mammalia, 362; in Human embryo, 358, 359, 361; in Man, 422; functions of, 436
 Optic Nerve, 442—445; an excitator of motion, 443; decussation of, 445; termination of, in retina, 539
 Optic Thalami, 423, 424
 Orang Outan compared with Man, 50—60
 Orbicularis muscle, reflex action of, 394
 Orbit, motor nerves of, 405; muscles of, 450, 451
 Organic fibres of Nervous System, 244, 247, 341
 Organization, connection of, with vital properties, 781; incipient in liquor sanguinis, 117—119; in coagulable lymph, 117, 795
 Organs of Sense, their mode of operation, see Ear, Eye, &c.
 Ornithorrhyncus, 44; mammary gland of, 821
 Ossification, in membrane, 197, 201; in cartilage, 198—201
 Ostrich, incubation of, 41
 Otter-breed, origination of, 70
 Ovarium, origin of ova in, 905—907; corpus luteum in, 913, 914
 Ovisac, 907, 908
 Ovum, component parts of, 905; origin of, 906, 907; maturation of, 909; arrival of spermatozoa at, 900, 911; discharge of, from ovary, 912; first changes in, 915—918; later changes in, 934—947
 Owen, Mr., on blood-corpuscles of Siren, 145 *note*; on structure of dentine, 210; on formation of dentine, 213, 214; on formation of enamel, 215; on formation of crista petrosa, 216
 Oxygen, introduction of, in respiration, 766; presence of, in arterial blood, 770, 771; influence of, on colour of blood, 771, 772; effect of respiration of, 777
- P.
- PAGE, Mr. J., on areas of arteries, 710 *b*; on concentric hypertrophy of heart, 597; on absence of corpus callosum, 474 *a*; on action of heart, 717
 Pancreas, structure of, 862; secretion of, 669, 670, 863
 Papilla, of skin, 522; of tongue, 527
 Papuans, 104
 Paralysis agitans, 381 *note*
 Paraplegia, cases of, showing reflex action, 366—369
 Parturition, 393, 928, 929
 Par Vagum, 408; the excitator of respiratory movements, 374, 375; influence of, on pharynx, 385; on œsophagus, 386; on stomach, 387; chief excitator of sense of hunger, 412, 637; effects of section of, on lungs, 409—411; on digestion, 412—415; on heart, 416
 Pelagian-Negro races, 104
 Pelvis, various forms of in different races of Men, 88
 Pepsin, 668, 669
 Perception, 488—490
 Perenni-branchiate Batrachia, 32
 Peristaltic movements of intestines, 388, 575, 660; independent of nervous agency, 388; influenced by spinal cord through sympathetic, 388, 389
 Peyrierian glands, 874, 876
 Philip, Dr. Wilson, his experiments on the Par Vagum, 414, 415; on connection of Nervous System with heart, 717 *a*; with Capillaries, 742; on animal heat, 890
 Phosphorus, an element of food, 648; in proteine-compounds, 113, 114; oxidation of, in system, 847
 Photophobia, 431
 Phrenological doctrines regarding Cerebellum, 466—470
 Phrenology, observations on, *Appendix I. Physiology*, objects of the science, and mode of pursuing it, *Introduction*.
 Pigment-cells, 163, 164
 Piementum nigrum, 164
 Placenta, 44; formation and structure of, 920—924
 Placental souffle, 925
 Plants, see Vegetables
 Playfair, Dr., his observations on Milk, 855
 Plethora, increase of blood-corpuscles in, 708 *c*
 Plexus of nerves, use of, 298
 Plica Polonica, 168
 Plicæ dorsales, 937
 Pneumogastric nerve, see Par Vagum
 Poissuille, M., his experiments on the circulation, 726, 729, 730
 Polli, Dr., his observations on blood, 701, 702
 Polydesmus, nervous system of, 326
 Polynesian races, 103
 Polypes, 6—10; circulation in, 715; reproduction of parts in, 9, 792; movements of, 313
 Porrigo favosa, 809 *a*
 Portal circulation, 685, 746; in liver, 826, 827; in kidneys, 839 *b*—841
 Portio dura, 406
 Posterior roots of spinal nerves, 344
 Pregnancy, signs of, 926; see Gestation
 Presbyopia, 538
 Richard, Dr., his ethnographical researches referred to, 63 *note*, 77, 92
 Primitive trace, 936
 Protecting agency of Spinal Cord, 394—396
 Proteine, composition and properties of, 116
 Proteus, 32; blood-corpuscles of, 146 *c*, 151
 Prout, Dr., his classification of alimentary substances, 640; his observations on secondary digestion, 681; on amount of carbonic acid excreted, 767; on watery exhalation from the lungs, 773; on urine, 845 *d*; on general disorders of secretion, 883
 Puberty, in Male, 903; in Female, 908
 Pulsation of heart, 717
 ——— of arteries, 729
 Pulse, average frequency of, at different ages,

The Numbers refer to the Paragraphs.

727; variations of, under different circumstances, 727 *a-e*; proportion of to respiratory movements, 762
 Pulse, respiratory, 744 *b*
 — venous, 723 *c*
 Pupil, action of, 395
 Purkinje, optical experiment of, 555
 Pus, production of of, 779, 800, 805, 806
 Pyramids, anterior and posterior, 350—354

Q.

QUADRUMANA, 50
 Quekett, Mr. J., his observations on bone referred to, 194 *a*
 Quetelet, M., his researches on relative mortality at different seasons, 699 *c*; on length and weight of infants at birth, 948; on relative viability of males and females, 950; on comparative heights of males and females, 951
 Quickening, 927

R.

RACIBORSKI, his researches on Conception, 909
Radiata, 5—10; general structure of, 5; affinity with vegetables, 6, 7; symmetry in, 8; reproduction of parts in, 9; nutritive organs in, 10; nervous system in, 311—314
 Rainey, Mr., his researches on structure of lungs, 757
 Recti muscles of orbit, 450
 Red Corpuscles of Blood, see Corpuscles, Red
 Reeds, vibrating, laws of, 606 *c*
 Rees, Dr. G. O., his observations on blood-corpuscles referred to, 143, 144, 148; on composition of Chyle and Lymph, 691; on Saline matter of Blood, 697 *d*
 Reflex action, 313, 363; in Mollusca, 316, 317, 322; in Articulata, 327—329, 335; in Vertebrata, 337, 361—373
 ———, cases of in Man, without sensation, 365—370
 Regeneration of parts, in lower Animals, 9, 792; of bone, 204—207, 792; of nervous substance, 253
 Reid, Dr. J., his researches on respiratory movements, 374, 375; on movements of deglutition, 384—386; on movements of stomach, 387; on glosso-pharyngeal nerve, 407; on pneumogastric, 408—416; on laryngeal nerves, 378, 379; on spinal accessory, 417; on muscular contractility, 589; on irritability of heart, 717; on Asphyxia, 723 *c*, 780; on capillary circulation, 740; on mucous membrane of uterus, 919; on structure of placenta, 922
 Reid, Dr. D. B., his researches on respiration, 765
 Reinforcement, fibres of, 326
 Reparative processes, 792—801; Dr. Macartney's views of, 793—801; union by first intention, 794; process of organization of liquor sanguinis, 119, 795; organization of blood, 700, 796; modelling process, 797;

causes favourable to, 798; granulation, 799—801

Repetition of parts in *Radiata*, 6—9; in *Articulata*, 324, 330

REPRODUCTION,

General account of, 281, 282, 898; in Plants, 109, 898, 899; in Animals, 900
 History of, in Male, 901—904; spermatic fluid, 867, 901; evolution of spermatozoa, 902; power of, 903; coitus, 904

History of, in Female, 905—933; general account of ovum, 905; first development of, 906, 907; menstruation, 908, 909; aptitude for conception, 909, 910; coitus, 911; escape of ovum, 912; corpus luteum, 913, 914; first changes in ovum, 915—917; addition of chorion, 918; formation of decidua, 919; formation and structure of placenta, 920—924; sound of, 925; increase of tissue of uterus, 926; quickening, 927; parturition, 928, 929; ordinary duration of gestation, 930; protracted gestation, 931; shortest term of gestation, 932; superfatation, 933

Development of embryo, see Embryo

Reproduction of lost parts, 9, 792

Reptiles, 28—32; respiration and circulation in, 28, 756; different orders of, 29, 30; connected with Fishes by *Batrachia*, 31, 32; brain of, 360; blood-corpuscles of, 145, 146 *c*; lungs of, 756

Resistance, sense of, 514

RESPIRATION,

General purposes of, 749—754; necessity for, 749; in Plants, 750; in Animals, generally, 751; in warm-blooded Vertebrata, 752; variation in degree of, 753, 754

Structure and action of Respiratory organs, in Invertebrata, 755; in lower Vertebrata, 756; structure and development of lungs in Man, 757; arrangement of their blood-vessels, 758; contractility of bronchial tubes, 758; movements concerned in exchange of air, 760, 761; number and extent of, 762, 763; capacity of lungs, 764

Chemical phenomena, 765—768; carbonic acid exhaled, 765; proportional amount of oxygen absorbed, 766; absolute quantity of carbon set free, 767; variations in, 767 *a-i*; azote absorbed and exhaled, 766; cutaneous respiration, 768

Effects on the blood, 769—772; carbonic acid in venous blood, 769, 770; exhalation of, in hydrogen and azote, 769; comparative analysis of free gases in arterial and venous blood, 770; causes of change of colour, 771, 772

To be regarded as an Excretion, 275, 749; consequences of retention of carbonic acid, 778—780; phenomena of Asphyxia, 779; its immediate causes, 780

Movements of, 760—763; dependent on Nervous agency, 374, 375; centre of, in *Medulla oblongata*, 376; nerves concerned in, 374—376; independent of will and of consciousness, 377; guard to entrances of lungs, 378, 379; modifications of, 379—381; influence of pain on, 431, 763; num-

The Numbers refer to the Paragraphs.

- ber of, 762, 763; share of lungs and air-passages in, 759, 760; various influences affecting, 763
- Respiratory Circulation, 710; peculiarity of, 746
- Respiratory pulse, 744 *b*
- Restiform bodies, 350—354
- Rete mucosum, 161
- Retina, structure of, 539; the recipient of visual impressions, 536; inversion of pictures upon, 543; persistence of impressions on, 551, 552; vanishing of images on, 554; visual representation of, 555
- Retinacula, 906, 912
- Rigor Mortis, 232, 595—597
- Richie, Dr., his researches on development of ova, 907; on Menstruation, 909; on the Corpus luteum, 914
- Robinson, Mr., on effusion of fibrine, 803
- S.
- SACCHARINE principles of food, 640; destination of, 641, 643, 645, 670
- Saliva, properties of, 656, 668, 863; incorporation of with food, 656
- Salivary glands, structure of, 862; secretion of, 863; influence of nervous system on, 625, 626
- Saunders, Mr. E., his researches upon the teeth, 217 *k-m*
- Savart, M., his researches upon sound, 469 *a*
- Scharling, Prof., his researches on respiration, 767
- Schleiden, his researches on the development of cells in Plants, 124
- Schwann, his experiments on muscular contraction, 592; his observations on cellular origin of Animal structures, 135
- Seasons, influence of on Calorification, 894
- Sebaceous glands, 872
- SECRETION, general nature of, 275—278, 817; structures adapted for, 821—823; essentially composed of cells, 821—823; disorders of, connected with nutritive processes, 882; not dependent on nervous agency, 620, 624; influence of nervous system on, 625—628
- Secretions, amount of, 818; sources of, 819; elements of, pre-existing in the blood, 820; some of them used in the system, 820; see Bile, Urine, Milk, &c.
- Seguin, on cutaneous exhalation, 870
- Selecting power, of individual parts, 782—785
- Semicircular canals, 366
- Seminal secretion, 867, 901, 904; influenced by state of feeling, 626 *note*
- SENSATION, 307, 308; characteristic of Animals, 283, 284; why associated with reflex actions, 371, 372; dependent on Capillary Circulation, 290, 507, 508; the originator of consensual movements, 430—432; the guide of voluntary movements, 433
- Sensations, nature of, 506; different kinds of, 507; dependence of on supply of blood, 508; pain or pleasure connected with, 509; influence of habit on, 510—513; special, 514, 518; common, 514, 515; subjective and objective, 516, 518, 521; transference of, 517; influence of attention on, 519—521; knowledge gained from, 487—490
- Sense, Muscular, 433, 434
- Sensibility in different parts, 507, 508
- Sensitive Plant, movements of, 1
- Sensorium, 435
- Sensory ganglia, 422—427; functions of, 428—440
- nerves, 441—449; terminations of, 248
- tract of Sir C. Bell, 351
- Serous membranes, 175
- Serpents, 29
- Serres, his measurements of Cerebellum, 457; of Cerebrum, 481
- Serum of blood, 696; composition of, 697; proportion of, to clot, 703; milky, 697 *e*
- Seventh pair, portio mollis of, 446; portio dura of, 406
- Sexual instinct, 903, 909; its supposed location in the Cerebellum, 466—470
- Sharpey, Dr., his observations on development of bone, 197—201; on muscular fibrillæ, 230, *note*; on nerves of Cuttlefish, 322; on decidua, 919
- Shell, structure of, in Echinodermata, 192; in Mollusca, 192
- Siege of Landau, 946
- Sighing, act of, 380
- Sight, sense of, see Vision
- Simon, Mr., on Thymus and Thyroid Glands, 687, 688
- Single vision with two eyes, 545—547
- Siren, 32; blood-corpuscles of, 145 *note*
- Sixth pair of nerves, 405
- Size, mode of estimating by vision, 549
- Skin, structure of, 176, 177; contractility of, 234; absorbing power of, 676—679; respiratory power of, 768; exhaling apparatus in, 868; transpiration from, 869—871; sebaceous and ceruminous glands in, 872; exudation from, increased by heat, 897
- Skull, forms of, in different races of Men, 83—87
- Sleep, 499
- Smell, sense of, 531, 532; seat of, 531; conditions of, 531; acuteness of, in some Animals and Men, 532
- Sneezing, act of, 381, 531
- Sobbing, act of, 380
- Solen, nervous system of, 317, 318
- Somatic death, 813, 814
- Somnambulism, 500, *Appendix II.*
- Sound, laws of propagation of, 560—562; successive pulses of, 569; mode of estimating direction, distance, and intensity of, 570; rapidity of perception of, compared with that of light, 571; use of in regulating voice, 572, 611
- Sounds, articulate, 612—619
- , of heart, 720, 721; of placenta, 925
- Spasmodic diseases, 501—504
- Species, discrimination of, 64—67; variation within limits of, 68—73; distinguished by physiological and psychological characters, 74—77
- Spencer, Earl, on the duration of gestation in Cattle, 931

The Numbers refer to the Paragraphs.

- Spermatic fluid, 867
 Spermatozoa, 900, 901; function of, 900, 911, 917; development of, 902
 Sphincters, action of, 391, 392
 Sphinx ligustri, Nervous system of, 325
 Spinal accessory nerve, 417
Spinal Cord of Vertebrata, 346—350; its comparative anatomy, 346; its divisions, 346, 347; its connections with the nerves, 347, 348; functions of several parts of, 349, 350; general functions of, 363—373; absence of proper sensibility in, 365; protecting agency of, 394—396; maintenance of muscular tension through, 398, 399; influence of, on heart, 717 *a*; power of sustaining locomotive actions, 397; pathological conditions of, 400, 401, 501—504
 Spinal nerves, double roots of, 344
 Spinal system, nerves of, 402—421
 Spleen, structure of, 683; functions of, 684, 685
 Sponges, 1, 7
 Spongioles of Plants, 107
 Stammering, causes of, 617, 618; treatment of, 619
 Star-fish, structure of, S—10; nervous system of, 312, 314
 Stark, Dr., his analysis of Bone, 196 *b*
 Stearine, composition and properties of, 185 *a*
 Stereoscope, 546, 547
 Stilling, Dr., his researches on the Spinal Cord, 347
Stomach, presence of, characteristic of Animals, 2; general characters of, 655; state of, in health, 657; in disease, 758; sense of hunger referred to, 637; movements of, 387, 413, 659; influenced by nerves, 387, 413; secretions of, 665, 873; influence of nerves on, 414, 415; effects of blows on, 580, 625
Stomato-gastric system, of Mollusca, 319, 320; of Articulata, 332—334
 Strabismus, 454 *a-d*
 Strangury, 504
 Strings, vibrating, laws of, 606 *a*
 Strumous diathesis, 878 (see Tubercle)
 Subjective sensations, 516, 518, 521
 Suction, act of, 386 *c*
 Sudoriferous glandulæ, 868; their secretion, 869, 870
 Sulphur, contained in food, 648; in proteino-compounds, 113, 114; oxidation of, in system, 847
 Superfetation, 933
 Suppuration, 799—801
 Supra-renal capsules, 686
 Swimming-bladder, 27
 Symmetrical diseases, 784, 785
 Symmetry, radiate, 8; bilateral, of Articulata, 18; of Vertebrata, 25; deficiency of, in Mollusca, 12
Sympathetic System, peculiar fibres of, 244; general structure of, 338, 341, 342; influence of, on movements of intestinal canal, 388, 389; on ureter and muscular coat of bladder, 390; on uterus and fallopian tubes, 393; on heart and vessels, 416, 623, 717 *b*, 730, 732; on ductus choledochus, 825 *f*; on processes of organic life, 620—628
 Sympathies, motor, 620—623; organic, 625—628
- Syncope, 580, 814
 Synovial Membranes, 175
 Syro-Arabian nations, 94
- T.
- TALIACTOTIAN operation, 253
 Taste, nerves of, 407, 447
Taste, sense of, 527—530; nerves concerned in, 407, 447; conditions of, 528; partly dependent on smell, 529; educability of, 530; purposes of, 529
 Teeth, 208—217; component tissues of, 208—216; development of, in Human infant, 217, *a-i*; a test of age, 217 *k, l, m*
 Temperature, sense of, 514, 524; ordinary, of the human body, 886; extremes of sustainable by Man, 887, 888; (see Heat)
 Tendons, structure of, 140; attachment of to muscle, 233
 Tenesmus, 504
 Tension of Muscles, 398, 399
 Tetanus, 401, 502
 Testis, structure of, 866; development of, 866 *b*; secretion of, 867
 Tessier's experiments on duration of gestation, 931
 Thackrah, Mr., his observations on coagulation of blood, 703
 Thalami Optici, 423, 424
 Thaumatrope, 551
 Third pair of Cranial Nerves, 405
 ——— ventricle of Brain, 358, 359
 Thirst, sense of, 639
 Thorax, movements of, in respiration, 760, 761
 Thymus gland, 687, 688
 Thyroid gland, 689
 Tiedemann, his researches on absorption, 675
 Tissues, elementary, classification of, 137
 Todd, Dr., on mucous membrane, 873
 Tomes, Mr., his observations on bone referred to, 196, 203, 207
 Tongue, papilla of, 527; movements of, 418, 419
 Tonicity of muscles, 593—597; of arteries, 731; effects of deficiency of, 745
 Tortoises, 29
 Touch, nerves of, 448
Touch, sense of, 522—826; varying acuteness of, in different parts, 522; ideas derived from, 514, 523; peculiarities of, 524; improbability of, 525; modifications of, in different animals, 526; connection of, with vision, 541, 542
 Toynbee, Mr., his researches on non-vascular tissues, 187—190
 Trainers' diet, 654
 Transudation, 824
 Travers, Mr., his observations on formation of new vessels, 222; on production of new tissue, 795
 Trifacial nerve, 403, 404
 Tubercula Quadrigemina, 422, 436
 Tubercular matter, 807, 808; tendency in the system to deposit, 878
 Tubular tissues, simple, 218—222; compound, 223—253

The Numbers refer to the Paragraphs.

Tunica granulosa, 906, 912
 Turkish race, 96
 Tunicata, nervous system and actions of, 316
 Tympanum, membrane of, 563; cavity of, 564

U.

UMBILICAL cord, 941, 942
 ——— vesicle, 939, 941
 Unguiculated Mammalia, 48, 49
 Ungulated Mammalia, 48, 49
 Unity, specific, of human races, 91
 Urea, composition of, 844; increase of by exercise, 844
 Uric acid, composition of, 845; pathological changes in, 845 *a-d*
 Urine, nature and purposes of its secretion, 842—852; effects of its retention, 842; composition of, in health, 843; amount of urea contained in, 844; uric acid in, 845; hippuric acid in, 845 *a*; no lactic acid in, 846; saline compounds in, 847; alkaline or acid reaction of, 848; amount of azotized matter in, 849; influence of diet on, 849, 850; transference of secretion, 851; excretion of saline matter with, 852
 Uterus, changes of, preparatory to gestation, 919; increase in substance during gestation, 926; contractions of, how far dependent on nervous agency, 393, 928

V.

VAGUS nerve, see Par Vagus
 Valentin, his researches on Spinal Cord, 349; on movements of Stomach, 387; on the Sympathetic, 388, 390, 393, 730; on Olfactory nerve, 441; on Optic nerve, 442; on Portio Dura, 406; on Par Vagus, 408, 416; on Spinal Accessory, 417; on Hypoglossal, 418; on quantity of blood in system, 724
 Valves of heart, actions of, 722, 723 *c*; sounds produced by, 720, 721
 Vapour, exhalation of, from lungs, 773, 774
 Variation, extremes of in species, 68—71; in Man, 72, 73
 Varicose nerve-tubes, 243
 Vasa lutea, 939
 Vascular area, 938
 ——— lamina of Germinal Membrane, 936, 938, 940
 Vegetable proximate principles, 111
 Vegetables, distinguished from Animals, 1—4; food of, 2; movements of, 1, 283; early development of, 3; formation of cells in, 106—109, 120—125; general functions of, 107, 261; circulation in, 712—714; respiration in, 750; reproduction in, 899
 Veins, distribution of, 710; structure of, 743; movement of blood in, 744; causes of congestion in, 745; pulsation in, 723 *c*
 Ventricles of heart, contraction of, 718—721; force of, 726; thickness of, 723; capacity of, 724
 Ventricles of brain, third, 358; fourth, 346, 358
 Vertebræ, 21; origin of, 937

Vertebral column in Fishes, 26
Vertebrata, 5, 20—25; skeleton of, 21, 22; extremities of, 22; predominance of nervous system in, 20, 23; organs of animal and vegetative life in, 23; symmetry in, 25; intelligence of, 23; nervous system of, 339—362
 Vesicles of Brain in Embryo, 358
 Vessels, formation of, in Plants, 218; in Animals, 221, 222
 Viability of Infant, earliest period of, 932
 Vierordt, his researches on respiration, 765, 767
 Villi of Mucous Membrane, 178, 472, 473
 Visceral system of nerves, see Sympathetic
 Visible direction, law of, 543
 Vision, sense of, 533—555; optical conditions of, 534—537; defective, 538; limits of, 540; mental conditions of, 541; connection of, with touch, 541, 542; erect, 543; single, 544, 545; appreciation of form by, 546, 547; of distance, 548; of size, 549; persistence of impressions, 551; complementary colours, 552; want of power to distinguish colours, 553; vanishing of images, 554; visual perception of retina, 555
 Vital Action involves change, 254
 ——— dependence of, on external stimuli, 255, 258
 Vital Actions, classifications of, into Functions, 260
 Vital forces, 256
 Vitality, duration of in individual parts, 810—812; dormant, 255
 ——— of general system, destroyed by sudden shock, 580, 735, 742
 Vital properties, 256, 258; retention of, 259
 Vitelline vessels, 939
 Vitreous humour, 190
 Voice, 602—619; conformation of larynx, 603—605; sounds resembling produced by strings, 606 *a*; by flute-pipes, 606 *b*; by reeds, 606 *c*; action of chordæ vocales, 607; artificial larynx, 607; pitch, how regulated, 608; falsetto notes, how produced, 609; influence of air-passages on, 610; movements concerned in, how directed, 611
 Volkmann, his experiments on Muscular contraction, 576
 Voluntary actions, distinguished from automatic, 483; originate in Cerebrum, 483, 495
 Vomiting, 505
 Vowel sounds, 614, 615

W.

WAGNER, his observations on blood-corpuscles, 148, 155, 157, 159 *a*; his account of development of Spermatozoa, 902
 Wasmann, his researches on pepsin 668
 Waste of Animal tissues, see Decay, and Disintegration
 Weber, Prof., his researches on sensation, 522; on absorption, 672; on movements of heart, 717 *a*
 Whale, Spermaceti, peculiar sensibility of, 526
 Wheatstone, Prof., his Stereoscope, 546, 547
 White corpuscles of blood, 151—159
 White fibrous tissue, 138—141

The Numbers refer to the Paragraphs.

- | | |
|--|--|
| White matter of nervous system, 242, 243 | Y. |
| Williams, Dr., on contractility of bronchi, 759;
on Necræmia, 708; on Inflammation, 158;
on causes of Venous Congestion, 745 | YAWNING, act of, 390 |
| Willis, Mr., his researches on the Voice, 604—
608 | Yellow fibrous tissue, 138—142 |
| Wilson, Mr. Erasmus, on cutaneous follicles,
868 | Yolk, 905, 935, 939 |
| Wings of Insects, interlacement of nerves sup-
plying, 298; rapidity of motion of, 600 | Yolk-bag, 905, 935, 939 |
| Wollaston, Dr., his observations upon sound,
569 <i>a</i> ; upon hemiopia, 545 <i>note</i> | Young animals, low calorifying power of, 893,
932 <i>a</i> ; influence of cold upon, 893 <i>c</i> |
| | Z. |
| | ZONA pellucida, 905, 917 |
| | Zwicky, Dr., on organization of thrombus, 700 |

THE END.

