

LIBRARY OF
THE NEW YORK BOTANICAL GARDEN

By exchange
1911-13

September 1899

R. W. Gibson - Invt.

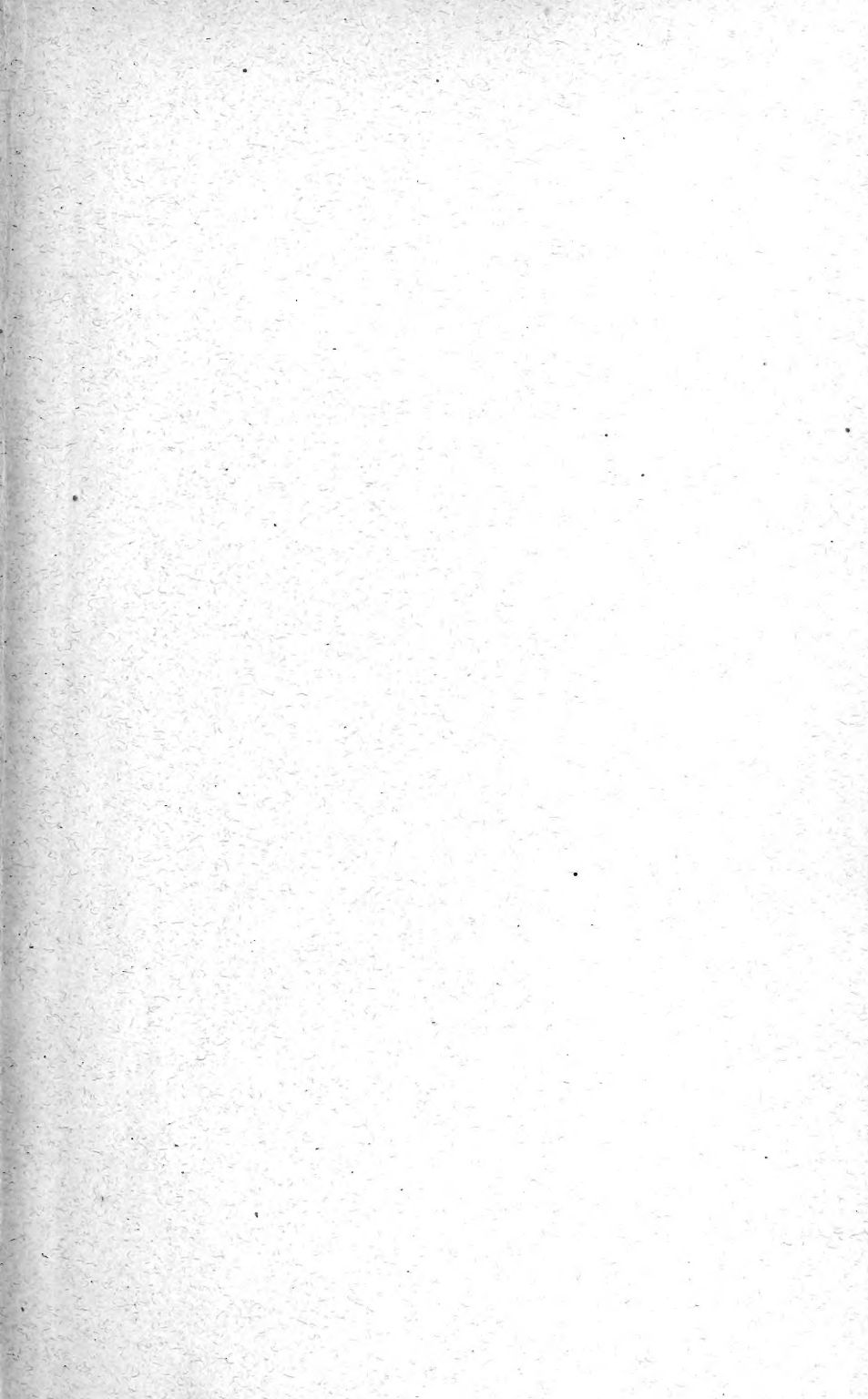

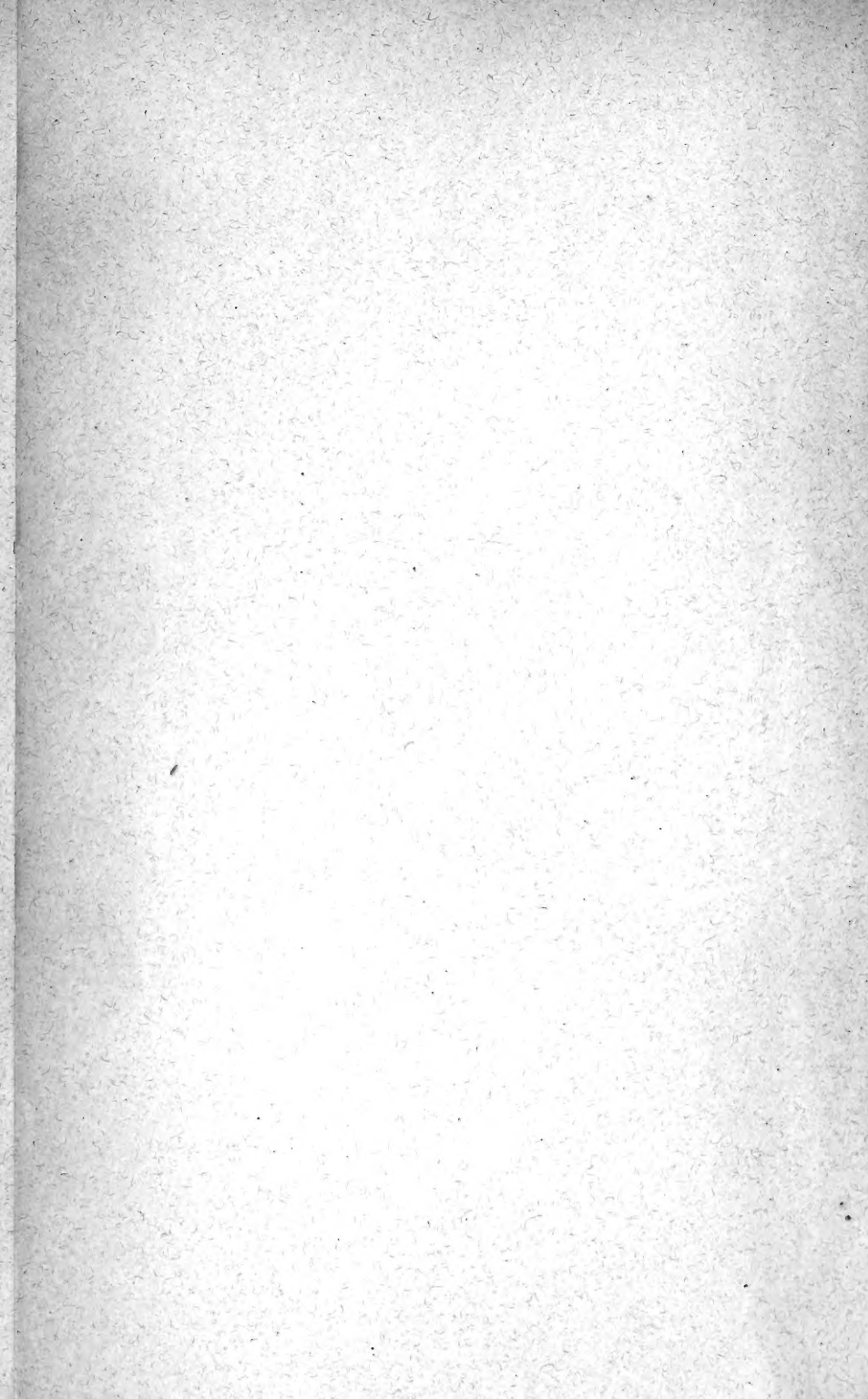

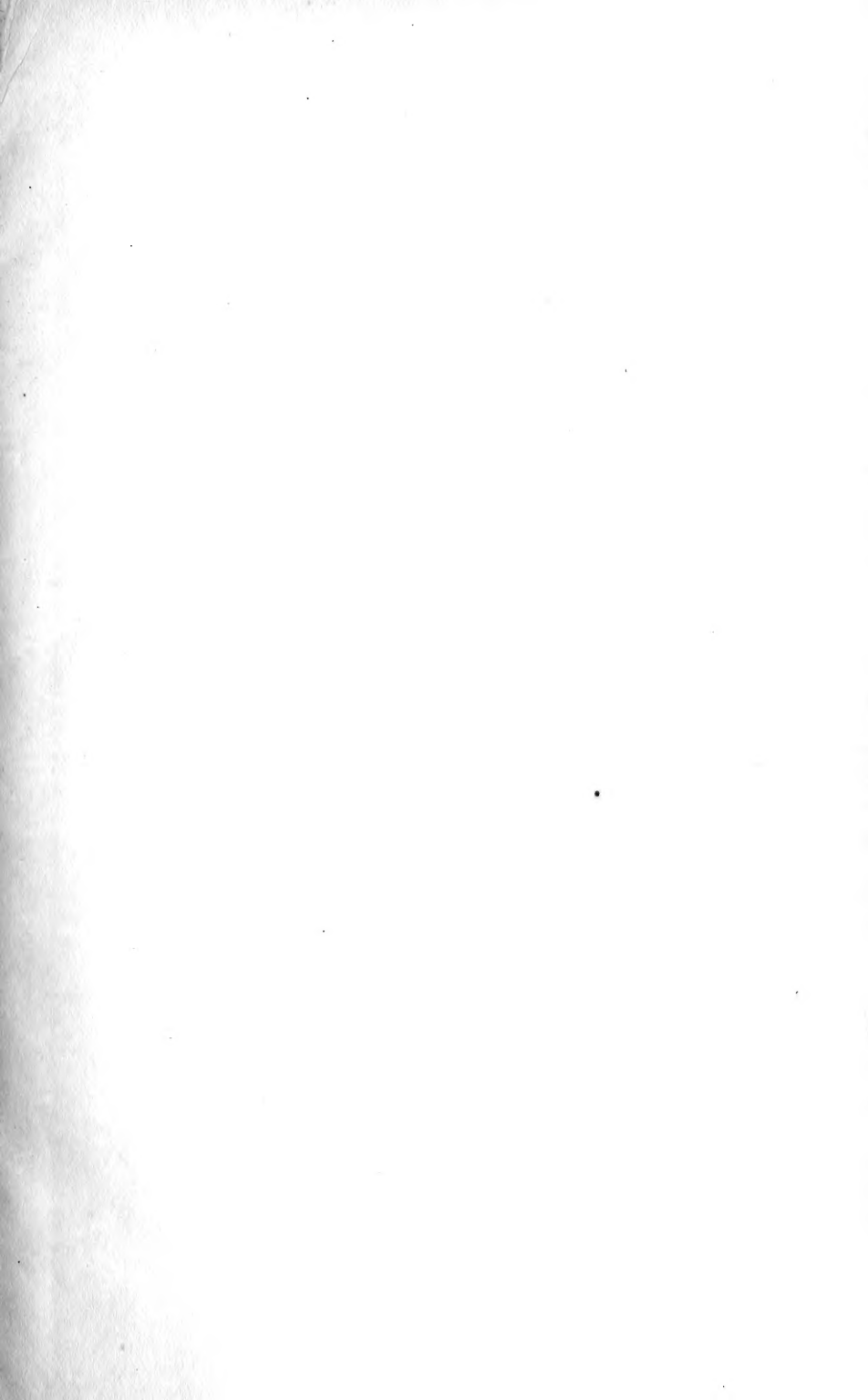

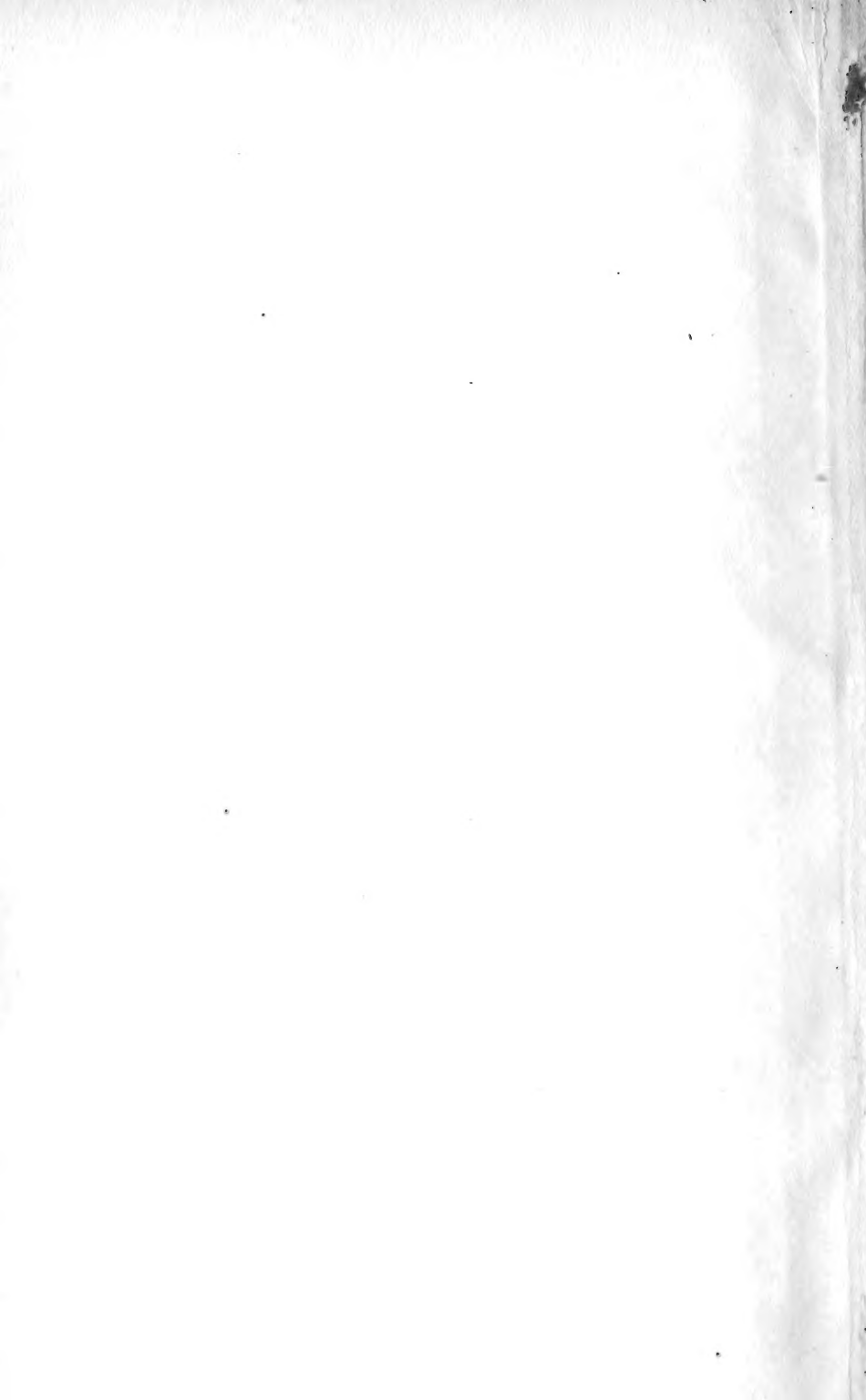

PROCEEDINGS

OF THE

Indiana Academy
of Science

1911

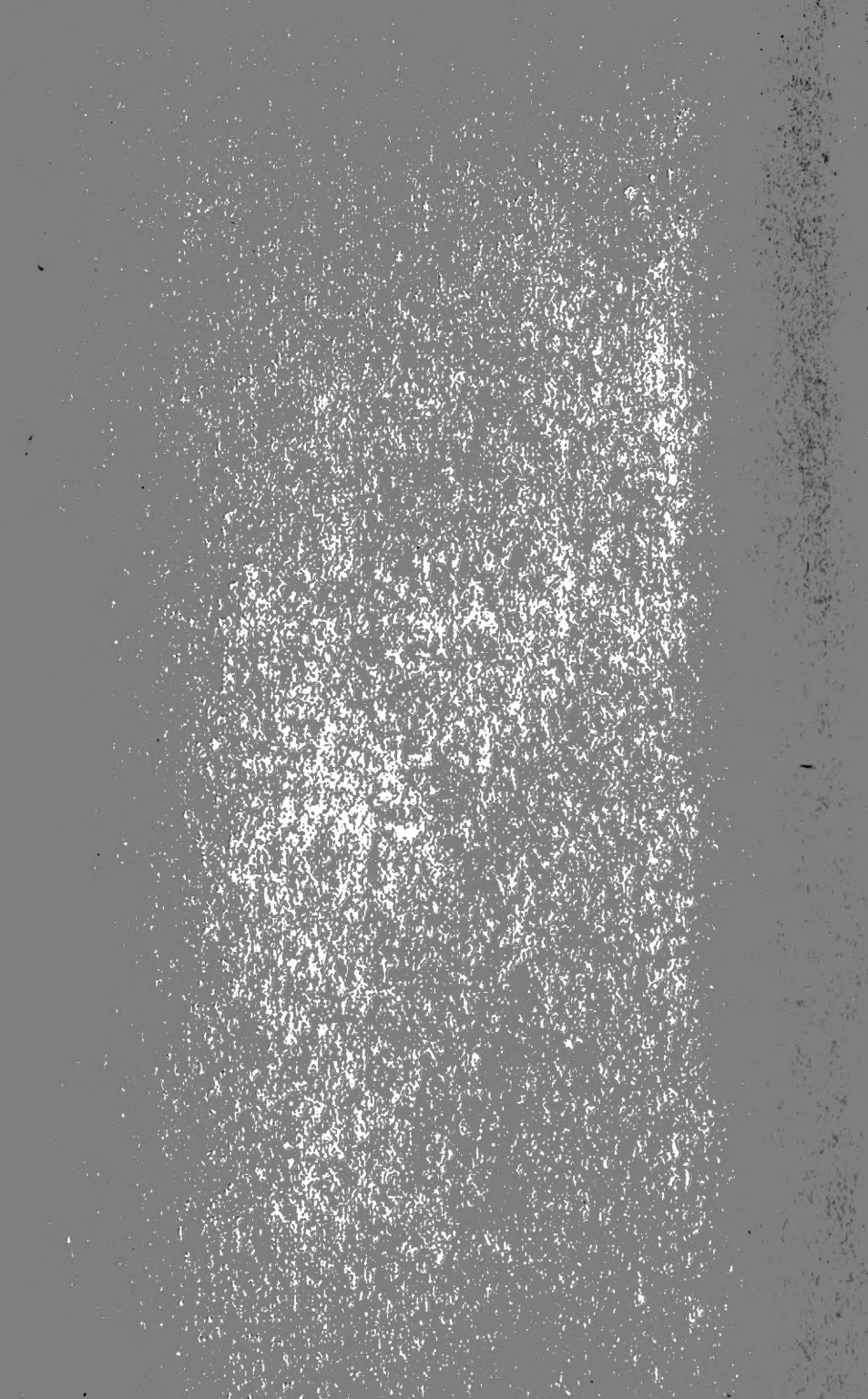

PROCEEDINGS

OF THE

Indiana Academy of Science

1911

L. J. RETTGER EDITOR

INDIANAPOLIS, IND.
1912.

XP
.R684

INDIANAPOLIS:
WM. B. BURFORD, PRINTER
1912

THE STATE OF INDIANA,

EXECUTIVE DEPARTMENT,

March 1, 1912.

Received by the Governor, examined and referred to the Auditor of State for verification of the financial statement.

OFFICE OF AUDITOR OF STATE,

INDIANAPOLIS, March 5, 1912.

The within report, so far as the same relates to moneys drawn from the State Treasury, has been examined and found correct.

W. H. O'BRIEN,

Auditor of State.

March 20, 1912.

Returned by the Auditor of State, with above certificate, and transmitted to Secretary of State for publication, upon the order of the Board of Commissioners of Public Printing and Binding.

MARK THISTLETHWAITE,

Secretary to the Governor.

Filed in the office of the Secretary of State of the State of Indiana, March 28, 1912.

L. G. ELLINGHAM,

Secretary of State.

Received the within report and delivered to the printer April 16, 1912.

ED D. DONNELL,

Clerk Printing Board.

MASON BLANCHARD THOMAS.

On Wednesday evening, March 6, 1912, Mason Blanchard Thomas, Professor of Botany at Wabash College and Dean of the Faculty, died at his home in Crawfordsville of an acute attack of pleurisy.

Mason B. Thomas was born at New Woodstock, N. Y., December 16, 1866. He prepared for college at Cazenovia Academy and entered the College of Arts and Sciences at Cornell University in the fall of 1886. He was graduated with the degree of B. S. in 1890 and was awarded a graduate fellowship in biology at Cornell for the following year. In 1891 he came to Wabash College as Professor of Biology, and after 1895, when the department was divided, he gave his whole time to the study and teaching of Botany.

While at Cornell he was elected to membership in the Sigma Xi Society and at Wabash was elected as an organization member of the Phi Beta Kappa Society. In 1907 an honorary Ph.D. was conferred upon him by the trustees of Wabash.

In June, 1893, he was joined in marriage to Miss Annie Davidson, only daughter of Judge and Mrs. T. F. Davidson, of Crawfordsville, and his wife survives him.

Professor Thomas was a great teacher. He brought to his work a thorough knowledge of his subject, an unbounded energy and enthusiasm, and a personal interest in and love for his students. He was active also in furthering the general interests of the college; was for many years the chairman of the Athletic Committee of the Faculty, and since 1907 has been the Dean of the Faculty. He was a fellow and past president of the Indiana Academy of Science and has always been active in its service. At the time of his death he was secretary of the Indiana Forestry Association and chairman of its Educational Committee, and secretary of the Board of Trustees of the Boys' School at Plainfield. He was also a fellow of the American Association for the Advancement of Science and a member of the American Microscopical Society, the American Forestry Association, the Botanical Society of America, the American Phyto-

pathological Society, the Society of Western Naturalists, and the Corporation of the Marine Biological Laboratory at Woods Hole.

For twenty years Professor Thomas has given his best efforts in the service of Wabash College, of Crawfordsville, and of the State of Indiana, and his influence will long be felt through the work he has done and the inspiration he has given to his students and associates.

TABLE OF CONTENTS.

	PAGE
Mason Blanchard Thomas.....	4
An Act to Provide for the Publication of the Reports and Papers of the Indiana Academy of Science.....	9
An Act for the Protection of Birds, Their Nests and Eggs.....	11
Indiana Academy of Science Officers, 1911-1912.....	12
Constitution.....	15
Members.....	18
Minutes of Spring Meeting, Terre Haute, Indiana, May 11, 12 and 13, 1911.	27
Minutes of the Twenty-Seventh Annual Meeting.....	29
Program of the Twenty-Seventh Annual Meeting.....	33
President's Address. By Charles Redway Dryer. The North America of Today and Tomorrow and Indiana's Place in It.....	37
Chemical Notes on Ventilation. By Percy Norton Evans.....	55
An Indiana Shell Mound. By W. S. Blatchley.....	61
Maternal Impression. A. G. Pohlman, Indiana University.....	65
Terraces of the Whitewater River Near Richmond, Indiana. By Allen David Hole.....	71
Some Neglected Principles of Physiography. A. H. Purdue.....	83
Conservation of the Soil in Dearborn County. A. J. Bigney.....	89
The Effect of Deforestation Upon the Water Level of Montgomery County. H. L. Barr.....	91
The Geological Conditions of Municipal Water Supply in the Driftless Area of Southern Indiana. By E. R. Cumings.....	111
A Note on the Batostomas of the Richmond Series. By E. R. Cumings and J. J. Galloway.....	147
Observations, Having for Their Object the Approximate Determination of the Time Required for the Erosion of Clifty and Butler Ravines in Jefferson County, Ind. Glenn Culbertson, Hanover, Indiana.....	169
The Occurrence of Hand-Specimens of Jointed Structure in the New Albany Shale. Glenn Culbertson, Hanover, Ind.....	171
Results of Glaciation in Indiana. By Charles W. Shannon.....	173
The Sand Areas of Indiana. By Chas. W. Shannon.....	197

	PAGE
Ancient Pipes. Andrew J. Bigney.....	211
Polarization of Cadmium Cells. By R. R. Ramsey.....	213
The Effect of Pressure on a Cadmium Cell. By R. R. Ramsey.....	215
Notes on the Calibration and Use of the Ballistic Galvanometer. By C. M. Smith.....	221
Qualitative Detection and Separation of Potassium and Sodium. F. C. Mathers and I. E. Lee.....	227
An Apparatus for the Study of the Radiation from Covered and Uncovered Steam Pipes. By O. W. Silvey and G. E. Grantham.....	229
Ash and Calorimeter Tests of Coal Purchased by Indiana University. By Frank C. Mathers and Ira E. Lee.....	237
Recovery of Silver from Silver Chloride Residues. By Frank C. Mathers.	241
A New Gas Generator. By Raymond Bellamy.....	243
Some Abnormal Plants. By Raymond Bellamy.....	245
A Modified Method for the Determination of Lead Peroxide in Red Lead. By A. R. Nees and O. W. Brown.....	247
A Simple Laboratory Method of Measuring Vapor Tension. By A. E. Caswell.....	251
A Theorem on Addition Formulae. By Leslie MacDill.....	255
Note on Multiply Perfect Numbers, Including a Table of 204 New Ones and the 46 Others Previously Published. By R. D. Carmichael and T. E. Mason.....	257
Concerning Spheric Geometry, by David A. Rothrock.....	271
On the Representations of a Number as the Sum of Consecutive Integers. By T. E. Mason.....	273
Application of the Cauchy Parameter Method to the Solution of Different Equations. By T. E. Mason.....	275
Some Variations in Plants. By F. M. Andrews.....	279
Report of the Work in Corn Pollination, III. M. L. Fisher.....	283
New and Notable Members of the Indiana Flora. E. J. Grimes.....	285
A Monograph of the Common Indiana Species of Hypoxylon. Charles E. Owens.....	291
The Improvement of Medicinal Plants. F. A. Miller.....	309
Nutrients in Green Shoots of Trees. By E. J. Petry.....	321
The New York Apple Tree Canker. By Lex R. Hesler.....	325
Value of Fertilizing Constituents of Weeds of Indiana. Analysis of Iron-weeds. By Frank Mathers and Miss Gail M. Stapp.....	341

	PAGE
The Prevalence and Prevention of Stinking Smut in Indiana. By C. R. Orton.....	343
Indiana Fungi, II. J. M. Van Hook.....	347
Diseases of Ginseng Caused by Sclerotinias. By Geo. A. Osner.....	355
Additions to the Flora of the Lower Wabash Valley, by Dr. J. Schneck. By Chas. C. Deam.....	365
Plants New or Rare in Indiana. By Chas. C. Deam.....	371
The Unattached Aecial Forms of Plant-rusts in North America. By A. G. Johnson.....	375
Coniosis. (Abstract.) By Robert Hessler.....	415
The Regenerated Scales of <i>Fundulus Heteroelitus</i> Linne, with a Preliminary Note on Their Formation. By Will Scott.....	439
A Catalogue of Scientific Periodical Literature on File in Various Libraries of the State. Compiled by Howard J. Banker and Will Scott.....	445

AN ACT TO PROVIDE FOR THE PUBLICATION OF THE REPORTS
AND PAPERS OF THE INDIANA ACADEMY OF SCIENCE.

[Approved March 11, 1895.]

WHEREAS, The Indiana Academy of Science, a chartered scientific association, has embodied in its constitution a provision that it will, upon the request of the Governor, or of the several departments of the State government, through the Governor, and through its council as an advisory board, assist in the direction and execution of any investigation within its province, without pecuniary gain to the Academy, provided only that the necessary expenses of such investigation are borne by the State; and,

WHEREAS, The reports of the meetings of said Academy, with the several papers read before it, have very great educational, industrial and economic value, and should be preserved in permanent form; and,

WHEREAS, The Constitution of the State makes it the duty of the General Assembly to encourage by all suitable means intellectual, scientific and agricultural improvement; therefore,

SECTION 1. *Be it enacted by the General Assembly of the State of Indiana*, That hereafter the annual reports of the meetings of the Indiana Academy of Science, beginning with the report for the year 1894, including all papers of scientific or economic value, presented at such meetings, after they shall have been edited and prepared for publication as hereinafter provided, shall be published by and under the direction of the Commissioners of Public Printing and Binding.

SEC. 2. Said reports shall be edited and prepared for publication without expense to the State, by a corps of editors to be selected and appointed by the Indiana Academy of Science, who shall not, by reason of such service, have any claim against the State for compensation. The form, style of binding, paper, typography and manner and extent of illustration of such reports shall be determined by the editors, subject to the approval of the Commissioners of Public Printing and Stationery. Not less than 1,500 nor more than 3,000 copies of each of said reports shall be published, the size of the edition within said limits to be determined by the concurrent action of the editors and the Commissioners of Public Printing and Stationery: *Provided*, That not to exceed six hundred dollars (\$600) shall be

expended for such publication in any one year, and not to extend beyond 1896: *Provided*, That no sums shall be deemed to be appropriated for the year 1894.

SEC. 3. All except three hundred copies of each volume of said reports shall be placed in the custody of the State Librarian, who shall furnish one copy thereof to each public library in the State, one copy to each university, college or normal school in the State, one copy to each high school in the State having a library, which shall make application therefor, and one copy to such other institutions, societies or persons as may be designated by the Academy through its editors or its council. The remaining three hundred copies shall be turned over to the Academy to be disposed of as it may determine. In order to provide for the preservation of the same it shall be the duty of the Custodian of the State House to provide and place at the disposal of the Academy one of the unoccupied rooms of the State House, to be designated as the office of the Academy of Science, wherein said copies of said reports belonging to the Academy, together with the original manuscripts, drawings, etc., thereof can be safely kept, and he shall also equip the same with the necessary shelving and furniture.

SEC. 4. An emergency is hereby declared to exist for the immediate taking effect of this act, and it shall therefore take effect and be in force from and after its passage.

APPROPRIATION FOR 1912-1913.

The appropriation for the publication of the proceedings of the Academy during the years 1912 and 1913 was increased by the Legislature in the General Appropriation bill, approved March 9, 1909. That portion of the law fixing the amount of the appropriation for the Academy is herewith given in full:

For the Academy of Science: For the printing of the proceedings of the Indiana Academy of Science, twelve hundred dollars: *Provided*, That any unexpended balance in 1911 shall be available in 1912.

AN ACT FOR THE PROTECTION OF BIRDS, THEIR NESTS AND EGGS.

SEC. 602. Whoever kills, traps or has in his possession any wild bird, or whoever sells or offers the same for sale, or whoever destroys the nest or eggs of any wild bird, shall be deemed guilty of a misdemeanor and upon conviction thereof shall be fined not less than ten dollars nor more than twenty-five dollars: *Provided*, That the provisions of this section shall not apply to the following named game birds: The Anatidae, commonly called swans, geese, brant, river and sea duck; the Rallidae, commonly called rails, coots, mud-hens, gallinules; the Limicolæ, commonly called shore birds, surf birds, plover, snipe, woodcock, sandpipers, tattlers and curlew; the Gallinæ, commonly called wild turkeys, grouse, prairie chickens, quails and pheasants; nor to English or European house sparrows, crows, hawks or other birds of prey. Nor shall this section apply to persons taking birds, their nests or eggs, for scientific purposes, under permit, as provided in the next section.

SEC. 603. Permits may be granted by the Commissioner of Fisheries and Game to any properly accredited person, permitting the holder thereof to collect birds, their nests or eggs for strictly scientific purposes. In order to obtain such permit the applicant for the same must present to such Commissioner written testimonials from two well-known scientific men certifying to the good character and fitness of such applicant to be entrusted with such privilege, and pay to such Commissioner one dollar therefor and file with him a properly executed bond in the sum of two hundred dollars, payable to the State of Indiana, conditioned that he will obey the terms of such permit, and signed by at least two responsible citizens of the State as sureties. The bond may be forfeited, and the permit revoked upon proof to the satisfaction of such Commissioner that the holder of such permit has killed any bird or taken the nest or eggs of any bird for any other purpose than that named in this section.

Indiana Academy of Science.

OFFICERS, 1911-1912

PRESIDENT

JOSEPH P. NAYLOR.

VICE-PRESIDENT

DONALDSON BODINE.

SECRETARY

A. J. BIGNEY.

ASSISTANT SECRETARY

E. A. WILLIAMSON.

PRESS SECRETARY

MILO H. STUART.

TREASURER

W. J. MOENKHAUS.

EDITOR

L. J. RETTGER.

EXECUTIVE COMMITTEE

JOSEPH P. NAYLOR,	D. M. MOTTIER,	A. W. BUTLER,
DONALDSON BODINE,	ROBERT HESSLER,	W. A. NOYES,
A. J. BIGNEY,	JOHN S. WRIGHT,	J. C. ARTHUR,
E. A. WILLIAMSON,	CARL L. MEES,	O. P. HAY,
MILO H. STUART,	W. S. BLATCHLEY,	T. C. MENDENHALL,
W. J. MOENKHAUS,	H. W. WILEY,	J. C. BRANNER,
CHARLES R. DRYER,	D. W. DENNIS,	J. P. D. JOHN,
P. N. EVANS,	C. H. EIGENMANN,	J. M. COULTER,
A. L. FOLEY,	C. A. WALDO,	D. S. JORDAN.
GLENN CULBERTSON,	STANLEY COULTER,	

CURATORS

BOTANY.....	J. C. ARTHUR.
ICHTHYOLOGY.....	C. H. EIGENMANN.
HERPETOLOGY }.....	
MAMMALOLOGY }.....	A. W. BUTLER.
ORNITHOLOGY }.....	
ENTOMOLOGY.....	W. S. BLATCHLEY.

COMMITTEES, 1911-1912.

PROGRAM.

J. W. BEEDE, R. S. HESSLER, D. BODINE.

MEMBERSHIP.

D. BODINE, J. S. WRIGHT, E. R. CUMMINGS.

NOMINATIONS.

A. L. FOLEY, U. O. COX, R. W. McBRIDE.

AUDITING.

C. H. EIGENMANN, L. J. RETTGER, F. J. BREEZE.

STATE LIBRARY.

H. E. BARNARD, W. S. BLATCHLEY, A. W. BUTLER.

RESTRICTION OF WEEDS AND DISEASES.

R. HESSLER, J. N. HURTY, A. W. BUTLER,
S. COULTER, D. M. MOTTIER.

DIRECTORS OF BIOLOGICAL SURVEY.

STANLEY COULTER, J. C. ARTHUR, J. M. VAN HOOK,
C. H. EIGENMANN, U. O. COX.

RELATIONS OF THE ACADEMY TO THE STATE.

M. B. THOMAS, R. W. McBRIDE, G. CULBERTSON,
C. C. DEAM, A. W. BUTLER.

DISTRIBUTION OF THE PROCEEDINGS.

J. S. WRIGHT, H. L. BRUNER, G. W. BENTON,
A. J. BIGNEY.

PUBLICATION OF PROCEEDINGS.

L. J. RETTGER, Editor, P. N. EVANS, D. M. MOTTIER.

OFFICERS OF THE INDIANA ACADEMY OF SCIENCE.

YEARS.	PRESIDENT.	SECRETARY.	ASST. SECRETARY.	PRESS SECRETARY.	TREASURER.
1885-1886	David S. Jordan	Amos W. Butler			O. P. Jenkins.
1886-1887	John M. Coulter	Amos W. Butler			O. P. Jenkins.
1887-1888	J. P. D. John	Amos W. Butler			O. P. Jenkins.
1888-1889	John C. Brammer	Amos W. Butler			O. P. Jenkins.
1889-1890	T. C. Mendenhall	Amos W. Butler			O. P. Jenkins.
1890-1891	O. P. Hay	Amos W. Butler			O. P. Jenkins.
1891-1892	J. L. Campbell	Amos W. Butler			C. A. Waldo.
1892-1893	J. C. Arthur	Amos W. Butler	Stanley Coulter		C. A. Waldo.
1893-1894	W. A. Noyes	C. A. Waldo	W. W. Norman		W. P. Shannon.
1894-1895	A. W. Butler	John S. Wright	A. J. Bigney		W. P. Shannon.
1895-1896	Stanley Coulter	John S. Wright	A. J. Bigney		W. P. Shannon.
1896-1897	Thomas Gray	John S. Wright	A. J. Bigney		W. P. Shannon.
1897-1898	C. A. Waldo	John S. Wright	A. J. Bigney	Geo. W. Benton	J. T. Scovell.
1898-1899	C. H. Eigenmann	John S. Wright	E. A. Schultze	Geo. W. Benton	J. T. Scovell.
1899-1900	D. W. Dennis	John S. Wright	E. A. Schultze	Geo. W. Benton	J. T. Scovell.
1900-1901	M. B. Thomas	John S. Wright	E. A. Schultze	Geo. W. Benton	J. T. Scovell.
1901-1902	Harvey W. Wiley	John S. Wright	Donaldson Bodine	Geo. W. Benton	J. T. Scovell.
1902-1903	W. S. Blatchley	John S. Wright	Donaldson Bodine	G. A. Abbott	W. A. McBeth.
1903-1904	C. L. Mees	John S. Wright	J. H. Ransom	G. A. Abbott	W. A. McBeth.
1904-1905	John S. Wright	Lynn B. McMullen	J. H. Ransom	G. A. Abbott	W. A. McBeth.
1905-1906	Robert Hessler	Lynn B. McMullen	J. H. Ransom	Charles R. Clark	W. A. McBeth.
1906-1907	D. M. Mottier	Lynn B. McMullen	J. H. Ransom	G. A. Abbott	W. A. McBeth.
1907-1908	Gleam Culbertson	J. H. Ransom	A. J. Bigney	G. A. Abbott	W. A. McBeth.
1908-1909	A. L. Foley	J. H. Ransom	A. J. Bigney	G. A. Abbott	W. A. McBeth.
1909-1910	P. N. Evans	Geo. W. Benton	A. J. Bigney	John W. Woodhams	W. J. Moenkhaus.
1910-1911	C. R. Dyer	A. J. Bigney	E. A. Williamson	Milo H. Stuart	W. J. Moenkhaus.
1911-1912	J. P. Naylor	A. J. Bigney	E. A. Williamson	Milo H. Stuart	W. J. Moenkhaus.

CONSTITUTION.

ARTICLE I.

SECTION 1. This association shall be called the Indiana Academy of Science.

SEC. 2. The objects of this Academy shall be scientific research and the diffusion of knowledge concerning the various departments of science; to promote intercourse between men engaged in scientific work, specially in Indiana; to assist by investigation and discussion in developing and making known the material, educational and other resources and riches of the State; to arrange and prepare for publication such reports of investigation and discussions as may further the aims and objects of the Academy as set forth in these articles.

WHEREAS, The State has undertaken the publication of such proceedings, the Academy will, upon request of the Governor, or of one of the several departments of the State, through the Governor, act through its council as an advisory body in the direction and execution of any investigation within its province as stated. The necessary expenses incurred in the prosecution of such investigation are to be borne by the State; no pecuniary gain is to come to the Academy for its advice or direction of such investigation.

The regular proceedings of the Academy as published by the State shall become a public document.

ARTICLE II.

SECTION 1. Members of this Academy shall be honorary fellows, fellows, non-resident members or active members.

SEC. 2. Any person engaged in any department of scientific work, or in original research in any department of science, shall be eligible to active membership. Active members may be annual or life members. Annual members may be elected at any meeting of the Academy; they shall sign the constitution, pay an admission fee of two dollars and thereafter an annual fee of one dollar. Any person who shall at one time contribute fifty dollars to the funds of this Academy may be elected a life member of

the Academy, free of assessment. Non-resident members may be elected from those who have been active members but who have removed from the State. In any case, a three-fourths vote of the members present shall elect to membership. Applications for membership in any of the foregoing classes shall be referred to a committee on application for membership, who shall consider such application and report to the Academy before the election.

SEC. 3. The members who are actively engaged in scientific work, who have recognized standing as scientific men, and who have been members of the Academy at least one year, may be recommended for nomination for election as fellows by three fellows or members personally acquainted with their work and character. Of members so nominated a number not exceeding five in one year may, on recommendation of the Executive Committee, be elected as fellows. At the meeting at which this is adopted, the members of the Executive Committee for 1894 and fifteen others shall be elected fellows, and those now honorary members shall become honorary fellows. Honorary fellows may be elected on account of special prominence in science, on the written recommendation of two members of the Academy. In any case a three-fourths vote of the members present shall elect.

ARTICLE III.

SECTION 1. The officers of this Academy shall be chosen by ballot at the annual meeting, and shall hold office one year. They shall consist of a President, Vice-President, Secretary, Assistant Secretary, Press Secretary and Treasurer, who shall perform the duties usually pertaining to their respective offices and in addition, with the ex-presidents of the Academy, shall constitute an Executive Committee. The President shall, at each annual meeting, appoint two members to be a committee, which shall prepare the programs and have charge of the arrangements for all meetings for one year.

SEC. 2. The annual meeting of this Academy shall be held in the city of Indianapolis within the week following Christmas of each year, unless otherwise ordered by the Executive Committee. There shall also be a summer meeting at such time and place as may be decided upon by the Executive Committee. Other meetings may be called at the discretion of the Executive Committee. The past Presidents, together with the officers and Executive Committee, shall constitute the council of the Academy, and

represent it in the transaction of any necessary business not especially provided for in this constitution, in the interim between general meetings.

SEC. 3. This constitution may be altered or amended at any annual meeting by a three-fourths majority of the attending members of at least one year's standing. No question of amendment shall be decided on the day of its presentation.

BY-LAWS.

1. On motion, any special department of science shall be assigned to a curator, whose duty it shall be, with the assistance of the other members interested in the same department, to endeavor to advance knowledge in that particular department. Each curator shall report at such time and place as the Academy shall direct. These reports shall include a brief summary of the progress of the department during the year preceding the presentation of the report.

2. The President shall deliver a public address on the morning of one of the days of the meeting at the expiration of his term of office.

3. The Press Secretary shall attend to the securing of proper newspaper reports of the meetings and assist the Secretary.

4. No special meeting of the Academy shall be held without a notice of the same having been sent to the address of each member at least fifteen days before such meeting.

5. No bill against the Academy shall be paid without an order signed by the President and countersigned by the Secretary.

6. Members who shall allow their dues to remain unpaid for two years, having been annually notified of their arrearage by the Treasurer, shall have their names stricken from the roll.

7. Ten members shall constitute a quorum for the transaction of business.

MEMBERS.

FELLOWS.

†G. A. Abbott.....	*1908	Fargo, N. D.
R. J. Aley.....	1898	Orono, Me.
F. M. Andrews.....	1911	Bloomington.
J. C. Arthur.....	1894	Lafayette.
H. E. Barnard.....	1910	Indianapolis.
J. W. Beede.....	1906	Bloomington.
George W. Benton.....	1896	New York City.
A. J. Bigney.....	1897	Moores Hill.
Katherine Golden Bitting.....	1895	West Lafayette.
W. S. Blatchley.....	1893	Indianapolis.
Donaldson Bodine.....	1899	Crawfordsville.
F. J. Breeze.....	1910	West Lafayette.
H. L. Bruner.....	1899	Indianapolis.
Severance Burrage.....	1898	Lafayette.
A. W. Butler.....	1893	Indianapolis.
W. A. Cogshall.....	1906	Bloomington.
†Mel. T. Cook.....	1902	Newark, Del.
†John M. Coulter.....	1893	Chicago, Ill.
Stanley Coulter.....	1893	Lafayette.
U. O. Cox.....	1908	Terre Haute.
Glenn Culbertson.....	1899	Hanover.
E. R. Cumings.....	1906	Bloomington.
S. C. Davisson.....	1908	Bloomington.
C. C. Deam.....	1910	Indianapolis.
D. W. Dennis.....	1895	Richmond.
C. R. Dryer.....	1897	Terre Haute.
C. H. Eigenmann.....	1893	Bloomington.
Percy Norton Evans.....	1901	West Lafayette.
A. L. Foley.....	1897	Bloomington.
M. J. Golden.....	1899	Lafayette.

†Non-resident.

*Date of election.

†W. F. M. Goss.....	1893	Urbana, Ill.
A. S. Hathaway.....	*1895	Terre Haute.
W. K. Hatt.....	1902	Lafayette.
Robert Hessler.....	1899	Logansport.
J. N. Hurty.....	1910	Indianapolis.
†H. A. Huston.....	1893	Baltimore, Md.
Edwin S. Johnnott.....	1904	Terre Haute.
Robert E. Lyons.....	1896	Bloomington.
W. A. McBeth.....	1904	Terre Haute.
†V. F. Marsters.....	1893	Santiago, Chili.
C. L. Mees.....	1894	Terre Haute.
†J. A. Miller.....	1904	Swarthmore, Pa.
W. J. Moenkhaus.....	1901	Bloomington.
Richard B. Moore.....	1910	Indianapolis.
D. M. Mottier.....	1893	Bloomington.
J. P. Naylor.....	1903	Greencastle.
†W. A. Noyes.....	1893	Urbana, Ill.
A. G. Pohlmann.....	1911	Bloomington.
Rolla R. Ramsey.....	1906	Bloomington.
J. H. Ransom.....	1902	Lafayette.
L. J. Rettger.....	1896	Terre Haute.
David Rothrock.....	1906	Bloomington.
Will Scott.....	1911	Bloomington.
J. T. Scovell.....	1894	Terre Haute.
Albert Smith.....	1908	Lafayette.
†Alex Smith.....	1893	Chicago, Ill.
W. E. Stone.....	1893	Lafayette.
†Joseph Swain.....	1898	Swarthmore, Pa.
J. M. Van Hook.....	1911	Bloomington.
†C. A. Waldo.....	1893	St. Louis, Mo.
†F. M. Webster.....	1894	Washington, D. C.
Jacob Westlund.....	1904	West Lafayette.
†H. W. Wiley.....	1895	Washington, D. C.
W. W. Woollen.....	1908	Indianapolis.
John S. Wright.....	1894	Indianapolis.

*Date of election.

†Non resident.

NON-RESIDENT MEMBERS.

George H. Ashley.....	Washington, D. C.
J. C. Branner.....	Stanford University, Cal.
M. A. Brannon.....	Grand Forks, N. D.
D. H. Campbell.....	Stanford University, Cal.
H. W. Clark.....	Fairport, Iowa.
H. B. Dorner.....	Urbana, Ill.
A. Wilmer Duff.....	Worcester, Mass.
B. W. Everman.....	Washington, D. C.
W. A. Fiske.....	Los Angeles, Cal.
C. W. Garrett.....	Pittsburg, Pa.
Charles H. Gilbert.....	Stanford University, Cal.
C. W. Greene.....	Columbia, Mo.
C. W. Hargit.....	Syracuse, N. Y.
O. P. Hay.....	Washington, D. C.
Edward Hughes.....	Stockton, Cal.
O. P. Jenkins.....	Stanford University, Cal.
C. T. Knipp.....	Urbana, Ill.
D. S. Jordan.....	Stanford University, Cal.
J. S. Kingsley.....	Medford, Mass.
D. T. McDougal.....	Tucson, Arizona.
L. B. McMullen.....	Valley City, N. D.
T. C. Mendenhall.....	Worcester, Mass.
J. F. Newsom.....	Stanford University, Cal.
A. H. Purdue.....	Nashville, Tenn.
A. B. Reagan.....	Orr, Minn.
J. R. Slonaker.....	Stanford University, Cal.
Alfred Springer.....	Cincinnati, Ohio.
Ernest Walker.....	Fayetteville, Ark.
G. W. Wilson.....	Raleigh, N. C.

ACTIVE MEMBERS.

C. E. Agnew.....	Delphi.
L. Evelyn Allison.....	West Lafayette.
H. W. Anderson.....	Ladoga.
Paul Anderson.....	Crawfordsville,

H. F. Bain.....	San Francisco, Cal.
Walter D. Baker.....	Indianapolis.
Walter M. Baker.....	Redkey.
Edward Hugh Bangs.....	Indianapolis.
Howard J. Banker.....	Greencastle.
H. H. Barcus.....	Indianapolis.
H. L. Barr.....	Ann Arbor, Mich.
Edward Barrett.....	Indianapolis.
W. H. Bates.....	West Lafayette.
Guido Bell.....	Indianapolis.
Ray Bellamy.....	Moores Hill.
Lee F. Bennett.....	Valparaiso.
Thomas Billings.....	West Lafayette.
Harry Eldridge Bishop.....	Indianapolis.
Lester Black.....	Bloomington.
Harold Blair.....	Indianapolis.
William N. Blanchard.....	Greencastle.
Charles S. Bond.....	Richmond.
A. A. Bourke.....	Edinburg.
Omer C. Boyer.....	Lebanon.
H. C. Brandon.....	Daleville.
Chas. Brossmann.....	Indianapolis.
E. M. Bruce.....	Terre Haute.
Wm. R. Butler.....	Indianapolis.
Edward N. Canis.....	Indianapolis.
E. Kate Carman.....	Indianapolis.
Lewis Clinton Carson.....	Detroit, Mich.
Albert E. Caswell.....	West Lafayette.
E. K. Chapman.....	Crawfordsville.
E. J. Chansler.....	Bicknell.
A. G. W. Childs.....	Kokomo.
C. D. Christie.....	Cincinnati, Ohio.
J. H. Clark.....	Connersville.
Otto O. Clayton.....	Portland.
H. M. Clem.....	Chicago, Ill.
Charles Clickner.....	Silverwood, R. D. No. 1.
Charles A. Coffey.....	Petersburg.
William Clifford Cox.....	Columbus.

J. A. Cragwall.....	Crawfordsville.
C. O. Cramer.....	West Lafayette.
M. E. Crowell.....	Franklin.
Chas. M. Cunningham.....	Indianapolis.
George Cutter.....	South Bend.
Lorenzo E. Daniels.....	Laporte.
E. H. Davis.....	West Lafayette.
Melvin K. Davis.....	Terre Haute.
E. M. Deem.....	Frankfort.
Harry F. Dietz.....	Indianapolis.
C. A. Deppe.....	Franklin.
Martha Doan.....	Westfield.
J. P. Dolan.....	Syracuse.
David A. Drew.....	Bloomington.
Hans Duden.....	Indianapolis.
Herbert A. Dunn.....	Logansport.
M. L. (Durbin) Ellis, Mrs.....	Bloomington.
J. B. Dutcher.....	Bloomington.
Samuel E. Earp.....	Indianapolis.
A. A. Eberly.....	Nowata, Okla.
C. R. Eckler.....	Indianapolis.
Max Mapes Ellis.....	Bloomington.
H. E. Enders.....	West Lafayette.
Samuel G. Evans.....	Evansville.
James E. Ewers.....	Terre Haute.
William P. Felver.....	Logansport.
C. J. Fink.....	Crawfordsville.
M. L. Fisher.....	West Lafayette.
Mary A. Fitch.....	Lafayette.
A. S. Fraley.....	Linden.
George M. Frier.....	West Lafayette.
F. D. Fuller.....	West Lafayette.
Austin Funk.....	Jeffersonville.
John D. Gabel.....	North Madison.
Jesse J. Galloway.....	Bloomington.
Andrew W. Gamble.....	Logansport.
H. O. Garman.....	Indianapolis.
J. B. Garner.....	Crawfordsville.

Florence A. Gates.....	Toledo, Ohio.
Robert G. Gillum.....	Terre Haute.
E. R. Glenn.....	Bloomington.
Frederic W. Gottlieb.....	Morristown.
Vernon Gould.....	Rochester.
Melvin K. Haggerty.....	Bloomington.
Guy E. Grantham.....	West Lafayette.
Frank Cook Greene.....	New Albany.
Earl Grimes.....	Russellville.
C. F. Harding.....	West Lafayette.
Mary T. Harman.....	Bloomington.
Walter W. Hart.....	Indianapolis.
Victor Hendricks.....	Springfield, Mo.
John P. Hetherington.....	Logansport.
C. E. Hiatt.....	Philadelphia, Pa.
John E. Higdon.....	Indianapolis.
Frank R. Higgins.....	Terre Haute.
S. Bella Hilands.....	Madison, Ind.
John J. Hildebrandt.....	Logansport.
Geo. N. Hoffer.....	Lafayette.
Geo. L. Hoffman.....	West Lafayette.
G. E. Hoffman.....	Logansport.
Allen D. Hole.....	Richmond.
Lucius M. Hubbard.....	South Bend.
Martha Hunt.....	Indianapolis.
O. F. Hunziker.....	West Lafayette.
Joseph G. Hutton.....	Brookings, S. D.
Roscoe R. Hyde.....	Terre Haute.
Harry M. Ibison.....	Marion.
J. Isenberger.....	Louisville, Ky.
C. F. Jackson.....	Durham, N. H.
D. E. Jackson.....	St. Louis, Mo.
P. D. Jenks.....	Indianapolis.
A. G. Johnson.....	Lafayette.
W. J. Jones, Jr.....	West Lafayette.
A. M. Kenyon.....	West Lafayette.
Frank D. Kern.....	West Lafayette.
Clinton A. Ludwig.....	West Lafayette.

L. V. Ludy.....	Madison, Wis.
R. W. McBride.....	Indianapolis.
Richard C. McCloskey.....	Chicago, Ill.
T. S. McCulloch.....	Charlestown, Ind.
N. E. McIndoo.....	
Edward G. Mahin.....	West Lafayette.
James E. Manchester.....	Minneapolis, Minn.
Wilfred H. Manwaring.....	New York City.
M. S. Markle.....	Richmond.
William Edgar Mason.....	Borden.
Clark Mick.....	Indianapolis.
A. R. Middleton.....	West Lafayette.
G. Rudolph Miller.....	Indianapolis.
F. A. Miller.....	Indianapolis.
H. T. Montgomery.....	South Bend.
Chas. R. Moore.....	West Lafayette.
Geo. T. Moore.....	St. Louis, Mo.
Richard Bishop Moore.....	Indianapolis.
Herbert Morrison.....	Indianapolis.
Edwin Morrison.....	Richmond.
Frank K. Mowrer.....	Redkey.
F. W. Muncie.....	Crawfordsville.
Fred Mutchler.....	Bowling Green, Ky.
B. D. Myers.....	Bloomington.
Leslie C. Nanney.....	Bedford.
Charles E. Newlin.....	Indianapolis.
J. A. Nieuwland.....	Notre Dame.
Milton S. Nugent.....	Elnora.
Clayton R. Orton.....	West Lafayette.
G. A. Osner.....	Ithaca, N. Y.
D. A. Owen.....	Franklin.
Everett W. Owen.....	Indianapolis.
C. E. Owens.....	Bloomington.
E. J. Petry.....	West Lafayette.
Ferman L. Pickett.....	Bloomington.
Rollo J. Pierce.....	Richmond.
F. J. Pipal.....	West Lafayette.
Ralph B. Polk.....	Greenwood.

James A. Price.....	Ft. Wayne.
W. H. Rankin.....	Ithaca, N. Y.
C. A. Reddick.....	Crawfordsville.
C. J. Reilly.....	Syracuse.
Allen J. Reynolds.....	
George L. Roberts.....	Lafayette.
J. Schramm.....	St. Louis, Mo.
E. A. Schultze.....	Laurel.
Charles Wm. Shannon.....	Brazil.
Fred Sillery.....	Indianapolis.
Oscar W. Silvey.....	West Lafayette.
James P. Simonds.....	Indianapolis.
Charles M. Smith.....	Lafayette.
C. Piper Smith.....	Logan, Utah.
Essie Alma Smith Shannon.....	Bloomington.
E. R. Smith.....	Indianapolis.
Geo. Spitzer.....	West Lafayette.
Brenton L. Steele.....	Pullman, Wash.
Chas. Stoltz.....	South Bend.
J. M. Stoddard.....	
Milo H. Stuart.....	Indianapolis.
Julius W. Sturmer.....	Lafayette.
J. C. Taylor.....	Logansport.
Albert W. Thompson.....	Owensville.
Clem O. Thompson.....	Terre Haute.
A. D. Thorburn.....	Indianapolis.
Iro C. Trueblood (Miss).....	Greencastle.
William M. Tucker.....	Osgood.
W. P. Turner.....	West Lafayette.
Chas. A. Vallance.....	Indianapolis.
W. B. Van Gorder.....	Lyons.
H. S. Voorhees.....	Ft. Wayne.
Frank B. Wade.....	Indianapolis.
Luther D. Waterman.....	Indianapolis.
Luther C. Weeks.....	West Lafayette.
Mason L. Weems.....	Valparaiso.
Daniel T. Weir.....	Indianapolis.
James E. Weyant.....	Indianapolis.

Virges Wheeler.....	Montmorenci.
A. E. White.....	Connersville.
Alfred T. Wiancko.....	Lafayette.
Kenneth P. Williams.....	Urbana, Ohio.
E. B. Williamson.....	Bluffton.
William L. Woodburn.....	Evanston, Ill.
John W. Woodhams.....	Indianapolis.
Herbert Milton Woollen.....	Indianapolis.
J. F. Woolsey.....	Cleveland, Ohio.
G. A. Young.....	West Lafayette.
Jacob P. Young.....	Huntington.
W. J. Young.....	Washington, D. C.
Lucy Youse.....	Terre Haute.
W. A. Zehring.....	West Lafayette.
Charles Zeleny.....	Urbana, Ill.

Fellows.....	66
Members, active.....	210
Members, non-resident.....	29
	—
Total.....	305

MINUTES OF SPRING MEETING.

TERRE HAUTE, INDIANA.

MAY 11, 12 AND 13, 1911.

Members of the Academy were called to order by President Dryer in the library of the State Normal at 8 p. m. Thursday, May 11th.

The plans of the meeting as arranged by the Local Committee were outlined by the President.

The regular program for the evening was as follows:

Illustrated lecture—"The Mussel Industry of the Wabash River," by Prof. U. O. Cox, Indiana State Normal.

Illustrated lecture, "The Autochrome Process in Color Photography," by Prof. J. B. Peddle, Rose Polytechnic Institute.

About seventy-five members and visitors were present.

On Friday, at 9:30 a. m., a boat excursion was taken up the Wabash River. The party was landed some distance above Fort Harrison for an hour's tramp ashore. The party then returned to the Fort Harrison grounds for luncheon, which had been provided by the Local Committee. After luncheon an inspection of the historic grounds was made. Dr. Scovell gave a brief history of the Fort, supplemented by some interesting remarks by Mr. Emil Ehrman, present proprietor of the grounds. Mr. Ehrman distributed souvenirs in the form of small pieces of wood from a log from the original fort. The following new members were elected to the Academy during a brief business meeting:

Milton B. Nugent, Elnora, Ind.

Geo. Cutter, South Bend, Ind.

Edward Barrett, Indianapolis.

Resolution of thanks were voted Mr. Emil Ehrman for his splendid hospitalities. Similar resolutions were voted the Local Committee for the splendid program they were providing the members of the Academy. The excursionists landed at Terre Haute at 5:00 p. m.

At 8:00 p. m. a public address was given by Professor Wm. H. Hobbs, University of Michigan, under the auspices of the Academy.

May 13, Saturday, was spent by some of the visiting members in a drive along Sugar Creek.

The following were members of the excursion party :

D. M. Mottier.	W. A. McBeth.
Robert Hessler.	Charles R. Stoltz.
T. H. Grosjean.	Dr. Charles Stoltz.
L. B. Webster.	L. J. Rettger.
J. J. Galloway.	O. L. Kelso.
John B. Peddle.	B. V. Caffee.
W. S. Blatchley.	J. W. Beede.
A. H. Caffee.	J. P. Young.
Donaldson Bodine.	W. A. Cogshall.
R. G. Gillum.	H. J. Banker.
W. H. Kessel.	C. H. Bean.
E. M. Bruce.	E. S. Johonnott.
U. O. Cox.	F. R. Higgins.
James H. Baxter.	C. W. Shannon.
W. C. Ball.	R. R. Hyde.
O. J. James.	J. E. Ewers.
George Cutter.	C. R. Dryer.
Fred Donaghy.	William H. Hobbs.
M. K. Davis.	E. Barrett.
George W. Benton.	Mrs. George Cutter.
Mrs. George W. Benton.	J. T. Scovell.

W. J. MOENKHAUS,
Secretary Pro Tem.

MINUTES OF THE TWENTY-SEVENTH
ANNUAL MEETING

INDIANA ACADEMY OF SCIENCE

CLAYPOOL HOTEL, INDIANAPOLIS, INDIANA.

NOVEMBER 30, 1911.

The Executive Committee of the Indiana Academy of Science held its regular annual meeting at 8:00 p. m. The following members were present: Chas. R. Dryer, President; A. J. Bigney, W. J. Moenkhaus, D. M. Mottier, W. S. Blatchley, Judge R. W. McBride, W. A. Cogshall, J. S. Wright, D. Bodine, R. Hessler, C. H. Eigenmann. The minutes of the Executive Committee of last year were read and approved. The Treasurer made the following report:

TREASURER'S REPORT, 1911.

Balance cash on hand November 25, 1910.....	\$323 64
Dues collected, 1911.....	163 00
Total	\$486 64
Expenditures during years as per vouchers.....	222 94
Balance cash on hand November 30, 1911.....	\$263 70

W. J. MOENKHAUS,
Treasurer.

Audited and approved.

C. H. EIGENMANN,
L. J. RETTGER.

The Program Committee reported that its work had been performed as represented on the printed program.

The State Library Committee reported that the State Librarian had been taking care of all the exchanges in the most careful way, that he had bound 237 volumes and had 300 more ready for binding, and that he

had published a list of the exchanges, which can be secured on application. The committee on the relations of the Academy to the State were instructed to keep in close touch with the plans for erecting a memorial building, so that if there were rooms available they might be secured for the Indiana Academy of Science. Mr. A. W. Butler was added to this committee. The committee on the distribution of the proceedings for 1910 reported that their work had been performed. Nine hundred volumes had been printed, 300 of which were retained in the State library for distribution to libraries and learned societies, the remainder distributed to members as exchanges.

The following persons were recommended as Fellows in the Academy: Will Scott, Augustus G. Pohlman, J. M. Van Hook, F. M. Andrews.

The following standing committees were appointed by the President: Program.—J. W. Beede, R. Hessler, D. Bodine.

Membership.—D. Bodine, J. S. Wright, E. R. Cumings.

Nominations.—A. L. Foley, U. O. Cox, R. W. McBride.

Auditing.—C. H. Eigenmann, L. J. Rettger, F. J. Breeze.

State Library.—H. E. Barnard, W. S. Blatchley, A. W. Butler.

Restriction of Weeds and Diseases.—R. Hessler, J. N. Hurty, A. W. Butler, Stanley Coulter, D. M. Mottier.

Directors of Biological Survey.—Stanley Coulter, J. M. Van Hook, C. H. Eigenmann, J. C. Arthur, U. O. Cox.

Relations of the Academy to the State.—M. B. Thomas, R. W. McBride, G. Culbertson, C. C. Deam, A. W. Butler.

Distribution of Proceedings.—J. S. Wright, H. L. Bruner, G. W. Benton, A. J. Bigney.

Publication of Proceedings.—L. J. Rettger, Editor; P. N. Evans, D. M. Mottier.

After discussing the general interest of the Academy the committee adjourned.

MINUTES OF THE TWENTY-SEVENTH
ANNUAL MEETING

INDIANA ACADEMY OF SCIENCE

THE GERMAN HOUSE, DECEMBER 1, 1911.

The Indiana Academy of Science met in general session at 9:30 a. m. with President Chas. R. Dryer in the chair. The minutes of the Executive Committee were approved.

The Editor of the Proceedings, L. J. Rettger, reported that many difficulties confronted him in his work as editor, and he urged those making contributions that great care should be taken in presenting their papers in the best possible form and that no changes should be made in the proof if they possibly could be avoided. On motion of Dr. Rettger, it was decided that the other members of the committee should meet with the editor at least twice, and that their expenses should be paid by the Academy.

The Program Committee introduced the following resolutions: (1) That the Program Committee shall have the greatest possible liberty in choosing what papers sent in shall be read in the Academy and what shall be read by title only, and they shall choose the place of meeting. (2) That the Academy vote on the question whether or not they desire the program to continue through Saturday morning. The first part was adopted. In the second part, it was voted to have no Saturday session.

The following persons were elected to membership: F. J. Pipal, West Lafayette; James E. Ewers, Terre Haute; E. K. Chapman, Crawfordsville; E. J. Petry, West Lafayette; C. O. Cromer, West Lafayette; C. A. Deppe, Franklin; Melvin K. Haggerty, Bloomington; Harold Blair, Indianapolis; Clinton A. Ludwig, West Lafayette; Geo. L. Hoffman, West Lafayette; F. M. Andrews, Bloomington; E. B. Williamson, Bluffton; B. D. Myers, Bloomington; P. D. Jenks, Indianapolis; Clem O. Thompson, Terre Haute; C. E. Owens, Bloomington; H. L. Barr, Ann Arbor, Michigan.

After these business items the Academy took up the program as printed.

In the afternoon session the following items of business were considered:

The Auditing Committee reported account of the Treasurer correct.

The Committee on Nominations reported as follows: For President, Joseph P. Naylor, Greencastle; Vice-President, Donaldson Bodine, Crawfordsville; Secretary, Andrew J. Bigney; Assistant-Secretary, E. A. Williamson, Bluffton; Press Secretary, Milo H. Stuart, Indianapolis; Treasurer, W. J. Moenkhaus; Editor, L. J. Rettger, Terre Haute.

The printed program was carried out.

Adjournment.

PROGRAM OF THE
 TWENTY-SEVENTH ANNUAL MEETING

INDIANA ACADEMY OF SCIENCE

GERMAN HOUSE, INDIANAPOLIS, INDIANA.

NOVEMBER 30, DECEMBER 1, 2, 1911.

CHARLES REDWAY DRYER, President. D. W. DENNIS, Vice-President.
 A. J. BIGNEY, Secretary. W. J. MOENKHAUS, Treasurer

THURSDAY, NOVEMBER 30, 7:30 P. M.

Meeting of the Executive Committee, Claypool Hotel.

FRIDAY, DECEMBER 1, 9:30 A. M.

Business

Respiration of Necturus, 10 m. H. L. Bruner
 Chemical Notes on Ventilation, 10 m. P. N. Evans
 Scientific Results of the Indiana University Expedition
 to British Guiana, 15 m. C. H. Eigenmann
 The String Galvanometer in Physiological Research, 10 m. . . . L. J. Rettger
 An Indiana Shell Mound, 10 m. W. S. Blatchley
 Maternal Impression, 20 m. A. G. Pohlman
 Through the Yukon and Alaska Gold Fields, 20 m. (Lantern). . R. E. Lyons
 Mountain Climbing in the Far Northwest. Pres. W. E. Stone

FRIDAY, DECEMBER 1, 1:30 P. M.

Business

President's Address—The North America of Today and
 Tomorrow, and Indiana's Place in It. Charles R. Dryer
 Purposes, Methods and Progress of the Indiana Soil
 Survey, 20 m. State Geologist Edw. Barrett
 The Water Powers of Indiana, 15 m. William M. Tucker
 Economic and Social Expressions of Physical Geography
 in Indiana, 15 m. Harry M. Clem

3:30 p. m. Sectional Meetings

GEOLOGY AND GEOGRAPHY SECTION.

- Terraces along the Whitewater River, near Richmond, 20 m. Allen D. Hole
- Conservation of the Soil in Dearborn County, 10 m. A. J. Bigney
- Remarks on the Nature and Origin of the Stream
- Terraces of Southern Indiana, 20 m. J. W. Beede
- The Geological Conditions of Municipal Water Supply
- in Driftless Areas of Southern Indiana, 30 m. E. R. Cumings
- Some Physiographic Features in the Great Fault, near
- the Mouth of the Illinois River (by title) J. G. Hutton
- Some Neglected Principles of Physiography (by title) A. H. Purdue
- The Function of Hydrostatic Pressure in Glacial
- Movement and Erosion, 15 m. J. E. Ewers
- Sand Dunes in Indiana (lantern), 10 m. C. W. Shannon
- Some Results of the Work of Glaciers in Indiana, 10
- m. (lantern) C. W. Shannon
- Physiography of the Guadalupe Mountains, 20 m. J. W. Beede
- The Georgraphic Contrasts of Brown and Johnson
- Counties. 10 m. Frederick J. Breeze
- Islands in the Border Drift, 10 m. M. K. Davis
- A Note on the Bastostomas of the Richmond Series of
- Indiana, 15 m. E. R. Cumings, J. J. Galloway
- A Note on the Occurrence of Hand Specimens of
- Jointed Structure in the New Albany Black
- Shale, 3 m. Glenn Culbertson
- Observations Having for Their Object the Determi-
- nation of the Time Required for the Erosion
- of Clifty and Butler Valleys in Jefferson
- County, Ind., Report of Progress, 6 m. Glenn Culbertson

BOTANY SECTION.

- Improvement of Medicinal Plants, 15 m. Fred A. Miller
- Notes on Some New and Notable Members of the
- Indiana Flora, 10 m. E. J. Grimes
- The Blooming of *Ceris Canadensis* in October, 2 m. D. M. Mottier
- Some Variations in Plants, 5 m. F. M. Andrews
- The Conjugation of Two Different Species of Spiro-
- gyra, 5 m. F. M. Andrews

Indiana Fungi, II, 5 m.....	J. M. Van Hook
A Monograph of the Common Indiana Species of Hypoxylon, 5 m.....	C. E. Owens
The Black Rot, Sphaeropsis Malorum Pk., 10 m.....	L. R. Hesler
The Root Rot of Ginseng, 10 m.....	G. A. Osher
Distribution of Trees among Spermatophytes, 10 m.....	F. J. Pipal
Prevalence and Prevention of Stinking Smut in Indiana, 10 m..	C. R. Orton
The Unattached Aecial Forms of Plant Rusts in North America, 10 m.....	A. G. Johnson
On Plants New or Little Known in Indiana, 3 m.....	A. J. Bigney
Report of Work on Corn Pollination, III, 5 m.....	M. L. Fisher
Inheritance of Color in Corn Silk, 10 m.....	C. O. Cromer
Rate of Tree Growth in Southern Indiana, 10 m.....	Stanley Coulter
Orchard Rust in Indiana, 10 m.....	F. D. Kern
Some Abnormal Plants, 5 m.....	Raymond Bellamy
Experimental Work of the Indiana State Board of Forestry, 10 m.....	Stanley Coulter

CHEMISTRY, PHYSICS, MATHEMATIC SECTION.

Effects of Certain Dissolved Salts upon the Cohesion of Water, 10 m.....	Edwin Morrison
Summary of a Series of Thermal Value and Ash Tests of an Indiana Slack and Nut Coal, 3 m..	F. C. Mathers and I. E. Lee
Effect of Storage on the Composition of Carburetted Water Gas, 3 m.....	F. C. Mathers and I. E. Lee
A Scheme for the Qualitative Separation and Detec- tion of Potassium and Sodium, 3 m....	F. C. Mathers and I. E. Lee
The Effect of Ammonium Chloride in the Precipitation of Barium Sulphate, 5 m.....	R. E. Lyons
A Modified Method for Determining Lead Peroxide in Red Lead, 5 m.....	A. R. Nees and O. W. Brown
Electrolytic Recovery of Silver from Silver Chloride Residues, 2 m.....	F. C. Mathers
Analyses and Fertilizer Value of Certain Weeds Growing in Indiana, 3 m.....	F. C. Mathers and Gail M. Stapp
A New Gas Generator, 10 m.....	Raymond Bellamy
The Nascent State (abstract), 10 m.....	J. H. Ransom and R. A. Stevens
The Use of Hydrogen Peroxide in Hyperchlorhydria, 10 m.....	O. P. Terry

Nutrients in Green Shoots of Trees, 10 m.....	E. J. Petry
Concerning Spheric Geometry, 10 m.....	D. A. Rothrock
On the Solution of Differential Equations by Cauchy's Parameter Method, 10 m.....	T. E. Mason
On the Representation of a Number as the Sum of Consecutive Integers, 10 m.....	T. E. Mason
On Multiply Perfect Numbers, with a Table of 170 New Ones together with the 47 previously published, 10 m.....	R. D. Carmichael and T. E. Mason
Theorem on Addition Formulage, 10 m.....	Leslie McDill
A Simple Method of Measuring Surface Tension, 5 m.....	Arthur L. Foley
Electromagnetic Induction in German Silver and Bismuth, 10 m.....	Arthur L. Foley
A New Method of Photographing Sound Waves, 10 m.....	Arthur L. Foley and Wilmer H. Souder
Recalescence in Magnetic Alloys, 10 m.....	John B. Dutcher
Diffraction Photographs, 5 m.....	Mason E. Hufford
Effect of Pressure on a Cadmium Cell, 10 m.....	Rolla R. Ramsey
The Cause of Polarization in a Cadmium Cell, 10 m.....	Rolla R. Ramsey

FRIDAY, 8:15 P. M.

The Story of Niagara.....	Frank Bursley Taylor
---------------------------	----------------------

SATURDAY, 9:00 A. M.

The Regenerated Scale of <i>Fundulus heteroclitus</i> with preliminary note on its formation, 5 m.....	Will Scott
Coniosis, 20 m.....	Robert Hessler
The Effects of Deforestation on the Water Level of Montgomery County, 10 m.....	H. L. Barr
Methods of Studying Animal Vision, 30 m. (lantern).....	M. E. Haggerty
The Climate of Indiana, 10 m.....	W. A. McBeth
The Lessening of Forest Waste, 20 m.....	S. J. Record
Our Diminishing Wood Industries, 10 m.....	Stanley Coulter
Some Archeological Specimens, 5 m.....	A. J. Bigney
The Archeology of Indiana and Ohio, 10 m (lantern).....	F. W. Gottlieb
Ethnological Researches in the North Land, 15 m. (lantern)	F. W. Gottlieb

PRESIDENT'S ADDRESS.

BY CHARLES REDWAY DRYER.

THE NORTH AMERICA OF TODAY AND TOMORROW AND INDIANA'S PLACE IN IT.

Among the twenty-six presidents who have served the Indiana Academy of Science since its organization, I have the honor to stand today as the first representative of geography. One out of twenty-six is hardly as many as the intrinsic importance of the science might justify, but it is as many as the standing of the subject among scientific men in Indiana calls for. However that may be, this is geography day in our Academy, and I feel like opening it with an invocation to Urania, the muse represented by that noble figure in the gallery of the Vatican, standing alert and at ease, with a globe in her left hand, a stylus in her right, and on her face an expression of dignity, interest and invitation worthy of a schoolma'am about to demonstrate the change of seasons. In view of the infrequency with which geographical topics are discussed before general scientific audiences, and in view of the vestigial and appendicular character of the position which geography generally holds in colleges and universities (where it has any position at all), it would not be out of place to enter upon an exposition of the nature, scope, and content of geography, and its logical place among the sciences. I will content myself, however, with saying that the grandmother of the scientific family, although often assigned the role of Cinderella, is alive, active and fairly keeping pace with the growth of her numerous progeny. Her greatest problems are no longer those of research, but rather those of the organization of the wealth of facts which her children, to the third and fourth generation, are continually pouring into her house. Geography is still a description of the earth; and how much that means now as compared with 400 or 100 years ago! Geography is still the science of distributions; and how the things distributed over the face of the earth do multiply! Geography is still the study of the earth as the home of man, and physiology, medicine, engineering, agriculture, economics and sociology vie with

one another in finding means to make that home more habitable, luxurious and utopian. Geography studies the relationships between the earth and its inhabitants, involved in the influences of natural environment and the reactions of plants, animals and men. Under the quickening power of the doctrine of evolution, biology has gone to studying "the reciprocal relations of organisms and the external world," and geography has been compelled to become a universal ecology. The very latest and happiest statement I have seen is that of Prof. Herbertson, that "geography is fast becoming the scientific study of environments." A distinguished geographer who is also a member of Parliament goes farther and defines geography to be not a science, but a state of mind, a way of looking at things in proper perspective, in relation to the world organism of which they form a part.

And so I have undertaken by way of both exposition and apology to present to the Academy a concrete example of the method and the results of contemporary geographic science, as applied to those regions with which the people of Indiana are most intimately concerned. Geography claims the right of scientific prevision, and therefore my topic is *The North America of Today and Tomorrow, and Indiana's Place in It*.

My theme might be very fully presented by a series of maps, almost unlimited in number, but arranged in a few groups. The first may be called the pedographic (Greek *pedon*, the ground) group, which would display the features of the ground, or substratum upon which plants grow, animals live, and men find their homes and do their work. It would include graphic expressions of the height, depth, outline, relief and structure of the earth crust. A second group would be hydrographic and display the features of the sea of water which acts not only upon the surface of the continent, but stretches through its substance from ocean to ocean. A third group would be climatic, and deal with the dynamic, thermal and hyetal conditions of the atmosphere. A fourth group would be biographic, (in a special sense) showing the distribution of plant and animal life. A fifth group would be economic and would reveal the secrets of household management, by which the human family makes a living, high or low, on this continent. A sixth group would be demographic, showing the distribution of people of all races, colors, languages, clothes, "diseases, accomplishments and sins," and would grade into a final sociologic group dealing with politics, education, art and religion. Of this possible gallery of maps I can display but half a dozen and make them exhibit details, for verbal mention of which time is lacking. The key to my thesis is map No. 4.

which divides North America into natural provinces, in each of which the conditions of environment are broadly uniform. What these conditions are, may be seen by a comparison of No. 4 with Nos. 1, 2 and 3.

North America in its world relations stands among the continents third in area and fourth in population. It is built on the triangular plan, presenting to the Pacific a high and forbidding back, but facing the Atlantic with a low and inviting coast. The body of it is made up of the largest continuous plain in the world, one-third of the continent being less than 660 feet above the sea. Its shores are washed by all the oceans of the northern hemisphere, and it is crossed by all belts of climate (Fig. 2). It contains an assemblage of land forms which include all varieties of structure, relief and mineral products. It would be difficult to name a plant or animal which could not find a congenial home in some part of it. More than half of it lies in those middle latitudes which are most favorable for a high degree of civilization. Its position, extent, character and complexity render it one of the most valuable assets of the human race on this planet. It constitutes by itself a world in which nothing essential for human welfare is lacking.

In the scientific study of environments extremes are the simplest. In provinces controlled by one dominant factor, such as the ocean, heat, cold, aridity or vertical elevation, the outlines of the pictures are clear and bold. Environmental influence and organic reaction, "the reciprocal relations of organisms and the external world," are apparent at a glance and leave little that is elusive or conjectural.

Greenland, the largest of islands, a broken block plateau capped with ice, is an absolute desert except around the margins, where a fringe of barren rock affords a perching place for sea fowls and Eskimos. Around its shores the lithosphere covers the hydrosphere in the form of a shifting crust of pack ice, where the seal, walrus, polar bear, and man live as ice-riding animals. The basis of subsistence is found in the water, which teems with life from microscopic infusoria to whales. Upon these birds and beast subsist, and man upon all of them. Metals are absent and vegetable material is negligible. The kayak, the harpoon pointed with a walrus tusk and tied with a rawhide-line to a bladder float, sealskin clothing, tents and boats, bone sledges, the snow igloo built in an hour and frost and bear proof, the arctic dog sleeping in all weathers with only his tail for a cover, blubber food and fuel, and the skill which men have acquired

in making use of these simple elements to maintain an enduring and cheerful life, form for the geographer one of the most interesting and satisfactory demonstrations in ecology. The Eskimos live upon the edge of things, where the struggle for existence is so nicely balanced that it is easily upset. The interference of the white man and the introduction of the utensils and habits of civilization, instead of improving their condition, is likely to lead to their ultimate extinction. The destruction of the seal and the introduction of coal stoves, baths and bacteria are sufficient to bring irretrievable disaster.

In the "barren grounds" of the arctic tundra the basis of subsistence shifts from sea to land, and the presence of lichens, grass, shrubs, the caribou and the muskox, brings new elements without materially complicating the problem. On the whole the barren land breeds a race of men inferior to those of the ice-covered sea.

In the great Canadian coniferous forest, the caribou plays the leading part, furnishing food, clothing, shelter and utensils, much as the seal does on the ice cap. Native human life is hardly less simple and severe than in the barren grounds. In the forest the snow shoe and the birch bark canoe have evolved as monuments of human skill, comparable to nature's handiwork in the double overcoat of the muskox and the concave spreading hoofs of the caribou. Europeans began 250 years ago to reap the harvest of furs. Trading posts and transportation lines were established all over the province, and every square mile of it has been the scene of the labors of the lonely trapper, greatly to the pecuniary advantage of the Hudson Bay Company, and to the luxury of European society, but with little gain in goods or morals to the Indian and the half-breed. The resources of the province in peltry have been so successfully conserved that the supply, except in the case of some species, such as the beaver, is scarcely diminished. The fur trade has bred men of iron who have spent their strength in getting more furs. An occasional exception, like Lord Strathcona, helps to ennoble the inglorious herd.

The lumberman has cut into the southern fringe of the forest and may be expected to extend his operations as fast as the demand for timber justifies the construction of new railroads. At a few points the lure of gold has led to the irruption of civilization in isolated chunks. The phenomenon of a city like Dawson or Fairbanks, with local railroads, electric lights, telegraphs, newspapers, police and dog sledge mail service.

has appeared almost in a day. Such communities are wholly artificial and precarious, but will probably be repeated many times as the assuredly great mineral wealth of the Laurentian peneplain and the Yukon plateau is prospected and exploited.

The Canadian province will always be a game country, and as it becomes more accessible, its thousands of lakes, streams and wooded islands will acquire new value as ideal play and recreation grounds, where the weary denizens of crowded marts will find a paradise for camping, boating, hunting and fishing, and will revert temporarily to the primitive and simple life.

On the ice cap, in the tundra and in the forest collective economy prevails to the exclusion of all others. Men produce nothing but live by plundering nature of plant, animal or mineral wealth. Yet these resources are subject to some degree of scientific conservation.

We have heard much of the coal, copper, gold and tin of the Alaskan coast province, and they are probably worth looking into. We have also heard marvelous stories of Alaskan agriculture, of the ripening of wheat at Circle City, and of potatoes and other hardy vegetables grown in apparently impossible places. Summer days are long on the Arctic circle, but that the province will never do more than furnish a limited and local supply of agricultural products, and have anything to export except timber, minerals, fish and mosquitoes, are among the certainties of geography. It possesses one literally invaluable asset which can never be exploited, syndicated, monopolized or in anyway diminished, and that is scenery. The combination of sea, mountain, fiord, forest, and glacier is unrivalled in the world. "If you are old," says Mr. Gammett, "go to Alaska; if you are young, postpone your visit, for after Alaska all other scenery is tame."

If our study of environments proceeds from the simple to the complex, the Arizonan, the "dry belt" province, stands next. The rainfall ranging from two inches to fifteen is so irregular in successive years and the evaporation so enormous that Arizona, Utah, Nevada, Sonora and southern and lower California constitute a desert area, saved from extreme Saharan conditions by the fact that there are two less dry seasons each year. The peculiar forms of desert relief and xerophilous flora were shown to the Academy by Dr. McDougal a year ago. Animal forms, being less plastic, are less peculiar and bizarre, but exhibit corresponding adaptation of habit. Among the extreme products of desert environment are

the Grand Cañon of the Colorado, the barrel cactus, animals that never taste water and do not know how to drink, men who can run 800 miles in five days, and the peaceful Pueblos, where men without guile, vice or crime, plead with the Great Father at Washington to be let alone, and to have the Yankee school teachers removed.

The desert is crossed by rivers fed by mountain snows, and supplying water enough to irrigate some portion of the area less than two per cent. Agricultural islands are springing up in the desert sea where seven crops a year are harvested, each acre supports one person, and wealth is assessed not so much by acres of land as by acre-feet of water. The lower Colorado valley will become a little Egypt without the pyramids. Mining camps will spring up and maintain their high pressure, uncertain existence, fed by automobiles instead of camel caravans. They will live their day and disappear, and the desert will remain the desert, with all its highest values untouched, its healthful climate, its inspiring scenery, and the lessons which the geographer, geologist, biologist, and artist may learn there.

The Mexican plateau, a bit of the tropics lifted into a temperate and semi-arid atmosphere, is the environment in which the American Indian, on a maize basis, without iron or domestic animals, attained his highest indigenous civilization. Perhaps for that reason the hand of the Spaniard was not wholly destructive, and a blending of European and American civilizations occurred. Of 15,000,000 people 80 per cent. are of Indian blood and more than half of those without a stain of white. With all his faults, the Mexican peon is not lazy or vicious, and remains now, as of old, the pure American at his best. Mexico is the land of cactus and agave, of tortillas and frijoles, of chili and pulque, of silver and manpower, of cockfights and revolutions, of opportunity and mañana, out of which a stable and prosperous civilization, more promising than that of Old Spain, seems to be rising as rapidly as tropical nature and human nature will permit.

The Caribbean province lies in the equatorial zone of volcanoes, earthquakes, perennial heat, heavy rainfall and tropical forest. These conditions attain their extremes for the continent in Central America, where 1,500,000 Indians, negroes, and mestizos are leavened with less than one per cent. of pure European stock. The natural and human conditions are less favorable than on the Mexican plateau. The most momentous things in the province just now are the Tehuantepec railway and the Panama

Canal. The Mexicans have bettered Captain Eads' scheme for a ship railway by constructing a first-class trunk line 192 miles long, with a summit level below 700 feet, and adequate harbor works at each end. The traffic amounted the first year to \$38,000,000. This route between Atlantic and Pacific ports is 1,000 to 1,500 miles and four to six days shorter than the Panama route, and in competition with it can hold mail, passenger and fast freight transit.

Concerning the consequences to follow from the opening of the Panama canal, no one can predict with assurance. Whether it is a great big bluff put up by the United States in response to the world's dare, and will be of value chiefly as a means of doubling the effective strength of our navy, or whether it will transform seaports and routes of trade between Europe, Asia and America, and even knock down transcontinental freight rates, remains to be seen. In either event, it will prove well worth doing. It is eminently fitting that the Great Republic should make real the dream of centuries, and should overcome the greatest natural obstacle to commercial progress that the world presents. The enterprise is more commendable and beneficent than the Crusades. Its execution is a victory of peace, surpassing in discipline, mastery of engineering and sanitary skill the achievements of Japan in war. The completion of the canal will make the Caribbean truly the American Mediterranean.

In the West Indies the negro peoples are the most interesting. They number 2,500,000 and constitute nearly the whole population of Haiti, Jamaica and Barbados. Here the negro has had the longest time and the best opportunity to show in a congenial environment his capacity for civilization. The results under self-guidance in the black republics of Haiti and Santo Domingo are scarcely better than those in central Africa. In Jamaica and Barbados, the British Empire has no more orderly, industrious, intelligent, and loyal subjects than the colored people, a large majority of whom are members of the church of England. The Caribbean province has an area about six times that of Java and one-third as many people. If it were as efficiently manned and managed as Java, it could supply the continent with all tropical products, including rubber, coffee, sugar, cocoa, fruit and spices. Who will man and manage it?

Thus far I have tried to characterize briefly the provinces of extremes, those which may be called cold and dry, cold and wet, hot and dry or hot and wet. I now come to those medial provinces which are called temperate, but are in a sense the most intemperate of all. The climatic

map (Fig. 2) shows that the isotherms of 70 degrees for July and of 50 degrees for January cross near San Francisco and spread widely apart, bounding a belt which belongs to the torrid zone in summer and the frigid zone in winter. The climate is best characterized as intemperate, having an annual range of 40 to 60 degrees. Maximum temperatures of 110 degrees and minimum of -50 degrees are not unusual. The belt is swept by a procession of cyclones and anticyclones which bring rapid changes from cool and dry to warm and wet and vice versa, two or three times a week. The weather is perhaps the most variable and uncompromising in the world. Cold waves and hot waves intensify the seasons and give everybody something to talk and read about. The atmosphere furnishes a perpetual turkish bath, running the gamut from hot to cold and cold to hot in the most stimulating and irritating manner. Our European friends say that American hustle and restlessness and the strained expression on our faces are due to the uncertainty and intensity of American weather.

The eastern half of the intemperate belt is saved from aridity by cyclonic winds from the gulf and Atlantic, which carry a rainfall of 20 or more inches to Hudson Bay. The western half catches its moisture as catch can and puts up with the dribblets left from the load dropped on the eastern plains or the western mountains. The line near the 100th meridian where the 20-inch isohyet and the 2,000 foot isohyps coincide is one of the most strongly marked natural boundaries in the world. It is the western limit of forest, prairie, agriculture without irrigation and dense population. The medial belt of North America is divided into three pairs of provinces, the Pacific, Interior, and Atlantic. The simplest is the Interior, including the Arizonan, already noticed.

The Interior province is composed of two plateaus separated by the broad system of the Rocky mountains. There is not a square mile in it below 2,000 except in the lower Columbia valley, and most of it lies above all but the summits of the Appalachians. On the west the smaller Columbia plateau is a frozen sea of lava, trenched by the Snake and Columbia rivers in gloomy cañons. Most of the scant rainfall sinks into the crevices to reappear along the cañon walls in voluminous springs. The dominant plant formation is sagebrush, which is neither grass nor shrub nor tree, but just artemesia. The eastern plateau, commonly known as the Great Plains, but better characterized as the High Plains, is nearly 2,000 miles long and 300 to 500 miles wide. It is broken here and there by

islanded uplifts of ingenious intrusion, such as the Black Hills, and carved into the fantastic forms of the Bad Lands; but over much of it the landscape has no feature but the bounding curve of the horizon. Overloaded and dwindling rivers from the mountains wind across it in tortuous or braided channels. It is semi-arid steppe, a transition between forest and prairie on the one hand and desert on the other. It is the domain of bunch grass, fitted by nature for the home of nomad herdsman.

The first chapter in the eventful geography of the steppe is concerned with the buffalo and the plains Indian. You know the story of the millions of "humpbacked cattle" and the thousands of fierce and restless red men who lived upon their tongues and hides, and with an economic basis and an energy that might have made them masters of the continent, expended both in killing one another. The white men brought them horses, firearms, firewater and smallpox, a combination which probably shortened their career.

The first serious invasion of the country was that of the cattle kings and cowboys from the south, who drove their herds over "the long trail," and inaugurated the strange, brief, pastoral episode of the steppe. The conflict between the Indian and the cowboy raged for a decade with no decisive results until the prairie schooners of the Mormons, Oregon emigrants, and gold seekers bound for California and Pikes Peak, brought new elements to turn the scale. For another decade the life of the steppe was a chaotic welter of Indian, cowboy, emigrant, miner, hunter, freighter, coach driver, pony express rider, outlaw, soldier and engineer, which lives in literature and fascinates young and old as the most adventurous and romantic chapter in American history. The civil war demonstrated by how slender a thread the Pacific States were bound to the Union and spurred Congress to tie them with iron bands. The completion of the Union and Central Pacific lines in 1869 insured the speedy extermination of the buffalo, the suppression of the Indian raider and the dawn of an era of law, order, and peace.

The Indian dozes on his reservation or works on irrigation dams, the open range has gone, cowboy life has become tame ranching, irrigation and dry farming are displacing bunch grass with alfalfa, kafir corn and durum wheat. Through all the shifting scenes in the strange drama of the steppe, aridity has been stage manager and will remain so to the end.

The Pacific provinces are but a narrow fringe hemmed in between the sea and the mountains beyond which desert and steppe begin abruptly.

California has the only bit of truly temperate climate where the monthly temperatures are always between 50 degrees and 70 degrees on the continent. The long, dry summer and mild, moist winter invite to a free, outdoor life, where men may take long breaths and live close to nature. Dr. Jordan claims for California three most valuable assets, climate, scenery and freedom, and the claim may be allowed in full, and to its items may be added Stanford University and San Francisco Bay. The Oregon province differs from the Californian chiefly in having more rain, cloud and fog. Here the coniferous forest reaches probably its highest floristic and economic development. Fruit trees and vines are so luxuriant and prolific that an astute, though amateur scientist, conjectured the presence of more radium than the average in the soil. Here the Columbia river makes the only complete gap in the mountain barrier between the tropic and the arctic circle. Here also the Strait of Fuca and Puget Sound break 200 miles inland. In the eyes of the geographer the better part of the Pacific provinces is water. The productive area is small, the great valley of California being about the size of Indiana. The land is narrow and rough and has no hinterland, but it forms a sufficient base for sea-power on the Pacific and a strong but gentle grasp upon the Orient.

And thus by a roundabout road I come finally to the core of the continent, the part of North America that really counts, around which the other provinces stand as natural and economic tributary vassals. The Atlantic provinces between the Laurentian heights and the gulf of Mexico, between the sea and the critical line of the 100th meridian stand out boldly on every map. The area of the two is nearly 2,000,000 square miles, or one-fifth of North America, and is half as large as Europe. The population is about 90,000,000 or 70 per cent. of the total of North America.

This region is the most densely populated large area in the western hemisphere and the most important center of civilization outside of Europe. This preëminence is due to many causes, geographical and historical.

(1) *Position.* It lies on the west side of the North Atlantic ocean and north of the American Mediterranean. The long, low coastline, with many drowned valleys, and the number of navigable waterways which penetrate the interior render it easily accessible by water from the better half of the world.

(2) *Structure and Relief.* While its relief is sufficiently varied, not more than a tenth of it is too rugged for cultivation. Four-fifths of it is a smooth plain below 2,000 feet in elevation, almost everywhere arable

and traversible by roads and waterways. Its crust includes the most valuable coal, petroleum and iron fields yet developed in the world. Two-fifths of its area is covered with the best of glacial soils.

(3) *Climate.* It lies in that part of the so-called temperate zone where the summers are long and warm enough to ripen the cereal grains, and the rainfall in the growing season is everywhere sufficient for agriculture.

(4) *Vegetation.* The natural vegetation includes large areas of coniferous and summer forests and prairie. The summer forests are easily converted by clearing into grass and agricultural lands.

(5) *People.* The bulk of population is of Baltic Caucasian stock, which the presence of negroes, and the recent influx of Alpine and Mediterranean immigrants, have not yet notably modified. In race and culture the region is an oversea colony of western and central Europe.

Here then we have an environment with influences and reactions sufficiently complex to task the powers of the most accomplished scientific geographer. I cannot in a part of an hour undertake to do it justice and shall attempt only to touch upon a few points. I can sum up its economics in a brief table.

LEADING PRODUCTS OF THE ATLANTIC PROVINCES OF NORTH AMERICA.

	North America.	World.
	Per cent.	Per cent.
Corn	99	80
Wheat	86	21
Oats	90	
Barley	75	
Rye	94	
Potatoes	79	
Cotton	98	62
Tobacco	70	32
Rice	91	
Coal	90	40
Iron Ore	98	40
Petroleum	70	46
Natural Gas	98	
Foreign Commerce	80	12
Population	70	5.6

The total value of its agricultural products in one year approaches nine billion dollars, a sum which Secretary Wilson says nothing short of omniscience can grasp. The net value of manufactured products is well over ten billion dollars. However approximate these figures may be, they show the order of the magnitudes.

When goods are produced in such quantities, the circulation of products and people must be on a corresponding scale. In the way of this, the Appalachian highland offers the only barrier. This is broken through by two gateways, the St. Lawrence and the Mohawk-Hudson valleys.

The gap of the Laurentian lakes and river plays the part of the Baltic sea in Europe. It lets tide and shipping 900 miles inland to Montreal, and smaller vessels penetrate to the head of Lake Superior, 2,000 miles by water and 1,000 miles in a direct line from the sea. Modern improvements have made this the greatest commercial waterway of the world, next to the North Atlantic ocean. The total tonnage passing through the "Soo" canals in one season of less than eight months is about 60,000,000 tons, or more than four times that of the Suez Canal, and equal to the combined tonnage of New York, London and Liverpool. The total traffic of the upper lakes through the Detroit River amounts to 70,000,000 tons.

The Mohawk-Hudson gap is even a more important gateway of the continent than the lower St. Lawrence. The New York barge canal now under construction may be regarded as a half-way measure toward a future ship canal at least 24 feet deep.

Time is lacking to discuss the waterways of the Mississippi system. Improvements will be made, but the complete control and utilization of the Mississippi is a larger proposition than mankind has yet anywhere attempted, and may prove too costly for even the richest country in the world to accomplish. I venture only to mention as probable future waterways of considerable magnitude: Lake Erie to Lake Ontario, Buffalo to Troy, Georgian Bay to Montreal, Cleveland to Pittsburgh and Cairo, Chicago to New Orleans, Kansas City to St. Louis, Winnipeg to Lake Superior. The strategic points on the seaboard are Montreal, New York and New Orleans. Among those inland, Buffalo, Cleveland, Pittsburgh, Detroit, Chicago, St. Louis and Winnipeg are plainly conspicuous. I want to call especial attention to Winnipeg. It stands in the wasp-waist of Canada, through which all currents must pass. If I were a capitalist I would look for investments in Winnipeg.

New York already looms up as one of the modern wonders, with a reasonable prospect of becoming within twenty years the metropolis and financial center of the world. The vision of a city of ten or twenty million people appalls the imagination. The growth of the seaboard, Cleveland-Pittsburgh, and Chicago manufacturing districts sustains the prophecy of H. G. Wells that there will ultimately be a continuous urban industrial district, extending from Boston, New York, and Philadelphia to Chicago and St. Louis, with various outliers along the Mississippi.

For the general map of future economies or use of land, Fig. 6, we are indebted to Raphael Zon of the U. S. Forest Service. (Circular 159.)

The question of future population is not only a fascinating subject of speculation, but a serious practical problem of vital importance to all students of the conservation of natural resources. It is not at all a question of space. If all the people in the world could be herded in Texas, every man, woman and child could have a domain 70 feet square, equal to an ordinary city lot. Even in Rhode Island they could stand in rows 4 feet 6 inches apart both ways. The population which any region can support is fixed, according to Dr. McGee, not by land area or limitation of atmospheric nitrogen, but by water supply, a proposition sustained by a comparison of the rainfall and population maps, which might almost serve one in place of the other.

He calculates that the "duty of water" in relation to human population is "the maintenance of one human life a year for each five acre feet used effectively in agriculture." The annual rainfall of the United States is five billion acre-feet; therefore the capacity of the United States for population is limited to one billion, giving a density about half that of Belgium, a figure which may be reached in less than three centuries. Several statisticians, calculating from known rates of increase, place the population of the United States in the year 2000 at 250 to 350 millions.

Even more momentous than the question, How many? is the question What shall we be? In 1830 the people of the United State and Canada numbered about 14,000,000 and were, except the French on the lower St. Lawrence, of almost pure British stock. Shortly after 1830 immigration began on a large scale, and with some fluctuation has increased until the present, when in some years a million aliens land upon American shores. The total number amounts to about 28,000,000, of which 90 per cent. have come from Europe. Previous to 1890, 75 per cent. of them were Baltic

and Teutonic people. Since 1890, 60 per cent. have been Alpine and Mediterranean people. This influx of people who differ widely from the original stock in temperament, habits, language, and religion, makes the problem of assimilation and blending a serious one. The most efficient agent of Americanization is the public school, where the children learn the English language, absorb American ideas, and undergo a change even in head form. The Alpine people are noted for their domestic virtues and devotion to family, divorce being almost unknown among them. The Italians have a native talent for art and music. These are qualities in which the typical American is often lacking, and desirable contributions to the society of the future.

A rapidly developing country like ours has an almost unlimited capacity to absorb and use labor supply, and there is no indication of a surplus. The number of colored people in proportion to the total population is decreasing, and it is possible that in time even the "black belt" will fade out. At the twelfth United States census the native whites of native parents formed a small majority, the foreign whites and native whites of foreign parents a little over one-third. The tardy returns of the thirteenth census will probably reverse these proportions. The United States is the melting pot of the nations.

The relative and absolute decrease of the rural population, the increase of foreign born, the relative decrease of food supply, the approaching limit of food production under the present systems of agriculture, the steady rise in prices, all indicate that the days of plenty and profusion are passing, and that the American standard of living must decline toward the European standard.

In Canada, with a population of about 7,000,000, mostly in southern Ontario and Quebec, there are too many unknown factors to make prediction justifiable. The greatness of Canada is chiefly visionary. Their official literature gives one the impression that they have learned the art of boom and brag until they can go us one better in claiming everything in sight and more beyond the horizon. In calculating such big round figures as I have given for the Atlantic provinces, in most cases Canada is almost negligible. Dreams of a large agricultural population on the Peace River in latitude 60° and on the "clay belt" around James Bay seem to have the same kind of a basis as that of a railroad to Hudson Bay and regular lines of steamers from Churchill to Liverpool. The geographic

probabilities are that Canada's most valuable assets lie in the great forest, and the unknown mineral wealth of the Laurentian peneplain.

Standing upon the broad principle postulated by Geddes, that "geography in the long run disposes," geographers should not hesitate to express the general trend of geographic influences. While taking into account the contravention and annulment of these influences by historical, racial, social, political and even personal forces, they are disposed to regard apparent violations of geographic laws as local and temporary, or as manifestations of some higher law. Jefferson was a geographer as well as a statesman when he prophesied that the Mississippi basin "will ere long yield more than half of our whole produce and contain more than half of our inhabitants," and declared that any foreign possessor of the mouth of the Mississippi is "our natural and habitual enemy." Lincoln and the loyal people of the north were geographers when they maintained that a separation of the northern and southern States would be a calamity to both.

The Canadian election is over, and we know what our next door neighbor thinks of us. Nevertheless I venture to predict that the two nations will ultimately become one. Annexation of the United States to Canada might be preferable to the inverse process; but geographic influences of maximum intensity crowd the two peoples together with the persistent pressure of gravitation. "No sane man," says Prof. Grant of Kingston University, "would, if asked to divide North America into three nations, draw the present boundary line between Canada and the United States."

The habitable area of Canada consists of a strip 4,000 miles long and 200 to 400 miles wide, almost cut into three fragments by the northward projections of Maine and Lake Superior. The provinces are held together like beads on a string by the Canadian Pacific Railway. Is it not probable that the enormous mass of wealth and kindred population on one side of the most unscientific boundary in the world will in time attract and dominate the economics and politics of our northern neighbors, and Canada be peacefully absorbed by economic rather than by diplomatic or military conquest?

The scientific frontier along which a geographer would divide the continent is, of course, the crest of the Rocky Mountains. That is the natural line of cleavage, but the Pacific States of America, as a world power, would incur the danger as well as enjoy the strength of their position. If there are ever as many people and as much wealth between Los Angeles

and Prince Rupert as between Chesapeake Bay and the Gulf of St. Lawrence, it will be when San Francisco is the capital of Japanese or Chinese America.

Whatever may be the changes and chances of the coming centuries, ours is a big country. We are not to blame for its bigness, and we must accept its awkward bulk and make the best of it. To live in a large country requires large mindedness. The American people have fallen heir to the largest fortune in natural resources and virgin lands that ever came to any people in the world's history. It is an opportunity larger than can ever come again on this planet. Every influence tends to foster in us a spirit of extravagance and arrogance. If we can survive the period of adolescent exultation and riot, and with spirit undimmed and powers intact, attain a sober and dignified maturity, all geographic influences conspire to make the Atlantic provinces of North America the home of a people united in blood, spirit, economics, government, institutions and civilization, equal in number to the population of Europe, and to make that people not only dominant in North America but able to divide with Europe the hegemony in the confederation of the world.

Let me cap my climax with the words of a French sociologist, Edmond Desmolins, who places in the United States and Canada the home *par excellence* of the development of the particularist social formation, where the Baltic and Teutonic peoples, expanding upon new and vacant lands, are able not only to develop freely, normally and without foreign influence, but also to acquire an ever increasing personal initiative. "By the processes of private life alone," he says, "they have established and will maintain parliaments, self-government and the predominance of the individual over the State. They absorb, assimilate or eliminate numerous and diverse elements from the old world. They are a society of intense life, of individual energy and aptitude for progress raised to their maximum. They are the society of the future."

And what of Indiana? The prepotent geographic quality of Indiana is its centrality. It is not in the center of North America, but near the center of its richest province. We, here at Indianapolis, are nearly midway between the critical line of the 100th meridian and the Atlantic coast, between the Laurentian peneplain and the gulf coastal plain, between the Appalachians and the Mississippi, between Lake Michigan and the Ohio, between the July isotherm of 70° and the January isotherm of 50°, be-

tween the isohyet of 20 inches and that of 60 inches, between the isopleth of 250 and that of 8. Indiana sits astride the Cincinnati arch with one foot over the edge of the interior coal field and the other on the oil and gas belts, and astride the boundary of glacial drift and the boundary between summer forest and prairie, with the balance on the right side in both cases. No State hits more exactly the golden mean. Its position makes it, like France, a "bridgeland" between north and south, east and west. It has been happily called the "midland gap" traversed by many lines of human interest. The mid-parallel of the United States, the 39th, triangulated and leveled by the geodetic survey, crosses it. The centers of cereal production and farm values have crossed it into Illinois. The center of manufactures is in Ohio headed this way. The center of population has been stuck in Indiana for twenty years and is likely to stay here indefinitely. The National Road, the Wabash and Erie canal and a score of east-west trunk-lines cross it, and ship canals both ways are more than possibilities. Everything comes our way because it must. The happy mean involves an absence of startling extremes. Few superlatives can be applied to Indiana, but it is not therefore commonplace. Its central position implies a moderate variety and complexity. In Indiana cold waves are not too cold, hot waves are not too hot, and tornadoes are not very frequent; yet the climate is by no means monotonous or enervating. There are no volcanoes, geysers, earthquakes or glaciers, but the moraines and lakes of the north and the hills, knobs, bluffs and caves of the south provide a pleasing variety of landscape beloved by the artist. The strongest contrasts in Indiana are between north and south separated approximately by the boundary of the Wisconsin drift, which also is or was the color line, the mule-horse line, the neckyoke and chain-trace line, the corn-shuck and corn-husk line, the tinpail-bucket line, the "thataway" line and the "right smart" line. In the north the winters are severe enough to compel a proper degree of foresight and care. In the south a family might live as Thomas Lincoln's did, with only a blanket for a door to the cabin. In the days of slavery Indiana was the right of way of the underground railroad, and during the Civil War no northern State was more evenly balanced in its sympathies. In party politics no presidential candidate can count upon it with assurance. Many great men start or stop in Indiana; not so many stay there. To trace the environmental influences which have given rise to a banner crop of oratory, poetry, fiction and humor

would be a fascinating problem, but something must be left for my colleagues who are to follow on this program. Indiana is too much in the way to be isolated, antiquated or one-sided, yet not in danger of being swamped by foreign elements. If it should ever cease to be the home of a prosperous community of enlightened and happy people the event will not be due to adverse geographic position or environment.

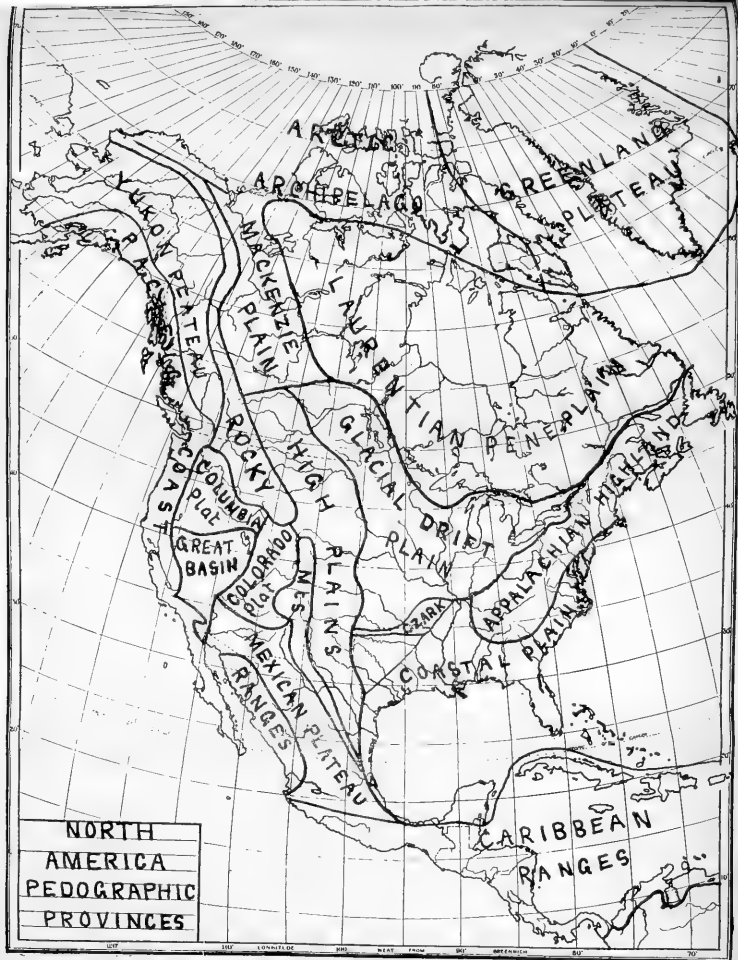

Fig. 1.



Fig. 2

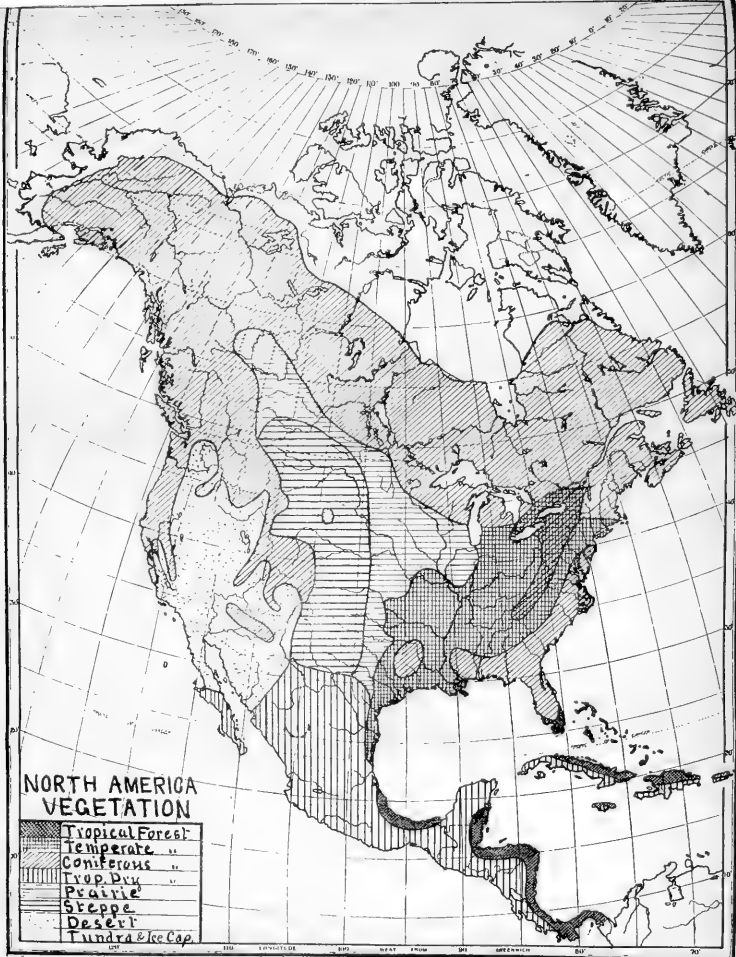

Fig. 3



Fig. 4.



Fig. 5.



Fig. 6

CHEMICAL NOTES ON VENTILATION.

BY PERCY NORTON EVANS.

What is the direct cause of the enervating and injurious effect of poor ventilation on the human system is still uncertain. The old theory that it is due to increased carbon dioxide and decreased oxygen in respired air seems quite inadequate in view of the smallness of the actual difference between ordinary poor air and fresh air; to be sure the carbon dioxide may be increased many times, but it is not poisonous, and experiments have shown that equal quantities added to air by purely chemical means have no such marked physiological effects; and the concentration of oxygen is altered to a scarcely appreciable extent in any case of ordinary poor ventilation.

It is held by some that definite toxic substances are exhaled in respiration, and that these, rather than the alteration in the proportions of inorganic constituents of the air, are responsible for the undesirable effects. Exhalations from the skin have also been considered of importance, and this hypothesis receives some measure of confirmation from the very noticeable difference in the intensity of the effect of a well-washed and a not-well-washed crowd in a poorly ventilated assembly room, the respiration products being the same in both cases presumably. Again, some claim that the excessive moisture is an important factor, but this seems an insufficient explanation, for the air of badly ventilated buildings in cold weather contains nothing like the amount of moisture present in fresh air in warm, damp weather.

Whatever the cause or causes—and they may be many—of the evil effects of poor ventilation, it is surely true that anything that tends to carry away the air that has been exhaled or in contact with the person and replace it by fresh air, must be beneficial.

Elaborate provision is often made to insure by mechanical means this movement of air. As will be shown, something can also be done by automatic physical means to bring about the same result, and where mechanical means are employed they should for economy and efficiency operate in such a direction as to assist rather than oppose the natural automatic movement.

It was formerly thought that foul air, that is air that has been breathed, was more dense than fresh air, because part of the oxygen of the latter is replaced by carbon dioxide in the lungs, and carbon dioxide is denser than oxygen, and consequently that expired air tended to fall and foul air to accumulate at the floor of a room, so that for the best results the removal of air should be from near the floor. This reasoning overlooked the fact that oxygen is also replaced by water vapor in the lungs, and water vapor is lighter than oxygen; also that the expired air is at a higher temperature than the air of the room and on this account less dense. This error is no longer generally made in the discussion of the principles although often in practice. As will be shown, expired air is actually lighter than fresh air under ordinary ventilation conditions, and therefore tends to rise and accumulate near the ceiling. This is assisted by the natural upward movement of air in a building warmer than its surroundings, as in a flue, and further by upward currents in the neighborhood of any body warmer than its immediate surroundings, such as a stove, a burning lamp or gas jet or electric light, or even the body of a person. That foul air tends to accumulate near the ceiling is very evident to those occupying the gallery of a crowded auditorium.

An experiment to test this upward movement of respired air was made by the writer in a class room about 27 by 30 feet and 16 feet high. The room temperature was 24° C. (75° F.), and the outdoor temperature 10° C. (50° F.); the moisture in the air of the room as shown by a *Mitt-hof* hygrometer was between 50 and 60 per cent. of saturation. The windows and door and a ventilator were closed during the period of experiment and the only source of artificial heat in the room was a vertical steam pipe, the radiator being shut off by the automatic thermostat.

The room was occupied by 26 adults for 50 minutes and was then unoccupied for 10 minutes immediately before the period of experiment, which also lasted 50 minutes, 36 adults being present, seated.

Carbon dioxide was determined in the air with a *Lunge* air tester, samples being taken alternately from within 6 inches of the ceiling and the floor, through tubes, and analyzed on a table, near the center of the room. The analytical method consisted in forcing the air through a standard solution of sodium carbonate colored pink with phenolphthalein, by squeezing a rubber bulb until the pink color disappeared, the number of squeezes being counted, and ranging in this experiment from 8 to 5, fresh outdoor air requiring 48 squeezes with the apparatus used.

The results for the successive samples from near the ceiling were 14.5, 16.0, 18.0, and 21.0 parts of carbon dioxide in 10,000 parts of air by volume; near the floor the figure obtained was 14.5 in 3 successive samples. Moisture readings with the hygrometer showed an increase from 52 to 58 per cent. of saturation during the experiment near the ceiling, and from 55 to 58 below the table—a greater increase near the ceiling. These results show that the respiration products, carbon dioxide and moisture, move upwards under these conditions.

The influence of the temperature and moistness of the air of the room on the upward movement of expired air will be shown in what follows.

The temperature of the exhaled air is necessarily body temperature, 37° C. (98.6° F.); that of the surrounding air of the room can be controlled in an artificially heated building, and since cold air is denser than warm air the lower the room temperature the greater will be the difference in density between it and the exhaled air, and the greater the tendency of the latter to rise and be automatically removed from the respiration level. Failure to take advantage of this principle probably accounts in part at least for the enervating and depressing effects of overheated rooms in our homes, schools, offices, public buildings, and, worst of all, our hotels. The usual temperature aimed at in this part of the country is well up in the seventies—a very mistaken form of luxury; it should be at least ten degrees lower, and sensible habits in clothing, especially on the part of fashionable women, would soon remove the apparent hardship. The accepted temperature for school rooms in England is said to be 58° F., and the standard temperature of the room generally accepted in European scientific work is 15° or 15.5° C. (59° or 60° F.).

The moisture factor is similar to the temperature factor in its effect and to a less degree in its control. The exhaled air is always saturated with moisture, the air of the room if at a higher temperature than out of doors is not saturated unless moisture is added to it after entering the building, and in frosty weather is commonly not over one-fifth saturated. Since, as already stated, water vapor is lighter than air, and since it displaces an equal volume of air, the less moisture there is in the air of the room the greater will be the tendency of the expired air to rise. There may be other reasons against having very dry air in buildings, such as irritation of the nose and throat, though this objection is at present debatable and not in agreement with the generally recognized benefits of

breathing fresh air even at low temperatures; also there may be injury to furniture and wood-work, but from our present standpoint the drier the room air the better. In harmony with this is the very noticeably depressing effect of a very moist atmosphere.

Let us now consider the numerical values concerned in these densities under ordinary conditions.

Accepting Halliburton's values for the composition of fresh air and expired air both in the dry condition,

Fresh air—

Oxygen	20.96 per cent. by volume
Nitrogen	79.00 per cent. by volume
Carbon dioxide	0.04 per cent. by volume

Expired air—

Oxygen	16.12 per cent. by volume
Nitrogen	79.45 per cent. by volume
Carbon dioxide	4.43 per cent. by volume

the densities, compared with hydrogen at the same temperature and pressure, are

$$\text{Fresh air: } \left(\frac{20.96}{100} \times \frac{16}{1} \right) + \left(\frac{79.00}{100} \times \frac{14}{1} \right) + \left(\frac{0.04}{100} \times \frac{22}{1} \right) = 14.42$$

$$\text{Expired air: } \left(\frac{16.12}{100} \times \frac{16}{1} \right) + \left(\frac{79.45}{100} \times \frac{14}{1} \right) + \left(\frac{4.43}{100} \times \frac{22}{1} \right) = 14.68$$

Considering now the effect of moisture on the density of expired air, the tension of aqueous vapor, or vapor pressure of water, is 47 millimeters of mercury at 37° C. (98.6° F.), therefore any gas saturated with water vapor at this temperature consists of $\frac{47}{760} \times \frac{100}{1}$ or 6.2 per cent. water vapor and 100 - 6.2 or 93.8 per cent. by volume of all other constituents together. The composition of expired air saturated with moisture at body temperature is therefore

Oxygen	16.12 × .938, or 15.12 per cent. by volume
Nitrogen	79.45 × .938, or 74.52 per cent. by volume
Carbon dioxide	4.43 × .938, or 4.16 per cent. by volume
Water vapor	6.20 per cent. by volume

The density of this mixture compared with hydrogen at the same temperature and pressure, calculated as before, the density of water vapor being 9, is 14.33.

Comparing then the densities of dry fresh air and expired air saturated with moisture, both at 37° C. (98.6° F.), we find them to be 14.42 and 14.33 respectively, the addition of the moisture having a greater effect in decreasing the density than the replacement of part of the oxygen by carbon dioxide in increasing it, if the inspired air is dry.

Taking into account such differences in temperature as are likely to occur between the inspired and the expired air, we find that since the density of any gas or mixture of gases is proportional to the absolute temperature, a density of 14.42 for dry fresh air at 37° C., or 310° absolute, becomes at 20° C., or 293° absolute, $\left(\frac{14.42}{1} \times \frac{310}{293}\right)$ or 15.26, so that the relative densities of dry fresh air at 20° C. (68° F.), and ordinary exhaled air (at 37° C.), are 15.26 and 14.42. The difference between these figures, which is favorable to the automatic removal of respiration products from the level of respiration, decreases with any increase in temperature of the fresh air. A density of 14.42 at 37° C. becomes 14.33 at 39° C., for $\left(\frac{14.42}{14.33} \times \frac{310}{1}\right)$ or 312° absolute is 39° C.; therefore dry fresh air would have at 39° C. (102° F.), the same density as ordinary expired air (saturated with moisture and at 37° C.), and at 39° C. the automatic upward removal of respiration products due to difference in density ceases.

Having considered the case of perfectly dry fresh air, let us take the other extreme of fresh air saturated with moisture at certain temperatures. The tension of aqueous vapor at 30° and 35° C. is respectively 32 and 42 millimeters of mercury, so, by reasoning similar to that on page 58, the composition of fresh air saturated with moisture at these temperatures is

At 30° C.—

Oxygen	20.96 × .958, or 20.08 per cent. by volume
Nitrogen	79.00 × .958, or 75.68 per cent. by volume
Carbon dioxide	0.04 × .958, or 0.04 per cent. by volume
Water vapor	4.20 per cent. by volume

At 35° C.—

Oxygen	20.96 × .945, or 19.81 per cent. by volume
Nitrogen	79.00 × .945, or 74.65 per cent. by volume
Carbon dioxide	0.04 × .945, or 0.04 per cent. by volume
Water vapor	5.50 per cent. by volume

The densities of these mixtures compared with hydrogen at the same temperature, say 37° C., are respectively 14.20 and 14.11, calculated as before, while ordinary exhaled air has the density 14.33 compared with the same standard (hydrogen at 37° C.). Imagining these mixtures cooled down to 30° and 35° C., respectively, their densities become 14.53 and 14.20, calculated as before from the absolute temperatures. By interpolation we find that if densities 14.53 and 14.20 correspond to temperatures 30° and 35° C., 14.33 corresponds to approximately 33° C.; therefore if fresh air is saturated with moisture it has at about 33° C. the same density as ordinary exhaled air (saturated with moisture and at 37° C.), therefore at 33° C. (91° F.) the useful upward movement of expired air ceases if the surrounding air is saturated with moisture.

A certain temperature between 33° and 39° C. corresponds to each degree of saturation with moisture.

It has been shown that under all ordinary conditions of ventilation the products of respiration move upwards; that this upward movement, by which the harmful products are removed from the level of respiration, is assisted by a low room temperature, and by dryness of the air of the room; also, that the fresh air has the same density as expired air (saturated with moisture and at body temperature) at 33° C. or 91° F. if the fresh air is saturated with moisture, at 39° C. or 102° F. if perfectly dry, and at temperatures intermediate between these with different degrees of moistness.

*Purdue University,
LaFayette, Indiana,
November, 1911.*

AN INDIANA SHELL MOUND.

BY W. S. BLATCHLEY.

Some six or seven years ago while looking up the road materials of Martin County, Indiana, I noted on the northwest quarter of section 36 (3 N.—4 W.) of an old county map which I had in hand the words "shell mound." I asked my companion, a resident of the town of Shoals, if there was a mound at the place so marked. He did not know but proposed that we drive out and ascertain. As our afternoon's work took us near the place, on returning we drove in a gateway and along a private road which followed the bank of White River for half a mile or more. While so doing we met the owner of the land, one Thomas Ghormley of Shoals, who returned with us and led us to the site of the so-called mound. It was on the crest of a sandstone bluff on the south side of White River and one hundred and twenty feet above the water. Here, on a level tract of several acres, the surface nearest the brink of the bluff was a few feet higher than that back of it and through the soil was here and there protruding a broken shell of a *Unio* or fresh water mussel. One or two small openings had been made by some superficial investigator which showed the shells to be closely massed a foot or so below the surface. Having no tools for digging I at that time made no farther observations, but resolved to return for a thorough investigation.

The next summer, accompanied by James Epperson, State Mine Inspector, I spent two days at the place and found it to be an extensive kitchen-midden or refuse heap of some ancient race. They probably had their village site on the level tract to the south or back of the shell heap and had dumped the shells, after the animals had been extracted, on the edge of the bluff. The area covered by the shells and other remains was found to be one hundred and seventy-feet in length from east to west by sixty-five feet in width from north to south, the edge nearest the bluff being curved or in a half circle. Over most of that area the shells were from three and a half to four and a half feet in thickness and covered with one to one and a half feet of sod and soil, through which in many places the shell fragments had worked to the surface. At several points

on the slopes there was found to be a layer of shells, then a layer of several inches of soil, followed by another layer of shells, this indicating an irregularity of dumping, brought about perhaps by the village site being vacated at intervals. In the thickest portion of the heap the shells were occasionally mixed with much humus, but for the most part they were nearly clean, appearing as if but recently dumped, though rapidly disintegrating when exposed. They represented the more common species of mussels now occurring in the river, but were mostly of small size. Among those noted were *Unio triangularis*, *luteolus*, *ligamentinus*, *teres*, *rectus*, *circulus*, *donaciformis*, *tuberculatus*, *irroratus*, *gibbosus*, *plicatus*, *undulatus*, *cylindricus*, *metancerrus*, *lachrymosus*, *pustulosus*, *rubiginous*, etc. Numerous specimens of fresh water univalve shells of the genera *Pleurocera* and *Campeloma* were mixed among the bivalves, as were also fragments of elks' and deers' horns and bones of various mammals. Almost all the bones, even the smaller ones, had been split for the marrow.

Mixed with the shells were also many fragments of sandstone rock about 3 x 2 x 3 inches which appeared as if they had been exposed to fire; also small pieces of charcoal and in two or three places thin beds of ashes tightly cemented together.

One very small fragment of coarse pottery of a reddish hue was found and one or two imperfect flint arrow-heads. The most interesting artificial objects taken were a number of bone awls and thicker pieces of bone sharpened down to serve as prys in opening the shells. The majority of the awls were broken, but of some all the pieces were found and cemented together. One had an eye or small opening at the end and had doubtless served as a needle. Some fragments of red orpiment or clay from which it is burned were also found.

T. Ghorncley, the owner of the land, has ploughed up two small axes and a number of flints, stone hammers, etc., from the supposed village site just south of the shell heap. Whether these belonged to the people who dumped the shells or to a later race which afterward inhabited the same site, there is no means of telling. They would indicate, however, that the former owners lived in the stone age before the advent of the white man with his weapons and implements of metal. By the best authorities such mounds in other localities are referred to the early part of the Neolithic age when the art of polishing flint instruments was known but before it had reached its greatest development.

Similar shell heaps are known to occur in a number of places in Indiana, though but few if any of them have been thoroughly investigated. Along the Ohio River in Clark County there is one near the mouth of Fourteen-mile Creek and another two miles east of New Washington. The large one formerly at Clarksville, just below Jeffersonville, has been mostly eroded away by the stream. Others occur on the banks of the Ohio in Perry and Posey Counties. On a high bluff just below New Harmony there is a large kitchen-midden, and also another on the Wabash near Merom, Sullivan County.

All of these Indiana refuse heaps are composed mainly of the shells of *Unio*, and show that that mollusc once formed an important element in the food supply of an ancient people. The larger number of *Unios* in our streams have in recent years been removed to furnish ornaments, not food, for the over-civilized white man. It might be well for him to cultivate a taste for these fresh water clams and so add another variety of food to his menu, thereby reducing in slight degree the high cost of living of which he now so much complains. I do not know, however, that I would advise him to try any of those (if any there be) in the West Fork of White River between Indianapolis and Martinsville.

Shell mounds or kitchen-middens of marine shells, some of them of great size, occur frequently along the Atlantic coast and are especially numerous in Florida. They have not as yet received the close attention from archaeologists that those of Europe have had. A thorough study of them would, without doubt, disclose many points of interest regarding the food habits and domestic life of our prehistoric races.

It was from one of these refuse heaps, 1,136 feet in length and with an average width of 160 feet, located near Ormond, Florida, that, in 1899 I secured the bones of the Great Auk, and so extended the known range of that now extinct marine bird more than 1,100 miles.

MATERNAL IMPRESSION.

A. G. POHLMAN, Indiana University.

When a doctrine has been in vogue since the earliest chapters of recorded history, and when evidence in its favor may be found in all climes and peoples, one is tempted as was Von Welsenburg to believe that some basic facts underlie the belief in maternal impression. Belief must however not be confused with fact, and the antiquity, iniquity and ubiquity of maternal impression are not synonymous with convincing evidence. In days gone by, skepticism was not particularly encouraged and the truth in a given matter was in direct proportion to the caliber, mental or physical, of the individual who uttered the statement, not to the amount of evidence he produced. Nostradamus' excellent contention for the peculiar inherent psychic qualities in the seventh son of a seventh son had a face value once upon a time, but now-a-days the Civil Service Commission would give him opportunity to pass the examination for Custom's Inspector if he applied for this position. Even in my own lifetime I have remarked that the clairvoyants are no longer born with a "caul" and have ceased to use the "caul" as the fulcrum upon which they pry into the affairs of others. Possibly through selection they have developed an instinctive second-sight. The fact that it is physiologically impossible for the hair to turn white in a single night may not be convincing, and I doubt that the inability of the German anatomist Stieda to find a single authentic case will be received any more seriously. Indeed we find that a single case cited upon good authority, even before history was, is still observed daily by trusting minds. The antiquity and ubiquity of the doctrine of maternal influence do not convince me as they did Von Welsenburg of certain fundamental facts. The sun went around the earth for myriads of years and will continue to do so even in remote peoples. Why deny our senses?

The antiquity of the doctrine is phenomenal and practically all writers pro or con hark back to the source whence all this blessing flows—the story of Jacob and his cattle. I will make an exception and dismiss Jacob with a word. It may be that Jacob used the "pilled rods" on the more susceptible human observers much after the fashion that the present day

magicians use their wands—to divert the attention and “cover the experiment.” As evidence I cannot consider it any more seriously than the remarkable feat of Joshua might be taken as proof conclusive of the futility in the study of celestial mechanics.

The ubiquity of the doctrine may also be satisfactorily explained. Like “Little Orphant Annie,” every race has its own peculiar story of how “the goblins will get you,” and it would be more than strange if superstitions of like character did not arise even in remote peoples over the birth of a child—particularly an abnormal one. I am not prepared to deny that folklore has some truth in it; but then folklore never loses in the telling and does not necessarily imply close analytical study.

The iniquity of the doctrine is notorious and consists in an attempt to convict Mrs. X. of giving birth to a mentally, morally or physically misshapen child or to a mathematico-musico-poetic prodigy by reason of certain influence she has exerted, and without giving her a chance to defend herself. If the law holds that a person must be proved guilty beyond reasonable doubt, let us first look into the evidence; for without the facts, there is nothing to disprove; without the facts, the argument may be entertaining but not productive.

Inasmuch as everyone has his own cases which illustrate the workings of maternal influence and which he looks upon anywhere ranging from a grave suspicion to conviction, I will arrange the evidence presented into several classes and illustrate each with a case.

I. Alleged bona-fide maternal impression—conscious type.

“Dr. Napheys tells of a woman, the wife of a baker, who during the earlier months of her pregnancy, sold bread over the counter. Nearly every day a child with a double thumb came in for a penny roll, presenting the money between the thumb and finger. After the third month, the mother left the bakery but the malformation was so impressed on her mind, that she was not surprised to see it reproduced in her own child.” Neither was Dr. Napheys, for that matter, for had he been skeptical, he would have inquired into what the mother of the first child saw to create the deformity, and would have commented on the frequency of this particular deformity at this time. Otherwise the evidence is excellent.

II. Alleged bona-fide maternal impression—subconscious type.

“We have heard of a mother (evidence?) who gave birth to a child that had but one hand. The other arm was handless as if amputated be-

tween elbow and wrist. The only way she could account for the deficiency was the fact that her husband's brother, who had his hand amputated, lived in the same family during the earlier months of her pregnancy. While she received no special shock, being familiar with his condition, yet maternal impression continued through a considerable period had its disastrous effects." This case is illustrative and suggestive for, as Dr. Stall says, it shows that the unconscious impression may be as potent as the conscious. Assuming that the evidence is quite good, how does Dr. Stall account for the normal children born directly of our mutilated war veterans?

III. Missed maternal impression; where a well defined shock occurred but the resulting defect did not resemble its alleged cause.

"An instance came under my observation but a few years ago in which the boy of the family had fallen from a banister of a porch some eight or ten feet to the ground below where his head came into contact with stones inflicting a large gaping wound of the scalp. The mother had it to care for until my arrival. In a few months (seven to be exact) she gave birth to a child with spinal defect that soon extended to the head to form hydrocephalus, causing great enlargement and the death of the child." Here the unborn child did not exactly register its mother's distress. Inasmuch as Goethe misunderstood the bones of the head and regarded them as modified vertebræ, the error on the part of the child is wholly excusable under the circumstances, for as Dr. Blondel said nearly two hundred years ago, it is "not yet acquainted with the outward objects that disturb the mother."

IV. Postpartum maternal impression; where a woman on beholding a marked child remembers the circumstance that must be held responsible.

I abbreviate a ¹¹³case reported by Ballantyne. "On July 2, 1884, she gave birth to a full ¹¹⁴term male child on whose chest there was a peculiar mark similar in size to the apple which was thrown at the patient, but rather paler in color. She then remembered the above mentioned circumstance (being hit by an apple in the previous October) and connected the impression and the mark together as cause and effect." Ballantyne, while he places this case in his list of maternal impression, remarks that it is not a strong case; to which I heartily agree. As evidence we cannot accept it any more than we accept the statement of several individuals on

beholding a well-filled pocket book—"It's mine"—as conclusive proof of the wallet's collective ownership.

V. Non-selective maternal impression; where a mother succeeds in marking both of the twins.

These cases are extremely uncommon, for as we shall see, maternal influence appears to be extremely rare and twins occur about one in eighty-eight births. I am therefore glad to report as an illustration, a case given by Wüstnei. He tells of a woman who was accustomed to taking her nap with her forehead against a porcelain stove. She gave birth to twins and it was found that each had a rather long impression running up and down on the forehead. The case is not reported in sufficient detail to comment on it. I present it for its face value, together with the suggestion that a mark down the forehead of each of the twins would be likely to make a skeptic examine the birth canal of the mother for a bony prominence in the pelvis.

VI. Non-selective type of maternal impression; where a mother only succeeded in marking one of the twins.

These cases must also be uncommon and I have found no instance reported by the champions for maternal impression either because they do not occur at all or because they do not strengthen the cause. I am of the opinion that the latter is the case; for abnormality in one twin is not particularly infrequent. I can, however, call attention to a case where the twins did not succeed in marking a single baby—the notorious example of the Balzac twins—a variety of Siamese—and one of them, I forget which, gave birth to a normal baby.

VII. Threatened maternal influence; where the mother is profoundly shocked and the infant refuses to register any marking whatever.

It may be remembered that the Messina disaster was calculated to upset the routine of that town, and yet after the earthquake only one abnormal child was born of the women who were pregnant at the time, and that in a woman who had been pinned down for many hours with a beam over her abdomen. Indeed, it was reported that a number of women that had aborted spontaneously in previous pregnancies were so severely shocked that they carried their children to term. Bischoff could not demonstrate a single case of maternal impression in 11,000 confinements; and William Hunter "during many years every woman in a large London lying-in hospital was asked before her confinement whether anything had

specially affected her mind, and the answer was written down, and it so happened that in no instance could a coincidence be traced between the woman's answer and any abnormal structure; but when she knew the nature of the structure, she frequently suggested some new cause." To this I would add a statement from Mauclerc: "Do we not know how shy Women are always in confessing their Longings? They will never own upon the Spot, that they longed for such a Thing. It must be presented before them as if we knew nothing of their Desire. And, if they are so unwilling to confess their Longing and Affections before the Effect, why may they not be sometimes as backward to confess them afterwards? Certainly some Women are such unaccountable Creatures, that no more Stress can be laid on their Denials, than their Affirmations." (I would state the gentleman has been dead over a century.)

Mauclerc attacked Blondel's famous treatise and based his contention on the Art of Criticism. He says: "All that lies upon me is to shew, that he (Dr. Blondel) has not proved his Negative." This argument holds today; for, as I have said, without the facts we have nothing to disprove. While nothing can be brought forward to demonstrate that a pregnant woman actually does influence her unborn child, it can be definitely proven that the child does affect the mother. Now, then, based on this fact, and with the idea that six equals half a dozen, if I propose the doctrine of fetal impression, I can defy anyone to prove me wrong—provided of course that any intelligent person will enter into argument with me. Further, this pseudo-hypothesis is much stronger than the maternal impression doctrine. If a child through congenital defect has hare-lip or what you will (and I can show that these defects arise spontaneously in egg-laying animals); and I can also show that the metabolism of the child (or call it what you like) influences the mother, then with justice I can also infer that carrying a child with a given defect will make the mother more susceptible to being shocked by a creature having a similar abnormality.

It is strange how difficult it is to think a new thought. I constructed an illustrative example for my hygiene class. "If a pregnant woman goes to the sideshow and is frightened at beholding a two-headed steer and later gives birth to a two-headed child, the biological question is, "What did the cow see?" I can not replace this with an authentic case reported by Wüstnei. It seems that a woman gave birth to a child with a sort of tumor in the pelvic region. The child died on its attempted removal, and

the tumor was found to contain a second child, or at least additional fetal parts. The mother then related that while she was pregnant she had a goose which brought forth her goslings and among the number was a double one. This double gosling she gave to her child of four years to play with but presently the sight of it became hateful to her and she was forced to dispatch it. Now while the maternal impressionist must explain what the goose saw; my pseudohypothesis of fetal impression can explain why the double gosling became hateful to the mother very readily.

I would therefore close this brief paper by repeating: The doctrine of maternal impression has four strong factors, its antiquity; its ubiquity; its iniquity and its unquestionable lack in proof. After all, the human being is more superstitious than he will openly admit, and perhaps P. T. Barnum, who capitalized credulity, should be accounted some word of authority in his statement "The public likes to be humbugged."

TERRACES OF THE WHITEWATER RIVER NEAR RICHMOND, INDIANA.

BY ALLEN DAVID HOLE.

INTRODUCTION.

The terraces referred to in this paper constitute a small part of the complex series of terraces which characterize practically all the larger valleys in a considerable portion of the glaciated area of the United States. The terraces along the Whitewater River near Richmond have been recognized and referred to by a number of observers, but so far as the writer knows, there is no record of any systematic, detailed study of them prior to 1909. In that year Harold Chapman, then a student at Earlham College, studied carefully under the direction of the writer the terraces within the gorge from Richmond to a point about one and one-half miles south of the city. A continuation of this work for the three forks of the Whitewater above the city, extending four or five miles along each fork, was undertaken by Wendell H. Pitts, another student, and completed by him in 1911. The author has, by permission, used freely the data gathered in these two studies, which covered the areas indicated on the accompanying outline map, Fig. 1.

GEOLOGY.

The geologic formations involved include (1) thin-bedded limestone and intercalated shale of Upper Ordovician age, exposed in the gorge-like valley near the city of Richmond and for some distance above and below; (2) Middle Silurian limestone exposed scarcely at all within the limits here referred to, but forming the underlying bed rock in the northern (upper) parts of the area studied; (3) glacial drift of Pleistocene age, both unsorted (moraines), and assorted (valley trains, outwash plains, etc.); and (4) deposits of Recent age, mainly alluvial (flood-plains), but including also fans, material shifted by sheet wash, accumulations of talus, etc.

Structurally, the bed rock forms a part of the northernmost end of the Cincinnati anticline; the strata exposed are, however, practically hori-

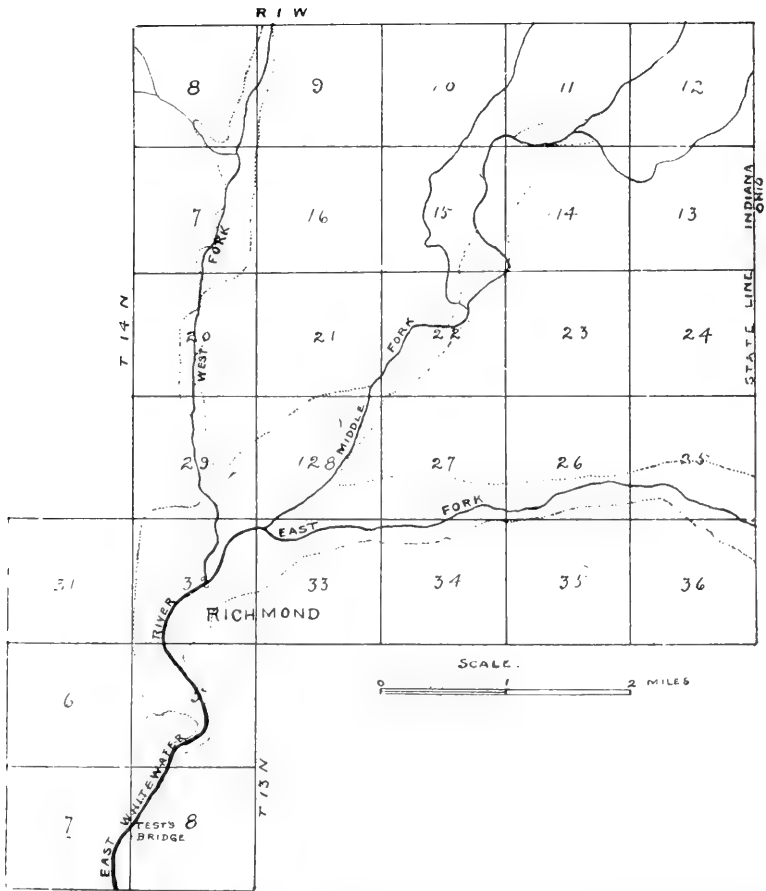

Fig. 1. Outline map of the region studied. Spaces included between dotted lines, or between one dotted line and the adjacent stream are approximately the areas within which terraces are found that is, a considerable part, though not all, of the included spaces are terraces.

zontal within the area observed, clinometer measurements indicating either no inclination at all or dips varying in amount up to about 1° in various directions, showing that the strata are either horizontal or departing from it to a very slight degree in such a way as to form an irregularly warped surface. Evidence of continued warping in the same direction of relatively recent date, considerable in total amount, yet occasioning dips too slight to be measured with a clinometer, will be presented in connection with the detailed discussion farther on.

No great systems of joints have been detected, and no faults except exceedingly diminutive ones.

GEOGRAPHY.

Whitewater River at Richmond is strictly East Whitewater River, the western branch crossing Wayne County near Cambridge City, and finally uniting with the eastern branch just below Brookville, in Franklin County, to form the Whitewater River proper; but in this paper, for the sake of brevity, the stream at Richmond will be referred to as the Whitewater River. This (East) Whitewater River is formed by the junction of three smaller streams just north of the city of Richmond, known as the West, the Middle, and the East Forks, respectively, of the Whitewater River. For the greater part of their course these three forks flow in valleys which are formed for the most part in glacial drift, bed rock being encountered at only a few points. Beginning a short distance north of Richmond, however, the valleys of these streams have cut into the underlying rock, which from this point on forms a large part of the slope of the sides of the valley; sometimes being exposed in steep, cliff-like faces, sometimes covered with a thin layer of soil, talus, or other rock waste.

From the vicinity of the junction of the three forks for a distance of over two miles southward, the valley is narrow, steep sided, and canyon-like, its width at the top being from 600 to 1,000 feet, and its depth 60 to 80 feet. A little farther down, the valley is somewhat deeper but proportionately much wider, with sides which, while still steep, are less precipitous, having cliff-like faces at relatively few points, and in general showing signs of greater topographic age.

THE TERRACES.

The region at and near the points of junction of the three forks marks the approximate location of a natural division separating the series of terraces along the valleys of the three forks above from those along the

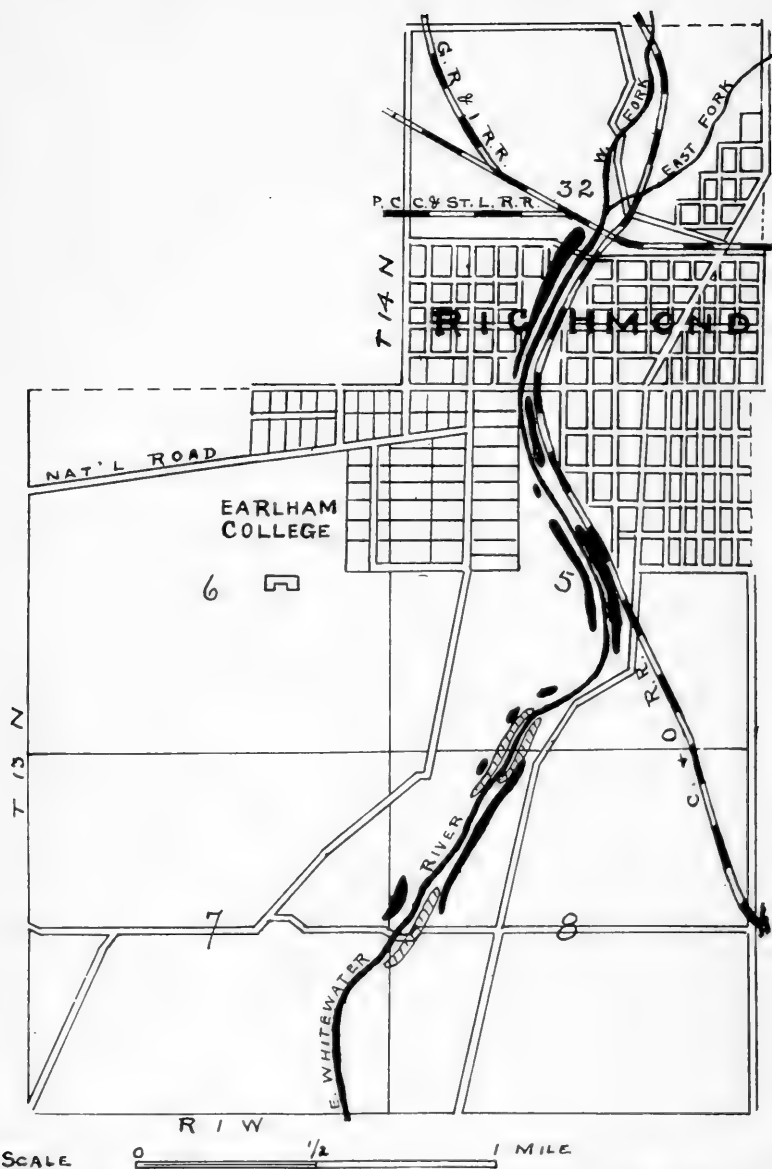

Fig. 2. Map of the gorge of the East Whitewater River and country adjacent, showing the approximate location of two levels of terraces within the gorge, viz: (A) a higher series, shown by solid black areas; and (B) a lower series, shown by obliquely-lined areas.

single, narrow, gorge-like valley below. The reasons for emphasizing this area as a division point will be clearer when the details of the different series are understood; but it may be worth while to note certain general differences just here between the terraces and valleys above the area near the junction and the corresponding phenomena below. The more obvious or the more important differences are:

1. Different materials; slopes mainly of outcropping bed rock below, mainly of glacial drift above.
2. Different number of terrace levels; four clearly marked below; seven above.
3. Different gradient of terraces; slope being upward in the downstream direction, or nearly horizontal below the junction area; level to a gradient about the same as the beds of the streams above the area.

SUMMARY OF OBSERVATIONS ON TERRACES ABOVE THE GORGE.

The different terraces along the three forks of the Whitewater can be referred to seven different series. For the West Fork these seven series are indicated in Fig. 3 by broken lines numbered from (1) to (7) inclusive. In nearly every case each series is made up of a number of disconnected terrace remnants. The total number of these remnants along the West Fork is 51; along Middle Fork, 26; along East Fork, 31; total, 108. From this total when deduction is made for terraces counted more than once near the junction of the streams, the net total is 103.

In size these remnants vary greatly. The largest forms the surface on which the principal part of West Richmond is built, and contains about 420 acres; its total length is more than $1\frac{1}{2}$ miles, and its width from $\frac{1}{8}$ to $\frac{1}{2}$ mile. This terrace is a part of the fourth series and has an elevation above the stream at its south end of 82 feet; at its north end, of 45 feet. At its southern end bed rock is within a few feet of the surface; farther north the covering of drift, mostly assorted, becomes thicker.

At the other extreme of size are the very small patches forming flat-topped points or shoulders, in some cases having areas of only a few square feet. These exceedingly small patches, while sometimes of value in the field in correlating remnants of terraces, have not, however, been included in the count of terrace remnants given above. The smallest area included in the numbers as given contains about one-fifth of an acre; the average is, however, much larger, being for the 103 areas a little over 20 acres.

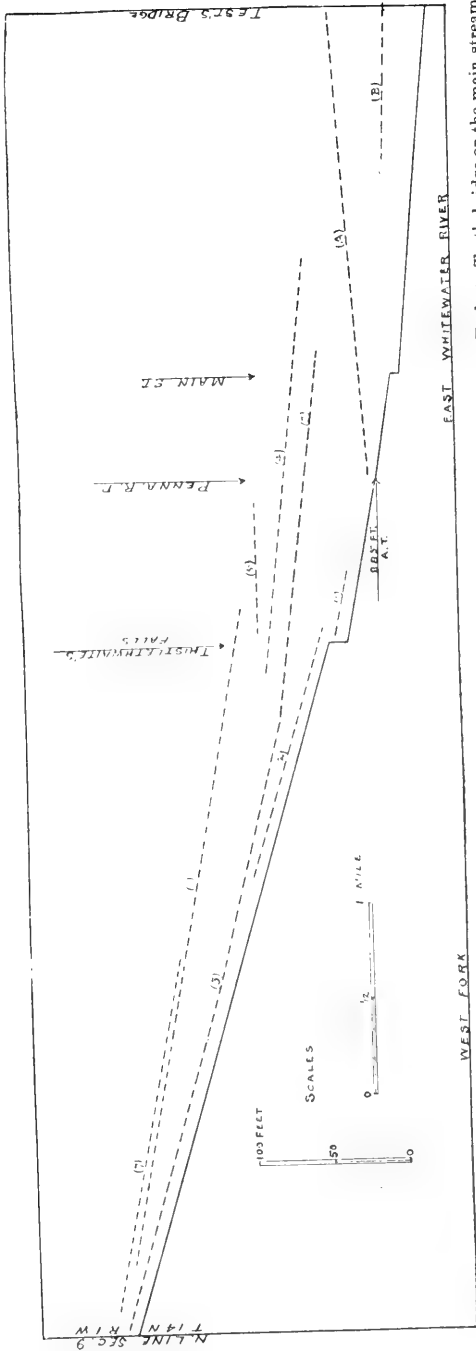

Fig. 3. Stream profile and approximate profiles of terraces from the north line of sec. 9 T. 14 N. R. 1 W., on the West Fork, to Test's bridge on the main stream (East Whitewater river).
 Terrace profiles, broken lines; (terraces are in most cases not continuous).
 Stream profile, unbroken line.

The gradients of the different series vary in about the same way on the three forks, though there is not perfect agreement. The general relations are shown by Fig. 3, viz.:

(1) The recent terraces above the point of junction of the forks agree quite closely in gradient with that of the stream to which they are adjacent.

(2) The older terraces have lower gradients than that of the adjacent stream.

One series, the fifth, has a surface almost horizontal so far as the West Fork is concerned; but its extent along this fork is limited to about three-fourths of a mile. When considered as a part of the corresponding series along Middle Fork with a total extent of nearly six miles, it agrees in general with the older terraces in having a distinct gradient, but less than that of the stream at present. The terrace profiles shown in Fig. 3 may suggest that the lower and upper parts of the third series do not belong together, since the degree of slope is so noticeably different. It cannot, of course, be considered as settled beyond question, yet the work in the field indicated so strongly that the two portions are part of the same series that the correlation was made as here given.

In most cases the remnants belonging to a given series are found part on one side, part on the other side of the stream. In only a few cases are remnants of the same series found on both sides of the stream at a given point.

In explanation of the profile of the West Fork it should perhaps be remarked that the Falls indicated are due to a diversion of the stream from a part of its natural channel for water-power purposes, which has forced it to abandon a part of its former course and re-enter its valley at a point where the slope is steep and formed of outcropping bed rock. The terraces of series (1) and (2) are, therefore, plainly not to be correlated, although the height of (2) above the stream bed above the Falls is about the same as that of (1) above the stream bed below.

TERRACES WITHIN THE GORGE.

Within the part of the main valley which is canyon-like, extending from a little north of the city of Richmond to a point about two miles south, are two well marked terrace levels, an upper and a lower, indicated in profile on Fig. 3 by (A) and (B) respectively, and shown on Fig. 2 by solid black (upper), and obliquely lined (lower), areas. At neither level

are the terraces continuous for the whole distance indicated on the profiles, but consist of remnants, part on one side, part on the other side of the stream.

At the upper level, there is first a continuous terrace on the west side of the stream for about half a mile; next, in the down-stream direction, for about $\frac{1}{4}$ mile on the east side; below this for some distance not more than a trace on either side, succeeded by nearly continuous terraces on both sides for more than $\frac{1}{4}$ mile; again a distance of about $\frac{1}{3}$ mile with either no trace remaining or merely shoulder-like projections here and there; and finally at the south end of the canyon-like part of the valley, a terrace $\frac{1}{2}$ mile in length on the east side, with a remnant only a few rods in length on the west side.

At the lower level the terraces are likewise discontinuous in places and found only at times on both sides of the stream at the same point.

The width of these terraces is, at the maximum, about 60 feet; average, perhaps 20 to 30 feet; see Figs. 4 and 5. At both levels the terraces are chiefly rock cut, only a small amount of soil, talus, glacial debris, and rock waste being found upon their surfaces, and the rock in place rising in each case on the side away from the stream sometimes as a steep, wall-like slope until, at an elevation above the upper terrace nearly as great as the general level of the country, a considerable amount of glacial drift is found.

Perhaps the most interesting and significant feature about these terraces is their gradient as compared with the gradient of the stream, and with sea-level as a datum. The terraces of the upper level vary in height above the stream from 6 to 8 feet at the point farthest upstream where they are clearly marked, to 64 feet above the stream at the farthest down-stream point, a differential elevation of about 57 feet, rising higher and higher the farther downstream they are found. This suggested at first that there might be an error in correlating the separate remnants as parts of the same terrace; but it was observed that in each case where the terrace was continuous for about $\frac{1}{2}$ mile, there was this consistent rise in the downstream direction; in one case a rise of about 25 feet in a half-mile's distance; in another case a rise of 11 feet in a little less than $\frac{1}{2}$ mile. The shoulder-like points and projections and smaller terrace remnants where the terraces are discontinuous, have elevations agreeing closely with the general rise of the gradient in the downstream direction.



Fig. 4. View along terrace (B) looking south from a point near the north end.



Fig. 5. View along terrace (A); looking north from a point about 40 rods north of Test's bridge.

Referred to sea level, the southern or downstream end of the upper terrace is about 20 feet higher than the northern, or upstream end. That is, in a distance of a little more than two miles the terrace level rises 20 feet higher above sea level, while the surface of the water in the stream has a fall of about 37 feet in the same distance, making a total differential level between the surface of the terrace and the surface of the water of about 57 feet.

The terraces of the lower level are from 25 to 35 feet lower than those of the upper level and are found only in the lower portion of the canyon-like part of the valley; their width is about the same as that of the upper terraces, averaging perhaps 25 or 30 feet, with a maximum of from 50 to 60 feet. The height of surface of this lower series above the stream also increases in the downstream direction, but at a much smaller rate than in the case of the upper terraces; in a total distance of about two-thirds of a mile the difference in elevation is about 6 feet. The fall of the stream is, in the same distance, a little more than 6 feet, which leaves the surface of the lower series of terraces with a very slight gradient in the downstream direction, when referred to sea level as datum.

Considering, then, the upper terrace level, the lower terrace level, and the present gradient of the stream in their relations to each other, the lower terrace level can be represented by a nearly horizontal line drawn a little lower than midway between two other straight lines which diverge in the downstream direction; the upper representing the surface of the upper terrace level, and the lower the present gradient of the stream.

CONCLUSIONS.

The causes which operated to make the conditions resulting in the terraces above described may, no doubt, be included for the most part in the following:

1. Variations in the amount of sediment carried by the streams.
2. Variations in the amount of water carried by the streams.
3. Variations in gradient due to—
 - (a) Diastrophism;
 - (b) Dams of ice and glacial debris more or less complete, resulting in ponds, river-lakes, etc.

While it is not possible to say positively just what share each of these causes may have had in the formation of each one of these terraces, the following partial explanations seem to be justified:

1. Terraces (A) and (B) in the gorge of the Whitewater River (mainly below the city of Richmond), were developed by the stream at periods, in each case, when its gradient was very much less than at present; a gradient sufficiently low to permit it to erode chiefly laterally.

2. In the case of the upper terrace, at least, this period of lateral erosion was interrupted by a relative elevation of the land (bed rock), which was not uniform, but increased southward from the city of Richmond to an undetermined distance. The total amount of the movement as indicated by terrace (A), is not less than 10 feet of elevation per mile in a general southward direction.

3. Since the terraces along each of the three forks are composed very largely of glacial material, it seems probable that temporary ponding of waters, and variation in amounts of water and sediment present, are largely responsible for their presence and for their relative positions. It seems probable also, however, that diastrophic movements may have had some part in producing the lack of parallelism in surface gradient of terraces of the different series.

The time relations involved can be stated clearly only in part. For example, the lowest terraces along the three forks, such as (1) along the West Fork, must be of date so recent as to fall within the category of present-day formations. Others, such as (A) in the gorge, must evidently be considered as belonging to a period sufficiently remote to allow for the erosion of a channel in bed rock 600 to 800 feet in width and 64 feet deep. Geologically this is still, however, quite recent, and this work may all have been accomplished since the final withdrawal of glacial ice from this latitude.

*Earlham College,
Richmond, Indiana.*

SOME NEGLECTED PRINCIPLES OF PHYSIOGRAPHY.

A. H. PURDUE.

All sciences suffer from errors and misconceptions, which have in one way and another crept in; and as such are difficult to eliminate. Many are passed on from older to younger workers, and are used in both theory and practice. Of such in geology are the popular notions of the characteristics of entrenched meanders; the origin of limestone sink-holes; and (in the opinion of the writer) of anticlinal valleys, and possibly of some transverse drainage.

The Entrenched Meander. It is an accepted principle of physiography that after a stream reaches base-level, it begins to meander. Uninterrupted by diastrophic movement, the meandering continues until the region on either side has been reduced to a plain, the width of which depends upon the size and strength of the stream. If such a region be elevated, the stream, from renewed vigor, will resume the downward cutting of its bed, producing a new (entrenched or incised) valley within the old one. Thus far, the popular notion of the entrenched meander can be accepted without question; but it is also the popular though erroneous notion that the new valley occupies the bed of the old one, and is V-shaped.

While it appears that some rejuvenated streams do have V-shaped valleys, such are rare. The rule is that the valleys of such streams are unsymmetrical. The slopes above the insides of the curves are of comparatively low gradient, while those on the outside are steep. This may be seen by inspecting almost any good topographical map of an area with rejuvenated streams. The explanation is simple. In an old stream, the downward cutting is little or nothing, while the lateral cutting on the outside of the bends may be relatively great. In rejuvenated streams, the downward cutting is resumed, but the lateral cutting does not cease. On the contrary, it becomes more rapid, because the impingement upon the banks is greater than before. The resulting topography is shown in Fig. 1, A and B. As all bends become greater, the rejuvenated stream is more crooked than when in its previous stage of old age, which of course means that it has shifted from its old bed.

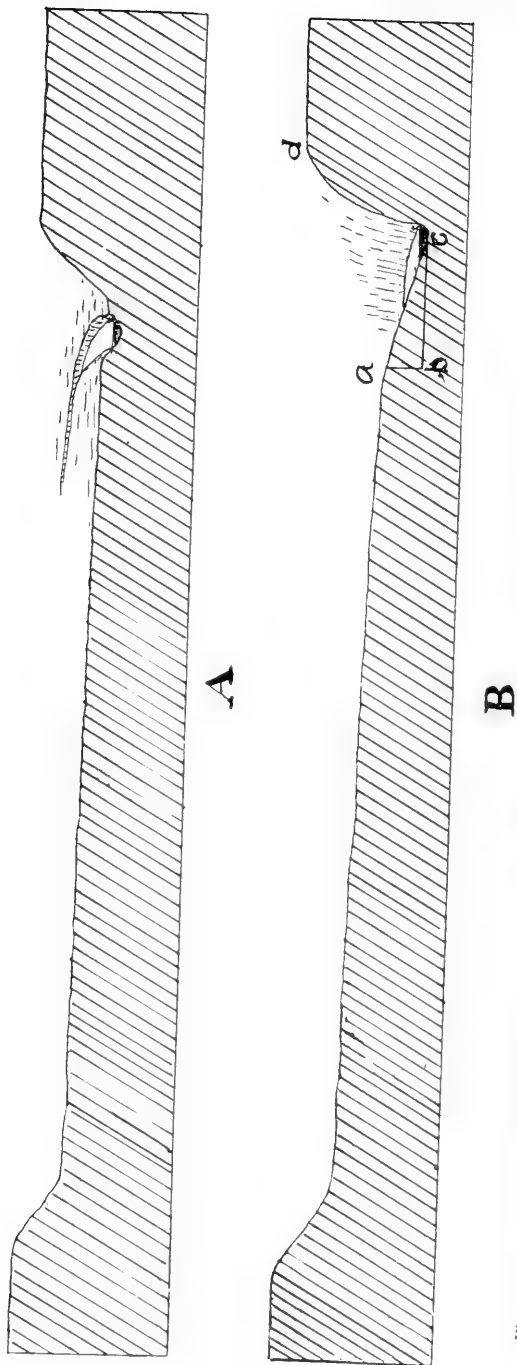

Fig. 1. Diagram showing the lateral shifting of a rejuvenated stream at a bend. The old stream (A) has base-levelled a wide valley. After rejuvenation (B), it has cut vertically the distance ab , and horizontally the distance bc , producing the flat slope ac , and the steep one, cd .

Just why some V-shaped valleys occur in older, wide, flat ones is not clear to the writer. Whether the inner gorge of the Grand Canyon is the result of rejuvenation or not, there has been little lateral erosion accompanying the great vertical cutting. Whether lateral cutting takes place or not, may depend upon the acceleration of the stream's force, which in turn would depend upon the rate and amount of elevation; or, it may depend upon the character and structure of the rocks. Unmetamorphosed, horizontal rocks of alternating hard and soft beds would favor lateral erosion, while metamorphosed crumpled beds, such as occur in the inner gorge of the Grand Canyon, probably would retard it.

Limestone Sink-holes. The common notion, and the teaching of most text-books, that limestone sink-holes are formed by the collapsing of the roofs of caves, is erroneous. That some sink-holes have had such origin doubtless is true, but they are the rare exception. Most of them are the result of solution by descending groundwater. As this has been discussed somewhat at length elsewhere, it will be only mentioned here.

Anticlinal Valleys. The common explanation of anticlinal valleys is that streams have gradually shifted from synclines to anticlines, the shifting having been invited by the excessive fracturing of the latter over the former. The writer believes that most anticlinal valleys have had a different history. It will be conceded that most folds had their inception while yet submerged. This granted, the first part of the folds to appear at sea level were the crests of the anticlines. Except at considerable depths, all the sedimentary material but that of calcareous nature was in the incoherent state at the time of elevation, and consequently was easily eroded. As soon as the anticlinal crests came within the effective force of the waves, they were thereby truncated. The rate of rise was greater than we are accustomed to admit, if the truncation did not for a long time equal the elevation. As the truncated material was shifted to the synclinal troughs, the whole process was a leveling one. It is not unreasonable to suppose that many folded areas emerged as practically level plains, and that streams were at least as free to flow along anticlines as synclines.

In those cases where the rise of any anticlines was rapid enough to overtake the erosive action of the waves, that action was still effective on the sides of the resulting islands. Added to this, was the work of the subaerial agencies. On the whole, the direction of the resulting small

¹ A. H. Purdue, *Science*, Vol. XXVI, p. 120.

streams was transverse to the anticlines. The anticlines did not everywhere emerge at a uniform rate, but appeared as rows of islands over each of which streams flowed radially. Consequently, some of the streams were, from the start, longitudinal to the direction of the anticlines, and others nearly so.

If at this stage the streams were still on incoherent material, the longitudinal ones had no particular advantage over the transverse ones; but if the indurated or partly indurated material had been reached, they had the special advantage of being able easily to seek out the soft beds and follow their strike. In the meantime, the material lapped off the sides by the waves and that washed into the sea by the streams was still filling up the adjacent synclines.

During the elevation, the synclines were occupied first by lagoons of salt, then brackish, and after complete emergence by those of fresh water. Even during the last stage they continued to be lines of deposition until the lagoons dwindled into lakelets and finally disappeared. Meanwhile, the anticlines were lines of degradation, and it is not improbable that as many synclinal lakelets were drained into streams that followed anticlines as into those that followed synclines; and it seems not unreasonable to suppose that in the course of stream adjustment, as many have shifted from anticlines to synclines as from synclines to anticlines, if, indeed, the former has not been the rule.

Major Streams Transverse to Folds. Folds are parallel to the old land areas from which the elastic material of their rocks was derived. In the addition of new land areas to old, the growth was often exogeneous. If a newly added area was folded, and the folds were leveled as above supposed, the streams from the old land gradually extended themselves over the new and in general were at right angles to the folds. As the elastic sediments were yet incoherent and nonresistant, it seems probable that many streams so thoroughly established themselves across the folds as to maintain this course as the elevation continued and after the indurated rocks were reached. May it not be that this has been the history of some of our transverse drainage? This conception, while closely related to that of antecedent streams, is different because it contemplates folding that antedates the streams, while the latter contemplates a well established stream before folding takes place.

In cases where anticlinoria emerged, not contiguous to existing land areas, it seems wholly within the probabilities that many of the transverse streams assumed and maintained their courses across the minor folds of the limbs. It has occurred to the writer that possibly this has been the history of some of the numerous transverse streams in the Ouachita area of Arkansas.

CONSERVATION OF THE SOIL IN DEARBORN COUNTY.

A. J. BIGNEY.

Since Theodore Roosevelt called the Governors of the several States together to consider the preservation of our forests and other natural resources, the word "conservation" has had a new meaning, not a different meaning, but an intensified meaning. A general awakening is occurring along many lines that were very remote from that considered by the council of the Governors. The recent congress in our own State called by Governor Marshall exhibited the range of the use of the term.

Since boyhood I have been observing the wasting of the land in my native county, Dearborn. The developing of the interest in these lines has stimulated me to more serious thought and has kindled a desire to be of some service in helping in the conservation of the soil in my own county. I believe that every member of the Academy should make himself felt in his own locality at least. The ear of the average citizen is open to the scientific man as never before, for his work is seen on every hand.

Dearborn County is drained by the tributaries of the Ohio River. On the south the Laughery Creek forms the boundary and drains that part. It empties into the Ohio River two and one-half miles south of Aurora. About six miles to the north and running nearly parallel with Laughery Creek is South Hogan, which empties into the Ohio at Aurora. The B. & O. S. W. follows it to Aurora. Between these creeks is a ridge of good farming land. Flowing from this ridge toward either stream are numerous branches. About eight miles further north, measuring on the west side of the county, is North Hogan, which joins South Hogan at Aurora. About the same distance to the north is Tanner's Creek. The Big Four follows it much of the way to Lawrenceburg. The northeastern part of the county is drained by the Great Miami River, the main Indiana branch being the Whitewater. With so many streams of various sizes it is plain to see the county is very hilly, no part of the county has much level land.

Twenty-five years ago most of the hilly land was heavily timbered. Since then, however, the greater part has been removed and the land put under cultivation.

This is where the most serious mistakes have been made. Year after year the hills were planted in corn, barley or wheat. The ground was thereby kept loose and the rains eroded it and transported this rich soil to the valleys below, thus enriching them. As the forests were cleared away the erosion increased until at the present time the rich black soil is largely removed from the hills and the clay beneath it is now being eroded very rapidly and this new soil is being transported to the bottom land and deposited upon the rich soil previously deposited. This not being mixed with humus is not very productive. This is seen on the large bottoms of the Ohio and Great Miami. Twenty-five years ago those alluvial plains produced corn in an extraordinary way, but today their productiveness has greatly decreased.

It is plain to see that the farmers on both the hill lands and also the bottoms have suffered great losses on account of this unfortunate method of procedure. Many of the landowners have seen the error of their way and are changing their method of farming. Alfalfa is now being sowed, and this is protecting the land and at the same time is rendering large profit. Others are sowing to blue grass and using the land for pasture—another wise and productive plan. Still others are setting out locust plants and in this way they are protecting the land and providing for the future realization of profit. Much of the waste land in the county could very profitably be used in this way. Others are clearing away the little timber that remains and planting this to tobacco year after year, and in this way the wasting of the land continues.

A large per cent. of the farmers have never realized the real value of their land. They have so much of it that it makes very little difference to them even if some of it is going to waste. The time is coming when this county will be more densely populated, and some one will be compelled to reclaim this waste land. Many are so selfish that they do not care; but is this a sensible way in which to act?

The greater number of the landowners do not consider how important the soil is. They fail to realize that mankind must look to it as the source of sustenance.

If we could look into the future more and try to see the coming needs it would be better for the present as well as the future generations.

*Moore's Hill,
Indiana.*

:

THE EFFECT OF DEFORESTATION UPON THE WATER LEVEL OF MONTGOMERY COUNTY.

H. L. BARR.

HISTORICAL.

The relation of the forest to many problems of vital interest to the welfare and prosperity of the people is becoming more apparent. Until comparatively recent times the far reaching influence of the forest has not been seriously considered, but the gradual disappearance of our vast areas of forest cover and the simultaneous appearance of certain phenomena that are, in the popular mind, probably incorrectly in many cases, ascribed to the cutting off of the forests, has stimulated interest and study along these lines. European countries were the first to recognize the importance of these questions and have consequently taken the lead in matters that have to do with their study or solution. Our own vast forests, with their seemingly inexhaustible supply of timber, have, until recently, blinded us to the facts and lessons which other nations have begun to learn.

One of the far-reaching aspects of forest influence is its relation to the ground water level. Influenced by public men, the press, private prejudices, etc., the public is divided on the question, the partisans of one side asserting that forests have a beneficial effect upon the water level, the others that they do not. Scientists are not agreed upon the subject, and many observations and experiments have been made which give conflicting results. The greatest faults have been that the areas under consideration have been too large for careful study, preventing definite conclusions. Really simple and trustworthy data in sufficiently comprehensive quantity has not been secured. We have deemed it possible that some definite conclusions might be reached by obtaining from a small area all statistics and data available regarding the past and present water level, also the forest, swamp, and drainage conditions. This paper has been undertaken to show the effects of deforestation upon the water level in Montgomery County, Indiana.

SOURCE AND DISPOSITION OF WATER.

Source.—It is deemed advisable to consider first the geological conditions which govern ground water. All terrestrial water is drawn primarily from the ocean, from whence it is taken by evaporation and carried by winds to be deposited upon the surface of the ground, principally as rain but partially as snow, mist, fog, or dew. There can be no other source of ground water available to man in any portion of the globe, with the probable exception of the special cases in which sea water penetrates through the pores of the rocks for a considerable distance inland in coral and other islands of a porous material.

Evaporation.—The rainfall is disposed of in a variety of ways. A great portion of it is returned to the atmosphere in the form of vapor by evaporation. This may be made to include the great amounts given off by vegetation in transpiration. A small portion of water is used in supplying the organic needs of the plants. The proportion that evaporates from the surface of the soil varies greatly under different conditions. Winds, a warm temperature, sunshine, etc., are very conducive to evaporation. The character of the soil and soil covering also has a great influence upon the amount of water returned to the air, a mulch of any character reducing the same.

Run-off.—Another portion of the water which falls upon the earth is known as run-off. This may be divided into two classes: surface run-off and seepage run-off. That portion of the precipitation which flows over the surface of the ground into streams and rivers without gaining access to the soil is known as surface or superficial run-off. By seepage run-off is meant that portion of the rainfall which sinks into the earth but which later reappears on lower levels as springs, seeps, etc., and joins the surface run-off. Another portion of the water is known as deep-seepage, and this sinks into the soil to such depths that it does not later reappear on the drainage basin.

UNDERGROUND WATER.

The amount of water which enters the soil, rocks, and other materials, varies greatly with the nature of the materials, the porous mediums absorbing the most water. The porosity of a soil or rock is determined by the fractional part of it which is occupied by the open spaces.

In Drift.—Drift is a heterogenous mixture of clay, sand, gravel, and boulders left by glaciers. It varies from very porous to impervious, ac

ording to the relative amounts of sand and clay. Water is also found in this in more or less tubular channels a few inches in diameter as well as in the interstices between the particles. Sands and gravels are very porous, the water sinking into beds of such material and the whole mass being saturated with water below the water level. Clay is very impervious to water.

In Rock.—Water found in the pores of rocks is given up readily only in the coarser rocks such as sandstones. The waters found in finer grained rocks are generally from joint, fault, or foliation planes. In limestone the water occurs mainly in channels and caverns which have been dissolved out or eroded by water. The amount of absorption also depends upon the inclination of the porous beds, the gently inclined ones absorbing more than the steeper ones.

Water-table.—As the water passes down through the ground it soon reaches a level at which the soil is completely saturated. The surface of this saturated zone is known as the water level or water-table. Above this plane the soil contains a large percentage of moisture which is a most important factor of plant and animal life, but only the water beneath this is generally included in the term underground water. The water-table in general follows the contours of the overlying soil, but the angles and slopes are much less abrupt than the surface of the land. The depth of the water-table below the surface of the ground varies greatly in different localities. In regions of abundant rainfall it is generally within a few feet of the surface, while in arid countries it may be hundreds of feet below. Moreover, the water level of any locality is subject to changes because of seasonal variations of rains and drouth. Underground water, besides being drawn up as soil moisture by capillarity, also creeps laterally, its direction and rapidity of flowing depending upon the porosity of the soil and rock through which it passes.

FORESTS AND WATER LEVEL.

Regarding the effects of forests upon water level, it is evident from the above considerations that any factors which tend to increase the conditions that make it possible for a larger per cent. of the precipitated water to enter the soil, will aid in raising the water level of the region on which the rainfall occurs, and any agent which tends to increase evaporation, surface run-off, etc., will help to lower it. Let us now consider the importance of the forest as a factor in both of these conditions.

RAINFALL.

The water level of a region is necessarily affected by the amount of precipitation which falls upon its soil. It cannot be said, however, that forests have any great influence upon the rainfall of a country. This question has long been debated but no conclusion, backed by convincing proofs of scientific exactness, has been reached. It is true that rainfall is most abundant where forests grow, but it is more reasonable to believe that rainfall controls the density and distribution of the forests rather than that forests are great factors in determining the amount of rainfall. Precipitation takes place whenever the air is suddenly cooled below the dew point. Forest air is cooler and contains a relatively greater amount of moisture than air in the open, and for this reason it is fair to infer that forests may have at least some effect in increasing local precipitation. The trees also have a mechanical effect in retarding a vapor laden wind, which condition may be conducive to the precipitation of moisture. On the other hand, the following quotation from Blanford (3) shows the opinion that meteorologists are adopting. "As a result of a long study of rainfall in India, and perhaps no country affords greater advantages for the purpose, I have become convinced that dynamic cooling, if not the sole cause of rain, is at all events the only cause of any importance, and that all the other causes so frequently appealed to in popular literature on the subject, such as the intermingling of warm and cold air, contact with cold mountain slopes, etc., are either inoperative or relatively insignificant."

Many experiments and observations made in Europe and elsewhere show an excess of rainfall in forested areas over that of open countries. Some of these excesses were so small, however, that they might have been due to errors in rain gauges and other extraneous conditions which affect them. In Prussia the following records have been gathered from the ordinary meteorological stations showing the excess of rainfall in forest stations over those in the open regions.

Between sea level and 328 feet elevation, 1.25 per cent.

Between 328 and 556 feet elevation, 14.2 per cent.

Between 1,967 and 2,297 feet elevation, 19 per cent.

Between 2,297 and 2,625 feet elevation, 43 per cent.

These figures seem to show that forests have very little effect on rainfall in the plains, but that their influence becomes greater with increasing

elevation. In studies made by Schubert (31) in Silesia a few years ago, the experiments indicated that the rainfall varies with forest cover and altitude as $529 + 0.78 p. + 0.57 a$, that is, precipitation varies above a constant amount by 0.78 mm. for each per cent. of the surface of the country under forest cover and 0.57 mm. for each meter in altitude. It is further stated that beyond about 50 per cent. of the total forest area, forest cover seems to have little additional influence upon rainfall, so that in Silesia, which has about 660 mm. rainfall and 29 per cent. forest cover, complete deforestation would reduce this amount only 5 per cent., and 20 to 80 per cent. additional forest cover would increase it but by 1 per cent. Schubert (32) has also presented data for the provinces of West Prussia and Posen and this data corresponds closely with that compiled in Liberia and Sweden. "Correlating these three series of data it may be stated generally that at altitudes under 500 meters an elevation of 100 meters increases the rainfall by 8-12 per cent.—the higher figure for the drier region—while in a country averaging 15-25 per cent. forest an increase of 10 per cent. in the forested area gives a corresponding increase of 1-2 per cent. in rainfall." Near Nancy, France, observations were made for seven years in two stations, one in a forest and the other in an almost woodless country. The results were as follows:

Excess in Forest.

February to April.....	7 per cent.
May to July.....	13 per cent.
August to October.....	23 per cent.
November to January.....	21 per cent.
—	
Mean of year.....	16 per cent.

This shows an increase of 16 per cent. at the forest station. Even this, however, cannot be taken as entirely conclusive proof because other factors may have helped to produce the difference. Willis L. Moore, Chief of the U. S. Weather Bureau, says: "The records of precipitation of the United States Weather Bureau do not show that there has been any appreciable permanent decrease in the rainfall of any section of the United States." It should be said of the statement of Moore's that this conclusion was given in a paper prepared to prove that the removal of the forest has not influenced the erosion of the surface of the ground or the

water level of the streams. But his report has been shown to be so full of glaring inaccuracies and misstatements that its conclusions are almost wholly discredited by scientific men. (12), (29), and (38.)

Other literature, much of which has contributed nothing new to the subject, has been gone over and after considering all the facts it may be safely said that the weight of evidence seems to show that forests do increase precipitation, at least to a small extent.

EVAPORATION.

Under the best of conditions much of the precipitated water is lost by evaporation. The proportion evaporated varies greatly in different parts of the world and under different conditions of season and soil. It depends principally on the temperature, the wind, and the amount of moisture already in the air. That the forest retards evaporation cannot be denied. The shade which it affords the soil and its relatively cooler temperature in summer retards evaporation to a great extent. The greater amount of moisture in the atmosphere of the forest is another factor which reduces evaporation. Winds are checked by the forest and their power to take up moisture limited. The wind and sun in winter evaporate a great portion of the snowfall. In the San Bernardino Mountains, snowfalls a foot in depth are frequently evaporated in two or three days without even moistening the soil. The forest aids in reducing this loss in so far that it furnishes shade and checks the wind. Experiments in Germany have proved that evaporation under trees is about one-half of that in the open and show a saving of 21 per cent. of the precipitation by the woods. The evaporation and saving by the forest were both greatest in May and June. It was also found that deciduous trees when in leaf retarded evaporation more than the evergreens and that evaporation under young trees was only 20 per cent. less than in the open. Following is data from a series of investigations by Dr. Ebermayer and by German investigators:

EVAPORATION IN WOODS IN PER CENT. OF EVAPORATION IN THE OPEN.

	DR. EBERMAYER'S RESULTS.						GERMAN OBSERVATIONS.		
	Water Surface.		Bare Soil.		Soil Under Forest Litter and Within Forest.	Rain- fall.	Water Surface.		Rain- fall.
	Open.	Woods.	Open.	Woods.			Open.	Woods.	
April.....	1	.45	1.15	.64	.27	1.75	1	.61	1.37
May.....	1	.43	.91	.37	.16	.68	1	.47	1.35
June.....	1	.36	1.07	.38	.14	1.46	1	.41	1.91
July.....	1	.35	.89	.34	.12	1.02	1	.38	2.33
August.....	1	.34	.87	.36	.11	1.00	1	.36	1.98
September.....	1	.33	.92	.39	.11	.59	1	.35	2.54
October.....	1	.41	1.26	.44	.18	3.45	1	.37	8.49
May-September..	1	.36	.93	.35	.13	.95	1	.39	2.02

The difference in instruments used by Dr. Ebermayer or their exposure is probably the cause of the relatively slight differences in the results. One of the most striking features of the table is the retarding effect that forest litter is seen to have upon the soil beneath. About seven-eighths of the loss of water by evaporation is cut off by the forest and litter. The stations of Prussia allow the following average for evaporation, the amount evaporated in the open field being called 100:

	Evaporated.	Retained More Than in Open Fal'ow Field.
	Per Cent.	
Under beech growth.....	40.4	59.6
Under spruce growth.....	45.3	54.7
Under pine growth.....	41.8	58.2
From cultivated field.....	90.3	9.7

Other data from Prussia are also given which show that greater amounts are lost by evaporation in the open than in the forest. Investigations by Shimek (34) in western and northwestern Iowa show that evaporation is much greater on prairie surfaces than in adjacent forests. It must therefore be admitted that wastefulness by evaporation from the ground is reduced by forest cover.

TRANSPIRATION.

Great amounts of water are returned to the air through evaporation from leaves and stems of plants. This is known as transpiration. Careful experiments and estimates have shown that plants differ widely as to the amounts transpired and that conditions such as wind, the amount of humidity, sunlight, etc., affect this to a great extent. An oak tree, with seven hundred thousand leaves, will transpire one hundred and eighty gallons of water per day. Von Höhnel estimates that a beech will transpire about two thousand two hundred and fifty gallons of water in one summer. Schleider believed that a forest transpired three times as much water as would be evaporated from a water surface equal in extent to the territory covered by the forest. Schübler considered it only one-fourth as much, and Pfeff, who studied only one oak, found it to vary from 0.87 to 1.50. Hartig believed the transpiration from a forest less than the evaporation from bare soil of equal extent. Schübler found that a forest transpired .06 as much as evaporated from bare soil and from sod three to five times as much. Investigations by Wollny show that agricultural crops and forms of low vegetation, such as weeds, transpire greater amounts than do forests. Risler, after a long series of experiments, concludes that forests take up less than one-half as much water from the soil as the average agricultural crop. Some investigators claim that the ground water level of a forest is lower than that in the open, and that this is caused by excessive transpiration. Others draw opposite conclusions. On the whole, however, it may be said that the forest, at least, transpires no more water than does any other ordinary form of vegetation.

FORESTS AND RUN-OFF.

It is generally believed that forests are great regulators of run-off, that is, that they increase seepage run-off and decrease surface run-off. This is true to such an extent that the government has recently made provision for buying certain timber lands with the express purpose of protecting the headwaters of several navigable streams.

Many factors enter into the question such as the slope of the ground, the underlying rock, the amount and length of time of precipitation, etc. The forest canopy intercepts the raindrops and extends the period of time during which the rain reaches the ground. This gives the soil more time in which to absorb the precipitation and thus lessens the surface

run-off. An added advantage is also obtained in that the force of the raindrops is diminished and prevents the soil from becoming hard and compact, thus reducing its absorptive power. It must not be forgotten, however, that the branches of the trees catch from 8-10 per cent. of the rainfall, and this is, of course, immediately evaporated.

The character of the soil has much to do with the distribution of the fallen water. Many experiments have been made concerning the conductivity of certain soils, but as many of these have led to contradictory results, no attempt will here be made to discuss them. It is fair to say, however, that the forest soil is well adapted to absorb a great deal of water. The humus and litter of leaves, limbs, etc., serve to keep the soil in a loose, spongy condition, which undoubtedly assures a great absorbing capacity. The great mass of roots also aids in this and facilitates the passage of the water down through the soil. It may be true, however, that after a long continued rain the forest soil will become so saturated that the water will run off as freely as from bare soil. The forest floor offers many obstructions and obstacles to the water that is not immediately absorbed as it runs over the surface of the ground. These retard its passage and thus more is taken into the soil.

In the case of bare land, the water is gathered into little rivulets which form larger and larger ones, which flow with constantly increasing velocity with the result that very little water gets into the soil.

Forests also have a great power in conserving snow water. Mattoon (21) in Northern Arizona has shown that the forest retains the snow later in the spring than does the open parks. The snow melts more slowly and more is taken into the earth. A layer of ice which kept the water from entering the soil was formed above the soil and under the snow in the park, while this was absent in the forest.

By retaining the rainfall the forest is a benefit in two ways. It tends to prevent disastrous and destructive floods, and holds the water until long after precipitation and gives it out slowly to streams, springs, etc., in times of drouth. Many, however, do not concede the regulating effect of the forest and much discussion has arisen concerning the subject. Professor Engler reports that at the Swiss Station experiments made for three years show that the springs in times of drouth continued to give out water for a longer period in a forested region than in an unforested one. Buffault (4) discusses the evidence reported at the Navigation

Congress at Milan in which Wolfschütz of Brünn gave proof to show that the efficacy of the forest in retarding water fails in times of long-continued and extraordinary rain, and Honsell claims that the best wooded basins of the Black Forest, Harz, Spessart, etc., contributed most of the water of the floods of the Rhine in 1882. Like experiences were reported from the watersheds of the Elbe in 1897, of the rivers Enns, Traun and Ybbs in 1899, and from the densely forested Riesenwald in Silesia in 1888, 1897 and 1903. Wolfschütz, however, thinks that forests have a limited and local influence in certain regions in reducing floods. Lauda, director of the Austrian Hydrographic Bureau, comes to the conclusion that weather conditions preceding the precipitation has a bearing on forest influences, the forest having the greater retentive capacity after a drouth. Ponti, an Italian engineer, asserts experiences of increased floods due to deforestation in Sardinia, Sicily, and Campobasso, and of the watersheds of Adda and Matero. He also finds favorable influences from forest planting in several provinces. The Russian, Lokhtine, cites a long series of general experiences and observations from parts of Europe and especially from Russia which indicate injurious effects from deforestation. Other instances were given which show that the water level is decreasing with deforestation.

After considering these and much additional testimony on the subject, one is justified in saying that forests do act as great regulators of rainfall but that their value in this respect is a relative one which is modified by many conditions.

FORESTS AND WATER LEVEL.

Let us now consider the relation of forests and water level as shown by observations and experiments.

Professor Bühler [see (7)] found a much lower ground water level under forest growth than in the meadows. Ototsky in the steppes of Russia, where a low rainfall prevails, came to the same conclusion as Bühler. Ebermayer and Hartman in Bavaria, however, found no difference between the ground water level of forest and field. Otoski states that Wollny and King found the ground water level lowered by a forest and that this caused its lowering in adjacent open soil. In a bulletin by A. Tolsky and E. Henry (40) it is shown that observations made independently in France, near Nancy, and those made in the Russian Steppes

in 1895 and in the neighborhood of St. Petersburg in 1897 and later, all agree in the following, at least as far as Europe is concerned.

(a) Water level is never higher under a forest cover than under bare soil. (b) The surface of ground water is always found farther from the surface of the ground under a forest than outside of it, this being true for both summer and winter. (c) Fluctuations in ground water are smaller in forests than outside of them. (d) Water level is lower in old forests. (e) Depressions of water level is greater in dry climates.

Wysotski, a Russian, finds that forests lower ground water level and also streams in summer time, but that this effect is reduced in mountainous regions. Buffault (4) in a paper gives the work of others. The Russian, Lakhtine, gives the statement of Schreiner and Copeland regarding conditions in Monroe County, Wisconsin, where in seventy years the forest area was reduced from 83 per cent. to 69 per cent., and the effect was noticeable in 1887 in a striking manner by low river beds and abandonment of mills. Results of a special commission on the Dnieper and its tributaries show the deforested basin as retaining from 3-20 per cent. less water than the forested basins, in proportion to the deforestation. In the Soma, a gradual decrease of the average water level has been observed from 1888 in proportion to progressive deforestation. Similarly on the upper Bielaja at Onfa, where deforestation has been going on from 1887-1900, the average water level has decreased, while on the lower Bielaja at Grouzdecka, where the forest cover has remained undisturbed, the water level has remained practically the same. Like observations are cited for the Volga basin. Experiences were also given by the department of Aude in 1893. The main river rose fifteen feet. In the two branches which passed through a country mostly deforested, great damage was done. In another branch which ran through a well forested region, little damage resulted. From these evidences, it is seen that although the water level under a forest may be lower than in the surrounding land, it is evident that deforestation causes a lowering of the ground water which is very detrimental to the continued flow of springs, streams and wells.

MONTGOMERY COUNTY.

We have discussed the general relationship which exists between forests and water level. We shall now take up our own particular problem and consider the effect which deforestation has had in this county.

Montgomery County is located in the middle western part of the State and contains 504 square miles, or 322,560 acres. The surface is somewhat diversified. The western and central part near the principal streams is hilly and broken; in the north central it is gently undulating, and at the east and southeast flat and level. The northern part of the county is, in general, a prairie region, level or gently rolling. The dip of the underlying rocks gives direction to the drainage, which is generally a little west of southwest. The main stream is Rock River or Sugar Creek, which enters south of the northeast corner and traversing the central area, passes out six miles north of the west corner of the county. Its tributaries from the north are Black and Lye creeks; from the south, Otfield, Walnut and Indian creeks. The southern and southeastern parts are drained by Big and Little Raccoon creeks and at the southwest by Coal Creek, which flows directly into Rock River. Glaciers have left the bed rock of the county covered with a drift which reaches in some places to a depth of 200 feet. In only a few places, mainly along streams, does the bed rock outcrop. The average depth of the drift, however, is very much less than the figure given above.

COLLECTION OF DATA.

In order to discuss this question intelligently, it is evident that one must be familiar with not only the past and present history of the water level of the county, but also the past and present forest, swamp and drainage conditions. To obtain data, trips were made personally to the principal towns in the county. Old residents were interviewed as to the past condition, and well-drillers and diggers were asked concerning their observations as to the water level. Stress was laid particularly on the history of old dug wells, because in these any fluctuations of the water level of the region would be evident. Owners of old wells were asked concerning the water level. From men well acquainted in the different communities visited, were obtained names of farmers who had or who would be most liable to have old dug wells on their farms. Letters of explanation and lists of questions were then sent to these men. These questions covered points concerning water level as exhibited by wells, and forest and drainage conditions, both past and present. They were asked to return answers on blanks furnished. One hundred and thirty-six letters were sent out and forty-two answers were received, eight of which contributed nothing to the solution of the problem.

PAST AND PRESENT CONDITIONS IN THE COUNTY.

Forests.—Early settlers in the county found a vast forest; broken only here and there by paths left by cyclones, and by marshy prairies. Their way had to be cut with the axe, and, from the first, war was made on the tree as an enemy to progress and civilization. Clearings were made and regular logging bees were held where thousands and thousands of trees were cut, rolled together, and burned. Great amounts of timber were used for cabins, fences, corduroy roads, etc. Practically the entire county was covered with this virgin stand of timber. The northern part of the county in the neighborhood of New Richmond, Linden, and Kirkpatrick borders on a prairie country which extends northward up into Tippecanoe, but even there the forests were in evidence. The soil over the greater portion of the county was covered with leaves, underbrush and general litter, under which was a thick layer of humus which acted as a reservoir for the rainfall of the region.

The needs of a growing population and civilization has increased the drain upon our once luxuriant forests until, today, little remains to remind us of them. Only here and there are patches of woodland, and these are so thin that they cannot be called forests at all. Fields, pastures and barren slopes have taken the place of our great stands of timber, and this has done much to lessen the efficacy of the soil as a retainer of rainfall. The following figures from the report of the statistician show the above conditions in the county:

1881.....	67,574 acres of timberland
1882.....	62,983 acres of timberland
1883.....	69,390 acres of timberland
1884.....	69,451 acres of timberland
1885.....	46,508 acres of timberland
1886.....	44,183 acres of timberland
1900.....	7,184 acres of timberland

Inaccurate data is responsible for the discrepancies in the early returns; the later reports are more reliable.

Streams.—It is evident to any one who has given the matter the slightest consideration that the flow of streams in the county is much changed. The amount of water carried by the streams is probably no less, but the flow is much more irregular, being greater than formerly in times of rain and lower in times of drouth. This is very noticeable in

Sugar Creek. This stream was once much used as a means of transportation. In 1824 William Nicholson came from Maysville, Kentucky, to Crawfordsville in a keelboat of ten tons burden, which landed at the mouth of Whitlock's Spring Branch. Trips were also made between Crawfordsville and Terre Haute in flatboats. Only the lightest of canoes can now do so. Records also show that Sugar Creek has furnished the motive power for at least nineteen mills situated along its course in Montgomery County. Not over three of these mills are now in operation, and these have to depend upon steam during most of the summer months. It may be that other factors, such as competition, have helped to cause their abandonment.

No accurate information regarding the maximum and minimum flow of the stream in different seasons in past years can be obtained, but it is the prevailing opinion that floods are now higher and more frequent and that the waters are lower during the summer months than formerly. The smaller streams of the county have also been affected. One stream near New Market has been reported as being dry for half the year, whereas, formerly it was never dry. A stream near Waveland under my own observation used to furnish fishing and swimming pools for the boys during the summer, but such sports are now rarely possible in this stream. Numerous other examples of the same nature can be cited.

This evidence proves that the water escapes from the ground in times of rain faster than formerly. From this it is evident that less water is held in the soil, thus causing a corresponding decrease in the water level of the county.

Springs.—The early settlers built their cabins where fresh water was easily obtainable. Springs were found on almost any hillside and wells were not thought of. Many springs in all parts of the county have either dried up or their water flow has been reduced. Several large springs just southwest of Crawfordsville have disappeared. Many springs have been reported as having failed or decreased in water flow in the neighborhoods of Ladoga, New Market, Waynetown, Darlington and elsewhere, all of which show a falling of the water level.

Wells.—The letters sent out dealt with the water level of old dug wells and the forest and drainage conditions in their vicinity. The data received was not such that it furnished a very reliable basis for positive conclusions and was only useful in connection with other information secured in a variety of ways. In some cases it must be remembered that

geological and geographical conditions would maintain the water level in certain small areas irrespective of the changes in soil cover, however important these might become. Many cases were cited by residents of wells which have failed. Many old wells have been dug deeper in order to keep up the flow of water. In many localities well diggers reported as having to go deeper for water than they formerly did. The weight of evidence shows that the falling of the water level is general in the wells all over the county.

Swamps.—Many places in the county have been wet and swampy. Natural ponds of greater or less extent were numerous, some of these being ten acres in area. The water level was very near the surface in these places. The region around Whitesville was especially very wet, water even running into shallow post holes. Such places have now all been drained and the ground water level much lowered.

Drainage.—A great amount of drainage has been done in the county. The county surveyor reports about 200 county ditches, open and large tile, with a probable average of two miles in length, which makes a total of 400 miles. The county is also well underdrained by many thousand rods of private tile ditches under farm lands. Swamps, ponds, wet fields, etc., have been drained and much of the water that sinks into the soil is quickly carried by ditches to the nearest stream.

Water-level.—That the water level of the county has lowered certainly needs no additional proof. Observant and intelligent men in all parts of it have given their opinion that this is undoubtedly so. The lowering has been greater in some places than in others. As reported by wells, the lowering has been 2-9 feet.

CAUSES OF THE CHANGE.

Deforestation.—That deforestation has been a great factor in causing a lowering of the water level can not be doubted. The cutting off of the timber has increased evaporation and surface run-off to such an extent as to affect the water table. One man gives the following experience: A well was dug on the farm and in ten years it went dry. During that time, a large tract of timber was removed from the farm. Another well was then dug with the same result in a few years, deforestation also having proceeded during the time. The same occurrence also happened again. Of course, it can not be asserted that deforestation was the sole cause of the lowering.

Drainage.—Drainage is also responsible in a great measure for the lower water level. The miles of tile and open ditches, city storm sewers, etc., carry a great part of the water to the streams as soon as it falls. The water is thus carried away instead of being held to feed the wells, springs, etc. Two instances have been given me in which wells went dry after sloughs, lower than but near the well, had been drained.

Greater Amounts Used.—A growing population has increased the drain upon the underground water supply. Water is put to more uses than formerly and this, no doubt, has its effect upon the water level.

RELATIVE IMPORTANCE OF ABOVE FACTORS.

It was hoped that it would be possible to separate the effects of deforestation and drainage and determine just the part each had played, but this can not be done in Montgomery County. My own judgment, based on field work and reported data, is that drainage has played as great a part in the lowering of the water level as has deforestation.

The results of this study are not as definite as were at first expected, but it is believed that the rather thorough study of such a typical county in Indiana is well worth recording, and it is hoped that it may induce others to undertake similar surveys in various parts of the State until more definite data are discovered upon which to base conclusions that, as far as Indiana is concerned, will be sufficiently reliable for real scientific work on the problem which depends upon these things.

This investigation was carried on in the Botanical Laboratory of Wash College under the direction of Prof. M. B. Thomas.

BIBLIOGRAPHY.

The following bibliography, while not complete, is sufficiently comprehensive to cover fairly the points presented.

- (1) Abbe, Cleveland. Determination of the True Amount of Precipitation and its bearing on theories of forest Influences. Forest Service, U. S. Dept. of Ag., Bull. No. 7, pp. 175-186.
- (2) Barbour, Erwin Hinecky. Wells and Windmills in Nebraska. U. S. Geo. Sur., Dept. of Int. W.-S. and Irr. Paper No. 29.
- (3) Blanford. Nature XXXIX, p. 583.
- (4) Buffault. La capacite retentionelle de la foret. Revue des eaux et forets. January, 1909, pp. 1-18, 33-34. April, 1909, pp. 229-234. Reviewed in American Forestry, March, 1910, pp. 156-173, and Forestry Quarterly, Vol. 7, pp. 322-324, September, 1909.

- (5.) Collett, John. Montgomery County. 7th Ann. R. of the Geo. Sur. of Ind., 1875, pp. 361-422.
- (6.) Curtis, George E. Analysis of the Cause of Rainfall, with Special Relation to Surface Conditions. Forest Service, U. S. Dept. of Ag., Bull. No. 7, pp. 187-191.
- (7.) Engler, Prof. Fünfte Versammlung des Internationalen Verbandes forstlichen Versuchsanstalten. Centralblatt für das gesammte Forstwesen, January, 1907, pp. 35-40. Reviewed in Forestry Quarterly, Vol. 5, pp. 91-92, March, 1907.
- (8.) Fernow, B. E. Forest Influences. Forest Service, U. S. Dept. of Ag., Bull. No. 7, pp. 9-22.
- (9.) —————. Relation of Forests to Water Supplies. Forest Service, U. S. Dept. of Ag., Bull. No. 7, pp. 123-170.
- (10.) Finney, John H. The Connection Between Forests and Streams. American Forestry, Feb. 1910, pp. 109-110.
- (11.) Fuller, M. L. Underground Waters of Eastern United States. U. S. Geo. Sur., Dept. of the Int. W.-S. and Irr. Paper No. 114.
- (12.) Glenn, L. C. Forests as Factors in Stream Flow. American Forestry, April, 1910, pp. 217-224.
- (13.) Harrington, M. W. Review of Forest Meteorological Observations, a Study Preliminary to the Discussion of the Relations of Forest to Climate. Forest Service, U. S. Dept. of Ag., Bull. No. 7, pp. 23-122.
- (14.) Haworth, Erasmus. Underground Waters of Southwestern Kansas. U. S. Geo. Sur., Dept. of the Int. W.-S. and Irr. Paper No. 6.
- (15.) Henry, Alfred J. Rainfall of the United States. Ann. R., U. S. Weather Bureau, 1896-97, p. 317.
- (16.) Hough, Franklin B. Report upon Forestry. U. S. Dept. of Ag., 1877.
- (17.) King, F. H. Principles and Conditions of the Movements of Ground Water. 19th Ann. R. U. S. Geo. Sur., Part II.
- (18.) Leighton, M. O., and H. Horton. The Relation of the Southern Appalachian Mountains to Inland Water Navigation. Forest Service, U. S. Dept. of Ag., Circular 143.
- (19.) Leverett, Frank. Wells of Northern Indiana. U. S. Geo. Sur., Dept. of the Int. W.-S. and Irr. Paper No. 21.
- (20.) —————. Wells of Southern Indiana. U. S. Geo. Sur., Dept. of the Int. W.-S. and Irr. Paper No. 26.

- (21) Mattoon, W. R. Measurements of the Effects of Forest Cover upon the Conservation of Snow Water. *Forestry Quarterly*, Vol. 7, pp. 245-248. September, 1909.
- (22) Moore, Barrington. Checking Floods in the French Alps. *American Forestry*, April, 1910, pp. 199-206.
- (23) Moore, Willis L. The Influences of Forests on Climate and on Floods. House of Representatives. U. S. Com. on Ag.
- (24) Oppokov, E. V., and H. Schreiber. Are Swamps Regulators of Water Flow and Should they be Drained? Pub. by the "Khozian," 1904, p. 52. Reviewed, *Forestry Quarterly*, Vol. 5, pp. 370-372., November, 1905.
- (25) Otoski. Die russischen Untersuckungen iiber den Einfluss des Walden auf den Grundwasserstand. *Centralblatt f. d. g. Forstwissen*, July, 1907, pp. 311-318. Review, *Forestry Quarterly*, Vol. 5, pp. 325-326.
- (26) Pinchot, Gifford. Relation of Forests to Stream Flow. *Ann. Am. Acad.* 31, pp. 219-227, January, '08.
- (27) Rafter, George W. The Relation of Rainfall to Run-off. U. S. Geo. Sur., Dept. of the Int. W.-S. and Irr. Paper No. 80.
- (28) Record, Samuel J. Forestry Conditions in Montgomery County. *Proc. Indiana Academy of Science*, 1902, p. 84.
- (29) Roth, Filibert. The Appalachian Forests and the Moore Report. *American Forestry*, April, 1910, pp. 209-217.
- (30) Schlick, W. *Manuel of Forestry*, Vol. 1.
- (31) Schubert. Wald und Niederschlag in Schlesien. *Zeitschrift für Forst. und Jagdwesen*, June, 1905, pp. 375-380.
- (32) —————. Wald und Niederschlag und die Be-einflussung der Regen und Schneemessung durch den Wind. *Zeitschrift für Forst. und Jagdwesen*. November, 1906, pp. 728-735. Review, *Forest Quarterly*, Vol. 5, pp. 419-20, December, 1907.
- (33) Schwarz, G. Frederick. The Diminished Flow of the Rock River in Wisconsin and Illinois, and its Relation to the Surrounding Forests. Forest Service, U. S. Dept. of Ag., Bull. No. 44.
- (34) Shimek, B. Evaporation in its Relation to the Prairie Problem. Review, *Science*, U. S. Vol. XXXIII. No. 840, February 3, 1911.
- (35) Spalding, V. M. Soil and Water in Relation to Transpiration. *Torrey*, February, 1905, pp. 25-27. *Forestry Quarterly*, Vol. 3, p. 167, May, 1905.

- (36) Slichter, Charles S. The Motions of Underground Water. U. S. Geo. Sur., Dept. of the Int. W.-S. and Irr. Paper No. 67.
- (37) —————. Theoretical Investigation of the Motion of Ground Waters. 19th Ann. R., U. S. Geo. Sur., 1897-98, Part II.
- (38) Swain, George F. "The Influence of Forests on Climate and Floods." A Review of Prof. Willis L. Moore's Report. American Forestry, April, 1910, pp. 224-240.
- (39) Toumey, James W. The Relation of Forests to Stream Flow. Reprint. Yearbook of U. S. Dept. of Ag. for 1903.
- (40) Tolsky, A., and E. Henry. Les forets de Plaine et les Eaux Souteraines. (Extrait des annals de la Science Agronomique francais et etrangere 2 Serie, 8 annee, 1902-03. Tome I.) Review, Forestry Quarterly, Vol. 3, p. 370.
- (41) Tolsky, A. P. Transactions of the Imperial Forest Institute, Vol. X. St. Petersburg, 1903. Reviewed, Forestry Quarterly, Vol. 5, pp. 54-55. Feb. 1905.
- (42) Velschow, Frantz A. The Cause of Rain and the Structure of the Atmosphere. Trans. Am. Soc. Civil Eng., Vol. XXXIII, 1890, p. 303.
- (43) Vermeule, C. C. New Jersey Forests and their Relation to the Water Supply. The Engineering Record, Vol. XLII, No. 1, July, 1901.
- (44) Wysotski, Lesnoj jornal. All gemeine Forst. u. Jagdzeitung. September, 1907, pp. 318-320. Reviewed, Forestry Quarterly, Vol. 5, pp. 417-419.
- (45) Wilmont, S. Eardley. The Influence of Forests on the Storage and Regulation of the Water Supply. Indian Forest Service. 58 pp. 8 Calcutta, 1906. Reviewed, Forestry Quarterly, Vol. 5, pp. 57-58, March, 1907.

THE GEOLOGICAL CONDITIONS OF MUNICIPAL WATER SUPPLY IN THE
DRIFTLESS AREA OF SOUTHERN INDIANA.

BY E. R. CUMINGS.

- I. Introduction.
 - Description of the driftless area.
 - Character of the rocks and topography.
- II. The Knobstone area.
 - Peculiarities of the rock formations.
 - Topography and soil.
 - Water-bearing qualities.
 - Water-producing qualities of the alluvial valleys of the region.
 - Climatological data of the driftless area.
 - Relation of rainfall to runoff.
 - Conditions affecting the impounding of water in the Knobstone region.
 - Proper construction of dams.
 - Indiana University dam.
- III. The limestone area.
 - Peculiarities of the rock formations.
 - Topography and soil.
 - Cavernous character of the rocks and development of underground drainage.
 - Difficulties of impounding water.
 - Character of the springs of the region.
 - General inadequacy of springs without impounding the water.
 - Deep and shallow wells.
 - Valley alluvium.
- IV. The Chester-Mansfield area.
 - Peculiarities of the rock formations.
 - Topography and soil.
 - Intermediate character of the region.
 - Conditions affecting the impounding of water.
 - Wells.

V. Relation of forests to water supply in the driftless area.

Runoff and ground water.

Erosion.

Siltling of ponds.

VI. Summary.

I.

The problem of municipal water supply involves a large number of factors, among which the geological conditions enter with varying importance, and have received a varying degree of emphasis at the hands of water-supply engineers. Some, as for example Vermeule¹, have been inclined to assign to the geological factors an importance second only to that of the fundamental factors of rainfall and run-off. Others, as Rafter², assign only secondary importance to the geological conditions. This difference of opinion is very probably attributable, in some degree, at least, to the sort of regions that have fallen most under the study of the respective students of these problems. In the glaciated portion of the United States, for example, where the geological conditions are apt to be measurably uniform over large areas, and where, at all events, the country rock is apt to be so deeply buried as to have little effect on the character and movements of surface waters, it is altogether likely that the geological factors, other than topography, would have received a relatively small amount of attention. In driftless areas, on the other hand, such as the area at present under consideration, the character of the rock formations may powerfully affect the case; and as a matter of fact, in this region, the geological factors are, next to rainfall, the most important factors to be taken into consideration.

The driftless area of southern Indiana comprises all of the counties of Floyd, Harrison, Perry, Crawford, Orange, Lawrence, Spencer and Warrick, and portions of the counties of Clark, Washington, Jackson, Brown, Monroe, Greene, Martin, Dubois, Pike, Gibson, Vanderburgh and Posey. It is a region of varied, but on the whole of rather strongly accentuated topography. The eastern portion of this area, the region of

¹ *Vermeule, C. C.*, Geological Survey of New Jersey, Report on water-supply. Vol. iii of the Final Report of the State Geologist, 1894.

² *Rafter, G. W.*, Hydrology of the State of New York, New York State Museum, Bull. No. 85, 1905.

the "Knobs," comprising the counties of Floyd, eastern Washington, Jackson and Brown, and lapping over into eastern Lawrence and Monroe, is a region of mature topography, with deep, steep-sided valleys, very little level upland, and broad flat valleys only on the larger streams. To the west of this lies the great limestone region (Mississippian limestones) in Harrison, western Washington and eastern Orange, central Lawrence and Monroe, and northeastern Owen counties. The topography of this region is rolling, with deeper valleys on the eastern and western edges only. It is the region of caves and sinkholes, and consequently, to a marked degree, of underground drainage¹. It is also the region of chief interest in the present connection.

To the west of the limestone belt lies the region of the Chester (Huron) formation and the Mansfield sandstone, which for our present purposes may be treated as a unit. Topographically this region bears considerable resemblance to the region of the "Knobs." In places it is even more rugged, as in Martin and Crawford counties. One important point of difference, however, from the standpoint of the water-supply engineer, is the fact that in this region of the Chester formation, the larger streams cut through the shales and sandstones to the limestone beneath, while in the region of the "Knobs," the valley floors are always in the same material as their sides. This type of valley in the Chester region is well exemplified by Richland Creek, in Monroe and Greene counties, and by French Lick Creek in Orange County.

To the west still of the region of the Chester and Mansfield formations, is the region of the Coal Measures, which presents no points of special interest to the present discussion.

Broadly speaking, we may say that the driftless area presents, from the standpoint of the water-supply engineer, two main types of geo-

¹ For descriptions of the geology, topography and caves of this region see: *Blatchley, W. S.*, Indiana Caves and their fauna, 21st Ann. Rept. Indiana Dept. Geol. and Nat. Res., 1897, pp. 120-212; *Hopkins, T. C.*, and *Siebenthal, C. E.*, The Bedford Oolitic limestone of Indiana, *Ibid.*, pp. 289-427; *Newsom, J. F.*, A geologic and topographic section across southern Indiana, *Ibid.*, 26th Ann. Rept., 1901, pp. 227-302; *Ashley, G. H.*, and *Kindle, E. M.*, The geology of the Lower Carboniferous area, *Ibid.*, 27th Ann. Rept., 1902, pp. 49-122; *Shannon, C. W.* and others, The Indiana Soil Survey, in the 32d to 34th Ann. Repts., *Ibid.*, 1907-10; *Cummings, E. R.*, On the weathering of the Subcarboniferous limestones of southern Indiana, Proc. Ind. Acad. Sci. for 1905, pp. 85-100; *Greene, F. C.*, Caves and cave formations of the Mitchell limestones, *Ibid.*, for 1908, pp. 175-183; *Beede, J. W.*, The cycle of subterranean drainage as illustrated in the Bloomington, Indiana, quadrangle, *Ibid.*, for 1910, pp. 81-111.

logical formation, and a type intermediate between them. One of these principal types, the Knobstone formation, consists of compact, insoluble, impervious sandstones and shales; and the other, the Mississippian limestones, consists of conspicuously fissured and jointed, highly soluble, and consequently pervious limestones. It is also apparent that these two principal types of formation present interesting differences of topography, which are of importance to the student of water-supply problems.

II.

The first of these, the Knobstone formation, consists of a considerable thickness of fine-grained sandstones, with clay cementing material; and of sandy shales, becoming more argillaceous toward the base of the formation. Both sandstones and shales are impervious to an unusual degree. The evidence of this is seen in the general absence of springs in the region of the Knobstone formation, in the impossibility of obtaining good wells, either deep or shallow in the rock, and in the small dry-weather flow of the streams in the area underlain by this rock. An indirect evidence of the minute size of the pores of the Knobstone sandstones, is the damage that the rock suffers when exposed to freezing. Experiment and microscopical examination reveal the same thing. If a sample of the rock be tested, it will be found to absorb water rather readily, but to transmit it very slowly. As a matter of fact the purely geological evidence already presented, of the imperviousness of the rock, is altogether more satisfactory than the experimental evidence mentioned, because it deals with the formation in masses commensurate with those with which the water-supply engineer has to deal.

What the Knobstone formation lacks in water-bearing qualities, it more than makes up in its perfection as a substratum for reservoirs and ponds. Its qualities in this respect will be brought out in the description of a typical water-supply plant—that belonging to Indiana University—and need not be further discussed at this point. It is sufficient to say here that wherever the conditions are such that an adequate supply of pure water can be impounded, the Knobstone formation may be depended on, with properly constructed works, to hold the water with a minimum of leakage, and with perfect security to whatever structures are placed upon it.

The soil cover in the region of the Knobstone is usually rather thin, owing to the steepness of the slopes. It is of a sandy character, more

er less mixed with clay, and is not in its usual state a fertile soil. As a consequence of this last fact, it is apt to be covered with a rather open and scanty vegetation. Where under cultivation, unless great care is observed, the steeper slopes gully badly¹. Where this soil is fairly sandy and of some thickness, good well water may be obtained for domestic supply. Owing to its usual thinness and indifferent permeability, however, it is not a good conserver of the ground-water, and consequently, in common with the underlying rock, constitutes a poor reservoir for equalizing the flow of streams.

Some of the larger valleys of the Knobstone region contain considerable thicknesses of alluvium. Examples of this type of valley are the Bean Blossom and Salt Creek in Brown and Monroe counties, and the White and Muscatatuck rivers. All of these streams enter the area from the glaciated region, and their flood plain deposits are therefore composite, consisting partly of valley-train material, and partly of silt, pebbles and sand washed from the neighboring hills. The nature of these valley deposits, so far as concerns their water-bearing qualities, has not yet been investigated in a satisfactory manner. Some evidence obtained in the Bean Blossom Valley in the vicinity of Bloomington indicates that the valley train in that valley is both deep and amply provided with pervious water-bearing strata. The evidence referred to is the log of a well 70 feet deep, drilled about a year ago in the valley near Bloomington. This well passed through 10 feet of white sand and 15 feet of gravel before reaching the depth mentioned. No attempt has been made by the owners of the well to ascertain the maximum yield.

The geological history of Bean Blossom Valley and of other similar valleys coming out of the glaciated into the driftless area is such as to indicate that these strata of sand and gravel, revealed in the Bloomington well, are extensive. It is not necessary to enter into the details of this subject here. They may be found in the writings of Mr. Leverett² of the U. S. Geological Survey. At least one indication of the immense quantities of water that must be carried as underflow by these valleys is the fact that the majority of the smaller streams and gulleys that emerge upon the sides of the valley do not flow out to the main stream

¹ *Shannon, C. W.*, Indiana soil types, Indiana Dept. Geol. and Nat. Res., 32d Ann. Rept., 1908, pp. 99-105.

² *Leverett, Frank.* The Illinois Glacial Lobe, Monog. U. S. Geological Survey, No. XXXVIII, 1899.

at all, but deliver their water to the pervious alluvium of the valley, and build their transported sediment into alluvial fans. These fans are a prime characteristic of the larger valleys of the driftless area.

In one instance the water-producing qualities of a valley of the Knobstone region have been carefully investigated by the writer, in connection with the investigations instituted with a view to obtaining the best available water-supply for Indiana University. This is the case of the valley of Griffey Creek at a point four miles due north of Bloomington. The valley at this point is about 1,000 feet wide, and the drainage area above the point where the tests were made is about seven square miles. The valley receives its water from steep slopes, and is entirely outside of the glaciated region. It contains no glacial drift of any sort. At the point named, four holes, about equally spaced across the valley, were drilled with an eight-inch soil augur through the alluvium to bed rock. The two nearest the west side of the valley reached a coarse impure gravel at a depth of eight feet. The two toward the east side of the valley passed through eighteen feet of fine silt, and very fine dark blue sand, and finally through two feet of coarse gravel to bed rock. All of these bores reached bed rock at a depth of about twenty feet.

At the second hole from the west side of the valley, a measurement of the rate of flow of the ground-water was made in the following manner: Four drive points were sunk into the gravel beds, so placed that one well was up stream and three down stream. The three down-stream wells were two feet from each other and each four feet from the up-stream well. The middle down-stream well and the up-stream well were as nearly as possible in the main axis of the valley. The up-stream well was then dosed with fluorescein, and the interval that elapsed before the reagent could be detected in the down-stream wells was noted. At the end of six hours the fluorescein was first detected in the middle down-stream well. It did not appear in the other two down-stream wells. It is believed that the fluorescein would not have diffused at a rate that would introduce any appreciable error into this computation, and consequently the rate of flow of the ground-water under this valley may be taken as about two-thirds foot per hour, or sixteen feet per day. Near this same spot a large test well, five feet in diameter, was sunk to bed rock. This well passed through eight feet of fine silt and twelve feet of fairly clean gravel. Careful tests of this well made by pumping it out

and noting the rate of filling, indicate a capacity of 12,000 gallons per day, under a head of fifteen feet, the water-table being depressed five feet when the test was made. This is probably about the usual dry weather depression. Allowing 50 per cent. interference of wells, this valley should produce 50,000 gallons of water per day during the driest year. Such a supply would be sufficient for a town of 1,000 population, and would be of first-class quality.

There are many valleys of this type in the Knobstone region, that would be good water producers for small towns, or for manufacturing plants. The water would be of excellent character and exceptional purity. The larger valleys, such as Bean Blossom, should furnish sufficient well-water for cities of 10,000 inhabitants or less, or for extensive industrial plants.

The conditions affecting the impounding of water in the Knobstone region can not be adequately discussed without introducing certain climatological data. Since these data will also serve for the limestone region, they may properly be discussed in full at this point.

The following climatological data are obtained principally from the publications of the U. S. Weather Bureau. Between the coldest and warmest portions of this section of the State there is a difference of about 5 degrees in the mean annual temperature. The warmest localities are in the Wabash and Ohio valleys, the temperature increasing quite regularly from the upper to the lower portion of each valley. The mean annual temperature varies from about 52 degrees at the north end of the area, to nearly 57 degrees at Evansville.

The length of the growing season is somewhat greater in the southern than in the northern portion of the area under consideration. It is from two to three weeks longer at the Ohio River than in the northern part of Indiana.

The mean annual precipitation varies from about 40 inches to 55.21 inches (at Marengo). The maximum precipitation for any one year within the area was 97.38 inches at Marengo, in 1890. The maximum for any one month is 18.00 inches, also at Marengo, in August, 1888. The minimum for one month is a trace in October, 1908, at Mt. Vernon. Precipitations of 10 inches or more in one month are not uncommon, having been recorded an aggregate of 35 times at the seven stations reporting within the area. Ten of these were in the month of March,

four each in January, July and August; three in September; and two each in February, June and November. Over ten inches have not been reported in any of the remaining months. Six inches or more have been reported an aggregate of 233 times at these seven stations. Of these 18 were in January, 28 in February, 44 in March, 19 in April, 18 in May, 25 in June, 14 in July, 17 in August, 8 in September, 8 in October, 26 in November and 9 in December. Less than 1 inch has been reported an aggregate of 120 times at the seven stations. Of these, 6 were in January, 14 in February, 4 in March, 4 in April, 3 in May, 1 in June, 11 in July, 10 in August, 25 in September, 25 in October, 12 in November and 5 in December. These statistics by stations are as follows: At Bloomington there have been 10 inches or more of rain in one month, twice. There have been 6 or more inches 19 times; and less than 1 inch 11 times (indices, 1-78, 1-8 and 1-14)¹. At Paoli, there have been 10 or more inches 2 times; 6 or more inches 16 times; and less than 1 inch 12 times (indices, 1-66, 1-8 and 1-11). At Jeffersonville there have been 10 or more inches 4 times; 6 or more, 34 times; and less than 1 inch 22 times (indices, 1-78, 1-9 and 1-14). At Marengo there have been 10 or more inches 18 times; 6 or more, 77 times; and less than 1 inch, 17 times (indices, 1-17, 1-4 and 1-18)². At Evansville, there have been 10 or more inches 6 times; 6 or more inches, 51 times; and 1 inch or less 32 times (indices, 1-64, 1-7 and 1-12). At Rome there have been 10 inches or more, once; 6 inches or more, 8 times; and 1 inch or less, 5 times (indices, 1-68, 1-8 and 1-13). At Mt. Vernon, there have been 10 inches or more, 4 times; 6 inches or more, 36 times; and 1 inch or less, 21 times (indices, 1-66, 1-7 and 1-12). The mean annual precipitation for these towns is as follows: Bloomington, 43.43; Paoli, 43.47; Jeffersonville, 42.51; Marengo, 55.21; Evansville, 44.11; Rome, 44.62; Mt. Vernon, 42.65. The maximum annual precipitation for these stations is as follows: Bloomington, 52.15 (in 1898); Paoli, 55.86 (in 1907); Jeffersonville, 54.16 (in 1898); Marengo, 97.38 (in 1890); Evansville, 70.61 (in 1882); Rome, 57.12 (in 1905); Mt. Vernon, 57.46 (in 1890). The

¹In order to compare the data of the several stations, it is necessary, since the length of record varies notably, to divide the number of times a given precipitation is reported at a given station by the total number of monthly reports for that station. Thus for Bloomington, where the length of record is 13 years, the divisor is 156. Since in each the numerator is made 1, these indices are only approximate.

²The unusual character of the record at Marengo arouses suspicion that some mistakes have been made in measuring the precipitation at that station.

minimum annual precipitation for these stations is as follows: Bloomington, 33.14 (in 1901); Paoli, 29.12 (in 1901); Jeffersonville, 30.18 (in 1904); Marengo, 32.37 (in 1901); Evansville, 28.65 (in 1887); Rome, 35.86 (in 1904); Mt. Vernon, 34.10 (in 1902).¹ At Indianapolis, which has a rainfall record going back without interruption to 1871, a period of forty years, the minimum recorded precipitation for any one year is 30.33 inches, in 1901.

An analysis of these data by seasons is interesting, and for our purposes more valuable than any other. Water-supply engineers are agreed on dividing the year into three periods, as follows: (a) The storage period, which in this latitude is ordinarily made to include the months from December to May, inclusive; (b) the growing period, from June to August, inclusive; and (c) the replenishing period, from September to November, inclusive. It is a well-known fact that in many years, and especially in dry years, the run-off is practically confined to the months from December to May, inclusive. It is important to ascertain, therefore, what is the minimum expectation of rain in these months. From the stations reporting there have been the following low precipitations during the storage period: Bloomington, 14.35 (Dec., 1895, to May, 1896) 16.58 (Dec. 1900, to May, 1901); Paoli, 13.03 (Dec. 1900 to May, 1901); Jeffersonville, 15.80 (Dec., 1888, to May, 1889), 13.02 (Dec., 1900, to May, 1901); Marengo, 14.58 (Dec., 1900, to May, 1901); Evansville, 11.83 (Dec., 1900, to May, 1901); Mt. Vernon, 12.70 (Dec., 1900, to May, 1901). The year 1901 will be remembered as one of the most disastrously dry seasons on record. It is clear, from the above data, that as low as 12 inches of rain may be expected within the area, during the storage period. A deficiency in this period is rarely made up by an excess of rainfall in the other periods of the year. In fact, a very considerable excess would be necessary to overbalance the effects of a deficiency in the winter and spring months. In other words, a relatively wet summer, following a dry winter and spring does not necessarily mean an ample supply of water for municipal use. During the summer months not only is all of the rainfall ordinarily consumed in the growth of plants and in other sources of evaporation, but in addition the ground-water is more or less extensively drawn upon, leaving a deficiency of ground-water at the end of the growing season, that must be made good

¹1901, for which one month's report is lacking, was undoubtedly drier by several inches than 1902.

by the rains of the fall season (the replenishing period). If, now, there is a deficiency of rain in the replenishing season also, a greater or less proportion of the rainfall of the winter and spring months must go to fill up the ground, and the run-off of this period will be correspondingly decreased. The most unfavorable condition, therefore, is a dry fall, followed by a dry winter and spring. If, for example, such a fall as that of 1908, with as low as 2.2 inches of rain at several of the stations, for the three months, September, October and November, should be combined with such a winter and spring as that of 1900-1901 (a not impossible contingency), the probable catch of water, on the basis of 50 per cent. of the rainfall of the storage period, would be only 5 inches for the entire year¹.

The available catch of water in a dry season, that is, one of 30 inches of rainfall, will be a considerably smaller proportion of the rainfall than the catch of a wet season. In the latter case the run-off may be from 50 to 60 per cent. of the rainfall, while in a dry season it is likely to fall as low, in the region under consideration, as 25 per cent., or even lower.² From these data it appears that there will be years

¹ It is not deemed necessary to enter here into the technical discussion of the relation of rainfall to run-off. A very full discussion of these points may be found in the works of Vermeule and Rafter, cited above. Ordinarily, in this latitude the run-off of the winter and spring months may vary from 50 to 75 per cent. of the rainfall. For the remaining months of the year it will vary from 0.0 to 20 per cent. of the rainfall. Unfortunately there are no satisfactory run-off data for the region. The gagings at Shoals from 1903 to 1906, inclusive, are the only ones of a stream lying largely within the region under consideration. These indicate a mean annual run-off of 12.53 inches, which is about 30 per cent. of the rainfall of the region for the same interval. (The mean annual rainfall for the nearest station, Paoli, for this interval was 42.75 inches.) This interval includes two years of less than 40 inches rainfall, namely, 1903, with 35.18 inches, and 1904, with 39.09 inches. On the Muskingum River in Ohio, a stream lying in a region of similar topography and climatic conditions to the catchment of the east fork of White River, and like the latter, mostly in the driftless area, the run-off has been known to fall as low as 25 per cent. of the rainfall.

² The run-off formulae of Vermeule are of interest in this connection. While designed to cover the conditions in New Jersey and southeastern New York, they are based on certain general considerations, such for example as mean annual temperature, etc., which are applicable to other regions as well. Vermeule's general formula is: $E = (11 + 0.29 R) M$, where E stands for annual evaporation, R for rainfall, and M is a factor depending on mean annual temperature. The values of M are as follows for the mean annual temperatures noted in the present region: 52°, 1.14; 53°, 1.18; 54°, 1.22; 55°, 1.26; 56°, 1.30; and 57°, 1.34. Thus for a mean annual temperature of 52° the evaporation, with a rainfall of 30 inches, should be 22.46 inches, and this subtracted from the total rainfall would leave a run-off for the year of 7.54 inches. For the higher temperatures the run-off would be correspondingly less, and might, according to the formula, fall as low as 2 inches. It is not probable, however, that it ever does fall as low as the latter figure.

when we can not safely count on more than about 7.5 inches of run-off, at the northern end of the area, and possibly not more than two or three inches at the southern end. If several dry years occur in succession, as, for example, 1899, 1900 and 1901 at Bloomington, the problem of water-supply becomes all the more difficult.

We are now prepared to return to the conditions affecting the impounding of water in the region under discussion. That the flow of any except the largest streams of the region, such as the White, Blue and Ohio rivers, will be insufficient for municipal water-supply, without provision for impounding the run-off of the wet season, is a certain inference from the data presented above¹. It has also been shown that there are no springs in the Knobstone area that are of use for other than domestic purposes; and in dry seasons it may be said that there is scarcely a spring of living water in the entire region. It will be necessary, therefore, for all towns, not located on one or other of the two or three largest streams of the area, to build reservoirs and impound water for municipal supply, except in those instances, already discussed, where the underflow of such valleys as the Bean Blossom, Salt Creek, etc., is available.

It has already been pointed out that for the purposes of impounding water the Knobstone formation is almost ideal. This is especially true of the upper portion of the formation, known as the Riverside sandstone. The latter, where it has not been exposed to the weather, and especially to frost action, is very firm, close-grained, impermeable, insoluble and strong. Its toughness and resiliency are remarkable. When the fresh rock is struck with the pick it is almost impossible to force off a clean spall, especially when the rock is wet. The rubber-like toughness of the rock causes blow after blow to spend itself with little effect. The writer has also noticed this same peculiarity of the rock in blasting. Instead of shattering the rock extensively, the whole charge will often enough spit out of the drill hole with little effect, or raise only a few fragments of rock in the immediate vicinity of the charge. This difficulty in blasting was experienced in the excavation of the cuts on the Illinois

¹ During the dry season of 1908, the writer observed the condition of the larger streams in the vicinity of Bloomington, drawing their water supply largely from the Knobstone region. In the Bean Blossom, the water stood in the deeper pools only. One mile from the mouth of this stream, with a drainage area of nearly 200 square miles, all of the riffles were dry. That is, all surface flow of the stream had completely ceased. The condition of Salt Creek was similar.

Central Railway, and again in the excavation for the foundation of the Indiana University dam. When, however, the rock is exposed to the action of the sun in summer, and of frost in winter, the differential expansion and contraction in the one case, and the wedging effect of the freezing of interstitial water in the other, rapidly reduce the rock to a mass of fragments, which in turn slack down to a sandy soil. For this reason the sandstone is of no account as a building stone. The peculiarities of the rock, just enumerated, are due in large measure to the fineness of the grain, and to the fact that the cementing material is clay, which, when moist, gives the rock its unique toughness and impermeability.

Structurally also this sandstone is extremely favorable as a substratum for dams. It is singularly free from open joints and bedding planes. In the case of the University dam, which is $116\frac{1}{2}$ feet long at the base and 34 feet high above the rock, there is not a single joint or bedding seam in the rock except near the top. The bottom and ends of the dam are in perfectly sound and unfissured rock. The thickness of weathered rock that it is necessary to remove in order to reach structurally sound material is usually slight. In the case of the University dam again, the maximum depth of excavation into rock was about five feet. On the crests of narrow ridges the rock will be found to be weathered to a greater depth than the above figure. But under the alluvium of valleys, and on the sides of steep hills, the depth of weathered and fractured rock should seldom be great¹.

The Riverside sandstone constitutes approximately the upper 100 feet of the Knobstone formation. Below this are alternating shales and sandstones, with the shale predominating. This shale is sandy or argillaceous, and toward the lower part of the formation, as may be seen in the quarries of the Lehigh Cement Company, at Brownstown, it becomes dark colored and somewhat carbonaceous. When unweathered the shale is firm and tough, and shows, on account of its sandy character, very little tendency to slip under heavy loading. In the excavation of the cuts on the Illinois Central, most of the shale required heavy blasting, and like the sandstone, described above, was tough and hard

¹The reason for this is clear enough, when it is remembered that the only agents of weathering that materially affect this rock are mechanical, such as insolation, frost action, and the wedging action of tree roots; and that unlike the limestone, presently to be discussed, it is not at all affected by solution—an agent that acts to much greater depths.

to shoot. Like the sandstones, also, it will not endure frost action and insolation. Structurally and texturally it is very impermeable, and ideally free from objectionable joints and crevices. Sound rock will usually be found fairly near the surface, especially on steep slopes.

This shale formation is known to geologists as the New Providence shale. It is 400 to 500 feet thick. Where, in the eastern portion of the Knobstone area the larger streams cut through the New Providence shale, they enter the upper portion of the New Albany black shale, which is, like the former, a very impervious formation. It is evident, therefore, that any part of the Knobstone region will afford satisfactory foundations for dams of all sorts.

The proper type of dam for the Knobstone region will depend, of course, on the conditions at the particular site. In the majority of cases comparatively narrow, deep, steep-sided valleys will have to be dealt with; and this will be so in practically every instance where only a few square miles of catchment are needed.¹ For this type of valley where the breadth of the valley floor is not more than 300 feet, the most satisfactory, as well as the cheapest type of dam, is the concrete dam, arched up-stream to a radius of 200 feet or more. Such a dam, depending to a large degree on its curvature for its stability under water pressure, may be built with less material than any other type of safe, permanent dam. The construction should be such that the water face of the dam is perfectly tight. The balance of the dam may, however, be built of rubble concrete (uncoursed stone) i. e., large stone imbedded in a mortar of concrete. Some reinforcing steel to assist the structure in taking up the strains due to setting of the concrete and to thermal readjustments, will tend to prevent cracking. After the pressure of the water comes against the dam, there should be no tendency of an arch dam to crack. The ends and base of the dam should be mortised into the solid, unweathered rock, and every precaution should be observed to make these contacts perfectly water-tight.

¹From the rainfall and run-off data given above, it will be seen that it is not safe in the present region to allow more than 25 per cent. of the rainfall of a dry season as available for impounding. This will approximate 300,000 gallons per day from each square mile of catchment with reservoir capacity sufficient to hold the entire run-off of the year. With reservoir capacity sufficient to hold the run-off of the three driest years—it is not economical to increase capacity beyond this point—the yield can be increased by about 50 per cent. A very full discussion of this subject will be found in the article on Water Supply in the 11th edition of the *Encyclopædia Britannica*, by Mr. G. F. Deacon. This article is a mine of information on most phases of water supply.

Earth dams will not ordinarily be feasible in the Knobstone region, owing to the general lack of clay of good puddling qualities for the core or the dam. In the edge of the limestone region such clay may be available, but would in most cases have to be moved down very steep slopes at considerable expense. Except on large contracts, where the construction of a cable-way would be worth while, the use of clay for short dams would probably be more expensive than concrete¹. In some instances it might be advisable to use earth embankments with a reinforced concrete core, mortised well into the rock, and extending to the top of the structure. With this type of construction any sort of material, having the requisite stability, could be used for the embankments, since the waterproof qualities of the dam would depend entirely on the core. Great care is necessary in this type of dam to prevent settling of the embankments in such a way as to warp or crack the core. It is best that no water should be allowed to come against the dam until thorough settling has taken place. For long dams in the Knobstone region some such construction as that just described is almost a necessity.² It may be said finally that timber dams are only makeshifts, and should not be tolerated by any community.

As an example of a successful concrete arch dam in the Knobstone region, a brief description may be given at this point of the dam recently built by Indiana University. The cross-section of this dam is shown in the accompanying figure (Fig. 1), and photographs of the dam and pond in Figs. 2, 3 and 4. The length of the dam on the rock substratum is $116\frac{1}{2}$ feet, and on the crest 200 feet. The thickness at the base is $28\frac{1}{2}$ feet, and the total height subject to water pressure is 34 feet. The maximum height above the valley alluvium is 28 feet. The dam is stepped up in ledges on both the up-stream and down-stream faces, and the cross-section is such that ample stability is provided, even without any arching. The arching (to a radius of 340 feet) gives very greatly increased stability under water pressure, and vastly decreases the liability

¹ As a matter of fact, nearly all of the bids on earth dams for the University were higher than on the type of concrete dam constructed, and to be described later.

² A type of dam, consisting of a thin plate of reinforced concrete, supported by buttresses of concrete is described in Buel and Hill's treatise on reinforced concrete, and has actually been constructed, in a few cases. This type of dam uses a minimum of structural material, but demands a considerable outlay for forms. It would probably cost about the same as a good rubble concrete dam.

to cracking. The dam is mortised into the rock on both bottom and ends, and is also anchored to the rock by 1-inch steel bars, grouted into the rock and extending well up into the dam. Reinforcing bars of $\frac{5}{8}$ -inch section lap past these and extend to the top of the structure, being spaced four feet apart. The center of the crest and of all ledges is one foot lower than the ends, so that the water spills over the middle section of the dam. The pump installation is a triplex Deming pump, driven by a 25 H. P. Otto gasoline engine; and it works against a 220 to 240 foot static head. The water is pumped one mile to a reinforced concrete

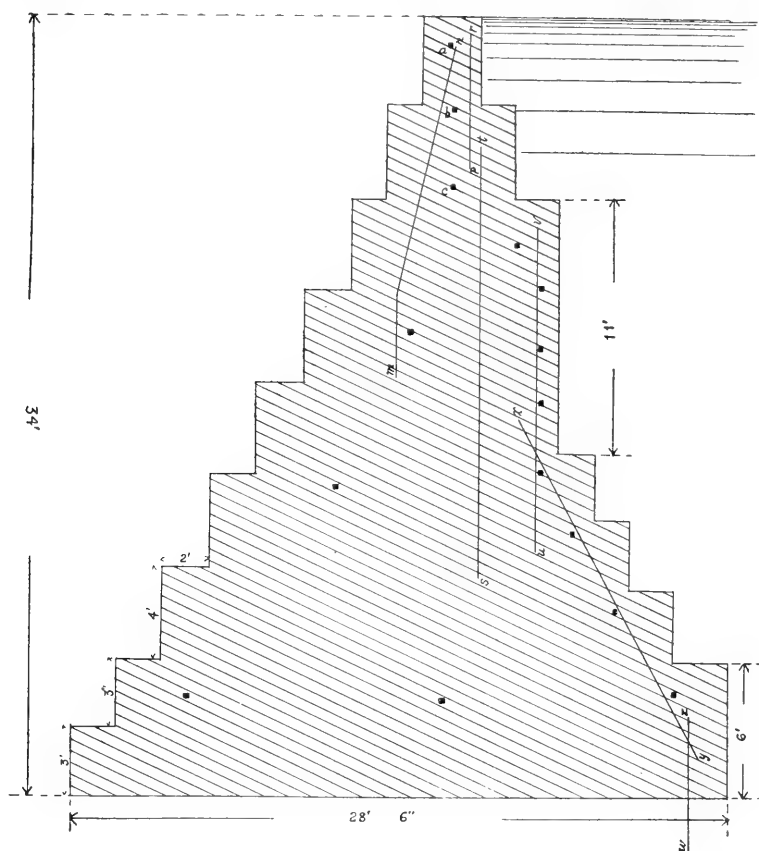

Fig. 1. Indiana University dam. Cross-section, showing dimensions, and distribution of reinforcing steel (a, b, c, etc., m-n, s-t, etc.). After a drawing by A. L. Foley.



Fig. 2. Indiana University dam, seen from the valley below the dam. Each ledge is 4 feet high. Three ledges are concealed beneath the ground.



Fig. 3. Indiana University water-works dam from above north end, showing arching up-stream.

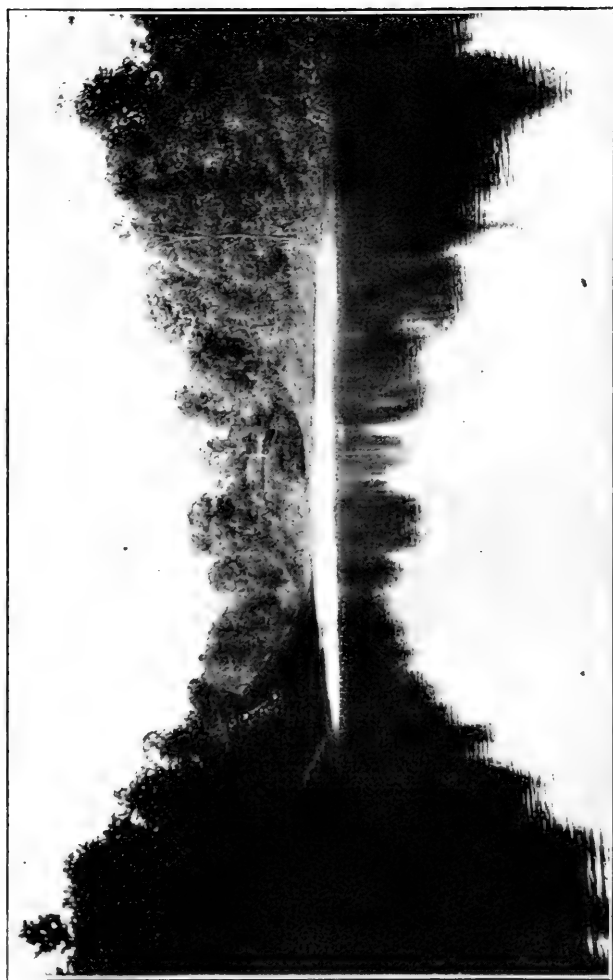

Fig. 4. Indiana University water-supply pond, looking from the dam toward the head of the pond.

tank of 120,000 gallons capacity, and 100 feet above the University campus. The main pipe lines are of 8-inch asphalted cast iron with leaded joints, and for the heavy pressure near the pump-house are of double strength. For the present consumption of 30,000 gallons per day, a few hours' service every three or four days is all that is required of this pump.

The pond formed by this dam has a water surface of four acres, and is deep and narrow. Its estimated capacity is 20,000,000 gallons. The area of the catchment is approximately 200 acres, most of which is characterized by steep, sparsely wooded slopes.

The dam was completed in July, 1911, and the pond began to fill in September. There was very little run-off, however, till the 15th of September, when a three-inch rain raised the pond from a nearly empty condition to within eight feet of the top of the dam. During the remainder of September the pond completely filled, and by the first of October was spilling over the crest. The total rainfall of this period was ten inches, from the first five inches of which there was no immediate run-off of any consequence. In other words, five inches went to replenish the groundwater, after the severe drouth of the summer. No leakage has developed in any part of the structure of the dam, nor in any part of the contact between the dam and the bottom and sides of the valley.

III.

The geological conditions of water supply in the limestone region are radically different from those just-described for the Knobstone area.

First of all the slopes are much less steep, and the soil is less permeable than in the Knobstone region. The soil is also of greater thickness and more fertile. Originally the region was heavily forested, and a few examples may still be seen of virgin forest, as for example, on the University farm at Mitchell.

The central portion of the region, away from the deep valleys to the east and west, is nearly level, and is the area of the Mitchell limestone, preëminent as a cave-bearing formation. In this central portion of the limestone region, nearly all of the drainage is underground, and springs and sinkholes abound¹. In many instances the entire headwater portions

¹ It is the sinkhole region of Newsom, the Mitchell plane of Beede. See *Newsom, J. F.*, A Geological Section Across Southern Indiana from Hanover to Vincennes, Proc. Ind. Acad. Sci. for 1897, pp. 250-253; *Beede, J. W.*, The Cycle of Subterranean Drainage as illustrated in the Bloomington, Indiana, Quadrangle, Proc. Ind. Acad. Sci. for 1910, pp. 81-111.

of streams have been taken underground and diverted from their ancient channels to new and alien outlets in great springs on the eastern and western borders of the area¹.

Remarkable examples of this are to be seen in the underground capture of the headwaters of Indian Creek in Monroe County, by Salt and Richland creeks. In the case of the famous Lost River, in Orange County, some twelve miles of the surface channel have been abandoned in favor of a subterranean course.

The depth to which these underground channels penetrate the rock is limited only by the thickness of the limestone formation and its elevation above the main lines of drainage². Near the Ohio River, where the main drainage is deeply entrenched into the Mitchell plain, the rock is cavernous to a depth of 300 feet³. In the northern portion of the area, where the main streams have not cut so deep, and where also the limestone formations are thinner, the underground openings in the rock do not go so deep, but even in this part of the area the limestone may be cavernous to depth of more than 100 feet⁴.

Nor is the cavernous character of the region confined to the higher portions, well above drainage. In all but the deeper valleys, the valley-floor itself may be riddled with solution holes and underground channels. This is exemplified in the valley of French Lick Creek. The extremely free underground communication of the waters underneath this valley has been repeatedly proven by the interference of wells in the valley with the flow of the mineral springs. The testimony taken in the case of the French Lick Springs Co. vs. Howard et al. showed this so conclusively that it may not be out of place to review it at this point.

¹Beede, *loc. cit.*

²Cummings, On the Weathering of the Subcarboniferous Limestones of Southern Indiana, Proc. Ind. Acad. Sci. for 1905, pp. 85-100.

³Greene, Caves and Cave Formations of the Mitchell Limestone, Proc. Ind. Acad. Sci. for 1908, p. 106.

⁴Most people do not realize the depth to which limestone formations may be affected by solution. In the remarkable treatise by Martel on the cave regions of Europe (*Les Abimes*), there are described many well-like solution holes that go almost straight down into the rock to depths of 600 feet or more. Into many of these Martel actually descended by means of rope ladders, and explored the caves at the bottom. The famous region of the Karst, on the eastern side of the Adriatic, has been literally honeycombed with caves and sinkholes to great depths. A more extraordinary region could scarcely be imagined. The Recca, in Austria, flows in a subterranean channel, which is in places more than 1,000 feet beneath the surface.

At one time and another a number of wells have been sunk in this valley at West Baden and French Lick. These wells are the Ritter well on the bank of Lost River north of West Baden (388 feet deep); the Howard well on the east side of the valley, opposite French Lick (529 feet deep); the Caves and Wells well (510 feet deep); the two wells of the Colonial Hotel Company (each 93 feet deep); and a well near the French Lick station, known as Cerberus (465 feet deep). The most noted of these, and the most important in the present connection, is the Ritter well. This well had at first a strong artesian flow, that very soon affected all the springs of the valley. Those at French Lick, the famous Pluto, etc., were the first to be affected, because their outlets are highest above that of the well. These springs are a mile and a half away from the Ritter well. Later even the springs at West Baden ceased to flow. The same result, so far as the French Lick springs were concerned, was experienced from the wells near French Lick station (later purchased and plugged by the French Lick Springs Company), and especially from the wells of Howard and Gagnon. The pumping of these latter wells interfered so seriously with the flow of Pluto spring that the Springs Company was driven to resort to the courts for relief, and succeeded in obtaining an injunction against the pumping and wasting of the water. The injunction was granted by the court sitting at Paoli and at Salem, and was afterwards confirmed and made permanent by the Supreme Court of Indiana.

It was brought out in the hearing on this case that the pumping of the wells of Howard and of Gagnon immediately affected the flow of the Pluto spring at French Lick, three-quarters of a mile away, and that as soon as the pumping ceased, the spring resumed its flow. This effect was noticed repeatedly¹.

Another evidence of the same thing is the frequency of sinkholes in the valley floors themselves. This is illustrated in many of the valleys to the west of Bloomington, as on the headwaters of Richland Creek, Blair Hollow, etc. In the excavation for the foundations of the bottling works at the French Lick Hotel, cavernous rock was met with under the

¹ The distances of these various wells and springs from Pluto are as follows: Pluto to the wells near French Lick depot, 1,500 feet; Pluto to the Gagnon (Colonial Springs) wells, 4,000 feet; Pluto to Howard well, 4,000 feet; Pluto to Ritter well, 8,000 feet; Pluto spring to Bowles spring, 950 feet; Pluto spring to Pagoda spring at West Baden, 5,000 feet; West Baden Hotel to Ritter well, 3,000 feet.

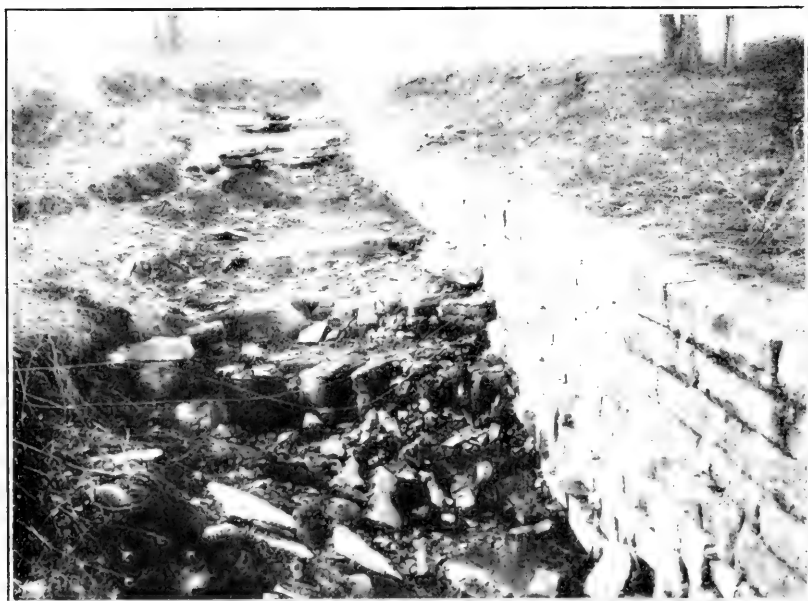

Fig. 5. Spillway of the upper pond of Bloomington water-works, showing joints in the rock.

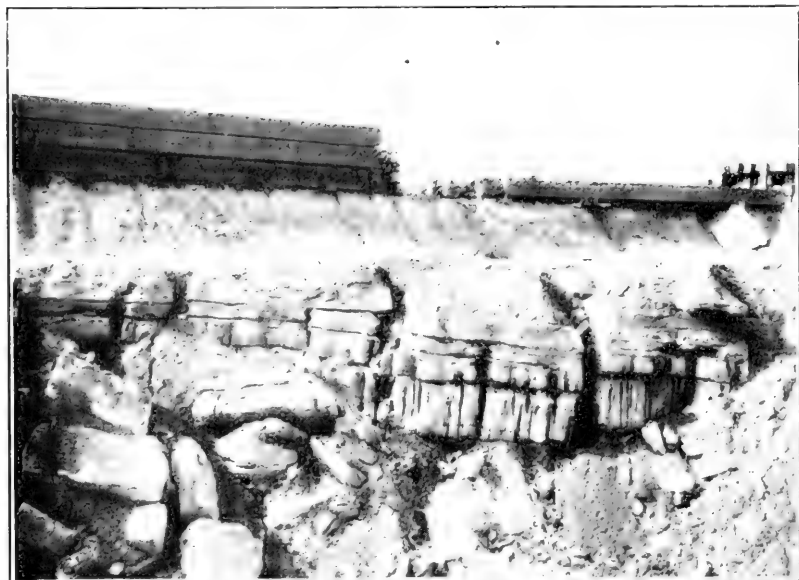

Fig. 6. Joints enlarged by solution. Cut on Illinois Central R. R., Bloomington.

valley. In the excavations for the foundation of the second dam of the Bloomington water-works, a joint, widely opened by solution, was traced down seventeen feet into the rock, without closing up. Some of these weathered joints are illustrated in the accompanying photographs (Figs. 6 and 7), and other illustrations may be found in the papers of the writer and Dr. Beede, cited above.

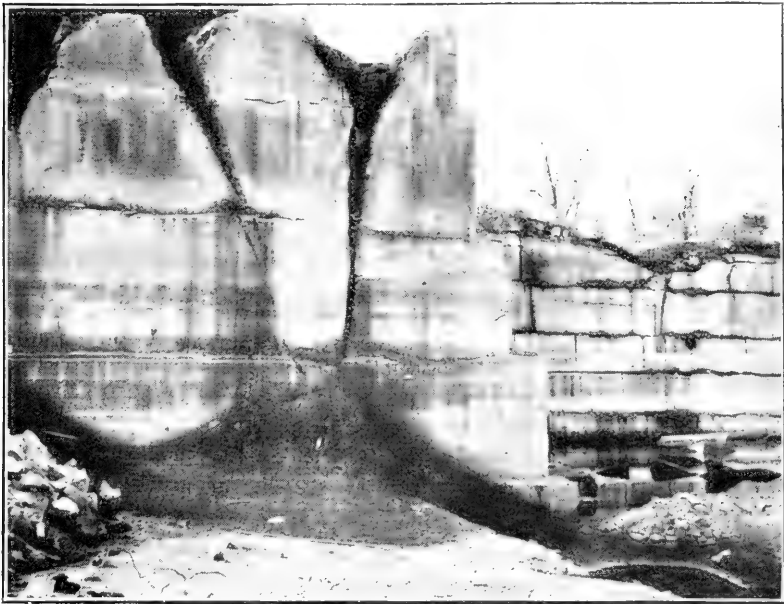

Fig. 7. A quarry face in the Hunter valley region, Bloomington, showing joints widely opened by solution.

The valley sides in the limestone area are apt to be so leaky as to render them totally unfit to act as retainers of impounded water. This has been very thoroughly demonstrated in the case of the Bloomington water-works plant. The original dam at this plant has long been decrepit, and the extensive leakage is due to a variety of causes, among which the chief is probably faulty construction. A considerable quantity of water, however, finds its way into the joints and bedding planes of the rock, under the spillway (Fig. 5), and is recovered by the second pond, which is immediately below the first. In the case of the second pond, built in

1905, the dam was very carefully constructed of good clean clay, with a concrete core carried down into the rock far enough to prevent any likelihood of leakage through the substratum. As soon as this pond filled, nevertheless, severe leaks developed under the spillway, through the crevices of the rock, as in the case of the old dam. It is thought that some of the water appearing at this leak actually comes from the upper (first) pond, making the entire journey through the cavernous rock of the valley-side. An attempt was next made to repair this leak by tunneling into the valley side at the spillway. This excavation developed the fact that there is a mud-filled seam, extending back into the hill between two layers of limestone. This seam was followed back into the hill about 40 feet, and as it showed no sign of closing up, the portion excavated was filled with concrete, and the attempt at repair was abandoned. It is altogether likely that the entire hill is cavernous to an unusual degree, and that the only way to render the valley side tight would be to expose the rock along this entire side of the pond, and close all of the joints and seams with concrete. At the present time the entire water supply of Bloomington is pumped from the leak under the spillway of the lower pond, and an equal amount is pumped back into the ponds. That is, the leakage at present amounts to over a million gallons a day. Both of these ponds are located in the Mitchell limestone, the foundation of the dam of the lower pond resting on the top of the Oölitic limestone.

Enough evidence has now been cited to prove beyond any question that the general geological conditions in the limestone region are distinctly unfavorable to the impounding of water. One corollary to be drawn from this fact is that all towns within a reasonable distance (a few miles) of the Knobstone area, should utilize the latter for their water-supply systems. Where it is necessary to obtain water, if at all, from the limestone area, the portions underlain by the Oölitic limestone or the Harrodsburg limestone should be utilized in preference to the area underlain by the Mitchell limestone, and the Oölitic is to be preferred to the Harrodsburg. If it becomes necessary to utilize the Mitchell area, the following facts should be noted: First, it will be noticed by any one familiar with the Mitchell limestone that there is a layer or bed of rather impervious rock about 50 feet above the base of the formation. This layer serves as the floor of many of the caves of the region, and is the level at which many of the large springs emerge. Examples of this are the Leonard and Shir-

ley springs and the Stone spring (Bloomington water-works) near Bloomington. In some cases this layer might be made to serve as the substratum of a pond. Great care would then be necessary to make the sides of the pond secure, since they would be in an extremely cavernous part of the formation. Second, for ponds to be fed by springs of the type just mentioned, the top of the Oolitic limestone can be utilized for the bottom of the pond, and here again the sides of the pond must be made secure. The second pond of the Bloomington water-works is built on this layer, and all of the leakage is through the valley sides, and not through the floor of the pond. Where the valley sides are thickly covered with residual clay, and this is carefully puddled, ponds at this level should be fairly tight. Third, in a few cases the flow of the larger springs of the region, or of several springs combined, will be sufficient for small towns, without impounding. In such cases the flow of the springs should be very carefully gaged, through a period of years, before any money is spent on works to utilize the water.

In this connection it is proper to speak of the special characteristics of the springs of the limestone region, especially since they are usually very much overrated, and their nature and cause misunderstood. All of the large springs of the limestone region are the outlets of subterranean solution channels in the rock, and very often serve also as the mouths of well-defined caves. These caves and channels are in turn, as already shown, intimately connected with the sinkholes of the region. The sinkholes are the main gathering grounds of the waters that emerge at the springs. Or, to be more precise, they are the avenues through which the water is taken under ground. The sinks, like the caves themselves, are largely the work of solution. (See Fig. 8.) Where the sinks are open at the bottom, as is usually the case, storm water passes very readily and very quickly into the subterranean channels, and as quickly emerges at the springs. At such times the spring water is muddy, showing that it is merely surface water that has made a journey of greater or less length through an underground conduit. It is indeed possible in some cases to drop a handkerchief into a sinkhole, and to presently see it emerge at a distant spring. Sometimes the journey from the sink to the spring is very short, a few rods; at other times it may be many miles. In any case the storm water comes to the spring unfiltered.



Fig. 8. An open, funnel-shaped sink-hole, due to solution. Near Ellettsville, Indiann.

The drainage area of these springs can usually be defined with a fair degree of accuracy, and is as important to know as in the case of surface water, for it must not be forgotten that the water of these springs is just as certainly conditioned by rainfall, as the water of surface streams. The criteria of rainfall and run-off, discussed above, apply here with equal force, though it is probable that a somewhat larger percentage of the rainfall is available than in the Knobstone region to the east; at least the run-off is more regular.

If the element of catchment area be analyzed, it will be perfectly apparent why so few of the springs of the region are adequate for municipal supply without impounding the wet-weather flow. The great Shirley and Leonard springs, near Bloomington, drain an area of about six square miles. During the storage season the flow of these springs must be at times several million gallons per day. At the end of the dry season of 1908 the writer estimated their combined flow at less than 100,000 gallons per day. At that time the writer gaged the Hottel spring in Bloomington and found a flow of 12,000 gallons per day. At the same time also the Rogers springs, just east of Bloomington, had a flow of 10,000 gallons per day. All of these springs have the local reputation of being very strong springs. The Stone spring, at the Bloomington water-works, during the same season had an estimated flow of about 20,000 gallons per day. On the other hand, Wilson's spring, on Blue River, is estimated by Tucker¹ to have a dry-weather flow of nearly 10,000,000 gallons per day. It is said to be the largest spring in Indiana.

Several attempts have been made to obtain water in quantity from deep wells in the limestone region. Invariably the water so obtained has been mineral water. The wells at French Link and West Baden are typical. The writer is unable to state definitely the yield of these wells, but from a rather intimate acquaintance with those that are still flowing, it would be safe to say that none of them, except the Ritter well, has a flow greater than that of the Pluto spring. The flow of this spring is said by Blatchley² to be nearly 26,000 gallons per day. The water contains about 300 grains of mineral matter per gallon. The flow of the Ritter well was at first much greater than this, and the water was less

¹ *Tucker, W. M.*, Water Power of Indiana, 35th Ann. Rept. Indiana Dept. Geol. and Nat. Res., 1910, pp. 34-37.

² *Blatchley, W. S.*, Mineral Waters of Indiana, 26th Ann. Rept. Indiana Dept. Geol. Nat. Res., 1901, p. 102.

strongly impregnated with mineral matter, but was nevertheless unfit for domestic use. The Nashville well, 500 feet deep, flows about 29,000 gallons per day, and the water is strongly impregnated with sulphur. The White Sulphur well, in Crawford County, flows about 15,000 gallons per day. There are many other wells of this type in the region, but even if their flow were increased by pumping, none of them have a capacity sufficient to be of any consequence, and, moreover, they are all too strongly impregnated with mineral matter to be of use for domestic or municipal purposes. They vary in depth from a few hundred feet to 1,000 feet or more.

Attempts have also been made to obtain water from shallow wells in the limestone. There are three levels at which water may be expected in small quantities in the Mississippian limestones; namely, at the top of the Oölitic, at the top of the Harrodsburg limestone, and at the top of the Knobstone formation. The latter horizon is the most important. The writer is familiar with the history of a considerable number of such wells in the vicinity of Bloomington, and these are typical of the entire limestone region. The University has drilled, at one time and another, three wells on the campus in the hope of obtaining water for boiler-water. These wells vary in depth from 50 to more than 100 feet, and reach the top of the Knobstone formation. The city of Bloomington also drilled a well in the dry season of 1908, starting at the top of the Oölitic limestone and reaching to the top of the Knobstone. Private individuals in and about Bloomington have drilled a number of wells of a similar sort. None of these wells have produced a supply of water sufficient for even a small town, and some of them have been total failures. The reason for these failures is not far to seek. First of all the Knobstone formation, an impervious rock, underlies these limestones at a comparatively slight depth, constituting a level beneath which no water can be obtained, except small quantities of mineral water, as described above. Second, in the eastern part of the area, the extent and thickness of outcrop of the limestone above the Knobstone, are not sufficient to furnish gathering grounds for water in quantity, and the limestones are, in addition, very thoroughly drained out by the deep ravines that trench the eastern edge of the region. Third, in the central part of the area, where the limestones are thicker and more extensive, they are also so cavernous that shallow wells are a failure, except where they strike the underground streams, and deeper wells pro-

duce mineral water. Fourth, in the western edge of the area, where the limestone is under cover of the Chester formation, except in the deeper valleys, the rock-water is artesian, and more or less highly impregnated with mineral salts, as in the case of the water of the French Lick Valley. In this part of the area mineral water is constantly making its way from considerable depths to the surface, along the joints of the soluble limestone, and consequently mineral springs abound, and even shallow wells produce mineral water.

Except in the valleys of White, Blue and Ohio rivers, the limestone area contains, so far as known, no coarse deposits of alluvium, from which water can be obtained, as in the Knobstone region. The larger valleys of the area, with the exceptions already mentioned, are of two types. One of these is represented by the headwaters of Indian Creek in Monroe County, and by Lost River in Orange County, and Indian Creek in Harrison County. These creeks flow in broad shallow valleys on the limestone upland, and have lost many of their tributaries and much of their water by underground piracy to the deeper valleys on the east and west. Their floors are leaky, and their deposits of alluvium are thin and very fine grained. The other type of valley is exemplified by Richland Creek in Monroe and Greene Counties and by the lower course of Indian Creek in Lawrence County, and by French Lick Creek. These valleys are deeply intrenched, having cut through the Mansfield and Chester formations into the top of the Mitchell limestone. They are broad, conspicuously terraced, and have well-developed alluvial deposits; but the character and water-bearing qualities of these deposits have not been carefully investigated.

IV.

Similar to the Knobstone region in topography, but differing considerably in type of geological formation, is the area occupied by the Chester and Mansfield formations. The Chester (Huron) formation consists of a series of limestones, shales and sandstones, varying from place to place in the thickness of its members, and in the details of its lithology, but presenting everywhere the following general sequence, in the ascending order: (a) Lower sandstone, $\frac{1}{2}$ to 12 feet thick; (b) Lower limestone, thin-bedded, oölitic or lithographic, 2 to 5 feet; (c) Middle sandstone and shale, argillaceous or arenaceous shale and cross-bedded, soft sandstone, 45 to 62 feet thick; (d) Middle limestone, crystalline, generally light colored, occasion-

ally oölitic, 6 to 21 feet; (e) Upper sandstone, ferruginous, reddish brown to white, laminated sandstone, 40 feet; (f) Upper limestone, grading from limestone at the bottom to shale at the top, 25 feet thick.¹ The limestones of the Chester are not unlike those of the Mitchell and Salem (Oölitic) formations. They are usually rather pure carbonate of lime, and hence soluble, as in the case of the limestones already discussed. Springs often occur at the base of the limestone beds. The sandstones are coarser grained than those of the Knobstone formation, and are cross-bedded and pervious, and conspicuously jointed, the joints often being widely opened by weathering. Springs occur at the base of the sandstone strata, where they rest on shale. The shales of the Chester formation vary from strongly bituminous to argillaceous or even arenaceous. The bituminous bands are very fine grained and impervious. The argillaceous shales are more pervious and grade into coarse grained pervious sandstones.

The Mansfield sandstone, forming the basal member of the Coal Measures of Indiana, and resting unconformably on the Mississippian formations, is a ferruginous, soft cross-bedded, rather coarse grained, sometimes conglomeratic pervious rock. It varies greatly in thickness. Where it is thick, as at Shoals, it produces a rugged topography, with cliffs and pinnacles. The deeply weathered joints and honeycombed weathered surfaces give it a very characteristic appearance. Small springs abound in the area of the Chester and Mansfield formations.

The soil of the Chester-Mansfield region varies from red residual clay, such as characterizes the limestone region, through sandy clay to almost pure yellow sand. In the more rugged portions of the region the soil is thin and poor, and the vegetation scanty. Some of the worst gullying seen in Indiana is to be found in this area. The rain water runs off very rapidly, carrying with it quantities of sediment. Greene and Martin Counties afford many excellent examples of this.

From the standpoint of the water-supply engineer this region is to be considered as intermediate in character between the Knobstone region and the limestone region. It is topographically similar to the former, but the greater permeability of the formations, and especially the presence of beds of cavernous limestone, and the fact that the deeper valleys are floored by the leaky Mitchell limestone, are all characteristics connecting

¹ *Greene, F. C.*, The Huron Group in Western Monroe and Eastern Greene Counties, Indiana. Proc. Ind. Acad. Sci. for 1910, p. 270. This paper contains a full discussion of the Chester formation of the area under discussion.

it with the limestone region. Smaller amounts of water enter the ground than in the limestone area, however, owing to the steepness of the slopes, especially where these are not under forest. The run-off is concentrated more into the winter and spring months, flood stages are higher, and the streams carry a greater amount of sediment than is the case in the limestone region.

Furthermore, there are, in contrast with the limestone region, beds of impervious shale in the Chester formation, that where favorably located might serve as foundations for dams. It should be noted, however, in this connection that these shales are less firm than those of the Knobstone formation, and would consequently be less capable of sustaining the weight of heavy structures.¹ Where the shales and sandstones are underlain by thick beds of limestone, they will often be found to have collapsed into large solution cavities in the latter, and consequently to present a confused and broken structure, wholly unfit for the foundation of a dam. Numerous examples of this collapse may be seen in the cuts on the Illinois Central Railroad near Stanford, Indiana.²

Because of their greater permeability the formations of this area will also be found to be weathered to a greater depth than those of the Knobstone area. In view of all these facts it will be seen that great care should be exercised, and very careful study of the geological conditions should be undertaken in every individual case before placing any impounding structures upon the rocks of the Chester formation. The Mansfield formation, while not as leaky as the limestones of the driftless area, is nevertheless not a favorable formation for impounding water, on account of its porosity.

In regard to deep wells, the Chester-Mansfield area is similar to the limestone region to the east. Deep wells ordinarily produce mineral water. In the western edge of the area, where the sandstones of the Chester or Mansfield are deeply buried, it may be possible to obtain from them water not too highly impregnated with mineral matter for domestic use. The writer is not in a position to speak with authority on this point. It is quite likely that the upward moving water from the limestones beneath would even here cause enough admixture to render the water of the sandstones unfit for use.

¹The recent failure of the Austin dam in Pennsylvania, was due to the presence in the substratum upon which the dam stood, of a bed of soft, slippery shale. The dam seems to have slid bodily forward, carrying the rock on which it stood with it. Even in this case, however, it is very doubtful if there would have been any failure had the dam been arched, as a dam of its length should have been.

² See Greene, *loc. cit.*

V.

Several times in this paper it has been necessary to call attention to the forest conditions of the driftless area. While this subject does not, in strictness, come within the view of a geologist, nevertheless the success or failure of a water-supply system, in a region where steep slopes preponderate, is so intimately bound up with forest problems, that it may not be out of place to devote a little space to the consideration of this topic.

Very little virgin timber is left standing in southern Indiana. Where the timber has not been removed entirely, it has been closely culled, and in many instances burned over, so that the stand is often thin and the forest cover poor. The writer has often been struck by the character of the woods in Brown County, which gives the impression of being largely under forest. And so it is, if one considers merely the area occupied mainly by trees; but when one notes carefully the character of the stand, one is immediately impressed with the fact that scarcely a tree can be found that appears to be over fifty years old, and much of the stand consists of mere saplings and inferior coppice. Cutting is still going on in the whole of the driftless area, and the writer has seen tracts of many acres of steep slopes denuded of their trees within the last five years. The fate of these slopes, under the type of farming generally practiced in the region, is pathetic (Fig. 9.). Gullying begins immediately, especially where the soil consists largely of clay, and absorbs the rainwater slowly, and in a few years the hillside is a scarred ruin. The regimen of the streams is radically changed. Floods increase in frequency and violence. Springs that formerly had a steady and abundant flow throughout the year, are reduced to dwindling threads of water throughout the dry season.

From the standpoint of water-supply, one of the most serious of these effects is the change of stream regimen. As Glenn¹ has pointed out in the southern Appalachians, whether or not the total rainfall of a region is affected by deforestation, it can be demonstrated that the regimen of the streams is notably changed. He has shown, and the same thing can be shown in southern Indiana, that in regions still under adequate forest cover, the streams are clear even at flood stage. He also points out the

¹ Glenn, L. C., Denudation and Erosion in the Southern Appalachians. U. S. Geol. Surv., Professional Paper No. 72. 1911.

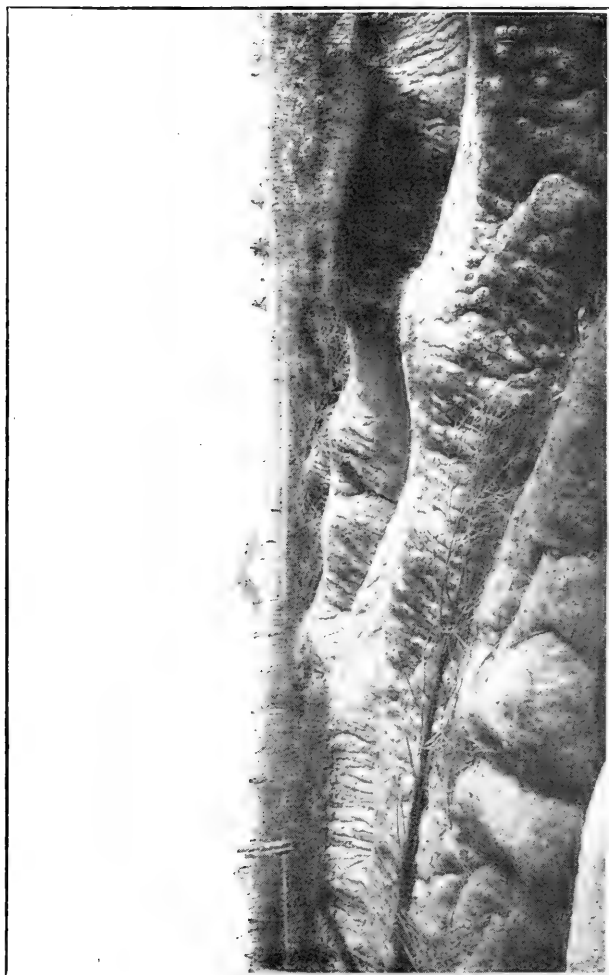

Fig. 9. Soil erosion on a moderate slope at the head of a deep ravine, near Clear Creek station, Indiana.

very significant fact that the former regimen of a stream is revealed in the character of its valley deposits. If a stream has been in the habit of depositing only very fine silt, the valley deposits (alluvium) will consist of fine material only. On the other hand if the stream has been in the habit of depositing coarse material, the valley deposits will reveal this fact. If furthermore a stream is now depositing coarse material where it formerly deposited only fine material, and if this change has come about *pari passu* with the deforestation of the region, and no other adequate cause can be assigned, it is a fair inference that the deforestation of the region has changed the regimen of the stream. This effect also finds ample illustration in southern Indiana. Torrential streams now emerge on the sides of broad alluvial valleys, building fans of coarse and sterile gravel out over the finer silt of the main stream flood plane. Deep scouring of fertile valleys by flood waters is only too common.

Now the importance of this change in stream regimen for the water-supply engineer is two-fold. First, if floods are notably increased in frequency and volume it will be necessary to build more massive structures to withstand them, and it will also be necessary to build large enough reservoirs to hold the flood water, since very little catch of water can be expected in the growing season. Second, the greatly increased erosion of slopes and valleys brings down immense quantities of sediment which tends to silt up reservoirs. The rapidity and completeness with which reservoirs are silted up, in the southern Appalachian region, as described by Professor Glenn, almost passes belief.¹ He says: "From the slopes along these streams a steadily increasing amount of waste is working its way down the channels, filling the dams and destroying their storage capacity; and this loss of storage means a decrease of efficiency that is calculated by the most experienced mill engineers to amount to 30 to 40 per cent. in plants that have been built especially for storage and a somewhat less marked decrease in other plants, the exact amount depending on the topography of the basin and the regimen of the particular stream on which the plant is located. So universal is this silting of storage basins that a prominent mill engineer of wide experience in his reports on the construction of power plants no longer calculates on power or anything except the flow of the stream, and he has increased his usual estimates by an allowance for increased storm waters that must be taken care of without endangering the dam or plant.

¹ Glenn, *loc. cit.*

"At one large plant storage basins that originally had a capacity to hold the water accumulated by several days of ordinary stream flow have been so filled that they cannot now hold the flow of a single night.

"At one dam where two years before, when the dam was first closed, there was a depth of 28 feet, an island has recently appeared. At another place, where a high dam had been built on a small stream, the pond has been so filled that its storage capacity has all been lost. . . . A pond four miles long and forty feet deep at the lower end was in four years entirely filled in its upper part and near the dam was three-fourths full."

The differences between the southern Indiana region and the southern Appalachians are largely such as arise from the greater relative relief of the latter region. Plenty of examples on a somewhat less pronounced scale can be found in Indiana, of precisely the same process here so vividly outlined by Glenn.

There is only one remedy for this condition, and that is to remove the cause. The writer can vouch for the fact that where the forest cover is adequate, slopes in the Knobstone region, almost too steep to climb, are not suffering an appreciable amount of erosion. The steep slopes of water-supply catchments must be maintained in forest cover if reservoirs are to be kept free of mud. It would be a blessing to the future citizens of Indiana if large sections of the more rugged portions of the driftless area of southern Indiana could be protected by the State from further denudation, and if, furthermore, slopes which have already been denuded, and which are too steep for agricultural purposes, could be reforested. The great Knobstone region, with its innumerable deep valleys and ample rainfall, and impervious strata, must ultimately be called upon to furnish the water supply of great cities. It should be seen that the one condition which alone can make this region unfavorable for such purposes, namely erosion of its steep slopes, is removed by early and adequate steps to forever maintain these slopes in forest.

VI.

SUMMARY. The driftless area of southern Indiana comprises an eastern portion of impervious sandstones and shales and rugged topography; a central portion of cavernous limestone and mild relief, and a western portion of shales, sandstones and limestones, and similar in topography to the eastern region. The mean annual temperature and the mean annual rainfall are slightly greater in the southern than in the northern portion

of the area. The minimum annual rainfall of the region is about thirty inches, and the run-off may, in dry years, fall as low as twenty-five per cent. of the rainfall. In the eastern region (Knobstone formation) water for municipal supply will have to be impounded, except where the underflow of the larger valleys may be used; and the conditions for building dams are ideal. In the central portion of the area the rock substratum is everywhere very cavernous and leaky, and tight ponds will be difficult to obtain. A few of the larger springs furnish sufficient water for small cities without impounding. All deep wells produce mineral water, and shallow wells are inadequate. In the western portion the conditions are intermediate between those of the eastern and central portions. To maintain the perennial flow of springs and prevent the silting of ponds the steep slopes of the area should be reforested, where necessary, and forever kept in forest.

*Geological Laboratory,
Indiana University.*

A NOTE ON THE BATOSTOMAS OF THE RICHMOND SERIES.

By E. R. CUMINGS and J. J. GALLOWAY.

Four species of the genus *Batostoma* have been reported from the Richmond series, namely: *Batostoma manitobense* Ulrich, from Stony Mountain, Manitoba; *B. (?) rugosum* (Whitfield), (possibly a species of *Callopora*) from Delafield, Wisconsin; *B. Varians* James and *B. variabile* Ulrich from various places in Ohio, Kentucky, Indiana, Illinois and Wisconsin. The two species last named have heretofore been confused, owing to inadequate descriptions and figures, although it appears that they never occupy the same horizon and are really very distinct. *Batostoma variabile*, which has been considered a rare species, occurs in great abundance at Ballstown and Weisburg, Indiana, in the lower part of the Whitewater formation.

Associated with *Batostoma varians*, in the upper Waynesville and lower Liberty formations on Tanner's Creek, Indiana, near Weisburg, is another species of *Batostoma*, not heretofore recognized. This is the form described in the present paper as *Batostoma prosseri* nov. It differs from *B. varians* in its ramose growth, more numerous mesopores, larger acanthopores with a smaller lumen, and the absence of a median lamina. These two species cannot readily be distinguished by external characters alone, but internally they are very different.

Batostoma prosseri and the ramose forms of *B. varians* are difficult to distinguish by external appearance from *Eridotrypa simulatrix* and *Callopora subnodosa* with which they are associated. The encrusting forms of *B. varians* might be confused with certain phases of *Ceramoporella*. In any of these cases, however, close inspection will reveal characteristic differences. The only species occurring with *B. variabile*, with which it might be confused is *Rhombotrypa quadrata*, which it resembles in zoarial characters, and to a less extent in deep tangential and longitudinal sections; but the quadrate zoecia at the growing ends of the branches are sufficient to distinguish the *Rhombotrypa*.

Communication pores, which have heretofore been considered as characteristic of the genus *Homotrypa*, are found in abundance in many speci-

mens of *Batostoma varians* and *B. Prosseri*. They are also typically developed in the following genera of the Trepostomata: *Bythopora*, *Callopora*, *Dekayia*, *Eridotrypa*, *Monticulipora*, *Nicholsonella* and *Peronopora*. It seems quite probable that communication pores are characteristic of all of the Trepostomata. They are most numerous near the surface, but are sometimes found in the deeper portion of the mature region. They are most readily seen in fairly thick tangential sections cut near the surface of well preserved material; but very thin sections show their structure better. Communication pores may also be seen occasionally in longitudinal sections. These pores usually pass through the region where the inter-zoecial wall is narrow, going directly from one zoecium to another. But they are sometimes very irregular in their course. They may be straight, curved, or looped, and are sometimes branched, so as to connect three zoecia. In the sections the pores usually appear clear and empty, but they sometimes are filled with dark colored, opaque pellets.

Batostoma variabile was quite certainly derived from *B. minnesotense* Ulrich, of the middle Trenton formation of Minnesota¹; from which locality it migrated southward during the late Richmond invasion. The two species seem to be almost identical.

B. prosseri, in everything but the possession of imperfect diaphragms, presents striking points of resemblance to *Hemiphragma irrasum* Ulrich.² In *B. prosseri*, however, the diaphragms are always complete, so that it is a true *Batostoma*.

Batostoma varians appears to be more closely related to the Eden forms, *B. jamesi* (Nicholson) and *B. implicatum*. The detailed description of these three Richmond species follows.

BATOSTOMA VARIANS (James).

Plate I, Figs. 1-1e; Plate VII, Figs. 3, 3a.

Chatetes varians. James, Paleontologist, No. 1, 1878, p. 2 (not figured).

Monticulipora (Chatetes) varians. James, Paleontologist, No. 5, 1881, p. 36.

Monticulipora varians. James and James, Jour. Cin. Soc. Nat. Hist., Vol. X, 1888, p. 177, pl. ii, Figs. 4a, 4b.

¹ Geology of Minnesota, vol. iiii, pt. i, p. 297, pl. 26, figs. 38-40; pl. 27, figs. 9-15.

² Ibid., p. 299, pl. xxiv, figs. 5-9.

- Batostoma variabile* (pars). Ulrich, Geol. Surv. Ill., Vol. VIII, 1890, p. 460, pl. xxxv, Figs. 4b, 4c (non 4, 4a, 5, or pl. xxxvi, Fig. 1).
- Monticulipora varians*. J. F. James, Jour. Cin. Soc. Nat. Hist., Vol. XVI, 1894, p. 199.
- Batostoma variabile*. J. F. James, Jour. Cin. Soc. Nat. Hist., Vol. XVI, 1894, p. 200.
- Batostoma varians*. Nickles and Bassler, Bull. U. S. Geol. Surv., No. 173, 1900, p. 179.
- Batostoma varians*. Nickles, Kentucky Geol. Surv., Bull. No. 5, 1905, p. 57, pl. iii, Figs. 8, 9.
- Batostoma varians*. Bassler, Proc. U. S. National Museum, Vol. XXX, 1906, p. 18.
- Batostoma varians*. Cumings, Indiana Dept. Geol. Nat. Res. 32d Ann. Rept., 1907, p. 778, pl. vii, Fig. 9; pl. viii, Figs. 3-3b; pl. xxvi, Fig. 14.

Zoarium irregularly ramose, branches 5 to 10 mm. in diameter, 10 to 80 mm. long; subfrondescent, or encrusting on the shells of brachiopods, Orthoceras, or other bryozoa. The encrusting forms are from one to 5 mm. thick, and frequently cover an area of 20 to 60 sq. cm. Cylindrical branches and knobs may spring from any portion of the zoarium. Surface smooth, no monticules, and only an occasional macula of larger zoëcia and mesopores. On unweathered specimens the knob-like projections of the acanthopores appear at the angles between the zoëcia. The pores at the ends of the acanthopores are funnel-shaped. The zoëcia, at the surface are usually angular or oval, sometimes rounded, and vary much in size and the thickness of the walls. The thin-walled zoëcia are angular, and the thick-walled ones are round or oval. Mesopores fewer than the zoëcia, at the angles of the latter, and in the maculæ; sometimes long and narrow, separating the zoëcia in thick-walled specimens. 6 or 7 zoëcia in 2 mm.

The tangential section shows the zoëcia to be thick-walled and separated by a conspicuous median lamina. Zoëcial apertures oval, mesopores fairly abundant, not so numerous as the zoëcia. Acanthopores abundant, situated at almost every angle between the zoëcia, rather large, thin-walled with wide central canal. Acanthopores sometimes occur in the wall between two zoëcia and then slightly indent the wall. Communication pores abundant in some specimens, but usually absent. In very shal-

low or very deep tangential sections the zoëcia are thinner walled and angular, and in the deep sections the mesopores appear to be more numerous.

In longitudinal sections the zoëcia are seen to be thin-walled and without diaphragms in the axial region, and gradually curving to the surface, they emerge at right angles to the latter. The mature region is fairly deep and here the zoëcia are thick-walled, except very close to the surface. Diaphragms from 2 to 8 in each zoëcial tube, in the mature region, one-half to two tube-diameters apart, the first one usually not nearer than two tube-diameters to the surface of the zoarium: more numerous in the mesopores, which present a chain-like appearance. In the submature region the acanthopores are thin-walled with a wide canal, crossed by numerous diaphragms. The external portion of the walls of the acanthopores as seen in longitudinal sections presents a spiny appearance, due apparently to an interrupted or periodic deposition of sclerenchyma.

According to Bassler, *Batostoma varians* is "abundant in the Arnheim, Waynesville, Liberty and Whitewater formations of the Richmond group in Ohio, Indiana and Kentucky."¹ It occurs in the Tanner's Creek section rarely in the Arnheim and lower sixty feet of the Waynesville, and abundantly in the upper thirty feet of the Waynesville and lower twenty feet of the Liberty formations. It does not occur in the upper Liberty, Saluda or Whitewater formations in Indiana. The Whitewater form is *B. variabile*. *B. varians* occurs in the base of the Liberty near Abington, Wayne County, Indiana, and in the Arnheim and Waynesville near Madison.

BATOSTOMA VARIABLE (Ulrich).

(Plate II, figs. 1-1c; Plate III, figs. 1-1c; Plate IV, figs. 1, 1a; Plate VII, figs. 1-1c.)

Batostoma variabile (pars). Ulrich, Geol. Surv. Ill., Vol VIII, 1890, pl. xxxvi, Fig. 1, (non pl. xxxvi, Figs. 4b, 4e, = *B. varians*).

Batostoma variabile. Bassler, Proc. U. S. Nat. Mus., Vol. XXX, 1906, p. 18, pl. vii, Figs. 9, 10.

Batostoma variabile. Cumings, Indiana Dept. Geol. Nat. Res. 32d Ann. Rept., 1907, p. 777, pl. xxvi, Fig. 13.

Zoarium ramose, robust, cylindrical or subcylindrical, 5 to 20 mm. in diameter, and 10 to 70 mm. long, dividing every 10 to 20 mm. either dichotomously or irregularly. The basal expansion forms large irregular masses

¹ Proc. U. S. National Museum, vol. xxx, 1906, p. 18.

by throwing off numerous large branches, which sometimes anastomose. Surface smooth, but having maculae of conspicuously larger zoëcia, which rise slightly above the surrounding zoëcia. Six maculae in 1 sq. cm. Acanthopores usually not visible at the surface, but sometimes in unweathered specimens, they project as very minute spines. Mesopores absent, except an occasional one in the maculae. Zoëcia very thin-walled at the surface in well preserved material, but thick-walled just below the surface. In weathered material the zoëcia appear thick-walled at the surface, owing to the fact that this outer thin-walled zone has been removed. Zoëcia very regular in size, angular or rounded by deposits of secondary sclerenchyma; six or rarely seven in 2 mm., those in the maculae one-half larger than the ordinary zoëcia.

Tangential sections show the zoëcia to be angular, thick-walled, and usually separated by a dark conspicuous lamina; their apertures rounded. Mesopores absent, but an occasional very small zoëcium, having the same wall-structure as the larger zoëcia is present. Acanthopores small or large, abundant, from 4 to 16 surrounding a zoëcium. Their walls thin, indistinct, and continuous with the median lamina. The central canal is usually minute, and not sharply defined. Communication pores few or absent.

In the longitudinal section the zoëcia are thin-walled in the axial region, slightly flexuous and crossed by straight diaphragms, from one to three tube-diameters apart. The zoëcia curve gradually till they reach the mature region, where they turn abruptly and go straight to the surface, and emerge at right angles to the latter. Diaphragms more numerous in the mature region, one-half tube-diameter or less apart. Some of the diaphragms are irregular, curved like cystiphragms, infundibular, and either concave or convex upward. Zoëcial walls abruptly thickened in the mature region, except in young zoaria, and becoming very thin again at the surface. Diaphragms thickened in the mature region by a secondary deposit.

Batostoma variabile occurs abundantly in the lower 40 feet of the Whitewater division at Weisburg and Ballstown, Indiana.

BATOSTOMA PROSSERI NOV.

(Plate V, figs. 1-1c; Plate VI, figs. 1-1d; Plate VII, figs. 2-2e.

Zoarium ramose or digitate, cylindrical, or compressed, dividing dichotomously or unequally at intervals of 10 to 20 mm.; 3 to 15 mm. in diameter and 20 to 60 mm. long. Surface smooth, but having maculae of

large zoëcia and mesopores, elevated above, or depressed slightly below the general level of the surface. About 9 maculae in 1 sq. cm. Mesopores abundant at the surface, frequently entirely surrounding the zoëcia; at other times not conspicuous. Zoëcial apertures round, and regular in size. Acanthopores, in unweathered specimens, appearing at the surface as large blunt spines at the angles of the zoëcia, and giving to the surface a decidedly spinose appearance. The zoëcia average 7 in 2 mm.

In tangential sections the zoëcia are thick-walled and round. The angles between the zoëcia are filled with secondary sclerenchyma and acanthopores. Mesopores usually abundant, but nearly absent in some sections. Acanthopores numerous, 4 to 10 surrounding a zoëcium; large and thick-walled, with a small distinct central canal; sometimes indenting the zoëcial walls. No intermural lamina. Communication pores usually absent, but numerous in some sections.

In longitudinal sections the zoëcia are thin-walled and wavy in the axial region, and usually without diaphragms. Diaphragms begin abruptly as the mature region is entered, and become numerous toward the surface, where they are from one-half to one tube-diameter apart. Zoëcial walls much thickened in the mature region, and proceeding directly to the surface, where they emerge at right angles to the latter. In immature specimens the zoëcial apertures are oval, the mature region shallow, and the zoëcia emerge obliquely to the surface. In the longitudinal section the acanthopores are thick-walled, with a small central canal, crossed by an occasional diaphragm. The diaphragms in the zoëcia are usually straight, but are occasionally cystoid. Diaphragms are more numerous in the mesopores.

The distinguishing features of *Batostoma prosseri* are the ramose growth, numerous mesopores and large acanthopores. The species is named in honor of Professor C. S. Prosser of Ohio State University. It occurs in the upper 40 feet of the Waynesville, and commonly in the lower 20 feet of the Liberty, at Weisburg, Indiana. It disappears abruptly at the level of the *Plectambonites scriccus* layer, as does also *B. varians*, with which it is associated.

Growth.	Size.	Surface.	Number of Zoecia in 2 mm.	Acanthopores. Number and Size.	Mesopores.	Diaphragms in Axial Region.	Diaphragms in Peripheral Region.	Communication Pores.	Diaphragms in Mesopores.	Median Lamina.
Irregularly ramose, subfrondescent, encrusting.	5-10 mm. thick, 10-80 mm. long.	Smooth, rarely spinose. Zoecia thin or thick walled, polygonal or rounded. Mesopores few.	6-7	Numerous, medium sized, thin walled, thorny in longitudinal section.	Few.	Usually Absent.	Few to Numerous.	Absent, few or numerous.	Numerous, chainlike.	Distinct.
Ramose.	3-15 mm. thick, 20-60 mm. long.	Smooth or spinose. Zoecia thick walled.	7	Numerous, large thick walled.	Abundant.	Few, usually absent.	Numerous, beginning abruptly in a line parallel with the surface.	Absent, few or numerous.	Numerous, rarely chainlike.	Indistinct or absent.
Ramose robust.	5-20 mm. thick, 10-70 mm. long.	Smooth. Maculae of large zoecia.	6	Numerous, medium size, indistinct.	Absent.	Numerous.	Numerous.	Few or absent.		Usually distinct.

BATOSTOMA VARIANS.

BATOSTOMA PROSSERI.

BATOSTOMA VARIABLE.

PLATE I.

	Page.
<i>Batostoma varians</i> (James).....	148
1. Surface. x 9. Upper Waynesville.	
1a. A subfrondescent specimen, natural size. Lower Liberty.	
1b. Typical tangential section, showing communication pores. x 18. Upper Waynesville.	
1c. A subramose specimen, natural size. Lower Liberty.	
1d. Longitudinal section, showing deep mature region and spiny acanthopores. x 18. Lower Liberty.	
1e. Typical longitudinal section. x 18. Upper Waynesville. All specimens from Weisburg, Ind.	

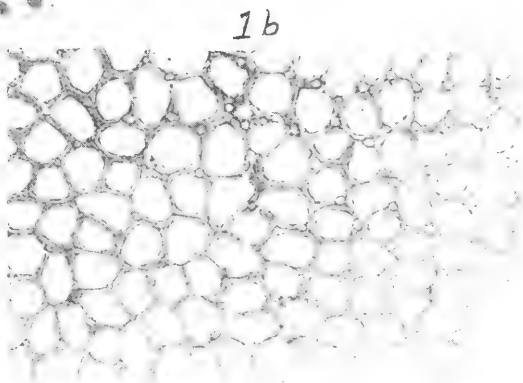
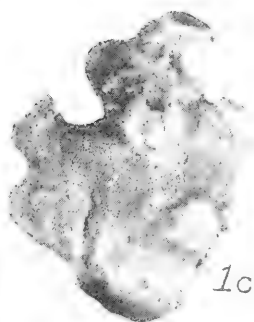
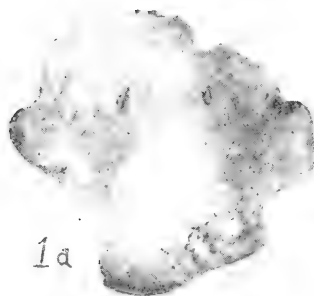
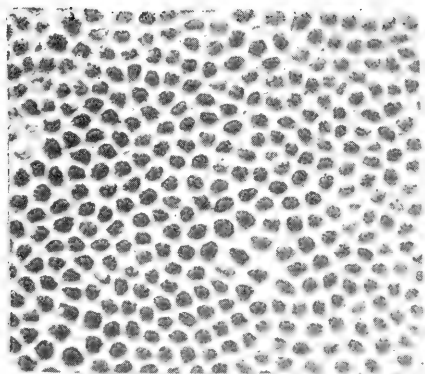

1d

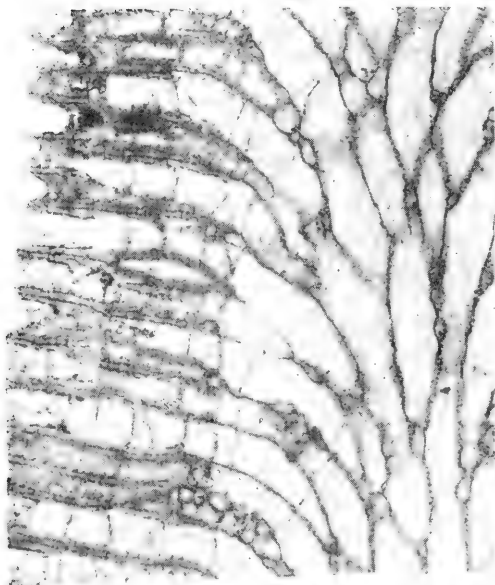

1e

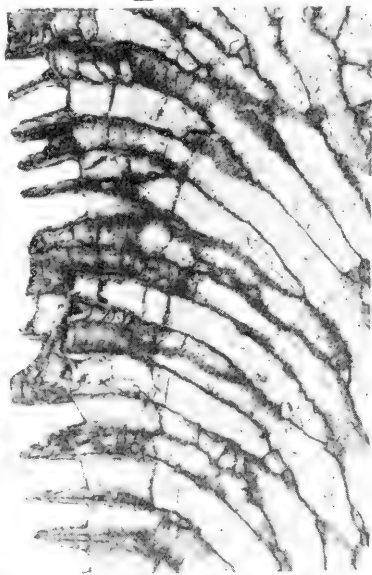
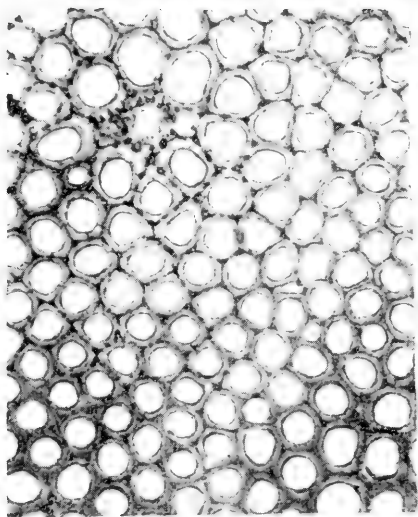
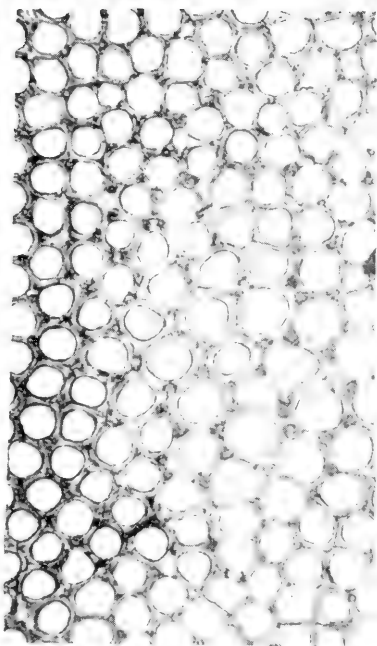

PLATE II.

	Page.
<i>Batostoma variabile</i> Ulrich.....	150
1. Typical tangential section, x 18. Ballstown, Ind.	
1a. Tangential section, showing unusually large acanthopores and faint median lamina, x 18. Weisburg, Ind.	
1b. Shallow tangential section, showing thin walls and few acanthopores, x 18. Weisburg, Ind.	
1c. Ramose specimen, natural size. Weisburg, Ind.	



1



1a

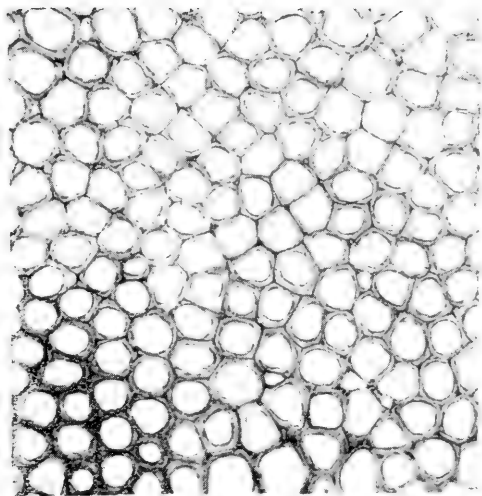

1b

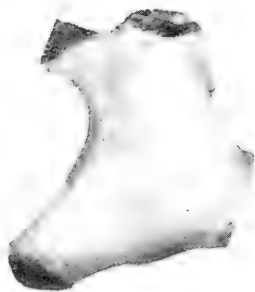

1c

PLATE III.

	Page.
<i>Batostoma variabile</i> Ulrich.....	150
1. Surface, showing a macula and thin-walled zoecia, x 9.	
1a. Longitudinal section, x 18.	
1b. Typical longitudinal section, x 18.	
1c. A compressed specimen, natural size. All specimens from Weisburg, Ind.	

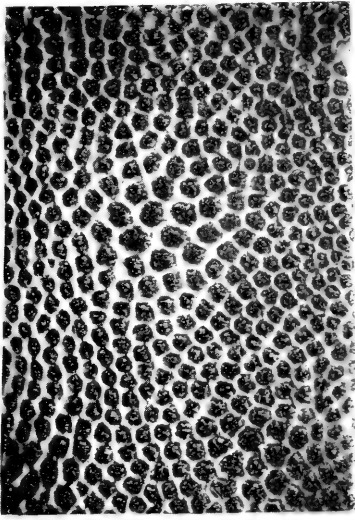

1

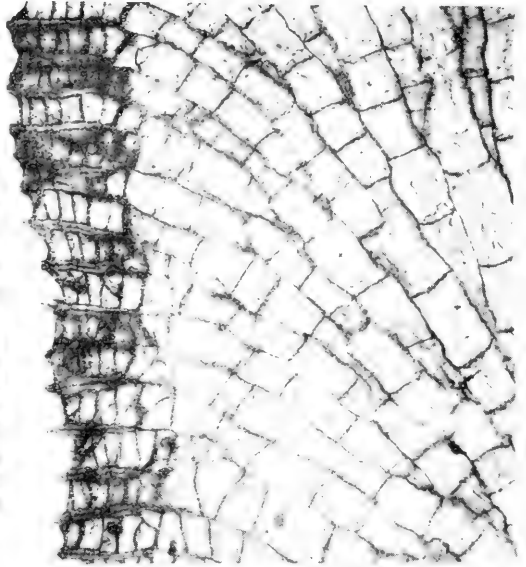

1a

1b

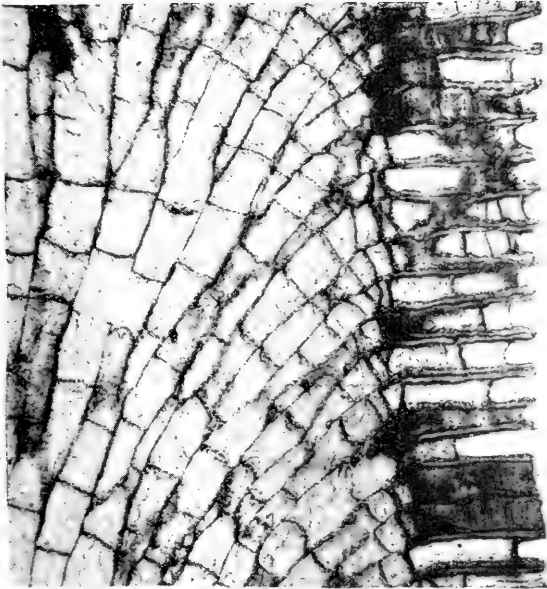

1c

PLATE IV.

	Page.
<i>Batostoma variabile</i> Ulrich.....	150
1. Cross section, showing an unusual development of cystoid diaphragms, x 18. Ballstown, Ind.	
1a. Longitudinal section of a specimen having an unusually deep mature region, x 18. Weisburg, Ind.	

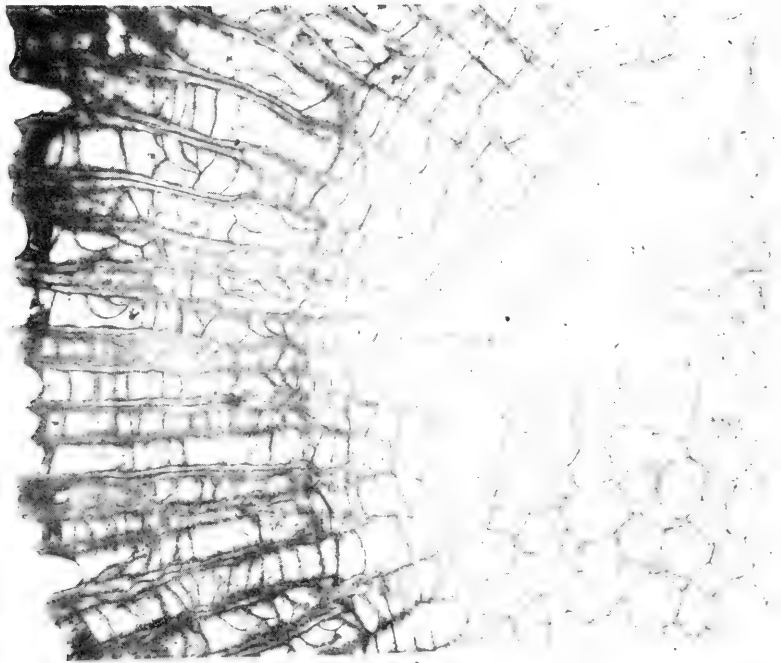

1

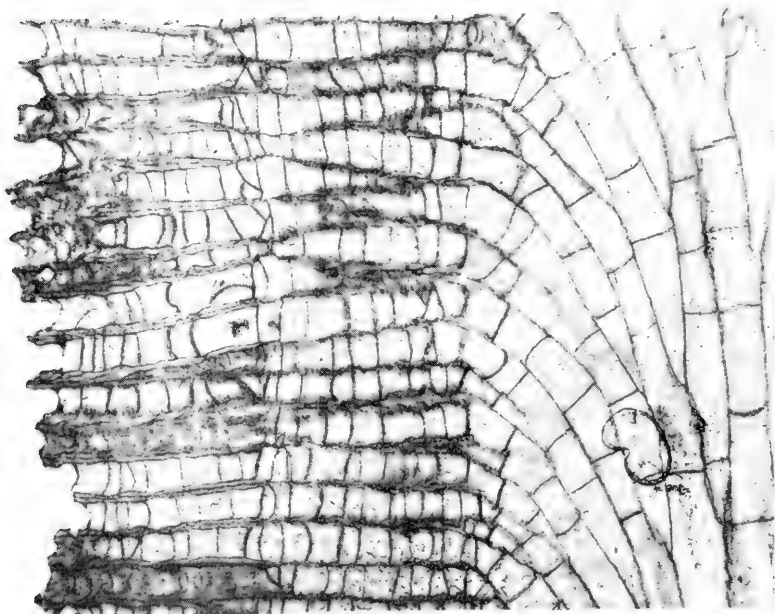

1a

PLATE V.

	Page
<i>Balostoma prosseri</i> nov.....	151
1. Tangential section, showing communication pores, x 18. Lower Liberty.	
1a. Tangential section, showing unusually large acanthopores, x 18. Lower Liberty.	
1b. Typical tangential section, x 18. Upper Waynesville.	
1c. Surface, showing numerous mesopores and acanthopores, x 9. Lower Liberty. All specimens from Weisburg.	

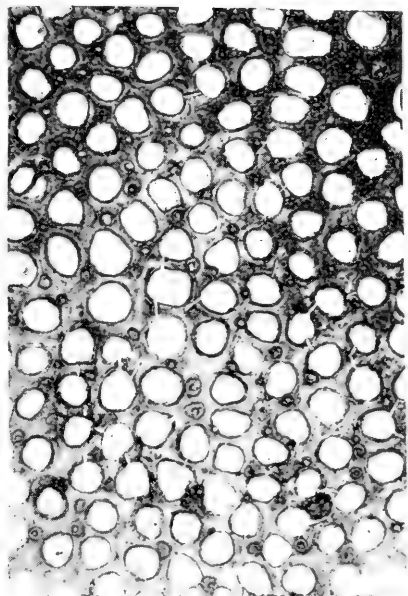

1

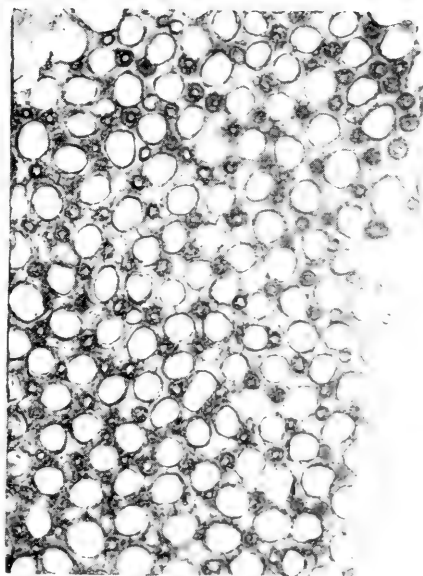

1a

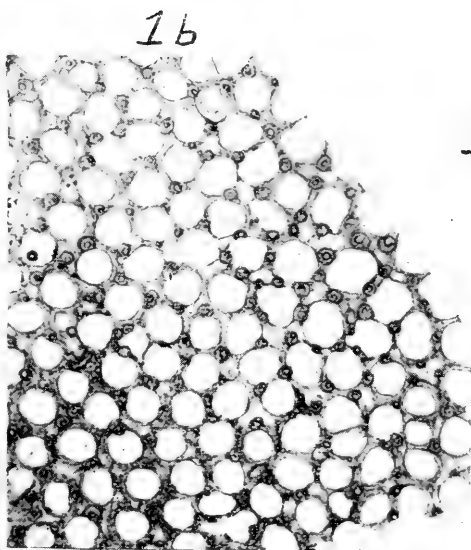

1b

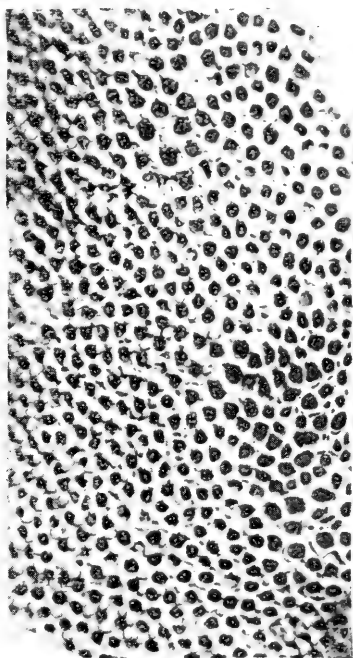

1c

PLATE VI.

	Page
<i>Batostoma prosseri</i> nov.....	151
1. Longitudinal section, showing shallow mature region, x 18. Lower Liberty.	
1a. and b. Two specimens natural size. Lower Liberty.	
1c. Typical longitudinal section, x 18. Upper Waynesville.	
1d. Longitudinal section, showing deep mature region, x 18. Upper Waynesville.	

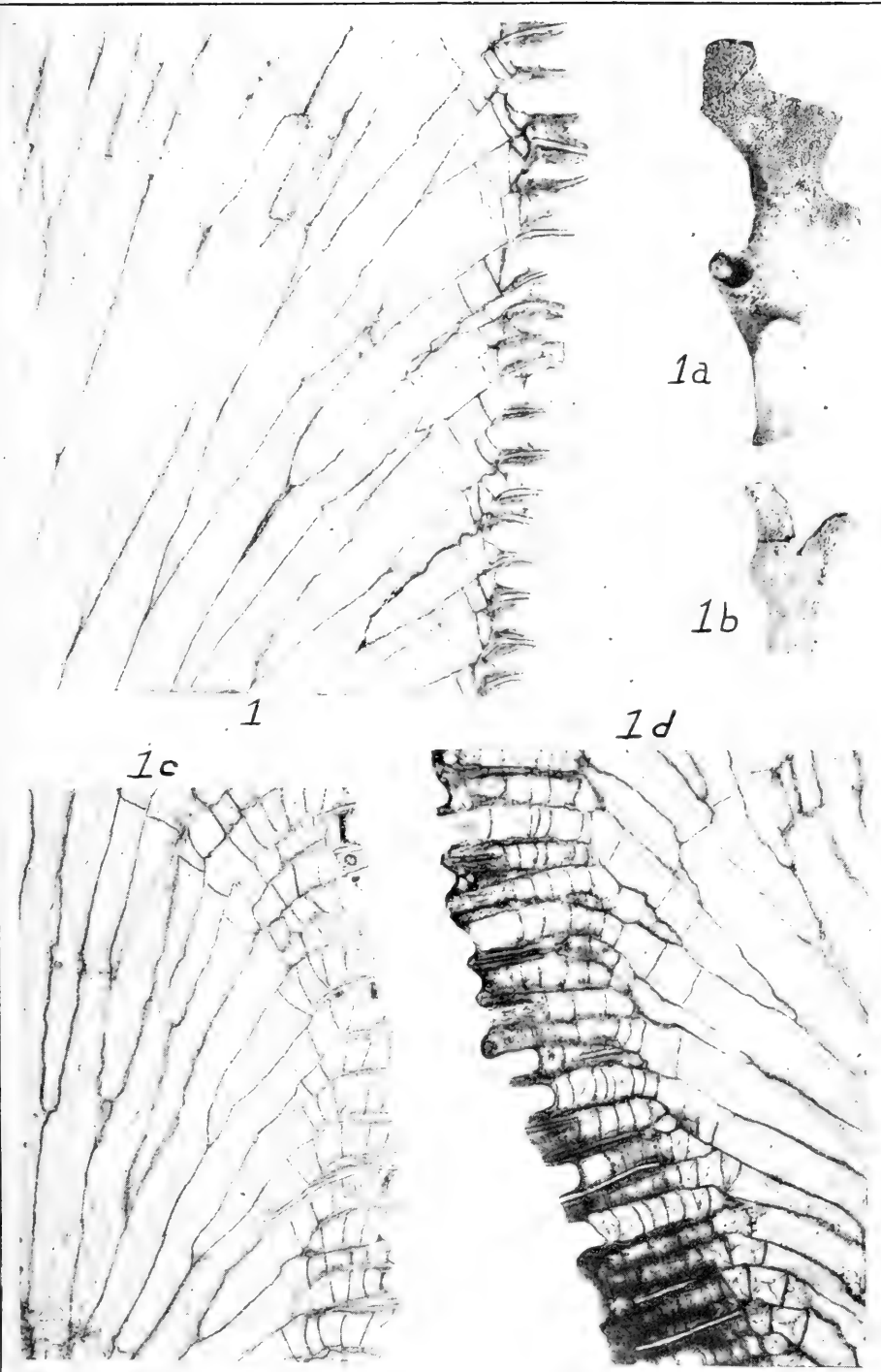
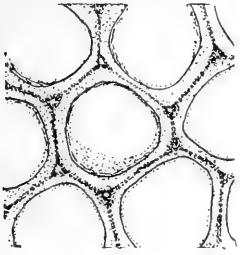

PLATE VI.

PLATE VII.

	Page.
<i>Batostoma variabile</i> Ulrich.....	150
1. Shallow Tangential section, showing thin walls. Weisburg, Ind. ¹	
1a. Deep tangential section, showing thick walls. Weisburg, Ind.	
1b. Tangential section, showing numerous indistinct acanthopores. Ballstown, Ind.	
1c. Longitudinal section. Weisburg.	
<i>Batostoma prosseri</i> nov.....	151
2. Typical tangential section, showing large acanthopores and numerous mesopores. Weisburg, Ind. Upper Waynesville.	
2a. Tangential section, showing communication pores. Weisburg, Ind. Upper Waynesville.	
2b. Tangential section, showing unusually large and numerous acanthopores. Weisburg, Ind. Upper Waynesville.	
2c. Longitudinal section.	
<i>Batostoma varians</i> (James).....	148
3. Typical tangential section.	
3a. Longitudinal section, showing spiny acanthopores crossed by diaphragms.	

¹All figures magnified 44 diameters.



1

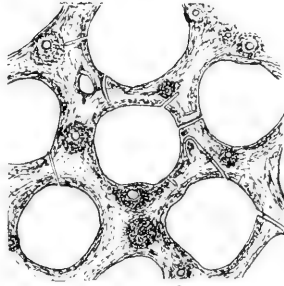

2a

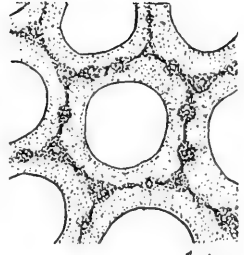

1b

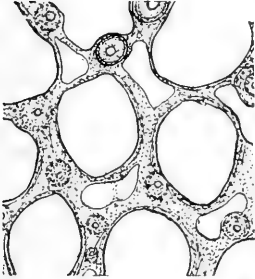

2

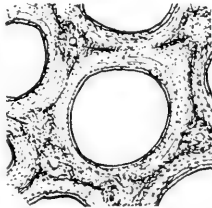

1a

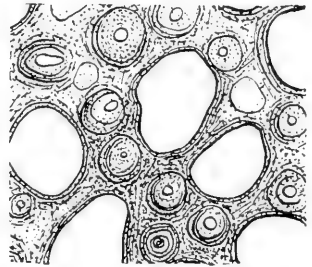

2b

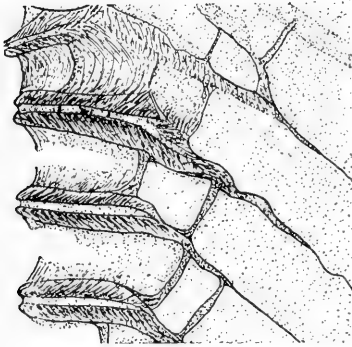

2c

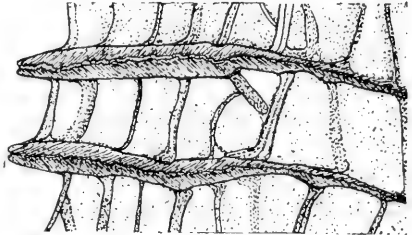

1c

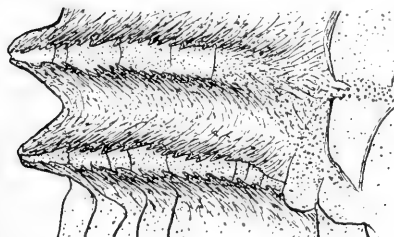

3a

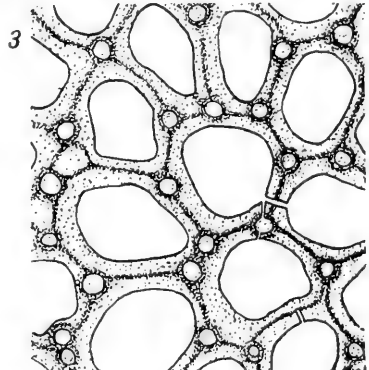

3

PLATE VII.

OBSERVATIONS, HAVING FOR THEIR OBJECT THE APPROXIMATE DETERMINATION OF THE TIME REQUIRED FOR THE EROSION OF CLIFTY AND BUTLER RAVINES IN JEFFERSON COUNTY, IND.

GLENN CULBERTSON, Hanover, Indiana.

In the Proceedings of the Indiana Academy for 1897, there is given an account of preliminary work looking forward to the determination of the period required for the erosion of Clifty and Butler ravines or valleys. This preliminary work consisted in making accurate measurements of the length of the valleys mentioned, and in drilling holes and in driving steel rods into the rocks both above, and in the amphitheater-like space beneath, the falls, and in making accurate measurements from these rods so that the rate of recession of the falls could be determined.

Nothing of value has resulted from the measurements from the rods driven in the bed of the streams above the falls. From those driven into the softer rocks beneath the falls, as described in the Proceedings of 1897, results so far as Clifty Valley is concerned are quite satisfactory. The evidence obtained in case of Butler Valley is as yet of little value.

A comparison of the measurements made at Clifty Falls fourteen years ago and very recently indicate that the sapping, as the weathering caused by the mists carried by the waterfall winds against the rocks beneath the falls, followed by frost action, is called, has been quite marked. Since 1897 the sapping has amounted to four and one-fourth inches. The sapping has been of a uniform character throughout the whole period, and certainly indicates very closely the present rate of retreat of the falls.

Four and one-fourth inches in fourteen years is very approximately at the rate of two-sevenths of an inch per year. The period required for the retreat of the falls from the edge of the deep valley of the Ohio, a distance of 11,000 feet, if the present rate of erosion has held throughout its history, should be 462,000 years.

The rock over which the water now flows at the falls is of the same character essentially as that over which the water flowed during the whole of the past history of the valley. Hence so far as that element is con-

cerned, the erosion should have been uniform throughout the period of the growth of the valley.

Whether or not the stream flowing over the falls at present is as great as in the past is a problem rather difficult of solution. The falls are in the main valley, yet as they have retreated through the two and a twelfth miles, several tributary valleys have been left to work back their heads, and because of this element it may be that there is a smaller volume of water flowing over the falls than in the past, and hence a somewhat slower retreat.

Again, the valley above the falls has certainly been growing longer, and developing tributaries, and hence has been adding to its volume of water during these milleniums, and because of this factor the falls may be retreating more rapidly than during the earlier period of its growth.

Considering all the possible factors which may have influenced the erosion of Clifty Valley, it is probable that the present rate of sapping beneath the falls, and hence the retreat of the falls up the valley, is very approximately that which has held throughout the history of its growth. Whether the valley has been entirely or only partially eroded since retreat of the ice sheet, probably the Illinoian, which at one time covered the entire region concerned, is an open question.

THE OCCURRENCE OF HAND-SPECIMENS OF JOINTED STRUCTURE IN
THE NEW ALBANY SHALE.

GLENN CULBERTSON, Hanover, Ind.

About one and one-half miles northwest of the village of Kent in Jefferson County, Indiana, and near the entrance to Lloyd's Cave, there is an outcrop of the New Albany black shale. This outcrop is found for some distance along the east and west road, and also along the road extending in a northwest direction past the upper entrance of the cave. One stratum of the shale, which is somewhat more indurated than the others, and which is approximately one-half an inch in thickness, furnishes excellent specimens of jointed structure. Both master and minor joints run so close together as to leave the weathered remnants of the shale in pieces from four to eight inches long and from two to six inches wide. The joint planes are approximately parallel, although in some cases there is considerable variation from parallelism.

Such specimens furnish excellent illustrations of jointed structure for museums and for the classroom, and are very convenient. The accompanying photograph shows several typical specimens, as found weathered out and lying on the surface. The relation of master and minor joints and the sharp outlines of the specimens are clearly indicated.

The number of specimens is seemingly rather limited, but further examination may disclose many more. So far as the writer is aware, the occurrence of such perfect specimens of jointed structure in sizes convenient for handling is very unusual if not entirely unique.

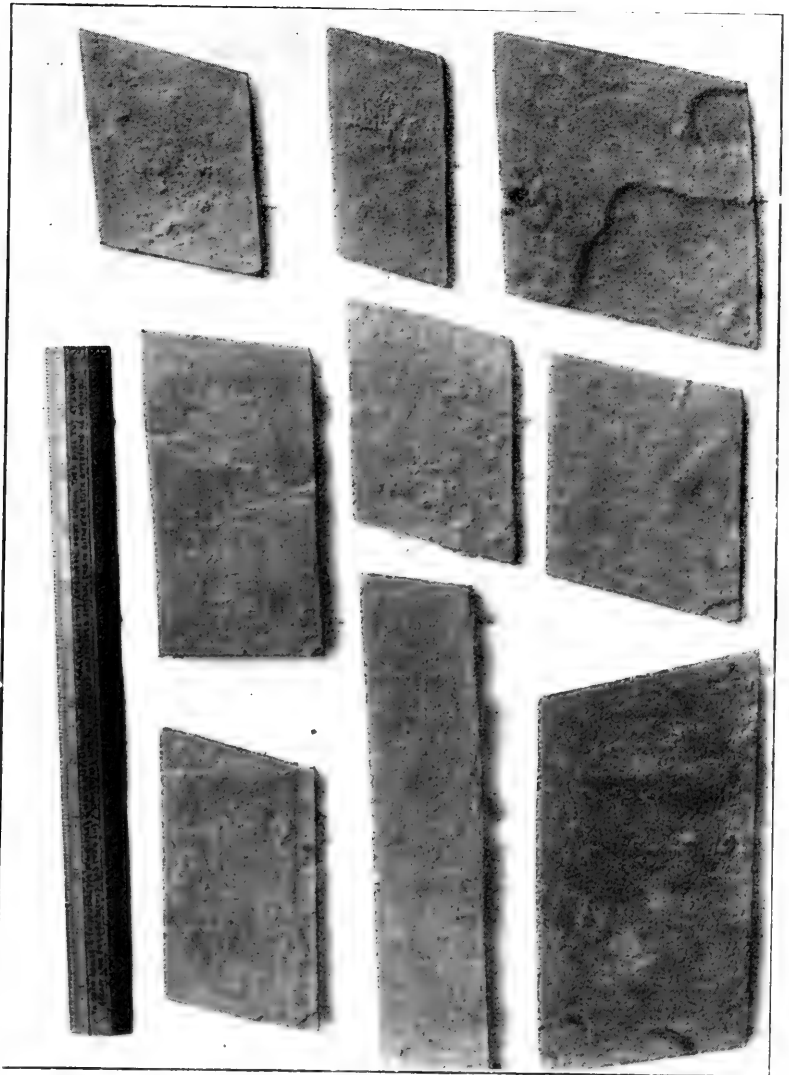

Typical specimens of jointed structure in New Albany Black Shale from Jefferson County Indiana.—Photo by Glenn Culbertson, Hanover, Indiana.

RESULTS OF GLACIATION IN INDIANA.

BY CHARLES W. SHANNON.

During the past five or six years my field work has been in both the glaciated and unglaciated parts of Indiana. The work has been chiefly concerning the surface features, such as drainage, soils, clays, gravel and sand deposits, and stone outcrops. A study of these surface features has revealed many contrasts between the two areas. Some of these are very marked, others are not so prominent at first consideration. It is the purpose of this paper to show some of these results of glaciation within the State.

For the general information concerning the ice sheets which have invaded the State, and their influence upon drainage and other physical features, I have drawn upon the works of Prof. T. C. Chamberlin, Mr. Frank Leverett, Dr. Charles R. Dryer, and others who have made special studies and investigations in glaciation within the State.

The work of the glaciers in Indiana has been attracting the attention of geologists and other investigators for a number of years. Both the State and the United States Surveys, as well as individuals, have done a great amount of work and are at present engaged in the investigation. A careful study of the glacial deposits in Indiana will throw much light upon the conditions present in adjoining States, and on the results of glaciation in general. According to Mr. Leverett, the glacial deposits and scorings of the State have been recognized from the earliest days of settlement. "It is in Indiana that we find about the first recognition in America of the boulders as erratics and of striæ as products of ice action. So long ago as 1828, granite and other rocks of distant derivation were observed by geologists near New Harmony, in the southwestern part of the State; at nearly as early a date (1842), striæ were noted near Richmond, in the eastern part of the State." But even with these observations, very little attention was given to the deposits until within the past twenty-five or thirty years.

About four-fifths of the State lies in the glaciated area. In the south central part of the State is a driftless area comprising all or a part of twenty counties.



Topography outside of influence of Glaciers. Knobstone area in Brown County.



Topography just outside the Glacial Boundary, but influenced slightly by outwash. Coal Measure area, Dubois County.

Two distinct periods of glaciation are recognized and in addition much material derived from a third, in which the advance of the ice sheet did not reach the limits of Indiana, but produced many important features by the action of wind and water upon the outwash material.

The various stages producing glacial deposits are spoken of as (1) The First Ice Invasion, chiefly that of the Illinoian ice sheet and probably an eastern lobe which reached the eastern side of Indiana. (2) The Main Loess Depositing Stage, the Iowan drift. (3) The Wisconsin Stage of Glaciation.

First Ice Invasion.—The State was invaded by ice which had its center of dispersion in the elevated districts to the east and south of Hudson Bay. From the region to the north of Lake Huron there was a movement to the west or south over the Lake Michigan Basin, Illinois and western Indiana. From a part of this sheet the part known as the Illinoian lobe was formed. The deposit left by this invasion constitutes the surface (aside from the thin covering of loess) over southwestern Indiana and an area of almost equal size in southeastern part—that is, it covers the entire area between the glacial boundary and the line of the Wisconsin drift. Many wells and drillings have shown that this drift is also present farther to the north underlying the Wisconsin. The thickness of this drift over the area of its exposure is in general about twenty-five feet except in filled valleys. In places the ridges carry but a thin coating, while adjoining valleys may be filled 100 feet or more. At the southern limit the coating of material is very thin in most places, and while the boundary is not marked by a well defined ridge, the character of the soil and the natural vegetation mark approximately the limits of the drift.

In general, the material is of a yellowish brown color to a depth of fifteen feet or more, beneath which the color is a gray or blue gray. There is every transition from the brown to the gray; it is therefore probable that the brown is an altered gray till, the oxidation of the iron having produced the color. In the filled valleys sand and gravel are often found, and in the northern part of the area the drift becomes more variable. The underlying rock formations in most of the area appear to have contributed largely to the material of the till. Where the underlying rocks are of a friable nature the material has been reduced to sand or clay and few if any pebbles remain in the till, the coarse and pebbly constituents of the

till thus varies with the character of the underlying rocks. The locally formed pebbles and rock fragments are chiefly sandstone, but numerous foreign rocks and boulders of large size are occasionally found near the limit of the drift. The region presents a fairly even topography. In places, knolls and ridges with undulating surfaces occur, but in no place do they become of great height.

Striæ are found in several places. They occur in Sullivan, Vigo, Clay, Greene and Owen counties. The markings are chiefly upon sandstone exposure. The drainage of the area covered by the Illinoian Invasion was in many respects greatly modified. In attempting to work out the history of an area whose drainage has been assisted by the invasion of the ice sheet, the life resolves itself into four fundamental parts. First. What were the topographic characteristics of the area during the preglacial history? Second. What changes took place during the glacial history? Third. What has happened since the disappearance of the ice sheet; its post glacial history? Fourth. What was the effect produced on the unglaciated parts of this area? The drainage is discussed to some extent under the heading of "Rivers and Lakes."

Loess Depositing Stage.—The Iowan Drift.—Prior to the invasion by the Illinoian ice lobe there was a marked interval of deglaciation and a similar interval occurred at the close of the Illinoian period. These intervals were marked by leaching and oxidation of the drift, the accumulation of peat and soil, and the processes of erosion. The interglacial interval following the Illinoian invasion is known as the Sangamon Stage.

The surface of the Illinoian drift outside the limits of the Wisconsin drift is covered with a fine grained yellowish silt or loam, to which the term loess has been applied. Loess is a deposit which, like sand or gravel, may be laid down whenever conditions are favorable, but since the great bulk appears to have been deposited at a definite stage in the glacial period, the time of deposition may be referred to as the Loess Stage. This loess may be of different ages, but since the materials contained are such as occur in glacial drift it must have been derived from the drift. The source is supposed to be from the Iowan drift, and the distribution due to the combined action of wind and water. The loess of Indiana varies from a fine silt of a loose floury texture to compact masses, held firmly by a calcareous cement. In some places small pebbles are found imbedded, also fossil remains of fresh water mollusks, and some insects and bones

of mammals are found. The color varies from yellow to almost white, due probably to modified forms of the same material. The thickness varies from a thin coating to twenty-five feet or more. Where exposures of the loess material occur the faces are vertical and compact, and any markings upon the face remains well preserved indefinitely. (See photograph of exposures along Wabash River north of Old Fort Knox, Knox County.) How far the material from the Iowan drift extends under the Wisconsin is not known.

The Wisconsin Stage.—Considerable time elapsed between the main deposition of loess and the invasion of the Wisconsin ice sheet. This time is designated as the Peorian Stage. Erosion produced many changes in the surface of the loess and the underlying drift. In places extensive deposits of muck and peat have been found. Following the Peorian Stage there occurred one of the most important stages of glaciation in the entire glacial period. "It is marked by heavier deposits of drift than those made at any other invasion. Throughout much of its southern boundary in the United States, a prominent ridge of drift is to be seen rising in places to a height of 100 feet or more above the outlying districts on the south, and merging into plains of drift on the north, which are nearly as elevated as its crest.

"The southern border of this drift sheet is less conspicuous in Indiana than in the States to the east and west. The ridge on its southern border in western Indiana rises scarcely twenty feet above the outer border tract, and it is no more conspicuous in central Indiana. Indeed, from near Greencastle to the vicinity of Columbus there is not a well defined ridging of drift along the border, the limits there being determined by the concealment of the loess beneath a thin sheet of bouldery drift. From the east border of East White River a few miles below Columbus, northeastward to Whitewater Valley at Alpine, in southern Fayette County, there is a sharply defined ridge of drift standing twenty feet to forty feet above outer border tracts. Upon crossing Whitewater where the border leads southeastward, it is not so well defined as west of the river, though there is usually a ridge about twenty feet in height."

Thickness of the Drift.—"There are surprising differences in the thickness of the drift within the State. The portion of the older drift exposed to view has, as already noted, an average of about thirty feet. The additional 100 feet of the newer drift is, however, deposited very

irregularly. In the belt of thick drift which leads from Benton County southeast to Marion County, and thence east into Ohio, the thickness is probably 200 feet. The portion of the newer drift area to the south of this belt has an average of about fifty to seventy-five feet. A still larger tract extending north from this belt of thick drift as far as Allen County and the west flowing portion of the Wabash, has only fifty to seventy-five feet, with limited areas where its thickness is but twenty to thirty feet. In northwestern White, southwestern Pulaski, and southern Jasper counties there are several townships in which scarcely any drift appears excepting boulders and sandy deposits. In northern Indiana the drift is very thick. Its average thickness for fifty miles south of the north boundary of the State is probably not less than 250 feet and may exceed 300 feet. At Kendallville it is 485 feet, and at several cities on the moraine which leads northeast from Fulton County to Steuben County, its thickness has been shown by gas borings to exceed 300 feet. The rock is seldom reached in that region at less than 200 feet. Were the drift to be stripped from the northern portion of Indiana its altitude would be about as low as the surface of Lake Michigan, though much of the present surface is 200 to 300 feet above the lake¹.

TOPOGRAPHY.

The surface of Indiana presents no great diversity of topographic features. The elevation above sea level ranges from 313 feet at the junction of the Ohio and Wabash rivers to about 1,285 feet, in the southern part of Randolph County. It is on this height of land that both the east and west forks of White River have their source. The average elevation of the State is about 700 feet. The greater part of the State is a plain of accumulation. North of the glacial boundary much of the area has a comparatively level surface, or only gently undulating. In the northeastern part of the State are some considerable hills and ridges, formed from the coarser materials and large boulders of the drift. These morainic ridges, some of which reach a height of 200 feet, stand out in sharp contrast to the level area of old Lake Maumee on the south, and to the sand covered area to the west. Here on the west, the Kankakee Marsh with an area of 1,000 square miles is very flat, and the area to

¹ See U. S. G. S. Monograph XXXVIII, Leverett. Also "Studies in Indiana Geography," Dryer, pp. 29-40.



Showing topography in level till plains near Princeton, Gibson County.



Glacial boulders two miles northwest Bowling Green, southern limit of glacial boulders of large size, very rare even so far to the south.

the north has scarcely any significant ridges. When sand ridges occur on the area they are usually not more than 30-50 feet high. In the dune area some of the elevations will exceed 100 feet. The lower moraine of the Wisconsin sheet presents a distinct ridging in places, with a gently undulating surface, but the range in elevation is slight. The area lying between the Wisconsin drift boundary and the farthest advance of the early ice sheet is a flat to gently rolling surface.

Exposures, wells and borings show that the preglacial surface of the drift area was much eroded, and drainage lines well advanced. If the surface could be seen it would perhaps have much the same appearance as the surface of the driftless area.

The unglaciated region is a thoroughly dissected plateau. The elevation ranges from 350 feet at the southwest corner, along the Ohio, to 1,147 feet, at Weedpatch Hill in Brown County. The hills and ridges vary much in general characteristics, according to the geological formations. But the greater part of the area may be classed as very rugged, no level tracts of very large size occur, and much of the surface is too hilly for cultivation. In general the work of the glacier in Indiana has been to make the surface more level and of much greater value from an agricultural standpoint.

DRAINAGE.

The drainage has been greatly influenced by the glaciers which have invaded the State. Many of the preglacial valleys were filled with drift and have been able to cut out only a part of the material, or in many cases have followed new lines entirely. Glacial water streams have done much on the surface, but most of these lines are represented only by the old channels, or by streams which are insignificant as compared with the flow from the ice front. In the driftless area deep valleys, gorges and ravines, are characteristic of the drainage, some of the special drainage features will be considered under the heading of Rivers and Lakes.

Rivers.—All the rivers of the State have been more or less influenced by the glacial action. In the glaciated part there is no uniformity in the drainage lines; in the driftless area a section of drainage worked out in detail will present a perfect dendritic system.

The Ohio River forms the southern boundary of the State, and flows in a winding course for 352 miles. The valley of the Ohio is very nar-

row except for a few miles near Louisville where it has developed a valley several miles wide on the Devonian shales and again widens in the southwestern part of the State, in the area of the coal measures. There are a few places between Pittsburg and Louisville where the width of the valley exceeds two miles, and usually it is less than a mile wide. The narrows above Louisville range in depth from 300 to 450 feet, below Louisville the average is about 300 and in the wider parts the depth is from 100 to 150 feet. The lower Ohio appears to be a very old drainage line.

The course of the lower Ohio is almost parallel with the dip of the formations.

There has been almost a total disregard of topographic features; the part of the river as boundary which has been directly affected by the glaciation is between Louisville and the Indiana-Ohio line. The early history of the stream has been largely obliterated by glacial deposits. The entire part of the Ohio which has been influenced by the result of glaciation extends from Louisville to Maysville, Ky., a distance of 190 miles, and including the abandoned channel near Cincinnati the glacial extent is about 225 miles. The drift deposits are found to extend down to the rock floor at a lower level than the present bed of the river, and as the material is unmodified the full excavation of the valley precedes the stage of glaciation. This work was done during the Illinoian period.

White Water.—White Water River in the eastern part of the State drains an area of about 1,500 square miles, partly from Ohio. The source of the stream is in a moraine in southern Randolph County. The east and west forks unite near Brookville.

“The head water portion for 15-20 miles are flowing in channels cut in drift. The east fork, then, near Richmond enters the rock and has carved its course partly in rocks from that point to Brookville. The west fork encounters rock at only a few points. Below Connersville it is in a partially filled preglacial valley, with broad bottom and elevated uplands on either side.

“The west fork, with its head waters, constituted an important line of drainage for the waters from the ice sheet at the time the moraine above referred to was forming and probably also at earlier stages in the glacial epoch. It is in consequence a gravel-filled valley, and the work of the present stream has been merely a removal of a small portion of these

gravel deposits. Above Cambridge it has cut scarcely twenty feet into these deposits. The depth gradually increases toward Brookville. At Brookville and below that city it has formed a channel 60-75 feet in depth."—(Leverett.)

It is possible that the northern part of the river basin drained west to the Wabash, as would be indicated by channels encountered in oil and gas borings. However, the width and depth of the lower White Water valley would require a drainage area almost as large as the present.

Blue River has a drainage area of 450 square miles, which lies wholly in the unglaciated. The flow of the stream is greatly influenced by underground channels. The fall is estimated by Tucker to be 5.34 feet per mile.

The White River System drains about one-third of the State. There are two main branches, the east and west forks, which unite at the southwest corner of Daviess County. Below the point of union the stream flows the entire distance to its junction with the Wabash through the lower part of the Illinoian drift. The west fork rises in Randolph County, where the maximum elevation is 1,285 feet; the elevation of the mouth is 375 feet. The total length of the stream is about 275 miles, with probably another 100 miles of windings. The average fall is nearly three feet per mile or more than twice that of the Wabash. The entire course is through the glacial area. The two main tributaries are Fall Creek having its source in a cascade ten feet in height at Pendleton, and Eel River which has a length of 100 miles; the source of the west fork is in southern Boone County. It flows over the edge of the Wisconsin drift in Putnam County. The eastern fork rises in Hendricks and flows through the limestone region in Owen County, where a series of falls are produced. Eel River is a very meandering stream with a sand-choked channel. The material is derived in part from glacial material but largely from the heavy sandstone formations exposed along the course, and especially on the tributaries.

The east fork of White River rises just below the southwest corner of Randolph County, a short distance from the head of west fork.

The main streams of these forks grow farther apart until they reach Shelby and Marion counties, where they approach each other then again turn from one another until the east fork reaches the southeast corner of Bartholomew County. This fork then turns in a southwest direction



Showing polished surface of sandstone. James Campbell farm north of Bowling Green.



Glacial Striae on Mansfield sandstone. James Campbell farm, north of Bowling Green. The marks to the left running at right angles to the scorings are cracks. Markings are filled with white sand to give contrast.

and crosses the glacial boundary near Brownstown, Jackson County. It cuts across the unglaciated area in a west-southwest direction, and is cut to a comparatively low gradient, although it has cut through many rock formations of great hardness. The valley has been filled to such an extent that the present stream is on the average about 100 feet above rock floor. The bluffs are 200 to 300 feet above the present valley floor, thus giving the preglacial valley a depth of 300 to 400 feet. In the unglaciated area the east fork receives only one important tributary from the north, that is Salt Creek. This creek lies wholly in unglaciated area but probably carried much water from the melting heads of glaciers which passed through the divides to the northeast, as is evidenced by the filling of sand and gravel in the upper course of the tributaries, as example Hubbard's Gap, Monroe County and eastern part of Brown County. The streams leading down from these gaps have strewn along their courses glacial boulders of considerable size.

In the Salt Creek basin the valleys are cut to great depth and a dendritic system of drainage has been developed which stands out in contrast to the irregular and unsymmetrical drainage system of the streams within the drift area to the north and east.

Lost River, an eastern tributary to east fork, is entirely out of drift limits area and for a distance of 12-15 miles flows through a subterranean channel. In flood times part of the water flows over the old surface bed.

The Muscatatuck, a large tributary from the east, has little fall compared with the neighboring part of the east fork. At the railway crossing south of Seymour the bed of the Muscatatuck is forty feet lower than at the crossing on the east fork to the north of Seymour. The difference is due to a filling of the east fork valley by deposits of gravel from the Wisconsin glacier. The Muscatatuck lies outside of the Wisconsin drift limits and the reach of its waters and the valley remains unfilled.

The principal tributaries of east fork to the northeast are Blue River and Little Flat Rock Creek. These tributaries have an average fall of about five feet per mile. From Columbus near the edge of the Wisconsin drift to the mouth of the Muscatatuck the fall is about twenty inches per mile. In the old preglacial valley through the driftless area the fall is about ten inches per mile. Riffles and rapids in this part of the course, however, increase the fall. The Hindostan Falls below Shoals give a

descent of about five feet; here the stream has cut off an old oxbow and is cutting down the rock in the ridge encircled by the oxbow.

The Patoka is a sluggish stream flowing along to the south of east fork of White River for a distance of about 100 miles, with a very narrow drainage basin, nowhere exceeding twenty miles in width. The river rises in the Huron Sandstone of southern Orange County, thus having its source in the driftless area, but in the vicinity of Jasper, Dubois County, it comes in contact with the drift. The present drainage system is made up of three small drainage systems which were formerly distinct and the waters of which flowed to the northwestward to west and east forks of White River. "The upper system embraced the portion above Jasper, the old divide being at the northeast border of that village. The middle system embraced the portion between Jasper and Velpen and the lower part from Velpen down to the vicinity of Princeton. The old drainage way there turned north to White River near Hazelton, but the present stream continues westward across a rock pass into the Wabash."—Leverett.

These streams which had then a northwestern discharge have been turned westward, just outside the glacial boundary to form the present Patoka River.

The Wabash River has a large drainage area within the State. The river rises in the western part of Ohio, flows across central Indiana then turns south and from a point a few miles below Terre Haute forms the Indiana-Illinois boundary to its junction with the Ohio. The main stream lies entirely within the glaciated area and practically all the waters from the system come from the drift surface. The river enters a preglacial valley just north of Lafayette, and after following this valley for a few miles, turns southwestward across a rock point, while the preglacial valley takes a longer route to the west and south, joining the river at the bend near Covington. From this point southwest the river follows the preglacial valley to the Ohio. Above Terre Haute the present stream has cut out only a part of the old valley, while to the south the river bottoms extend from bluff to bluff of the old valley. At Terre Haute the valley is five miles wide, to the north from 2-4 miles, and increases to the south to about fifteen miles near the mouth of the river. In the upper part of its course at Huntington the river enters the old outlet of glacial Lake Maumee. The old valley here is several times

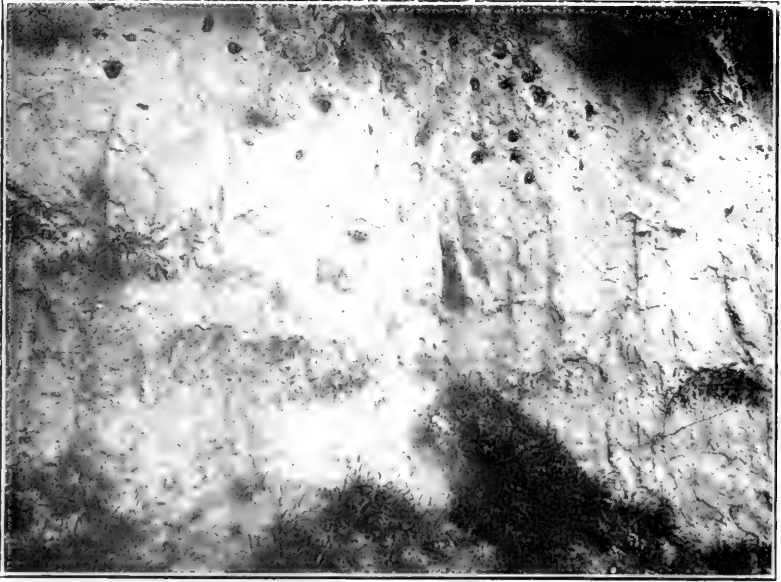

Vertical face of loess along the Wabash north of Old Fort Knox. Withstands weathering—
 Letters which have been cut in face for long time remain unchanged.

as wide as that occupied by the river above this point. From Huntington it flows in a westward course and has opened up a post glacial line as far as Lafayette, where it joins a preglacial channel as mentioned above.

Big Raccoon Creek and its main tributary *Little Raccoon Creek* drain an area of about 500 square miles. At the southern edge of Parke County the stream enters an old channel of the Wabash and follows this channel for about fifteen miles northward before entering the Wabash.

Busseron Creek, a tributary of the Wabash, has its source near the Clay and Vigo line. The general direction of the stream is southwest across Sullivan County into the Wabash. For a few miles near the mouth the stream probably occupies a preglacial channel, otherwise it is not influenced by preglacial drainage.

There are two Eel rivers within the State. One a tributary of the Wabash entering at Logansport and the other a tributary of White River entering just above Worthington.

Along the latter and its tributaries are some of the best rock exposures in southern Indiana. These exposures are chiefly in the Mansfield sandstone. It is a very meandering stream and at present the question of the drainage of some of the bottom lands which are subject to overflow is receiving serious consideration in Clay, Vigo and Greene counties. From the great bend westward to the Wabash there is a continuous strip of almost level country.

The Salamonie River enters the Wabash from the southeast near the city of Wabash. The river is about seventy-five miles in length and flows along a plain along the south side of a moraine. The Mississinewa enters near Peru. It has a length of about 160 miles and its channel is cut mainly in drift, but in a few places down to solid rock. *The Tippecanoe River* is the main tributary from the northwest. Its source is in the moraines in the northeast part of the State. Its course is controlled by the moraines. From the moraines it passes through a sand plain of "Old Lake Kankakee" then again follows the course of a moraine along the northwest side of the Wabash, and enters it a few miles below Delphi.

The Kankakee River is a very sluggish stream, flowing a distance of about seventy-five miles in Indiana by a very meandering course in which the river is said to make 2,000 bends



Washes in Glacial till, eastern Gibson County. Thickness about 50 feet.

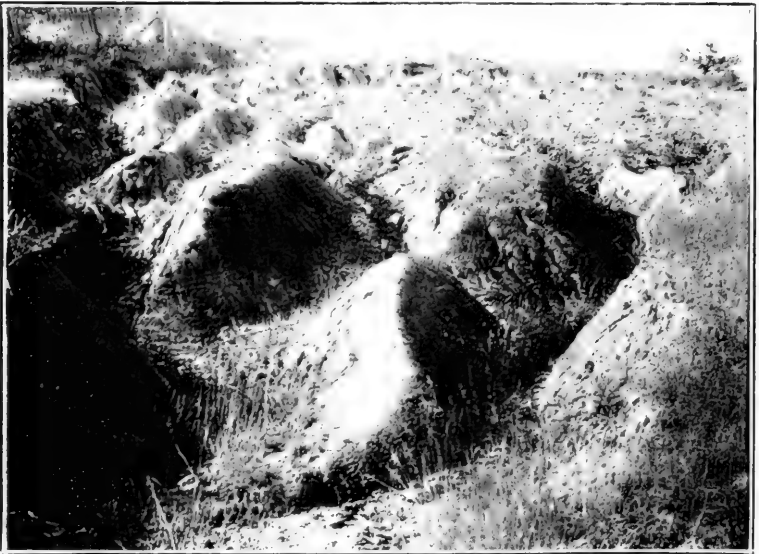

Glacial till intermingled with large fragments of sandstone from local formations. Gibson County.

In Illinois the Kankakee unites with the DesPlaines to form the Illinois. The river drains an area of about 3,040 square miles in Indiana. The general trend of the watershed is from east to west with an entire length of 200 miles and a north and south width of seventy miles. All the north tributaries have their source in the Valparaiso morainic system. The southern limit of the watershed is in the Iroquois and Marseilles moraines. There is no well defined ridge separating the watershed of the Kankakee from that of the Wabash. The river rises in a marsh near South Bend in the edge of a moraine. The Kankakee marshes comprise the most extensive body of swamp land in Indiana. In the seven counties drained by the river the original area of the marsh was almost a half million acres. In many places wild rice, rushes, water-lilies and grasses grow so abundantly in the channel as to cause the flooding of the marshes even during a summer freshet. In former years the river could scarcely be approached but now more than a dozen railways cross the stream and numerous highways bridge its waters. The surface of the marsh land is for the most part a treeless plain except along the immediate border of the river, where some trees are found. The soil is in general a dark, sandy clay soil, rich in organic matter. The sand content varies, and presents a number of soil types. According to situation the soils would be classed as swamp, marsh, island, peat and muck.

The St. Joseph River, now tributary to Lake Michigan, formerly discharged through the Kankakee. It has a drainage area of about 4,000 square miles. *Papaw River* which joins it near the mouth is the chief tributary. It has its source in the swampy region to the east of Valparaiso Moraine. *Pipestone Creek* and *Dowagiac River* are other tributaries.

Yellow River drains an area of about 700 square miles lying to the east of the moraine in which the Kankakee also has its source.

About 800 miles of the Iroquois watershed lies in Indiana. In most of its course the stream is sluggish and the drainage imperfect. The soil of the area is a sandy loam and is largely under cultivation. The natural waterways have been greatly assisted in drainage by systems of ditching.

The Calumet River has its source in the Valparaiso morainic system south of Michigan City. All the tributaries enter from the south side. The course of the stream and tributaries are controlled to some extent by the sand dunes along the beaches of the old lake. The stream now

discharges at South Chicago in Illinois. The old discharge was in Lake County on the southeast border of the lake. Near the source the river flows in an almost straight line and has the appearance of an artificial ditch rather than a natural stream. After flowing across the counties of Porter and Lake it crosses the State line but three miles south of its entry into Porter County and almost due west of its source. From the State line it flows in a northwesterly direction, for about seven miles and then at Blue Island, Illinois, it makes a sharp curve, then flows northeast then southeast and again crosses into Lake County about three miles north of its first line then continuing eastward for fourteen miles to its old point of discharge, but two and a half miles from the point where it first entered Lake County. The area included in this meander consists of slightly elevated morainic tracts, sandy beaches and marshes.

LAKES.

In the northern part of the State are hundreds of lakes varying much in size. These lakes are chiefly confined to the four northern tiers of counties. These lakes are all due to the irregular deposition of glacial drift. They occupy basins within the morainic area. They may be divided into three classes. (1) Kettle Hole Lakes, those which have been formed by the melting of detached blocks of ice. (2) Channel Lakes, in which the basins are the abandoned channels of glacial streams. (3) Irregular lakes, those with no general form of outline but are due to the irregular depressions formed in the accumulated drift.

The abundant vegetation has produced considerable deposits of peat about the margins of many of the lakes, and many of the smaller ones have been completely filled. Good marl deposits also occur in many of the lakes and is being utilized for the manufacture of cement, brick and tile.

No lakes occur outside the limits of the Wisconsin drift, although many basins of extinct lakes occur over the southwestern border of the Illinoian. Some small ponded areas are found which take considerable proportions in wet seasons but are not permanent. In the driftless area numerous small ponds are found, which owe their origin chiefly to sink hole depressions in which the outlet has become clogged.

For description of Indiana Streams, see U. S. G. S. Monographs XXXVII and XLI.—Leverett.



Niagara limestone exposed in the Wabash Arch at Wabash



Niagara limestone exposed in the channel of the Wabash river at Logansport.

SOILS.

The soils of the State are of two general classes.

First. *Sedentary or Residual Soils.*—These are the soils in place, they have not been removed from the parent rock. Such soils occur throughout the driftless area. They vary much in color, texture structure and natural fertility, according to the nature of the formation of which they have been derived. The poor soils are those derived from the shales and the sandstones. Those from the limestones are rather fertile, but will not stand continuous cropping, but soon become depleted. The residual soils are as a rule not very deep and do not withstand drouth very well.

Another group of soils to be classed as sedentary are in cumulous deposits as peat, muck and swamp, since they result from the gradual accumulation of material "in situ." Though differening in both composition and origin from those just described such soils are common in the northern part of the State in the Wisconsin drift.

Peat occurs only in very limited areas outside of the Wisconsin drift boundary. Muck areas occur about the margins of the many lakes and thousands of acres are in the swamp areas of the lake region and the Kankakee basin.

Second. *Transported Soils.*—Those which have been transported by the power of water, wind and ice. These are known as colluvial, alluvial and glacial drift soils. The two latter classes are of most importance. All of the alluvial soils of the State are fertile both in the glaciated and driftless areas. A large part of the river bottom soils are low lying and difficult to drain. These soils vary from the sands and gravel to the stiffest clays, but in general they are a good clay loam. Corn is the principal crop.

The drift soils are composed of a great variety of types, and mostly of good to fair fertility. The black loam of the drift has made Indiana take first place among the States in the production of corn and other staple crops. The glacial drift is for the most part a very productive and permanent soil. The drift deposits are varied in the arrangement of clay, gravel and sand, so that what is true in one locality may be entirely different in another. But in general it consists of a confused mass of material derived from many sources and is usually rich in all the necessary plant foods.

The line between the residual types and the loess covered tracts is well defined as to differences of plant growth and crop production, but the line between the pale silt and the black soils of the Wisconsin drift is very conspicuous.

The loess soils are easily cultivated, much of the surface of a well filled field is frequently a loose floury dust, and when small clods occur they are easily broken. The soil may be plowed when wet and yet easily be worked to a loose pliable condition. There is a marked deficiency of organic matter in the virgin soil and as this amount becomes less the soils get in a poor physical condition and are sometimes difficult to manage. A systematic rotation of crops and good application of stable manure are necessary to keep the soils in good condition for cultivation. Much of the land is used for pasture, but when left uncultivated for a few years the ground becomes covered with a growth of briars.

The principal alluvial soils of the State are those of the White River, Wabash and Ohio Valleys. The valleys of these streams and their tributaries are the results of stream erosion, and chiefly by the streams which now occupy them. During the glacial period they were largely choked with drift, only a small part of which has been removed; gorges and ravines exist in great numbers along the White Water, White and Ohio rivers and their tributaries. The eastern tributaries of the Wabash in Fountain and Parke counties flow through deep gorges cut in the sandstone. The streams flowing from the glacial area had their valleys flooded with glacial waters and choked with glacial debris. The effect of this is shown by the extensive terraces of sand and gravel which border their present channels. Between these terraces are the bottom lands, large areas of which contain very productive soils.

A larger percentage of the drift soils are suited for cultivation than those of the driftless area, but there are, however, large areas of the former which are either too rough for agricultural purposes, as in the boulder morainic belts, or too wet, as in the lake and marsh districts of the northern part of the State.

ROCK OUTCROPS.

In the northern part of the State rock outcrops are few. At Mokena, Illinois, occurs the first limestone outcrop along the Kankakee, and from that point to its junction with the Iroquois there is a solid



Oolitic limestone weathering into soil. Cleveland Quarry near Harrodsburg, Monroe County. Typical example of the source of the residual soils of the driftless area.

rock bed. At Mومence some of the rock ledge has been blasted away in an effort to give a better flow to the Kankakee. The Wabash arch presents the best exposure in the central and northern part of the State. Following down the Wabash numerous outcrops occur, at Logansport, Covington, Merom, Vincennes and below New Harmony. The rock gorges along Sugar Creek below Crawfordsville afford some of the most picturesque scenery within the State. Above Crawfordsville the channel is shallow and touches rock only at a few places. Rocky Fork, in Parke County, also has many erosive features of similar appearance. In Vigo County many exposures occur along the tributaries of the Wabash. Along Eel River in Putnam County and Clay County are some excellent examples of erosion in the Mansfield Sandstone. Croy's Creek, a main tributary, is lined with gorges, undercuts, vertical walls, and cliffs with steep slopes. The falls of the east fork of Eel River at Cataract in Owen County are over the limestone. In the eastern part of the State along Clifty Creek, Big Flat Rock and Little Flat Rock there are long stretches of rock bottom and bank exposures in the Devonian and Upper Silurian. Along the channel of White Water and at Madison is found some of the very best of scenery. The rock bluffs along the Muscatatuck, as at Vernon, and the shale in the beds of the streams to the south, as about Henryville, are also of prominence in the southeastern part of the State. In the southwest the bluffs of the Patoka are specially noted. These are only a part of the rock outcrops within the drift area, and in addition to the many exposures of natural ledges may also be mentioned the great deposits of conglomerate gravel which presents some rugged surfaces, as along the upper Wabash and along White River to the northeast of Noblesville.

In the driftless area the bare rock surfaces give all sorts of weathered forms. The sandstone areas have the most striking features, with the almost vertical cliffs, rising in some cases to 200 feet or more. The scenery of the driftless area is not excelled by any in the State, or along the Ohio Valley, or indeed, by any in the Middle West.

Most of the streams of the State would afford good water power; many examples of good power sites are present which could be utilized with little cost. Rock exposures in the bed of some of the streams afford greater fall and at the same time good solid bases for dams or other works to be constructed.

An accurate topographic map of the State would show the contrast in the physical features of the glaciated and the unglaciated portions better than any other description or illustration that could be given to a person who had not been over the area to investigate the contrast. In the glaciated area the lines would run in large regular curves and far apart, showing the smoothness and regularity of the surface. South of the drift limit the lines would be close together with a very winding course and sharp curves, showing a region of deep, narrow valleys, irregular divides and abrupt cliffs.

POPULATION AND LAND VALUES.

About four-fifths of Indiana is in the glaciated area.

Excluding Indianapolis, about one-eighth of the population of the State is in the unglaciated area. New Albion and Jeffersonville, although included in the unglaciated area, really do not belong in that class but are river valley towns and their population has been increased by the condition of the surrounding area.

The next largest towns in the unglaciated area are, Bloomington and Bedford, with populations of about 9,000 each, with no other towns coming up to this size by less than half.

In the unglaciated area the average per cent. of the land under cultivation is about 60 per cent. and is valued on the average at about \$40 per acre, while in the glaciated area over 75 per cent. is under cultivation and sells on the average at \$85 per acre. The average is lowered greatly by the sand hills of Lake County. In the central counties about 95 per cent. of the land is under cultivation, and much of it sells at prices ranging from \$100 to \$150 per acre, or even more where within a few miles of good market centers.

THE SAND AREAS OF INDIANA.

BY CHAS. W. SHANNON.

Sand deposits may be studied from two points of view, first as to origin and structure, second as to their economic value. Dune sand is a kind of soil and at the same time is a particular kind of deposit.

The sand areas of Indiana consist of sand-dunes, sand-hills, sand-flats or "swales" and sand prairies. The principal areas of the sand deposits are. (1) The dunes and ridges about the head of Lake Michigan. (2) The great expanse of the sand-hills and plains to the south of the principal dune area, extending to the southern limit of the marshy area south of the Kankakee River and east to the gravelly moraines. (3) The sand prairies of the lower Wabash Valley. (4) The deposits along the Ohio River. (5) The deposits along White River and its tributaries.

The Dune Area.—One of the marked features of the northern part of the State is the shifting dunes and ridges of sand. These great tracts of sand about the head of Lake Michigan belong wholly to beach accumulations, being sand derived from the immediate south shore, and from the erosion of the eastern and western shores and carried southward by shore currents during northern gales, and after being rolled upon the south shore it is carried inland by the winds and built up into unstable hillocks and ridges.

"Dune sand consists of loose, incoherent sand forming hillocks, rounded hills and ridges of various heights. Dunes are found along the shores of lakes, rivers or oceans, and in desert areas. They are usually of little value in their natural condition because of their irregular surface, the loose open nature of the material, and its low water holding capacity. Dunes are frequently unstable and drift from place to place. The control of these dunes by the use of windbreaks and binding grasses is frequently necessary, as at Cape Cod and on the coast of California, for the protection of adjoining agricultural lands. In certain regions they have been improved for agricultural purposes or employed as catchment areas in city water supplies or planted to pine forests for the protection of agricultural lands and for revenue."—U. S. Bureau Soils.

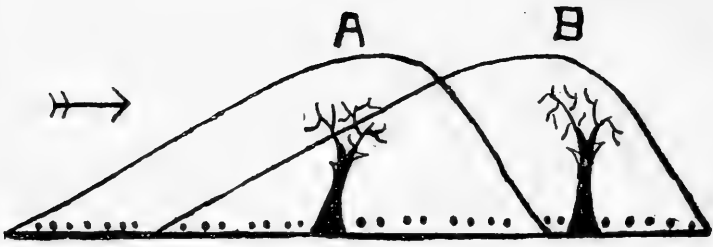

Showing Progress of Dune from "A" to "B."

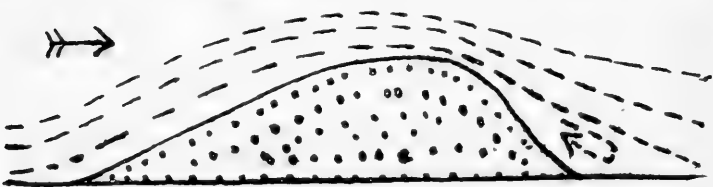

Relation of Dune Profile to the Wind.

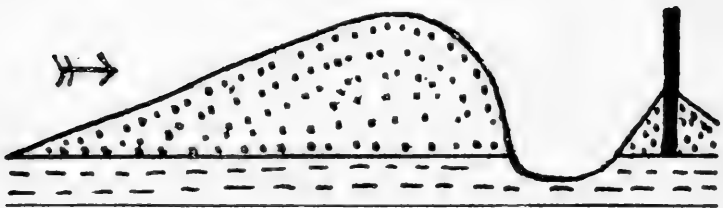

As Affected by a Solid Object—as a Fence.

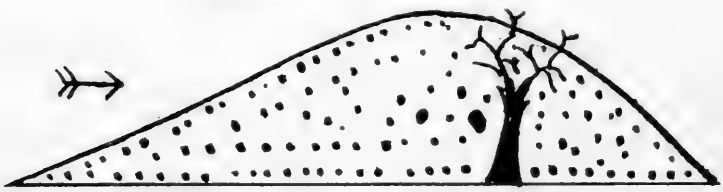

By an Inflexible Object—as a Tree.

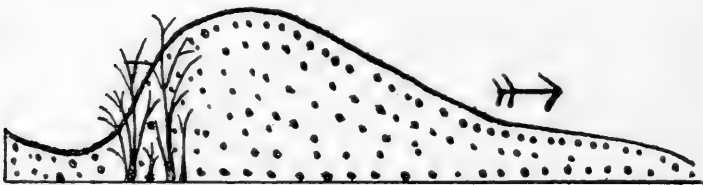

By a Flexible Object—as Grass.

Wherever a sandy soil occurs unprotected by vegetation dunes are built up. They are usually roughly stratified, the degree of stratification and the thickness of the beds depending upon the force and direction of the wind. The sand grains become much rounded by abrasion, and in many cases become very small. Sand grains are heavier than dust particles and are not raised far above the surface by the winds; the larger grains being rolled along on the surface. The movement is very similar to that of "frozen" snow in drifting.

From Michigan City, Indiana, west for a distance of about twenty-five miles the lake beach presents a line of sand-dunes, averaging in width from one-third to one-half mile, and in places 150 to 200 feet high. Farther to the west to the State line the beach spreads out into a broad belt of low ridges running parallel and with an extreme width of about two miles. It has been estimated that after deducting the sand deposited by Lake Chicago that at least half a billion cubic yards of material have been added to the surface of Lake and Porter counties alone by the waters of the present lake. The dunes and ridges are most typically developed on a large scale about Michigan City in the great "Hoosier Slide," which has stood as the greatest and most noted of the dunes. During the past few years this dune has had its bulk greatly decreased by the hauling away of the sand by the hundreds of train-loads for various economic purposes. The sand sells for about three dollars a carload. Railroad switches are laid along the sides of the dune and steam shovels scoop out the sand and dump it into the cars. Many cars are also loaded with hand shovels and wheelbarrows. When a cavity is made in the sand the wind soon brings down a new supply from the top and renews the deposit. A sand brick and building block factory located in the southeastern part of the dune finds its supply of raw material continually replaced at its shed doors. Practically all the railroads entering Chicago have used this sand in track ballast and elevation. Great trestles have been filled and swamps and marshes along rights of way have been covered with the sand. The dunes and ridges at Dune Park, about twelve miles to the southwest of Michigan City, are very extensive and are also a source of much of the sand shipped out for numerous purposes. In addition to the use mentioned the sand is used for the filling of city lots, building sand, and many manufactured products.

The Origin and Accumulation of the Sand.—Estimates were made several years ago by Dr. Andrews to determine the amount of sand belonging to the Lake Chicago deposits and the amount belonging to the work of the present lake. It was found that the lake was encroaching upon the western border and on the eastern border along southwestern Michigan. In Indiana the lake is filling in rather than extending its borders. The estimates show that the combined bulk of the beaches formed by Lake Chicago is nearly equal to that due to the present lake. The length of time involved in the accumulation of the beach deposits was estimated by measuring the amount of sand carried southward past the piers at Chicago and Michigan City. The sand stopped by the two piers annually was found to be 129,000 cubic yards. Since the estimate shows that not more than one-fourth or one-fifth of the drifting sand is stopped by the piers, the period for the accumulation is given as less than 6,000 years, or about 3,000 for Lake Michigan. Dr. Andrews has also estimated the age of the lake from the annual amount of destruction from the bluffs.

“Dr. Andrews’s estimates were based on the assumption that there is a southward-flowing current on each side of the lake, carrying sand to its present head. Investigations made by the Weather Bureau in 1892 and 1893, under the direction of Pro. Mark Harrington, led him to the conclusion that the currents on the east shore in the southern portion of the basin are northward instead of southward. He accounts for the accumulation of sand on the north side of breakwaters along this coast by the action of the surf, in storms blowing from the north which is more transient than the currents proper and would affect the southern part of Lake Michigan only when the wind was in the north. This occasional phenomenon is very efficient when it occurs. He concludes that the estimates of the time involved in the formation of beaches have less value than they would have if the accumulations were due more largely to lake currents.

“Considerable study of the movement of water in Lake Michigan has been made by the Chicago Drainage Commission, largely under the direction of Professor Cooley. As a result of these investigations, which involve not only a study of bottle papers but also a thorough canvass of the opinions of lake captains and an examination of breakwaters, Cooley has reached the conclusion that the effective work on the shores is due to waves and not to currents, and it is a matter of doubt if this lake has



Hoosier Slide as viewed across the docks at Michigan City. The entire foreground is a solid expanse of sand.

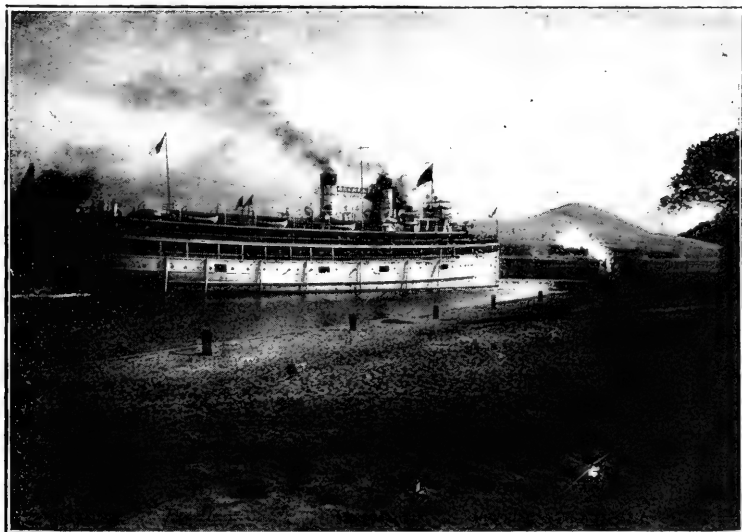

Hoosier Slide as viewed across the docks at Michigan City. Chicago-Michigan City steamer "Roosevelt" in the foreground.

such a system of currents as is indicated by Professor Harrington's charts. The movement of the water seems to depend mainly upon the wind, but is governed to some degree by the contour of the shores. If the north winds prevail for a few days, as is often the case in the spring months, the surface water appears to have a southward movement throughout the breadth of the lake, and return currents must be at some depth. On the other hand, a prevailing south wind, such as occurs for short periods during the summer, will induce a northward movement across the entire breadth of the lake. The contours of the shore seem to favor a northward movement from direct west winds in the north half and a southward movement in the south half of the lake. As the prevailing winds are often from the west, these become the most protracted of the movements of the surface water. Cooley has found that breakwaters along the shore support this interpretation. In the southern half of the lake they are largely constructed to protect the harbors from the drift on the north side, while in the northern half they are constructed to protect them from drift coming from the south. In view of this apparently changeable course of lake movements, it seems doubtful if estimates, such as Dr. Andrews attempted, have the value that some have attached to them.¹

"Near the shore the bottom of Lake Michigan is uniformly covered with sand. At the shore line this sand is about ten feet deep and it extends out to where the water reaches a depth of about thirty-five feet. Beyond this depth of water the lake bottom is composed of a stiff, tenacious blue clay, which is said to contain partings, or pockets of sand from whence, in part, comes the supply which is constantly being carried to the shore by the waves. Much of this sand is doubtless blown from the dunes by south winds back over the lake, and, falling on its surface is again brought to land. Moreover, by storms and by ice jams in the spring all projecting points along the lake are slowly worn down and the material composing them is carried out to be again returned and built up in a new place. Thus much of the sand is in constant circulation, and the necessary new supply is not as great as it seems to be.

"Much gravel, consisting of pebbles ranging in size from the size of a hen's egg to that of a small marble, is washed up by the waves to within a foot or two of the margin of the water. In many places it is raked out

¹ U. S. G. S. Monograph XXXVIII, pp. 455-56.

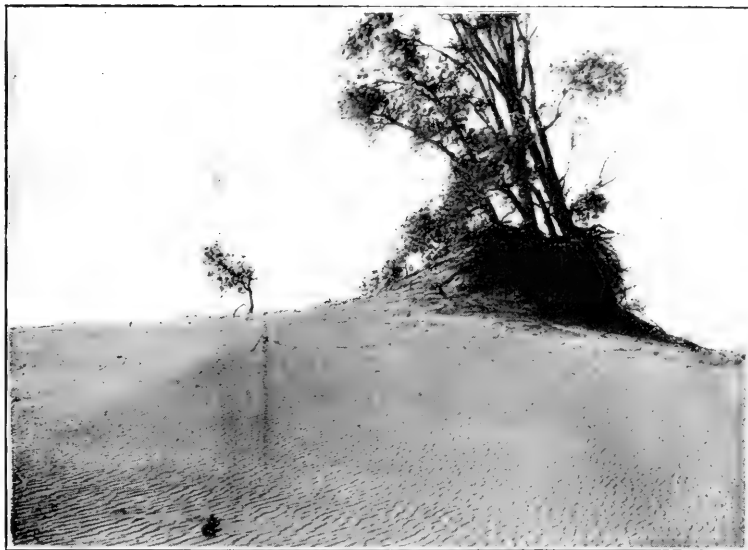

Uprooting of trees on sand dunes at Dune Park Ind. Wind ripples in foreground



Uprooting of tree caused by the south side of the dune being disturbed by the building of interurban line. The sand at once began to move on and the old dune was destroyed.

by hand and carted beyond the reach of the high storm waves, and afterwards loaded and shipped by rail to Chicago, where it is used in roofing and concrete pavements. The immediate source of this gravel doubtless is the blue glacial till which forms the greater part of the floor of the lake, since the composition of the pebbles plainly show that they came originally from formations which lie far to the northwest."¹

If a person stands upon the southern shore of the lake and observes the waves coming in, he will notice that each wave carries up a small quantity of sand, and when it is rolled up far enough to be out of the reach of other waves until it has had time to dry it is rolled farther inland by the wind and is added to the great mass of sand already accumulated, which goes to build up the dunes and the ridges. The surface of dry sand over which the wind blows for a considerable length of time is generally marked with ripples just as the sand in the bottom of a shallow stream. The ripples are small, but their shape and structure is the same as that of the larger dune of which they are a part. The long gentle slope of the dune is formed on the windward side. As the wind blows over the surface the current is turned upward, and as it passes over the crest an eddy is left on the leeward side and the grains roll over the crest and drop downward. Objects in the path of the dune influence the outline of the dune as shown in the page of diagrams. The transporting power of the wind varies as the sixth power of the velocity, i. e., if the velocity be doubled the carrying power is sixty-four times as great. Consequently any increase in velocity rapidly increases the carrying and erosive power.

The grains of sand freshly brought up from the lake from the erosion of the shores are angular pieces of quartz, but soon become rounded by abrasion. The sand of the Lake Michigan region is of a light brown color, but when viewed at a distance in the sunlight has a very white appearance.

Vegetation.—The surface of a great part of the dune area is without vegetation. The tops and sides exposed to the winds are in most cases bare, while in the swales between the ridges are shrubs and grasses of distinctly sand soil types. The bare surfaces gleam in the sunlight and give the appearance of great snowdrifts. On cloudy days the top of the ridges, the clouds and the lake in the background present a confused outline. Farther inland the vegetation gets a better hold on the sand and many of the hills are practically covered with black and barren oaks, north-

¹Indiana State Geological Report, 1897, p. 41, Blatchley.

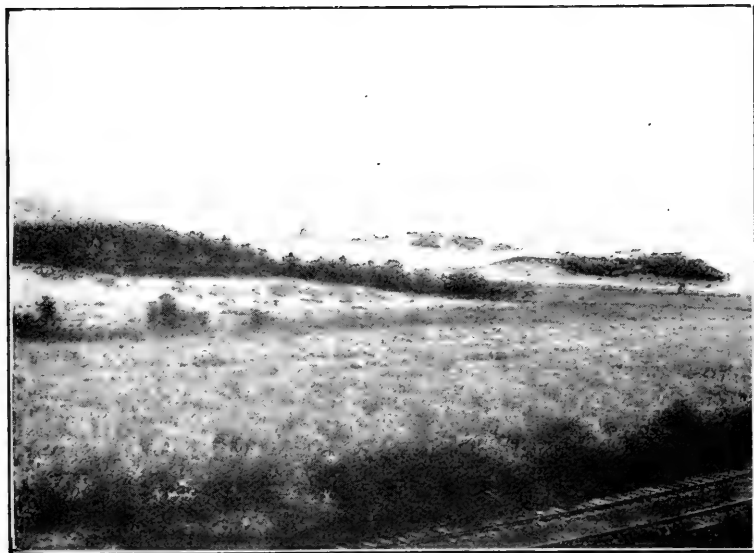

Sand dunes and ridges at Dune Park, Ind. Some vegetation finds a footing on the sides and in the swales.



Buildings of the Sand Brick and Building Block Co., located in the southeast corner of Hoosier Slide. Raw material is close at hand and with natural transportation renewing the supply.

ern scrub pine and white pine, but often after a tree has attained considerable size and apparently firmly rooted, the crust of the surface is broken slightly in some manner, or the grasses and other protecting plants are burned and the wind again gets free action on the bare surface and the sand is moved along and the trees uprooted. On the other hand, the sand often drifts about a tree and wholly or partly covers the tree. If the top of the living tree be found to be projecting from a dune it is a good evidence of a recently constructed dune. In most cases the trees are dead, and after the twigs and limbs become brittle or decayed, they are broken from the main branches or trunk and blown away. The wind then again begins its work, and as new parts of the tree are exposed the process continues and the sand once present has constructed new hills or ridges and the resurrected tree with only the trunk and larger branches stands as a marker of the former location of the sand.

Animal life is rare in the dune region. Vegetation is too scarce to furnish a sufficient supply of food. In the area quiet prevails but work is constantly going on, the surface is always being modified.

2. *The Sand-hills and Plains.*—This area in a very general way comprises the tract of sand to the south of the principal dune area extending to the southern limit of the Kankakee marshes, and east to the gravelly moraines. The term "sand-hill" is used to describe ridges and uneven tracts of sand not in motion, either on account of partial consolidation, or because the sands are fixed by a natural growth of vegetation.

In addition to the sand-dune and sand-hill areas, large tracts of sand are common, the surface of which is very even. Such areas occur usually in connection with the dune or hill areas, but are designated as "sand-plains" or "sand-prairies." Such areas also occur along the old flood plains of rivers. Some of the best agricultural lands, and especially for the growing of small fruit, are found in these level sand tracts. The sand usually carries a large percentage of organic matter, and retains moisture sufficiently well to insure good yields except in times of long continued drought. The dry growing season of 1911 was a severe test on such soils. Sand-plains vary in size from the low narrow swales between dunes and ridges to areas many square miles in extent.

In the area under consideration the sand ridges and hills occupy southeastern Starke, the greater part of Pulaski and the central portion of Jasper and Newton Counties; all of which lie southeast of the Kankakee

marsh; also a narrow strip of ridges on the east and south borders of the sand area in Fulton, Cass, White and Jasper Counties; and the ridges from the southern limit of the typical dunes to the flats on the north of the Kankakee. Scattering ridges and "sand-islands" are found scattering over the level portions of the sand area.

The thickness of the sand varies much because of the irregularities of the surface. Over much of the region the sand is very thin except in the ridges. Throughout much of the region wells are obtained without passing below the sand. They are shallow, having depths of ten feet or less on the level tracts and correspondingly deeper on the ridges. It would appear from all available data and estimates made that the sand is on an average about ten feet in thickness over the area. The ridges range in height from five to forty feet, but the majority are less than twenty feet. They vary in breadth from a few feet to an eighth of a mile, but in general are from two hundred to three hundred feet wide. The prevailing trend of the ridges is usually easily determined, but in places they wind about apparently without system. Mr. Leverette, Dr. Chamberlin and Professor Purdue have attempted to work out a system of the ridges and the bouldery tracts associated with the ridges. Further study of the region is contemplated to work out the system.

"Those on the east border in Pulaski County, Indiana, show a tendency to a north to south trend, while those on the south border in Cass, White and Jasper Counties trend nearly east to west. Those on the south border of the Kankakee trend about with the course of the stream, south of west in the Indiana portion, and north of west in the Illinois portion. Between the ridges bordering the Kankakee in Indiana, and those on the south and east borders of the sand area, the trend is not so easily systematized. The ridges there are arranged in groups and strips, among which there are extensive plain tracts, often boulder strewn and having only a thin sand covering."—U. S. G. S. Monograph XXXV!!!, p. 332-33.

The soils of the area vary from peat and muck, with a considerable percentage of sand and high in organic content, to the loose barren sands. Much of the area is low lying and marshy, thousands of acres of which have not been reclaimed for agricultural purposes. In the undulating and rolling parts the soil is chiefly a fine sandy loam, with good natural drainage. All the ordinary crops are grown to some extent and many special crops are of great importance in the region. While much of this land has



Showing stratification lines in sand dune at Michigan City.



Markings caused by slumpings in sand dunes, Michigan City.

been considered worthless, present indications are that all will be reclaimed and made to yield good returns. The nearness to Chicago makes the region of special value for truck farming and the growing of small fruit.

3. *Sand Plains of the Wabash Valley.*—All along the course of the Wabash from its source to its mouth are found deposits of gravel and sand which are of great importance. From Parke County to the mouth of the river are extensive level stretches of sand occupying the area between the lower bottoms of the river and main tributaries and the higher uplands to the east. These sand tracts have the widest development and the most even topography through Vigo, Sullivan and Knox Counties; in the greater part of the widest expanse being from two to five miles in width and with a very even surface. This part of the area consists of a sandy loam with a high percentage of organic matter, giving the soil a very dark color and rendering it of high agricultural value. It is devoted chiefly to the growing of corn. In the region about Carlisle in Sullivan County the sand is built up into hills and ridges rising in some places to considerable height. This region is devoted chiefly to the growing of cowpeas. They make a very rank growth of a good quality. A very similar type of topography is found in the region about Emison in Knox County and in the part of the county to the south of Merom and extending southward past Decker into the region about Owensville in Gibson County. Melons are grown on all these sandy soils, but the great melon producing part of the State is in the vicinity of Decker and Owensville. The growing of melons has increased the price of the sand land in the past ten years from about \$20 an acre to \$100 or more.

From the neighborhood of Decker southward the sand is of a coarser quality than that farther to the north. In the coarser sands the soils are so porous and so well drained that they are poorly adapted to the general farm crops. Much of the sand strip from Hazelton to New Harmony has in many places a typical dune topography, but in general it has been somewhat modified by the reworking of the surface and by the effects of the natural growth of vegetation. Low swales are also present which are difficult or impossible to drain. These dune deposits are due either to recent agencies or represent a transitional stage between the deposits from the flood waters of the Wisconsin stage and the recent stages. The material of the dunes is a coarse quartz sand which in some places shows

some degree of stratification. The sand varies in thickness from a thin coating to 100 feet or more.

To the south of New Harmony the same type occurs, but in many places it appears a true sandy loam. In addition to the areas of sand mentioned above, many areas of small extent and varying quality occur in the lower bottoms along the river.

4. *The Deposits Along the Ohio River.*—Great bars and deposits of sand occur in the bends of the Ohio River all along its course, but no valley deposits of importance occur until below Rockport. From this point to the junction of the Ohio and the Wabash there is a continuous deposit of sand except where broken by the bluffs coming down to the river, as at Rockport. The most characteristic occurrence of the sand is in a narrow, persistent ridge lying only a short distance back from the river. The slope on the river side is rather abrupt while inland the slope is long and gentle. This ridge seems to have been formed before the river cut its channel down to the present level. During times of overflow the coarser materials were deposited near the channel and the finer grades carried farther inland, thus forming a natural levee along the river.

5. *The Deposits Along White River and Its Tributaries.*—Both forks of White River have considerable deposits of sand and gravel along their courses and have contributed much to road material, building sand, etc. Along the east fork large quantities of sand occur in the bed of the river at Brownstown, and south of Bedford old stream deposits furnish much sand for ballast and other purposes. Here on the south side of the river the sand is built up into dune-like hillocks. At West Shoals considerable sand occurs in the present valley, and also on the top of the bluff is a deposit made by the stream in its early history. Again to the west at Portersville river sand occurs on the bluff. From this point to Petersburg the sand continues in an irregular line, and from there to Hazleton the area widens and becomes a part of the line of the Wabash deposits. Through Greene and Daviess Counties considerable sand occurs along the west fork, but in most places where it occurs it becomes a sandy loam. To the northwest of Bloomfield some magnetite is found in the sand, and similar deposits of less extent occur at other points to the north along the main stream and its tributaries.

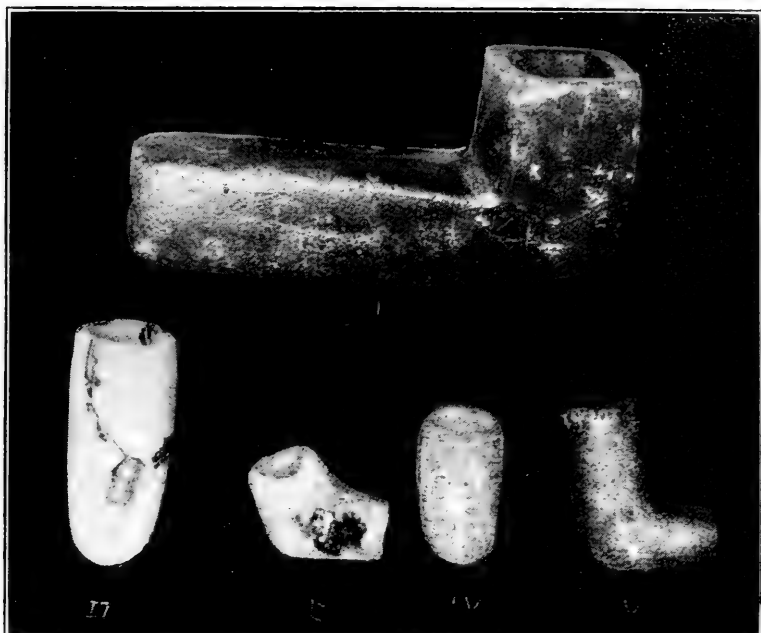

ANCIENT PIPES.

ANDREW J. BIGNEY.

The customs of ancient peoples are always interesting and instructive. Several pipes of rare occurrence have come into the possession of the museum of Moores Hill College. Some brief notes are here presented.

No. I is a very large pipe measuring nine inches long and the bowl end four inches, and $2\frac{1}{2}$ inches in width. It is made of soapstone. Its place of occurrence is not known.

No. II is a pipe of the mound builders. The place where it was found is not known.

No. III is an unfinished mound builder's pipe. This is particularly interesting because it is unfinished.

No. IV is a very old pipe showing the rude drawings on it of some prehistoric people.

No. V is probably a more recent pipe. It no doubt was used by the early Indians.

POLARIZATION OF CADMIUM CELLS.

BY R. R. RAMSAY.

This work is a continuation of some work reported at a previous meeting (Ind. Acad. Proc. 1909), in which it was shown that if a cadmium cell was polarized it would regain its normal E. M. F., if the cell contained mercurous sulphate, but would remain polarized if the mercurous sulphate was absent. In that paper it was stated that when the mercury from the polarized cell was sparked, a spectroscope showed the cadmium lines. Since then I have been able to obtain a photographic record of the fact, which I present at this time. The photographs were made with a large Hilger quartz spectrograph using Cramer spectrum plates, which are sensitive for the entire visible spectrum and far up into the ultra violet.

The cadmium amalgam from the mercury terminal of the polarized cell was placed in a small arc lamp made as follows: The lower terminal was made of the amalgam in a quartz tube which had a heavy copper wire leading into the bottom. Fireclay was used to make the tube mercury tight around the wire. The upper terminal of the arc was a heavy copper wire. After filling the cup with the amalgam the terminals were drawn apart and an arc could be maintained for about 10 seconds, after which it was necessary to fill the cup again with the amalgam. The current strength was about three amperes. The arc was focused upon the slit of the spectrograph by means of a quartz lens. The spectrum of the amalgam is shown, together with the spectrum of mercury taken with the same arc lamp, the spectrum of cadmium arc between C. P. cadmium rods and also the spectrum of an arc between copper terminals. Referring to the plate beginning at the top: We have 1st, mercury arc of short exposure, the brighter lines showing on the plate; 2d, the cadmium amalgam arc made with three different lengths of slit, thus bringing out the fainter lines and avoiding to some extent the blurring due to the brighter lines; 3d, the spectrum of the cadmium arc, showing four lines in the visible spectrum, which can be identified in the cadmium amalgam spectrum, together with a large number in the ultra violet; 4th, the spectrum of the copper arc. The wave lengths of several of the more prominent lines are marked. This will serve to give one an idea of the accuracy of the scale as well as to identify the copper lines; 5th, the mercury arc of long exposure; 6th, the cadmium amalgam arc, and, 7th, the cadmium arc.

Hg.

Cd. amal.

Cd.

Cu.

Hg.

Cd. amal.

Cd.

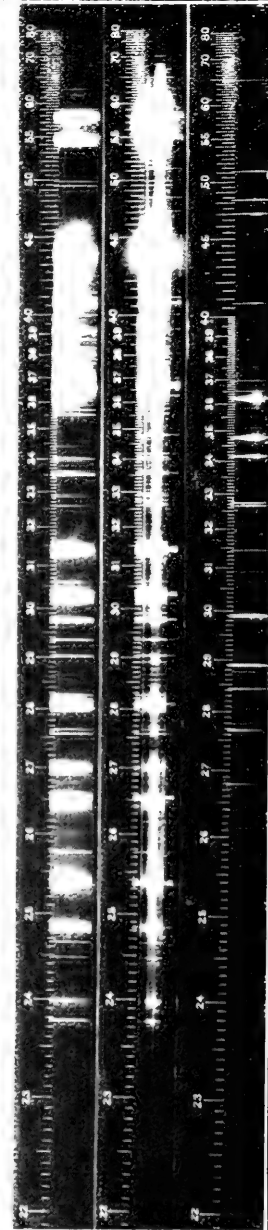
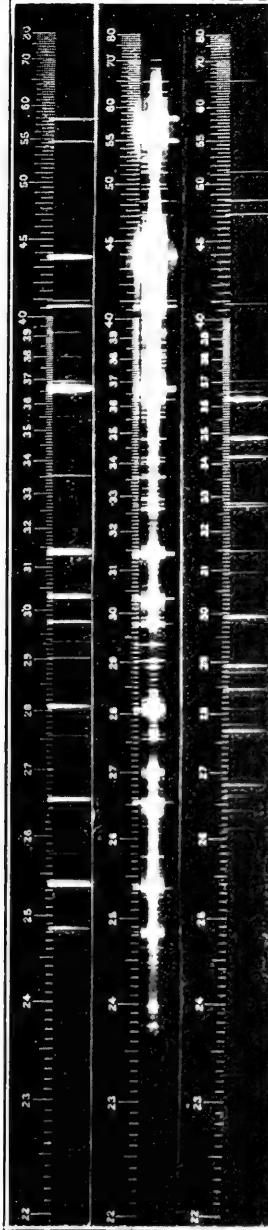

THE EFFECT OF PRESSURE ON A CADMIUM CELL.

BY R. R. RAMSEY.

This work is an extension of some work done in 1901 (*Phys. Rev.*, Vol. 13, July, 1901), in which the pressure was raised to 300 atmospheres. In 1909 there appeared the work of Cohen and Swinge (*Zeit. Phys. Chem.* 67, 5 pp. 513, Sept., 1909), in which the cell was placed under a pressure



Fig. I.

of 750 atmospheres. Within the past year the Department of Physics has secured a compression pump extending to 1,000 kilograms per square centimeter (1 atmosphere=1,033 kilogram per square centimeter) and inasmuch as Cohen and Swinge's results were not in exact accord with my former results I thought it well to repeat and extend the work.

The apparatus and plan of the experiment was practically the same as in my former work. The pump was a Ducretet compression pump fitted with a gauge recording pressure up to 1,000 kilograms per square centimeter. The cell is made in the *H* form with very short connecting tube (Fig. I), so that it will go inside the piezometer (Fig. II), whose inside

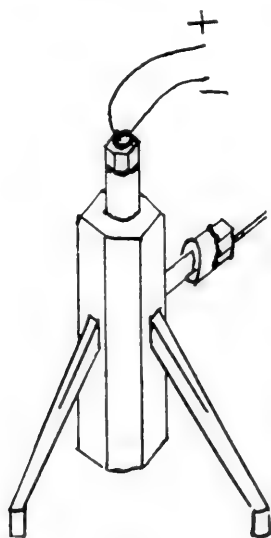

Fig. I.

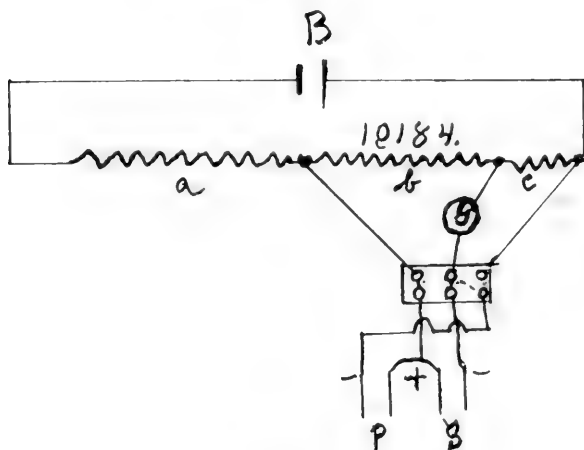

Fig. III.

diameter is three centimeters. The top of the cell is drawn to a capillary after the electrodes and cadmium sulphate crystals are placed inside. The cell is then immersed in kerosene inside the piezometer. A special cap was made for the piezometer. This cap has two insulated connections leading through it so that the cell can be connected to a potentiometer. The piezometer is connected to the pump with a copper tube of small inside diameter. The potentiometer (Fig. III), is so arranged that the cell can be compared with a standard Weston cell and also so that the difference between the cell under pressure and a second cell can be measured. This second cell is immersed in a quantity of kerosene and placed as close as possible to the piezometer. In this way any fluctuations due to change of room temperature will be avoided.

The results are given in Table I.

TABLE I.

Pressure in Kilograms per Square Centimeter.	Change of E. M. F. in Volts.	Average $\frac{de}{dp}$
100	$7. \times 10^{-4}$ Volts.	$7. \times 10^{-6}$
200	13.3	6.65
300	19.3	6.23
400	26	6.5
500	32.4	6.28
600	38.7	6.45
700	44.6	6.37
800	50.7	6.33
900
1000	64.7	6.47
		Mean, 6.47

The results are also shown in a curve (Fig. IV). The average value of $\frac{de}{dp}$ is 6.47×10^{-6} volts per kilogram per square centimeter.

In the previous work a cell was made of heavy glass tubing and subjected to pressure up to 75 atmospheres, at which pressure the cell burst. The result for this method was 6.02×10^{-5} volts per atmosphere.

The result for the piezometer method obtained at that time was 7.6×10^{-6} volts per atmosphere. Cohen and Swinge have found the value 6.28×10^{-6} volts per atmosphere for a pressure up to 750 atmospheres. The E. M. F.

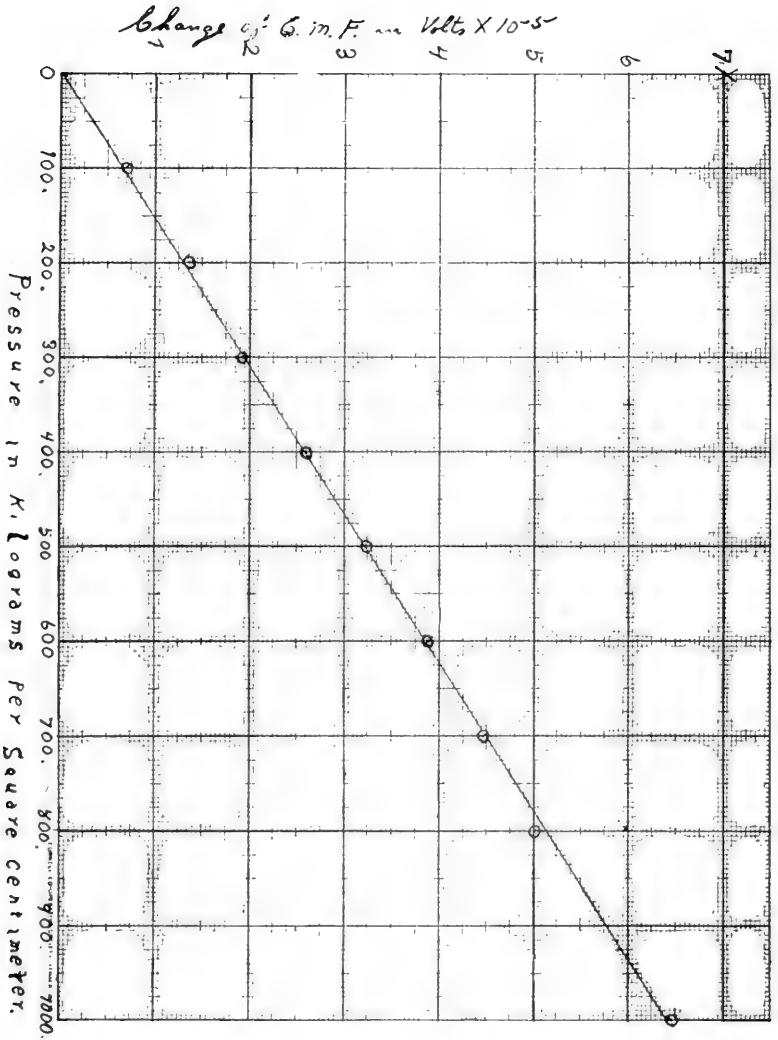

Fig. IV.

when first placed under pressure is increased more than the value given above. The pressure caused an increase of the temperature of the oil and a decrease of the temperature of the electrolyte in the neighborhood of the crystals. This has been shown by means of a thermo-junction. The exact results will be reserved for further investigation.

Both these temperature changes affect the E. M. F. of the cell. After a time, a half hour say, the cell reaches a constant E. M. F. When the cell was first placed under a pressure of 1,000 the E. M. F. was changed 78×10^{-4} volts. The final change after thirty minutes was $6.4^7 \times 10^{-4}$ volts.

Indiana University, February 2, 1912

NOTES ON THE CALIBRATION AND USE OF THE BALLISTIC
GALVANOMETER.

BY C. M. SMITH.

The ballistic galvanometer is an important adjunct to an electrical laboratory, inasmuch as it integrates the transient and varying currents in the case of circuits which contain inductance or capacity or both. If the time constant of the circuit is small compared with the quarter period of the suspended system of the galvanometer, the first throw is proportional to the total charge which passes, or $Q = \int idt = G\phi$. Where Q is the charge, ϕ is the observed first throw, and G is a constant expressed in terms of coulombs or micro-coulombs per scale division. To interpret any reading the galvanometer must be calibrated by passing through it a known charge and observing the resulting first throw, the quotient giving the value of G .

This first throw is reduced somewhat by the so-called "damping," by which is meant the effect of all those resisting forces which tend to absorb the energy of a vibrating system, of any sort whatever. These forces are generally assumed to be proportional to the velocity of the moving parts, although there is no reason *a priori* why they should not depend upon other functions of the velocity, as indeed they appear to do in some cases. However, long experience has shown that the simple proportion above stated is a satisfactory generalization for slowly moving bodies, and one which introduced into the general equations of motion leads to results quite in accordance with experimental observations, for a large class of physical problems.

The earlier forms of ballistic galvanometer, now seldom seen in actual service, were designed with small, highly polished needles of the Siemens pattern, bell-shaped and slotted, and usually arranged much like the Kelvin galvanometers of the same period, astatic, and highly sensitive. An essential feature, as pointed out in the older text-books, was that the damping should be a minimum, in this type of galvanometer being due to fiber viscosity, air friction and the electro-magnetic reactions of induced currents.

this latter effect however being very small. Such damping as did occur was corrected for by the use of that convenient fiction, the throw which would have occurred if there had been no damping, which is given by

$$\phi_0 = \phi \left(1 + \frac{\lambda}{2} \right)$$

where ϕ is the observed throw and λ is the logarithmic decrement of Gauss, which is the natural logarithm of the ratio of successive amplitudes.

This method was known to lack precision, and indeed became unusable when the logarithmic decrement reached a value of 0.4 or 0.5. A common laboratory experiment¹ of this period was one designed to determine the resistance of a galvanometer or of an unknown coil in terms of the logarithmic decrements taken successively on open circuit, circuit closed through the galvanometer only, and circuit closed including the resistance to be measured. Satisfactory results were possible only with a needle of large magnetic leakage, and with special adjustments of the coils.

With the introduction of the suspended coil type of galvanometer and its rapid displacement of earlier types, it claimed attention also as a valuable and accurate ballistic instrument. However the normal damping is much greater in this case, first because of the increased air friction as compared with that acting on the small polished bell-shaped steel needles, and second because of the very greatly increased electro-magnetic reactions due to induced currents circulating within the coil itself.

In passing from the older to the newer type there are certain considerations which require careful attention, inasmuch as the methods applicable to the older type will usually lead to incorrect results if applied to the suspended coil type. Particularly is this true in calibrating the galvanometer. With the older type concordant results were obtained either with a standard cell and condenser, or with a mutual inductance, the logarithmic decrement being calculated in either case, and the appropriate corrections being applied. But with the suspended coil galvanometer, where the electromagnetic damping is large frequently indeed causing the motion to lose its oscillatory character entirely and become aperiodic, it is impracticable to calculate or use the logarithmic decrement in the regular way. It is then clear that the damping, and hence the discordance between the observed and fictitious throws will not only be large, but will be a function of the resistance in the external circuit, which function is not easy to determine.

¹ Kohlrausch, Lehrbuch der Prak, Physik. 9th ed., p. 399.

Regarding this matter of calibration, existing hand books, laboratory text books, and maker's catalogs are not clear, and the reader, whether he be a student, an inexperienced instructor, or a practical man can be, and to to the writer's knowledge often is, misled. In discussing the use of the ballistic galvanometer in iron testing for example, the statement in various sources which should be authoritative is not infrequently seen, that the galvanometer may be calibrated with a standard cell and condenser, and students have been known to follow these directions, without counsel from the instructor, although the condenser was introducing perhaps 4,000 megohms in series with the galvanometer, while the resistance of the secondary circuit otherwise used was less than 100 ohms. This procedure may give rise to errors of several hundred per cent. with corresponding influence on the values for the B-H curve.

Recognizing that this problem is satisfactorily treated in much of the existing literature, it must also be admitted that many of the current helps, to which one first turns for reference, are quite inadequate and misleading, and it is the purpose of this article to offer a wider discussion of the facts. A single example with calibration curves of a Leeds and Northrup type H galvanometer will serve to illustrate the principle. In figure 1, curve D gives the relation of charge to deflection for the case of calibration with a standard condenser. For the same galvanometer, A, B and C are the corresponding calibration curves when the total circuit resistances are respectively 486, 886, and 1,486 ohms. These curves show clearly the influence of diminishing total circuit resistance upon the value of the galvanometer constant. Curve D shows 8.2 scale divisions for 1 micro-coulomb, while curve A, for a circuit resistance of 486 ohms, shows 1.4 scale divisions for the same charge.

Curves A, B, C, and D were taken with the small rectangular damping coil removed. A similar set of curves, A₁, B₁, C₁, and D₁ give the calibration values after the damping coil has been removed.

Various suggestions have been made for calculating the true value of the ballistic constant for any given condition from the known constants of the galvanometer such as period, moment of inertia, moment of torsion, strength of field, etc. These methods, entirely adequate theoretically, are nevertheless difficult to apply practically, because the values of the constants are seldom known with sufficient precision, and are themselves liable to change when the galvanometer is readjusted.

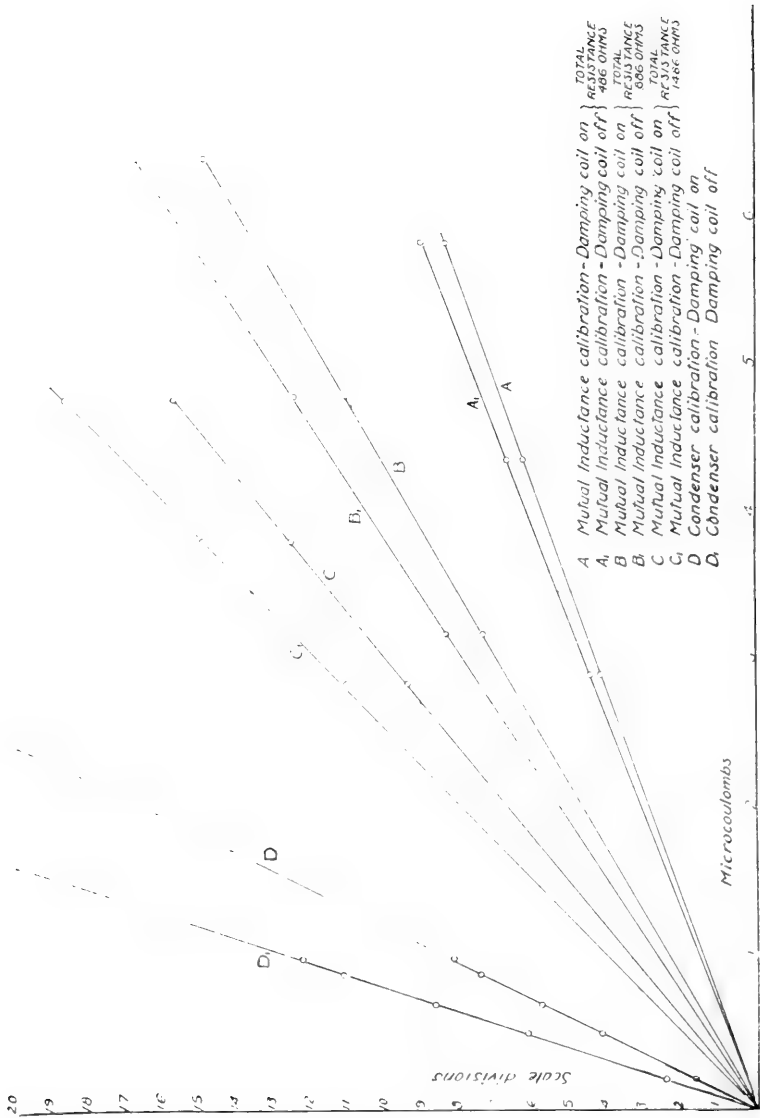

To eliminate the effect of damping due to eddy currents two suggestions have been made. (1) to insert in the galvanometer circuit a special key so arranged as to break the galvanometer circuit a brief instant after the charge has passed, thus securing always the open circuit conditions of curve D; (2) to insert a special key in the galvanometer circuit so arranged that the galvanometer will always be closed through a circuit of constant resistance. Both of these methods are satisfactory, but only with perfectly operating keys, which condition is not easy to secure.

By far the safest and most convenient procedure is then to *calibrate the galvanometer for the precise conditions under which it is to be used*. This may readily be carried out by permanently including in the galvanometer circuit the secondary coil of a standard mutual inductance, and by simply reversing a known current in the primary circuit the constant can be accurately determined from the resulting throw.

For a standard of mutual inductance it has long been customary to rely on the long solenoid with a short coaxial solenoid for a secondary coil. Unless these are well made, with exceptional care and by experienced hands, they are by no means standard. The writer has measured the mutual inductance of a large number of such coils from different makers, and the subjoined table will show the discordances between measured and calculated values for a few of them.

SOLENOID.	Calculated.	Measured.	Per Cent. Variation.
1.....	2.411	2.428	0.7%
2.....	1.779	1.878	5.5
3.....	1.010	1.053	4.0
4.....	0.609	0.581	4.7
5.....	1.027	1.068	3.8
6.....	0.539	0.544	0.8
7.....	2.1526	2.1560	0.17
8.....	1.0436	1.0560	1.2
9.....	1.056	1.073	1.6

The calculated values were all secured from the approximate formula based on $4\pi ni$ as the value of the field at the center of a solenoid, while the measured values were obtained by Maxwell's method, by comparison

with a marble spool standard for which the Bureau of Standards had furnished values. These coils represent several makers, and one, No. 7, was made by the writer. It is known to be the practice of some makers to wind the coils with only approximate measurements and data, then to standardize them against a known value and subsequently to adjust certain factors in the data so that the calculated and measured values agree.

It has long the writer's belief that, except as a brief laboratory exercise, to show the student how a standard mutual inductance may be realized, the coaxial solenoids should be replaced by calibrated standards, wound preferably on white marble spools thoroughly varnished and baked hard. These when calibrated at the Bureau of Standards or elsewhere are very permanent, convenient and reliable.

*Purdue University,
Lafayette, Ind.*

QUALITATIVE DETECTION AND SEPARATION OF POTASSIUM AND SODIUM.

F. C. MATHERS AND I. E. LEE.

The qualitative detection and separation of potassium and sodium is less satisfactory than tests for any other group. Some manuals have abandoned wet methods and use spectrum tests. This is objectionable on account of the great difficulty in testing for potassium in the presence of an excess of sodium and also because the test is so delicate that sodium is detected in almost every chemical substance.

The test for sodium with potassium pyroantimonate has been unsatisfactory in this laboratory. There are numerous excellent and satisfactory tests for potassium.

A new method which has been tried in this laboratory and which has been found satisfactory is as follows: Separate the hydrogen sulphide and ammonium sulphide groups by the ordinary methods. Then precipitate barium, strontium, and calcium with ammonium carbonate. This leaves, in the solution, magnesium, potassium, sodium, and ammonium salts and perhaps traces of barium, strontium, and calcium, which are sometimes incompletely precipitated by ammonium carbonate.

Introduce this solution into a small evaporating dish and evaporate to dryness. Heat (in the hood) over the free gas flame until the ammonium compounds are completely volatilized, i. e., until white fumes are no longer given off.

Allow the dish to cool, dissolve the residue in about one-fourth of a test tube full of distilled water (5-7 cc.) and *add 2 to 3 cc. of alcohol (not more than an equal volume of alcohol should be added)* and then add a few drops of sulphuric acid¹ and filter (I) through a small paper but do not wash. Discard the residue.

Transfer about one cubic centimeter of filtrate I to a test tube and add one drop of sodium cobaltic nitrate, $\text{Na}_3\text{Co}(\text{NO}_2)_6$.

A. No precipitate is formed. Proceed as in B, 2, for the detection of sodium.

¹ The sulphuric acid will remove any barium, strontium, or calcium which was not precipitated by the ammonium carbonate.

B. A yellow precipitate proves the presence of potassium in the solution (ammonium compounds must be absent).

1. To the remainder of filtrate I add an excess of perchloric acid². A white crystalline precipitate of potassium perchlorate is formed. Filter (II) and test a few drops of filtrate II with the sodium cobaltic nitrite. If a precipitate is formed, add to the filtrate II more perchloric acid, filter again and test as above. When the sodium cobaltic nitrite shows that all potassium has been removed by the perchloric acid, proceed as directed in B, 2, for the detection of sodium.

2. To the filtrate from B, 1, add a few drops of hydrofluosilicic acid, H^2SiF^6 . A cloudy flocculent precipitate indicates the presence of sodium in the solution. This precipitate is not very voluminous and must be looked for carefully if only a little sodium is present. Turn the test tube and examine the sides for adhering precipitate.

This method has been tried in this laboratory with excellent results. Some of the advantages are:

1. Magnesium does not interfere and need not be removed. Magnesium perchlorate is very soluble. Magnesium fluosilicate is soluble and only precipitated, even in the alcohol solution, when large amounts are present.

2. The test for sodium is delicate but traces of sodium which are present in so many reagents are not detected. This is an advantage over the spectrum test where all substances show sodium.

3. The tests are simple and easily understood and followed by the students.

4. The tests are decisive and the student has confidence in his work.

5. Only a short time is required to make a test.

²The perchloric acid must be free from sodium but the presence of potassium does no harm because potassium is detected previously, by the use of sodium cobaltic nitrite, and any potassium present is precipitated by the alcoholic perchloric acid solution.

AN APPARATUS FOR THE STUDY OF THE RADIATION FROM COVERED AND UNCOVERED STEAM PIPES.

BY O. W. SILVEY AND G. E. GRANTHAM.

“The measurement of the efficiency of materials in preventing loss of heat from bodies involves the determination of the constant K in the expression :

$$K = \frac{DH}{A(t_2 - t_1)}$$

Where D = thickness of the specimen.

H = Amount of heat per sec. flowing through A .

A = Area of specimen.

t_1 = Temperature of cooler side of specimen.

t_2 = Temperature of hotter side of specimen.

“The determination of H , t_1 , and t_2 are attended with considerable difficulty if accurate work is attempted, and for much engineering work the relative efficiency of two coverings for heated surfaces is all that is required. For the testing of the relative efficiency of two such substances as are commonly used for covering steam pipes, or for determining the relation between the heat loss from a covered pipe and that from an uncovered pipe, the following method has been found suitable :

“The apparatus consists of two short pieces of steam pipe which may be heated electrically from within by means of a current bearing coil of wire immersed in oil. If sufficient electrical energy be supplied, the pipe becomes gradually heated to some temperature at which the amount of heat energy lost to the surroundings is just equal to the electrical energy supplied to the heating coil. By measuring the electrical energy with an ammeter and voltmeter we may find at once the amount of heat lost from the pipe by radiation, convection, and conduction. At some temperature the heat loss would be such as to require some other rate of energy supply to keep the temperature of the pipe constant, and the electrical supply would, therefore, have to be varied. Again, if the bare pipe be heated to some convenient reference temperature (200°C is usually selected for testing steam pipe covers) and the current adjusted

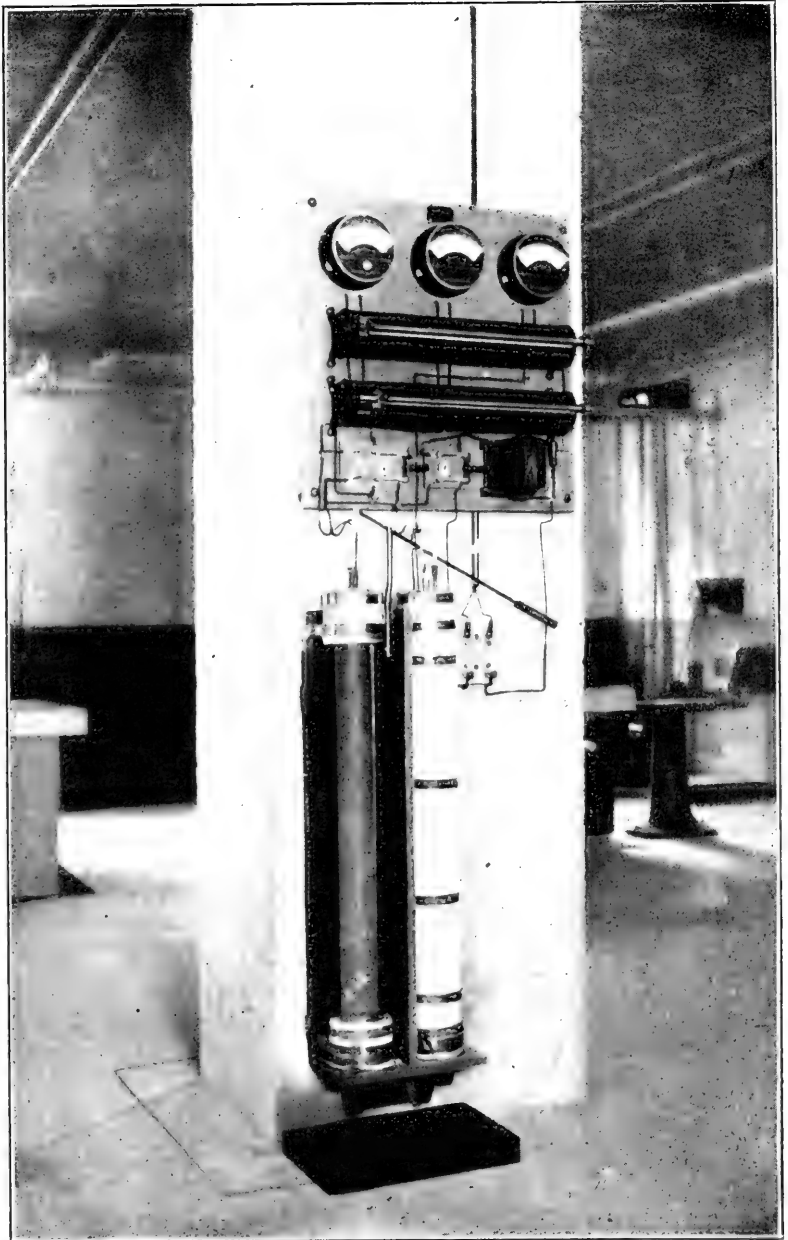

Fig. 1.

until a condition of temperature equilibrium is obtained—that is, the electrical input just compensates for the thermal output—and a second, and exactly similar pipe, be covered with a ‘non-conducting’ cover and heated in the same manner, it will be found that much less electrical energy is needed to keep the covered pipe hot than is required by the bare pipe. The difference represents the saving due to the use of the covering.”—Laboratory Notes, Massachusetts Institute of Technology.

In accordance with the above plan, we are now using for a laboratory exercise for engineering students the apparatus shown in Fig. 1. Two pieces of ordinary three-inch gas pipe of equal length (40 inches), are closed by means of caps at both ends. They are mounted on an oaken support, and separated by a $\frac{7}{8}$ -inch oak board, which prevents one pipe receiving heat from the other. Three short pipes are fitted into holes in the upper cap extending through about an inch; one (B, Fig. 2), of $\frac{5}{8}$ -inch pipe, five inches long in the center, another (A), of $\frac{1}{2}$ -inch pipe, five inches long, for the support of a thermometer, and a third (C), of $\frac{3}{8}$ -inch pipe, nine inches long on the opposite side of the center from the second, for the lead wires of the heating coil.

The heating coils (G), made of No. 16 advance wire, are wound on a paper-insulated brass tube, which extends along the axis of the pipe. Each turn of the coil is separated from the neighboring coil by a hemp cord. The tube is held in position at the top by telescoping over the lower end of the pipe which pierces the middle of the cap. At the lower end it is held in position by a wooden frame (E), clamped rigidly around it by means of screws. This frame also holds firmly the lower end of the heating coil and the lower part of the paper insulation. A similar clamp holds the upper end of the coil and insulation.

The two pipes are covered alike at the ends by means of magnesia covering one inch thick (D and F), leaving 36 inches of each one bare. Brass collars having a flange extending out flush with the circumference of the covering are clamped to the pipes and prevent the end covering from slipping along the pipes. When a test is to be made, a piece of pipe covering of regulation length (36 in.) and suitable size, is placed on one of the pipes, thus completely covering it, while the other one has an equal length left bare.

The tube (Fig. 3), upon which the heating coil is wound, acts also as the cylinder for a pump, by means of which the oil is stirred. It is $\frac{7}{8}$ inch

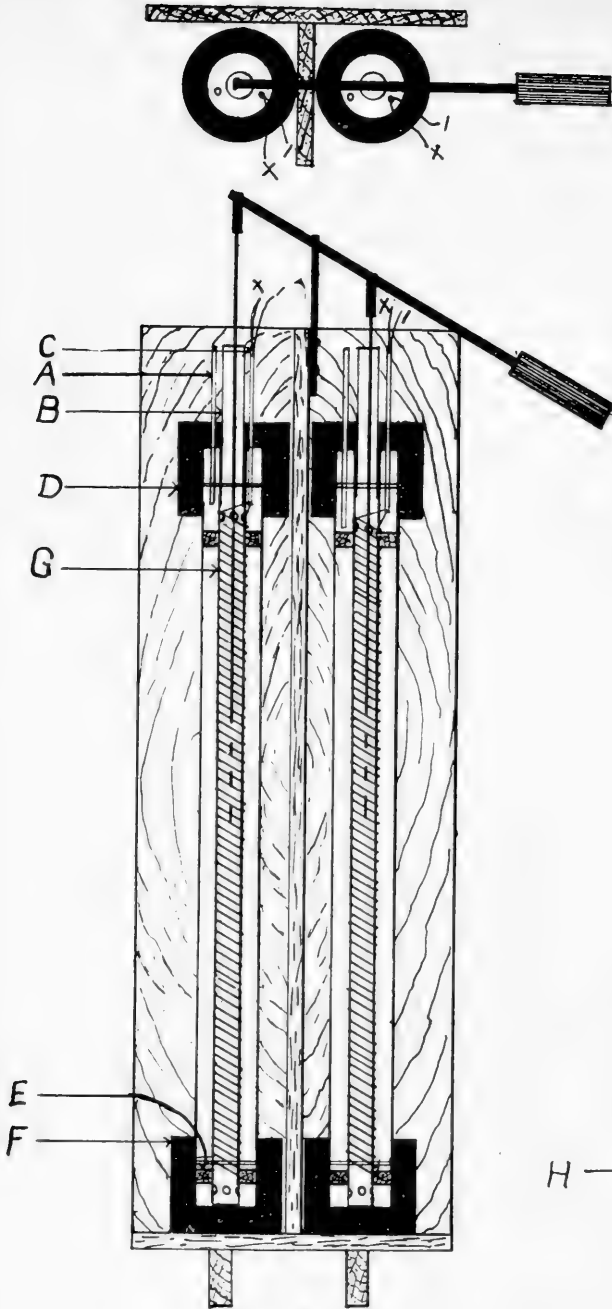

Fig. 2



H

Fig. 3

in diameter and has near the bottom a hollow wooden cylinder (II), upon which rests a small marble, which acts as a valve. The piston of the pump is made of a smaller tube, which is just large enough to slip easily inside the $\frac{7}{8}$ -inch tube. The valve in it is of the same type as the one at the bottom of the tube. The piston rods extend through the central hole at the top of the heating pipe, and are attached to a lever which is pivoted to a support fastened to the oaken partition.

Above the pipes is mounted a switchboard (Fig. 1), containing the necessary measuring instruments. The ammeter on the right side of the switchboard measures the current used in heating the covered pipe, and the one in the upper central part of the board measures the current used in heating the uncovered pipe. The two coils are in multiple circuit, and when switch C is closed current passes through both coils, the amount in each coil being regulated by the two rheostats. The upper rheostat controls the current in the covered pipe, and the lower one controls the current in the uncovered pipe. When the switch on the left side of the board is thrown, closing circuit A, the voltmeter is connected to the terminals of the coil in the unjacketed pipe, and when thrown, closing circuit B, it is connected to the terminals of the jacketed pipe. Switch B is in multiple circuit with an impedance coil, and may be used when a large circuit is needed in the heating coils.

Each of the heating coils has a resistance of about 6.5 ohms, the impedance coil a resistance of about 9.3 ohms, and each rheostat has a resistance of 7.5 ohms when all is used. At the outset of a measurement the resistance of the rheostats is thrown in, switch D is closed, then the sides of the rheostats moved until the current in the covered pipe is 8 amperes. The oil in the pipes is stirred by means of the pumps. When the temperature of about 100° C. is reached switch D is opened, and while the oil is vigorously stirred the current is regulated until the temperature of both pipes is kept at the same constant value. After the two pipes have kept at the same constant temperature for about ten minutes, the temperature of each oil bath, the voltage at the terminals of each coil, and the current in each coil, is read.

A record of the test is as follows:

Outside diameter of pipes, 3.5 in.

Length exposed, 36.0 in.

Temperature of surroundings, 23.1° C.

UNCOVERED PIPE.			COVERED PIPE.		
Volts.	Amperes.	Temperature, Degrees C.	Volts.	Amperes.	Temperature, Degrees C.
38.5	5.5	98.8	24.0	4.1	98.9
38.5	5.5	99.0	23.5	4.1	98.6
38.5	5.4	98.7	24.0	4.2	98.9
39.0	5.5	98.8	23.0	4.2	98.9
39.0	5.5	98.8	24.0	4.1	99.0
39.0	5.5	99.0	24.0	4.2	99.0
39.0	5.5	99.0	23.5	4.1	99.0
38.0	5.5	98.8	23.0	4.1	99.0
38.5	5.5	98.9	24.0	4.1	99.0
38.3	5.4	98.9	24.0	4.1	99.0
Mean, 38.63	5.48	98.88	23.70	4.13	98.93

Average energy consumed by uncovered pipe, 211.69 watts.

Average energy consumed by covered pipe, 97.88 watts.

$(211.69 - 97.88) \div 211.69 = 53\%$ the efficiency of the pipe covering.

211.69 watts = 0.283 horse-power

97.88 watts = 0.131 horse-power.

Difference = 113.81 watts = 0.152 horse-power.

Area of radiating surface, 395.64 sq. in. = 2.74 sq. ft.

$113.81 \times 10^7 \div 4.2 \times 10^7 = 27.09$ cal. per second loss.

= 0.107 B. T. U. per second loss.

$0.107 \times 3600 \times 24 = 9240$ B. T. U. loss per 24 hours.

$0.107 \times 3600 \times 24 \times 365 = 337 \times 10^4$ B. T. U. loss per year.

$337 \times 10^4 \div 2.74 = 123 \times 10^4$ B. T. U. loss per sq. ft. per year.

"Problem: Compute the saving for the first year for 1,000 feet of three-inch pipe, assuming that the pipes are maintained at the temperature used in the above test, that coal develops 14,000 B. T. U. per pound and costs \$6.00 per ton, and that the loss in the boiler, etc., is 50%. The pipe covers cost 25 cents per square foot, and interest and depreciation are 10%."

Loss on 1,000 square feet of pipe per year 123×10^7 B. T. U.

1 lb. coal gives up on combustion 14,000 B. T. U.

1 ton of coal gives up on combustion 28×10^5 B. T. U.

At 50% efficiency 14×10^5 B. T. U. are used in pipes at a cost of \$6.00.

Cost of covering per 1,000 square feet at 25 cents per square foot, is \$250.00; interest 10% = \$25.00.

Total \$275.00.

$123 \times 10^7 \div 14 \times 10^5 = 87.9$ tons of coal required.

$87.9 \times 6 = \$527.40$ loss per 1,000 feet per year.

$\$527.40 - \$275.00 = \$252.40$ saving for the first year for a pipe covering of 53% efficiency.

*Physical Laboratory of Purdue University,
Lafayette, Ind.*

ASH AND CALORIMETER TESTS OF COAL PURCHASED BY INDIANA UNIVERSITY.

BY FRANK C. MATHERS AND IRA E. LEE.

Coal is purchased by Indiana University under a contract that all coal with ash greater than 15 per cent. shall be rejected. The analyses given in this paper represents the ash tests (and some determinations of British Thermal Units, B. T. U.) of the nut and slack coal which has been delivered by the Summit Mine under this contract.

The sampling was done by an employe of the University in the following manner: The coal from six holes, each about 1.5 feet deep which were dug at uniform intervals into the car of coal, was mixed thoroughly. This large sample weighed 50-75 pounds. After the large lumps had been broken, the sample was quartered until about one pint remained. This sample was then brought to the laboratory.¹ The analyses are upon samples dried at 103 to 110 degrees Centigrade for 0.5 hour. A Parr calorimeter was used in determining the British Thermal Units.

The results are as follows:

	No. of cars analyzed.	Dates between which delivered.	Maximum.	Minimum.	Average.
B. T. U.	148	9/1/09 & 7/16/10	13,470	11,525	12,719
Ash %	276	9/1/09 & 6/20/11	22.6	6.37	11.647

The ash determinations when averaged by months are as follows:

September, 1909, 10.66; October, 10.53; November, 10.97; December, 16.64.

January, 1910, 11.25; February, 12.35; March, 11.39; April, 11.50; May, 11.88; June, 10.26; July, 13.32; October, 11.80; November, 13.15; December, 10.81.

January, 1911, 10.76; February, 10.07; March, 12.37; April, 11.41; May, 11.33.

¹The analysis of the sample obtained by taking portions of coal from each wagon load from a car did not differ materially from the analysis of the sample obtained from the car in the manner described. This showed that the method of sampling was accurate.

There is no relation between time of year and low ash values. This indicates that the variation in ash and heating value is due to variation in the quality of the coal and not to any greater carelessness in mining due to rush periods, since high ash tests do not coincide with winter months.

These determinations are presented on account of their value. They represent actual coal and show exactly¹ the kind of coal that can be delivered to customers. Many of the samples of coal which are furnished by the mine operators for analysis are improperly taken and do not represent the average character of the coal. A small sample taken in a mine will almost always show a better analysis than a sample taken from a car. The official taking the sample leaves out the slate and takes only the coal. The miner puts in the car as much slate as the boss will allow. A black, shiny lump of coal, picked up at random and submitted for analysis will show a higher grade than the dull, lusterless pieces. A United States bulletin advises mine officials to have analyses made of samples taken from cars and warns them that analyses of samples taken from mines will generally show a quality which cannot be reached in car lots. For example, the analyses of coals "from nineteen of the leading mines of the State" (Indiana)² show an average ash of 6.09 per cent. The analysis of coal from the Summit Mine as given in the same report shows 5.42 per cent. ash on the dry basis. No analysis in this laboratory of samples of Indiana coal, which were known to be accurately taken from cars, has shown such a low ash. Of course nut and slack coal is higher in ash and lower in B. T. U. than run-of-mine coal, but the difference between 11.64 and 6.09 in ash is greater than really exists between the two grades of coal.

It is of value to compare this Indiana coal with the coal purchased by the United States under rigid tests and specifications during the year 1908-9. The following table shows the analyses of bituminous coals which were delivered under these specifications. The analyses of the coal purchased by Indiana University are also included in the table.

¹The rejected cars are included in the averages.

²31st Annual Report of Indiana Department of Geology and Natural Resources, page 21 (1906).

State	Ash.	B. T. U. (Average for each State.)
Pennsylvania	7.85	14,321
West Virginia	6.06	14,715
Illinois	13.33	12,437
Alabama	9.50	13,917
Virginia	5.40	14,941
Maryland	7.81	14,480
Average of the six States.....	8.325	14,133.5
Indiana	11.64	12,719

All the coal received by the United States Government from Virginia and West Virginia had percentages of ash 0.03 and 0.69 lower respectively than the average ash from "nineteen of the leading mines of the State (Indiana)."¹ Pennsylvania coal showed 1.70% more ash than the Indiana coal. No one thinks that Indiana coal is as good as comparisons from these analyses indicate. However, if Indiana coal is given the value of 11.64% ash and 12,719 B. T. U., it will occupy a position where it seems to belong. While there are objections to Indiana coal, nevertheless it makes a good showing when compared with the eastern coals, which are actually of a higher grade. A maximum number of heat units for a dollar is what one wishes in a coal and "* * * it is possible to burn coal of low heating value as efficiently as high grade coals."² Indiana coal, as delivered, generally contains more moisture than eastern coal, say 10 per cent. in the place of 3 per cent. There is, say 1 per cent., additional expense for the extra cost of handling the greater amount of ash in the Indiana coal. This gives eastern coal an advantage of, say 8 per cent., over Indiana coals, i. e., if two samples of coal (dried at 103 degrees Centigrade) have equal calorimetric value, the Indiana coal, as delivered (with the water in it) is worth 8 per cent. less than the eastern coal. The B. T. U. values of Indiana coal, after deducting 8 per cent. for the excess of water and ash, were compared with the B. T. U. values of coals from the different States which are represented in the United States Purchase Bull.³

If one ton of Indiana coal is worth \$2.00; then
 One ton of Pennsylvania coal is worth \$2.45;
 One ton of West Virginia coal is worth \$2.52;

¹ Indiana Geological Report, loc. cit.

² U. S. Geol. Survey Bull., No. 325, p. 94. "Four Hundred Steaming Tests."

³ Loc. cit.

- One ton of Illinois coal is worth \$1.95;
- One ton of Alabama coal is worth \$2.38;
- One ton of Virginia coal is worth \$2.55;
- One ton of Maryland coal is worth \$2.48.

This gives a method of figuring the value in dollars and cents of eastern coals compared with Indiana coal. This table is for average values of many grades of eastern coal, but for only one coal from Indiana.

For example, if one ton of this Indiana nut and slack costs \$1.60, the value of one ton of Pennsylvania coal (7.85% ash and 14,321 B. T. U.) is $(160 \times 245) / 200$, or the eastern coal is more economical, if it costs less than 196 cents.

If Virginia coal is \$2.50 per ton, then Indiana coal is more economical if it costs less than $(250 \times 200) / 255$, or 196 cents per ton.

SUMMARY.

The nut and slack coal which has been delivered to Indiana University from the Summit Mine showed an average ash of 11.64% and an average B. T. U. of 12,767.

A comparison of this coal with the coal purchased by the United States during the year 1908-9 shows that the Indiana coal is inferior to the coal from Virginia, West Virginia, Pennsylvania, Maryland, Alabama, but superior to that from Illinois.

A method is given for calculating from the B. T. U. the relative value of Indiana coal compared with eastern coal.

This article is an attempt to show the real worth of Indiana coal and to make clear the errors due to inaccurate sampling. The buyer of coal should know exactly what he purchases. Eastern coal has been incorrectly sampled, the same as Indiana coal. Analyses and method of sampling given in the Government bulletin are without doubt correct. Analyses of Indiana coal from samples incorrectly taken are worthless for use in calculating the comparative values of the coals and should not be given the least weight or consideration by a purchaser of coal.

It is urged that coal samples for analysis be taken from cars by some one who understands sampling.

The figures given in this paper for Indiana coal are not assumed to be average values, since coal from only one mine is represented. The average value of Indiana coal can not be determined without making a series of analyses of proper samples from many Indiana mines.

Indiana University, Bloomington.

RECOVERY OF SILVER FROM SILVER CHLORIDE RESIDUES.

BY FRANK C. MATTERS.

The silver from any silver residue or solution can be easily precipitated as the chloride. Some silver electro-plating experiments in this laboratory gave silver chloride residues which were treated in various ways for the recovery of the metallic silver. One of the schemes was so satisfactory that it is described in this paper.

Metallic zinc and hydrochloric or sulphuric acid will reduce silver chloride to metallic silver. The objection to this method is that it introduces any impurity which is in the zinc into the metallic silver. Also the finely divided precipitate of silver is very difficult to filter and to wash free from the zinc salts.

If silver chloride is boiled in sodium hydroxide solution with glucose or other reducing sugar, it is reduced to metallic silver. The very serious objection to this method is that the finely divided silver is exceedingly difficult to filter and wash free from the sodium chloride.

The method which has given the best results in this work is an electrolytic reduction scheme. The silver chloride was filtered and was washed free from soluble salts. The silver chloride, after drying, was transferred from the filter paper to a porcelain crucible and fused with a Bunsen burner. One end of a platinum wire was dipped into the fused mass just as it began to solidify. This crucible, containing the silver chloride, was suspended by the platinum wire into a dilute sulphuric acid solution. This platinum wire was connected as cathode. A platinum foil served as anode. The electric current should not be strong enough to heat the solution, since this would cause platinum to dissolve from the anode. After several hours of electrolysis, the crucible either drops away from the partially reduced silver chloride or may be removed easily by pushing with a rod. The electrolysis was continued until the large amount of hydrogen evolved from the cathode showed that the silver chloride was largely reduced. The electrolyte was changed, at intervals of several hours, until the odor of chlorine could not be detected in the gases which were given off. The reduced silver, which retained the shape of the cru-

cible, was suspended in distilled water until the sulphuric acid of the electrolyte was washed out. This pure silver was then ready for use again.

The advantages of this method are :

1. No metal or other impurity is introduced during the reduction.
2. The silver which is obtained in a firm condition can be very easily handled. This avoids the very troublesome filtration of finely divided slimy silver, which is obtained by reduction with glucose.

University of Indiana, Bloomington.

A NEW GAS GENERATOR.

BY RAYMOND BELLAMY.

This generator is really so new that it exists only on paper. There is, therefore, still a question as to its efficiency, although it is so simple in its construction that it can hardly fail to perform its work satisfactorily. It is designed for use whenever a gas is to be made by intermingling of a liquid and a solid and will be found to be especially adapted to the generation of hydrogen sulphide for analytical work.

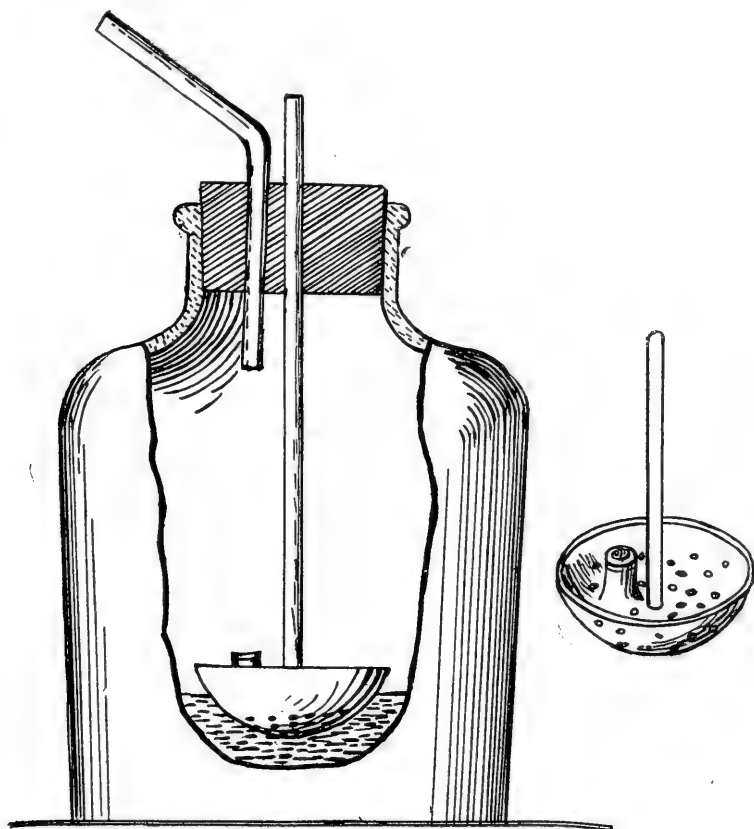

This generator's claim to superiority is based on its simplicity of structure, its inexpensiveness and its ease of operation. All the special apparatus required is a bowl-shaped member, attached to an upright rod, the bowl being perforated. This can be made any size desired, but should be of some material which will resist chemical action, preferably glass. This can be used with a vessel constructed especially for the purpose, or with an ordinary wide-mouthed flask or bottle.

In use, the rod extends through one of the holes in an ordinary rubber stopper. Through the other hole is the tube furnishing an outlet for the gas. The acid or other liquid is put in the bottle or flask receptacle and the solid is placed in the bowl-shaped member. Now when a quantity of gas is desired, by pressing downward on the rod, the bowl with its solids will be lowered into the liquid and the chemical action will begin. When a sufficient amount of the gas has been obtained, by raising the bowl out of the liquid the action will be stopped, as the acid will run out through the perforation in the bowl. This will save the unused chemicals and prevent the escape of the poisonous and obnoxious gas. As a still further safeguard, the bowl can be constructed with a projection on it, this projection having a concave depression; this will be arranged in such a way that when the bowl-shaped member is lifted from the liquid, this depression will fit over the outlet for the gas and completely shut off the escape.

The principle of the generator will be made clear by an examination of the accompanying drawing.

Moore's Hill, Indiana.

SOME ABNORMAL PLANTS.

BY RAYMOND BELLAMY.

While tramping across the country in northern Montana, my attention was caught by a plant of the *Campanula rotundifolia* (L.) species. This was remarkable for its abnormalities. It was in full bloom and the central stem appeared to be formed by the union of three separate stems, while all the flowers on this stem showed the same triple growth in all their parts. Surrounding this stem were a number of others, each of which showed a double arrangement throughout, in the same manner that the central stem had showed a triple one. The specimen was preserved, but lost, along with a number of others, somewhere between there and Indiana.

Another interesting abnormality was noticed this fall while sprouting some white beans for laboratory work. In the bunch were two that had three cotyledons, one being much smaller than the others, but seemingly as strong and full of vitality as they.

Moore's Hill, Indiana.

A MODIFIED METHOD FOR THE DETERMINATION OF LEAD PEROXIDE IN RED LEAD.

BY A. R. NEES AND O. W. BROWN.

Two general methods are used for determining how near commercial red lead corresponds to the formula Pb_3O_4 . One method depends upon dissolving the free litharge from the sample and assuming the residue to be pure Pb_3O_4 . Other methods depend upon the determination of the per cent. of PbO_2 in the material, and calculating from this value the per cent. of Pb_3O_4 in the sample.

Mr. E. E. Dunlap (J. Am. Chem. Soc. 30, p. 611) has proposed a method of determining the free litharge in red lead. He states that by digesting a sample of commercial red lead in a boiling dilute solution of lead acetate, all of the free litharge is dissolved and that the material remaining corresponds to formula Pb_3O_4 . This method is employed in many commercial laboratories. However, the writers have not obtained accordant results when it is used, because the amount of litharge dissolved by the lead acetate solution depends upon the length of time the sample is digested. The analysis of a single sample by this method gave results of 4.71% to 8.8% litharge when Mr. Dunlap's directions were carefully followed, and the time of digestion was varied from ten to thirty minutes.

For accurate results the writers believe that it is necessary to use some of the methods for the determination of PbO_2 . A number of methods have been described in the literature and most of them have been tested in this laboratory.

The method of Lux (Treadwell and Hall's Quantitative Analysis, p. 491) is based upon the fact that oxalic acid is oxidized by PbO_2 in dilute nitric acid solution. Our experience with this method is that it usually gives high results and that they are not concordant. A series of determinations on the same sample gave results varying between 35.1% and 31.54%.

The method of Diehl as modified by Topf (Treadwell and Hall, p. 531) was also tried. This method depends upon the fact that potassium iodide

reduces lead peroxide in an acetic acid solution in the presence of an excess of alkali acetate. The iodine liberated is titrated with N/10 sodium thiosulphate. This method gives concordant results when proper precautions are taken. The best results were obtained when the potassium iodide and sodium acetate were ground in a mortar, dissolved in 50% acetic acid, the sample then added and the solution diluted. It is essential that all of the lead iodide be dissolved. This is the chief objection to this method, since it usually requires considerable time and trouble to bring about the complete solution of the lead iodide.

A method which has given good results is based upon the fact that dilute nitric acid will dissolve the PbO in red lead and leave behind the PbO₂. Careful tests have shown that the concentration of the acid should be at least 1 to 20 and not stronger than 1 to 10. We proceeded as follows:

Digest a weighed quantity of about one gram in about 100 c. c. of warm dilute nitric acid (1 part acid, 10 parts water by volume) for thirty minutes. The sample is then filtered and the residue of lead peroxide washed with dilute (1 to 10) nitric acid, and then dissolved in equal parts of dilute nitric acid and hydrogen peroxide. This solution is evaporated to dryness to remove oxides of nitrogen. The evaporation carried out in a Kjeldahl flask to prevent spattering. This residue of lead nitrate is dissolved in dilute nitric acid and electrolyzed in the usual way. This method gives good results but requires considerable time and very careful manipulation. A series of determinations on one sample gave the following percentage of lead peroxide: 32.04, 31.84, 31.86, 31.79, 31.89.

The most rapid method for the determination of PbO₂ is distillation with hydrochloric acid. The PbO₂ reacts with the HCl to liberate free Cl according to the following reaction:



The chief objection to this method, as described in the various books, is the cumbersome apparatus used. Cork or rubber stoppers on rubber connections of any kind can not be used because of the corrosive action of the strong HCl. After many trials we finally devised a very simple and workable apparatus. It consists essentially of a 100 c. c. distilling flask having a long bent delivery tube and provided with a perfectly fitting ground glass stopper. The complete apparatus is shown in the figure.

The determination is carried out as follows: One gram of the sample is introduced into the distilling flask, together with a few lumps of pure magnesite. The neck of the flask is washed down with 5 to 10 c. c. of distilled water, then 40 to 45 c. c. of concentrated HCl is added and the flask quickly stoppered. The delivery tube of the flask, which is drawn out to point, dips into a 100 c. c. Nessler tube containing a 3 to 4 per cent. solution of potassium iodide. The chlorine given off liberates free iodine which is soluble in the excess of potassium iodide present. The amount

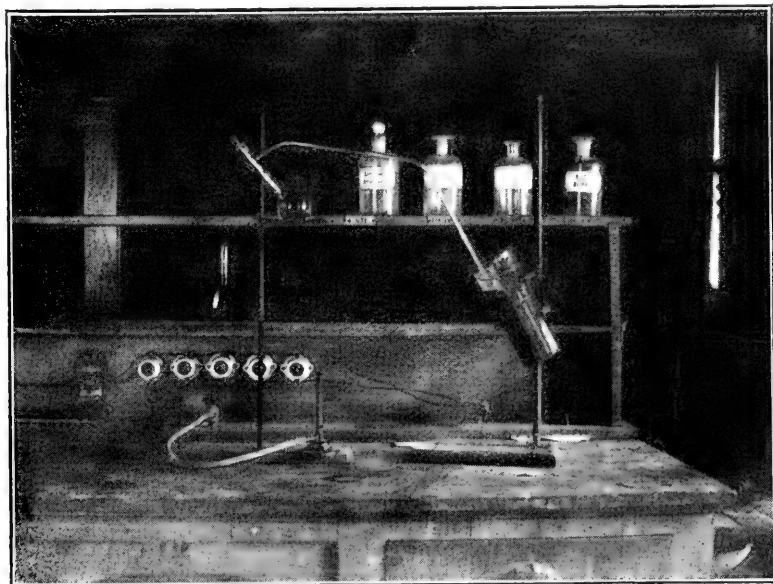

of iodine liberated is determined by titration with N/10 normal sodium thiosulphate solution. One c. c. of N/10 sodium thiosulphate .01195 gm. of PbO_2 .

The flask should be gently heated at the beginning of the reaction and strongly again at the end. During the intervening time, heating is unnecessary and undesirable, since it causes a too rapid evolution of gas. The action of hydrochloric acid on the magnesite causes the evolution of enough carbon dioxide to carry over all the chlorine except the last traces. Twenty to twenty-five minutes should be allowed for the com-

plete reaction to take place. Care must be taken during the last stages of the reaction, since the magnesite is used up and the HCl gas given off being extremely soluble allows the potassium iodide solution to suck back into the flask. This is prevented by heating. Heating at this point not only prevents the sucking back of the KI solution, but is necessary in order to expel the last traces of chlorine from the flask. A second Nessler tube should be inserted and the heating continued a few minutes, in order to make sure that the reaction is complete. During the distillation the Nessler tube is surrounded by a beaker of cold water, in order to keep the temperature of the potassium iodide solution as low as possible so as to prevent the volatilization of the iodine.

This method is both quick and accurate. A series of analyses on one sample gave the following results: 31.84, 31.92, 31.92 per cent. lead peroxide. In all about fifty different samples were run by this method and in every case it was easy to check the results to within 0.10 per cent.

If a distilling flask with a ground glass stopper is not at hand, one can be made in a few minutes. Select a glass stopper of the proper size to fit the neck of the flask and fasten it in an horizontal position to the end of a slowly rotating shaft or axle fit the flask over the rotating stopper and grind with fine emery dust moistened with a mixture of equal parts of ether, turpentine, and alcohol.

*Chemical Laboratory,
Indiana University.*

A SIMPLE LABORATORY METHOD OF MEASURING VAPOR TENSION.

BY A. E. CASWELL.

About a year ago I designed a slight modification of the ordinary barometer tube apparatus for measuring vapor pressure of less than an atmosphere. This has been used in connection with a heat course for engineers with very satisfactory results, the accuracy attainable being about the same as by the usual methods.

The general arrangement of the apparatus is shown in the accompanying figure. A, is a piece of glass tubing about 2 cm. in diameter and 105 cm. long, graduated at suitable intervals. B, is a metal tube of slightly larger cross section than A, and ending in the reservoir C. This is provided with a tripod support. The length from the bottom of the tube to the top of the reservoir may be 15 cm. less than the length of A. The top of the tube A is surrounded by the vessel D, which may consist simply of a metal or glass tube fitted with a rubber stopper E. The vessel D, together with the tube A, to which it is rigidly attached, is raised or lowered by means of a clamp attached either to a rigid support attached to the tube B, or to a common laboratory support. When the tubes A and B are being filled with mercury about 5 cm. of the length of the tube, A is filled with the liquid whose vapor tension is to be measured. The vapor space can be varied by raising or lowering D, and by noting the corresponding change in height of the mercury column the necessary correction for any contained air may be determined. Ten centimeters is a convenient length for the vapor space. D is equipped with suitable thermometer and stirrer.

This method involves determining the temperature corresponding to a given vapor pressure. The vessel D, is filled with water, or other liquid, heated to a temperature above that at which the determination is to be made, and raised or lowered until the mercury surface in the tube is below graduation G, which is about 15 cm. from the upper end of the tube, and another graduation coincides with the level of the mercury surface in the reservoir C. The liquid D, is kept well stirred and allowed to cool

slowly; the temperature being read the instant that the meniscus coincides with G. The vapor tension in cm. of mercury is then the difference between the barometric reading and the height of the mercury column in A plus the mercury equivalent of the liquid in A and pressure of air in the vapor space.

The principal advantage of this arrangement lies in the ease with which one may secure a series of determinations at different temperatures by merely raising D 5 or 10 cm. as soon as one determination is made, and allowing the liquid in D to cool until the meniscus again coincides with G. In this way a series of ten or twelve determinations may be made in a half hour.

Purdue University,

LaFayette, Ind.

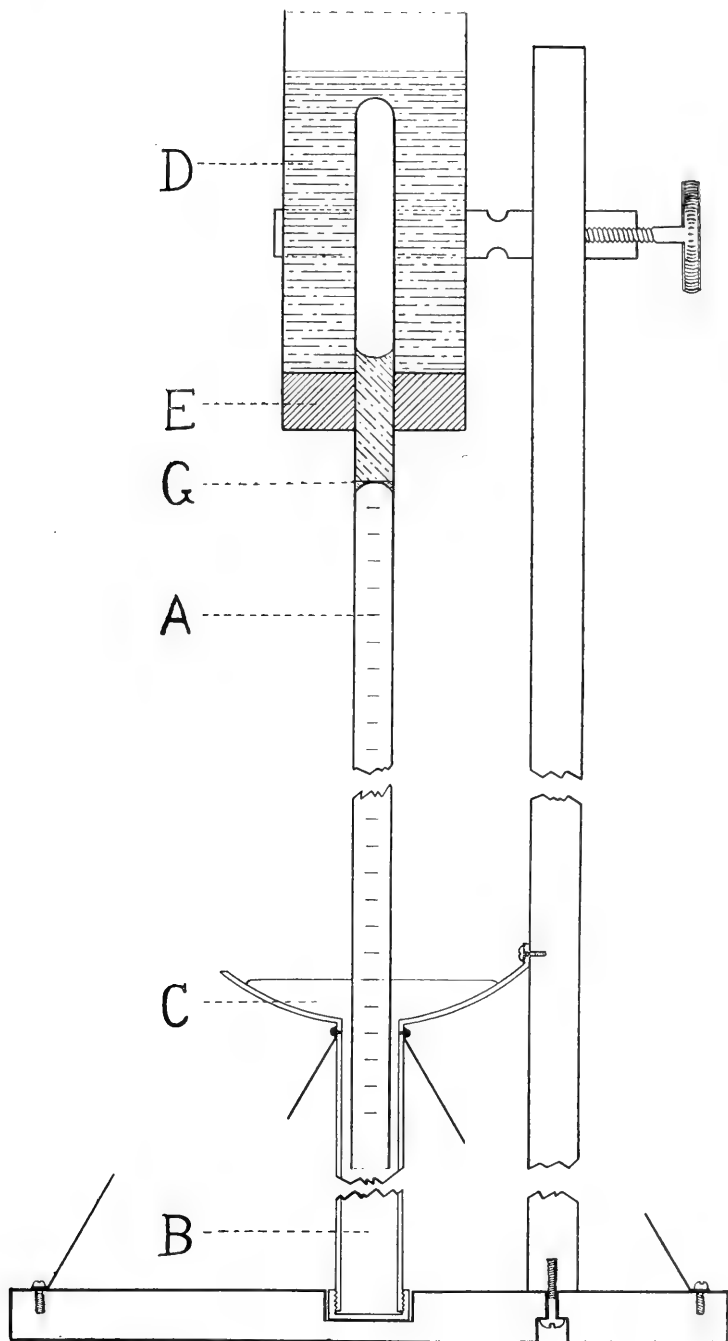

A simple laboratory method of measuring Vapor Tension.—A. E. Caswell.

A THEOREM ON ADDITION FORMULAE.

BY LESLIE MACDILL.

The theorem stated here is a corollary of a general theorem on a certain class of functional equations, whose theory has not been completed at the time of writing.

Abel has shown that if a function, $\phi(x, y)$, has the property:

$\phi[z, \phi(x, y)]$ is a symmetrical function of x, y , and z ; then there exists another function such that:

$$f(x) + f(y) = f[\phi(x, y)].$$

The corollary mentioned proves the converse of this theorem, and shows further, that a necessary and sufficient condition for the solution of an addition formula in the form:

$$f(x) + f(y) = f[z(x, y)],$$

where $z(x, y)$ is supposed given as a known function of x and y , is that the ratio:

$$\frac{\frac{\partial z}{\partial x}}{\frac{\partial z}{\partial y}}$$

shall assume the form of the ratio of a function of x alone, to a function of y alone, both of which functions have an indefinite integral, possessing each an inverse function, viz:

$$\frac{\frac{\partial z}{\partial x}}{\frac{\partial z}{\partial y}} = \frac{u'(x)}{u'(y)}$$

Furthermore, if we designate the inverse function by the bar,

$$z(x, y) = \bar{u}[u(x) + u(y)]$$

is another necessary and sufficient restriction on the function $z(x, y)$.

If the equation be given in the form:

$$(2) \quad z[f(x), f(y)] = f(x + y),$$

the necessary and sufficient conditions are:

$$\frac{\frac{\partial z}{\partial s}}{\frac{\partial z}{\partial t}} = \frac{u'(s)}{u'(t)} \quad \begin{array}{l} s = f(x). \\ t = f(y). \end{array}$$

$$z(s, t) = \bar{u}[u(s) + u(t)].$$

The solution for the unknown function in (1), under the restrictions named above is

$$f(x) = \lambda u(x), \quad \lambda = \text{arbitrary constant,}$$

and for (2) is

$$f(s) = \lambda u(s), \text{ or as before; } f(x) = \lambda u(x).$$

It will be further noticed that if

$$z[w, z(x, y)] = \text{symmetric function,}$$

then

$$f(x) + f(y) = f[z(x, y)], \text{ by Abel's theorem.}$$

We prove the converse. Necessarily

$$z(x, y) = \bar{u}[u(x) + u(y)].$$

$z[w, z(x, y)] = \bar{u}[u(w) + u\{u(u(x) + u(y))\}] = \bar{u}[u(w) + u(x) + u(y)],$
which is a symmetric function.

Indiana University.

NOTE ON MULTIPLY PERFECT NUMBERS, INCLUDING A TABLE OF 204
NEW ONES AND THE 47 OTHERS PREVIOUSLY PUBLISHED.

BY R. D. CARMICHAEL AND T. E. MASON.

§1. *Introduction and Historical Note.*

If the sum of all the divisors of N is mN , where m is an integer, we shall call N a multiply perfect number of multiplicity m . If $m=2$ we shall call N a perfect number.

The study of such numbers gave rise to the principal contributions of Fermat to the higher arithmetic; and consequently they have been a means of prime importance in leading to the development of the modern theory of numbers.¹ As is well known their history goes back to Euclid, who proved that every number of the form $2^{p-1}(2^p-1)$, where 2^p-1 is a prime, is a perfect number. Euler and others² have shown that every even perfect number is of the Euclid type; but it remains an open question as to whether there do or do not exist odd perfect numbers. Several supposed proofs that no odd perfect number exists have been given, but none of these is rigorous. The actually known perfect numbers³ are included in the Euclid formula $2^{p-1}(2^p-1)$ for the ten values of p , $p=2, 3, 5, 7, 13, 17, 19, 31, 61, 89$.

It appears that the first discovery of a multiply perfect number of multiplicity greater than 2 is due to Mersenne, who observed that 120 is one-third of the sum of all its divisors. In response to a problem proposed by Mersenne, Fermat pointed out that 672 has also the property of being equal to one-third the sum of all of its divisors. From time to time other multiply perfect numbers have been discovered.⁴ Up to the present time

¹ Cf. Lucas, *Théorie des nombres*, I, p. 376.

² A very simple proof of this theorem has recently been given by Dickson, *American Mathematical Monthly*, vol. 18 (1911), p. 109. See also a proof by Carmichael, *Annals of Mathematics*, vol. 8 (1907), p. 150.

³ For reference to the literature of perfect numbers, see *Encyclopédie des sciences mathématiques*, I₃, pp. 53-56.

⁴ For a short history of these numbers, with references, see *Encyclopédie des sciences mathématiques*, I₃, pp. 56-58.

there have been published altogether, so far as we have been able to find out, a total of forty-seven multiply perfect numbers. Cunningham¹ has announced that he has a table of eighty-five multiply perfect numbers; but he published only one of them. In the table of perfect and multiply perfect numbers in §3 we have credited to the discoverer each of the forty-seven numbers which have heretofore been published.² The remaining two hundred four numbers of the table are believed to be published here for the first time. It should be noted that numbers of multiplicity 7 occur in this table for the first time.

In §2 we have given some working rules which were found useful in obtaining new multiply perfect numbers from those already known or discovered in the process of constructing the table. Their further use would consist in the possible discovery of several new multiply perfect numbers from a single new one found by any other means whatever. It was in this way that many of the new numbers in this paper were discovered; one was obtained by direct means and others followed by use of the rules. As to the rules themselves, some of them were gotten by direct means and others by comparison of numbers in the table while the table itself was being constructed. The list of number pairs in the rules might be largely extended by a further comparison of numbers in the table. We have selected a part of those which actually proved to be of most use in the construction of the table.

§2. Rules for Finding Multiply Perfect Numbers.

The following two theorems afford useful working rules for finding new multiply perfect numbers:

I. If $\prod p_i^{a_i}$ and $\prod q_i^{b_i}$ (in either order) are a pair of factor sets from the list below and if a multiply perfect number N of multiplicity m contains the factor $\prod p_i^{a_i}$ without containing either any factor $p_i^{a_i+1}$ or any factor q_i different from every p_i ; then the number

$$\frac{N \prod q_i^{b_i}}{\prod p_i^{a_i}}$$

is also a multiply perfect number of multiplicity m .

¹ *British Association Report*, 1902, pp. 528-529.

² We are indebted to Prof. Dickson for reference to the first publication of six of these numbers.

27. 17, 2^{10} . 23. 89
 27. 17, 2^{25} . 19. 683. 2731. 8191
 29. 31, 2^{13} . 43. 127†
 2¹¹. 3⁵, 2^{20} . 3³. 127. 337
 2²⁸. 7. 23. 233. 1103. 2089, 2^{36} . 7⁵. 43. 223. 7019. 112303. 898423. 616318177
 2³³. 131071, 2^{37} . 174763. 524289
 2³⁸. 53. 229. 8191. 121369, 2^{61} . 59. 157. 43331. 3033169. 715827883. 2147483647
 3⁴. 11³. 13, 3⁵. 11. 13²
 3⁶. 137. 547. 1093, 3^{10} . 107. 3851
 3⁷. 23. 41, 3^{10} . 23^2 . 79. 107. 3851
 5². 7². 19. 31, 5^3 . 7³. 13
 5². 13^2 . 31^2 . 61. 83. 331, 5^3 . 13^3 . 17
 5². 7². 19^2 . 127, 5^3 . 7³. 19
 5³. 7⁴. 13^3 . 17^2 . 307. 467. 2801, 5^4 . 7³. 13. 17. 71

If $N = r_1^{\gamma_1} r_2^{\gamma_2} \dots r_n^{\gamma_n}$, where r_1, r_2, \dots, r_n are different primes, is a multiply perfect number of multiplicity m , then from the formula for the sum of all the divisors of N and the fact that this sum is now supposed to be mN , we have

$$m = \prod_{i=1}^n \frac{r_i^{\gamma_i+1} - 1}{r_i^{\gamma_i} (r_i - 1)}$$

Therefore in order to prove the accuracy of the rules we have only to show in each case that

$$\prod \frac{p_i^{a_i+1} - 1}{p_i^{a_i} (p_i - 1)} = \prod \frac{q_i^{\beta_i+1} - 1}{q_i^{\beta_i} (q_i - 1)}$$

The verification is not carried out.

II. If $\prod p_i^{a_i} (m_1)$ and $\prod q_i^{\beta_i} (m_2)$ (in either order) are a pair of factor sets and multiplicity from the list below and if a multiply perfect number N_1 of multiplicity m_1 contains the factor $\prod p_i^{a_i}$ without containing either any factor $p_i^{a_i+1}$ or any factor q_i different from every p_i ; then the number

$$N_2 = \frac{N_1 \prod q_i^{\beta_i}}{\prod p_i^{a_i}}$$

† This pair is due to Descartes.

is a multiply perfect number of multiplicity m :

$$3^3 \cdot 5 \cdot 7^3 \cdot 13 \text{ (5)}, 3^{10} \cdot 7 \cdot 23 \cdot 107 \cdot 3851 \text{ (4)}$$

$$3^4 \cdot 7 \cdot 11^2 \cdot 19 \text{ (5)}, 3^6 \cdot 23 \cdot 137 \cdot 547 \cdot 1093 \text{ (4)}$$

$$5 \cdot 7 \text{ (5)}, 5^3 \cdot 7^2 \cdot 13 \cdot 19 \text{ (6)}$$

$$5^2 \cdot 31 \text{ (5)}, 5^3 \cdot 7 \cdot 13 \text{ (6)}$$

In order to prove the theorem it is clear that we have only to show in each case that

$$\frac{1}{m_1} \prod_{i=1}^{a_i+1} p_i = \frac{1}{m_2} \prod_{i=1}^{\beta_i+1} q_i$$

The verification is omitted.

The following theorem, due to Descartes, is also readily proved:

III. If N is a multiply perfect number of multiplicity p^a , where p is a prime number, and if N is not divisible by p , then pN is a multiply perfect number of multiplicity $(p+1)^a$.

§3. Table of Multiply Perfect Numbers.*†

- 2) 2. 3. (Euclid, Nicomaque.)
- 2) 2². 7. (Euclid, Nicomaque.)
- 4) 2². 3². 5. 7². 13. 19. (Lehmer.)
- 3) 2³. 3. 5. (Mersenne.)
- 4) 2³. 3². 5. 7. 13. (Descartes.)
- 2) 2⁴. 31. (Euclid, Nicomaque.)
- 3) 2⁵. 3. 7. (Fermat.)
- 4) 2⁵. 3². 5. 7. (Descartes.)
- 4) 2⁵. 3⁴. 7². 11². 19². 127.
- 2) 2⁶. 127. (Euclid, Nicomaque.)
- 4) 2⁷. 3³. 5². 17. 31. (Mersenne.)
- 5) 2⁷. 3⁴. 5. 7. 11². 17. 19. (Descartes.)
- 5) 2⁷. 3⁵. 5. 7². 13. 17. 19. (Descartes.)
- 4) 2⁷. 3⁶. 5. 17. 23. 137. 547. 1093. (Fermat.)
- 4) 2⁷. 3¹⁰. 5. 17. 23. 107. 3851.
- 4) 2⁸. 3. 5. 7. 19. 37. 73. (Lucas.)

* The numbers marked with a star were discovered by Mr. Mason. The remaining hitherto unpublished numbers were discovered by Mr. Carmichael.

† The multiplicity of each number is written to its left. If previously published the discoverer's name is given to the right.

- 4) $2^3, 3^3, 7^3, 13, 19^2, 37, 73, 127$. (Lehmer.)
 3) $2^3, 5, 7, 19, 37, 73$. (Legendre.)
 3) $2^9, 3, 11, 31$. (Jumeau, Fermat.)
 4) $2^9, 3^2, 7, 11, 13, 31$. (Descartes.)
 4) $2^9, 3^3, 5, 11, 31$. (Descartes.)
 4) $2^9, 3^4, 7, 11^3, 31^2, 61, 83, 331$.
 4) $2^{10}, 3^3, 5^2, 23, 31, 89$. (Mersenne.)
 5) $2^{10}, 3^4, 5, 7, 11^2, 19, 23, 89$. (Fermat.)
 5) $2^{10}, 3^5, 5, 7^2, 13, 19, 23, 89$. (Frenicle.)
 5) $2^{11}, 3^3, 5^2, 7^2, 13, 19, 31$. (Lehmer.)
 5) $2^{11}, 3^5, 5, 7^2, 13^2, 19, 31, 61$.
 5) $2^{11}, 3^3, 5^2, 7^3, 13^2, 31^2, 61, 83, 331$.
 5) $2^{11}, 3^5, 5^3, 7^3, 13^3, 17$.
 5) $2^{11}, 3^9, 5, 7^2, 13, 19, 23, 137, 547, 1093$.
 5) $2^{11}, 3^{10}, 5, 7^2, 13, 19, 23, 107, 3851$.
 2) $2^{12}, 8191$. (See *Encyclopédie* I, 3, p. 55.)
 3) $2^{13}, 3, 11, 43, 127$. (Descartes.)
 4) $2^{13}, 3^2, 7, 11, 13, 43, 127$. (Descartes.)
 4) $2^{13}, 3^3, 5, 11, 43, 127$. (Descartes.)
 4) $2^{14}, 3, 5, 7, 19, 31, 151$. (Fermat.)
 4) $2^{14}, 3^2, 7^2, 13, 19^2, 31, 127, 151$. (Carmichael.)
 5) $2^{14}, 3^2, 5^2, 7^3, 13, 19, 31^2, 83, 151, 331$.
 3) $2^{14}, 5, 7, 19, 31, 151$. (Fermat.)
 6) $2^{15}, 3^3, 5^2, 7^2, 11, 13, 17, 19, 31, 43, 257$. (Carmichael.)
 *6) $2^{15}, 3^5, 5^3, 7^4, 11^2, 13^3, 17^2, 19, 43, 257, 307, 467, 2801$.
 *6) $2^{15}, 3^5, 5^4, 7^3, 11^2, 13, 17, 19, 43, 71, 257$.
 5) $2^{15}, 3^7, 5, 7, 11, 17, 41, 43, 257$.
 6) $2^{15}, 3^7, 5^3, 7^2, 11, 13, 17, 19, 41, 43, 257$.
 2) $2^{16}, 131071$. (See *Encyclopédie* I, 3, p. 55.)
 6) $2^{17}, 3^4, 5^3, 7^3, 11^2, 13^2, 19^3, 31, 37, 61, 73, 181$.
 5) $2^{17}, 3^5, 5, 7^3, 13, 19^2, 37, 73, 127$. (Fermat.)
 4) $2^{17}, 3^3, 7, 19^2, 23, 37, 73, 127, 137, 547, 1093$.
 *6) $2^{17}, 3^9, 5^2, 7^3, 11^2, 17, 19^4, 31^2, 37, 61, 73, 83, 101, 227, 331, 137561$.
 4) $2^{17}, 3^{10}, 7, 19^2, 23, 37, 73, 107, 127, 3851$.
 5) $2^{17}, 3^{11}, 7^5, 11^2, 13, 17^2, 19^4, 43, 53, 73^2, 101, 227, 307, 1801, 137561$.
 6) $2^{17}, 3^{11}, 5, 7^5, 11^2, 13, 17^2, 19^4, 43, 53, 73^2, 101, 227, 307, 1801, 137561$.
 *6) $2^{17}, 3^{11}, 5^3, 7^4, 11, 13^3, 17^2, 19, 53, 73^2, 307, 467, 1801, 2801$.

- 6) 2^{17} , 3^{11} , 5^4 , 7^3 , 11, 13, 17, 19, 53, 71, 73^2 , 1801.
- 2) 2^{18} , 524287. (See *Encyclopédie* I, 3, p. 55.)
- 6) 2^{19} , 3^4 , 5^2 , 7^2 , 11^3 , 13, 19^2 , 31^3 , 37, 41, 61, 127.
- 6) 2^{19} , 3^4 , 5^5 , 7^3 , 11^3 , 13, 19, 31^3 , 37, 41, 61.
- 6) 2^{19} , 3^5 , 5^2 , 7^2 , 11, 13^2 , 19^2 , 31^3 , 37, 41, 61, 127.
- 6) 2^{19} , 3^5 , 5^3 , 7^3 , 11, 13^2 , 19, 31^3 , 37, 41, 61.
- 5) 2^{19} , 3^6 , 5, 7, 11, 23, 31, 41, 137, 547, 1093.
- 6) 2^{19} , 3^6 , 5^3 , 7^2 , 11, 13, 19, 23, 31, 41, 137, 547, 1093. (Lehmer.)
- 5) 2^{19} , 3^7 , 5^2 , 7, 11, 31^2 , 41^2 , 83, 331, 431, 1723.
- *6) 2^{19} , 3^8 , 5^3 , 7^2 , 11, 13^2 , 19^2 , 31^2 , 41, 61, 83, 127, 331, 379, 757.
- 6) 2^{19} , 3^9 , 5^3 , 7^4 , 11^3 , 13^3 , 17, 31, 41, 61^2 , 97, 467, 2801.
- 5) 2^{19} , 3^{10} , 5, 7, 11, 23, 31, 41, 107, 3851.
- 6) 2^{19} , 3^{10} , 5^3 , 7^2 , 11, 13, 19, 23, 31, 41, 107, 3851.
- 5) 2^{20} , 3^2 , 5^2 , 7^3 , 13^3 , 17, 31, 127, 337.
- 5) 2^{20} , 3^3 , 5, 7^2 , 13^2 , 19, 31, 61, 127, 337. (Fermat.)
- 5) 2^{20} , 3^3 , 5^2 , 7^3 , 13^2 , 31^2 , 61, 83, 127, 331, 337.
- 5) 2^{20} , 3^3 , 5^3 , 7^3 , 13^3 , 17, 127, 337.
- *6) 2^{20} , 3^4 , 5^2 , 7^4 , 11^2 , 13^3 , 17, 19, 31, 127, 337, 467, 2801.
- 5) 2^{20} , 3^7 , 5, 7^4 , 13^3 , 17, 41, 127, 337, 467, 2801.
- 5) 2^{21} , 3^6 , 5^2 , 7, 19, 23^2 , 31, 79, 89, 137, 547, 683, 1093. (Lehmer.)
- 5) 2^{21} , 3^7 , 5^2 , 7, 19, 23, 31, 41, 89, 683.
- 5) 2^{21} , 3^8 , 5, 7, 13, 19^2 , 23, 89, 127, 379, 683, 757.
- *6) 2^{21} , 3^9 , 5^3 , 7^3 , 11^2 , 13^2 , 19^2 , 23, 61^2 , 89, 97, 127, 683.
- 5) 2^{21} , 3^{10} , 5^2 , 7, 19, 23^2 , 31, 79, 89, 107, 683, 3851.
- *6) 2^{21} , 3^{11} , 5^2 , 7^2 , 13, 17, 19^2 , 23, 31, 37, 73, 89, 101, 227, 683, 137561.
- 5) 2^{21} , 3^{12} , 7^2 , 11, 13, 17^2 , 19^2 , 23, 89, 101, 103, 227, 307, 617, 683, 137561, 398581, 797161.
- 6) 2^{21} , 3^{12} , 5, 7^2 , 11, 13, 17^2 , 19^2 , 23, 89, 101, 103, 227, 307, 617, 683, 137561, 398581, 797161.
- *6) 2^{21} , 3^{12} , 5^2 , 7^2 , 13^2 , 17, 19^2 , 23, 31^2 , 61, 83, 89, 103, 181, 331, 617, 683, 398581, 797161.
- 5) 2^{22} , 3^7 , 5, 7, 11, 19, 41, 47, 151, 197, 178481.
- *6) 2^{22} , 3^8 , 5^2 , 7^2 , 11, 13^2 , 19^2 , 31^2 , 47, 61, 83, 151, 181, 197, 331, 379, 757, 178481.
- *6) 2^{22} , 3^8 , 5^3 , 7^2 , 11, 13^3 , 17, 19^3 , 47, 151, 181, 197, 379, 757, 178481.
- *5) 2^{22} , 3^{11} , 7^2 , 11, 13, 17, 19^2 , 37, 47, 73, 101, 151, 197, 227, 137561, 178481.
- *6) 2^{22} , 3^{11} , 5, 7^2 , 11, 13, 17, 19^2 , 37, 47, 73, 101, 151, 197, 227, 137561, 178481.

- 6) 2^{23} , 3^7 , 5^3 , 7^4 , 11^2 , 13^3 , 17^2 , 31, 41, 61, 241, 307, 467, 2801. (Fermat.)
- *6) 2^{23} , 3^7 , 5^4 , 7^2 , 11^3 , 13, 17, 31, 41, 61, 71, 241.
- *6) 2^{24} , 3^7 , 5^3 , 7^3 , 11, 13, 17, 31, 41, 43, 53, 601, 1801.
- *6) 2^{24} , 3^7 , 5^4 , 7^3 , 11^2 , 17, 19, 31, 41, 43, 53, 71, 601, 1801.
- 5) 2^{24} , 3^8 , 7^2 , 11, 13, 17, 19^2 , 31, 43, 53, 127, 379, 601, 757, 1801.
- 6) 2^{24} , 3^8 , 5, 7^2 , 11, 13, 17, 19^2 , 31, 43, 53, 127, 379, 601, 757, 1801. (Lehmer.)
- 4) 2^{25} , 3^3 , 5^2 , 19, 31, 683, 2731, 8191. (Carmichael.)
- 4) 2^{25} , 3^4 , 7, 11^2 , 19^2 , 127, 683, 2731, 8191.
- 4) 2^{25} , 3^5 , 7^2 , 13, 19^2 , 127, 683, 2731, 8191.
- 4) 2^{25} , 3^6 , 5, 19, 23, 137, 547, 683, 1093, 2731, 8791. (Carmichael.)
- 4) 2^{25} , 3^{10} , 5, 19, 23, 107, 683, 2731, 3851, 8191.
- 6) 2^{26} , 3^2 , 5^6 , 7^3 , 11^2 , 13^2 , 19^3 , 31, 37, 43, 61, 73, 181, 199, 257, 19531, 11939, 262657.
- 6) 2^{26} , 3^3 , 5^5 , 7^5 , 11^2 , 13, 19^3 , 31, 37, 43, 73, 181, 199, 11939, 262657.
- 6) 2^{26} , 3^4 , 5^3 , 7^2 , 11^3 , 13, 19^2 , 31, 37, 61, 73, 127, 199, 11939, 262657.
- 6) 2^{26} , 3^5 , 5^3 , 7^2 , 11, 13^2 , 19^3 , 31, 37, 61, 73, 127, 199, 11939, 262657.
- 6) 2^{26} , 3^6 , 5^3 , 7^2 , 11, 13, 19^2 , 23, 37, 73, 127, 137, 199, 547, 1093, 11939, 262657.
- 6) 2^{26} , 3^7 , 5^4 , 7^4 , 11^2 , 13, 19^2 , 37, 41, 71, 73, 127, 199, 467, 2801, 11939, 262657.
- *6) 2^{26} , 3^7 , 5^5 , 7^4 , 11, 13, 19, 31, 37, 41, 73, 199, 467, 2801, 11939, 262657.
- *6) 2^{26} , 3^7 , 5^6 , 7^3 , 11^2 , 17, 19^4 , 37, 41, 43, 73, 101, 199, 227, 257, 11939, 19531, 137561, 262657.
- 6) 2^{26} , 3^{10} , 5^3 , 7^2 , 11, 13, 19^2 , 23, 37, 73, 107, 127, 199, 3851, 11939, 262657.
- 6) 2^{27} , 3^4 , 5^3 , 7, 11^3 , 13, 19, 29, 31, 43, 61, 113, 127.
- 6) 2^{27} , 3^5 , 5^3 , 7, 11, 13^2 , 19, 29, 31, 43, 61, 113, 127. (Fermat.)
- 6) 2^{27} , 3^5 , 5^5 , 7^3 , 11, 13, 19, 29, 31, 43, 113, 127.
- *5) 2^{27} , 3^6 , 5^2 , 11, 19, 23, 29, 31, 43, 113, 127, 137, 547, 1093.
- 6) 2^{27} , 3^6 , 5^3 , 7, 11, 13, 19, 23, 29, 43, 113, 127, 137, 547, 1093.
- *5) 2^{27} , 3^9 , 5^4 , 11^4 , 19, 29, 31, 43, 61, 71, 113, 127, 179, 3221.
- 5) 2^{27} , 3^{10} , 5^2 , 11, 19, 23, 29, 31, 43, 107, 113, 127, 3851.
- 6) 2^{27} , 3^{10} , 5^3 , 7, 11, 13, 19, 23, 29, 43, 107, 113, 127, 3851.
- *6) 2^{28} , 3^6 , 5^2 , 7^2 , 11, 13, 19^2 , 23^2 , 31, 79, 127, 137, 233, 547, 1093, 1103, 2089.
- 6) 2^{28} , 3^6 , 5^3 , 7, 11, 13^2 , 19, 23^2 , 31, 61, 79, 137, 233, 547, 1093, 1103, 2089.
- 6) 2^{28} , 3^6 , 5^4 , 7^3 , 11^2 , 13, 19^2 , 23^2 , 71, 79, 127, 137, 233, 547, 1093, 1103, 2089.
- 6) 2^{28} , 3^6 , 5^5 , 7^3 , 11, 13, 19, 23^2 , 31, 79, 137, 233, 547, 1093, 1103, 2089.

- *6) $2^8, 3^7, 5^2, 7^2, 11, 13, 19^2, 23, 31, 41, 127, 233, 1103, 2089$.
- 6) $2^8, 3^7, 5^2, 7, 11, 13^2, 19, 23, 31, 41, 61, 233, 1103, 2089$.
- 6) $2^8, 3^7, 5^4, 7^3, 11^2, 13, 19^2, 23, 41, 71, 127, 233, 1103, 2089$.
- 6) $2^8, 3^7, 5^2, 7^3, 11, 13, 19, 23, 31, 41, 233, 1103, 2089$.
- *5) $2^8, 3^8, 5, 11, 13^2, 19^2, 23, 31, 61, 127, 233, 379, 757, 1103, 2089$.
- 6) $2^8, 3^8, 5^2, 7, 11, 13^2, 19^2, 23, 31^2, 61, 83, 127, 233, 331, 379, 757, 1103, 2089$.
- *6) $2^8, 3^8, 5^3, 7, 11, 13^3, 17, 19^2, 23, 127, 233, 379, 757, 1103, 2089$.
- 6) $2^8, 3^8, 5^4, 7, 11^4, 13, 19, 23, 31, 61, 71, 179, 233, 1103, 2089, 3221$.
- *6) $2^8, 3^{10}, 5^2, 7^2, 11, 13, 19^2, 23^2, 31, 79, 107, 127, 233, 1103, 2089, 3851$.
- 6) $2^8, 3^{10}, 5^3, 7, 11, 13^2, 19, 23^2, 31, 61, 79, 107, 233, 1103, 2089, 3851$.
- 6) $2^8, 3^{10}, 5^4, 7^3, 11^2, 13, 19^2, 23^2, 71, 79, 107, 127, 233, 1103, 2089, 3851$.
- 6) $2^8, 3^{10}, 5^5, 7^3, 11, 13, 19, 23^2, 31, 79, 107, 233, 1103, 2089, 3851$.
- *6) $2^8, 3^{11}, 5^3, 7^2, 11, 13^4, 19^3, 23, 37, 73, 181, 191, 233, 1103, 2089, 30941$.
- 6) $2^9, 3^7, 5^2, 7^3, 11^2, 13, 19^2, 31^2, 37, 61, 83, 127, 151, 331$.
- 6) $2^9, 3^7, 5^2, 7^3, 11, 13^2, 19^2, 31^2, 37, 61, 83, 127, 151, 331$.
- 5) $2^9, 3^6, 7^2, 11^2, 13, 19^3, 23, 31, 43, 83, 137, 151, 181, 331, 547, 1093$.
- 6) $2^9, 3^6, 5, 7^2, 11^2, 13, 19^3, 23, 31, 43, 83, 137, 151, 181, 331, 547, 1093$.
- 6) $2^9, 3^6, 5^2, 7^3, 11, 13, 19, 23, 31, 83, 137, 151, 331, 547, 1093$.
- 5) $2^9, 3^{10}, 7^2, 11^2, 13, 19^2, 23, 31, 43, 83, 107, 151, 181, 331, 3851$.
- 6) $2^9, 3^{10}, 5, 7^2, 11^2, 13, 19^3, 23, 31, 43, 83, 107, 151, 181, 331, 3851$.
- 6) $2^9, 3^{10}, 5^3, 7^3, 11, 13, 19, 23, 31, 83, 107, 151, 331, 3851$.
- 2) $2^{30}, 2147483647$. (Euler.)
- *5) $2^{31}, 3^{13}, 7^4, 11^3, 13, 17, 31, 41, 43, 61, 83, 163, 257, 307, 331, 467, 547^2, 613, 1093, 2801, 65537$.
- *6) $2^{31}, 3^{13}, 5, 7^4, 11^3, 13, 17, 31, 41, 43, 61, 83, 163, 257, 307, 331, 467, 547^2, 613, 1093, 2801, 65537$.
- *6) $2^{32}, 3^8, 5^7, 7^3, 13^2, 17, 19, 23, 31, 61, 79, 89, 157, 313, 379, 757, 2141, 599479$.
- *7) $2^{32}, 3^{11}, 5^3, 7^3, 11^2, 13^2, 17^2, 19^4, 23, 31, 37, 43, 61, 73, 89, 101, 227, 307, 2141, 137561, 599479$.
- *7) $2^{32}, 3^{11}, 5^4, 7^3, 11^2, 13^2, 17, 19^2, 23, 31, 37, 43, 61, 71, 73, 89, 181, 2141, 599479$.
- *7) $2^{32}, 3^{14}, 5^2, 7^3, 11^2, 13, 17^2, 19^4, 23, 31^2, 37, 41, 61, 83, 89, 101, 163, 227, 307, 331, 1063, 2141, 2281, 4561, 137561, 599479$.
- 6) $2^{32}, 3^{12}, 5^9, 7^3, 11^4, 17, 23, 29, 31, 61, 71, 89, 179, 197, 521, 1181, 2141, 3221, 599479$.

- 4) 2^{33} , 3^4 , 7, 11^3 , 31, 61, 83, 331, 43691, 131071.
- 5) 2^{33} , 3^5 , 5, 7^3 , 11, 13, 83, 331, 43691, 131071.
- 4) 2^{33} , 3^6 , 7, 11, 23, 83, 137, 331, 547, 1093, 43691, 131071.
- 5) 2^{33} , 3^7 , 5, 7^2 , 11, 19, 41, 83, 331, 43691, 131071.
- 4) 2^{33} , 3^{10} , 7, 11, 23, 83, 107, 331, 3851, 43691, 131071.
- *6) 2^{33} , 3^{14} , 5^2 , 7^4 , 11^4 , 13^2 , 17, 31^2 , 41, 61, 163, 179, 331^2 , 467, 2281, 2617, 2801, 3221, 4561, 5233, 43691, 131071.
- *6) 2^{34} , 3^8 , 5^4 , 7, 11, 13, 17, 19^2 , 31, 71^2 , 127^2 , 271, 379, 683, 757, 1279, 2557, 5113, 5419, 6829, 122921.
- 5) 2^{34} , 3^{12} , 7^2 , 11, 13, 17^2 , 19^4 , 31, 71, 101, 103, 127, 227, 307, 617, 683, 6829, 122921, 137561, 398581, 797161.
- 6) 2^{34} , 3^{12} , 5, 7^2 , 11, 13, 17^2 , 19^4 , 31, 71, 101, 103, 127, 227, 307, 617, 683, 6829, 122921, 137561, 398581, 797161.
- *6) 2^{34} , 3^{13} , 5^3 , 7^4 , 11, 13, 19, 31^2 , 41, 71, 83, 127, 163, 307, 331, 467, 547^2 , 613, 683, 1093, 2801, 6829, 122921.
- *6) 2^{34} , 3^{15} , 5^3 , 7^4 , 13^2 , 17, 19, 31^2 , 41, 61, 71, 83, 97, 127, 193, 331, 467, 683, 2801, 6829, 122921.
- *6) 2^{34} , 3^{19} , 5^3 , 7, 11^4 , 17, 19^2 , 31^2 , 43, 61, 71, 83, 127^2 , 179, 197, 257, 271, 331, 683, 1181, 3221, 5419, 6829, 19531, 122921.
- 7) 2^{35} , 3^{13} , 5^2 , 7^5 , 11^2 , 13, 17, 19^2 , 31^2 , 37^2 , 41, 43, 61, 67, 73, 83, 109, 127, 163, 307, 331, 547^2 , 613, 1093.
- *7) 2^{35} , 3^{13} , 5^3 , 7^4 , 11^2 , 13^3 , 17^2 , 19^2 , 23, 37^2 , 41, 43, 67, 73, 109, 127, 163, 307^2 , 367, 467, 547^2 , 613, 733, 1093, 2801.
- *7) 2^{35} , 3^{14} , 5^3 , 7^3 , 11^4 , 13^2 , 17, 19^2 , 31, 37^2 , 41, 43, 61, 67, 73, 109, 127, 163, 179, 257, 2281, 3221, 4561, 19531.
- 7) 2^{35} , 3^{15} , 5^3 , 7^7 , 11^4 , 13, 17^2 , 19, 29, 37^2 , 41, 43, 67, 71, 73, 97, 109, 179, 193, 307, 521, 601, 1201, 3221.
- 6) 2^{38} , 3^5 , 5^4 , 7, 11^2 , 13^2 , 19, 31, 43, 61, 71, 223, 601, 1201, 7019, 112303, 898423, 616318177.
- *6) 2^{36} , 3^6 , 5^2 , 7^3 , 11, 13, 19, 23, 31, 43, 137, 223, 547, 1093, 7019, 112303, 898423, 616318177.
- 6) 2^{36} , 3^6 , 5^4 , 7, 11^2 , 13, 19, 23, 43, 71, 137, 223, 547, 601, 1093, 1201, 7019, 112303, 898423, 616318177.
- *6) 2^{36} , 3^7 , 5^3 , 7^5 , 11, 13^2 , 19, 31, 41, 43, 61, 223, 7019, 112303, 898423, 616318177.
- *6) 2^{36} , 3^8 , 5^2 , 7^5 , 11, 13^2 , 19^2 , 31^2 , 43, 61, 83, 127, 223, 331, 379, 757, 7019, 112303, 898423, 616318177.

- *6) 2^{30} , 3^8 , 5^2 , 7^2 , 11, 13^2 , 17, 19^2 , 43, 127, 223, 379, 757, 7019, 112303, 898423, 616318177.
- 6) 2^{30} , 3^8 , 5^2 , 7^2 , 11, 13^2 , 19, 31^2 , 43, 61, 83, 223, 331, 379, 601, 757, 1201, 7019, 112303, 898423, 616318177. (Gérardin.)
- *6) 2^{30} , 3^9 , 5^4 , 7^2 , 11^4 , 13, 19, 31, 43, 61, 71, 179, 223, 3221, 7019, 112303, 898423, 616318177.
- 6) 2^{30} , 3^9 , 5^2 , 7^2 , 11^3 , 13^2 , 19, 29, 31, 61^3 , 223, 263, 1861, 4733, 7019, 112303, 898423, 616318177.
- *6) 2^{30} , 3^{10} , 5^2 , 7^2 , 11, 13, 19, 23, 31, 43, 107, 223, 3851, 7019, 112303, 898423, 616318177.
- 6) 2^{30} , 3^{10} , 5^4 , 7, 11^2 , 13, 19, 23, 43, 71, 107, 223, 601, 1201, 3851, 7019, 112303, 898423, 616318177.
- *6) 2^{30} , 3^{11} , 5^2 , 7^8 , 13^2 , 17, 19^2 , 31^2 , 37^2 , 61, 67, 73, 83, 127, 223, 331, 1063, 7019, 112303, 898423, 616318177.
- *5) 2^{30} , 3^{12} , 7^8 , 11, 13, 17, 19^4 , 37, 41, 101, 163, 223, 227, 307, 547^2 , 613, 1063, 1063, 7019, 112303, 137561, 898423, 616318177.
- *6) 2^{30} , 3^{12} , 5, 7^8 , 11, 13, 17, 19^4 , 37, 41, 101, 163, 223, 227, 307, 547^2 , 613, 1063, 1063, 7019, 112303, 137561, 898423, 616318177.
- *6) 2^{30} , 3^{14} , 5^4 , 7^2 , 11^4 , 13^2 , 29, 31, 41, 61, 71, 163, 179, 223, 263, 2281, 3221, 4561, 4733, 7019, 112303, 898423, 616318177.
- 4) 2^{37} , 3^4 , 7, 11^3 , 31, 61, 83, 331, 43691, 174763, 524287.
- 5) 2^{37} , 3^5 , 5, 7^3 , 11, 13, 83, 331, 43691, 174763, 524287.
- 4) 2^{37} , 3^6 , 7, 11, 23, 83, 137, 331, 547, 1063, 43691, 174763, 524287.
- 5) 2^{37} , 3^7 , 5, 7^2 , 11, 19, 41, 83, 331, 43691, 174763, 524287.
- 4) 2^{37} , 3^{10} , 7, 11, 23, 83, 107, 331, 3851, 43691, 174763, 524287.
- *6) 2^{37} , 3^{14} , 5^2 , 7^4 , 11^4 , 13^2 , 17, 31^2 , 41, 61, 163, 179, 331^2 , 467, 2281, 2617, 2801, 3221, 4561, 5233, 43691, 174763, 524287.
- 6) 2^{38} , 3^5 , 5^6 , 7^2 , 11, 13, 19, 23, 43, 53, 79, 229, 257, 8191, 19531, 121369.
- *5) 2^{38} , 3^7 , 5^5 , 7^2 , 23, 31, 41, 53, 79, 229, 8191, 121369.
- *6) 2^{38} , 3^8 , 5^4 , 7^2 , 11, 13, 19^2 , 23, 53, 71, 79, 127, 229, 379, 757, 8191, 121369.
- *6) 2^{38} , 3^9 , 5^2 , 7^5 , 11^2 , 19^2 , 23, 31^2 , 43^2 , 53, 61, 79^2 , 83, 127, 229, 331, 631, 8191, 121369.
- *6) 2^{38} , 3^9 , 5^4 , 7^2 , 11^3 , 13, 23, 43^2 , 53, 61^2 , 71, 79^2 , 97, 229, 601, 631, 1201, 8191, 121369.
- *6) 2^{38} , 3^{11} , 5^5 , 7^4 , 13^2 , 19, 23, 31^2 , 37, 53, 61, 73, 79, 83, 229, 331, 467, 2801, 8191, 121369.

- *7) 2^{30} , 3^{11} , 5^7 , 7^3 , 11, 13^2 , 17, 19^2 , 29, 31^2 , 37, 41, 61, 73, 79, 83, 127, 157, 313, 331, 2203, 30841, 61681.
- *7) 2^{30} , 3^{12} , 5^5 , 7^7 , 11^3 , 13^2 , 17^2 , 19^2 , 29, 31^2 , 41, 43, 61^2 , 83, 97, 103, 127, 307, 331, 601, 617, 1201, 2203, 30841, 61681, 398581, 797161.
- *7) 2^{30} , 3^{13} , 5^3 , 7^2 , 11^2 , 13, 17^2 , 19^4 , 23, 29, 31, 41^2 , 43, 101, 163, 227, 307^2 , 367, 431, 547^2 , 613, 733, 1093, 1723, 2203, 30841, 61681, 137561.
- *7) 2^{30} , 3^{15} , 5^4 , 7^4 , 11^2 , 13^2 , 17^3 , 19^2 , 29^2 , 31^2 , 41^2 , 61, 67, 71, 83, 97, 127, 193, 331, 431, 467, 1723, 2203, 2801, 30841, 61681.
- *5) 2^{40} , 3^{12} , 7^8 , 11^2 , 17^2 , 19^3 , 31, 37^2 , 43, 47, 67, 103^2 , 127, 257, 307, 557, 617, 1063, 3571, 7621, 13367, 15241, 398581, 797161, 164511353.
- *6) 2^{40} , 3^{12} , $5 \cdot 7^8$, 11^2 , 17^2 , 19^5 , 31, 37^2 , 43, 47, 67, 103^2 , 127, 257, 307, 557, 617, 1063, 3571, 7621, 13367, 15241, 398581, 797161, 164511353.
- *7) 2^{40} , 3^{15} , 5^2 , 7^6 , 11^2 , 13, 17, 19^2 , 29, 31^2 , 37, 41, 43, 83, 97, 103, 127, 193, 257, 263, 331, 557, 4733, 7621, 13367, 15241, 164511353.
- *6) 2^{41} , 3^5 , 5^3 , 7^7 , 11, 13^3 , 17^2 , 31, 43^2 , 79, 127, 271, 307, 337, 601, 631, 1201, 5419.
- *7) 2^{41} , 3^{11} , 5^5 , 7^6 , 11^3 , 13^2 , 17^2 , 19, 29, 31^2 , 37, 43, 61, 73, 83, 127, 263, 271, 307, 331, 337, 4733, 5419.
- *5) 2^{41} , 3^{14} , 7^4 , 11^3 , 13^4 , 17, 31, 41, 43, 61, 127, 163, 191, 271, 337, 467, 2281, 2801, 4561, 5419, 30941.
- *6) 2^{41} , 3^{14} , 5, 7^4 , 11^3 , 13^4 , 17, 31, 41, 43, 61, 127, 163, 191, 271, 337, 467, 2281, 2801, 4561, 5419, 30941.
- 6) 2^{42} , 3^{11} , 5^7 , 7^3 , 13^3 , 17, 19, 31, 37, 61, 73, 79, 83, 157, 313, 331, 431, 9719, 2099863.
- 5) 2^{42} , 3^{12} , 7^5 , 11^2 , 13, 19^2 , 31, 41, 43, 61, 83, 127, 163, 307, 331, 431, 547^2 , 613, 1093, 9719, 2099863.
- 6) 2^{42} , 3^{13} , 5, 7^3 , 11^2 , 13, 19^2 , 31, 41, 43, 61, 83, 127, 163, 307, 331, 431, 547^2 , 613, 1093, 9719, 2099863.
- *6) 2^{43} , 3^{13} , 5^3 , 7^8 , 11, 19^5 , 23, 31, 37, 41, 89, 127, 151, 163, 199, 307, 397, 547^2 , 613, 683, 1063, 1093, 2113.
- *7) 2^{43} , 3^{14} , 5^6 , 7^3 , 11^3 , 13, 17, 19^4 , 23, 31, 41, 43, 61, 89, 101, 151, 163, 199, 227, 257, 397, 683, 2113, 2281, 4561, 19531, 137561.
- *7) 2^{43} , 3^{15} , 5^8 , 7^6 , 11, 13, 17, 19^3 , 23, 29, 31, 41, 83, 89, 97, 151, 181, 193, 199, 263, 397, 683, 829, 2113, 4733.
- *6) 2^{43} , 3^{10} , 5^3 , 7, 11^4 , 19^2 , 23, 29, 31, 61, 71, 89, 127, 151, 179, 197, 199, 397, 521, 683, 1181, 2113, 3221.

- *7) 2^{13} , 3^{21} , 5^5 , 7^6 , 11, 13, 17, 19^3 , 23^2 , 29, 43^2 , 67, 79^2 , 83, 89, 107, 151, 181, 199, 257, 263, 331, 397, 631, 661, 683, 2113, 3851, 4733, 19531.
- *6) 2^{14} , 3^8 , 5^3 , 7^3 , 13, 19^2 , 23, 31^2 , 37, 47, 73, 79, 83, 127, 137, 151, 331, 547, 631, 1093, 23311.
- 6) 2^{14} , 3^7 , 5^4 , 7^3 , 11, 19^2 , 31^2 , 37, 41, 47, 71, 73, 79, 83, 127, 151, 331, 631, 23311.
- *6) 2^{14} , 3^{10} , 5^3 , 7^3 , 13, 19^2 , 23, 31^2 , 37, 47, 73, 79, 83, 107, 127, 151, 331, 631, 3851, 23311.
- *7) 2^{14} , 3^{11} , 5^3 , 7^6 , 11^2 , 13^3 , 17^2 , 19^3 , 29, 31^3 , 37, 47, 53, 73^2 , 79, 151, 181, 263, 307, 631, 1801, 4733, 23311.
- *5) 2^{15} , 3^{13} , 7^3 , 11^3 , 17, 19^2 , 31, 41, 43, 47, 61, 127, 151, 163, 197, 271, 307, 547², 613, 1093, 5419, 178481, 2796203.
- *6) 2^{15} , 3^{13} , 5, 7^2 , 11^3 , 17, 19^2 , 31, 41, 43, 47, 61, 127, 151, 163, 197, 271, 307, 547², 613, 1093, 5419, 178481, 2796203.
- *7) 2^{15} , 3^{14} , 5^3 , 7^3 , 11^5 , 13^2 , 17^2 , 19^4 , 31, 37, 41, 43, 47, 61, 101, 151, 163, 197, 227, 271, 307, 2281, 4561, 5419, 137561, 178481, 2796203.
- *7) 2^{15} , 3^{14} , 5^4 , 7^3 , 11^5 , 13^2 , 17, 19^3 , 31, 37, 41, 43, 47, 61, 71, 151, 163, 181, 197, 271, 2281, 4561, 5419, 178481, 2796203.
- *7) 2^{15} , 3^{15} , 5^4 , 7^3 , 11^5 , 13, 17^2 , 19^3 , 29, 37, 41, 43, 47, 71, 97, 151, 181, 193, 197, 263, 271, 307, 4733, 5419, 178481, 2796203.
- *7) 2^{15} , 3^{21} , 5^3 , 7^3 , 11^2 , 13, 17^3 , 19^4 , 23, 29, 43, 47, 67, 83, 101, 107, 151, 197, 227, 271, 331, 661, 3851, 5419, 137561, 178481, 2796203.
- *7) 2^{16} , 3^{15} , 5^3 , 7^8 , 11, 13, 17^2 , 19^2 , 23, 31, 37^2 , 41, 61, 89, 97, 127, 193, 307, 1063, 2351, 4513, 442151, 13264529.
- *7) 2^{16} , 3^{17} , 5^5 , 7^7 , 11, 13, 17, 19^2 , 23, 31^2 , 37^2 , 43, 61, 67, 83, 89, 127, 331, 379, 601, 757, 1201, 2351, 4513, 442151, 13264529.
- *7) 2^{16} , 3^{21} , 5^4 , 7^4 , 11, 13, 17, 19, 23^2 , 31, 37, 61, 67, 71, 79, 83, 89, 107, 331, 467, 661, 2351, 2801, 3851, 4513, 442151, 13264529.
- *6) 2^{20} , 3^4 , 5^4 , 7^4 , 11^3 , 13^3 , 17^2 , 31, 61, 67, 103, 139, 307, 467, 2143, 2801, 11119, 131071.
- 6) 2^{20} , 3^4 , 5^4 , 7^3 , 11^3 , 13, 17, 31, 61, 67, 71, 103, 139, 2143, 11119, 131071.
- 6) 2^{20} , 3^5 , 5^4 , 7^3 , 11, 13^2 , 17, 31, 61, 67, 71, 103, 139, 2143, 11119, 131071.
- *6) 2^{20} , 3^6 , 5^3 , 7^2 , 13^2 , 17, 19, 23, 31, 61, 67, 103, 137, 139, 547, 1093, 2143, 11119, 131071.
- *6) 2^{20} , 3^6 , 5^3 , 7^4 , 11, 13^3 , 17^2 , 23, 67, 103, 137, 139, 307, 467, 547, 1093, 2143, 2801, 11119, 131071.

- 6) 2^{50} , 3^0 , 5^4 , 7^3 , 11, 13, 17, 23, 67, 71, 103, 137, 139, 547, 1093, 2143, 11119, 131071.
- *6) 2^{50} , 3^{10} , 5^3 , 7^2 , 13^2 , 17, 19, 23, 31, 61, 67, 103, 107, 139, 2143, 3851, 11119, 131071.
- *6) 2^{50} , 3^{10} , 5^3 , 7^4 , 11, 13^3 , 17^2 , 23, 67, 103, 107, 139, 307, 467, 2143, 2801, 3851, 11119, 131071.
- 6) 2^{50} , 3^{10} , 5^4 , 7^3 , 11, 13, 17, 23, 67, 71, 103, 107, 139, 2143, 3851, 11119, 131071.
- *6) 2^{51} , 3^{15} , 5^6 , 7^3 , 11, 17, 19^2 , 41, 43, 53, 79, 97, 127, 157, 193, 257, 269, 683, 1613, 2731, 8191, 19531.
- *6) 2^{51} , 3^{17} , 5^5 , 7^8 , 13, 17, 19^2 , 31, 37^2 , 53, 67, 79, 127, 157, 269, 379, 683, 757, 1063, 1613, 2731, 8191.
- *5) 2^{51} , 3^{19} , 5^6 , 11^4 , 19^2 , 31, 43, 53, 61, 79, 127, 157, 179, 197, 257, 269, 683, 1181, 1613, 2731, 3221, 8191, 19531.
- *6) 2^{51} , 3^{21} , 5^3 , 7^2 , 13, 17, 19^2 , 23, 53, 67, 79, 83, 107, 127, 157, 269, 331, 661, 683, 1613, 2731, 3851, 8191.
- *6) 2^{51} , 3^{21} , 5^4 , 7, 11, 17, 19, 23, 53, 67, 71, 79, 83, 107, 157, 269, 331, 661, 683, 1613, 2731, 3851, 8191.
- *7) 2^{51} , 3^{21} , 5^4 , 7^5 , 11, 13, 17, 19^4 , 29, 37, 41, 43^2 , 53, 71, 73, 79^2 , 101, 157, 227, 269, 463, 631, 683, 1613, 2731, 6481, 8191, 137561.
- *7) 2^{52} , 3^{15} , 5^3 , 7^2 , 11^3 , 13, 17, 19^2 , 31, 37, 41, 43, 53, 61, 79, 97^2 , 127, 157, 193, 263, 313, 317, 2503, 3169, 3181, 6361, 69431, 485581, 20394401.
- *6) 2^{56} , 3^{11} , 5^7 , 7^8 , 13^3 , 17^3 , 19^2 , 29, 37^2 , 67, 73, 79, 127, 157, 313, 1063, 1619, 16189, 32377, 524287, 1212847.
- *6) 2^{56} , 3^{14} , 5^5 , 7^9 , 11^4 , 13^3 , 17^2 , 31, 41, 163, 179, 191, 307, 467, 1619, 2281, 2801, 3221, 4561, 16189, 32377, 524287, 1212847.
- *7) 2^{59} , 3^{23} , 5^7 , 7^6 , 11^2 , 13^4 , 19^5 , 29^3 , 31^2 , 37, 41^2 , 53, 61, 73, 79, 83, 151, 157, 181, 191, 211, 263, 313, 331^2 , 421, 431, 463, 661, 1321, 1723, 1889, 4733, 6481, 30941.
- 2) 2^{59} , 2305843009213693951. (Seelhoff, Pervusin.)
- 6) 2^{61} , 3^5 , 5^6 , 7^3 , 11, 13, 19, 23, 43, 59, 79, 157, 257, 19531, 43331, 3033169, 715827883, 2147483647.
- *5) 2^{61} , 3^7 , 5^5 , 7^3 , 23, 31, 41, 59, 79, 157, 43331, 3033169, 715827883, 2147483647.
- 6) 2^{61} , 3^8 , 5^4 , 7^2 , 11, 13, 19^2 , 23, 59, 71, 79, 127, 157, 379, 757, 43331, 3033169, 715827883, 2147483647. (Cunningham.)

- *6) 2^{61} , 3^9 , 5^2 , 7^5 , 11^2 , 19^2 , 23 , 31^2 , 43^2 , 59 , 61 , 79^2 , 83 , 127 , 157 , 331 , 631 ,
43331, 3033169, 715827883, 2147483647.
- *6) 2^{61} , 3^9 , 5^4 , 7^7 , 11^3 , 13 , 23 , 43^2 , 59 , 61^2 , 71 , 79^2 , 97 , 157 , 601 , 631 , 1201 ,
43331, 3033169, 715827883, 2147483647.
- *6) 2^{61} , 3^{11} , 5^5 , 7^4 , 13^2 , 19 , 23 , 31^2 , 37 , 59 , 61 , 73 , 79 , 83 , 157 , 331 , 467 , 2801 ,
43331, 3033169, 715827883, 2147483647.
- *7) 2^{67} , 3^{15} , 5^7 , 7^7 , 11^2 , 13 , 17 , 19 , 23 , 41 , 43 , 47 , 53 , 79 , 83 , 97 , 137 , 157 , 193 ,
313, 331 , 601 , 953 , 1201 , 13159 , 26317 , 43691 , 131071 .
- *7) 2^{75} , 3^{21} , 5^6 , 7^9 , 11^3 , 13 , 17^2 , 19^3 , 23 , 37 , 43^2 , 67 , 79^2 , 97 , 107 , 139 , 181^2 ,
191, 199 , 229^2 , 257 , 307 , 331^2 , 457 , 467 , 631 , 661 , 2617 , 2801 , 3851 ,
5233, 11939 , 19531 , 43691 , 174763 , 262657 , 524287 , 525313 .
- 2) 2^{88} , 618970019642690137449562111. (Powers.)

Bloomington, Ind.

CONCERNING SPHERIC GEOMETRY.

BY DAVID A. ROTHROCK.

(Abstract.)

In this paper is developed a system of analytic geometry upon the surface of a sphere, in which the axes of reference are great circles and the coördinates of a point are arcs of great circles. With a proper choice of axes, the equations of the loci known as spheric straight line, spheric circle, spheric ellipse, spheric hyperbola, spheric parabola defined metrically as in plane analytics, appear in a form analogous to their equations in the plane.

The paper also investigates other loci of more complex character, together with a discussion of the notion of spheric pole and polar, radical axis, etc. A summary of the literature upon this system of geometry is also included.

Bloomington, Indiana,

November 30, 1911.

ON THE REPRESENTATIONS OF A NUMBER AS THE SUM OF CONSECUTIVE
INTEGERS.

BY T. E. MASON.

(Abstract.)

Theorem :

If we define a series of consecutive integers so as to include zero and negative numbers and if we consider a number itself as a series of consecutive integers with one term, then a number

$$m = 2^a \cdot p_1^{a_1} \cdot p_2^{a_2} \cdot \dots \cdot p_r^{a_r},$$

where the p 's are the odd prime factors of m and the a 's the power to which they occur, may be expressed as the sum of a series of consecutive integers in

$$2(a_1+1) \ (a_2+1) \ \dots \ (a_r+1)$$

ways. When $m = 2^n$ it may be so expressed in two ways.

One-half of the total number of series will have an even number of terms and one-half will have an odd number of terms.

One-half of the total number of series will consist of all positive terms and one-half the number of series will contain zero or zero and negative terms.

We shall now apply this theorem to express 15 as the sum of consecutive integers.

$$15 = 3 \times 5.$$

The number of series will be

$$2(1+1) \ (1+1) = 8.$$

<i>No. of terms.</i>	<i>Mid terms.</i>	<i>Series.</i>
1	15	15
3	5	4+5+6
5	3	1+2+3+4+5
15	1	-6-5-4-3-2-1+0+1+2+3+4+5+6+7+8
2	7,8	7+8
6	2,3	0+1+2+3+4+5
10	1,2	-3-2-1+0+1+2+3+4+5+6
30	0,1	-14-13....-4-3-2-1+0+1+2+3+4+5+....+14+15

Indiana University,

November, 1911.

[18—29034]

APPLICATION OF THE CAUCHY PARAMETER METHOD TO THE SOLUTION
OF DIFFERENCE EQUATIONS.

BY T. E. MASON.

In the application of the Cauchy parameter method to the solution of difference equations the following are the necessary steps:

1) Break the equation up into two parts, one of which gives a part $f_1(x)$ which may be readily solved and multiply the other part of the equation by the parameter t , so that the equation

$$f(x)=0$$

becomes

$$(a) \quad f_1(x)+tf_2(x)=0.$$

2) Assume a solution of the form

$$U(x)=A(x)+B(x)t+C(x)t^2+D(x)t^3+\dots$$

3) Substitute in the equation (a) and equate the coefficients of the different powers of t to zero and solve. Then the parameter t is made equal to 1.

4) The solution

$$U(x)=A(x)+B(x)+C(x)+D(x)+\dots$$

must be shown to be convergent and to satisfy the original equation.

In breaking up the equation it is necessary to make such division that the resulting solution is convergent. In equations with constant coefficients the solution of the resulting equations is, in general, no easier than the solution of the original equation, so that this method of solution is of little or no value there.

By a proper division of the equation the method of Cauchy will give the same results as the method of successive approximations. Let us illustrate this by means of the example

$$\Delta U(x) = \Phi(x)U(x),$$

where*

$$\Phi(x) = \Phi''x^{-2} + \Phi'''x^{-3} + \dots$$

*The general linear homogeneous difference equation of first order may be transformed to this form by a transformation of the form

$$g(x) = x^\alpha a^x x^m f(x),$$

where the α , a and m are constants to be determined for the particular equation.

Let us write

$$\Delta U(x) - t\phi(x)U(x) = 0$$

and assume for the solution

$$U(x) = A(x) + B(x)t + C(x)t^2 + D(x)t^3 + \dots$$

Then

$$\Delta U(x) = \Delta A(x) + \Delta B(x)t + \Delta C(x)t^2 + \Delta D(x)t^3 + \dots$$

Substituting in the equation we have

$$\Delta A(x) + t[\Delta B(x) - \phi(x)A(x)] + t^2[\Delta C(x) - \phi(x)B(x)] + t^3[\Delta D(x) - \phi(x)C(x)] + \dots = 0.$$

Equating the coefficients of the powers of t to zero we have

$$\begin{aligned} \Delta A(x) &= 0 \\ \Delta B(x) - \phi(x)A(x) &= 0 \quad \text{or} \quad \Delta B(x) = \phi(x)A(x) \\ \Delta C(x) - \phi(x)B(x) &= 0 \quad \text{or} \quad \Delta C(x) = \phi(x)B(x) \\ \Delta D(x) - \phi(x)C(x) &= 0 \quad \text{or} \quad \Delta D(x) = \phi(x)C(x) \\ &\dots \end{aligned}$$

Solving we have

$$\begin{aligned} A(x) &= 1 \\ B(x) &= S_x \phi(x), \text{ where } S_x \phi(x) = - \sum_{i=0}^{\infty} \phi(x+i) \\ C(x) &= S_x \phi(x) S_x \phi(x) \\ D(x) &= S_x \phi(x) S_x \phi(x) S_x \phi(x) \\ &\dots \end{aligned}$$

$$\therefore U(x) = 1 + S_x \phi(x) + S_x \phi(x) S_x \phi(x) + S_x \phi(x) S_x \phi(x) S_x \phi(x) + \dots$$

This series has been proven to be convergent* and gives a particular solution of the linear homogeneous equation of the first order.

But this parameter method may be applied in such a way as to obtain solutions different from those obtained by the ordinary method of successive approximations. We shall illustrate this remark by the solution of the equation

$$\Delta^2 U(x) - aU(x) = x^{(n)\ddagger}, \quad a < 1.$$

Let us write

$$\Delta^2 U(x) - x^{(n)} - taU(x) = 0$$

and assume the solution

$$U(x) = A(x) + B(x)t + C(x)t^2 + D(x)t^3 + \dots$$

*Carmichael, Transactions American Mathematical Society, Vol. 12, No. 1, p. 101. If in that discussion we put $a=1$, $m=0$, the two problems are identical.

$\ddagger x^{(n)} = x(x-1)(x-2)\dots(x-n+1)$.

Substituting in the equation and equating to zero the coefficients of the powers of t , we have

$$\begin{aligned} \Delta^2 A(x) - x^{(n)} &= 0 & \text{or} & & \Delta^2 A(x) &= x^{(n)} \\ \Delta^2 B(x) - aA(x) &= 0 & \text{or} & & \Delta^2 B(x) &= aA(x) \\ \Delta^2 C(x) - aB(x) &= 0 & \text{or} & & \Delta^2 C(x) &= aB(x) \\ \Delta^2 D(x) - aC(x) &= 0 & \text{or} & & \Delta^2 D(x) &= aC(x) \\ \dots\dots\dots & & & & \dots\dots\dots & \\ \dots\dots\dots & & & & \dots\dots\dots & \\ \Delta^2 A(x) &= x^{(n)} & & & & \end{aligned}$$

$$\Delta A(x) = \frac{x^{(n+1)}}{n+1} + p_1(x)$$

$$A(x) = \frac{x^{(n+2)}}{(n+2)^{(2)}} + p_1(x) \cdot x + p_2(x)$$

$$\Delta^2 B(x) = \frac{ax^{(n+2)}}{(n+2)^{(2)}} + ap_1(x) \cdot x + ap_2(x)$$

$$B(x) = \frac{ax^{(n+4)}}{(n+4)^{(4)}} + ap_1(x) \frac{x^{(3)}}{3!} + ap_2(x) \frac{x^{(2)}}{2!}$$

$$\Delta^2 C(x) = \frac{a^2x^{(n+4)}}{(n+4)^{(4)}} + a^2p_1(x) \frac{x^{(3)}}{3!} + a^2p_2(x) \frac{x^{(2)}}{2!}$$

$$C(x) = \frac{a^2x^{(n+6)}}{(n+6)^{(6)}} + a^2p_1(x) \frac{x^{(5)}}{5!} + a^2p_2(x) \frac{x^{(4)}}{4!}$$

.....

$$\therefore U(x) = \frac{x^{(n+2)}}{(n+2)^{(2)}} + \frac{ax^{(n+4)}}{(n+4)^{(4)}} + \frac{a^2x^{(n+6)}}{(n+6)^{(6)}} + \dots + p_1(x) \left[x + \frac{ax^{(3)}}{3!} + \frac{a^2x^{(5)}}{5!} + \frac{a^3x^{(7)}}{7!} + \dots \right] + p_2(x) \left[1 + \frac{ax^{(2)}}{2!} + \frac{a^2x^{(4)}}{4!} + \frac{a^3x^{(6)}}{6!} + \dots \right].$$

Since $a < 1$ these series converge, and it can readily be shown by substitution that this does afford a solution of the equation.

If we denote the solution of the previous equation by $U^{(n)}(x)$, then the solution of the equation

$$\Delta^2 U(x) - aU(x) = P(x), \quad a < 1,$$

where $P(x)$ is a polynomial in x of the form

$$P(x) = a_0 + a_1x^{(1)} + a_2x^{(2)} + a_3x^{(3)} + \dots + a_mx^{(m)},$$

may be written in the form

$$U(x) = \sum_{n=0}^m a_n U^{(n)}(x).$$

The $2m+2$ periodic functions combine into 2 independent ones.

The solution of other examples would follow the same method.

Bloomington, Ind.

SOME VARIATIONS IN PLANTS.

BY F. M. ANDREWS.

In the proceedings of the Indiana Academy of Science for 1905 and 1909 I have mentioned some variations in plants. Some of those have been noted and studied by de Vries, who considered the subject of such importance as to undertake its further study.

Flattened stems of various kinds are not infrequently found and sometimes twisted stems also. The latter de Vries¹ has noted in wild teasels and he was able by selection and cultivation to increase the percentage of plants of teasel having this peculiarity.

One instance of stem flattening, not due to a traumatic effect, is that of the blackberry. The stems of this plant are ordinarily more or less rounded in transverse outline and it would be interesting to see if this monstrosity could be increased in any way in plants grown from them as in teasels.

This same tendency to produce occasionally flattened parts occurs in dandelions. De Vries² was able to increase in various plants the percentage of flattened stems. Not infrequently the scapes of the dandelion are so united with others and so flattened as to be more than a centimeter in width.

Likewise deviations are often shown in the flowers of dandelions. This is especially seen in the union of two or more heads of flowers. Two, three and once five of flowers were more or less united into one and produced by this means a rather confused and irregular mass of many flowers. Here also was a flattening of the more or less perfectly united scapes. A sunflower which had several heads fused into one very large and curiously shaped mass was observed.

The union, however, of most flowers or branches in the neighborhood of one another are always of rare occurrence, as De Vries³ has mentioned is the case with most plants. An exception to this is seen in the case of

¹ De Vries—Species and Varieties, their Origin by Mutation. 1905, pp. 404, 405.

² De Vries—Species and Varieties, their Origin by Mutation. 1905, p. 411.

³ De Vries—Species and Varieties, their Origin by Mutation. 1905, p. 428.

some plants, however, which show a decided tendency to bring about a union of fruits, as in the strawberry, several of whose fruits and leaves at times grow together.

Deviations as to the time of the blooming of flowers are sometimes noticed. In Bloomington an apple tree that, besides blooming profusely during the regular time in spring, has two years bloomed twice each year. After blooming in the spring it produced a few blossoms again in August and September of the same year. After blooming the next spring an increased number of blossoms were produced in August and September as compared with the same time the preceding year.

It is well known that apple trees often bloom a second time in the fall in very dry seasons, but in this case the climatic conditions were just the reverse.

It will be interesting to see what this tree will continue to do in this respect. At the time that the second period of blossoming occurred the tree was bearing a fairly good crop of apples from the first blooms. The same may be seen in many other plants at times, as in violets, horse-chestnuts, anemones, gentians, redbuds, some primulas¹ and weigela.

The sudden and complete transformation of color in flowers from the normal sometimes occurs, as in *Achillea millifolium*, where the rays are pink instead of white.

The same is true of the common yellow adder's-tongue (*Erythronium Americanum*) which sometimes, though rarely, produces purple instead of the usual yellow flowers. When found such specimens should be transferred to a rich garden (if it is not possible to guard and grow them in their native habitats, which would be better) and cultivated and closely watched and protected in order to see whether they would reproduce the monstrosities again or even to a greater extent.

Apparent monstrosities are sometimes caused not naturally by the plant but are frequently caused by some sort of traumatic effect. This I have repeatedly seen in plants. Especially is this true in the more hardy plants that are able to bear a rather considerable injury without a fatal termination. The common iron weed (*Vernonia fasciculata*) shows frequently a branching only a short distance above the ground and below the usual branching, if partly crushed or otherwise injured.

Another instance of an apparent monstrosity, is the change brought

¹ Kerner, Vol. 1, p. 564.

about in *Ambrosia artemisiifolia* due to traumatic causes, as shown by A. C. Life.¹ This plant was injured by a wagon running over it and showed a number of abnormal conditions in which the reproductive primordia had a tendency to change into vegetative parts.

It is well, therefore, on finding any monstrosities of any kind to consider and inquire into the cause or source of the deviation and to try to ascertain whether these deviations are traumatic in origin or are inherent in the plant itself for some other reason.

¹A. C. Life, *Botanical Gazette*, 1904, Vol. 38, pp. 383-384.

Bloomington, Indiana.

REPORT OF THE WORK IN CORN POLLINATION, III.

M. L. FISHER.

A brief resume may be helpful. In 1908 a series of studies in corn pollination was begun. Of these studies two were reported to this society at the 1908 meeting. One of these dealt with the vitality of pollen as affected by age. The other dealt with the results of cross-pollinating varieties of different colors also, the crossing of sweet and dent corn. Seed obtained from these crosses was used for planting in 1909. The results of this planting were reported at the 1910 meeting. In brief they showed an agreement with Mendelian principles.

In 1910 seed was selected from the various types developed in 1909. For example, from ears which showed white and yellow dent, and sweet kernels all on the same cob, the white kernels were picked out and planted separately; the same was done with the yellow dent and sweet kernels. In all sixteen different selections were made. These were planted in single rows side by side and given similar treatment in every way. Hand pollination was resorted to as in the two previous years. It may be said here that after three years of self-pollination there was not the marked deterioration which breeders have told us would happen from such in-breeding.

A full account of the results of this experiment may not be given in this place, but the following observations are presented:

1. The effect of using Reid's Yellow Dent as a male on Boone County White was to increase the height of the stalk noticeably, while the reciprocal cross showed a sturdier stalk than is usual with either variety.

2. Sweet corn as either parent induced an abundance of suckers. The average for six different rows in which the seed used had some sweet in it was 47.5 per cent. of the stalks being suckered, some stalks having as many as six to eight. Also, where Reid's Yellow Dent was the male, the per cent. of suckers was large, amounting to 42.6 per cent. of all the stalks, while the reciprocal gave only 9.6 per cent. It is well known that sweet corn normally produces many suckers, and under favorable conditions Reid's Yellow Dent produces more than most dent varieties.

3. The Sweet-Reid's Yellow Dent and the Reid's Yellow Dent-Boone County White crosses which had the largest per cent. of suckered stalks also showed the largest per cent. of twin ears and the smallest per cent. of barren stalks. It may not be accepted that suckers are an indication of prolificacy, but this series of experiments indicated as much.

4. This being the third year of the experiment the constancy of dominants and recessives would be expected to show itself. Sweet, red, speckled, and white are supposed to be recessive to dent and yellow. In 18 self-pollinated ears from sweet, 15 were pure sweet and 3 mixed white, sweet, and yellow. In 12 ears from speckled seed, 9 were pure speckled, 2 pure yellow, and 1 pure red. In 15 ears from red seed, 13 were pure red and 2 pure yellow. However, in none of the pollinations from white seed was the percentage of pure ears so high. The highest being from the white seed selected from the Sweet-Reid's Yellow Dent cross, in which 7 out of 12 ears were pure.

In the experiments of 1908 yellow showed itself dominant to all other colors, consequently it would contain not only the dominants but the hybrids and such a condition manifested itself in the various selection from yellow seed. A notable exception was from a row planted with yellow seed from a twin ear. Every self-pollinated ear from this row was pure yellow.

5. From the Sweet-Reid's Yellow Dent cross two types arose, one with whitish kernels and white cobs, like the original Stowell's Evergreen, and the other with yellowish kernels and red cobs. These two types were planted in 1911 on the grounds of the Horticultural Department, Purdue University. The season being backward the crop was not large, but enough was obtained to show that the types were fixed and would breed true.

*Purdue University,
LaFayette, Ind.*

NEW AND NOTABLE MEMBERS OF THE INDIANA FLORA.

 E. J. GRIMES.

The following notes deal with the distribution and the ecological condition of the species mentioned. They pertain for the most part to the flora of Putnam County.

The determinations have been verified by authorities, and the specimens are deposited in the National Herb., Gray Herb., and my herbarium.

The nomenclature follows the Vienna Code as exemplified in the seventh edition of Gray's Manual.

The seventeen species and varieties that are recorded as new to the Indiana flora are marked with an asterisk (*).

Ophioglossum vulgatum L.

Putnam County. Four miles south of Russellville a large colony of this plant was found June 4, 1911, on a wooded hillside along Raccoon Creek.

The plants were very thrifty, from 24 to 32 cm. in height, the leaves 3.5-4 cm. wide, and 6-7 cm. long. The sterile regments were attached below the middle.

Woodsia obtusa (Spreng.) Torr.

Putnam County. Grows sparingly on sandstone ledges. September 4, 1911.

Aspidium noveboracense (L.) SW.

Parke County. Low woods in moist soil. Small colony was found one mile north of Ferndale, September 11, 1910.

Asplenium Thrichomanes L.

Putnam, Parke and Montgomery counties. Frequent on dry sandstone ledges, found with *Polyodium vulgare*.

**Marsilea quadrifolia* L.

Putnam County, south of the Vandalia station at Greencastle in an old pond. This species is quite abundant on one side of the pond, but is rapidly disappearing, due to the draining of the pond and the subsequent encroaching of the vegetation, which is filling up the pond and eventually choking out the *Marsilea*. This plant was first detected by Dr. Banker of De Pauw University in 1904. Possibly introduced by some botanist.

**Paspalum stramineum* Nash.

Putnam County. Open, dry hillsides and along railways, October 4, 1911. The range as given in Gray's Manual is Nebraska to Missouri and southward.

Panicum huachucae Ashe.

Putnam County, dry open hillsides, June 11, 1911. Reported from Indiana at Clarke Junction (Bebb), Gibson (Hill), (Hitchcock and Chase.)—(N. A. Species of *Panicum*, p. 216).

Aristida tuberculosa Nutt.

Putnam County, along old Big Four Railway, August 8, 1911. "In sandy soil along the lake beach. Lake (Hill)."—(State Catalog, p. 633.)

Diarrhena diandra (Michx.) Wood.

Rich soil in a wooded ravine along Raccoon Creek, Putnam County, July 9, 1911. Reported only from counties bordering the Ohio River and lower Wabash.

Bromus purgans L.

Putnam County, rich hillside along Raccoon Creek. First detected as a member of our flora by G. W. Wilson.—(Proc. Ind. Acad. Sci. 1905, 166.)

Cyperus aristatus Rottb.

Southern part of Putnam County on wet sandy shore of Mill Creek, August 10, 1911.

**Eleocharis palustris glaucescens* (Willd.) Gray.

Putnam County, one mile east of Russellville, in ditch along C., H. & D. Railway. In flower May 22, 1911.

Carex cristata Schwein.

Putnam County, three and one-half miles south of Russellville, in Everman's Swamp along Raccoon Creek, June 11, 1911, with *Carex stipata*, *C. cephalophora* and *Scirpus validus*.

**Carex virescens Swanii* Fernald.

Putnam County, on rocky, wooded hillside at Fern, August 8, 1911.

**Juncus effusus solutus* Fernald and Weigand.

Putnam County, near Limesdale, in an abandoned rock quarry, October 5, 1911.

Maianthemum canadensis Desf.

Putnam County, two miles northeast of Bainbridge, on dry hillside, associated with *Tsuga canadensis*, June 25, 1911. Most southern station known in the State.

Ranunculus circinatus Sibeth.

Putnam County, three miles east of Russellville. It is abundant in a bayou of Raccoon Creek. In flower May 22, 1911. Reported only from Hamilton County.—(State Catalog, p. 757.)

Conringia orientalis (L.) Dumort.

Putnam and Montgomery counties, along the Monon R. R. In flower May 6, 1911. First reported by G. W. Wilson.—(Proc. Ind. Acad. Sci. 1905; 171.) Becoming more abundant each year.

**Sisymbrium officinale leiocarpum* DC.

Putnam County in cultivated grounds with the type, but far more abundant.

**Hesperis matronalis* L.

Montgomery County, along roadside near Crawfordsville, August 11, 1911.

**Hydrangea cinerea* Small.

Posey County, July 7, 1910 (C. C. Deam); Montgomery County (Deam and Grimes), July 23, 1911. Putnam County, two miles northeast of Bainbridge, on Knobstone shale along Walnut Creek. In flower August 15, 1911. Flowering later than *H. arborescens*, this is the predominating species wherever found. The range in Gray's Manual is South Carolina and Georgia to Tennessee and Missouri.

**Pyrus ioensis* (Wood) Bailey.

Putnam County, two miles west of Greencastle, on embankment of old Big Four Railway. Fruit was collected from a single individual about eight feet tall, August 27, 1911.

**Crataegus pruinosa* (Wendl) K. Koch.

Putnam County, on dry wooded hillside along Raccoon Creek. This is the first species in our area to ripen its fruit, mature fruit having been collected July 30, 1911.

**Geum flavum* (Porter) Bicknell.

Putnam County, four miles south of Russellville, in moist wooded ravine near Raccoon Creek. Taken at only one other station. Infrequent, July 10, 1910.

Rosa blanda Ait.

Putnam County, near Greencastle, on dry bank along Big Four Railway, in full flower June 4, 1911. "In a few localities in the rocky hills of the southern counties."—(State Catalog, p. 789.)

Desmanthus illinoensis (Michx.) MacM.

Putnam County, on embankment of old Big Four Railway, west of Greencastle, August 8, 1911. Well established at two stations along the railway. "I have seen specimens from no other region (Clark County). In my opinion the form is of rare occurrence in the southern and south-western counties. If found it would probably be on alluvial banks or in prairies."—(State Catalog, p. 819.) Possibly a migrant in Putnam County.

Strophostyles pauciflora (Benth.) Wats.

Putnam County, near Fern, along the old Big Four Railway. This interesting species is frequent along the roadside for about a quarter mile, where it is associated with *Euphorbia heter ophylla*, *Medicago sativa* and *Aristada tuberculosa*. The leaves varied from 2-4.5 cm. long, the pods were from 2 to 2.5 cm. long and 5 mm. wide. Stipules 3 mm. long. The peduncles varied from 2 to 10 cm. long, the seeds were grayish brown in color and 3-3.5 mm. long.

The most northern station known in Indiana, having been reported only from Gibson and Posey counties, where Dr. Schneck recorded it as rare.

Croton glandulosus septentrionalis Muell. Arg.

Putnam County, three miles west of Greencastle on right of way of old Big Four Railway. Flowering and fruiting specimens collected August 27, 1911. Local and rare. Previously reported only from Daviess County.

Croton monanthogynus Michx.

Putnam County, frequent five miles west of Greencastle along old Big Four Railway. August 8, 1911.

Hypericum Ascyron L.

Putnam, Parke and Montgomery counties, in alluvial soil and on banks of streams. A beautiful species deserving cultivation.

**Vaccinum corymbosum amoenum* (Ait.) Gray.

Montgomery County, on Devil's Back Bone at Pine Hills. Collected in fruit July 23, 1911. A single individual about one meter tall, grows on the very dry ledge, associated with *Tsuga canadensis*.

**Ligustrum vulgare* L.

Montgomery County, along roadsides and in waste places. June 25, 1911.

**Asclepias Sullivantii* Engelm.

Putnam County, one mile west of Bainbridge, in a pasture. In full flower, June 25, 1911. Two additional stations have since been detected near Russellville, associated with *A. syriaca*.

Verbena angustifolia Michx.

Putnam County, in a ditch along the C., H. & D. Railway near Russellville. In flower July 10, 1911.

**Verbascum Blattaria albiflorum* Ktze.

Putnam and Montgomery counties. Common in old fields and pastures. The form with purplish corolla is frequent throughout the State, while the type with yellow corolla is infrequent or rare.

Ruellia ciliosa Pursh.

Putnam County, four miles south of Bainbridge along the Monon Railway. In flower August 14, 1911. Less frequent than *R. strepens*.

Viburnum molle Michx.

Putnam County, three and half miles south of Russellville, on rich wooded hillside along Raccoon Creek. Collected in flower June 14, and mature fruit September 4, 1911. Frequent throughout the county on wooded slopes adjoining streams. A shrub 3-4 m. high, easily recognized by its gray exfoliating bark.

Erigeron divaricatus Michx.

Putnam and Parke counties, on dry exposed hillsides. Abundant wherever found. I have seen this species in Russell and Washington townships in Putnam County, and near Ferndale in Parke County. "Reported only from the extreme southern part of the State, where it is found on the banks of streams."—(State Catalog, p. 978.)

Antennaria fallax Greene.

Putnam County, three miles south of Russellville. Poor soil on dry hillside. April 30, 1911. Previously taken by H. H. Bartlett in Marion County.—(Proc. Ind. Acad. Sci., 1904; 303.)

**Antennaria neglecta* Greene.

Putnam County, three and half miles south of Russellville. Poor soil in an old field, April 30, 1911. More frequent than the preceding species.

**Galinsoga parviflora hispida* DC.

Putnam County, in town of Russellville, in cultivated grounds, August 18, 1911. Associated with *Malva rotundifolia*.

Russellville, Ind., December, 1911.

A MONOGRAPH OF THE COMMON INDIANA SPECIES OF HYPOXYLON.

CHARLES E. OWENS.

It is the purpose of this paper not to present an exhaustive treatise on the genus *Hypoxylon*, but to give a brief account of the habit and habitat of these fungi as the writer has observed them, together with a key to the species which have been collected in this State. Descriptions of the species covered by the key have also been included.

The *Hypoxylons*, like most other fungi, have a vegetative phase which grows hidden in the substratum, and a fruiting phase which grows on the surface of the host for the purpose of facilitating the dissemination of the spores. The essential part of this fruiting body consists of from one to many perithecia which contain the spore-bearing asci. The perithecia are usually aggregated in clusters and imbedded in a carbonaceous crust known as a stroma. The stroma is more or less conspicuous and varies greatly in form and size. Sometimes it may take the form of a broadly effused crust several inches or even many feet in extent; again it may be a globose, subglobose, or hemispherical structure varying in size from a single perithecium approximately 1 mm. in diameter, to a large stroma 1 to 2 cm. in diameter and containing numerous perithecia. The perithecia are usually arranged peripherally in a single, regular or irregular layer. Sometimes, however, they are crowded into several more or less irregular layers, so that the spore-bearing layer of the stroma may be several times the thickness of a single perithecium. The stromata are usually of a carbonaceous nature, but sometimes they are woody or corky-fibrous. The color of the substance is generally dark-brown or black; while that of the surface exhibits a range from whitish or gray, through various shades of red, ferruginous and purple, to black.

Without exception, the species of this genus are saprophytic and live upon the dead trunks, branches and rotten wood of various kinds of trees. They prefer the shade and moisture of the woods and are seldom found in the open where they would be exposed to direct sunlight for a large part of the day. Certain species, however, are sometimes found around the edge of woodlands where they are not shaded at all times. This is es-

pecially true during rainy seasons. Some species are found upon the dead bark of trees and branches which are not in an advanced stage of decay. Others are usually found upon decorticated wood which is still sound. Still others seem to prefer wood which is very rotten. Occasionally a species is found which seems to flourish equally well under any or all of these conditions. Especially is this true of certain species which grow in great profusion both on sound bark and decorticated wood.

It is thus evident from the very nature of this group of fungous plants that they are of very little, if any, economic importance. Since they are not parasitic, they never cause the death of living plants, and, although true to fungous nature, they aid in the decay of timber already dead, yet, because of the fact that they thrive only in the forest, they are not destructive of timber which has been promptly removed to its proper place of use. The chief interest, then, which attaches to them is a scientific one. Most species of *Hypoxylon* are large and conspicuous in comparison with most other genera of *Pyrenomycetes*, and therefore they attract the attention of the collector. It is perhaps this characteristic more than any other which makes them interesting to the student of fungi.

The *Hypoxylo*ns develop late in the season, passing through the conidial stage during the summer or early autumn. The perfect stage follows the conidial and arrives at maturity sometime during the fall or early winter. The time for collecting mature specimens, then, is during the late autumn or early winter. They persist throughout the winter, however, and may be collected in good condition until the warm weather of spring comes, when they begin to disintegrate rapidly.

In attempting to make a key to the species of *Hypoxylon* a great difficulty is encountered. Perhaps there are few genera of fungi, or even of any group of plants, which offer more difficulty along this line than the genus under consideration. In the first place the genus itself is not set off from all other genera by distinct and unmistakable characters. For example, it would take an expert to distinguish with accuracy between some species of *Nummularia* and certain of the *Hypoxylo*ns. This lack of reliable marks of identity is even more evident when it comes to distinguishing between the various species of *Hypoxylon*.

Most investigators who have worked with this genus have attempted to divide it into groups of doubtful extent on the basis of the form and

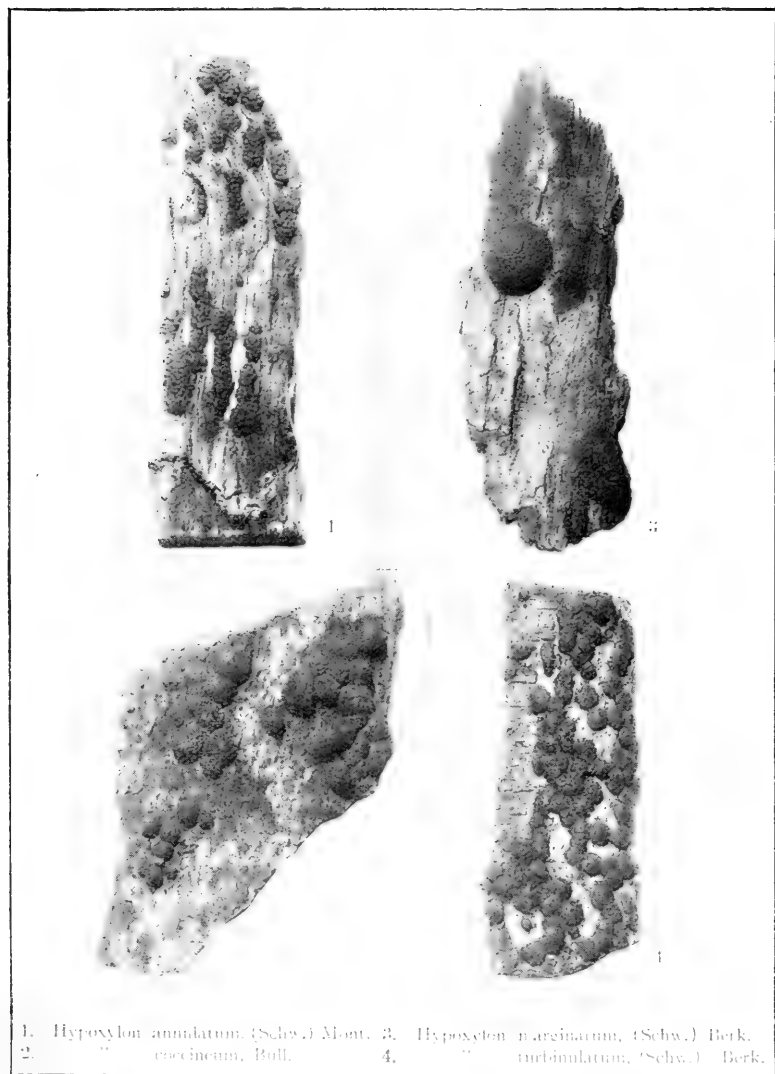

color of the stroma. But this is not entirely satisfactory, because these characters are not at all constant in a great many species. Specimens of a certain species may be found at one time which show the effused form in a very marked degree. Again specimens of the same species may grow in a globose or hemispherical form with scarcely a sign of the effused nature. Similarly the color of the same species may vary greatly under different conditions of growth and with increasing age.

In any given species perhaps the spore measurements are the most constant of any of the characters, and even these vary within certain limits. But the differences between the spore measurements of all the various species are not of wide enough range to be of any great advantage in throwing them into groups which would be usable in a key. It is true that there are a few species here and there which might be thrown out upon the basis of spore size, but the great majority of them range so
o nearly together that it is not feasible to attempt a key upon this basis.

Since it has been our final purpose to make a key which could be used chiefly in the field without the use of the microscope, we have deemed it best to follow, for the most part, the example of former writers. Therefore the more evident, although more superficial and unstable characters have been employed, and the key has been based to a large extent upon the form and external color of the stroma. Although in a few of the ultimate divisions spore measurements have been used, it is hoped that in most cases the student will be able to locate any of the species covered by this key, by means of the naked eye, aided, perhaps, only by the hand lens.

Perhaps not the least valuable aid in identifying species may be found in the accompanying figures. When working with objects which are of such a uniformly dark appearance and which show such little contrast between stroma and substratum as do most of the *Hypoxylons*, it is no easy task to produce photographs which show their form and external appearance to good advantage. The figures appended are from photographs which were taken near a west window with the rays of the afternoon sun falling directly upon the specimens. It is the experience of the writer that this gives more contrast and makes the stromata and the perithecia stand out more prominently in the photograph than is the case when the exposure is made in diffused light.

Sixteen species have been collected thus far and the key has been made to fit the specimens at hand without regard to any others.

The descriptions of species have been taken to a great extent from the original descriptions and comments appended thereto, as given in "North American Pyrenomycetes" by Ellis and Everhart. In nearly all cases, however, the writer has made some changes, and in some instances the whole description has been rewritten to suit the specimens at hand. All measurements of asci and spores are original. Where the measurements given by Ellis and Everhart differ, their figures are given in parentheses. In some cases the measurements given by Saccardo are included also.

The identification of all species covered by this paper has been verified by Dr. Charles H. Peck, State Botanist of New York, who was kind enough to examine all our specimens. In a few cases the species was determined by him. I take this opportunity to express my thanks for his assistance in this work.

I am also indebted to Prof. J. M. Van Hook, of Indiana University, for material placed at my disposal, and for aid and advice in formulating this paper.

KEY TO SPECIES.

- I. Stroma large, irregular, thrown into folds or ridges, spores 8 microns long or less.....1. *H. Petersii*.
- II. Stroma more or less effused.
 - A. Stroma broadly effused.
 1. Externally colored whitish or gray.
 - a. Smooth, whitish, dotted with black ostiola.....2. *H. atropunctatum*.
 2. Externally colored not whitish or gray.
 - a. Perithecia 2/3-1 mm. long, spores 11-13 microns long.....3. *H. atropurpureum*.
 - b. Perithecia 1/2 mm. long, spores 9-11 microns long.....4. *H. rubiginosum*.
 - B. Stroma variously effused or confluent, usually in small areas.
 1. Externally colored not black.
 - a. Surface of stroma bright purple, ostiola not white-margined, spores 12-15 microns long.....5. *H. fuscopurpureum*.
 - b. Surface of stroma brown or slightly purplish, ostiola white-margined, spores 8-11 microns long.....*6. *H. perforatum*.

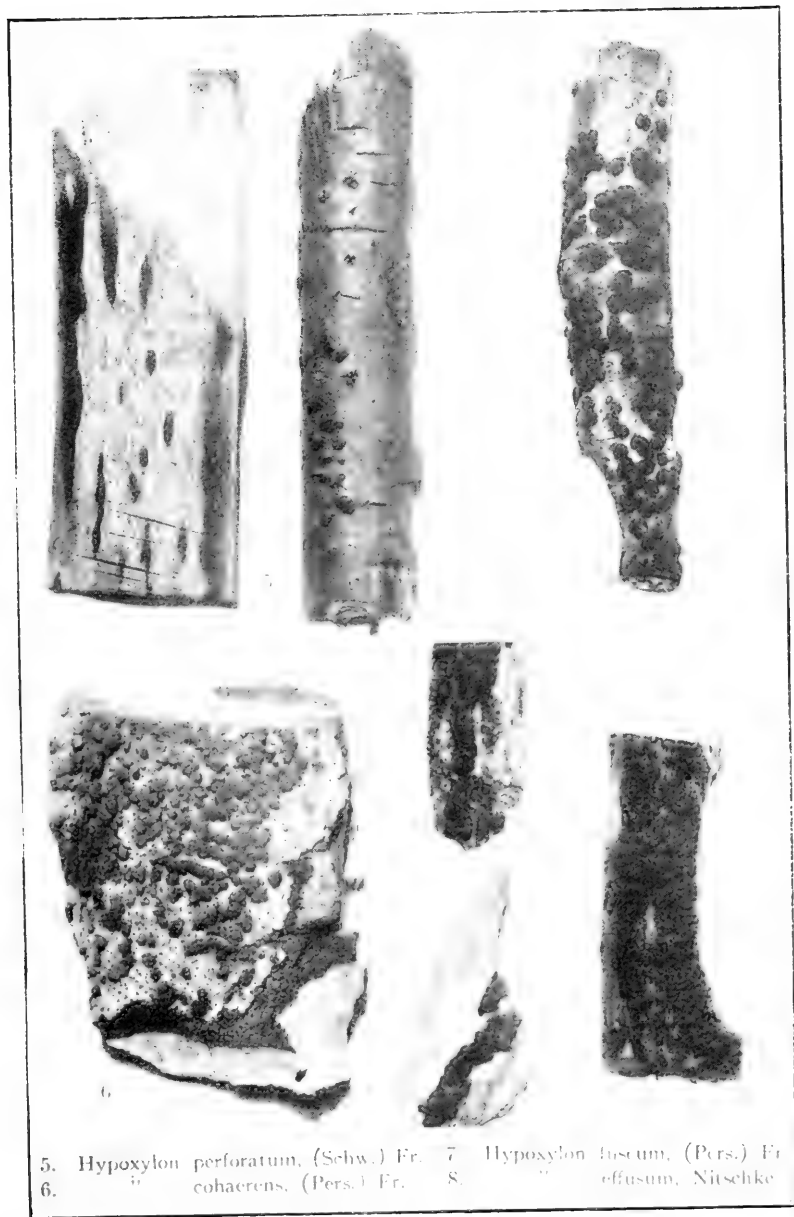

2. Externally colored black.
- a. Stroma scant, composed of large perithecia which are almost solitary, or confluent in variously shaped, thin-crusts patches.
.....7. *H. effusum*.
 - b. Stroma thick or thin, in more or less effused patches 1/2 to 1 or 2 cm. long and wide. (Some very convex forms might be mistakenly placed under III.).....8. *H. multiforme*.
- III. Stroma globose or subglobose.
- A. Externally colored not black.
 1. Stroma globose.
 - a. Substance of stroma concentrically-zoned, radiate-fibrous, spores 8 microns long or less.....9. *H. Howeanum*.
 - b. Substance of stroma homogeneous, spores more than 8 microns long.10. *H. coccinum*.
 - c. Substance of stroma scant, perforate or granular, ostiola white-margined.*6. *H. perforatum*.
 2. Stroma depressed-pulvinate or rounded, surface dark purple.
.....11. *H. fuscum*.
 - B. Externally colored black.
 1. Perithecia annulate-truncate.
 - a. Stroma large, with the small (.5 mm.) perithecia deeply and evenly sunk in the substance of the stroma so that scarcely more than the disk projects, giving a rounded, even appearance.....12. *H. marginatum*.
 - b. Stroma of medium size and irregular from the large (2/3-1 mm.), prominent perithecia, many of which project one half their length beyond the surface of the stroma.....
.....13. *H. annulatum*.
 2. Perithecia not annulate-truncate.
 - a. Stroma scant, perithecia large, solitary or confluent in small, elongated areas in grooves of the bark.....
.....14. *H. sassafras*.
 - b. Stroma roughly subglobose, composed of a few loosely-aggregated perithecia (Usually not over 15 or 20 in a

* *H. perforatum* is sometimes found with the effused form of stroma, and again with a subglobose or hemispherical stroma. In order that the student may not be at a loss to know where to place it in case he should have only the one or the other form, the key has been arranged so that this species will run under either the effused or the globose group.

- stroma).15. *H. cohaerens*.
 c. Stroma flattened above, turbinate narrowed below, bearing numerous (usually over 25), not very prominent perithecia.16. *H. turbinulatum*.

DESCRIPTIONS.

The following descriptions are adapted mainly from "North American Pyrenomycetes" by Ellis and Everhart.

HYPOXYLON, *Bulliard*.

Stroma of carbonaceous or woody-corky consistence, dark-brown or black within, externally ranging from almost white through shades of red, brown or purple, to black, free from the first or erumpent-superficial, sometimes more or less sunk in the wood, globose, subglobose, or more or less effused and crustaceous, at first covered by a conidial growth, finally bare. Perithecia peripheral in a single layer or sometimes in several layers concentrically or irregularly arranged, globose, ovate or oblong, coriaceous or corneo-coriaceous, sunk in a stroma, but generally with the upper part more or less projecting, with a papilliform or umbilicate ostiolum. Asci cylindrical, 8-spored. Spores uniseriate, elliptical or fusoid, inequilateral or curved, continuous, brown.

1. *H. Petersii*, B. & C.

Stroma large, 2.5-6 cm. long, 2.5-4 cm. wide, .75-1.5 cm. thick, ranging in shape from almost circular to oblong or elliptical, convex above, sometimes even, often raised into a few large folds or ridges which usually extend crosswise but occasionally lengthwise of the stroma, centrally attached with a spreading margin free at the sides. In the elliptical forms the attachment extends lengthwise almost from end to end. The surface sometimes exhibits deep cracks. The stroma is covered at first with a thick, leathery, membranaceous veil which soon disappears except around the margin where there persists a leather-colored strip of irregular width which becomes narrower and darker-colored with age. Substance corky, slightly fibrous, brown, upper spore-bearing part blackish-brown, slightly carbonaceous. Perithecia subglobose or sub-elongated, .5-.75 mm. long, with necks ending in papilliform ostiola, arranged in several layers, which in places are so crowded that the layers are not distinct. The entire spore-bearing stratum averages about 5 mm. in thickness. Asci cylin-

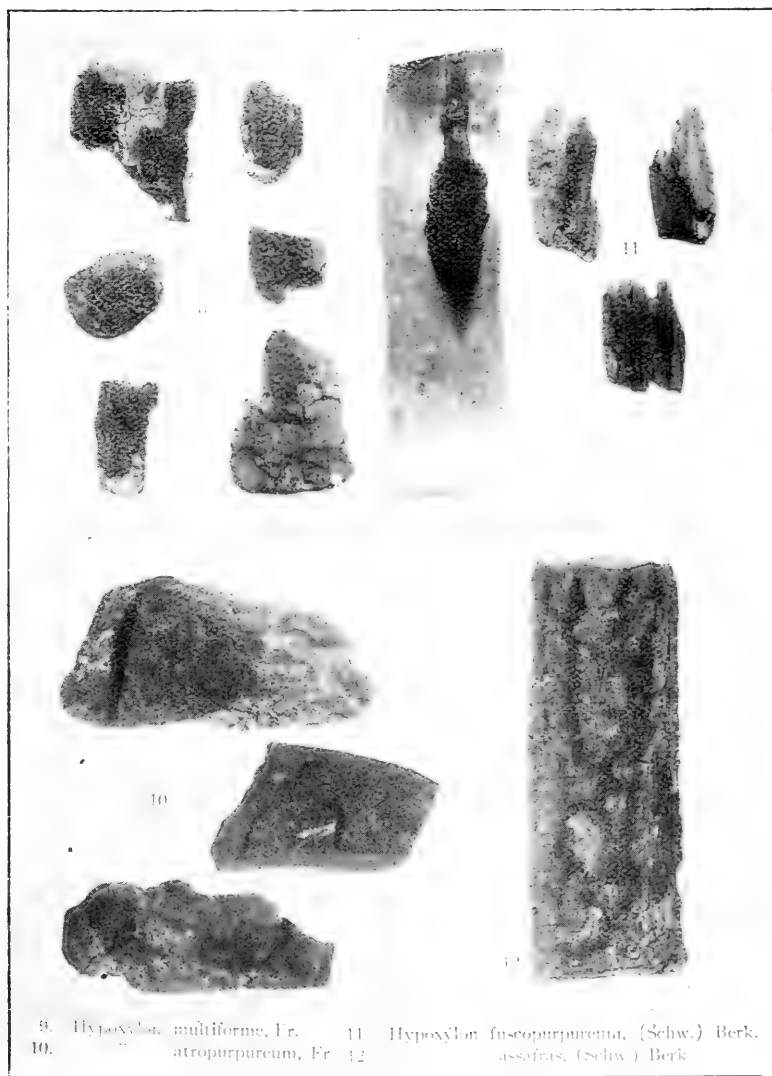

9. *Hypoxylon multiforme*, Fr.
10. " *atropurpureum*, Fr.

11. *Hypoxylon fuscopurpureum*, (Schw.) Berk.
12. " *assafrae*, (Schw.) Berk.

dricul, 60-75 x 5 microns, spore-bearing part 35-40 x 5 microns. Spores uniseriate or sub-biseriate above, elliptical, rather narrow, brown, 7-8 x 3-4 microns.

On rotten log of *Quercus*, Huckleberry Woods, near Bloomington, Indiana.

2. *H. atropunctatum*, (Schw.) Cke.

Sphaeria atropunctata, Schw.

Anthostoma atropunctatum, Sacc.

Hypoxyton atropunctatum, Cke.

Stroma very broadly effused, forming a thin (.75-1 mm.), smooth, whitish or gray crust which is flush with the surface of the surrounding bark, irregularly dotted with the black ostiola, usually surrounded by a black, sterile margin or circumscribing line, substance hard and rigid, black inside. Perithecia in a single layer, not crowded, ovate, about .5 mm. high, sometimes reaching almost to the base of the stroma. Asci abruptly contracted below into a short, stipitate base, 175-220 x 15-17 microns, spore-bearing part 100-180 x 15-17 microns. Spores acutely elliptical or almond shaped, dark, 22-30 x 11-14 microns (E. & E.—Asci 150 x 10-12 microns. Spores 25-30 x 10-12 microns.) (Sacc.—Spores 25-30 x 8-9 microns.)

On *Fagus* and *Quercus*, vicinity of Bloomington, Ind. Also in Orange County, Indiana.

This species often extends in broad expanses for many feet along dead, standing tree trunks. It is easily overlooked on beech because of its similarity in color to the bark, but is readily identified by its black-punctate character.

3. *H. atropurpureum*, Fr.

Spharia atropurpurea, Fr.

Stroma broadly effused, varying greatly in extent, sometimes 1-2 cm. wide and 5-10 cm. long, occasionally continuous or interruptedly continuous for two or three feet in strips 1-3 cm. wide; 1-2 mm. thick; brown or purple, changing to dark-purple or almost black; margin of stroma rounded and distinct; surface papillate from the slightly prominent perithecia which are .66-1 mm. high, oblong or obovate, and are closely packed in a single layer. Spores ovate, subacute at each end, opaque, 9-13 x 4.5-6 microns. No asci were present in our specimens. (E. & E.—Asci, spore-bearing part, 50-60 x 7-8 microns. Spores 10-14 x 5-6 microns.)

On *Carya* and *Fagus*, vicinity of Bloomington, Ind. Also reported on bark of *Tilia* and other trees.

This species was found growing on the smooth surface of a hickory log from which the bark had been removed by man apparently one or two years previous to the finding of the specimen. The wood was slightly decayed. The stroma was extensively effused in a strip which was approximately one inch wide, entirely continuous for one foot and almost continuous for three feet in length.

This species is distinguished (in our specimens) from *H. rubiginosum* by its larger and more prominent perithecia.

4. *H. rubiginosum*, (Pers.) Fr.

Sphaeria rubiginosa, Pers.

Hypoxyton rubiginosum, Fr.

Stroma broadly effused, occasionally found, however, in small patches a few millimeters or a few centimeters across; rusty-red or brown, finally black, sometimes with a distinct purple tint; .75-1.5 mm. thick and adhering closely to the substratum, the lower part consisting of the altered wood so that it is sometimes difficult to distinguish between stroma and substratum; at first even and sterile but finally distinctly mammillose from the small (.5 mm.) perithecia which generally appear at first separate in the center and spread outwardly, becoming closely packed in a single layer. Asci 105-130 x 5-6 microns, spore-bearing part 70-80 x 5-6 microns. Spores 9-11 x 4.5-5.5 microns. (E. & E.—Asci, spore-bearing part 60 x 6 microns. Spores 10 x 4.5 microns.)

On decorticated *Liriodendron*, Borden, Ind. Also on *Ulmus*, Bloomington, Ind. Reported on *Acer*, *Quercus*, *Fagus* and other deciduous trees. Seems to be very common.

This species is difficult to distinguish from *H. atropurpureum*, but has smaller perithecia and slightly smaller spores. It may also be confused with *H. fuscopurpureum*, but the latter (in our specimens) has larger spores and a more elegantly purple surface.

5. *H. fuscopurpureum*, (Schw.) Berk.

Sphaeria fuscopurpurea, Schw.

Hypoxyton fuscopurpureum, Berk.

"Variously effused, margin generally sterile, outer crust rather hard, black and shining within, surface elegantly purple, regularly granulose from the subjacent perithecia which are oblong-ovate, polystichous, numer-

ous, small, immersed in the shining black stroma, staining the wood or bark around it black, inseparably adnate, extending for an inch or more in length and preferring depressions in the surface of the wood. Sec. Cooke Grev. XI, p. 124, the sporidia are 14 x 7 microns. The specimen in Rav. F. Am. 653, on bark of ash, seaboard of South Carolina, has sporidia 9-11 x 4.5-6 microns, and looks more like a smooth form of *H. rubiginosum*."

The above is quoted verbatim from the description as given in Ellis and Everhart's work. The specimens at hand are rather meagre. Our measurements are: Asci 120 x 9-10 microns, spore-bearing part 85 x 9-10 microns. Spores 12-15 x 6-7 microns.

On rotten wood of *Liriodendron*, Bloomington, Ind.

To distinguish from *H. rubiginosum*, see under description of the latter. It may also be confused with *H. atropurpureum*, but has a more elegantly purple surface and slightly larger spores.

6. *H. perforatum*, (Schw.) Fr.

Sphaeria perforata, Schw.

Stroma superficial, effused, tubercular-convex or depressed-hemispherical (2-4 mm.), often interruptedly confluent for several centimeters in narrow (2-4 mm.) strips, dirty-brown, dark, or purplish rust-color, dotted with the minute, white-margined, punctiform ostiola. Perithecia submonostichous, globose, small (.25-.33 mm.), lying near the surface of the stroma, crowded, mostly not distinctly prominent. Asci 85-110 x 7-8 microns, spore-bearing part 60-70 x 7-8 microns. Spores 8-11 x 4-6 microns. (E. & E.—Spores 10-14 x 5-7 microns.)

On *Ulmus*, *Fraxinus*, *Rhus* and *Sassafras*, vicinity of Bloomington, Indiana. Also reported on *Quercus*.

I have frequently found this species with the hemispherical or tubercular-convex form of stroma. When found in this form alone, it is not at all probable that the collector would think of placing it in the effused group. (See note immediately following the key.)

7. *H. effusum*, Nitschke.

Stroma superficial, thin, forming black, crust-like patches of various shapes and sizes, 3-4 mm. across, or often confluent seriate, 3-4 cm. or more long by .5-1 cm. wide. Perithecia in a single layer, rather large (the central cavity being about .33-.5 mm. in diameter), prominent, but usually flattened above, sometimes with a central papilla much as in *H. annu-*

latum, but not so distinctly annulate-depressed. Asci 90-110 x 5-6 microns, spore-bearing part 55-65 x 5-6 microns. Spores ovate-oblong, pale brown, 8-10 x 3-4.5 microns. (E. & E.—Spores 9-10.5 x 3.5 microns.)

On decorticated *Ulmus*, near site of university reservoir, Bloomington, Indiana.

The stroma in this species is very scant. The perithecia are sparingly fused or confluent so that there is not much substance aside from that comprised in the perithecia themselves.

8. *H. multiforme*, Fr.

Sphaeria multiformis, Fr.

Sphaeria peltata, DC.

Sphaeria rubiformis, Pers.

Hypoxyylon granulatum, Bull.

Stroma erumpent and often margined by the ruptured bark, of various shapes, at first rounded, then spreading and becoming somewhat flattened above, dull rusty-red, finally black and smooth. Perithecia irregularly monostichous, rather large (1 mm.), globose, distinctly prominent, with papilliform ostiola. Asci cylindrical, on long pedicels, 95-110 x 6-7 microns, spore bearing part 60-70 x 6-7 microns. Spores 9-12 x 4.5-6 microns. (E. & E.—Spores 9-10.5 x 3.5 microns.)

On *Fagus*, *Ulmus* and *Juglans*, vicinity of Bloomington, Ind. Also reported on *Betula* (where the stroma is usually transversely elongated), *Alnus*, *Sorbus*, *Quercus* and *Castanea*.

Specimen No. 2193 in the herbarium at Indiana University seems to be the most typical one in our collection. Several other specimens in the same herbarium were identified by Dr. Peck as depressed forms. They have somewhat smaller perithecia.

9. *H. Howcianum*, Pk.

Stroma globose or depressed-globose, 5-15 mm. across; surface brick-red or sometimes orange colored or slightly olivaceous, becoming darker, almost smooth but densely punctuate with the minute, black ostiola; substance of a shining blue-black or brown-black color and showing a radiate-fibrous structure, usually with from one to three or more faint, concentric zones. Perithecia ovate, .25-.75 mm. high, peripheral in a single layer, with scarcely more than the minute ostiola projecting. Asci 75-90 x 4-5 microns, spore-bearing part 50-60 x 4-5 microns. Spores 7-8 x 3-4 microns. (E. & E.—Asci, spore-bearing part 45-50 x 5 microns. Spores 6-7 x 3-3.5 microns.)

On *Acer* and *Fagus*, vicinity of Bloomington, Indiana.

This species is distinguished from *H. coccineum* by the radiate-fibrous, concentric-zoned structure of the stroma, which is lacking in the latter, and also by its much smaller spores.

Specimen No. 2245 in the Indiana University Herbarium is a peculiar form, having a thin orange-colored or brick-red crust which peels off easily, and shows only a few scattered perithecia. This is perhaps an immature specimen.

10. *H. coccineum*, Bull.

- Sphaeria fragiformis, Pers.
- Sphaeria rubra, Willd.
- Sphaeria lycoperdoides, Weigel.
- Sphaeria radians, Tode.
- Sphaeria tuberculosa, Sow.
- Sphaeria bicolor, DC.
- Sphaeria lateritia, DC.
- Lycoperdon pisiforme, Sow.
- Lycoperdon variolosum, Lin.
- Stromatosphaeria fragiformis, Grev.

Stroma globose or subglobose, erumpent, turning the bark dark in streaks for a short distance around, then superficial, completely hiding the scar where it broke through the outer bark, deep brick-red when mature, often paler when young, sometimes turning darker with age after maturity, 2-10 mm. in diameter; interior homogeneous and of an even sooty or gray-black color; surface evenly mammillose from the slightly projecting perithecia; finally solitary or joined together in tufts of two, three, or more. Perithecia peripheral in a single layer, subglobose or ovate, slightly prominent, crowded, .33-.5 mm. in diameter. Asei 115-140 x 6-8 microns, spore-bearing part 70-90 x 6-8 microns. Spores black, often 2-guttulate, 10-14 x 5-7 microns. (E. & E.—Spores 10-12 x 4-5 microns.)

On bark of dead *Fagus*, vicinity of Bloomington, Indiana. Also reported on other trees such as *Quercus*, *Salix* and *Betula*. This is one of our most common species.

11. *H. fuscum*, (Pers.) Fr.

- Sphaeria fusca, Pers.
- Sphaeria fragiformis, Hoff.
- Sphaeria confluens, Willd.
- Sphaeria tuberculosa, Bolt.

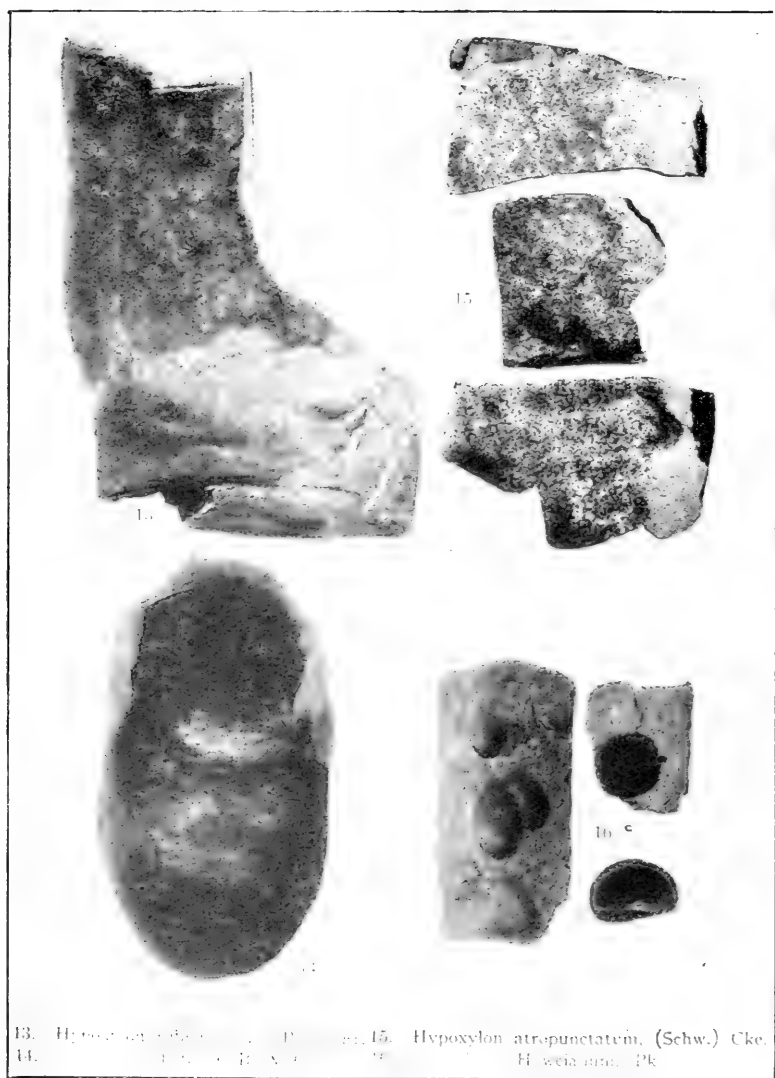

Sphaeria castorea, Tode.

Sphaeria coryli, DC.

Sphaeria glomerata, DC.

Hypoxyton fuscum, Fr.

Stroma erumpent, then superficial, generally 1-4 mm. in diameter, solitary or subconnate, depressed-pulvinate or hemispherical, dark purplish-brown or purplish-red, finally almost black, somewhat uneven from the slightly projecting, small (.5 mm.) perithecia which are closely packed, irregularly monostichous, subglobose, with minute mammilliform ostiola. Asci 95-110 x 7-8 microns, spore-bearing part 80-90 x 7-8 microns. Spores 10-12 x 5-6 microns. (E. & E.—Spores 11-14 x 5-6 microns.) (Saccardo.—Spores 12-16 x 5-7 microns.)

On dead *Ulmus*, *Acer* and *Ostrya*, vicinity of Bloomington, Indiana. Also reported on *Alnus*, *Betula*, *Corylus*, *Fagus* and other deciduous trees.

This species sometimes grows with a few of the perithecia in the center of the stroma projecting farther than the remainder, forming a kind of papilla and giving the entire stroma the appearance of a much flattened volcanic cone.

12. *H. marginatum*, (Schw.) Berk.

Sphaeria marginata, Schw.

Sphaeria durissima, Schw.

Sphaeria truncata, Schw.

Hypoxyton durissimum, Cke.

Hypoxyton marginatum, Berk.

Stroma pulvinate or hemispherical, 3 mm. to 2 cm. across or by confluence more than that, ranging up to 6 or 7 mm. in thickness; black when mature; surface slightly roughened by the projecting perithecia with their papilliform ostiola. Perithecia ovate, monostichous, peripheral, about .5 mm. in diameter, with black ostiola which arise from the center of a small, flat, circular disk or depression which, however, does not appear in the earlier stage of growth. Asci 75-100 x 5-7 microns, spore-bearing part 55-75 x 5-7. Spores 7-9 x 3.5-5 microns. (E. & E.—Asci 75-80 x 6-7 microns. Spores 7-9 x 3-3.5 microns.)

On bark and wood of *Quercus*, vicinity of Bloomington, Indiana.

This species has the annulate-truncate perithecia similar to *H. annulatum*, but is distinguished from that species by its smaller and less prominent perithecia, and by its larger stroma. (See under description of *H. annulatum*.)

13. *H. annulatum*, (Schw.) Mont.

Sphaeria annulata, Schw.

Hypoxyton annulatum, Mont.

Stroma hemispheric-tuberculiform, about 2-5 mm. across, or irregularly effused and interruptedly confluent-tuberculose, brownish-black or purplish-black. Perithecia subglobose, irregularly monostichous, large (.75-1 mm.), with from one fourth to one half of the upper part free, finally annulate-truncate above, with the black, papilliform ostiola in the center of the truncate disk. Asci 90-125 x 6-7 microns, spore-bearing part 65-80 x 6-7 microns. Spores 8-9 x 4-5 microns. (E. & E.—Spores 7-9 x 3.5 microns.)

Common on bark and wood of *Quercus*, vicinity of Bloomington, Indiana.

This species is readily distinguished from *H. marginatum* (which also has the annulate-truncate perithecia) by its usually smaller stroma, which is very irregular on account of the larger, rounded and prominent perithecia, while the stroma of the latter species is even and regular.

14. *H. sassafras*, (Schw.) Berk.

Sphaeria sassafras, Schw.

Hypoxyton sassafras, Berk.

Stroma scant; perithecia large (1-1.5 mm.), the internal cavity nearly 1 mm. in diameter, occurring either singly or aggregated in clusters of 3-8 or more, standing in elongated areas mostly in grooves of the bark, sometimes flattened or compressed by mutual pressure, with their bases united in a thin stroma of a dirty brownish-black, and with one half or more of their upper part free, sub-truncate above, with a minute, papilliform ostiolum. Asci 110-150 x 4-5 microns, spore-bearing part 65-75 x 4-5 microns. Spores 7-9 x 3-4 microns.

On dead fallen *Sassafras*, vicinity of Bloomington, Indiana. Also reported on *Lindera*, where the perithecia may be more evenly scattered over the matrix.

I found this species growing in great abundance on dead saplings in a thicket of *Sassafras* about four miles east of Bloomington, Indiana. In some cases the whole trunk of the tree was thickly covered with the fungus. It seems to prefer cracks and grooves in the bark, and thus grows in long, interrupted strips, which are parallel with the trunk, and in most cases a single perithecium wide.

15. *H. cohaerens*, (Pers.) Fr.

Sphaeria cohaerens, Pers.

Stroma erumpent-superficial, irregularly subglobose or depressed-hemispherical, usually about 2-4 mm. in diameter, gregarious or crowded, often confluent, at first dirty brown, becoming black or nearly black. Perithecia irregularly monostichous, usually 5 to 15 or 20 in a stroma, large (.75-1 mm.), with papilliform ostiola. Sometimes the perithecia are distinctly prominent, forming an irregular stroma composed of a few, large, rounded perithecia loosely joined together. Asci 100-150 x 6-7 microns, spore-bearing part 65-90 x 6-7 microns. Spores 8-12 x 3.5-5.5 microns.

Common on bark of *Fagus*, near Bloomington, Indiana.

Some forms of this species slightly resemble *H. annulatum*, from which it is distinguished by the absence of the annulate-truncate disk on the perithecia. Other forms resemble *H. turbinulatum*, but the latter usually has less prominently projecting perithecia, with more prominent ostiola, a larger number of perithecia in a stroma, and is more turbinate-lately narrowed below.

16. *H. turbinulatum*, (Schw.) Berk.

Sphaeria turbinulata, Schw.

Stroma turbinate-pulvinate, 2-6 mm. in diameter, subconfluent, but with the stromata nearly always distinct, at first brown, then black. The stromata are arranged in a seriate manner so as to bear some resemblance to Hebrew letters, and are sometimes seated on a black crust which over-spreads the bark. Perithecia large, scattered through the entire stroma, with small, scattered, but conspicuous ostiola which are the most prominent part of the perithecia above the surface of the stroma. Asci 120-140 x 5-6 microns, spore-bearing part 70-80 x 5-6 microns. Spores 9-11 x 3.5-5 microns. (E. & E.—Spec. in Herb. Schw., Spores 8-10 x 3.5-4.5 microns.)

On dead bark of *Fagus*, neighborhood of Bloomington, Indiana.

To distinguish this species from *H. cohaerens*, see under description of the latter.

All figures in this paper are practically natural size.

Indiana University,
Bloomington, Indiana.

THE IMPROVEMENT OF MEDICINAL PLANTS.

F. A. MILLER.

The principles of plant breeding have as yet hardly been brought to bear upon the improvement of medicinal plants. The necessity of improvement and the possibilities of the application of modern methods of breeding to this group of plants has led the writer to undertake a series of investigations upon this subject. A discussion of the results and progress of these investigations is the object of the present paper.

The broadening influence of plant breeding is gradually bringing under control members from all groups of the plant kingdom, and it is only fitting that this very important group of plants should be made to yield the best of nature's possibilities. That the group contains many plastic forms which will yield readily to modern methods of breeding is evidenced by the fact that some of the most potent medicinal forms appear in families from which have been obtained many valuable horticultural varieties. The Solonaceæ for example, with the genera *Atropa*, *Hyoscyamus*, *Datura*, *Solanum* and *Capsicum*, and the no less important Scrophulariaceæ containing the now widely known genus *Digitalis*, which is found to be equally as variable both in chemical and physical characteristics as the common garden forms derived from the same and related genera, will serve to illustrate this point.

A review of the literature on drug plant improvement reveals but few attempts at systematic investigation by the employment of standard methods of breeding. On the other hand much has been written and no little accomplished upon the introduction and cultivation of medicinal plants. Introduction and cultivation with no improvement has been the order of procedure. It is quite true that some improvement has resulted from a changed environment and a reduced struggle for existence, but not through the intensive application of particular methods. Improvement by means of seed and plant selection, the isolation and testing of favorable varieties, the study of soil and climatic conditions, trials in hybridization, grafting, or other methods which might prove applicable, have not been tried except in comparatively few instances. Had the government made

selections of hydrastis (*Hydrastis canadensis* L.) ten years ago upon a basis of alkaloidal percentage, their plantings made at that time might now be yielding interesting and valuable data upon the behavior of this plant under cultivation. Problems relating to propagation, cultivation, collecting and curing have been solved, but the cause of the wide range in the percentage of alkaloids in this drug remains an unknown factor. From January 6, 1909 to November 8, 1911, this range in the percentage of alkaloids was found to be from 2.79 to 7.60.

Another illustration of cultivation without improvement which will at the same time serve to demonstrate the practical value of the application of a single standard method is the growing of the drug burdock. This drug consists of the root of *Arctium lappa* L. collected from plants of the first year's growth. For the past fifteen years this plant has been grown under cultivation on a commercial scale near Indianapolis for the production of the first year's roots in the recent condition. The superior quality of the resulting product over that obtained from wild plants was early recognized. The drug was more uniform in every respect, almost free from fibrous tissue and is believed to produce a more active preparation. With this favorable beginning it is surprising, indeed, to learn that the final results of fifteen or more years of continuous cultivation have failed to advance this plant beyond the point reached at the end of the first year. Upon seeking an explanation of this fact it was found that from one year to the next the total seed supply came from wild plants found growing by the roadside. This plant being a biennial and the crop being harvested at the end of the first year's growth has left the farmer at the end of each season to search for a new seed supply. When interviewed as to why seed plants were not selected upon a basis of green weight of root produced, the answer has been that it would not pay. That seed and plant selection could be made to pay can be demonstrated upon a basis of original investigation and reliable data. A study of the results obtained in the Division of Botany of the United States Department of Agriculture upon "the Superior Value of Large, Heavy Seed," indicates an increase in the weight of the plant which is in direct proportion to the weight of the seed employed. To obtain data for calculations upon such a basis, burdock seeds were taken from a lot collected miscellaneously from wild plants and separated into light and heavy portions. The separation was accomplished by the use of an apparatus designed after one

used for the separation of tobacco seeds, in the experiments on tobacco breeding performed at the Connecticut State Experiment Station. This apparatus is described in the Yearbook of the Department of Agriculture for 1904. Slight modifications were found necessary to adapt it to this type of seed. A number of seeds from both the heavy and light portions were accurately weighed. The average of the light seeds was 0.0035 grams and of the heavy 0.0084, a ratio of 1:2.40. The variation in the heavy seeds was from 0.0077 to 0.0091 grams and in the light from 0.0017 to 0.0046. The greater variation in the light seeds was found to be due to the force of the air current employed in the separation. That a separation into light, medium and heavy can be made just as readily as into light and heavy will be shown in connection with another form.

A planting of three acres of burdock of the present year has been chosen as a type upon which to calculate the increase in yield which might have been obtained by means of seed selection. This planting was made upon a deep mellow loam and the total yield of 33,890 pounds is rather unusual. Assuming that the seed supply used on this planting consisted of light and heavy seeds in the determined proportion of 1:2.0, the total yield can be theoretically divided into two portions of 6,778 and 27,112 pounds, respectively produced by the light and heavy seed. Had the light seed used been equal in weight to the heavy seed they would have produced twice as much as they theoretically did, which would have been 13,556 pounds. This would make a total yield of 40,668 pounds instead of 33,890, an increase of 20 per cent.

Even of greater importance, however, to the medical and pharmaceutical professions is the improvement of henbane and digitalis, representing as they do two valuable drugs of the United States Pharmacopœia. By their being more amenable to chemical and physiological methods of standardization, the investigator is furnished with additional means of following the progress of various methods of improvement. Official henbane is supposed to consist of the dried leaves and flowering tops of *Hyoscyamus niger* L. collected from plants of the second year's growth and yielding not less than 0.08 per cent. of mydriatic alkaloids. That the above chemical and botanical conditions of this drug rarely obtain has been clearly demonstrated. An average of a large number of samples examined from August 25, 1908, to September 23, 1911, indicates that only 13 per cent. conformed to the requirements of the United States Pharma-

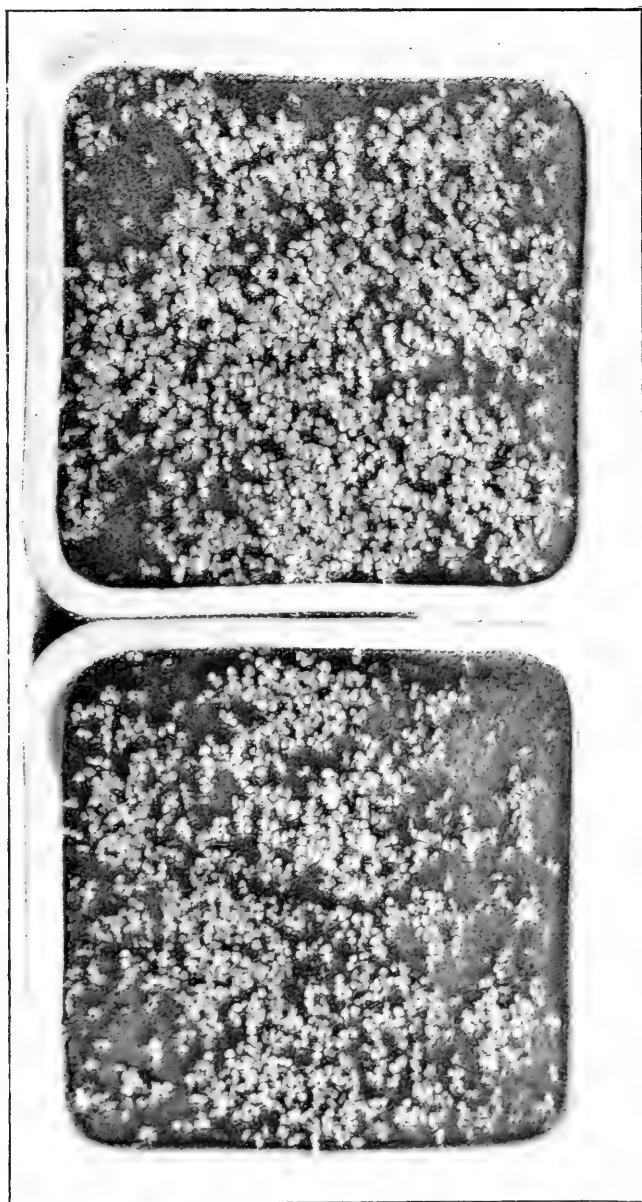

DIGITALIS PURPUREA L.

Result of equal volumes of selected and non-selected seed. Upper seed pan sown with selected heavy seed. Lower seed pan sown with non-selected seed.

copœia from a chemical standpoint. The average alkaloidal percentage of all samples for the same period was 0.0640 and the range of variation in individual samples was from 0.018 to 0.125 per cent.

The botanical characteristics approach the official requirements with no greater degree of certainty. The crude drug varies from fragmentary specimens of unevenly cured leaves and stems containing an admixture of grass, straw and other plant parts, as well as the refuse of chicken and barn lots, to pure, bright, clean, evenly cured leaves, compressed in such a manner that the entire leaf is available for inspection. The botanical source of the drug is also questionable, as evidenced by numerous seed tests from samples and lots from which viable seeds could be obtained. These tests have shown this drug to consist of a mixture of two distinct forms. The so-called annual variety, which is not included in the pharmacopœial description, appeared regularly in these tests. Specimens of this form have been grown to maturity in the writer's garden and close observation has failed to substantiate the statements that it is identical with *Hyoscyamus niger* L. Seedling plants from both forms are now under observation and will be studied both botanically and chemically through succeeding generations. To determine the possibility of obtaining a uniform henbane, seeds were purchased from August and George Fischer of London, which were found to possess a high percentage germination. Plants from these seeds differed greatly in size and vigor in the early seedling stages, and a selection from approximately two thousand seedlings was necessary in order to obtain one hundred and forty plants of uniform character. The great variation noted in the seedling stages of these plants led to a second application of the seed separator. The seeds of this form being quite small, several portions of two hundred seeds each, were taken from light, medium and heavy separations. The respective weights of these were 0.0705, 0.945 and 0.125 grams. Plantings from these different weight seeds have not progressed sufficiently at the present time to justify a discussion of the merits of the method. Open field experiments with this drug have demonstrated that seed germination is uncertain, that the plants are subject to the attacks of many insects and that the seedlings transplant with considerable difficulty. No conclusions can be drawn from these facts, however, since the seeds employed in all outdoor tests were imported and but very few lots of such seeds have given satisfactory results. The two forms of henbane mentioned, i. e., annual

and biennial do not represent the limit of possibilities in this genus. According to Engler and Prantl the genus consists of eight species widely distributed throughout temperate and subtropical regions. In the subtropical is found the very promising form, *Hyoscyamus muticus* L., yielding over one per cent. of alkaloids, while the remainder are found in the temperate regions. Of these, some have passed through periods of prominence in different countries, as *Hyoscyamus albus* in France, the annual form in parts of Germany and the biennial form in England, all of which suggest the possibilities within the entire genus.

In this group of plants the necessity of systematic efforts leading to the development of pure-bred strains of promising species, and to an increase in the percentage of alkaloids is indicated by the above data. The famous corn-breeding experiment at the Illinois State Experiment Station, the records of which now cover thirteen generations, indicates what may be done through selection. That the efforts to increase and decrease the protein and oil have met with great response is shown by the fact that two strains of corn have been produced out of a single variety, one of which contains more than half again as much protein as the other. The effect upon the oil content is even more striking, since from this same variety two other strains have been produced, one of which contains practically three times as much oil as the other. The sugar beet industry of this and other countries is illustrative of the necessity of the intensive breeding, essential to the production of high yielding plants. The gain of 22.2 per cent. in the total sugar beet output of Germany for 1910-11 with an increased acreage of only 3.6 per cent. was due to three factors, one of which was the higher sugar content of the beets. Experiments have shown a variation of seven per cent. in sugar content in beets of the same parentage grown in different localities, a fact which is suggestive of the necessity of a careful choice of localities for drug plant investigation. The introduction of various species of *Cinchona* into India by the British Government over fifty years ago has long passed the experimental stage, but the records of the difficulties overcome stand as convincing evidence of what may be accomplished in the introduction and improvement of arborescent forms. Many of these forms were long grown and propagated under glass until individuals could be isolated which would endure the new environment and be made to serve as starting points for future generations. The work of the Department of Agriculture on capsic-

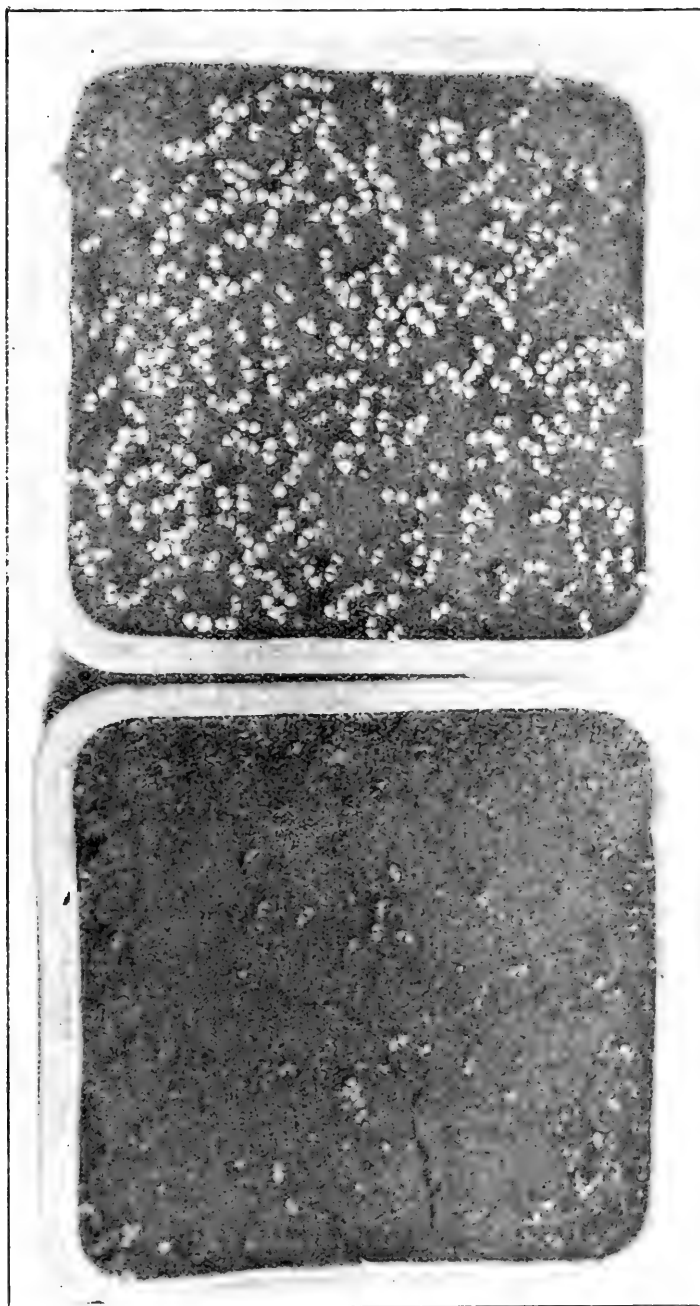

DIGITALIS MONSTROSA.

Upper seed pan sown with heavy seed. Lower seed pan sown with light seed. Equal volumes of seeds were used.

cum, camphor, tea, tobacco and a host of other forms bears out the evidence of the foregoing, and furnishes the worker with a wealth of data applicable in many ways to drug plant improvement.

The drug digitalis, consisting of the dried leaves of *Digitalis purpurea* L. collected from the second year's growth at the commencement of flowering, is equally in need of improvement. Physiological tests have shown a variation in the toxicity of preparations made from drugs representing different geographical sources. Differences of opinion also exist as to the relative medicinal value of first and second year leaves, of those from wild and cultivated plants and of those from plants of different species and varieties, as well as to the effects of different periods of collecting and methods of curing, packing and storing of the crude drug and the relative value of preparations made from fresh and dry leaves. A botanical examination of the genus reveals conditions which will probably account, in part at least, for the above differences of opinion.

The genus is a large one, consisting of twenty-one widely distributed species, a fact which alone increases the possibilities of an admixture of leaves from several species or from the same species growing under different climatic conditions. This possibility is also increased by the numerous varieties originated by florists and gardeners who have not been slow in recognizing the aesthetic value of the genus. Their catalogues now contain many standard varieties which are noted for their attractive nature and ease of culture. The official species *Digitalis purpurea* L. has figured largely in this production, having given rise to no less than half a dozen distinct forms which are now listed as hardy perennials. Other species have been active in this respect but have not produced such a diversity of forms. This property of a genus to yield multiple forms is strongly suggestive of a wide range of variations in the corresponding percentage of active principles. The botanical inspection of the crude drug is in no degree indicative of this percentage of active principle, but that such an indication is possible is suggested by recent investigations of Gregory upon the association of transmissible characters in *Primula sinensis*, where it has been shown that some characters are always found to accompany others with recurring regularity. But until such a convenient relation is found to exist between active principle and specific morphological characters, the botanical examination can only point to the possible source and not to the comparative medicinal value of the drug.

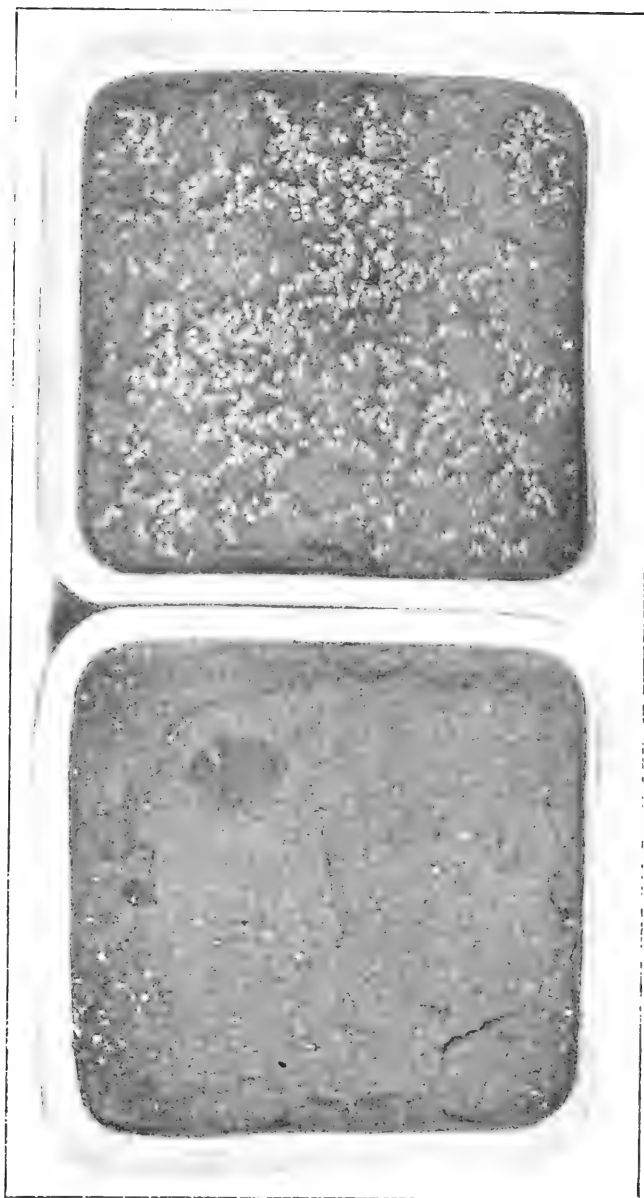

DIGITALIS PURPUREA L.

Upper seed pan sown with heavy seed. Lower seed pan sown with light seed. Equal volumes of seeds were used.

Observations now being made upon several species and varieties of digitalis have revealed variations which would prove of considerable commercial value if found associated with a correspondingly high percentage of active principle. A dissimilarity of leaf forms has been obtained in plants grown from seed which offer valuable material for selection as to form, size, color, and arrangement, relative number per plant, length of petiole, texture and curing properties. Differences have also been noted as to rate and percentage of seed germination, flowering period, production of suckers, hardiness, and ease of propagation and cultivation.

In the course of an investigation upon a form of digitalis found growing adventively in parts of Oregon, an excellent example has been obtained of the uncertainty of the botanical origin of commercial digitalis and the difficulty of the separation of distinct forms upon a basis of leaf characters. One hundred and forty plants said to represent the first year's growth were obtained from this source. These plants were collected in the open and represented a locality from which commercial digitalis leaves had been marketed. These plants arrived in excellent condition and were transplanted in the open near Indianapolis in early spring. They were closely observed throughout the season and during this time but few plants flowered, all of these, however, coming true to the description of *Digitalis purpurea* L. and were quite uniform as to leaf characters. The plants made excellent growth during the summer and went into the winter as large, strong healthful plants in fit condition for experimental purposes. To test this form for hardiness in this latitude these plants were left in an exposed locality in an unprotected condition throughout the year. Forty-three per cent. withstood the severe winter of 1910-11 and flowered, but very irregularly, during the ensuing summer. The effects of the exposure were manifested by a much lower production of leaves than that attained during the first year's growth. Among the sixty plants which survived the winter there was one which produced racemes of pure white flowers instead of the characteristic purple flowers of *Digitalis purpurea* L. The presence of this form among a comparatively small number of plants indicates the admixture of a varietal form, the medicinal properties of which are not known. The other individuals which flowered were fairly uniform in all visible characters except as to variations in flower arrangement, some bearing upright instead of drooping flowers, an arrangement which gave the plants a striking appearance. Seed selec-

tions were made from these forms and a further study will be made of them both for hardiness and as to fitness for medicinal use.

Preliminary work has been done on seed selection with several forms of *Digitalis*. Seed tests of light and heavy seeds obtained by means of the apparatus previously mentioned have given striking results in the early stages of seedling growth as shown by the accompanying photographs. The following data will indicate the accuracy of this method of seed selection and the uniformity in the seeds separated. It also demonstrates the practical value of the method if applied to the commercial production of *Digitalis* leaves. Seeds collected from the foregoing plants of *Digitalis purpurea* L. were separated into light, medium and heavy. The extreme smallness of these seeds made it necessary to use five hundred seeds from each separation for weighings. Seeds of *Digitalis grandiflora* Lam. obtained from Henry A. Dreer of Philadelphia were also separated, weighed and tested. These were heavy enough to be weighed in one hundred lots and were of such uniformity that they were only separated into light and heavy portions.

The following table includes the results of these separations and weighings:

Digitalis purpurea.

Light.	Medium.	Heavy.
500 seeds	500 seeds	500 seeds
0.0217 gm.	0.0253 gm.	0.0341 gm.

Digitalis grandiflora.

Light.		Heavy.
100 seeds.....	0.0168 gm.	100 seeds..... 0.0215 gm.
100 seeds.....	0.0167 gm.	100 seeds..... 0.0223 gm.
100 seeds.....	0.0161 gm.	100 seeds..... 0.0223 gm.
100 seeds.....	0.0161 gm.	100 seeds..... 0.0215 gm.
100 seeds.....	0.0164 gm.	100 seeds..... 0.0217 gm.

Total	0.0821 gm.	Total
		0.1093 gm.

In conclusion it is only necessary to say that the application of these methods of breeding and the possibilities in drug plant improvement herein suggested should be extended until they include such valuable forms as

cannabis indica, belladonna, buchu, and others. Hardy productive varieties of these forms must be discovered or produced, and these brought under the influence of modern agriculture where they may be utilized to meet the conditions of growing scarcity, advancing prices and the demand for better products.

*Botanical Department, Eli Lilly & Company,
Indianapolis, Ind., November, 1911.*

NUTRIENTS IN GREEN SHOOTS OF TREES.

BY E. J. PETRY.

The foods of browsing animals, both wild and domestic, have doubtless engaged the interest of many observers.

Especially, sheep and goats consume much of the succulent leafage of the second growths of forest trees, while the undergrowths of forest seedlings never survive the visitations of these animals, unless the species have particularly obnoxious flavors or principles.

In order to learn the comparative nutritive values in the succulent parts of some of these plants, the writer made numerous chemical analyses,¹ the results of which are given in Tables I and II.

The samples were collected between May 3d and 17th of a very "backward" season; the data therefore apply only to the first crop of shoots in the spring. Subsequent crops of shoots would doubtless vary within wide limits, dependent on moisture and other conditions. The material was collected early in the forenoon, the hour depending on the disappearance of the dew on the leaves, and only material of a certain "hardness" was taken. This "hardness" or shearing quality was taken as nearly uniformly for all samples as was possible.

Branches were cut and enclosed in an airtight case. These were immediately carried to the balance, where only the succulent shoots, i. e., new growth, was removed, and 200 gram samples were weighed out immediately. They were then placed in the sun to dry. By calculating the per cent. moisture of Table I to the moist sample and subtracting from the moisture as given in Table II, one may find the amount of water lost by drying in the sun. It will be seen that they vary from 65.9% to 81.45% in the amount of water driven off by air-drying in the sun. The time consumed in drying varied from two to five days, they being considered air-dry as soon as they would grind well in a drug mill. This mill was thoroughly cleaned after grinding each sample. The ground sample was immediately put into a bottle and tightly stoppered.

¹ Abstract from thesis, Ohio State University.

TABLE I.
PERCENTAGES CALCULATED TO AIR-DRY WEIGHT.

No.	NAME OF SPECIES.	Moisture. (Oven)	Protein. (N×6.25)	Ether Extr.	N-free Extr.	Crude Fibre	Ash.
1	<i>Tilia americana</i> L.....	8.66	19.25	1.84	40.45	20.30	9.50
2	<i>Acer saccharum</i> Marsh.....	8.72	16.62	2.22	49.26	17.16	6.02
3	<i>Acer saccharinum</i> L.....	6.84	17.50	3.12	57.38	9.36	5.80
4	<i>Ulmus fulva</i> Michx.....	7.76	27.56	2.46	38.08	15.40	8.74
5	<i>Celtis occidentalis</i> L.....	6.98	28.00	2.48	36.78	15.64	10.12
6	<i>Robinia Pseudo-Acacia</i> L.....	5.56	27.13	2.54	44.17	13.96	6.64
7	<i>Gleditsia triacanthos</i> L.....	7.28	30.18	3.24	38.80	14.80	5.70
8	<i>Populus alba</i> L.....	7.26	14.37	4.37	44.66	19.72	4.62
9	<i>Liriodendron Tulipifera</i> L.....	7.44	18.81	3.14	45.48	17.23	7.10
10	<i>Fraxinus americana</i> L.....	6.96	17.06	4.06	47.77	18.67	5.48
11	<i>Acer Negundo</i> L.....	4.78	18.81	2.80	48.91	14.63	10.06
12	<i>Populus deltoides</i> Marsh.....	5.78	16.18	4.02	49.30	16.60	8.12
13	<i>Sassafras variifolium</i> (Salisb) Ktze.....	8.84	25.81	4.14	44.24	10.67	6.30
14	<i>Liquidambra Styraciflua</i> L.....	6.85	17.06	3.92	55.53	11.40	5.24
15	<i>Gymnocladus dioica</i> L. Koch.....	6.14	26.69	3.06	39.51	18.58	6.02
16	<i>Quercus alba</i> L.....	6.28	17.94	3.81	45.83	21.64	4.50
17	<i>Quercus rubra</i> L.....	5.52	19.25	3.82	42.42	24.29	4.70
18	<i>Fagus grandifolia</i> Ehrh.....	5.04	16.69	3.82	47.35	19.26	4.84
19	<i>Platanus occidentalis</i> L.....	4.96	22.75	2.83	44.28	18.44	6.74
20	<i>Morus rubra</i> L.....	5.68	28.00	3.54	39.96	12.54	10.28
21	<i>Betula alba</i> , var. <i>papyrifera</i> Spach.....	4.62	17.06	5.80	54.30	12.82	5.40
22	<i>Prunus serotina</i> Ehrh.....	5.04	19.69	5.43	54.72	9.54	5.58
23	<i>Catalpa speciosa</i> Warder.....	3.70	26.25	3.41	47.94	12.06	6.64
24	<i>Populus tremuloides</i> Michx.....	4.62	22.75	8.41	46.19	13.71	4.32
DRY FEEDS (Wolfe*).							
	Red clover.....	16.5	13.5	2.9	37.1	24.0	6.0
	Peas (bloom).....	16.7	14.3	2.6	34.2	25.2	7.0
	Timothy.....	14.3	9.7	3.0	45.8	22.7	4.5
	Leaf feed.....	16.0	10.5	3.0	49.3	14.2	7.4
	Poplar leaves.....	16.0	10.8	8.7	39.6	17.4	7.5

*Wolfe, Emil; Landwirtschaftliche Fütterungslehre, 3rd Ed.

TABLE II.
PERCENTAGES CALCULATED TO GREEN WEIGHT.

No	COMMON NAME.	Moisture. (Air+Oven)	Protein. (N×6.25)	Fat.	N-free Extract.	Fibre. (Crude)	Ash.
1	Basswood.....	77.71	4.6	.44	9.86	4.95	2.31
2	Sugar maple.....	75.40	4.47	.59	13.27	4.62	1.62
3	Soft maple.....	68.23	5.96	1.06	19.56	3.19	1.97
4	Red elm.....	79.10	6.24	.56	8.62	3.48	1.97
5	Hackberry.....	79.20	6.25	.55	8.22	3.49	2.26
6	Black locust.....	76.15	6.85	.64	11.15	3.52	1.67
7	Honey locust.....	77.88	7.19	.77	9.25	3.52	1.35
8	White poplar.....	71.71	4.38	1.33	13.62	6.01	2.93
9	Tulip tree.....	80.88	3.88	.81	9.39	3.55	1.46
10	White ash.....	76.60	4.29	1.02	12.00	4.69	1.36
11	Box elder.....	80.61	3.80	.56	9.90	2.96	2.03
12	Cottonwood.....	73.94	4.47	1.11	13.63	4.47	2.24
13	Sassafras.....	82.31	5.00	.80	8.58	2.07	1.22
14	Sweet gum.....	75.64	4.46	1.02	14.52	2.98	1.37
15	Ky. coffee tree.....	82.54	4.95	.56	7.34	3.45	1.12
16	White oak.....	68.13	6.00	1.29	15.58	7.35	1.43
17	Red oak.....	75.86	4.91	.97	10.83	6.20	1.20
18	Beech.....	72.69	5.66	1.03	13.61	5.53	1.39
19	Sycamore.....	77.04	5.49	.68	10.69	4.45	1.62
20	Mulberry.....	82.08	5.31	.67	7.58	2.38	1.95
21	Birch.....	70.86	5.21	1.77	16.58	3.91	1.64
22	Wild cherry.....	70.51	6.11	1.68	16.99	2.96	1.73
23	Catalpa.....	82.13	4.86	.63	8.89	2.23	1.23
24	American aspen.....	71.18	6.87	2.54	13.95	4.14	1.38
*WOLFE'S DATA.							
	Meadow grass.....	80.0	3.5	.8	9.7	4.0	2.0
	Timothy grass.....	70.0	3.4	1.1	16.3	8.0	2.2
	Clover (bloom).....	80.4	3.0	.6	8.9	5.8	1.3
	Peas (bloom).....	81.5	3.2	.6	7.6	5.6	1.9
	Beans (bloom).....	87.3	2.8	.3	5.1	3.5	1.0
	Poplar leaf.....	55.0	5.8	4.6	21.3	9.3	4.0

*Wolfe, Emil: Loc. cit.

These ground samples were subjected to analysis according to the method of the A. A. O. A. C. for feed stuffs. In order to compare with other similar feeds, data from the Analyses of Wolfe¹ are added at the bottom of each table. The figures in all cases represent per cent., those in Table I being calculated to sun-dry sample, while those in Table II are calculated to green weight as collected.

From these tables it will be seen that these shoots compare very favorably with the other green feeds usually fed, and especially numbers 4, 5, 6, 7, 16 and 22 show a favorable protein content. By the aid of such data, it should not be difficult to explain why animals can live almost indefinitely on such food, while in the dry condition they compare favorably with most of the common concentrates fed to stock. The leguminous species No. 6 and No. 7, as well as others, are of especial interest in this connection.

Wolfe uses a digestion coefficient which varies from approximately 55% to 70% for the various valuable constituents. Doubtless these, too, would show a high degree of digestibility.

No determinations of the amids have been made as yet, nor have the shoots of later dates in the season been used. These two points, along with an investigation of the nitrogen-free extract now in progress may be embodied in a later report.

¹ Loc. cit.

THE NEW YORK APPLE TREE CANKER

BY LEX R. HESLER

(Abstracted from a thesis presented in competition for the Eastman Prize in Biology, Wabash College.)

Much credit is due those who have aided in writing this paper; to Prof. M. B. Thomas for valuable suggestions, to Prof. Donald Reddick and Prof. H. H. Whetzel for suggestions and photographs.

THE HOST

The economic importance of the apple tree makes the disease in question well worth consideration. That the apple as an agricultural product has a vast relative value cannot be denied. We have only to turn to certain statistics to find fairly accurate figures regarding the absolute dollar value of a single crop. Gannett ('03)¹ estimates that the annual crop is worth above \$175,000,000. As an orchard product, the apple comprises 55% of orchard trees and produces 82% of the total bushels of orchard fruit.

THE DISEASE

The term "canker" has come to be a general one, and is usually applied to any disease which causes the death of definite areas of bark on the limbs and trunks of trees. Consequently some modifying term is necessary in order to indicate which canker is under consideration. Paddock ('99)² first used the name New York apple tree canker, thus distinguishing it from the European canker, Illinois blister canker, fire blight canker, and others.

The disease frequently occurs on twigs, where it is usually called "twig blight," but this is confusing, since this term is applied to fire blight. When the disease occurs on leaves it is known as "frog eye." Black rot refers to the disease as it appears on fruit.

The earlier theories regarding canker lead us to believe that the diseases under consideration probably were not the New York apple tree

¹'03, Gannett, H. Twelfth Census of the United States 1900: 74-78.

²'99. Paddock, W. The New York Apple Tree Canker. N. Y. (Geneva) Agr. Exp. Sta. Bull. 153:180. 1899.

canker, nevertheless, they are interesting. Parkinson (1629)¹ in a rare volume discusses canker after the following manner: "The canker is a shrewd disease when it happeneth to a tree; for it will eate the barke round, and so kill the very heart in a little space. It must be looked into in time before it hath runne too farre; most men do wholly cut away as much as is fretted with the Canker, and then dresse it, or wet it with vinegar, or Cowes dung and urine, etc., until it be destroyed, and after healed againe with your salve before appointed * * *." Hales (1732)² wrote in regard to the manner in which canker spreads. Marshall? (1799)³ says: "The canker is a disease that originates chiefly in the soil, pervades the juices of the plant, and finally operates towards its dissolution."

Other workers have discussed canker, but Paddock ('98)⁴ was first to present anything definite regarding the New York apple tree canker. Mangin ('02)⁵ and Delacroix ('03)⁶ described an apple disease. Until recent years there has been confusion as to the cause of the leaf-spot or "frog-eye" disease, but Scott and Rorer ('08)⁷ proved its identity with the canker disease.

Geographical Distribution.—The disease is known to occur in England, France, Austria, Italy, probably in Scotland, South Africa and in America. In our country it is found in practically all apple growing districts.

Economic Importance.—From careful conservative estimates it has been determined that this disease is second in importance among the fungous diseases of the apple. The annual loss can be safely put at \$10,000,000, which makes it apparent that the disease is a serious one.

Symptoms.—The first signs of canker are usually the dying out of the top of affected trees (Fig. 1). Upon approaching more closely, the bark is found to be roughened in more or less definite areas (Fig. 2).

¹1629. Parkinson, John. *Pardisus Terrestris*, London. 1629:550.

²1732. Hales, Stephen. *Statistical Essays*. 1732:264-265.

³1799. Marshall? *An Inquiry into the Cause of Diseases in Plants with Hints Respecting their Cure or Prevention*. Edinburg (J. Ruthven and Sons). 1799:24.

⁴'98. Paddock, W. *An Apple Canker*. *Science n. s.* 8:595-596. 1898.

⁵'02. Mangin, L. *Sur une nouvelle maladie des Pommiers causee par le "Diplodia pseudo-Diplodia"*. *Jour. d'Agr. Prat.* 2:138-139. 1902.

⁶'03. Delacroix, G. *Sur un chancre du Pommier produit par le Sphaeropsis malorum* *Pk. Bull. Soc. Myc. France.* 19:132-142. 1903.

⁷'08. Scott, W. M. and Rorer, J. B. *Apple Leaf-Spot Caused by Sphaeropsis malorum*. *U. S. D. A., Bu. Pl. Ind. Bull.* 121:48. 1908.

These areas begin as slight discolorations, which become depressed, and a distinct crevice marks the line between the healthy and diseased bark. The bark may fall, exposing the wood, or it may adhere closely to the underlying wood. A plate of cork seems to limit for a time the extent

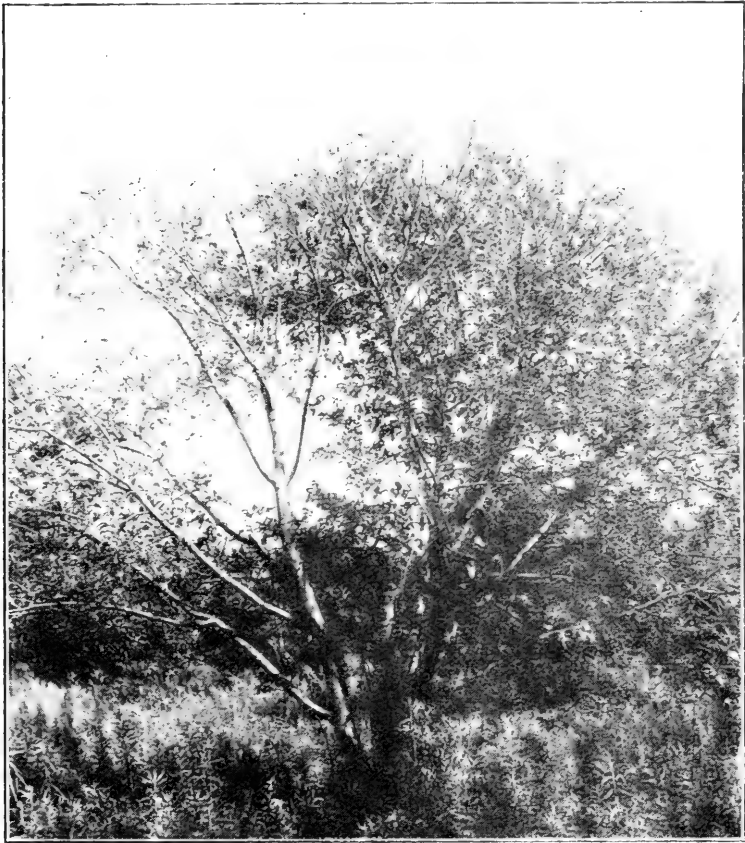

Fig. 1. Twenty Ounce apple tree dying from the attacks of New York apple tree canker. Note the characteristic dying out of the top.

of the diseased area, but this is pierced and the healthy tissue invaded. Soon the affected cells are killed; they shrink, and the healthy portion again is separated from the diseased by a crevice and by a second plate of cork. This process continues until we have concentric rings as shown

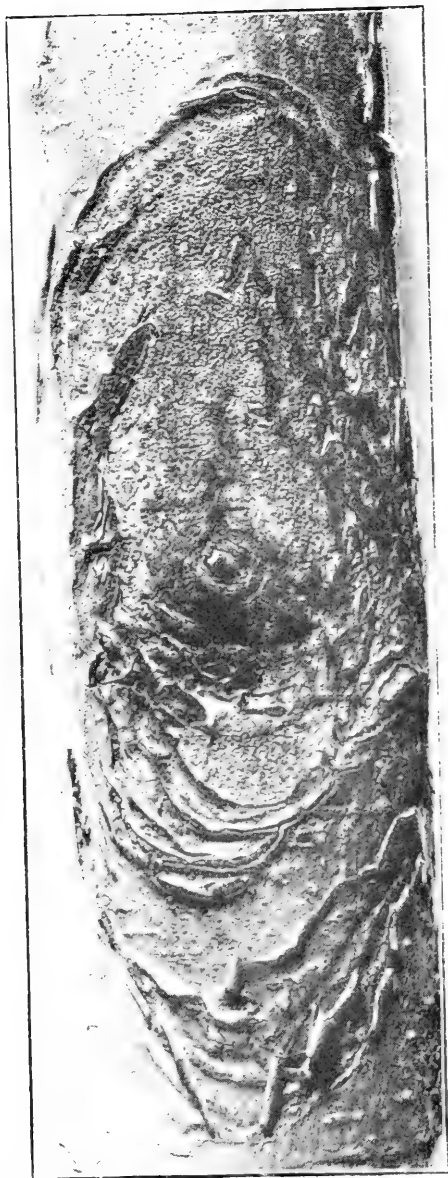

Fig. 2. Photograph of New York apple tree canker showing pycnidia in abundance. (After Whetzel.)

in the figure. The writer has not seen cases where healthy wood is invaded, and the cambium is attacked only rarely. In such cases where only the bark layer is attacked, the canker is not so destructive as when it is less superficial.

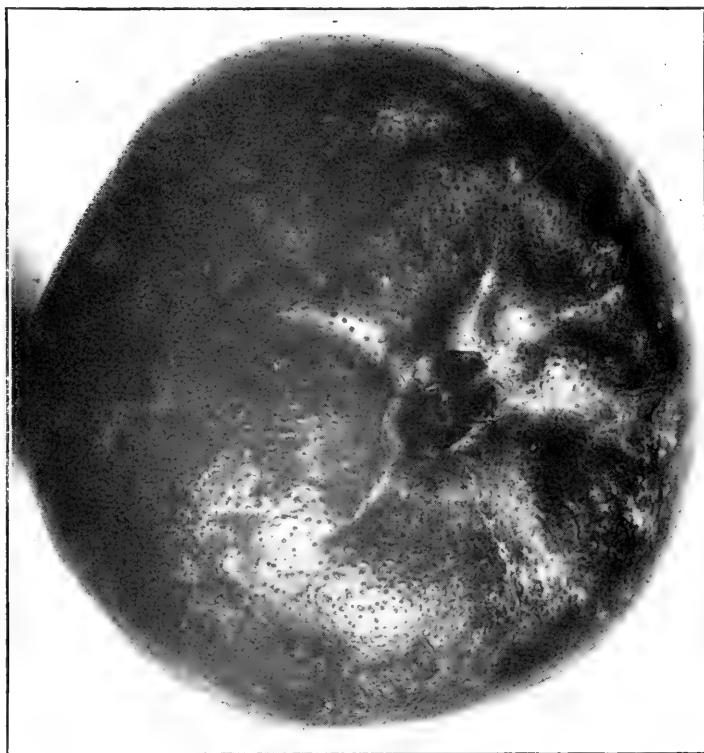

Fig. 3. Black rot of apple. Enlarged to show distribution of fruit bodies of the fungus. (After Whetzel.)

“Frog-eye” spots on leaves begin as small reddish brown spots with purple margins. Later the spots become brown, and if infection is bad they may coalesce, forming large brown patches which involve a larger portion of the leaf.

Black rot (Fig. 3) begins as small darkened area. After a few days alternating bands of lighter and darker colored brown appear, forming

concentric circles of uniform breadth about the point of infection. Finally the fruit is mummified, and according to Dandeno ('06)¹ there seems to be a distinct production of cellulose in the cell-wall of the apple, and also a production of starch in the invaded cells. The walls become thick and the fruit is temporarily in a state of preservation.

ETIOLOGY

The disease is caused by a fungous parasite, *Sphaeropsis malorum*. Its general nature is that of a wound parasite, though it frequently follows blight, thus acting as a saprophyte. Its pathogenicity has been established by Paddock ('00)² and by Scott and Rorer (l. c., p. 49). The writer has confirmed the work of these men, but at present the results are not entirely satisfactory. In few cases has the canker been produced by artificial inoculation even under the most favorable conditions. The only explanations at hand are that the fungus is strictly saprophytic or that the work was not done at the right season of the year. Where maximum sterile conditions were maintained and where the inoculations were made in early summer the writer has failed to reproduce the canker disease. Further experiments may show, however, that infection is possible if done at earlier seasons, perhaps at the time of the rise of sap. Leaves have been inoculated in all conceivable manner, but only where spores were sprayed on the under side were we able to produce "frog eye." In these cases abundant fruit bodies appeared. Extended discussion, as regards the pathogenicity of the organism cannot be taken up here, but it may be said that the present state of our knowledge is very unsatisfactory and many experiments will be necessary to clear up these points.

Synonymy.—In literature we find the fungus referred to as *Sphaeropsis malorum* Berk. and *S. malorum* Pk. Other names have been applied to the same species, so that it is only by making a careful outline of the work done, tracing it from its discovery to the present time, that the situation may become clear.

Berkeley ('36)³ found a fungus which he called *Sphaeria malorum*. He described it as follows: "Globose or subglobose, covered with a blackened cuticle; stroma blackish, cuticle erumpent, more or less strongly

¹'06. Dandeno, J. B. A Stimulus to the Production of Cellulose and Starch. Rept. Mich. Acad. Sci. 8:40-44. 1906.

²'00. Paddock, W. The New York Apple Tree Canker (Second Report) N. Y. (Geneva) Agr. Exp. Sta. Bul. 185:205-213. 1900.

³'36. Berkeley, M. J. English Flora 5:257. 1836.

papillæ form. On apples lying on ground, Winter King's Cliffe, Norths, Rev. M. J. Berkeley. Asci broadly elliptic, septate filled with yellowish green granular." Why he should say "Asci septate," etc., is not known. In his Outlines ('60)¹ he changed the name to *Sphaeropsis malarum* Berk. listing *Sphaeria malarum* in synonymy.

Since the spores of *Sphaeropsis malarum* are brown when mature, and those of *Phoma* are greenish, Saccardo ('84)² used the name *Phoma malarum* (Berk.) Sacc. for Berkeley's fungus. In 1886, the genus *Phoma* was divided, the basis of separation being the size of the spores. Species of the genus *Phoma* with spores less than 15 microns long were retained in that genus, while those species with longer spores were placed in the genus *Macrophoma*. Consequently, Saccardo's *Phoma malarum* (Berk.) Sacc. was renamed by Berlese and Voglino ('86)³ as *Macrophoma malarum* (Berk.) Berl. and Vogl. Meanwhile Dr. Peck ('78)⁴ found a black rot fungus on apples which had brown spores. He believed it to be Berkeley's fungus, and so called it *Sphaeropsis malarum* Berk. But Saccardo ('84)⁵ believed that, since the spores were brown, Peck's fungus was new and used the name *Sphaeropsis malarum* Pk.

Paddock ('99)⁶ points out that *Sphaeropsis mali* Westd. and *S. cinerea* (C. & E.) Sacc. are identical with *S. malarum* Pk. In his second report (l. c., pp. 211-212) he states, as a result of inoculation work, that *S. malarum* Pk. occurs on apple trees, pear trees and hawthorn trees, and on apple, pear, and quince fruits. From this it seems that the species of *Sphaeropsis* on these different hosts are all identical with *S. malarum* Pk. O'Gara ('02)⁷ records that *Sphaeropsis rhoïna* (Schw.) Starb. on *Rhus glabra* is identical with *S. malarum* Pk.

Unfortunately it seems that species of *Sphaeropsis* have been confused with species of *Diplodia*. The two genera are almost identical, the chief distinction being that the spores of the former are usually 1-celled, while the latter embraces species with 2-celled spores. But both genera fail in their chief distinction, so that mycologists have frequently been

¹'60. Berkeley, M. J. Outlines of British Fungology (Lovell Reye, London). 1860:316.

²'84. Saccardo, P. A. Sylloge Fungorum, 3:152. 1884.

³'86. Berlese, A. N. and Voglino, P. Atti. Soc. Veneto-Trentina 1886:184.

⁴'78. Peck, C. H. Report N. Y. State Mus. Nat. Hist. 31:20. 1878.

⁵'84. Saccardo, P. A. Sylloge Fungorum, 3:294. 1884.

⁶'99. Paddock, W. The New York Apple Tree Canker. N. Y. (Geneva) Agr. Exp. Sta. Bull. 163:202. 1899.

⁷'02. O'Gara, P. J. Notes on Canker and Black Rot. Science n. s. 16:434-435. 1902.

mised on this point. Fuckel ('62)¹ described *Diplodia malorum* and *D pseudo-Diplodia* on the branches of apple, and according to his description *S. malorum* is identical with these. Delacroix ('03)² states that, since *S. malorum* Pk. is only a species, which was formerly observed by Fuckel and described by him under the name *Diplodia pseudo-Diplodia*, the name *S. malorum* Pk. should disappear. As a substitute for all previous names he says that the logical name should be *Sphaeropsis pseudo-Diplodia* (Fuckel) Delacroix.

Schweinitz ('34)³ in his treatment of the North American Fungi described a fungus which he called *Sphaeria Sumachi*. Cook and Ellis ('76)⁴ evidently recognized this organism as a *Sphaeropsis*, for they listed it as *Sphaeropsis Sumachi* (Schw.) C. & E. giving *Sphaeria Sumachi* Schw. as a synonym. According to their description and figures, this organism is identical with *S. malorum* Pk. If this is true, then *Sphaeropsis Sumachi* (Schw.) C. & E. is most ancient, and should stand.

Schweinitz (l. c. p. 218) described a fungus, calling it *Sphaeria rhoïna*. Starbäck evidently considered this fungus as a *Sphaeropsis* for Saccardo ('95)⁵ lists it as *Sphaeropsis rhoïna* (Schw.) Starb.; but we have not seen Starbäck's original description. O'Gara (l. c., pp. 434-435), as we have pointed out, has shown that *S. rhoïna* (Schw.) Starb. and *S. malorum* Pk. are identical. We find again that Schweinitz (l. c. p. 219) described a fungus which he called *Sphaeria pomorum*. Cooke ('92),⁶ after having examined Schweinitz's collection, states that it should be classed with the species of *Sphaeropsis*, and that it is probably identical with *S. malorum* Pk.

At this point it might be stated that the writer has collected species of *Sphaeropsis* on several different hosts, all of which agree morphologically with the *Sphaeropsis malorum* of Peck; so that in order to clear up this confusion, these different specific names may also have to be considered in the synonymy. This will be determined by cross-inoculation work. The hosts follow: Apple (wood, bark, leaf, and fruit), *Rhus*

¹'69. Fuckel, L. *Symbolae Mycologicae*. 1869:395.

²'03. Delacroix, G. *Sur l'identité réelle Sphaeropsis malorum* Peck. *Bull. Soc. Myc. France* 19:350-352. 1903.

³'34. de Schweinitz, L. D. *Synopsis Fungorum America boreali media degentium*. *Trans. Amer. Phil. Soc.* n. s. 4:205. 1834.

⁴'76. Cook, M. C. and Ellis, J. B. *New Jersey Fungi*. *Grey*, 5:31. 1876.

⁵'95. Saccardo, P. A. *Sylloge Fungorum*. 11:512. 1895.

⁶'92. Cooke, M. C. *Sphaeriaceae Imperfectae Cognitae*. *Grey*, 20:86. 1892.

typhina; Peach twigs; Pear (bark and fruit); Quince (fruit and leaf); *Tilia americana*; *Morus alba*; *Ulmus americana*; *Sambucus canadensis*; *Hamamelis virginiana* and Crab apple (bark).

With regard to this whole situation it may be said that the suggestion made by Dr. Peck ('81)¹ should have prevented any such confusions. He states that *Diplodia* and *Sphaeropsis* are merely form genera, and that both fail in their chief distinction. Accordingly the oldest generic name should be selected for species like this one, where spores are such that it may be classed either as *Sphaeropsis* or *Diplodia*, and further the separation of the two genera on the basis of the presence or absence of a septum in the spores seems little warranted. It seems that Saccardo was little justified in changing the name *Sphaeropsis malorum* Berk. to *Phoma malorum* (Berk.) Sacc., for it is quite possible that Berkeley described an immature organism. It is quite common to find spores greenish in black rot of apples. After maturing they are brownish.

The discussion of such a situation in regard to the name of a fungus may seem somewhat unimportant, yet it serves as a good example of some of the lack of thorough investigation and the mere guessing at details, which lead to just such confusion. As yet the writer is not wholly satisfied with any of the names. The types of several species will have to be carefully compared before any name can be accepted.

In concluding this phase of the subject there are listed a number of species with citations to literature, which it seems to the writer must be considered in determining the correct name of this fungus, and which names should appear in synonymy.

Sphaeria Sumachi Schw.

Trans. Amer. Phil. Soc. n. s. 4:205. 1834.

Sphaeria rhoiza Schw.

Trans. Amer. Phil. Soc. n. s. 4:218. 1834.

Sphaeria pomorum Schw.

Trans. Amer. Phil. Soc. n. s. 4:219. 1834.

Sphaeria malorum Berk.

Eng. Flora. 5:257-258. 1836.

Podosporium demersum Bon.

Handb. 1851:227.

¹'81. Peck, C. H. Report of the Botanist, N. Y. State Mus. Nat. Hist. 34:36. 1881.

- Sphacropsis malorum* Berk.
 Outlines Brit. Fung. 1860:316.
- Diplodia pseudo-Diplodia* Fckl.
 Sym. Myc. 1869:393.
- Diplodia malorum* Fckl.
 Sym. Myc. 1869:395.
- Sphacropsis Sumachi* (Schw.) C. & E.
 Grev. 5:31. 1876.
- Macroplodia cinerea* C. & E.
 Grev. 6:2. 1877.
- Sphacropsis cydoniae* C. & E.
 Grev. 6:84. 1878.
- Phoma malorum* (Berk.) Sacc.
 Syll. Fung. 3:152. 1884.
- Sphacropsis dcrmersa* (Bon.) Sacc.
 Syll. Fung. 3:298. 1884.
- Sphacropsis cinerea* (C. & E.) Sacc.
 Syll. Fung. 3:293. 1884.
- Macroplodia mali* Westd.
 Lamb. Fl. Myc. Belg. 3:66.
- Sphacropsis Mali* (West) Sacc.
 Syll. Fung. 3:293. 1884.
- Sphacropsis malorum* Pk.
 Syll. Fung. 3:294. 1884.
- Macrophoma malorum* (Berk.) Berl. et Vogl.
 Atti. Soc. Myc. Veneto-Trentina 1886:184.
- Sphaeropsis pseudo-Diplodia* (Fckl.) Delacr.
 Bull. Soc. Myc. France, 19:350-352. 1903.

LIFE HISTORY

Upon examination of a cankered limb, especially if comparatively young, pyrenidia will be found. Occasionally, too, they are developed on leaves, and very abundantly on the fruit. They are borne beneath the cuticle, which is ruptured at their maturity, and a papillate ostiolum

protrudes (Fig. 4). The size of pycnidium varies from 200-270 microns in the vertical diameter, by 180-210 microns in the horizontal diameter. Typically, there is a unilocular spore-bearing cavity and an ostiole; however, certain conditions of culture have developed pycnidia which lack the ostiole (Fig. 5). This has been observed by Walker ('08)¹ who regarded the character as sufficient to call it a "new form." Whether or not this is so to be regarded cannot be said, but the strain which produced pycnidia in our culture lacking the ostiole, originally possessed an ostiole in nature. Isolations were made from unilocular pycnidia and when mature fruit bodies had developed in culture, they were larger, measuring 400-600 microns x 660-720 microns, and were multilocular. Just how we are to interpret these variations is yet a question, but it seems

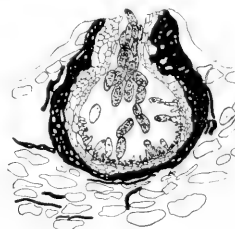

Fig. 4. Camera lucida drawing of a typical pycnidium of *Sphaeropsis malorum*.

that they are not to be taken too seriously when questions of taxonomy are involved. If these characters were constant they would be more important, but since they are only variations, little importance should be attached to the absence of an ostiole or to the number of conceptacles.

The pycnidial wall is thick, but not uniformly so. The reason for any variation in thickness may be that less protection is needed at the base, or that its thickness, there, is determined by purely mechanical pressure brought about by the resistance offered to the apex of the pycnidium by the epidermal and cuticular layers of the host tissue. It is made up of two distinct layers, the pseudo-cells of which are very thick-walled and black, and an inner layer of thin-walled cells.

Conidiophores arise from all points of the inner layer and extend outward. They are variously shaped and each is terminated by a conidium

¹'08. Walker, L. B. A New Form of *Sphaeropsis* on Apples. Nebr. Agr. Exp. Sta. Rept 21:31-44. 1908.

or pycnospore. A spore arises as a swelling at the tip of the stalk which bears it and after it has reached a certain size, is cut off by a septum. Spores vary in color, size, and shape. When young they are hyaline, later becoming greenish, and when mature are brownish. They may or may not become septate; just what determines this is not understood. One-celled spores in some cases develop two-celled spores in culture. The sporophore is binucleate (Fig. 4) and as the swelling begins at the terminal end, one nucleus passes into the swelling. About this time, a con-



Fig. 5. Photomicrograph of a pycnidium in median section, developed on fruit of apple by artificial inoculation. Note the absence of an ostiole.

striction begins to appear a short distance from the spore-end of the stalk. This marks the line of detachment of the spore from the sporophore. Further development cannot be given at present, except to say that the mature spore is binucleate. The most noteworthy difference in size of spores is that they are larger on fruit and in culture than on limbs or leaves. There is also slight variation with host-plants.

Spores readily germinate in water (Fig. 6), about six hours being required, though we have observed germination after three hours. The tube first appears as a slight swelling at one end or the side. Two-celled

spores frequently put out two germ tubes. Those kept in the laboratory for a year have been found capable of germination.

Micro-conidia have been found frequently in cultures. They are produced near the tips of young mycelial threads and will reproduce the fungus when sown in pure culture. They are colorless and measure 3.6–6.3 x 7–14.5 microns.

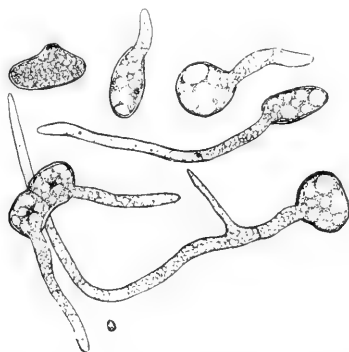

Fig. 6. Spores. Germinated in water after a few hours.

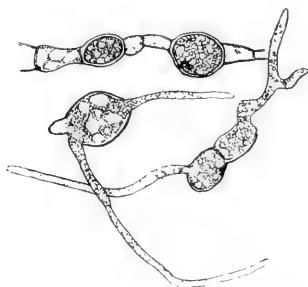

Fig. 7. Chlamydospores produced in culture after four months. Germinated in water after a few hours.

Chlamydospores are also quite common (Fig. 7). The first notice of these bodies was made in agar cultures about three months old. Their formation seems to be brought about as a result of certain mycelial cells becoming rich in protoplasm and becoming delimited by transverse walls to form the chlamydospore, which later acquires a thick membrane. In older cultures, oil drops have been seen in the chlamydospores. These germinate readily in water (Fig 5).

The Mycelium.—The germ-tube as it branches to develop the mycelium is at first hyaline, but soon becomes darker. In old cultures it is very dark brown. The contents are granular, glycogen frequently being present. Its diameter ranges from 4-10 microns; averaging about 7 microns.

The ascogonous form has been reported by Shear ('10),¹ who sowed ascospores of *Melanops quercuum* (Schw.) Rehm *forma vitis* Sacc. and obtained brown pycnosporos which agree morphologically with those of *S. malorum* Pk. and *Diplodia pseudo-Diplodia* Fekl.

Pure Cultures.—The fungus grows and fruits well on any of the media which we have used, including several vegetable and fruit decoction agars. Growth is at first cottony, the colonies effuse and radiating. The brown color characteristic of the older threads soon spreads through the aerial hyphae until only the extreme surface threads remain a light gray color. The production of pycnidia in culture has never failed in our experience, and at present we have about fifty different strains growing. Whether or not certain strains will not fruit in culture remains to be tested.

CONTROL

Preventive measures have not been carefully worked out, though a few general suggestions can be given.

So far as an immediate remedy is concerned it seems that eradication, protection and immunization are points most worthy of consideration. Clean culture should be practiced along with surgical measures. Cankers should be cleaned out and this done carefully. Whether this is practicable or not depends upon the energies of the grower. In one orchard of about 400 trees which we call to mind, the work was done effectively at a cost of about twenty-five cents per tree. In removing cankered spots, all diseased bark should be removed, the wounds disinfected with corrosive sublimate (1-1000) and painted with coal gas tar. Tools which we have found convenient are those which any farmer has, namely, a draw-shave, a farrier's knife for trimming the margin of the wound, and the necessary coal tar and disinfectant. In performing these operations, as well as when picking the fruit, it is recommended the workmen use care about breaking the bark. Any such wounds are only an open door for the fungus.

¹'10. Shear, C. L. Life History of *Melanops quercuum* (Schw.) Rehm, *forma vitis* Sacc. Science n. s. 31:748. 1910.

Spraying for canker is practiced; but do not misunderstand what is meant. If the organism is established then it is likely that spraying will not be effective, but trees can be protected against infection. It is often stated that canker is not found in well managed orchards, but this has not been our observation. Even in some of the best cared for orchards we have found the most cankers. In these cases, either the fungus gained entrance to the cambium in only a few instances, or if it did pierce this layer, the limbs were cut off just back of the diseased area and a new shoot allowed to form.

It has been noticed for a number of years that not all varieties are attacked. We have in mind an orchard in which three rows were the Twenty Ounce variety. Other varieties on either side were unaffected. Just why this difference? Is it due to the virulence of the fungus or does it depend upon increased susceptibility of the host, this in turn to be attributed to some subtle change in nutrition, soil condition, or some other overlooked factors of environment? Soil conditions were apparently uniform, so that some more remote factor must have contributed to this phenomenon.

Is it possible to inject into a tree a substance which would render it immune? It is claimed by some that such a thing is possible. After all, then, just how far is the canker fungus responsible for the destruction of the host? May not its invasion be the result of changes from some of the causes suggested rather than the direct work of the parasite? The questions are only to be answered by hoping that future investigation will reveal some of these remote, yet interesting, questions to such an extent that economic conditions generally will be benefited.

Wabash College,

Crawfordsville, Ind., June 1911.

VALUE OF FERTILIZING CONSTITUENTS OF WEEDS OF INDIANA.
ANALYSIS OF IRONWEEDS.

BY FRANK MATHERS AND MISS GAIL M. STAPP.

This paper is the beginning of work to determine the value of weeds. Ironweeds, which grow everywhere in great abundance, were selected for analysis. Samples were collected from the university campus on September 29, 1911. They were cut into small pieces and dried for several days in the air. Finally the material was dried for several hours at about 50°. The analysis was made upon this dried sample, but the results were calculated to the air dried material. The loss on drying was 14 per cent. The analyses¹ of several other substances are given in this table for comparison.

	PER CENT OF			Value per Ton.*
	Nitrogen.	Phosphoric Acid.	Potash.	
Ironweeds.....	1.29	0.66	0.95	} \$6 50
	1.28	0.63	0.98	
Blue grass.....	1.19	0.40	1.57	6 65
Oxeye daisy.....	0.28	0.44	1.25	3 28
Wheat straw.....	0.59	0.12	0.51	2 87
Foxtail.....	1.54	0.44	1.99	8 45
Corn stover (fodder).....	1.04	0.29	1.40	5 76
Timothy hay.....	1.26	0.53	0.90	6 24
Red top.....	1.15	0.36	1.02	4 14
Red clover.....	2.07	0.38	2.20	10 54

*The values used for N, P₂O₅ and K₂O are 18, 6 and 6 cents per pound respectively.

These calculations do not consider the value of the organic matter, which is really the thing of greatest importance in manures and soiling crops. The values assigned represent the cost of a commercial fertilizer containing the same amounts of nitrogen, phosphoric acid and potash.

¹ Yearbook of the U. S. Dept. of Agriculture, 20: 611 (1896).

The object of this work is to point out the value of weeds and to call attention to the possibilities of utilizing these waste products for increasing the fertility of the soil. Many tons of ironweeds grow each summer in the pasture fields of the State. In some cases the weeds are cut but are not used in any way. The cost of cutting, raking, hauling and scattering these weeds upon some field under cultivation would be only a small part of their value. If there were a market for ironweeds at say \$2.50 per ton, farmers would harvest the entire crop. Then why are the ironweeds not used by the farmer himself, since they are worth \$6.50 to him? The value of clover as a fertilizing material is recognized by everyone, but ironweeds, which are worth 60 per cent. as much as clover, are never considered of any value whatever.

Indiana University, Bloomington.

THE PREVALENCE AND PREVENTION OF STINKING SMUT IN INDIANA.

BY C. R. ORTON.

In bringing before the Academy the subject of "Stinking Smut" the writer wishes to impress upon its members the fact that this disease is of considerable economic importance, and that so far little, if any, systematic effort has been made to eradicate it. It is hoped that the importance of this disease will soon be brought before the wheat growers and agriculturists of Indiana, and since the disease is one which has been proved, both experimentally and practically, to be easily and cheaply prevented, that active measures will be taken to check its further spread in the State.

There is little doubt that stinking smut has been present in Indiana since the introduction of wheat growing in the State, and that in some years comparatively small loss has been occasioned, but it is not a matter of doubt that in some years a very severe loss is reported which amounts to startling figures when represented in monetary values.

There have been several bulletins¹ issued from the Purdue Experiment Station in years past concerning this disease, but none which have given any definite information regarding its prevalence throughout the State.

In the fall and winter of 1910-11, Dr. Frank D. Kern, Associate Botanist at the Purdue Experiment Station, sent out from that Department about 1,200 interrogatory letters, one of which is here reproduced, to the leading elevators and grain dealers throughout the State, each county being represented.

"Name.....

Postoffice.....

County.....

Did stinking smut of wheat occur in your vicinity the past season?

.....

¹Arthur, J. C. Smut of Wheat and Oats. Bull. Agr. Exp. Sta. of Ind. 28:1889.

Arthur, J. C. Treatment of Smut in Wheat. Bull. Agr. Exp. Sta. of Ind. 32, 2:1890.

Arthur, J. C. and Johnson, A. G. The Loose Smut of Oats and Stinking Smut of Wheat and their Prevention. Circular Agr. Exp. Sta. of Ind. 22. 1910.

- If so, to what extent? (General, local, or occasional.).....
- About how many bushels of smutted wheat from the past season's crop did you buy?.....
- What was the average dockage on such wheat?.....
- Kindly estimate as closely as possible the total number of bushels of smutted wheat from the past season's crop bought in your county.....
-
- What was the general average of dockage in your county?.....
- Is the formaldehyde (formalin) seed treatment practiced in your territory?.....
- If so, to what extent, and with what success?.....
- What are the greatest pests of wheat, and the greatest drawbacks to its successful culture in your vicinity?.....
- In your opinion how may these be overcome?.....

The following statistics are compiled from 503 replies to these letters: Five counties were not heard from. Reporters from Benton County replied that no wheat was raised in that county. Eight counties reported that stinking smut did not occur with them, and eight counties reported it as occurring, but did not report the amount of smut estimated present or actually purchased. This leaves seventy counties from which we compile our statistics. From these seventy counties 422 reports were returned, of which practically all stated that stinking smut occurred locally or generally with them, showing that it is thoroughly distributed throughout the State.

Of these 422 reporters who replied, only 247 reported the number of bushels of smutty wheat which they actually purchased. These were in varying amounts from fifty bushels by one correspondent in Morgan County, to 150,000 bushels by another in Vigo County. In all there were 885,610 bushels actually purchased by them. This was "docked" varying amounts, from 2 cents to 40 cents per bushel, averaging $8\frac{1}{2}$ cents per bushel. This made a total reported loss to the State for 1910 of \$75,276.85. Considering that only 247 of the 1,200 dealers written to replied with figures from which we can draw conclusions, it seems very conservative to estimate the actual loss from stinking smut to be three times that reported, or about \$225,000 for the State.

DESCRIPTION OF THE FUNGUS.

It is not the purpose of the writer of this article, in the treatment of the subject-matter at hand, to attempt a technical description of the fungus popularly called "stinking smut of wheat," or known scientifically as *Tilletia foetens* (B. & C.) Trel. It is in order that those not acquainted with the disease may recognize it that a brief description is here included.

The fungus belongs to a family of the smuts which form their spore masses usually within the ovaries of various grains and grasses. In this particular it differs materially from the so-called "loose smut" of oats, wheat and barley. The spores when mature render the seed coat brittle and it is soon ruptured. The spores in dissemination become attached to the sound seed and remain there until planted. Germination of the smut spores takes place about the same time that germination of the wheat kernel occurs. This is an especially favorable time for the vegetative growth (mycelium) of the fungus to invade the soft tissues of the wheat seedling, and their growth and development goes on simultaneously. When the wheat plant has attained its growth and is forming its seed, the fungus has also attained to its maximum mycelial development and produces its spores within the maturing kernel of the wheat. These spores soon mature and form a greasy mass of dark brown color which gives off a disagreeable odor if the seed coats become ruptured. They are soon disseminated by various agents.

Thus the wheat, instead of growing sound heads, produces heads which are light and chaffy and worse than worthless, for any appreciable amount of them ground together with sound seed produces an unmarketable flour. They are also a very grave source of further contamination and infection of seed wheat. A field infected with stinking smut or a bin of wheat containing a very small per cent. of stinking smut is readily detected by the strong disagreeable odor it gives off. Thus it is that grain dealers and elevator men instantly detect stinking smut in the wheat they buy.

PREVENTION AND TREATMENT.

From the nature of the disease and its habit of growth it is readily understood that a contact fungicide should be effective in controlling this disease. It has been conclusively demonstrated by several experimental workers, including the Purdue Experiment Station, that the following treatment of seed wheat will entirely prevent it and at a very low cost.

This is quite clearly brought out in the report. Of the five hundred and three reporters, only forty-four knew of the formaldehyde treatment being tried for stinking smut, and forty-two of these had been successful. The two failures reported could easily have been caused by careless methods of treatment or perhaps by storing in contaminated vessels after treatment.

The formaldehyde treatment consists in spreading the seed on a tight floor or canvas and sprinkling until thoroughly moist with a .1% formaldehyde solution (made by adding one pound of 40% commercial formaldehyde to about 50 gallons of water). The grain should be shoveled over several times during the sprinkling process in order that the formaldehyde may be evenly distributed. It should then be shoveled into a pile and covered with canvas, or some closely woven material, for about two hours. The covering should then be removed and the grain either planted immediately or else dried by shoveling or spreading the seed into a thin layer and stirring occasionally. It may then be stored, care being taken to thoroughly disinfect the bins or sacks in which the treated wheat is placed.

The cost of treating the seed required to plant the crop of 1910 is estimated as follows: By multiplying the number of acres planted in wheat, or 2,027,000, by one and one-quarter bushels, or the amount of seed planted per acre, we obtain 3,283,750 bushels of seed required to raise a crop equal to that of 1910.

Figuring that formaldehyde costs 40 cents per pound, and that one pound mixed with 50 gallons of water will be sufficient to disinfect 80 bushels of seed, we have a cost of the formaldehyde for treating one bushel, of approximately one-half cent.

Then the amount of seed required, or 3,283,750 bushels multiplied by one-half cent, gives \$16,418.75, or the cost of the formaldehyde for treating all the seed wheat planted in the State. This sum subtracted from the estimated loss of \$225,000, leaves \$208,582, approximately, which would be the gain to the State in one year by treating the seed wheat with formaldehyde. These figures need no emphasis. The whole subject is one which is now in the hands of the farmer. It is for him to decide whether he wants to prevent this heavy loss or not. The Purdue Experiment Station is anxious to assist, in every possible way, those interested in this work.

*Purdue University,
Lafayette, Indiana,*

INDIANA FUNGI—II.

J. M. VAN HOOK.

The collecting of fleshy fungi during the months of July and August was almost a total failure, due to the extreme dry weather. On the other hand, the continued rainfall during September and October was productive of a great many species common to the fall months. Many of these had not been met with during the four years previous to 1911. It is interesting to observe during such seasons how the rains will awaken apparently dormant mycelia which produce immense quantities of spores. Moreover these seem most abundant on dry exposed hillsides, which under ordinary conditions produce but few mushrooms.

One plant not previously observed was *Armillaria nardosmia* Ell. This species grew in abundance in several places in Brown and Monroe counties in October. It is one of our most attractive mushrooms (Fig. 1). In color and general appearance it reminds one of the soft feathers of our native pheasant.

Likewise specimens of *Lactarius sordidus* Pk. were abundant in situations commonly very dry. (Fig. 2.)

One of the most interesting things ever observed by the writer was a most splendid fairy ring formed by *Clavaria formosa* Pers. This ring was complete; about twenty feet in diameter and composed of "bunches" for the most part six or eight inches in height and two to four inches in diameter.

One species collected the year before and resembling in its manner of growth *Institule maxima*, which is occasionally found on the hymenium of the common *Fomes applanatus*, was found on the hymenium of a resupinate form of *Fomes conchatus*. Specimens of this were sent to Dr. Peck, who describes it in the New York State Museum Report for 1910 as a new species, *Sporotrichum chryseum* Pk. The following is his English description: "Hyphæ slender, 3-4 microns thick, continuous, long, intricate, hyaline, forming a soft, thin, subrosy separable membrane, golden yellow beneath; spores abundant, minute, globose, 2.5-3 microns in diameter."



Fig. 1. *Armillaria nardosmia* Ell



Fig. 2. *Lactarius sordidus* Pk.

"On the hymenium of a resupinate form of *Fomes conchatus* (Pers.) Fr., Bloomington, Indiana, J. M. Van Hook."

Most of the fungi collected during the year have as yet not been identified. The list for 1911 includes only species new to Indiana University herbarium and collected in the State.

The Myxomycetes, omitted from last year's list, are here included. All specimens not otherwise marked were determined by myself and collected in 1911.

USTILAGINEÆ.

Ustilago anomala J. Kunze. On *Polygonum scandens*. Coll. F. L. Pickett, Monroe County, October.

POLYPORACEÆ.

Boletus cyanescens Bull. Ground, rich leaf mold, woods. Clark County, September 8, 1910. J. M. V.

Polyporus berkeleyi Fr. Growing from the ground but attached to the root of an oak stump. Monroe County, July 15. Cue.

AGARICACEÆ.

Agaricus abruptus Pk. Monroe County, October 4. Meier.

Amanita caesarea Scop. Ground, campus, September 27.

Armillaria nardosmia Ell. Ground, Monroe County, October 4. Det. Pk. (See Fig. 1.) J. M. V.

Collybia zonata Pk. Ground, Monroe County, October 4. J. M. V.

Cortinarius cylindripes Kauff. Ground, Monroe County, October 4. J. M. V.

Hygrophorus pratensis (Pers.) Fr. Ground, forming a fairy ring, Monroe County, October 10. Edmondson.

Lactarius camphoratus (Bull.) Fr. Ground, Monroe County, October 6. J. M. V.

Lepiota conspurcata (Willd.) Morg. Rich humus, campus, under trees, October 9. J. M. V.

Lepiota virescens (Speg.) Morg. Ground, campus, September 27. Meier.

Marasmius delectans Fr. On dead leaves, ground, campus, September 27. J. M. V.

- Pholiota angustipes* Pk. Lawn, Monroe County, October 12. J. M. V.
Russula lepida Fr. Woods, ground, July 12, Brown County. J. M. V.
Russula sordida Pk. Low wet ground, beech woods, Brown County,
 July 12. J. M. V.

LYCOPERDINEÆ.

- Lycoperdon cruciatum* Rost. Ground, between cement blocks, Kosciusko County, September 28. Elder.
Tylostoma verrucosum Morg. On very rich leaf mold, campus, October 2. Woolery.

ASCOMYCETES.

- Didymella lophospora* Sacc. & Spieg. On living leaves of *Quercus rubra*, Monroe County, November 3. Sutton.
Dothidella ulmea (Schw.) E. & E. On fallen leaves of *Ulmus americana*, campus, December. J. M. V.
Erysiphe graminis DC. On old wheat straw, Monroe County, August 9. Pickett.
Erysiphe polygoni DC. On *Polygonum aviculare*, campus, August 17. J. M. V.
Helvella lacunosa Afz. Ground, top of hill, Monroe County, October 21. J. M. V.
Hypoxyylon atropurpureum Fr. On beech, Monroe County, November 12, 1910. Owens. Det. Pk.
Hypoxyylon effusum Nitschke. On elm, Monroe County, January 7, 1910. Owens.
Hypoxyylon marginatum (Schw.) Berk. On oak, Monroe County, November 25, 1910. Owens.
Hypoxyylon multiforme Fr. On beech, Monroe County, November 12, 1910. Owens.
Hypoxyylon perforatum (Schw.) Fr. On ash, Monroe County, January, 1910. Owens.
Hypoxyylon rubiginosum (Pers.) Fr. On elm, Monroe County, January 28, 1910. Owens. Det. Pk.
Hypoxyylon sassafras Schw. On sassafras, Monroe County, February 11, 1911. Owens.
Nummularia microplaca B. & C. On sassafras, Monroe County, January 28, 1911. Owens.

Nummularia repanda (Fr.) Nitsch. On elm, Monroe County, November 25, 1911. Owens.

Rhytisma acerinum (Pers.) Fr. On living leaves of *Acer rubrum*, Monroe County, October. Sutton.

Rosellinia subciculata (Schw.) Sacc. On stump of *Liriodendron tulipifera*, Clark County, November 2, 1908. J. M. V.

Valsaria exasperens (Ger.) Sacc. On beech bark, Monroe County, November 18. Owens. Det. Owens.

SPILÆROPSIDALES.

Phyllosticta cercidicola E. & E. On living leaves of *Cercis canadensis*, Monroe County, October. Sutton.

Phyllosticta cruenta (Fr.) Kickx. On living leaves of *Smilax rotundifolia*, Monroe County, August 17, 1909. Shekell & Culp.

Phyllosticta faginea Pk. On living leaves of *Fagus ferruginea*, Monroe County, August 17, 1909. Shekell & Culp.

Phyllosticta labruscae Thuem. On living leaves of *Vitis cordifolia*, August 17, 1909. Monroe County. Shekell & Culp.

Phyllosticta solitaria E. & E. On Maiden Blush apples, fall of 1909. Clark County. J. M. V.

Septoria erigerontis B. & C. On *Erigeron* sp., Monroe County, August 11, 1909. J. M. V. & Culp.

MELANCONIALES.

Colletotrichum trifolii Bain. On red clover, Monroe County, June 6, 1908. J. M. V.

Cylindrosporium toxicodendri (Curt.) E. & E. On living leaves of *Rhus toxicodendron*, Monroe County, fall of 1910. J. M. V.

Gloeosporium septorioides Sacc. On living leaves of *Quercus rubra*, Monroe County, August 17, 1909. Shekell & Culp. (Some spores appear one-septate. This is *Marsonia quercina* Wint.)

Marsonia martini Sacc. & Ell. On living leaves of oak, Monroe County, fall of 1910. J. M. V.

HYPHOMYCETES.

Cercospora cercidicola Ell. On living leaves of *Cercis canadensis*, Monroe County, fall of 1910. J. M. V.

Cercospora granuliformis Ell. & Höllw. On living leaves of *Viola cucullata*, Clark County, September 21, 1906. J. M. V. (Varies slightly from the description.)

Cercospora oculata Ell. & Kell. On living leaves of *Vernonia noveboracensis*, Monroe County, August 11, 1909. J. M. V.

Cercospora violae Sacc. On living leaves of *Viola cucullata*, campus, August 11, 1909. J. M. V. (Spores as much as 250 microns long. Conidiophores up to 150 long.)

Sporotrichum chryseum Pk. On the hymenium of a resupinate form of *Fomes conchatus*. In Monroe County or Brown County. Exact location not known. Data temporarily lost. Fall of 1909 or 1910. J. M. V.

MYXOMYCETES.

Arcyria denudata (Linn.) Sheldon. October 28, 1901, Monroe County. Mutchler.

Dietydium cancellatum (Batsch.) Macbr. Mutchler.

Dianema depressum List. Mutchler.

Fuligo ovata (Schaeff.) Macbr. On bark of rotten hickory log, Monroe County, November 11, 1908. J. M. V.

Hemitrichia clavata (Pers.) Rost. Monroe County, October 29, 1901. Mutchler.

Hemitrichia leiocarpa (Cke.) Macbr. Monroe County, October 29, 1901. Mutchler.

Hemitrichia stipata (Schw.) Macbr. Monroe County, October 25, 1901. Mutchler.

Hemitrichia vesparum (Batsch.) Macbr. Monroe County, November 4, 1901. Mutchler.

Lamproderma scintillans (R. & Br.) List. On oak bark, Brown County, August 25, 1908. J. M. V.

Lycogola epidendrum (Buxb.) Fr. Montgomery County, November 3, 1908. Wood.

Oligonema nitens (Lib.) Rost. Monroe County, October 25, 1901. Mutchler.

Perichaena variabilis Rost. Monroe County, October 20, 1901. Mutchler.

Plasmodiophora brassicae Wor. (No data as to county.)

Stemonitis ferruginea Ehrenb. Monroe County, October 25, 1901. Mutchler.

Stemonitis fusca (Roth.) Rost. Brown County, October 22, 1908.
On rotten log. J. M. V.

Stemonitis smithii Macbr. Winter 1897. Copeland. Monroe County.

Trichia contorta Rost. Monroe County, October 25, 1901. Mutchler.

Trichia decipiens (Pers.) Macbr. Monroe County, October 22, 1901.
Mutchler.

Trichia favoginea (Batsch.) Pers. Monroe County, October 30, 1901.
Mutchler.

Trichia persimilis Karst. Monroe County, October 25, 1901. Mutchler.

Trichia scabra Rost. Monroe County, fall of 1908. J. M. V.

Indiana University,
December 1, 1911.

DISEASES OF GINSENG CAUSED BY SCLEROTINIAS.

BY GEO. A. OSNER.

The diseases of ginseng may be divided into two main classes; first, those which attack primarily only the part above ground, and second, those which directly affect the root of the plant. Of the former class, the two most destructive diseases are the *Alternaria* Blight and *Phytophthora* Mildew. Of the latter class, four or five of the most important ones may be mentioned, among which are: Wilt, End or Fiber Rot, Soft Rot, and those diseases caused by *Sclerotinias*—the Black and Crown Rots. It is with the two last named diseases that this paper deals.



Fig. 1. Photograph of a portion of a ginseng garden, showing a spot in one of the beds killed by Black Rot fungus.

The Sclerotinias are characterized during the vegetative stage by the formation of sclerotia. The sclerotia are white when first formed, but soon the outer cellular layers become black and more or less roughened. These sclerotia are usually formed abundantly on the diseased root, especially during the later stages, thus affording an easy means of distinguishing these diseases.

There are two distinct types of Sclerotinial diseases of ginseng; one in which the entire root becomes black and covered with hard black sclerotia and the other in which the root retains its natural color, but in which a number of black sclerotia are developed on the outside. The former type is known as Black Rot and is familiar enough in those gardens infested by it. The diseases of the latter type have collectively gone under the name Crown Rot, although it is by no means certain that the various diseases given this name have all been caused by the same organism.

It was with the object of determining the name and characteristics of each organism connected with these diseases and of finding some means for successfully combating them that the present investigation was undertaken. The work during the summer of 1910 was carried on at Cornell University under the direction of Prof. H. H. Whetzel, to whom grateful acknowledgments are due for the use of his private notes collected during his work on ginseng diseases. The work was continued during the past winter in the laboratories of the Botanical Department of Wabash College under the direction of Prof. M. B. Thomas.

BLACK ROT.

The first recorded mention of this disease was by Van Hook ('04) from a ginseng garden in New York. However, with the increased cultivation of ginseng it has spread, until last summer it was reported not only from several counties in New York but from other States as well. While to the author's knowledge, its destruction has been extensive in only a few cases, it is well worth while to be on the lookout for it, as this disease is very difficult to eradicate when once it obtains a foothold.

Roots attacked by Black Rot are coal black in color when dug, changing to a dirty gray when dried. They are devoid of all their small fibrous

('04) Van Hook, J. M. Diseases of Ginseng. New York (Cornell) Agr. Exp. Sta. Bul. 219: l. c. 181-182. 1904.

roots and are covered with many black protuberances or sclerotia. The disease is caused by a soil fungus which penetrates the epidermis of the root, attacking and breaking down the tissue, which is replaced by a tangled compact mass of mycelial threads. The fungus is apparently able to gain entrance into any part of the root, as some infections were found which had started at the crown while others seemed to have originated in the smaller roots. The outer tissue is first attacked, the mycelium gradually turning black and giving the root its characteristic appearance. At this stage the center of the root still retains its natural color, but instead of being compact and brittle is rather soft and watery, while the whole root is tough and pliable. Infected roots which have lain in the soil two or three years gradually become black throughout and finally decay.

One of the peculiar things about this fungus is that its period of attack is during the winter. Healthy roots with well-formed buds, when set in the fall in infected soil, fail to send up shoots the following spring, and on examination are found diseased with Black Rot, the blackening by this time usually extending one-fourth of the way to the center. After the plants come up in the spring, with the return of warm weather, there is no further spread of the disease until the next winter. In working with the fungus in pure culture in the summer, an ice-box is necessary, as it will not grow at the ordinary temperature.

The organism causing this disease is a new species of fungus belonging to the genus *Sclerotinia*. The mycelium is septate, branching, and when old becomes more or less blackened. In pure culture it grows luxuriantly on almost any medium if kept at a temperature of 40° Fahr. On nutrient agar or potato agar, sclerotia are produced in three to six days. The sclerotia are at first white compact masses of tangled mycelium, which soon become black on the outside. They are for the purpose of producing the perfect stage and carrying the fungus over unfavorable periods for growth, being able to withstand submersion in boiling water for three minutes without having their germinating power destroyed. Under favorable conditions of moisture and temperature, these sclerotia send out germ tubes just as do spores. Under other conditions they may give rise to the perfect stage, although this has never been obtained in pure cultures. However, last spring, (1910), the perfect stage¹ was found in one

¹ NOTE.—A technical description of this fungus is to be published in an early number of *Phytopathology* by Mr. W. H. Rankin.

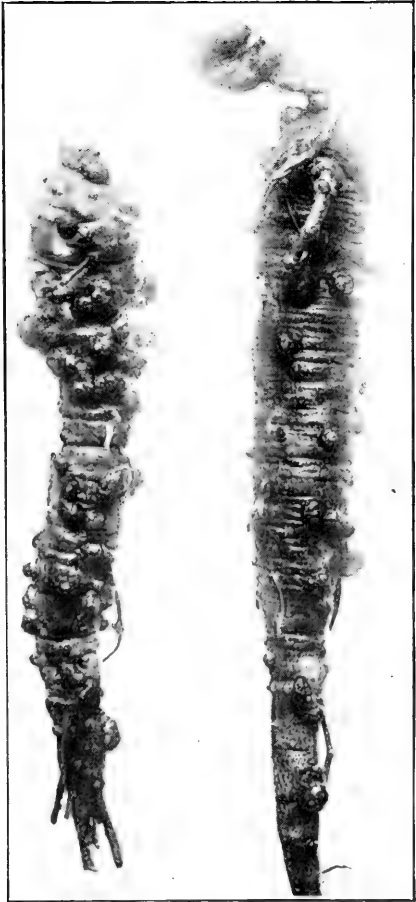

Fig. 2. Ginseng roots attacked by Black Rot and showing sclerotia.

of the ginseng gardens in New York. This perfect stage developed from sclerotia on roots which had lain in the garden during the winter, very near the surface of the ground. In the spring short stalks were sent up, bearing large cup-shaped apothecia containing the asci with their ascospores. These spores when mature are shot up into the air to be disseminated by the wind and rain.

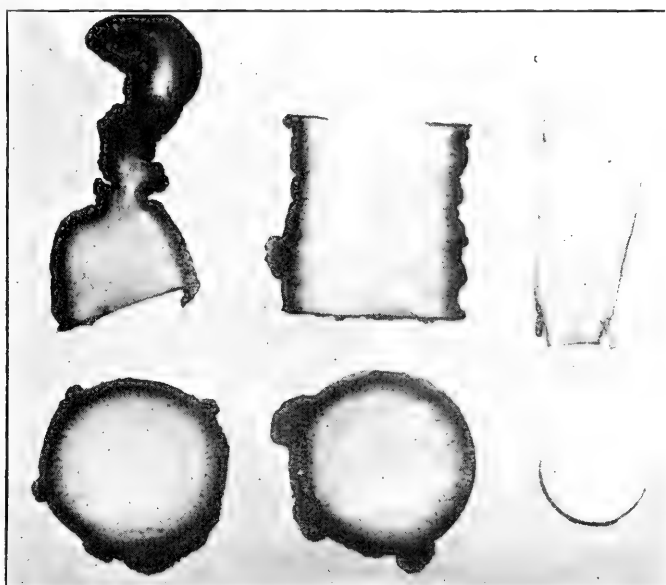

Fig. 3. Black Rot. Cross and longisections of root and bud of diseased and healthy plants. The blackening of the diseased roots will later extend to the center of the diseased root. Section of healthy plant on right. (After H. H. Whetzel.)

When once established in the garden the parasite apparently spreads by the mycelium growing through the soil from one plant to another, killing all that come in its path. It is also spread by the tools used in weeding or spading the beds, especially in the fall. Its distribution from one garden to another is probably brought about by infested soil or perhaps by spores being carried on the shoes of people visiting the various gardens, or by the importation of diseased roots.

A number of experiments were performed to determine if possible some method of eradicating this disease by soil treatment. It was found

that the fungus would grow equally well on alkaline and acid media in any strength which could be used on the soil. From this it seems probable that changing the acidity of the soil would be of no benefit here, as it is in the case of some other ginseng diseases. Until some other means for its control is found, it would be advisable to keep a sharp lookout for black roots when digging in the fall, and to examine all spots where plants fail to come up in the spring. If any diseased roots are found, search the area carefully and remove and burn all of them. The soil in the infested area should then be sterilized with formalin, diluted 1-100, care being taken not to injure the adjacent healthy roots, or if suitable apparatus is at hand, steam sterilization may be used. If the garden becomes too badly infested, the only remedy is to move the seedlings to another garden, carefully sterilizing all tools with formalin or corrosive sublimate before using them in the new garden. Van Hook ('04) cites a case where a grower had set roots in a bed from which black roots had been taken six or seven years before. The roots failed to come up in the spring, and on being examined were found to be infected with Black Rot, thus showing that this fungus is apparently capable of remaining in the soil as a saprophyte for several years.

CROWN ROT.

This disease has been known to ginseng growers for several years, but except in a few cases it has not been found very abundant. The first mention of it was by J. H. Koehler ('03)¹ in a letter to *Special Crops*. Since then it has been reported from various counties in New York and from States as far west as Wisconsin.

There are two different types of the disease; one in which it attacks the upper part of the stem, and the other in which it attacks the root at or near the crown. In the latter type, the organism causing the trouble seems to gain entrance into the plant through the base of the stem near the surface of the ground, or in some cases through the upper part of the root. It works slowly up the stem and quite rapidly down, soon entering and rotting the root. The stem loses its green color and the tissue becomes shrunken, so that the fibro-vascular-bundles stand out sharply as long striations or ridges. The stem soon becomes hollow and inside are found large black sclerotia. These are also found on the roots. The tissue of the diseased root generally becomes soft and "doughy." The

¹('03) Koehler, J. H. Letter to Editor. *Special Crops* 2 : 148. Sept. 1903.

mycelium is abundant throughout the diseased tissue and seems to travel between the cells, dissolving the middle lamella.

In case the disease attacks the upper part of the stem, the first effect noticed is that the petioles all droop, or the leaflets droop from the petiole. The leaves soon fall off, and on examination the stalk will be found to contain several black sclerotia. In one garden, examined by the writer last summer the plants had been attacked by this disease in June after they had attained their growth, and when examined in August the leaves

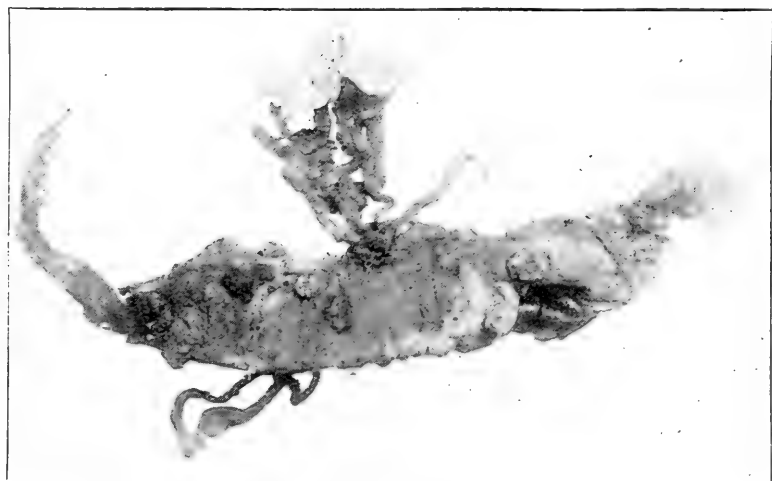

Fig. 4. Black Rot of ginseng showing apothecia. (After Rankin.

had fallen off, leaving only the straight dead stems containing sclerotia. In this type of injury the root may send up a new stalk the next year, but in the year of the attack no growth is added.

From observations in the diseased gardens it would seem that the trouble is increased by the presence of too much moisture; that is, if the fungus occurs in the soil with these conditions present it will produce the disease. One man, whose garden was troubled with this disease, stopped it almost immediately by removing the shade and aerating the enclosure.

The cup fungus, *Sclerotinia libertiana* Fuckel, has been connected with this disease. This is a soil parasite which is widespread and common on other plants such as hemp, rape, cucumber, tobacco, many forced

vegetable and bulbous plants. The mycelium is septate, irregularly branching, and frequently very much vacuolated. It grows from the cracks in the root as a white felt, later giving rise to large, hard, black sclerotia. When first formed, these are white, but later they change to brown, and finally black. Mature sclerotia are white or dirty-white within, of densely woven threads and with a black cellular outer coat. As in the case of the Black Rot fungus, they are for the purpose of carrying the organism over periods unfavorable to growth and for giving rise to the perfect



Fig. 5. Crown Rot of ginseng showing large, well developed sclerotia. (After Whetzel.)

stage. Under suitable moisture and temperature conditions, they send out germ tubes directly, just as the Black Rot fungus. The perfect stage has never been obtained by the writer in pure culture, although during the past winter an effort was made to do so. A large number of sclerotia, grown on various media, were placed out of doors in sterile sand, contained in earthen pots, and this spring one-half of them were brought into the greenhouse. Some of the pots containing the sclerotia were kept very

moist, some fairly moist, and others rather dry, but in no case did any fruiting stage appear. However, in the spring of 1910, in a ginseng garden near Apulia, N. Y., the perfect stage was found, having developed from some old sclerotia which had lain near the surface of the soil over winter. Specimens of this perfect stage sent to Dr. E. J. Durand of Cornell University were pronounced by him to be *Sclerotinia libertinia* Fuckel.

It is possible that some of the diseases reported by ginseng growers and described as Crown Rot have been caused by other species of *Sclerotinia*. During the past winter, the writer has grown several different

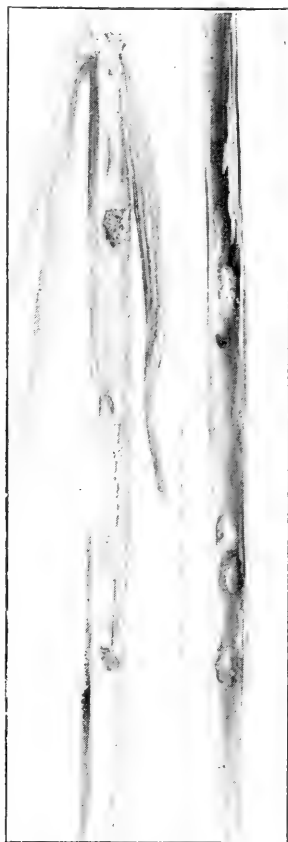

Fig. 6. Crown Rot showing sclerotia inside the old dead stems. In this case the roots were not diseased.

strains of this Crown Rot fungus—secured from various parts of the country—on culture media in an effort to classify them. Cultures were made on a large number of media, including nutrient agar, potato agar, bean plugs, potato plugs, ginseng plugs, sweet potatoes, turnips, nutrient gelatin, corn-meal, Raulins' culture fluid, and several others. On all the media mentioned the various strains made a good growth, the optimum being at the temperature of 20° C. On several of the media the growths of a number of the strains were unlike, so there may be more than one species, but as the fruiting stages were not obtained, this could not be determined definitely.

The Crown Rot is apparently disseminated in two ways; by the mycelium and by spores. The mycelium may grow through the soil to other roots or it may be distributed by implements used in spading or weeding the beds. The spores may be scattered by the wind and rain or they may be carried on diseased seedlings or on the shoes and clothes of people visiting the various gardens. As stated before, this fungus grows on a number of plants other than ginseng and it may also gain entrance to the ginseng garden directly from these other plants by any of the agencies given above.

The growth of this fungus does not seem to be affected by any change in the acidity or alkalinity of the soil which could be brought about in the field. Until some better means of combating it is found, the old rotted roots should be carefully dug and burned so as to remove the danger of infection from the cup stage in the spring. The attacked stems should also be removed and burned as soon as noticed. Spraying with bordeaux mixture will probably lessen the injury to the stems above ground. In addition to this the garden should be well-drained, and if the disease becomes very prevalent, it would be well to remove part of the over-head covering and loosen the soil around the plants so as to allow them to dry out.

Wabash College,

Crawfordsville, Ind., June 17, 1911.

ADDITIONS TO THE FLORA OF THE LOWER WABASH VALLEY, BY DR.
J. SCHNECK.

BY CHAS. C. DEAM.

Among some volumes which I recently purchased from the library of the late Dr. J. Schneck is a copy of "The Flora of the Wabash Valley Below the Mouth of White River, by Dr. J. Schneck," published in the 7th report of the Indiana Geological Survey, 1875, in which Dr. Schneck made numerous annotations and additions. Believing that these notes and additions are of sufficient interest and value to justify their publication at this time, the following list has been prepared, which excludes those reported in the Botanical Gazette, Volume 1, page 83. The nomenclature adopted is that of Gray's Manual, 7th edition.

- Cystopteris bulbifera* (L.) Bernh. Hanging Rock.
Potamogeton foliosus Raf.
Potamogeton pusillus L. 1887.
Zanchinella palustris pedunculata J. Gay. In muddy water at Grand Rapids, August 1880.
Najas flexilis (Willd.) Rostk. & Schmidt. October 18, 1880.
Tripsacum dactyloides L. July.
Paspalum laeve Michx.
Paspalum mucronatum Muhl.
Panicum anceps Michx.
Panicum dichotomiflorum Michx.
Leersia lenticularis Michx. September 25, 1878.
Muhlenbergia Schreberi J. F. Gmel.
Muhlenbergia sobolifera (Muhl.) Trin.
Muhlenbergia sylvatica Torr.
Sporobolus asper (Michx.) Kunth.
Sporobolus vaginiflorus (Torr.) Wood.
Agrostis perennans (Walt.) Tuckerm.
Calamagrostis canadensis (Michx.) Beauv.
Sphenopholis pallens (Spreng.) Scribn. 1887.

- Eragrostis megastachya* (Koeler) Link.
Glyceria canadensis (Michx.) Trin.
Festuca octoflora Walt.
Bromus ciliatus L.
Agropyron Smithii Rydb. Embankment of the Southern Railroad,
 east of Mt. Carmel, June 25, 1900.
Cyperus filiculmis Vahl.
Dulichium arundinaceum (L.) Britt.
Eleocharis acicularis (L.) R. & S. Margin of Burnett's pond in Gib-
 son County, Indiana. August 11, 1891.
Eleocharis olivacea Torr.
Eleocharis palustris (L.) R. & S.
Eleocharis rostellata Torr.
Scirpus fluviatilis (Torr.) Gray.
Carex alata Torr.
Carex bromoides Schkuhr.
Carex canescens L.
Carex Davisii Schwein. & Torr.
Carex filiformis L.
Carex Frankii Kunth.
Carex hystericina Muhl.
Carex lanuginosa Michx.
Carex lurida Wahl.
Carex lupulina Muhl.
Carex pallescens L.
Carex pennsylvanica Lam.
Carex retroflexa Muhl.
Carex riparia W. Curtis.
Carex rosea radiata Dewey.
Carex stricta Lam.
Peltandra virginica (L.) Kunth.
Lemna trisulca L. Cypress pond.
Wolffia columbiana Karst. 1891.
Juncus effusus L.
Juncus nodosus L.
Luzula campestris (L.) DC.
Stenanthium gramineum (Ker.) Kunth.

- Allium vineale* L. 1896.
Yucca filitomentosa L. Escaped from yards and cemeteries.
Smilax pseudo-china L.
Smilax Walteri Pursh. In low, damp woods about Dan's pond in
 Knox County, Indiana. August 13, 1900.
Orchis spectabile L.
Habenaria flava (L.) Gray. Border of Foote's pond in Posey County,
 Indiana. July 14, 1877.
Quercus Michauxii Nutt. Gibson County, Indiana.
Quercus texana Buckley.
Comandra umbellata (L.) Nutt.
Chenopodium Botrys L.
Anychia canadensis (L.) BSP.
Stellaria media (L.) Cyrill.
Cerastium nutans Raf.
Silene regia Sims. July 2, 1879.
Dianthus Armeria L.
Nymphae advena variegata (Engelm.) Fernald. Not rare, in all de-
 grees of dark purple to yellow.
Ranunculus circinatus Sibth.
Ranunculus laxicaulis (T. & G.) Darby.
Cocculus carolinus (L.) DC.
Papaver dubium L. In Shannon's lot. June 5, 1879.
Sisymbrium canescens Nutt. May 20, 1887.
Sisymbrium Thalianum (L.) J. Gay.
Barbarea vulgaris R. Br. In Harrington's meadow. 1904.
Arabis dentata T. & G.
Cleome serrulata Pursh. 1888 and 1894.
Saxifrage virginensis Michx. This may be pennsylvanica L.
Gillenia stipulata (Muhl.) Trel. June 10, 1879.
Amelanchier canadensis (L.) Medic.
Potentilla monspeliensis norvegica (L.) Rydb.
Geum canadense Jacq. 1879.
Prunus angustifolia Marsh. French or Chicasaw plum.
Melilotus officinalis (L.) Lam.
Desmodium viridiflorum (L.) Beck.
Lespedeza procumbens Michx.

- Vigna sinensis* (L.) Endl. Escaped, 1898.
Amphicarpa Pitcheri T. & G.
Polygala verticillata L.
Croton capitatus Michx.
Euphorbia Cyparissias L.
Euphorbia humistrata Engelm.
Callitriche deflexa Austrina (Engelm.) Hegelm. May, 1879.
Rhus copallina L.
Vitis cinerea Engelm.
Vitis palmata Vahl.
Viola lanceolata L.
Didiplis diandra (Nutt.) Wood. In a pond along the Southern Railroad east of Mt. Carmel. July 24, 1897.
Rotala ramosior (L.) Koehne. Rare. October, 1888.
Oenothera laciniata Hill. In sandy soil near Lyles Station in Gibson County, Indiana. July 10, 1895.
Oenothera speciosa Nutt. 1893.
Myriophyllum heterophyllum Michx.
Sanicula canadensis L.
Thaspium barbinode (Michx.) Nutt. Near the mouth of White River. Not rare there. May 22, 1887.
Hottonia inflata Ell.
Lysimachia thrysiiflora L. May, 1881.
Vinca minor L. About open and grassy places.
Asclepias amplexicaulis Sm.
Cuscuta Cephalanthi Engelm.
Cuscuta Coryli Engelm.
Cuscuta Epithimum Murr. On clover on the Keene farm.
Cuscuta obtusiflora HBK.
Hydrophyllum canadense L. June 4, 1896.
Ellisia Nyctelea L. Near Cypress pond. 1888.
Lithospermum arvense L. May 15, 1879.
Lithospermum canescens (Michx.) Lehm.
Trichostema dichotomum L. In Wabash County, Illinois.
Lamium amplexicaule L. April, 1878.
Salvia azurea grandiflora Benth. On the farm of Martin Myer. June 30, 1896.

- Melissa officinalis* L. Along streets and old roads. June-Sept.
Physalis subglabrata Mack. & Bush. July 28, 1882.
Datura Metel L. Occasionally spontaneous.
Bacopa rotundifolia (Michx.) Wettst. August, 1888.
Gratiola sphaerocarpa Ell.
Gerardia auriculata Michx.
Utricularia cleistogama (Gray) Britton. In mud where there had
been several feet of water. Gibson County, Indiana, October 9,
1901.
Utricularia gibba L. In pond along the Southern Railroad, about
three miles east of Mt. Carmel.
Orobanche ludoviciana Nutt.
Plantago aristata Michx. June, 1883.
Plantago elongata Pursh.
Plantago lanceolata L.
Galium triflorum Michx. August 5, 1887.
Eupatorium altissimum L.
Kuhnia eupatoides L.
Chrysopsis villosa Nutt. August, 1878.
Solidago speciosa Nutt.
Aster laevis L. On the Walter farm. October 9, 1878.
Polymnia canadensis L.
Xanthium echinatum Murr. River bottoms. 1877.
Rudbeckia speciosa Wenderoth.
Bidens discoidea (T. & G.) Britt.
Chrysanthemum Leucanthemum L.
Senecio glabellus Poir.
Cirsium arvense (L.) Scop. 1887.
Cirsium spinosissimum (Walt.) Scop. June 18, 1878.
Tragopogon porrifolius L.
Sonchus oleaceus L.
Lactuca Scariola L. Found for the first time near the shops of the
Big Four Railroad, July 31, 1891.

Bluffton, Indiana.

PLANTS NEW OR RARE IN INDIANA.

 BY CHAS. C. DEAM.

Specimens of the following species are deposited in the writer's herbarium and in the larger herbaria of the United States. The number of specimens in all cases has been ample for correct determinations, which have been checked by specialists.

Elymus australis Scribn. & Ball.

Knox County, September 28, 1910. Frequent on the north bank of White River near its mouth.

Carex laxiculmis copulata (Baily) Fernald.

Noble County, June 20, 1910. In moist, rich woods about six miles southwest of Rome City.

Muscari racemosa (L.) Mill.

Harrison County, April 17, 1911. Common in a clover field of about 6 acres on the farm of Aaron Wolf, located about seven miles northwest of Corydon.

Dioscorea glauca Muhl.

Clark County, June 30, 1910. In a wooded ravine on the east side of the Forest Reserve.

Dioscorea quaternata (Walt.) Gmel.

Posey County, July 7, 1910, in Black Oak woods, about four miles northwest of Mt. Vernon. Jennings and Jefferson counties, 1911.

Cocculus carolinus (L.) DC.

Posey County, September 23, 1911. Frequent on the wooded bank of the cypress pond near Bone bank. Robert Ridgway was the first to report this species for the State. (See Amer. Naturalist, Vol. 6:729, pub. 1872. Also taken by Dr. Schneck. Collected also by Dr. Schneck near Burnett's pond in Gibson County, October 20, 1879.)

Chrysplenum americanum Schwein.

Porter County, May 4, 1911. In anthesis on this date. Frequent in wet woods just north of Willis stop on the South Shore Electric line. It

was associated with *Acer saccharinum*, *Pinus Strobus*, *Viola conspersa*, *Panax trifolium* and *Coptis trifoliata*.

Lespedeza striata (Thunb.) H. & A.

Posey County, September 23, 1911. A small colony in a woods pasture at Bone bank.

Vitis rotundifolia Michaux.

Gibson County, September 4, 1911. Two specimens over three inches in diameter were noted in a woods on the flood plain of the White River about six miles northwest of Patoka. One was suspended from the top of a tall sycamore tree. This species was noted several times in Gibson County along White River and in the vicinity of Long pond. It was noted in Knox County near the mouth of White River, and in Posey County along the Wabash River about four miles below New Harmony. It may easily be distinguished from other species of the genus by the lighter green of the leaves and by the bark of old stems being deeply fissured and not shreddy like the other species. It has the habit of climbing to great heights and small vines will soon overtop shrubs 15-25 feet high. In Knox County it was associated with *Aristolochia tomentosa*, competing for the top of shrubs and trees. Perry County, July 3, 1912.

Viola emarginata LeConte.

Laporte County, May 22, 1910. A few specimens found in the woods on the bank of an open ditch just west of the State Prison at Michigan City. It was associated with *Epigaea repens* and *Pinus Strobus*.

Viola pedata lineariloba DC.

Steuben County, August 13, 1903. Also found later in Laporte, Lake and Porter counties. In Steuben County it was found in dry sandy woods on the east side of Tamarack Lake. *Viola pedata* is frequent in all parts of this county, but the varietal form was noted but in the above locality. In the counties bordering Lake Michigan the varietal form only has been noted. It is frequent or common on the wooded sand dunes.

Kalmia latifolia L.

Crawford County, April 18, 1911. In anthesis on May 26, 1911. Found for about one-fourth mile on the top of a cliffy ravine about one mile east of Taswell. It is infrequent on the east bank, while on the west it is so thick that one can with difficulty get through it. It is generally 2-4 feet high, however, in favorable locations it grows larger. One specimen measured was 3 inches in diameter and 15 feet high. It is associated

on the top of the ravine with *Quercus velutina* and *Quercus alba*, and on the sides of the cliffs with *Tsuga canadensis* and *Betula lutea*. This species is said to occur also in Floyd County. In Coulter's catalogue of the plants of Indiana this species was included in the list of plants, the locations of which could not be verified. Perry and Martin counties.

Spigelia marylandica L.

Posey County, May 26, 1911. Just coming into anthesis. A few specimens only were found on the wooded bank on the southwest side of Hovey Lake. This species was reported for the State by Moffatt from Marion County. This is a southern species and is no doubt very rare in this State.

Monarda clinopodia L.

Ripley County, June 27, 1910. In anthesis on this date. In a beech and sugar maple woods, on the south side of the public road and on the west side of a ravine about one mile west of Morris. Brown and Jennings counties.

Lonicera canadensis Marsh.

Laporte County, May 2, 1911. In anthesis on this date. A few specimens 2-3 feet high were noted in a moist woods about nine miles northwest of Laporte.

Viburnum rufidulum Raf.

This species was reported by Young from Jefferson County in the Rept. Ind. Geol. Surv. 2:1871. It is no doubt rare but well distributed in the southern counties. It was collected this year on the sides of rocky ravines in Jefferson, Jennings, Lawrence and Washington counties.

Aster furcatus Burgess.

Tippecanoe County, September 7, 1902, along Wildcat Creek, near Lafayette, by H. B. Dorner. This specimen is in the writer's herbarium, and not until the species was collected again was it recognized as new to the State. Found also in Warren County at the narrows of the west tributary of Pine Creek about one mile north of Mudlavia on September 11, 1911. It is rare in this locality and was not noted again along Pine Creek for a distance of over three miles.

Galinsoga parviflora hispida DC.

Ripley County, June 27, 1910. Common in a few lots and adjacent street in Batesville.

Senecio plattensis Nutt.

Steuben County, May 25, 1905, on the north side of Clear Lake, associated with *Quercus velutina*. Noble County, June 20, 1910, on a wooded hillside just northwest of Rome City. Elkhart County near Middlebury.

Prenanthes altissima cinnamomea Fernald.

Wells County, October 2, 1904, and later in Allen, Clark, Dekalb, Morgan and Steuben counties. The writer has not seen *Prenanthes altissima* in the State and it is believed that only the variety occurs in our area.

Bluffton, Indiana.

THE UNATTACHED AECIAL FORMS OF PLANT-RUSTS IN NORTH
AMERICA.

BY A. G. JOHNSON.

Ever since the definite establishment of heteroecism in the Uredinales by DeBary in 1864 and 1865, many different aecial forms have been, one by one, properly connected with their respective telial forms, so that now the proper relationships are definitely known for a large number. On the other hand, there still remain a considerable number of aecial forms whose telial connections are still unknown.

The aecial forms of Uredineae are included mainly under the form-genera of *Cacoma*, *Peridermium*, *Roestelia* and *Accidium*. In this paper the treatment will be limited to the last named form-genus, viz: *Accidium*.

The genus *Accidium* was established by Persoon in Linné, *Systema Naturae* 2:1472. 1791, by the following brief generic description: "Theca (membranacea) utrinque glabra seminibus nudis non cohaerentibus plena." As now most generally accepted the diagnostic characters of the genus are: a more or less cupulate peridium, rupturing at apex, within which spores are borne in chains.

The genus was at first considered distinct and independent by the early botanists, yet practical farmers had for a long time observed and recognized the connection between rusted barberry bushes and rust on wheat in the fields, and were very certain that the former was a direct cause of the latter. To the end of protecting wheat from the disease due to this origin, a strict law providing for the destruction of all barberry bushes in Massachusetts was enacted as early as 1755, the same to take effect in 1760 and be in force for practically four years. Following this, various observations were made and experiments performed by different men, with varying degrees of conclusiveness. While observations and experiments had been previously made by Schroeter in 1816, DeBary was the first to show conclusively the exact succession of spore-forms in the life history of a heteroecious rust. He showed definitely by experiments

that aeciospores were produced on *Berberis* from infections from teliospores of *Puccinia poculiformis* from wheat, and thus definitely established heteroecism in the Uredineae in 1864. He also showed that urediniospores followed by teliospores were produced on wheat by sowing aeciospores from the barberry. DeBary's radical discovery was rather slow in being accepted by many other botanists, yet his evidence was indisputable and his interpretation prevailed.

Oersted, working independently and contemporaneously with DeBary, established similar alteration of spore forms on different hosts between the genera *Gymnosporangium* on cedars and *Rocstelia* on the apple family.

This was epoch-making work in this line and showed the necessity for accurate observations and most careful cultures to show the definite relationships of the different aecial forms. This work was taken up by botanists both in the old and new world and is still being carried on with much success. Early workers in Europe, beside DeBary and Oersted, were Fuckel, Magnus, Schröeter, Wolff, Rostrup, Winter, Nielson, Reichardt, Hartig, Rathay, Cornu and Plowright. More recent workers of the old world are Fischer, Klebahn, Tranzschel, von Tubenf, Wagner, Bubak, Juel, Hennings, Eriksson, Dietel, Liro and others.

In America Farlow and Thaxter did pioneer work, followed later, and with greater success, in this line by Arthur, Kellerman, Clinton, Kern and others. The work of Dr. J. C. Arthur stands out prominently above all others.

The methods used by the different workers are, in the main, very similar, viz: germinable spores of one stage are placed on sterile plants of the suspected alternate host. Conditions of heat and moisture being kept as favorable as possible throughout. In the methods used by Dr. Arthur, the perfectly healthy potted plants are kept covered with bell-jars for three days after the spore sowing is made. Each day the bell-jars are removed for five minutes or so to allow the entrance of a fresh supply of air, after which they are sprinkled within and replaced over the plants, and the plant thus covered is left in a shaded place until about a day after the bell-jar is removed. The inoculated leaves are then kept well moistened and kept out of too strong light and carefully watched for spore developments, especially after the first week. If the culture is successful the first spore structure will usually be evident in a week or ten days, followed later by the second spore structure, when that is pres-

ent, and thus showing definitely that the two alternate phases on wholly different plants belong to the same species of fungus.

Thus a large number of aecia have been properly assigned to their telial connection, and still many others remain to be thus connected.

At first the species of *Accidium* were placed in groups largely according to hosts, but as they were studied more closely, both microscopically and in cultures, it was found that often there occurred many forms on the same family of host plants, and often on the same host genus, several distinct species could be segregated. Even on the same host-species it was not infrequent to find more than one species of *Accidium*. As certain of these aecia were properly referred to their telial connections, these were separated as carefully as possible from the unattached forms and the latter remained to be studied further. In certain cases the definite morphological characters of the forms that are properly connected with their telial stages have made it possible to segregate definitely the attached forms from the unattached forms. In other cases where the morphological differences are less distinctive, and where certain physiological differences exist, the separation between the attached and unattached forms has been less definite, and in some cases it is impossible to make such separation with certainty until further cultures are made in order to help decide the matter. In making such separation of attached from unattached forms it is clear then that it is necessary to take into consideration not only the morphological characters of a species but also its physiological behavior in cultures.

It has been the purpose of this study to make such separation, farther than it had already been made, and to determine as far as possible the number of forms still unattached and to work out clues for probable connection wherever possible.

The forms of aecia whose telial connections still remain unknown, are arranged and follow in the form of an annotated list preceded by a provisional key, for convenience of reference. Under each species are given as far as possible the citation of the original description and date of publication, the hosts inhabited, the states and provinces in which the species has been found on each host, the type locality, type host, general distribution, and reference by number to specimens published in sets of exsiccati. Notes follow in most cases, especially where the form is especially striking, or where there are clues to relationship, or where there

is some question as to the definiteness regarding the placement of the form in the unattached list. Notes are also added in some other cases.

The arrangement in the list is according to host families and genera in the sequence used in Britton and Brown's Illustrated Flora of the Northern States and Canada, supplemented by Engler and Prantl's Natürliche Pflanzenfamilien in cases where the host is not within the range of the former work. The provisional key precedes this list and follows in this connection.

KEY TO THE UNATTACHED SPECIES OF AECIDIUM IN NORTH AMERICA.

I. Aecia scattered, arising from diffused mycelium:

- Host belonging to Urticaceae *A. libertum* 10
 Host belonging to Chenopodiaceae *A. Eurotiac* 12
 Host belonging to Caryophyllaceae *A. Cerastii* 15
 Host belonging to Fumariaceae *A. Dicentrac* 27
 Host belonging to Malvaceae:
 Aeciospores with thin walls:
 Peridia fugacious, aecia more or less elliptical
 in outline *A. tuberculatum* 48
 Peridia less fugacious, aecia practically circular
 in outline *A. sp.* 49
 Aeciospores with very thick walls..... *A. interveniens* 50
 Host belonging to Holoragidaceae *A. Prospinaccac* 59
 Host belonging to Boraginaceae *A. Myosotidis* 69
 Host belonging to Solonaceae *A. Physalidis* 72
 Host belonging to Scrophulariaceae *A. Collinsiac* 77
 Host belonging to Valerianaceae *A. Valerianellac* 86
 Host belonging to Cichoriaceae *A. Columbiense* 90

II. Aecia gregarious, arising from a limited mycelium:

- Host belonging to Scheuchzeriaceae *A. Triglochinis* 1
 Host belonging to Melanthaceae *A. Uvulariac* 2
 Host belonging to Liliaceae:
 Of the genus *Leucocrinum* *A. sp.* 3
 Of the genus *Anthericum* *A. sp.* 4
 Host belonging to Convallariaceae *A. Trillii* 5

Host belonging to Amaryllidaceae	<i>A. Zephranthis</i>	6
Host belonging to Iridaceae	<i>A. Iridis</i>	7
Host belonging to Myricaceae	<i>A. Myricatum</i>	8
Host belonging to Urticaceae	<i>A. Boehmeriae</i>	9
Host belonging to Loranthaceae	<i>A. sp.</i>	11
Host belonging to Allioniaceae:		
Of the genus <i>Abronia</i>	<i>A. Abroniae</i>	13
Of the genus <i>Mirabilis</i>	<i>A. Mirabilis</i>	14
Host belonging to Ranunculaceae:		
Of the genus <i>Caltha</i>	<i>A. sp.</i>	16
Of the genus <i>Actaea</i> , or <i>Cimicifuga</i>	<i>A. Cimicifugatum</i>	17
Of the genus <i>Delphinium</i>	<i>A. Delphinii</i>	18
Of the genus <i>Aconitum</i> :		
Aecia in rather large groups, not crowded.	<i>A. Aconiti-Napelli</i>	19
Aecia in small crowded groups.....	<i>A. circinans</i>	20
Of the genus <i>Anemone</i>	<i>A. Anemones</i>	21
Of the genus <i>Viorna</i>	<i>A. occidentale</i>	22
Of the genus <i>Ranunculus</i> :		
Aecia crowded in dense		
groups	<i>A. Ranunculaccarum</i> (in part)	23
Aecia less crowded.....	<i>A. Ranunculaccarum</i> (in part)	24
Of the genus <i>Thalictrum</i>	<i>A. Thalictri</i>	25
Host belonging to Berberidaceae	<i>A. Fendleri</i>	26
Host belonging to Saxifragaceae	<i>A. sp.</i>	28
Host belonging to Parnassiaceae	<i>A. Parnassiae</i>	29
Host belonging to Caesalpinaceae	<i>A. sp.</i>	30
Host belonging to Fabaceae:		
Of the genus <i>Baptisia</i>	<i>A. Kellermanni</i>	31
Of the genus <i>Psoralea</i>	<i>A. Onobrychidis</i>	32
Of the genus <i>Parosela</i>	<i>A. Daleae</i>	33
Of the genus <i>Petalostemon</i>	<i>A. Petalostemonis</i>	34
Of the genus <i>Lupinus</i>	<i>A. Lupini</i>	35
Of the genus <i>Apios</i> , or <i>Falcata</i>	<i>A. Falcatae</i>	36
Host belonging to Geraniaceae	<i>A. violascens</i>	37
Host belonging to Malpighiaceae	<i>A. Brysonimatis</i>	38
Host belonging to Rutaceae	<i>A. Xanthoxyli</i>	39
Host belonging to Polygalaceae	<i>A. polygalinum</i>	40

Host belonging to Euphorbiaceae:

Of the genus *Croton*, or *Crotonopsis* *A. crotonopsidis* 41Of the genus *Argithamnia* *A. Argithamniae* 42Of the genus *Mozinna* (*Jatropha*) *A. sp.* 43Of the genus *Sabastiana*, or *Stillingia*..... *A. Stillingiae* 44Host belonging to Hippocastanaceae *A. Aesculi* 45

Host belonging to Vitaceae:

Of the genus *Cissus*:Aeciospores rather large *A. Mexicanum* 46Aeciospores rather small *A. Cissi* 47

Host belonging to Malvaceae:

Of the genus *Sphaeralcea* *A. Sphaeralceae* 51Of the genus *Gossypium* *A. Gossypii* 52Host belonging to Fouquieriaceae *A. Cannonii* 53Host belonging to Passifloraceae *A. passifloricola* 54Host belonging to Thymelaceae *A. thymoideum* 55Host belonging to Elaeagnaceae *A. Allenii* 56Host belonging to Lythraceae *A. Ncsaeae* 57Host belonging to Onagraceae *A. Anograe* 58Host belonging to Primulaceae *A. Lysimachiae* 60

Host belonging to Apocynaceae:

Of the genus *Macrosiphonia* *A. leporinum* 61Of the genus *Apocynum*:Aeciospores small *A. Apocyni* 62Aeciospores large *A. obscum* 63Host belonging to Asclepidaceae *A. Brandegei* 64

Host belonging to Hydrophyllaceae:

Of the genus *Hydrophyllum* *A. Hydrophylli* 65Of the genus *Phacelia* *A. Phacelliae* 66Host belonging to Heliotropiaceae *A. Guatemalensis* 67

Host belonging to Boraginaceae:

Of the genus *Bourreria* *A. sp.* 68Of the genus *Lithospermum*, or *Onosmodium*..... *A. Onosmodii* 70Of the genus *Mertensia* *A. Mertensiae* 71

Host belonging to Solonaceae:

Of the genus *Chamaesarache* *A. sp.* 73Of the genus *Solanum* *A. tubulosum* 74

Host belonging to Scrophulariaceae:

- Of the genus *Chelone* *A. Chelonis* 75
 Of the genus *Pentstemon* *A. Palmeri* 76
 Of the genus *Azelia*, or *Dasystema*..... *A. Gerardiae* 78
 Of the genus *Castilleja* *A. micropunctum* 79
 Of the genus *Melampyrum* *A. sp.* 80

Host belonging to Acanthaceae *A. Tracyanum* 81

Host belonging to Rubiaceae:

- Of the genus *Houstonia* *A. Oldenlandianum* 82
 Of the genus *Bouvardia* *A. Bouvardiae* 83
 Of the genus *Randia* *A. pulverulentum* 84

Host belonging to Caprifoliaceae *A. Triostei* 85

Host belonging to Cichoriaceae:

- Of the genus *Lygodesmia* *A. Lygodesmiae* 87
 Of the genus *Crepis* *A. crepidicolum* 88
 Of the genus *Hieracium* *A. Hieraciatum* 89

Host belonging to Ambrosiaceae *A. sp.* 91

Host belonging to Carduaceae:

- Of the genus *Laciniaria* *A. Liatridis* 92
 Of the genus *Boltonia* *A. Boltoniae* 93
 Of the genus *Clibadium* *A. Clibadii* 94
 Of the genus *Montonoa* *A. Montonoae* 95
 Of the genus *Wedelia* *A. Wedeliae* 96
 Of the genus *Bahia*, or *Eriophyllum*..... *A. Bahiae* 97
 Of the genus *Senecio*:

Peridia short, not lacerate:

- Aecia rather small *A. Senecionis* 98
 Aecia rather large *A. sp.* 99

Peridia long, coarsely lacerate *A. Herrerianum* 100Of the genus *Coleosanthus*, *Chrysogonum*,*Chrysothamnus*, *Dugaldia*, *Helenium*, *Pol-**lymnia*, or *Rudbeckia*..... *A. compositarum* 101

1. *Accidium Triglochinis* D. & H. *Erythea* 7:98. 1899.

On SCHEUCHZERIACEAE:

Triglochis concinna Davy, California.

Triglochis sp., Nevada.

TYPE LOCALITY: Amedee, California, on *Triglochin concinna*.

DISTRIBUTION: Known only from Nevada and California.

There are no clues as to the relationship of this *Accidium*. It has, however, the habit of a heteroecious form.

2. *Accidium Uvulariae* Schw. Schr. Nat. Ges. Leipzig 1:69. 1822.

On MELANTHACEAE:

Uvularia grandiflora J. E. Smith, Iowa.

Uvularia perfoliata L., Iowa, Missouri, North Carolina.

Uvularia sessiliflora L., Delaware.

TYPE LOCALITY: Salem, North Carolina, on *Uvularia perfoliata*.

DISTRIBUTION: Delaware and North Carolina west to Iowa and Missouri.

Very similar to *Accidium Majanthae* Schum. with which it may belong. Cultures are necessary to determine the standing of these closely related forms.

3. *Accidium* sp.

On LILIACEAE:

Leucocrocinum montanum Nutt., Colorado.

DISTRIBUTION: Known only from Colorado.

There are no definite clues as to the relationship of this *Accidium*, but its telial stage is most likely to be a *Puccinia* on some grass.

4. *Accidium* sp.

On LILIACEAE:

Anthericum nanum Baker, Mexico.

Only one, the collection from the State of Mexico, known.

5. *Accidium Trillii* Burr. Bot. Gaz. 9:190. 1884.

On CONVALLARIACEAE:

Trillium grandiflorum (Michx.) Salisb., New York.

Trillium recurvatum Beck., Illinois.

TYPE LOCALITY: Pine Hills, Union Co., Illinois, on *Trillium recurvatum*.

Closely related to *Accidium Majanthae* Schum. with some race of which it may prove eventually to belong. Cultures are necessary to determine the point.

6. *Accidium Zephyranthis* Shear, Bull. Torr. Bot. Club 29:454. 1902.

On AMARYLIDACEAE:

Zephyranthes sp., Hidalgo, Mexico.

TYPE LOCALITY: Near Tlalpam, Valley of Mexico, Mexico, on *Zephyranthes* sp.

DISTRIBUTION: Central Mexico.

7. *Accidium Iridis* Ger. Rep. N. Y. Mus. 24:93. 1872.

On IRIDACEAE:

Iris versicolor L., Iowa, New York, Massachusetts, Minnesota, Nebraska, Wisconsin.

TYPE LOCALITY: Poughkeepsie, New York, on *Iris versicolor*.

DISTRIBUTION: New York, Massachusetts, west to Minnesota and Nebraska.

EXSICCATI: Ellis, N. Am. Fungi 1014; Roum. Fungi. Sel. 4917; Rab-
Wint. Fungi Eur. 2927; Thüm. Myc. Univ. 1519.

There is considerable question as to the relationship of this *Accidium*. It is very uncertain if it belongs with *Puccinia Iridis* (DC.) Wint. on the same host. It has been suggested that it may belong with a *Carex*-inhabiting *Puccinia*. Cultures are necessary to settle the point.

8. *Accidium Myricatum* Schw. Trans. Am. Phil. Soc. II. 4:294. 1832.

On MYRICACEAE:

Myrica cerifera L., Delaware, New Jersey, New York.

Myrica Carolinensis Mill., Connecticut, New Jersey.

TYPE LOCALITY: New York, on *Myrica cerifera*.

DISTRIBUTION: New York, New Jersey, Connecticut and Delaware.

EXSICCATI: Ellis, N. Am. Fungi 230; Ellis & Ev. Fungi Columb. 62;
Roum. Fungi Sel. 4835; Thüm. Myc. Univ. 1224.

A conspicuous, characteristic *Accidium* of rather limited range.

9. *Accidium Boehmeriae* Arth. Bull. Torr. Bot. Club 34:590. 1907.

On URTICACEAE:

Boehmeria cylindrica (L.) Willd., District of Columbia.

TYPE LOCALITY: Takoma Park, District of Columbia, on *Boehmeria cylindrica*.

DISTRIBUTION: Known only from type locality.

This is very similar to *Accidium Urticae* Schum., which is connected with *Puccinia Caricis* (Schum.) Schröt. on *Carex*, except for having smaller aeciospores and peridia more delicate in general. Repeated trial sowings of *Puccinia Caricis* on *Boehmeria* have uniformly failed, while infections have been easily obtained on *Urtica*. This species of *Accidium* is therefore no doubt distinct and may belong with some other *Carex*-inhabiting *Puccinia*.

10. *Accidium libertum* Arth. Bull. Torr. Bot. Club 37:580. 1910.

On URTICACEAE:

Urtica chamaedryoides Pursh, Oklahoma.

TYPE LOCALITY: Sapulpa, Oklahoma [Indian Territory], on *Urtica chamaedryoides*.

DISTRIBUTION: Known only from type locality.

A very characteristic species. No clues as to possible telial connection. It may, however, belong with some telial form inhabiting some host other than a grass or sedge.

11. *Accidium* sp.

On LORANTHACEAE:

Loranthus sp., Guatemala.

This is doubtless an undescribed species. It does not agree with previously described species on this host.

12. *Accidium Eurotiae* E. & E. Jour. Myc. 6:119. 1891.

On CHENOPODIACEAE:

Eurotia lanata (Pursh) Moq. Montana, New Mexico, Wyoming.

TYPE LOCALITY: Helena, Montana, on *Eurotia lanata*.

DISTRIBUTION: Montana south to New Mexico.

EXSICCATI: Ellis & Ev. N. A. F. 2709; Ellis & Ev. Fungi Columb. 271.

13. *Accidium Abroniae* Ellis & Everhart n. sp. (Ined.)

On ALLIONIACEAE:

Abronia micrantha (Torr.) Chois.?, Colorado.

Abronia umbellata Lam., California.

TYPE LOCALITY: Ft. Collins, Colorado, on *Abronia* sp.

DISTRIBUTION: Colorado and westward.

As far as the writer can determine this species has never been published. The name appears to be only an herbarium name by Ellis & Everhart. The species is no doubt distinct.

14. *Accidium Mirabilis* D. & H. Bot. Gaz. 24:37. 1897.

On ALLIONIACEAE:

Mirabilis sp., Mexico.

TYPE LOCALITY: Rio Hondo, near City of Mexico, Mexico, on *Mirabilis* sp.

DISTRIBUTION: Known only from type locality.

No specimen seen.

15. *Accidium Cerastii* Wint. Jour. Myc. 1:126. 1885.

On CARYOPHYLLACEAE:

Cerastium nutans Raf., Missouri.

TYPE LOCALITY: Perryville, Missouri, on *Cerastium nutans*.

DISTRIBUTION: Known only from Missouri.

A rare species of the typical perennial type judging from the description, no specimen has ever been examined.

16. *Accidium* sp.

On RANUNCULACEAE:

Caltha leptosepala DC., British Columbia.

DISTRIBUTION: Only one collection known.

Probably followed by the telial stage, (*Puccinia*), on the same host, only not yet collected.

This is doubtless a new species collected by Professor E. W. D. Holway on north moraine, Mt. Sanford, Glacier, British Columbia, July, 1910.

17. *Accidium Cimicifugatum* (Schw.) Berk. Grev. 3:60. 1874.

Cacoma (*Accidium*) *Cimicifugatum* Schw. Trans. Am. Phil. Soc. II. 4:293. 1832.

Accidium Actaeae Authors. Not Opiz.

On RANUNCULACEAE:

Cimicifuga racemosa (L.) Nutt. (*Actaea racemosa* L.), Pennsylvania, New York, Ohio, Virginia; Ontario.

Actaea alba (L.) Mill., Iowa, Minnesota, Ohio, Wisconsin.

Actaea rubra (Ait.) Willd. (*A. spicata rubra* Ait.), New York.

TYPE LOCALITY: Bethlehem, Pennsylvania, on *Cimicifuga racemosa*.

DISTRIBUTION: United States east of the Mississippi River, especially northward.

EXSICCATI: Ravenel, Fungi Car. 1:94; Sydow, Ured. 1343; Rab.-Wint. Fungi Eur. 3420; Kellerm. Ohio Fungi 61; Ellis, N. Am. Fungi 227.

18. *Accidium Delphinii* Barth. Jour. Myc. 8:173. 1902.

Accidium Batesianum Barth. Ellis & Everhart's Fungi Columb. 20:1901. 1904.

On RANUNCULACEAE:

Delphinium albescens Rydb., Nebraska.

Delphinium bicolor Nutt., Montana.

Delphinium Carolinianum Walt. (*D. azurcum* Michx.), Colorado.

Delphinium cuculatum A. Nelson, Montana.

Delphinium geraniifolium Rydb., Colorado.

Delphinium Geyeri Greene, Colorado.

Delphinium Nelsoni Greene, Idaho.

Delphinium robustum Rydb., Colorado, Nebraska.

DISTRIBUTION: Colorado and northward.

TYPE LOCALITY: Steamboat Springs, Colorado, on *Delphinium scopulorum*, later referred to *D. geraniifolium*.

EXSICCATI: Ellis & Ev. Fungi Columb. 1901; Clements, Crypt. Form. Colo. 151.

This *Accidium* becomes very abundant in Colorado some years. Its telial connection is probably some grass-inhabiting *Puccinia*. In 1907, Dr. J. C. Arthur and Mr. F. D. Kern found it "growing intermixed with *Elymus condensatus* covered with *Puccinia montanensis*," and this may prove to be the connection.

19. *Accidium Aconiti-Napelli* (DC.) Wint. Die Pilze p. 268. 1881.

On RANUNCULACEAE:

Aconitum Columbianum Nutt., Colorado.

Aconitum sp., Colorado.

DISTRIBUTION: Known from Colorado only.

EXSICCATI: Ellis & Ev. N. Am. Fungi 2212.

This *Accidium* is very similar to *Accidium Delphinii* Barth. with which it may ultimately prove to be identified.

20. *Accidium circinans* Erikss. Bot. Centralbl. n. 36:297. 1891.

On RANUNCULACEAE:

Aconitum Delphinifolium DC., Alaska.

TYPE LOCALITY: Sweden, on *Aconitum Lycoctonum* L.

DISTRIBUTION: Known only from Alaska. Also in Europe.

Little is known regarding this *Accidium*. It may prove to be the aecial stage of an autoecious *Uromyces* similar to *Uromyces Aconiti-Lycoctoni* (DC.) Wint., the aecial stage of which it greatly resembles.

21. *Accidium Anemones* Am. Authors.

On RANUNCULACEAE:

Anemone narcissiflora L., Alaska.

Anemone Virginiana L., Indiana, Iowa, Wisconsin; Ontario.

DISTRIBUTION: Northern Mississippi and northward.

22. *Accidium occidentale* Arth. Bull. Torr. Bot. Club 31:7. 1904.

On RANUNCULACEAE:

Vioria Douglasii (Hook.) (*Clematis Douglasii* Hook.), Idaho, Washington.

Vioria Wyethii (Nutt.) Rydb., Montana, Washington.

TYPE LOCALITY: Pullman, Washington, on *Clematis Douglasii*.

DISTRIBUTION: Montana to Washington.

23. *Accidium Ranunculacearum* DC. (in part).

On RANUNCULARACEAE:

Ranunculus ellipticus Greene, North Dakota.

Ranunculus glaberrimus Hook., Idaho, Montana, Washington.

Ranunculus scleratus L., North Dakota.

DISTRIBUTION: Northern Mississippi valley west to Washington.

The aecia on the above named hosts resemble very closely the *Accidium* on *Oxygraphis Cymbalaria* (Pursh) Prantl. which belongs with *Puccinia cinerea* Arth. on *Poa*, and may be shown by cultures to belong with it. This is especially likely since its range practically coincides with that of this *Puccinia*.

24. *Accidium Ranunculaccarum* DC. (in part).

On RANUNCULACEAE:

Cyrtorhyncha ranunculina Nutt., Colorado.

Ranunculus bulbosus L., Connecticut.

Ranunculus recurvatus Poir., Missouri.

DISTRIBUTION: Connecticut west to Colorado and Missouri.

These differ slightly from the preceding by the peridia being much less crowded and the substratum not being thickened. They may prove to be different.

25. *Accidium Thalictri* Am. Authors.

On RANUNCULACEAE:

Isopyrum biternatum (Raf.) T. & G., Iowa.

Syndesmon thalictroides (L.) Hoffm., Indiana, Missouri.

Thalictrum dioicum L., Massachusetts, Minnesota, Vermont.

Thalictrum polygamum Muhl., Colorado.

Thalictrum purpurascens L., Nebraska, South Dakota, Wisconsin.

Thalictrum thyrsoideum Greene, North Dakota.

Thalictrum sp., Idaho; Newfoundland.

DISTRIBUTION: Northern United States and Canada.

EXSICCATI: Barth. Fungi Columb. 2405; Brenckle, Fungi Dak. 104;

Ellis & Ev. Fungi Columb. 1390; Rab.-Wint. Fungi Eu. 3322; Rab.-

Wint.-Paz. Fungi Eu. 3836.

The accia on *Thalictrum* and related hosts are very closely related, and cultures are necessary to segregate them with certainty. These placed together here are slightly different as to form and habit from those already connected with *Bromus* and *Agropyron*-inhabiting *Puccinac*.

26. *Accidium Fendleri* Tracy & Earle, Pl. Baker. 1:17. 1901.

On BERBERIDACEAE:

Berberis Fendleri A. Gray, Colorado.

TYPE LOCALITY: Mancos, Colorado, on *Berberis Fendleri*.

DISTRIBUTION: Known only from Colorado.

This differs slightly in habit from *Accidium Berberidis* and may prove distinct, although it is very similar.

27. *Accidium Dicentrae* Trel. Trans. Wis. Acad. Sci. 6:136. (Nov.) 1884.

Accidium Dicentrae Burr. Bot. Gaz. 9:189. (Dec.) 1884.

On FUMARIACEAE:

Dicentra Cucullaria (L.) Bernh., Illinois, Indiana, Iowa, Kansas, Missouri, Nebraska, New York, Pennsylvania, South Dakota, Wisconsin.

TYPE LOCALITY: Madison, Wisconsin, on *Dicentra Cucullaria*.

ENSICCATI: Ellis & Ev. Fungi Columb. 1903; Kell. & Swingle, Kans. Fungi 2; Sydow, Ured. 497.

A characteristic species of wide range. It doubtless has its telial stage on some host other than a grass or sedge. Its pycnia are subcuticular.

28. *Accidium* sp.

On SAXIFRAGACEAE:

Mitella nuda L., Newfoundland.

Only the one collection known from Shoal Point, Bay of Islands, Newfoundland. No doubt a distinct species.

29. *Accidium Parnassiac* (Schl.) Grav. Duby Bot. Gall. 2:904. 1830.
Caeoma Parnassiac Schl. Fl. Berol. 2:113. 1824.

On PARNASSIACEAE:

Parnassia palustris L., Alaska.

TYPE LOCALITY: Berlin, Germany, on *Parnassia palustris*.

DISTRIBUTION: In America, known only from Alaska.

In Europe this is considered the aecial stage of *Puccinia uliginosa* Juel, which it may also prove to be in America.

30. *Accidium* sp.

Accidium Cassiae E. & K. Trans. Kans. Acad. 10:91. 1887. (nomen nudum) not *Acc. Cassiae* Bres.

On CAESALPINACEAE:

Cassia Chamaecrista L., Kansas, Nebraska.

TYPE LOCALITY: Manhattan, Kansas, on *Cassia Chamaecrista*.

DISTRIBUTION: Central Mississippi valley.

This *Accidium* differs decidedly from *Acc. Cassiae* Bres. in having considerably smaller spores than the African species, and is without question distinct from it. Ellis & Kellerman's name was never established, as far as the writer can determine and not now an available one. This being the case, this *Accidium* is still unnamed.

31. *Accidium Kellermanni* DeT. Sacc. Syll. 7:788. 1888.

Accidium amphigenum Ellis & Kell. Jour. Myc. 2:4. 1886. not *A. amphigenum* Hazsl. 1877.

On FABACEAE:

Baptisia australis (L.) R. Br., Kansas.

Baptisia bracteata Ell. (*B. leucophaea* Nutt.), Kansas.

TYPE LOCALITY: Manhattan, Kansas, on "*Baptisia leucophaea*."

DISTRIBUTION: Known only from Kansas.

32. *Accidium Onobrychidis* Burrill, Bot. Gaz. 9:189. 1884.

On FABACEAE:

Psoralea onobrychis Nutt., Illinois.

TYPE LOCALITY: LaSalle County, Illinois, on *Psoralea onobrychis*.

DISTRIBUTION: Known only from Illinois.

EXSICCATI: Ellis & Ev. N. Am. Fungi 1826.

This is no doubt heteroecious and probably belongs with some unattached *Uromyces*. It is characteristically distinct from the aecial stage of *Uromyces Psoraleae* Pk., which has scattered aecia and is followed by teliospores, without an intervening uredinial stage.

33. *Accidium Dalcae* Kellerm. & Sw. Jour. Myc. 5:13. 1889.

On FABACEAE:

Parosela enncandra (Nutt.) Britton (*Dalca lariflora* Pursh), Kansas, Nebraska.

TYPE LOCALITY: Rockport, Kansas, on "*Dalca lariflora*."

DISTRIBUTION: Nebraska and Kansas.

EXSICCATI: Barth. Fungi Columb. 3301; Shear, Ell. & Ev. Fungi Columb. 1473; Sydow, Ured. 1448.

A characteristic species. Very abundant in Kansas some seasons, becoming rather destructive to host plants.

34. *Accidium Petalostemonis* Kellerm. & Carl.; Arth. Bull. Torr. Bot. Club 34:589. 1907.

Accidium fluxum Arth. Bull. Torr. Bot. Club 34:590. 1907.

On FABACEAE:

Petalostemon candidus (Willd.) Michx., Kansas, Nebraska.

Petalostemon multiflorus Nutt., Kansas.

Petalostemon oligiophyllus (Torr.) Rydb., Nebraska.

Petalostemon purpureus (Vent.) Rydb. (*P. violaceus* Michx.), Kansas, Nebraska.

Petalostemon villosus Nutt., Colorado, Nebraska.

TYPE LOCALITY: Manhattan, Kansas, on *Petalostemon candidus*.

DISTRIBUTION: Nebraska and Kansas west to Colorado.

EXSICCATI: Barth, Fungi Columb. 2296, 2497, 2604, 2903; Clements, Crypt. Form. Colo. 595; Ellis & Ev. N. Am. Fungi 1845.

Similar to *Aecidium Daleae* K. & S. in general habit, but has thinner walled and slightly smaller aecisporae. It is no doubt distinct and heteroecious.

35. *Aecidium Lupini* Peck, Rep. N. Y. State Mus. 46:33. 1893.

On FABACEAE:

Lupinus perennis L., New York.

TYPE LOCALITY: Karner, New York, on *Lupinus perennis*.

DISTRIBUTION: Known only from the type locality.

This form differs somewhat from the aecia common in the western mountains belonging to *Uromyces Lupini* B. & C. The type locality is within a few miles of Albany, and it is difficult to explain why it has not been met with a second time.

36. *Aecidium Falcatae* Arth. Bull. Torr. Bot. Club 33:32. 1906.

On FABACEAE:

Falcata comosa (L.) Kuntze (*Amphicarpa monoica* Ell.), Illinois, Iowa, Minnesota, Wisconsin.

Apios Apios (L.) MacM. (*A. tuberosa* Moench.), Iowa, Minnesota, Nebraska.

TYPE LOCALITY: Decorah, Iowa, on *Falcata comosa*.

DISTRIBUTION: Upper Mississippi valley.

EXSICCATI: Barth, Fungi Columb. 2303; Barth, N. Am. Ured. 1; Ellis, N. Am. Fungi 1435.

A distinct species, probably of some *Uromyces* connection.

37. *Aecidium violascens* Trel.; Sacc. Pk. & Trel. Harriman Alaska Exped. 5:37. 1904.

On GERANIACEAE:

Geranium erianthum DC., Alaska.

TYPE LOCALITY: Kadiak, Alaska, on *Geranium orianthum*.

DISTRIBUTION: Known only from Alaska.

This differs from *Accidium sanguinolentum* Lindr., which belongs with *Puccinia polygoni-amphibii* Pers., in having the peridia less exserted and less recurved, and in having larger spores.

38. *Accidium Byrsonimatis* P. Henn. Hedwigia 34:101. 1895.

Accidium byrsonimaticola P. Henn. Hedwigia 34:322. 1895.

Tandophyllum singulare Diet. & Holw. Bot. Gaz. 31:336. 1901.

Accidium Byrsonimae Kern & Kellerm. Jour. Myc. 13:24. 1907.

On MALPIGIACEAE:

Byrsonima crassifolia (L.) DC., Guatemala, Jalisco.

TYPE LOCALITY: Goyaz, Brazil, on *Byrsonima* sp.

DISTRIBUTION: Central Mexico and southward. Also in South America.

A strikingly characteristic form with conspicuous peridia; often produces hypertrophy.

39. *Accidium Xanthoxyli* Peck, Bot. Gaz. 6:275. 1881.

On RUTACEAE:

Xanthoxylum americanum Nutt., Iowa, Kansas, Missouri, Nebraska.

Xanthoxylum Clava-Herculis L. (*X. Carolinianum* Lam.), Texas.

Xanthoxylum Clava-Herculis fruticosum (A. Gray) S. Wats., Alabama.

TYPE LOCALITY: Decorah, Iowa, on *Xanthoxylum americanum*.

DISTRIBUTION: Iowa and Nebraska south to Texas and Alabama.

ENSICCATI: Carleton, Ured. Am. 6; Barth. N. Am. Ured. 102; Ellis, N. Am. Fungi 1013; Ellis & Ev. Fungi Columb. 1477; Rab.-Wint. Fungi Eur. 2928; Sydow, Ured. 1548.

A characteristic species, probably belonging with some grass-inhabiting *Puccinia*.

40. *Accidium polygalinum* Peck, Bot. Gaz. 6:275. 1881.

On POLYGALACEAE:

Polygala Senega L., Iowa, Michigan, Wisconsin.

TYPE LOCALITY: Ann Arbor, Michigan, on *Polygala Senega*.

DISTRIBUTION: Upper Mississippi valley.

EXSICCATI: Ellis, N. Am. Fungi 1009; Rab.-Wint. Fungi. Eur. 3319; Sydow, Ured. 1396.

A distinct species of rather limited range.

41. *Accidium crotonopsidis* Burr. Bot. Gaz. 9:190. 1884.

Accidium splendens Wint. Rab.-Wint. Fungi Eur. 3224. 1885.

On EUPHORBIACEAE:

Croton monanthogynus Michx., Illinois, Missouri.

Crotonopsis linearis Michx., Illinois.

TYPE LOCALITY: Johnson County, Illinois, on *Crotonopsis linearis*.

DISTRIBUTION: Central Mississippi valley.

EXSICCATI: Ellis & Ev. N. Am. Fungi 1824; Rab.-Wint. Fungi Eur. 3224; Roum. Fungi Gall. Exs. 3860.

No doubt a heteroecious species.

42. *Accidium Argithamniac* Arth. Bull. Torr. Bot. Club 33:33. 1906.

On EUPHORBIACEAE:

Argithamnia Schiediana Müll.-Arg., Hidalgo.

TYPE LOCALITY: Trinidad, State of Hidalgo, Mexico, on *Argithamnia Schiediana*.

DISTRIBUTION: Known only from the type locality.

43. *Accidium* sp.

On EUPHORBIACEAE:

Mozinna spathulata (Müll.-Arg.) Ortega (*Jatropha spathulata* Müll.-Arg.), Guanajuato.

DISTRIBUTION: Only one collection known.

Doubtless a distinct species of heteroecious connection.

44. *Accidium Stillingiac* Tracy & Earle, Bull. Torr. Bot. Club 26:492. 1899.

On EUPHORBIACEAE:

Sebastiana ligustrina (Michx.) Muell.-Arg. (*Stillingia ligustrina* Michx.), Mississippi.

Stillingia sylvatica L., Florida.

TYPE LOCALITY: Wisdom, Mississippi, on "*Stillingia ligustrina*."

DISTRIBUTION: Mississippi to Florida.

45. *Accidium Aesculi* Ellis & Kell. Bull. Torr. Bot. Club **11**:114. 1884.

On HIPPOCASTANACEAE:

Aesculus arguta Buckley, Kansas.

Aesculus glabra Willd., Kansas, Nebraska.

TYPE LOCALITY: Manhattan, Kansas, on *Aesculus glabra*.

DISTRIBUTION: Central Mississippi valley.

EXSICCATI: Barth. Fungi Columb. 2301; Ellis, N. Am. Fungi 1429;

Ellis & Ev. Fungi Columb. 1296; Kell. & Swingle, Kans. Fungi 1;

Roum. Fungi Gall. 3865; Sydow, Ured. 1198.

Bartholomew (Trans. Kans. Acad. Sci. **16**:186.) reports that this striking *Accidium* was so abundant on several small trees of *A. arguta* in Rooks County, Kansas, in 1897, that it became quite destructive.

46. *Accidium mexicanum* D. & H. Bot. Gaz. **24**:36. 1897.

On VITACEAE:

Cissus sp., Mexico.

TYPE LOCALITY: Near City of Mexico, Mexico, on *Cissus* sp.

DISTRIBUTION: Known only from type locality.

Distinguishable from *Acc. Cissi* Wint. by having larger spores.

47. *Accidium Cissi* Wint. Hedwigia **23**:168. 1884.

On VITACEAE:

Cissus sicyoides L., Guatemala, Jamaica, Porto Rico.

TYPE LOCALITY: Near Sao Francisco, Brazil, on *Cissus* "*Syciaefolius*."

DISTRIBUTION: West Indies and Guatemala; also in South America.

48. *Accidium tuberculatum* Ellis & Kellerm. Jour. Myc. **4**:26. 1888.

On MALVACEAE:

Callirrhoe alceoides (Michx.) A. Gray, Colorado.

Callirrhoe involucrata (T. & G.) A. Gray, Kansas, Nebraska.

Sidalcea candida A. Gray, Wyoming.

TYPE LOCALITY: Rooks County, Kansas, on *Callirrhoe involucrata*.

DISTRIBUTION: West central Mississippi valley.

EXSICCATI: Carleton, Ured. Am. 31; Kellerm. & Sw. Kans. Fungi 30;

Rab.-Paz. Fungi Eur. 4239; Sydow, Ured. 1199.

An especially characteristic species. Its telial connection is doubtless something other than a grass- or sedge-inhabiting rust.

49. *Accidium* sp.

On MALVACEAE:

Althaea rosea L., Nebraska.

Sidalcea candida A. Gray, Colorado.

Sidalcea Neo-Mexicana A. Gray, Colorado.

DISTRIBUTION: Colorado and Nebraska.

A distinct species formerly confused with *Accidium interveniens* Pk. (*A. roestelioides* E. & E.) and *Accidium tuberculatum* E. & K. Its thin-walled spores readily distinguish it from the former and the form of its aecia, which are circular in outline, distinguish it from the latter.

50. *Accidium interveniens* (Peck) Farl. Bibl. Index N. Am. Fungi 1:58. 1905.

Roestelia interveniens Peck, Bull. Torr. Bot. Club 10:74. 1883.

Accidium roestelioides E. & E. Jour. Myc. 1:93. 1885.

On MALVACEAE:

Callirrhoe alceoides (Michx.) A. Gray, Nebraska.

Callirrhoe digitata Nutt., Texas.

Malvastrum marrubioides Dur. & Hilg., California.

Malvastrum Thurberi A. Gray, Lower California.

Sidalcea asprella Greene, California.

Sidalcea candida A. Gray, Washington.

Sidalcea delphinifolia (Nutt.) Greene, California.

Sidalcea humilis A. Gray, California.

Sidalcea malvaefolia (Moc. & Seese) A. Gray, California.

Sidalcea Neo-Mexicana A. Gray, Colorado.

Sidalcea rivularis, Washington.

TYPE LOCALITY: Lower California, on *Malvastrum Thurberi*.

DISTRIBUTION: Nebraska south to Texas, west to Lower California and Washington.

EXSICCATI: Barth. Fungi Columb. 2401, 3201; Clements, Crypt. Form. Colo. 600.

A strikingly characteristic species readily distinguishable by its very thick-walled spores and deeply lacerate peridium.

The names *Accidium roestelioides* E. & E. and *Accidium interveniens* (Pk.) Farl. are here considered as synonyms. Type material has been examined and the two species are thought to be the same. The latter species name has priority, hence becomes the accepted species name.

51. *Accidium Sphaeralceae* E. & E. Bull. Torr. Bot. Club. **22**:364. 1895.

On MALVACEAE:

Sidalcea candida A. Gray, Colorado.

Sphaeralcea angustifolia Dcn., New Mexico.

TYPE LOCALITY: Las Cruces, New Mexico, on *Sphaeralcea angustifolia*.

DISTRIBUTION: Colorado and New Mexico.

EXSICCATI: Ellis & Ev. N. Am. Fungi 335; Ellis & Ev. Fungi Columb. 871.

There is no definite evidence that this form belongs with *Puccinia Sphaeralceae* E. & E., with which it sometimes occurs and with which it has been listed. It has the appearance of a heteroecious form and is so regarded here. Its telial form is likely to be a *Puccinia* on some grass. It may possibly belong with *Puccinia Boehmia* B. & C.

52. *Accidium Gossypii* E. & E. Eryth. 5:6. 1897.

On MALVACEAE:

Gossypium herbaceum L., Texas.

Gossypium sp., California, Lower California; Mexico.

TYPE LOCALITY: California, on *Gossypium* sp.

DISTRIBUTION: Texas to California, south to Mexico.

A rarely collected species. It may possibly belong with the aecia of *Puccinia Boehmia* B. & C.

53. *Accidium Cannonii* Griff. Bull. Torr. Bot. Club **34**:210. 1907.

On FOUQUIERIACEAE:

Fouquieria splendens Engelm., Arizona.

TYPE LOCALITY: Sabino Cañon, Santa Catalina mountains, Arizona, on *Fouquieria splendens*.

DISTRIBUTION: Known only from type locality.

A characteristic species with long peridia.

54. *Accidium passifloricola* P. Henn. Hedwigia **43**:168. 1904.

On PASSIFLORACEAE:

Passiflora rubra L., Jamaica, Porto Rico.

TYPE LOCALITY: Tarapoto, Peru, on *Passiflora* sp.

DISTRIBUTION: West Indies, also in South America.

55. *Accidium hydnoideum* B. & C. Grev. 3:61. 1874.

On THYMELACEAE:

Dirca palustris L., Alabama, Indiana, Iowa, Maine, Michigan, Minnesota, Missouri, New York, Ohio, Wisconsin.

TYPE LOCALITY: Alabama, on *Dirca palustris*.

DISTRIBUTION: New York west to Minnesota, south to Alabama.

EXSICCATI: Ellis & Ev. N. Am. Fungi 1816; Rab.-Wint. Fungi Eur. 3017; Ravenel, Fungi Car. 4:94; Roum. Fungi Gall. 3862; Thüm. Myc. Univ. 1126.

There are no definite clues as to relationship for this characteristic, conspicuous *Accidium*. It is of the typical heteroecious type and may possibly belong with some heteroecious telial form, within its range, on a host other than a grass or sedge.

56. *Accidium Allenii* Clinton, Peck, Ann. Rep. N. Y. Mus. 24:93. 1872.

On ELAEAGNACEAE:

Elacagnus argentea Pursh, Montana, North Dakota; Assiniboia.

Lepargyrea argentata (Nutt.) Greene, Colorado, Nebraska, Wyoming.

Lepargyrea Canadensis (L.) Greene (*Shepherdia Canadensis* L.), Colorado, Michigan, Montana, New Mexico, New York, South Dakota, Washington, Wisconsin, Wyoming; Alberta, Yukon.

TYPE LOCALITY: Buffalo, New York, on *Shepherdia Canadensis*.

DISTRIBUTION: Northern United States, western Canada to Alaska.

EXSICCATI: Ellis & Ev. N. Am. Fungi 1815; Ellis & Ev. Fungi Columb. 1702; Griff. W. Am. Fungi 297; Rab.-Wint.-Paz. Fungi Eur. 4039. Roum. Fungi sel. 4412.

From field observations, Prof. E. W. D. Holway is reasonably certain that this *Accidium* belongs with a coronate *Puccinia* inhabiting *Agropyron* and *Elymus* in the Canadian Rockies. Later Mr. E. Bethel found the same coronate form on *Bromus* and *Calamagrostis* in the mountains of Colorado intimately associated with the same *Accidium*. From the geographical distribution of these alternate forms, this connection seems very likely.

57. *Accidium Nesaeae* Ger. Bull. Torr. Bot. Club 4:47. 1873.

On LYTHRACEAE:

Decodon verticillatus (L.) Ell. (*Nesaea verticillata* H. B. K.). Delaware, Massachusetts, Michigan, New York, Ohio, Wisconsin.

TYPE LOCALITY: Poughkeepsie, New York, on *Nesaea verticillata*.

DISTRIBUTION: New York and Massachusetts, west to Michigan and Wisconsin.

EXSICCATI: Ellis, N. Am. Fungi 1015; Ellis & Ev. Fungi Columb. 197; Kellerm. Ohio Fungi 91; Rab.-Wint. Fungi Eur. 3019.

No telial form is known on this host. *Puccinia Nesucae* E. & E. was described from material erroneously supposed to be on *Nesaea verticillata*, but subsequently ascertained to be on *Ludwigia polycarpa*, belonging to the family *Onagraceae*. The form is probably heteroecious.

58. *Accidium Anograe* Arth. Bull. Torr. Bot. Club 28:664. 1901.

On ONAGRACEAE:

Anogra pallida (Lindl.) Britton, Nebraska.

TYPE LOCALITY: Long Pine, Nebraska, on *Anogra pallida*.

DISTRIBUTION: Known only from Nebraska.

EXSICCATI: Barth. Fungi Columb. 2601.

Distinguishable from *Accidium Peckii* DeT. which belongs with *Puccinia Peckii* (DeT.) Kellerm. by having larger and rougher spores.

59. *Accidium Proserpinaccac* B. & C. Grev. 3:60. 1874.

On HALORAGIDACEAE:

Proserpinacca sp., Alabama.

TYPE LOCALITY: Alabama, on leaves of *Proserpinacca*.

DISTRIBUTION: Known only from type locality.

60. *Accidium Lysimachiac* Schw. Schr. Nat. Ges. Leipzig 1:67. 1822.

On PRIMULACEAE:

Lysimachia quadrifolia L., Connecticut, New York, North Carolina.

Lysimachia terrestris (L.) B. S. P. (*L. stricta* A. Gr.), Connecticut, Delaware, North Carolina, Pennsylvania.

TYPE LOCALITY: Salem, North Carolina, on *Lysimachia quadrifolia*.

DISTRIBUTION: New York south to North Carolina.

EXSICCATI: Ellis, N. Am. Fungi 1424; Ellis & Ev. N. Am. Fungi 1424b. Possibly belongs with some *Carex*-inhabiting *Puccinia*.

61. *Accidium Ichorinum* Arth. Bull. Torr. Bot. Club 37:578. 1910.

On APOCYNACEAE:

Macrosiphonia brachysiphon (Torr.) A. Gray, Chihuahua.

TYPE LOCALITY: Guayanoba Cañon, Sierra Madre Mountains, State of Chihuahua, Mexico, on *Macrosiphonia brachysiphon*.

DISTRIBUTION: Known only from type locality.

62. *Accidium Apocyni* Schw. Schr. Nat. Ges. Leipzig 1:68. 1822.

On APOCYNACEAE:

Apocynum cannabinum L., District of Columbia.

Apocynum pubescens R. Br., Delaware, New Jersey, North Carolina.

TYPE LOCALITY: Salem, North Carolina, on *Apocynum cannabinum*.

DISTRIBUTION: New Jersey south to North Carolina.

EXSICCATI: Ellis & Ev. Fungi Columb. 1295.

An eastern species characterized by its small spores.

63. *Accidium obscum* Arth. Bull. Torr. Bot. Club 37:579. 1910.

On APOCYNACEAE:

Apocynum hypericifolium Ait., Illinois, Kansas, Nebraska.

TYPE LOCALITY: Manhattan, Kansas, on *Apocynum hypericifolium*.

DISTRIBUTION: Illinois west to Nebraska and Kansas.

EXSICCATI: Ellis & Ev. N. Am. Fungi 1823; Vestergren, Micr. Rar. Sel. 1101.

A western species readily distinguishable from *Accidium Apocyni* Schw. by having much larger asciospores.

64. *Accidium Brandegei* Peck, Bot. Gaz. 3:34. 1878.

On ASCLEPIADACEAE:

Asclepias pumila (A. Gray) Vail, Kansas.

Asclepias subverticellata (A. Gray) Vail, New Mexico.

Asclepias verticellata L., Colorado, Nebraska, South Dakota.

Philibertella Hartwegii Vail, Chihuahua.

Philibertella Hartwegii heterophylla (Engelm.) Vail, Arizona.

TYPE LOCALITY: Colorado, on *Asclepias verticellata*.

DISTRIBUTION: South Dakota to Kansas, west to New Mexico and Arizona, south into Mexico.

A striking species often causing considerable hypertrophy.

65. *Accidium Hydrophylli* Peck, Bull. Buff. Soc. 1:68. 1873.

On HYDROPHYLLACEAE:

Hydrophyllum albifrons Heller, Idaho.

Hydrophyllum canadense L., New York.

Hydrophyllum capitatum Dougl., Colorado, Idaho, Montana, Utah, Washington, Wyoming.

Hydrophyllum Fendleri (A. Gray) Heller, Colorado, Idaho, New Mexico, Wyoming.

Hydrophyllum occidentale A. Gray, California.

Hydrophyllum tenuipes Heller, Washington.

Hydrophyllum Virginicum L., Iowa, Minnesota, Nebraska, New York, Washington.

Hydrophyllum Watsonii (A. Gray) Rydb., Utah.

Macrocalyx Nyctelca (L.) Kuntze (*Ellisia Nyctelca* L.), Iowa, Kansas, Nebraska.

TYPE LOCALITY: Catskill Mountains, New York, on *Hydrophyllum canadense*.

DISTRIBUTION: New York, across the continent to Idaho and Washington, south to New Mexico.

EXSICCATI: Ellis & Ev. Fungi Columb. 2102; Garrett, Fungi Utah. 35, 36; Sydow, Ured. 1544.

A conspicuous species of wide range. Its telial connection is problematical. A large number of trial sowings on it have been made in cultures, but without success.

66. *Accidium Phacelliae* Pk. Bull. Torr. Bot. Club 11:50. 1884.

On HYDROPHYLLACEAE:

Phacelia alpina Rydb., Utah.

Phacelia heterophylla Pursh, Colorado, New Mexico, Utah; British Columbia.

Phacelia leucophylla Torr., Colorado.

Phacelia ramosissima Dougl., California.

Phacelia ramosissima hispida Gray, California.

Phacelia tanacetifolia Benth., California.

TYPE LOCALITY: Utah, on *Phacelia* sp.

DISTRIBUTION: British Columbia south to California, Colorado and New Mexico.

EXSICCATI: Barth, Fungi Columb. 3001; Garrett, Fungi Utah. 31, 77; Ellis & Ev. N. Am. Fungi 2218.

A species of wide range in the Rocky Mountains and adjacent regions. Doubtless belongs with a telial form on some mountain grass.

67. *Accidium Guatemalensis* Kern & Kellerm. Jour. Myc. 13:23. 1907.

On HELIOTROPIACEAE:

Heliotropium indicum L., Guatemala.

TYPE LOCALITY: Gualan, Department Zacapa, Guatemala, on *Heliotropium indicum*.

DISTRIBUTION: Known only from type locality.

68. *Accidium* sp.

On BORAGINACEAE:

Bourreria havanensis Miers, New Providence Island.

No doubt a new species.

69. *Accidium Myosotidis* Burr. Bot. Gaz. 9:190. 1884.

On BORAGINACEAE:

Myosotis Virginica (L.) B. S. P. (*M. verna* Nutt.), Illinois, Missouri.

TYPE LOCALITY: Cobden, Illinois, on *Myosotis verna*.

DISTRIBUTION: Illinois and Missouri.

EXSICCATI: Ellis & Ev. N. Am. Fungi 1832.

70. *Accidium Onosmodii* Arth. Bull. Torr. Bot. Club 31:6. (Jan.) 1904.

Accidium Williamsi Ricker, Jour. Myc. 10:165. (July) 1904.

On BORAGINACEAE:

Onosmodium Carolinianum (Lam.) A.DC., Kansas.

Onosmodium molle Michx., Kansas, Nebraska, North Dakota.

Onosmodium occidentale Mack., Colorado.

Lithospermum linearifolium Goldie (*L. angustifolium* Michx.), North Dakota, South Dakota.

TYPE LOCALITY: Callaway, Nebraska, on *Onosmodium molle*.

DISTRIBUTION: From Kansas and eastern Colorado northward.

These two names are placed here as synonyms. The aecia can not be distinguished, the hosts are closely related, and their ranges coincide. It is therefore thought that they are one and the same species.

Morphologically the species is very similar to *Accidium Lithospermi* Thüm. and may possibly prove to be the same.

A rather likely connection for this *Accidium* is the subepidermal leaf-inhabiting *Puccinia* of *Hordeum* or possibly *Puccinia triticina* Eriks. on *Triticum*.

71. *Accidium Mertensiae* Arth. Bull. Torr. Bot. Club **31**:6. 1904.

On BORAGINACEAE:

Mertensia paniculata (Ait.) Don., Idaho.

Mertensia Sibirica (L.) Don., Oregon.

TYPE LOCALITY: Near Lolo Creek, Idaho, on *Mertensia paniculata*.

DISTRIBUTION: Idaho and Oregon.

In many ways this species is very similar to the preceding.

72. *Accidium Physalidis* Burr. Bot. Gaz. **9**:190. 1884.

Accidium Solani Am. Authors. Not. Mont.

On SOLOACEAE:

Physalis heterophylla Nees., Indiana, Nebraska.

Physalis lanccolata Michx., Colorado, Kansas, Nebraska.

Physalis longifolia Nutt., Nebraska.

Physalis Virginiana Mill., Colorado, Missouri.

Physalis viscosa L., Illinois, Texas.

TYPE LOCALITY: Urbana, Illinois, on *Physalis viscosa*.

DISTRIBUTION: Mississippi valley from Nebraska to Texas.

EXSICCATI: Ellis & Ev. N. Am. Fungi *3147*, *2992*; Ellis & Ev. Fungi Columb. *1578*.

While it is considered by some that this *Accidium* belongs with *Puccinia Physalidis* Peck, there is no definite proof to that effect either by cultures or otherwise. However, the fact that the two forms are largely co-regional and also that they resemble each other in general habit might be taken to reinforce the above supposition, but cultures are necessary to prove or disprove it definitely. No doubt the better way to make the culture is to sow fresh aeciospores on a sterile plant of their own host. The species is distinguishable from *Accidium Solani* Mont. by its small aeciospores and its revolute and more coarsely lacerate peridium.

73. *Accidium* sp.

On SOLOACEAE:

Chamaesaracha Coronopus (Dunal) A. Gray, New Mexico.

DISTRIBUTION: Known only from New Mexico.

Entirely distinct from the aecial stage of *Puccinia Chamaesarchae* Syd. which has a diffused mycelium while that of this is limited.

74. *Accidium tubulosum* Pat. & Gaill. Bull. Soc. Myc. p. **97**. 1888.

Accidium Uleanum Pazschke, Hedwigia **31**:91. 1892.

On SOLANACEAE:

Solanum Hartwegi Benth. (*S. torvum* Schlecht.), Cuba, Jamaica, Porto Rico, Mexico.

TYPE LOCALITY: Venezuela, on a spinose *Solanaceous* plant.

DISTRIBUTION: Mexico and West Indies.

75. *Accidium Chelonis* Ger. Bull. Torr. Bot. Club 5:40. 1874.

On SCROPHULARIACEAE:

Chelone glabra L., Connecticut, Massachusetts, New York.

TYPE LOCALITY: Poughkeepsie, New York, on *Chelone glabra*.

DISTRIBUTION: New York, Massachusetts and Connecticut.

EXSICCATI: Ellis, N. Am. Fungi 1433; Rab.-Wint. Fungi Eur. 3018; Shear, N. Y. Fungi 322.

76. *Accidium Palmeri* Ands. Jour. Myc. 6:122. 1891.

On SCROPHULARIACEAE:

Pentstemon virgatus A. Gray, Arizona.

TYPE LOCALITY: Willow Spring, Arizona, on *Pentstemon virgatus*.

DISTRIBUTION: Known only from type locality.

Distinguishable from *Accidium Pentstemonis* Schw., which belongs with *Puccinia Andropogonis* Schw., by the relative thickness of the outer and inner walls of the peridial cells, and from the aecia of the autoecious *Puccinia Palmeri* D. & H. by the persistent and more cylindrical peridia, and the smaller spores. It is possibly connected with some western grass-inhabiting *Puccinia*.

77. *Accidium Collinsiae* Ell. & Ev. *Bull. Washb. Lab. 1:4. 1884.

Accidium Tonellae D. & H. Erythea 3:77. 1895.

On SCROPHULARIACEAE:

Collinsia parviflora Dougl., Washington.

Collinsia Rottani A. Gray, Washington.

Tonella tenella (Benth.) Heller, Washington.

TYPE LOCALITY: Falcon Valley, Washington, on *Collinsia parviflora*.

DISTRIBUTION: Known only from Washington.

Distinct from aecia of *Puccinia Collinsiae* P. Henn. which arise from a limited mycelium, that is, are in groups.

* Not verified from original description.

78. *Accidium Gerardiae* Peck, Ann. Rep. N. Y. Mus. 25:92. 1873.

On SCROPHULARIACEAE:

Afzelia macrophylla (Nutt.) Kuntze, Nebraska.

Dasystema flava (L.) Wood (*Gerardia flava* L.), Alabama.

Dasystema virginica (L.) Britton (*Gerardia quercifolia* Pursh), Connecticut, Michigan, North Carolina, New Jersey.

TYPE LOCALITY: Near Cold Spring, New York, on *Gerardia quercifolia*.

DISTRIBUTION: Nebraska and Michigan, Connecticut south to Alabama.

EXSICCATI: Barth. Fungi Columb. 3302; Ellis & Ev. N. A. F. 2710; Roum. Fungi Sel. 4618; Thüm. Myc. Univ. 1225; Seym. & Earle, Econ. Fungi Suppl. B30.

This *Accidium* is very similar to the one on *Pentstemon*, which belongs with *Puccinia Andropogonis* Schw. and probably also belongs with this *Puccinia*. This supposition is strongly reinforced by a field observation made by Rev. J. M. Bates in 1910. After observing aecia in June on a plant of *Afzelia macrophylla*, he later found *Puccinia Andropogonis* developed close by. Since *Pentstemon*, *Dasystema*, and *Afzelia* all belong to the same family, it is very likely that the similar aecia on them have the same telial connection, viz: *Puccinia Andropogonis* Schw.

79. *Accidium micropunctum* E. & E. Jour. Myc. 6:119. 1891.

On SCROPHULARIACEAE:

Castilleja coccinea (L.) Spreng., Iowa.

Castilleja integrifolia Colorado.

Castilleja sessiliflora Pursh, Iowa, Nebraska, South Dakota.

TYPE LOCALITY: Pine Ridge, Nebraska, on *Castilleja [sessiliflora]*.

DISTRIBUTION: Iowa, Nebraska and South Dakota.

From field observations in Nebraska, Rev. J. M. Bates suggests that this *Accidium* belongs with *Puccinia Ellisiana* Thuem. on *Andropogon*.

80. *Accidium* sp.

On SCROPHULARIACEAE:

Melampyrum lineare Lam. (*M. americanum* Michx.), Connecticut, Delaware, Massachusetts.

DISTRIBUTION: Southern New England States.

This *Accidium*, while similar to, is probably different from *Accidium Melampyri* Kuntze & Schum. of Europe which belongs with *Puccinia*

Molinia Tul. on *Molinia cocculca*, especially since that rust is not yet recognized as American. The American *Accidium* probably belongs with some other grass-inhabiting *Puccinia*. It is doubtless a distinct species.

S1. *Accidium Tracyanum* Syd. Hedwigia 40:(129). 1901.

On ACANTHACEAE:

Colophanes oblongifolia (Michx.) Don. (*Ruellia oblongifolia* Michx.), Florida.

TYPE LOCALITY: Braidentown, Florida, on *Ruellia [oblongifolia]*.

DISTRIBUTION: Known only from type locality.

Distinct from aecia of *Puccinia lateripes* B. & R.

S2. *Accidium Oldenlandianum* Ellis & Tracy, Jour. Myc. 7:43. 1891.

On RUBIACEAE:

Houstonia minor (Michx.) Britton, Alabama.

Houstonia purpurea L., Mississippi.

TYPE LOCALITY: Starkville, Mississippi, on "*Houstonia coerulea*," error for *H. purpurea* L.

DISTRIBUTION: Gulf States.

Distinct from *Accidium Houstoniatum* Schw. which belongs with *Uromyces* on *Sisyrinchium*, by aecia being produced from a limited mycelium.

S3. *Accidium Bouvardiae* D. & H. Bot. Gaz. 24:36. 1897.

On RUBIACEAE:

Bouvardia hirtella H. B. K., Guanajuato, Queritaro.

Bouvardia triphylla Salib., Mexico.

Bouvardia sp., Guanajuato.

TYPE LOCALITY: Rio Hondo, near City of Mexico, on *Bouvardia triphylla*.

DISTRIBUTION: States of Guanajuato, Queritaro, and Mexico.

Distinct from the aecia belonging to *Uromyces Bouvardiae* Sydow.

S4. *Accidium pulverulentum* Arth. Bull. Torr. Bot. Club 33:521. 1906.

On RUBIACEAE:

Randia sp., Morelos, Jalisco.

TYPE LOCALITY: Cuernavaca, State of Morelos, Mexico, on *Randia* sp.

DISTRIBUTION: Morelos and Jalisco.

85. *Accidium Triostei* Arth. Bull. Torr. Bot. Club **33**:32. 1906.

On CAPRIFOLIACEAE:

Triosteum angustifolium L., Missouri.

TYPE LOCALITY: Perryville, Missouri, on *Triosteum angustifolium*.

DISTRIBUTION: Known only from Missouri.

86. *Accidium Valerianellae* Biv. Bernh. Stirp. Rar. Sicil. 1816.

On VALERIANACEAE:

Valerianella congesta Lindl., California, Washington.

TYPE LOCALITY: Sicily, on *Valerianella campanulata*.

DISTRIBUTION: Washington and California.

87. *Accidium Lygodesmiac* (Webber) Shear; Ellis & Ev. Fungi Columb. *1476*. 1901.

Accidium compositarum Lygodesmiac Webber, Bull. Neb. Agr. Exp. Sta. **1**:n.9:61. 1889. Nomen nudem.

Accidium compositarum Lygodesmiac Webber, Rep. Neb. Bd. Agr. 1889: **210**. (70). 1890.

On CICHORIACEAE:

Lygodesmia juncea (Pursh) D. Don., Montana, Nebraska, South Dakota.

TYPE LOCALITY: Belmont, Nebraska, on *Lygodesmia juncea*.

DISTRIBUTION: Nebraska, South Dakota and Montana.

EXSICCATI: Ellis & Ev. Fungi Columb. *1476*.

This is definitely a heteroecious form, as cultures by Dr. J. C. Arthur spring of 1911 show the telia on this same host to be autoecious. Possibly connected with some sedge-inhabiting *Puccinia* within its range.

88. *Accidium crepidicolum* E. & G. Jour. Myc. **6**:31. 1890.

On CICHORIACEAE:

Crepis acuminata Nutt., Montana.

Crepis glauca (Nutt.) T. & G., Utah.

Crepis runcinata (James) T. & G., Montana, Nebraska.

TYPE LOCALITY: Helena, Montana, on *Crepis acuminata*.

DISTRIBUTION: Nebraska, Montana and Utah.

Doubtless heteroecious and probably goes with some *Puccinia* on *Carex*.

89. *Accidium Hieraciatum* Schw. Trans. Am. Phil. Soc. II. **4**:293. 1832.

On CICHORIACEAE:

Hieracium Canadense Michx., Illinois, Minnesota.

Hieracium albiflorum Hook., British Columbia.

Hieracium cynoglossoides Arvet., Montana.

Hieracium paniculatum L., Pennsylvania.

TYPE LOCALITY: Bethlehem, Pennsylvania, on *Hieracium paniculatum*.

DISTRIBUTION: Pennsylvania west to Montana and British Columbia.

This *Aecidium* is very similar to the one on *Lactuca* which belongs to what has been referred to the so-called *Puccinia Opizii* Bubak on *Carex*. Further, in 1907, Prof. E. W. D. Holway collected the *Aecidium* at Glacier, B. C., and made the observation that it was possibly connected with a *Puccinia* on *Carex Deweyana* Schw. and *C. vitilis* Fries which *Puccinia* is practically identical with the so-called *Puccinia Opizii* Bubak. This together with the fact that this *Hieracium Aecidium* and *Puccinia Opizii* have practically the same general geographical distribution, makes it very likely that this *Aecidium* belongs with the above named *Carex* rust, but cultures are necessary to prove this definitely.

90. *Aecidium columbiense* Ellis & Ev. *Erythea* 1:206. 1893.

On CICHORIACEAE:

Hieracium albiflorum Hook., Washington; British Columbia.

Hieracium Scouleri Hook., British Columbia.

TYPE LOCALITY: British Columbia, on *Hieracium [Scouleri]*.

DISTRIBUTION: Washington and British Columbia.

Distinct from *Aecidium Hieraciatum* Schw. in having a diffused mycelium.

Prof. Holway believes this to be connected with *Puccinia* on *Luzula*.

91. *Aecidium* sp.

On AMBROSIACEAE:

Iva oraria Bartlett (*I. frutescens* A. Gray, not L.), Delaware, Florida, Louisiana, Virginia.

DISTRIBUTION: Salt marshes along the ocean and gulf coasts from Delaware to Louisiana. Evidently a heteroecious form.

92. *Aecidium Liatridis* (Webber) Ellis & Anders. *Bot. Gaz.* 16:47. 1891.

Aecidium compositarum Liatri Webber, *Bull. Neb. Agr. Exp. Sta.* 1:n. 9:60. 1889. Nomen nudem.

Aecidium compositarum Liatridis Webber, *Rep. Neb. Bd. Agr.* 1889:210 (70). 1890.

On CARDUACEAE:

Laciniaria punctata (Hook.) Kuntze (*Liatris punctata* Hook.), Montana, Nebraska, North Dakota.

Laciniaria spicata (L.) Kuntze (*Liatris spicata* (L.) Willd.), Nebraska.

Laciniaria scariosa (L.) Hill (*Liatris scariosa* Willd.), Kansas, Nebraska.

TYPE LOCALITY: Ansemo, Nebraska, on *Liatris scariosa*.

DISTRIBUTION: Kansas to North Dakota and Montana.

ENSICCATI: Barth. Fungi Columb. 2603, 2902; Brenckle, Fungi Dak. 101; Carleton, Ured. Am. 38; Sydow, Ured. 2377.

Numerous trial sowings of teliospores on these hosts in cultures have been unsuccessful. The telial connection may possibly be some unrecognized *Puccinia* on some sedge.

93. *Accidium Boltoniae* Arth. Bull. Torr. Bot. Club 28:664. 1901.

On CARDUACEAE:

Boltonia asteroides (L.) L'Her., Iowa, North Dakota, South Dakota.

TYPE LOCALITY: Spirit Lake, Iowa, on *Boltonia asteroides*.

DISTRIBUTION: Iowa to North Dakota.

With this as with the preceding species, numerous unsuccessful sowings have been made on the host in cultures. The telial connection is likely to be some sedge-inhabiting form.

94. *Accidium Clibadii* Syd. Ann. Myc. 1:333. 1903.

On CARDUACEAE:

Clibadium arboreum F. D. Smith, Mexico.

Clibadium Donnell-Smithii Coult., Guatemala.

TYPE LOCALITY: Guatemala, on *Clibadium Donnell-Smithii*.

DISTRIBUTION: Known only from two localities.

95. *Accidium Montanoae* D. & H. Bot. Gaz. 24:36. 1897.

On CARDUACEAE:

Montanoa sp., Mexico.

TYPE LOCALITY: Near City of Mexico, Mexico, on *Montanoa* sp.

DISTRIBUTION: Known only from type locality.

96. *Accidium Wedeliae* Earle, Muhl. 1:16. 1901.

On CARDUACEAE:

Wedelia carnosus Pers., Porto Rico.

TYPE LOCALITY: Mayaguez, Porto Rico, on *Wedelia carnosus*.

DISTRIBUTION: Known only from type locality.

97. *Accidium Bahiae* B. & C. Grev. 3:60. 1874.

On CARDUACEAE:

Bahia sp.

Eriophyllum stachadifolium Greene, California.

TYPE LOCALITY: (North America) on *Bahia* sp.

98. *Accidium Senecionis* Authors.

Accidium compositarum Senecionis Authors.

On CARDUACEAE:

Senecio aureus L., Iowa, New Hampshire, New York, Wisconsin.

DISTRIBUTION: New Hampshire west to Wisconsin and Iowa.

99. *Accidium* sp.

On CARDUACEAE:

Senecio praecox DC., Mexico.

DISTRIBUTION: Known only from State of Mexico.

A very characteristic form, no doubt a distinct species, doubtless belonging to some grass- or sedge-inhabiting telial form.

100. *Accidium Herrerianum* Arth. Bull. Torr. Bot. Club 33:520. 1906.

On CARDUACEAE:

Senecio salignus DC., Hidalgo.

TYPE LOCALITY: State of Hidalgo, Mexico, on *Senecio salignus*.

DISTRIBUTION: Known only from type locality.

A strikingly characteristic form, on account of its conspicuous peridium and large, thick-walled, dark colored spores. Doubtless heteroecious and possibly belongs with some telial form other than a grass- or sedge-inhabiting one.

101. *Accidium Compositarum* Authors.

(The following closely related forms, which have not been properly assigned to their telial connections and regarding which little is known.

are placed together under this one general "catch all" name, which has no particular significance. Field observations and cultures, along with further microscopical work, are necessary to segregate these forms. No doubt some of them will be found to belong with aecial forms already connected, while others of these forms will doubtless be found to have new heteroeccious connections.)

On CARDUACEAE:

Colcosanthus grandiflorus (Hook.) Kuntze (*Brickellia grandiflora* Hook.), New Mexico.

Chrysogonum virginianum dentatum A. Gray, District of Columbia.

Chrysothamnus Parryi (A. Gray) Greene (*Aplopappus Parryi* A. Gray) New Mexico.

Dugaldia Hoopsii (A. Gray) Rydb. (*Helenium Hoopsii* A. Gray), Colorado.

Helenium autumnale L., Colorado.

Polymnia canadensis L., Iowa, Wisconsin.

Rudbeckia hirta L., Nebraska.

Rudbeckia laciniata L., Iowa, Nebraska, Wisconsin, Wyoming.

Rudbeckia triloba L., Delaware.

ACKNOWLEDGMENTS.

The writer wishes here to express his sincerest thanks to all who have assisted in any way in the pursuance of this study. The kindly attention and critical suggestions of Dr. J. C. Arthur, under whose direction the work has been done, has been greatly appreciated throughout. Acknowledgments are especially due Dr. Arthur for the free use of his exceptionally large private collection of plant rusts, as well as for free access to his extensive private library on this subject, without either of which this study would not have been possible at this time. Free use was also made of his private card indices and manuscript sheets on the subject, which very greatly facilitated the use of both the library and the herbarium, and where much information was already brought together in available form.

Sincere thanks are also extended to the other members of the botanical department of the Indiana Experiment Station, viz: to Dr. Frank D. Kern, Mr. C. R. Orton, Miss Evelyn Allison and Miss Mary A. Fitch, for kindly assistance in various ways.

INDEX OF SPECIES OF AECIDIUM.

Abroniae	*13	Hieraciatum	89
Aconiti-Napelli	19	Hydrophylli	65
Aesculi	45	hydroideum	55
Allenii	56	interveniens	50
Anemones	21	Iridis	7
Anograe	58	Kellermanni	31
Apocyni	62	leporinum	61
Argithamniae	42	Liatridis	92
Bahiae	97	libertum	10
Boehmeriae	9	Lupini	35
Boltoniae	93	Lygodesmiae	87
Bouvardiae	83	Lysimachiae	60
Brandegei	64	Mertensiae	71
Brysonimatis	38	mexicanum	46
Cannonii	53	micropunctum	79
Cerastii	15	Mirabilis	14
Chelonis	75	Montonoae	95
Cimicifugatum	17	Myosotidis	69
circinans	20	Myricatum	8
Cissi	47	Nesaeae	57
Clibadii	94	obesum	63
columbiense	90	occidentale	22
Collinsiae	77	Oldenlandianum	82
Compositarum	101	Onobrychidis	32
crepidicola	88	Onosmodii	70
Crotonopsidis	41	Palmeri	76
Daleae	33	Parnassiae	29
Delphinii	18	passifloricola	54
Dicentrae	27	Petalostemonis	34
Eurotiae	12	Phaceliae	66
Falcatae	36	Physalidis	72
Fendleri	26	polygalinum	40
Gerardiae	78	Prospinaeae	59
Gossypii	52	pulverulentum	84
guatemalensis	67	Ranunculacearum	23, 24
Herrerianum	100	Senecionis	98

* List number.

Sphaeralceae	51	tubulosum	74
Stillingiae	44	Uvulariae	2
Thalictri	25	Valerianellae	86
Tracyanum	81	violascens	37
Triglochinis	1	Wedeliae	96
Trillii	5	Xanthoxyli	39
Triostei	85	Zephranthis	6
tuberculatum	48		
Species unnamed.....	3, 4, 11, 16, 28, 30, 43, 49, 68, 73, 80, 91, 99		

GENERIC INDEX OF HOSTS.

Abronia	*13	Castilleja	79
Aconitum	19, 20	Cerastium	15
Actaea	17	Chamaesaracha	73
Aesculus	45	Chelone	75
Afzelia	78	Chrysogonum	101
Althaea	49	Chrysothamnus	101
<i>Amphicarpa</i>	36	Cimicifuga	17
Anemone	21	Cissus	46, 47
Anogra	58	<i>Clematis</i>	22
Anthericum	4	Clibadium	94
<i>Aplopappus</i>	101	Coleosantes	101
Apocynum	62, 63	Collinsia	77
Argemone	42	Colophanes	81
Aselepias	64	Crepis	88
Bahia	97	Croton	41
Baptisia	31	Crotonopsis	41
Berberis	26	Cyrtorhyncha	24
Boehmeria	9	<i>Dalca</i>	33
Boltonia	93	Dasystema	78
Bourreria	68	Decodon	57
Bouvardia	83	Delphinium	18
<i>Brickellia</i>	101	Dicentra	27
Byrsonima	38	Direa	55
Collirrhoe	48, 50	Dugaldia	101
Caltha	16	Elaeagnus	56
Cassia	30	<i>Ellisia</i>	65

* *Accidium* number in list.

Eriophyllum	97	Onosmodium	70
Eurotia	12	Parnassia	29
Falcata	36	Parosela	33
Fouquieria	53	Passiflora	54
Geranium	37	Pentstemon	76
<i>Gerardia</i>	78	Petalostemon	34
Gossypium	52	Phacelia	66
Helenium	101	Philibertella	64
Heliotropium	67	Physalis	72
Hieracium	89, 90	Polygala	40
Houstonia	82	Polymnia	101
Hydrophyllum	65	Proserpinacea	59
Iris	7	Psoralea	32
Isopyrum	25	Randia	84
Iva	91	Ranunculus	23, 24
Jatropha	43	Rudbeckia	101
Laciniaria	92	Ruellia	81
Lepargyrea	56	Sebastiana	44
Leucocrinum	3	Senecio	98, 99, 100
<i>Liatria</i>	92	<i>Shepherdia</i>	56
Lithospermum	70	Sidalcea	48, 49, 50, 51
Loranthus	11	Solanum	74
Lupinus	35	Sphaeralcea	51
Lygodesmia	87	Stillingia	44
Lysimachia	60	Syndesmon	25
Macrocalyx	65	Thalictrum	25
Macrosiphonia	61	Tonella	77
Malvastrum	50	Triglochin	1
Melampyrum	80	Trillium	5
Mertensia	71	Triosteum	85
Mirabilis	14	Urtica	10
Mitella	28	Uvularia	2
Montanoa	95	Valerianella	86
Mozinna	43	Viorna	22
Myosotis	69	Wedelia	96
Myrica	8	Zanthoxylum	79
Nesaea	57	Zephranthes	0

*Furdue University,
Lafayette, Indiana.*

CONIOSIS.

(Abstract)

BY ROBERT HESSLER.

This paper relates to an experiment on the part of Nature, one that is going on all about us on a large scale, namely adapting man to live in cities overhung with smog clouds, in other words, changing man from an open air animal to an indoor air animal.

Like all of Nature's adaptative processes, this one is attended with great loss of life. The outcome is still a matter of doubt. It seems that besides destroying individuals there is also a tendency to destroy the species. To what extent man can counteract this weeding-out process is an interesting as well as vital question. Besides great loss of life there is much misery and ill health, all of which may be regarded as a reaction to an abnormal environment.

In the evolution of living matter we find organisms adapted to all sorts of surroundings: lichens in the cold arctics and algæ in the almost boiling hot water of geysers; animals in water and on land, in deep caves and high in the air.

The naturalist and the evolutionist see a life and death struggle everywhere, plants fighting for possession of the soil, animals destroying life and seeking to avoid destruction. Nothing is at peace, war everywhere, a struggle for existence with a survival of the fittest. Nature is constantly at war with man, and civilized man himself is at war with Nature trying to counteract her.

Man as a species of animal is still undergoing the process of adaptation, the law of the survival of the fittest is still in active operation. Man has not even outgrown destroying his own kind; the annual expenditure for war or being prepared for war is a burden that threatens to ruin many a nation.

Man as a species has adapted himself to a variety of surroundings from pole to pole. In some regions there is perpetual winter, in other places there is perpetual summer. In the temperate zone there is an alternation of half a year winter and half a year summer. Man indigenous to the temperate zone is adapted to these changes in temperature. Indi-

viduals from extremes, from the frigid and torrid zones, are not adapted to changes. If the Eskimo and the South Sea Islander exchanged places they would quickly perish.

In his evolution man has passed through different stages of civilization, or as some one has said domestication. At first he was a hunter and fisher, living an outdoor life like the animals about him. This was followed by the pastoral stage. Then came the agricultural in which for the first time he had a fixed home, and that meant to keep alive his old and decrepit and sick; many house diseases now found favorable opportunity for propagating themselves. In the handicraft stage where men were confined indoors the conditions for the propagation of house diseases became still more favorable. During the present industrial stage man has actively counteracted the ravages of many specific diseases, has practically banished some, but many still flourish unchecked. Common ill health that can not be dignified by the name of disease is perhaps more prevalent today than ever. Many people are not adapted to domestication, to a life under indoor conditions, in short, to an artificial climate.

In many regions of the globe man still leads the simple outdoor life (in the interior of Africa, Australia, South America), in others men are massed in cities. City life means a many-sided contact with all sorts of causes of ill health and disease and the weeding-out process. The process of adaptation is attended with great loss of life, as just mentioned. Here again we see a survival of the fittest, those best able to live under unsanitary environment. But fittest does not mean best—the inhabitants of overcrowded filthy Chinese and East Indian cities do not head the list of best men, most highly civilized.

Dismissing far away people and confining ourselves to man at home, we again see how the process of adaptation has been at work in producing the fittest, but not necessarily the best.

We trace our ancestry to Europe. Parentage goes back either to country or city ancestry. The ancestors of some of us have always led a quiet isolated rural life, others were more or less in contact with city life. A few have ancestors who for generations lived under crowded city conditions. City life means a many-sided exposure to all sorts of weeding-out factors.

The man among us who has perhaps undergone the weeding-out process attending city life most thoroughly is the Jew who traces his an-

cestry to the ghettos of old fortified European cities; his susceptible ancestors have been killed off to such an extent that he is largely immune to unsanitary conditions found in our cities. But he can not thrive under extreme conditions, such as are found in Asiatic cities, nor does he try to. Being ambitious he gets out of our own slums as quickly as possible.

On the other hand are the descendants of Southern Mountaineers, the latter a class of people who for several generations have lived in isolation, under so-called healthful surroundings, with an almost complete abatement of the weeding-out process found in cities. When they go to crowded, smoky and dusty cities they quickly fail. There may be complete failure, that is death, or failure of health with much ill health, the ill health attendant upon the process of adaptation. One can not properly speak of this as disease but as a reaction to an abnormal, an unsanitary environment.

Country-bred man goes to the city with a "stock of health." This in time fails, quickly in some, slowly in others; it may suffice for an individual but not for descendants and then we hear of race suicide.

Children born of city parents may perish at once or they may live for weeks, months or years and then die, perhaps after having had much ill health which finally terminates in disease. Certain diseases must be regarded as city and house diseases par excellence.

Just where health shades off into ill health, into minor maladies, and then into disease and death, is always an interesting study to the student of environmental influences, not to speak of the student of pathology.

Ill health touches many of us or our relatives or friends. Well-defined disease is comparatively rare, it may not appear until near the end of life. We should sharply discriminate between ill health and disease.

Some diseases have a rapid onset and may be fatal in a few hours, but as a rule the onset is slow and announced by preliminary warnings. Change of environment, making the conditions favorable for the body, may mean a continued existence.

Some diseases must be considered incident to city life and indoor life, notably tuberculosis and pneumonia—diseases with a frightful mortality. Then there is a host of minor maladies which must be looked upon as "diseases of civilization"—we need only think of catarrh, dyspepsia and nervous prostration.

We have not yet reached a stage where we judge the salubrity of a community by the amount of ill health. Our statistics relate to deaths—many individuals when fatally stricken leave the cities. The large industrial city overhung by smoke clouds has no use for the man over forty or forty-five. Men are soon worn out.

Besides people born in this country, natives as we say, there are those who come in directly from old European homes, immigrants of all kinds. How do they fare in our country? Here again we must consider the former life conditions and ancestral history and to what extent the weeding-out process has been operative. The conditions for existence in the new home may be better or worse.

There is an old saying, *The good die young*. I do not know where that saying originated but I feel sure it is one based on city life. Such a saying is diametrically opposed to the belief in the survival of the fittest. The man best adapted to live in slums is not the best type of man—if this were so the inhabitants of crowded Asiatic cities would head the list.

There is another saying, *Mens sana in corpore sano*, yet when we study biography we find that many of the world's greatest minds had much ill health, some constantly complained. What makes a healthy body? Must or should we contrast healthy or health with disease? or would it be better to contrast it with ill health? The physician constantly meets people who have ill health and yet no disease. In general it may be said that health results from country life, ill health from city life.

When we study the lives of city people who complain much of ill health we may find that their bodies are "healthy" enough but that there is a reaction to an abnormal environment, particularly abnormal air conditions; there are all sorts of symptoms of ill health. If we carefully study life histories of individuals who have had much ill health we may find that although they had ill health in the city they lived comfortably under simple country life conditions. We may come to the conclusion that symptoms of ill health must be regarded as warnings from nature to be heeded. Formerly it was assumed that "neuralgia is a cry for pure blood;" today we may safely assume that most symptoms of ill health in city people are cries for pure air.

What distinguishes city from country life? One could quickly make a long list of antitheses, beginning with crowding in the city and living

in isolation in the country. Many conditions are so extreme that the reader has no difficulty in determining where a mention applies: pure food, contaminated food; good water, polluted water; pure air, impure air; smog clouds overhead, blue sky overhead.

Crowding, food, water have all for a long time received attention and great efforts have been made to improve conditions. But not until recently have air conditions been given attention. Black smoke clouds receive frequent mention in the public press. The dust problem is likewise receiving more and more attention—if the people knew to what extent it is a factor in producing ill health and disease and death they would soon make a determined effort to alter existing conditions.

What are the effects on a pure air man when he goes into the large and dirty city overhung with smog clouds? Dust makes him feel dirty, his hands and clothing are soiled; he "blows black" into his handkerchief and spits black; there is more or less free production of mucus, followed perhaps by pus formation, and he will speak of having catarrh; in attempting to hawk up morning phlegm he may become nauseated and even vomit; dust particles reach his lungs and become imbedded, the lung becomes black (in old city residents it is coal black, pneumokoniosis); he experiences all sorts of disagreeable sensations, symptoms of ill health so-called, symptoms shade off into affections, minor maladies and disease; infective particles are locked up in the lymphatics, forming "kernels" in the neck and tumors along the windpipe and in the lungs and these bursting produce disease and death. The two great dust diseases are tuberculosis and pneumonia, they decimate mankind by thousands and millions.

Medical men have names for the effects produced by the inhalation of different forms of dust: Anthracosis for the effects produced especially in coal miners; Byssinosis due to inhaling cotton dust, as in cotton factories; Chalicosis, Silicosis and Siderosis are names applied to affections in potters, stone masons and iron workers who inhale gritty matter. The term Pollenosis is expressive and should come into general use; the name indicates a state or condition produced by inhaling pollen, that is in those susceptible.

Kinds of Dust¹.—There are all kinds of dust, all of varying importance in the welfare of man. To the physicist dust is of great importance in the matter of light and shade and precipitation; to the tidy house-

¹ For a synoptical table of Kinds of Dust an relationship to stages of civilization, see my Presidential Address, Indiana Academy of Science, for 1906, p. 23.

keeper dust is something to be fought constantly; the merchant looks upon it as something that spoils his goods; the physician looks upon it in the light of a producer of ill health and disease. In industrial cities factory dusts of many kinds occur and produce so-called industrial diseases.

A very pernicious kind of dust to which people living massed together are exposed is dust containing dried spittle and full of all sorts of infective matter, infective dust. This is the kind of dust of most importance to the student of Coniosis.

The modern dust problem can be considered from many viewpoints, physical, mechanical, economic, sociologic, esthetic, medical, pathologic, biologic.

Biology and pathology are closely related, often it is difficult to determine what is normal and what is abnormal, or what must be considered normal in the light of an abnormal environment. Dusty air produces reactions, states or conditions, in living organisms. Is the change adaptive and biological? Is it degenerative and pathological? We expect a tree to grow in the woods but not in the crowded city; we expect children to grow in the country—but many of us doubt their thriving in crowded cities. We ask what is abnormal, the child that does not thrive or the environment.

Disease, Ill Health, Symptoms, Reactions to Environment.—Disease is a term loosely applied to all sorts of conditions, to all sorts of reactions of the human body (not to speak of animals and plants), on the one hand to the morbid processes induced by the great epidemic diseases that kill by the thousands, and, on the other, to mere feelings of discomfort as those attendant on overeating, over-exercising, worry, etc., etc. Symptoms and disease and states of ill health are constantly confused, and indeed are often very confusing.

Shall the reaction due to inhaling dust be regarded as a disease or as a condition of ill health, or as a reaction to an abnormal or unsanitary environment? Shall we regard the effects produced on inhaling dusty air as a disease, or as a reaction that can be studied in the light of biology? (In answer I may say that several years ago I looked upon the reaction as a disease and published a paper based on data then at hand.)

In this paper I shall consider the subject in the light of a reaction to an abnormal environment, as a problem in biology. I shall consider symptoms as warnings from nature. If the warnings are heeded man lives on and on; if he does not heed them he perishes. In proportion as man

guards or protects himself he survives. One need scarcely consider the few individuals, shall we say the survivals of the fittest, able to live under filth and filthy air conditions. Fittest does not necessarily mean the best—the slums of cities do not represent civilization, neither do backward cities represent the civilization of today. We have not yet reached a stage where we look far ahead into the future. We still act upon the principle of letting the future take care of itself. After us the flood.

CONIOSIS (Konis, dust; osis, a state or condition) may be defined as a peculiar state or condition due to inhalation of dust (dust with more or less infection derived from dried spittle); it is a reaction of the body. The reaction varies from a mere feeling of discomfort up to decided painful sensations, perhaps with a feeling of ill health or threatened sickness. Metabolism is more or less disturbed, depending on the amount of reaction; there is deviation in temperature; the sensory organs and the sensorium are more or less affected, likewise the circulatory and excretory systems, with variations in the secretion of gastric juices. Pain may be localized in old injuries or weak parts of the body. The severity of the reaction depends on the amount of exposure. The reaction may last a few hours or indefinitely under continued exposure.¹

In attempting to define the term Coniosis one feels himself in the position of the physician in court when asked to define insanity: he may very well know what it means and to whom to apply the term when making an insanity inquest—but to make a definition that will be satisfactory to a quibbling lawyer is a difficult matter. The definition of Coniosis (which the general practitioner of medicine may regard as ill health) may not be satisfactory to the student of specific diseases, there will be quibbling.

If a man wants to know why it is difficult to make a good definition of insanity he should spend a few months among the insane. If he wants to know why it is difficult to define Coniosis or dust infection he should carefully observe a number of dust victims. (A man may even study himself, how he reacts under good and bad air conditions.)

¹ In a paper on Atypical Cases and Dust Infection (*American Medicine*, 1 Oct., 1904) I used the following definition:

"It is characterized clinically by an irritation of mucous membranes; vague wandering pains throughout the body, mostly referable to the muscles or ligaments; lassitude, headache, feverishness and anorexia, up to vomiting, marked nervous disturbance, and severe localized pain. The manifestations may vary considerably in different individuals, and the symptoms may be wholly subjective. It is often followed by other, specific, diseases."

At that time I had assumed that the term Coniosis was preoccupied.

Here is an illustration which I at times use in discussions with dust victims.

A man becomes the possessor of an automobile, he learns how to run it but knows little or nothing about its internal arrangements. On the road the machine begins to run badly, he knows there is something wrong but can not locate the trouble; he may or may not make an attempt to learn what is wrong; he may conclude to run the machine as long as possible and then turn it over to a master-mechanic to have the difficulty corrected. He may be sufficiently interested to learn about the "internal anatomy and physiology" of his machine and just what to do the next time there is trouble, indeed knowing the nature of the machine he may look it over at short intervals to avoid trouble on the road. Shall we say that dust in the carbureter is a frequent cause of trouble?

Any one who has ridden with an experienced and with an inexperienced automobilist will appreciate this illustration: He probably noticed the direct method of the one in looking for the source of difficulty on the merest indication of abnormal working of the machinery, and he can not avoid noting the utter helplessness of the inexperienced man when his machine balks; the latter usually does more harm than good in his bungling with wrench and hammer trying to make the machine go.

A dust victim may be regarded as a machine that becomes clogged with dust. Dust interferes in some way with the proper working of the machinery, in time the machine may refuse to run. Like the automobilist, he may in time learn much about the significance of symptoms, of warnings that something is wrong, and he avoids breakdowns, attacks of ill health and disease.

DUST VICTIMS.—Individuals who react more or less markedly to dust may be regarded as dust victims. In studying a large number of such one can make a composite description of the effects of inhaling dust, of Coniosis as defined above—but in proportion as a brief composite description includes many individuals it must be more or less vague.

An individual as a rule reacts very much the same each time under similar exposure. Individual reactions however may differ greatly, so much so that one can speak of types.¹

¹ In 1904 I described several types of dust victims, as far as I then understood the subject. Since then I have been gathering more data, more case reports, but I am not yet in a position to bring together all my data for a complete statement. This paper, like all others, must be regarded as provisional, subject to changes and corrections.

It needs scarcely be added that nature makes transitions and naturalists make divisions, and that divisions overlap. A reaction of the body may become so marked that we speak of the presence of disease. Moreover some organ or part of the body may be weakened and here the first evidences of abnormal functioning, or ill health or disease, may appear.

TYPES OF CONIOSIS OR DUST INFECTION.—Coniosis can be considered as an entity. It shades off on the one hand into health and on the other into disease. By studying a large number of "dust victims" one can distinguish certain more or less well-defined types or varieties, briefly characterized about as follows:

Respiratory Type: This type manifests itself mainly by symptoms or conditions that we commonly regard as colds and catarrh; in more advanced cases with more or less active inflammation by affections with all sorts of names, rhinitis, pharyngitis, laryngitis, tracheitis, bronchitis, pulmonitis. (Often there is much adventive tissue in the upper air passages—adenoids, hypertrophied tonsils, etc; removal of such tissues may greatly benefit.)

Peripheral Type: This is marked by the appearance of more or less ill defined pains and aches, at times by acute pains, especially at the site of an old injury. The pain is variously referred to as rheumatic or neuralgic. Pain may occur in any part of the body but may be localized in the arm or leg or toe or in the head or chest. (So-called living barometers are often dust victims who react acutely to dust influences.)

Alimentary Tract Type: Under such a head may be grouped individuals with more or less marked digestive tract disturbances, notably by conditions commonly regarded as dyspepsia and constipation. In some there is an excess, in others a deficiency of hydrochloric acid; mucus may be greatly in excess. (In studying the life histories of individuals one may find that what at first was an excess of free H Cl in time becomes a deficiency, there may even be a total absence. So-called laboratory examinations become highly important.) Where dust infection manifests itself as more or less constant constipation during the closed door season attention to diet, to exercise and the use of a proper laxative become imperative. (The best laxative and the best tonic or alterative is pure air—something many can not afford.)

Nervous Type: Here one can distinguish between nervous and mental symptoms. The importance of symptoms is largely dependent on the

life an individual leads. The brain worker may be disabled by symptoms that might not be at all noticed by a common manual laborer. A headache disables the one, a backache the other.

The nervous type is difficult to define briefly, but if we will keep in mind the average individual who is called "neurasthenic" or "hysterical" or as being "imaginary ill" we will have some idea of what is meant. It is sometimes said that "the complaints of the neurasthenic are innumerable," but they are enumerable, and they are preventable in perhaps nine-tenths of the cases that ordinarily come before the physician. (All some people need is good air—but what patients usually want is medicine that will enable them to continue life under the old environment.)

Psychic Type: Some individuals react mentally, especially to the air of crowds. Dull school children are often dust victims. Men are subject to moods and humors; they may be agreeable or disagreeable. Perhaps all have noticed that there are times when one can think clearly and persistently and there are times when thoughts will not come or when one can not reason clearly; this again may largely depend on air conditions. The reaction may even be so extreme that we speak of insanity.

Cardio-vascular Type: Here there is more or less marked change in heart action and blood pressure, especially an elevation or hypertension, this may manifest itself mentally, overlapping the above type.

Dust victims may be divided into two groups according to the blood pressure, whether low or high. The one tends to end in wasting diseases like tuberculosis and catarrhal pneumonia and the other by apoplexies, paralyzes and Bright's disease. It is necessary to mention these things so that the dust victim will take heed in time. (An interesting question to the physician is, What preceded an apoplexy? To what extent, for instance, was something done out of the usual, as riding on an overcrowded train or street car, shopping in ill ventilated stores, in short, having been exposed to infected dust?)

Cutaneous type is manifested especially in so-called neuroses of the skin, conditions or symptoms at times difficult to explain.

Genital Type: Here come particularly women who have pelvic disturbances, both acute and chronic, which interferes more or less with the process of reproduction. This type should be considered in the matter of race suicide. "Flat life" is very destructive to human life, all sorts of factors must be considered—one rarely considered is the dust factor.

Coniosis should be looked upon as a reaction to an abnormal environment, rather than as a disease.¹ It manifests itself by a variety of symptoms all more or less modifiable by the use of drugs, mainly by masking them. Although incurable it is readily preventable.

Coniosis is most prevalent during the closed door season when clean or pure air is at a minimum. It may occur in epidemic form in winter, at times of a thaw when sidewalk filth is tracked indoors and pulverized under foot, as by shoppers. It may also occur in epidemic form at times of high winds, when street filth is blown about, as on the approach of spring, when nearly everybody complains more or less—and many think they need a “spring tonic.”

Coniosis is prevalent among people in all walks of life. Among poor people to whom life means a constant struggle for existence there is an early and constant weeding out on account of the appearance of well-defined diseases that kill. Among the well-to-do many reach old age because they are careful but there is more or less constant complaint of ill health. Coniosis is not incompatible with long life, that is in those who are prudent. The attitude of the poor man, and of those who are heedless, is shown by the old observation of Plato:

“When a carpenter is ill . . . he expects to receive a draught from his doctor, that will expel the disease by vomiting or purging, or else to get rid of it by cauterizing, or a surgical operation; but if any one were to prescribe to him a long course of diet, and to order bandages for his head, with other treatment to correspond, he would soon tell such a medical adviser that he had no time to be ill, and that it was not worth his while to live in this way, devoting his mind to his malady, and neglecting his proper occupation: and then wishing the physician a good morning, he would enter upon his usual course of life, and either regain his health and live in the performance of his business; or, should his constitution prove unable to bear up, death puts an end to his troubles.”

What the carpenter needs, what the workman needs, is a knowledge of the influence of environment, and a knowledge of the limitations of the physician in curing ill health and diseases. Much ill health is incurable

¹ The term disease is really an objectionable one because many people at once think of a “cure.” The patent medicine man keeps alive the old belief that there is a cure for every disease. To simple people all things are simple. As a matter of fact the “diseases” of the patent medicine man are mostly symptoms. Many people still have an idea that a disease can be “knocked out” or “killed.”

but preventable. Proper ventilation prevents much ill health—but if the individual asks for it he is apt to be discharged. We here see the value of Unions in making a combined demand.

SYMPTOMS.—Symptoms are usually divided into subjective and objective, those that we experience ourselves and those that we observe in others. The latter are also called signs. Some signs are discoverable only by the use of instruments, or laboratory methods.

Ordinarily we do not speak of symptoms of health, but we do speak of symptoms of ill health, and of course of disease. Indeed, some diseases are said to be made up of symptom-complexes or syndromes and are diagnosed thereby.

Symptoms are evidences of abnormal functioning. Symptoms can be regarded as warnings that something is wrong. In this volume I am speaking of symptoms not as evidences of the presence of disease but as an evidence of a reaction due to inhaling dusty air.

The individual who does not react to his environment is exceptional. At the other extreme are the very susceptible, to these a study of mesology and ecology may be of advantage.

Symptoms in great variety occur in Coniosis. Many of the common ones accompany the general type, others are more or less limited to the special types. Pain, in its widest sense, is a very common symptom. Cough is common in the respiratory type; headache is common in the nervous type; albuminuria, arrhythmia, edema, palpitation in the cardiovascular, etc. I am here making only brief references. Symptoms enable us to classify or group.

SUSCEPTIBILITY.—This varies greatly and is determined by a large number of factors, such as the phylogenetic history; the ontogenetic history; the place of residence, whether city or country; the amount and intensity of the exposure; the air conditions before and after exposure; the state of nutrition, whether over- or underfed; the ability to take a day, a week or a month off when not feeling well; etc., etc. The very susceptible individual may really suffer less by living within limitations than the less susceptible who is heedless. It needs scarcely be added that an individual can largely guard himself against environmental influences but less against hereditary tendencies.

Some individuals who react acutely are constantly watching themselves, are "exceedingly careful," and yet if they do not know where the

danger lies are constantly suffering. A knowledge of Coniosis is of great value to them.

For a man who has long believed he had consumption or was constantly on the verge of it, or that he had cancer of the stomach, or Bright's disease, or heart disease, not to speak of other diseases and affections, to know that he is "only a dust victim," that his fears are perhaps wholly groundless, is certainly a great relief. But the prudent man will take care to avoid exposures, knowing that disease may follow an acute attack of dust infection, emphasized in the warnings of the patent medicine man, "Beware of a cold."

At the other extreme is the man in "robust health" who is constantly exposed but who, because he does not complain, is assumed not to react. Yet he may be reacting all the time, as by gradually developing a high blood pressure and then suddenly going to pieces prematurely.

Coniosis may be looked upon as a "Protean disease" with which the general practitioner of medicine is very largely concerned, not to speak of people who "doctor" themselves. Perhaps the great majority of the "diseases" for which the patent medicine men advertise their nostrums and cure-alls fall within the scope of Coniosis. If we understand that Coniosis is a reaction to an abnormal environment, we at once see the uselessness of attempting to cure by drugs. Drugs however may palliate—alcohol, opium, cocaine, acetanilid are largely interchangeable; all are habit producing drugs.

When marked symptoms, as of ill health, appear then Coniosis becomes a medical subject—and then the best advice to a dust victim is to seek the services of a competent physician, one who will properly investigate, if necessary by laboratory methods, and who will discuss findings freely. Usually good advice rather than medicine is needed in such cases, but we should not forget that drugs may palliate, may modify severe symptoms. (Here is a very practical point: Pay the physician for advice rather than for medicine—or in self-defense he will dispense medicine or write a prescription for a tonic in order to get his fee. The practice of medicine is after all a bread and butter profession. The physician who makes time-consuming examinations in competition with symptom-prescribers often has difficulty in maintaining himself.)

RESULTS OF EXPOSURE.—What constitutes an exposure? This is a matter in which personal experience largely enters; each must learn for him-

self how much or how little he can bear. Exposure to extremely bad air conditions, as going to a political meeting with spitters all about or riding in a dirty car, may bring on a prompt reaction, or the reaction may appear under continued exposure to relatively good air.

Since infected dust is a variable quantity there is more or less danger of complications and Coniosis proper may ultimately develop into what the physician regards as disease and perhaps well-defined specific disease.

CONIOSIS VS. DISEASE.—It seems a trait of human nature that the moment a name is given to a thing or a phenomenon the mind is satisfied and makes no further inquiry, except the scientific mind. The physician constantly sees this in dealing with his patients. What is the matter? he will be asked by his patient, who often enough has his own diagnosis and merely comes for a "little medicine." If told he has a cold, or bronchitis or rheumatism, or stomach trouble, or heart or kidney trouble, etc., he usually asks no further, still more rarely about causes. If he does ask about the cause or causes and is told his trouble is due to "cold" he thinks he understands and rarely indeed asks further. And yet the physician has great difficulty in defining a "cold," just as he has difficulty in defining nearly all the names current among the people or used in patent medicine advertisements.

As long as we look upon every reaction of the body as a disease, or that a certain combination of symptoms constitutes a disease, the average individual will make no effort to find the reason why he is not feeling well, nor will he make any radical attempts to get well. There are not lacking those who deny there is such a thing as disease, that it is all imaginary; they must be taught that just as there is a reaction when the hand is put into hot water or when irritating smoke is inhaled, so there will be a reaction on inhaling dust. Perhaps we had best not speak of disease at all, only of a reaction, and that this reaction moreover depends on what may be called individual susceptibility, varying from slight to marked. When the subject is once understood each one can determine for himself to what extent he is susceptible; a good physician will help him, especially to rule out other reactions, so-called diseases.

Some individuals or patients must be kept under observation for some time before a physician will venture on a diagnosis, some constantly "fight for time." Diseases that can be readily and accurately diagnosed and about which the opinions of different men will not vary greatly are

comparatively few. States of ill health where no accurate diagnosis can be made are many. Some physicians hesitate to make a diagnosis when they know the patient has already had a variety of diagnoses and likely will receive more after leaving him. Some "cases" are as easy to "treat" as they are difficult to diagnose. Physicians have an old saying, Any one can prescribe, the difficulty consists in making a proper diagnosis.

It should be kept in mind that Medicine like everything else is an evolution and that it has not yet reached a stage where it can properly classify the things with which it deals—with reactions and states of the body variously termed disease, maladies, affections, symptoms. Much is still to be learned about the common ills of the common people.

Primitive Medicine included all the sciences, as knowledge developed sciences crystalized out and each pursued an independent course; some have now little connection with Medicine proper. We need only think of chemistry, as an outgrowth of alchemy, and the search for the elixir of life and the transmutation of metals, or of the herbalist changing into a botanist and more recently into a bacteriologist concerned with microscopic plants. In short, sciences formerly studied by medical men have now developed to such an extent that the practitioner of medicine can not acquire more than a smattering knowledge of them; and that means in proportion as men specialize they must limit their field of work. A specialist in one department of Medicine may scarcely know what is going on in other departments.

There are topics that are of interest to all, such as the life conditions under which we live and the search for the favorable ones and avoidance of the unfavorable. Favorable conditions tend to what we call health, unfavorable ones to ill health, disease and death. Extinction may come suddenly or slowly; it may not appear for several generations—in what is called race suicide.

DIFFERENTIAL DIAGNOSIS.—Just where reactions, or symptoms shade off into disease is often difficult to determine, in fact is impossible because there is no exact definition of the very term disease.¹ In order to diagnose Coniosis properly one must rule out other more or less related conditions, especially diseases, so-called. For the purposes of this paper it may

¹ Diseases themselves are variously classifiable. A common division is into parasitic (due to invasion of parasites of all kinds) and constitutional (due to defects in the body, congenital or acquired). Another general classification is structural and functional.

suffice to divide the latter into three groups: 1. Diseases proper, due to specific or definite pathogenic causes; they are as a rule self-limited and run a more or less well-defined course. 2. Diseases due to alteration in structure and usually incurable when once fully established; some are favorably influenced by surgical procedures. 3. Diseases due to alteration in function or temporarily altered functioning, more or less preventable or modifiable.

1. *Specific Diseases*, those due to definite causes, as pathogenic microorganisms. The reaction of the body in its efforts to rid itself of the enemy is manifested by signs and symptoms, and the syndrome or symptom-complex is designated as disease, in other words, diseases are made up of symptoms. In the absence of symptoms one would scarcely speak of the presence of disease (although a disease may exist and not manifest itself for a long time). Nosologists are attempting to classify diseases by their causes, but so far only a good beginning has been made; much work remains to be done.

To make full statements regarding the diseases of our State would require the possession of data difficult if not impossible to obtain. The proper method of studying the specific diseases of a country would be to consider them in the order of their appearance and how they dominated other diseases and prevalent ill health. Here I can only briefly refer to a few diseases.

Malaria. This disease or its cause came early. Formerly our State was very "unhealthy" on account of the presence of malaria. It dominated everything. With the clearing up of wet places where mosquitoes breed and by the free use of quinine malaria has practically disappeared.

Malarial fever is to be ruled out in dust infection. Many physicians still suspect a "malarial element" in many cases of common ill health, at times referred to as a "touch of malaria." True malaria yields readily to quinine in sufficient dosage, dust infection not.

Physicians are accustomed to speak of another form of malaria. Locally we have the name False Malaria. It is not dependent on the plasmodium malarie nor is it transmitted by the bite of mosquitoes; it is transmitted through infected dust. It is, in short, dust infection or Coniosis.

Some writers believe that the civilization of ancient Greece and Rome passed away on account of the presence of malarial fever, in altering

man's environment to such an extent that he could no longer flourish. Malaria literally means bad air, but in the case of malarial fever we know that this is really not true. Regarding the air conditions of our cities we can properly speak of mal-aria. We can even speculate to what extent bad air is a factor in destroying our own civilization, shall we say by killing off the desirable and leaving the city to the undesirable?

Tuberculosis: This is the great indoor air disease which is actively weeding out those not adapted to city life or to life indoors under bad air. Individuals whose ancestors have long been exposed to the ravages of tuberculosis are largely immune, succumbing only when conditions are unusually bad or prolonged. It is well known that the descendants of European ghetto Jews are largely immune while Russian rural Jews are not. The descendants of southern mountaineers are very susceptible. Phthisophobiacs are often dust victims whose fears can be allayed.

Pneumonia is another great indoor disease, now ranking with tuberculosis. It is a disease of the wellfed rather than of the poor. Individuals subject to high blood pressure seem especially prone to pneumonia. An acute "cold" (dust infection) may terminate in pneumonia.

Influenza is a disease that appears periodically, after an interval of years, and attacks practically everybody. After a pandemic subsides there may be sporadic cases for a short time. Cases of "grip" after the subsidence of epidemic influenza are usually cases of dust infection. Influenza manifests itself by several quite well marked types, indeed, the similarity to dust infection is quite marked. The best treatment for Influenza, in reducing the number and severity of symptoms to a minimum and avoiding a fatal termination, is the pure air treatment.

This enumeration of specific diseases can not be continued but there should at least be a mention of Cancer.

Cancer: Although the active cause of cancer is still unknown it is regarded as a definite or specific disease, running a more or less well-defined course, usually fatal in a short time. Cancer in its various forms or kinds is to be ruled out, especially in dust victims of the alimentary tract type; to do that properly requires the use of laboratory facilities.

2. *Diseases Due to Alteration in Structure*, to enlargement or atrophy, to altered innervation or imperfect nutrition or circulation, to the presence of scar tissue, to adhesions, etc. This condition is often due to injury or to the presence of disease which produced alteration, with an

alteration in function. But the altered functioning of an organ may be perfectly natural for such an altered organ, it could not be otherwise. The presence of an acute disease may so modify "the normal action of an abnormal organ" that at first sight a case may seem very mystifying—hence the need of studying an individual not alone when complaining but when in apparent health. A good family physician in time learns much about his patient and knows just what to do in case of an acute disturbance.

Alterations in organs and tissues are very common in people much exposed to infective matter, especially in the air they inhale. There may be at first mere irritation, followed by active inflammation and then scar tissue. In proportion as there is scar tissue there is alteration of function, finally reaching a stage where well marked symptoms appear. Whether to speak of disease or reaction is often a matter of doubt; one may not be able to decide until the reaction has ceased or the pathological process has run its course. (One is reminded of "How to distinguish mushrooms from toadstools.")

If one were to enumerate systematically the diseases, maladies, or affections to be ruled out in dust victims, one would have to begin at the nose and mouth where the inhaled infection first shows its effects.

Infection reaching the sense organs may produce all sorts of disturbances, acute and chronic, as impairment or abolition of the sense of smell and taste, or impaired hearing and sight.

A host of affections or "diseases" of the respiratory system would have to be considered, such as rhinitis, laryngitis, tonsillitis, tracheitis, bronchitis, pulmonitis, etc.

Infection may travel down the esophagus with the production of conditions designated as pharyngitis, esophagitis, gastritis of many varieties, and intestinal disturbances in variety, one marked form being attended with the production of large quantities of mucus.

Here I can not consider the influence on other and distant organs, the kidneys for instance, or the nervous system.

3. *Diseases Due to Altered Functioning*, more or less transient, and more or less bound up with conditions described above. Here might be cited a number of conditions that can not properly be called diseases at all—such as the more or less transient effect of much or too little food; the use of too much or too little fluid; or foods that produce a reaction,

perhaps an intoxication; the excessive use of condiments; the influence of heat or cold, etc. To what extent to speak of diseases, of symptoms or of reactions is at times a difficult matter to determine, there are no hard and fast lines, no more than between species, subspecies and varieties. Opinions vary.

What is in dust that produces the condition described as Coniosis? This is really a question for the pathologist and bacteriologist, for men who study causes. For our present purposes all we need to know is that there is something to which the body reacts. In illustration might be mentioned malaria: all we need to know to protect ourselves from malaria is to keep from being bitten by the mosquito which transmits the disease, and indeed we need not fear its bite at all if there is no malaria about. We know what the active cause of malaria is but in the case of Yellow Fever transmitted by another species of mosquito we do not know, and yet keeping the mosquito under control and avoiding being bitten means to prevent the ravages of Yellow Fever.

In the case of Coniosis as defined above we need only consider kinds of dust, whether in part it came from man, particularly expectoration and whether sterilized by age or sunlight. The inhalation of country dust may be disagreeable but it is not the kind of dust that produces Coniosis. We at once see that infected dust is very common in backward cities, less in clean cities and wholly absent in the isolated country.

We see an analogy in pollenosis or hay-fever. This occurs where the pollen of certain plants abounds. The hay-fever victim no longer expects to be cured by the use of drugs; he knows that he will feel miserable as long as he is exposed to the particular pollen to which he reacts. To get relief, he "changes climate;" he goes where the air is free from this irritating dust—just as people who are educated regarding Coniosis will also make a change.

"Precolds" under exposure to "exciting causes" result in "colds." Colds are commonly although not necessarily always attacks of Dust Infection.

To what extent the body protects itself and to what extent man makes an effort to protect himself are very practical questions, but they can not be considered in this brief abstract. People are often "exceedingly careful" in their attempts to avoid ill health and sickness, but not

knowing where the real danger lies they are overcareful along some lines and not sufficiently so in others. Some must consider the dust factor in order to survive.

Dust victims and observant people generally often have a stock of unformulated knowledge (obtained through bitter experience) that is of more value to them than the advice and medicine of the young physician who in college is taught about diseases but little or nothing about the common ills of the common people. The physician like everybody else learns much in the school of practical experience, and he often learns from old chronics, if he gains their confidence. Related data may be formulated by comparing the experiences of many. Often all sorts of apparently isolated facts are explainable by a theory.

Individuals who are designated as "old chronics" often have "tried everything" and being still uncured have lost faith in drugs and in the science (or should I say art?) of Medicine. A physician may induce some to look upon their ill health in a new light. Some readily take up with the idea or theory of Coniosis—to them it may become a working theory, a guide that enables them to reduce symptoms to a minimum. Coniosis moreover is a subject that can be studied by any one, no medical education is necessary although desirable. It is moreover a study that should be taught in a practical manner in the schools, not as mere book learning.

Like all theories relating to complex biological problems the theory of Coniosis should not be applied too rigidly, for the case under consideration may be wholly exceptional. The practitioner of medicine must constantly bear in mind that he is dealing with fellow-creatures who have wants and needs; he must consider all sorts of causes and factors.

There are any number of problems regarding dust influences that still seek solution. The dust victim who will study himself and keep a record of himself and his varying surroundings can greatly assist his physician, and if he perchance has a physician who is not a student he may deem it advisable to make a change; he may even conclude to go to a community where people expect more from physicians than merely handing out medicine.

The question, What makes dust dangerous, what is the noxious matter? is a problem that is beyond the scope of the ordinary physician. It requires laboratory facilities and unbounded time. The need for a special institution for studying details is imperative.

WHAT THE THEORY OF CONIOSIS EXPLAINS.—In the light of present data the following statements seem justified:

Coniosis explains many cases of common ill health, cases that can not be definitely diagnosed as disease, cases about which differences of opinion among doctors are proverbial.

It explains the prevalence of our "Triad of National Diseases"—carrh, dyspepsia and nervous prostration.

It explains why much of the "prevalent ill health" is incurable, but preventable.

It explains why there is a seemingly endless succession of nostrums advertised in the newspapers and medical journals; all may have some merit in palliating symptoms—but as to curing that is another question.

It explains the prevalence of patent medicine advertisements and their seasonal variation.

It explains why our nation is a land of fads in medicine and quack remedies (mainly because we tolerate the chewer and spitter).

It largely explains the discrepancy of opinion between city and country doctors regarding typical and atypical cases.

It explains the ordinary ills of the school child and the seasonal prevalence of some specific diseases.

It explains the "degeneration" of school children and the supposed influence of "overwork." (Usually there is an overworking of the defences of the body.)

It largely explains why poor people who must work under crowded conditions perish prematurely and why old chronics able to take care of themselves live on indefinitely.

It explains why many foreigners fail in our cities, some physically, others mentally. (Immigrants not adapted to city life should be encouraged to settle in the country and not in cities and certainly not in slums.)

It explains the prevalence of tuberculosis in low pressure individuals and of heart and kidney diseases in high pressure individuals.

Coniosis gives a clew to the chronic ill health of men and women whose biographies are full of references to ill health.

It puts a new interpretation on the old saying, Acquire an incurable disease and live long.

It teaches us to make sharp distinctions (or attempt to do so) between symptoms or ill health and real diseases.

It shows the need for "case reports" extending over years and not merely over a few weeks or a few months.

It shows why many people need good advice rather than a "little medicine."

It shows the value of a seventh day of rest and of an occasional vacation and an annual vacation in the country.

It shows why hospitals should be located in the suburbs rather than in the heart of large cities.

It teaches why many of the common ills or symptoms are to be looked upon as blessings in disguise—as warnings to be heeded.

It puts a different interpretation on the old saying, A sound mind in a sound body.

It shows the need of full co-operation between patient and physician and that free discussion is necessary to arrive at the truth.

This list could be extended indefinitely. Perhaps needless to say it takes time to go over accumulated data and digest facts and draw conclusions.

General sanitation is the duty of the community and of the State but there will always be problems that are purely personal. Every one should have sufficient education to properly choose a private medical adviser. The family physician still has a place in our civilization. He must "super-*vis*e health" and advise his patients how to prevent ill health and disease. In the case of actual disease he may be able to direct his patient to the proper specialist, and he must constantly stand between his patient and the operator.

The theory of Coniosis allays the fears of specific diseases and on the other hand it creates a pure air conscience. A sensible man does not become an alarmist.

The mere ability to live under bad air conditions, to tolerate, is not synonymous with adjustment or adaptation. A "return to the simple life" can scarcely be considered a remedy; few care to return to such a life after having lived a complex city life. The proper remedy is to make the city sanitary.

Although sanitary science has markedly decreased the prevalence of many specific diseases, the decrease of common ill health is less noticeable. We must distinguish between individual and communal effort; some com-

munities are backward and some individuals are heedless. (Shall we go a step further and say our cities will not be properly cleaned until women are given a voice in the management of municipal affairs?)

Coniosis needs to be taught, it should be taught in the schools. It shows why schools should be located under sanitary surroundings and why cities should clean up and keep clean.

*THE REGENERATED SCALES OF *FUNDULUS HETEROCLITUS* LINNE'
WITH A PRELIMINARY NOTE ON THEIR FORMATION.

BY WILL SCOTT.

The work of Hoffbauer, '99, on the scales of the carp established the fact that, up to the third year, the age of this fish could be determined by the sculpture of the scales. Johnston '05-'08-'10 has shown that not only can the age of the salmon be determined by the sculpture of the scale, but the emigration of the young salmon (parr) from river to sea and each return to spawn of the sexually mature leave an indelible mark upon the scale. These marks have been rendered perfectly intelligible by the work of Johnston and that of his associates on the Scottish fisheries board.

Hutton, '10, in working on the scales of the Wye River salmon observed, occasionally, scales quite different from the normal ones and suggested that these scales might be the result of regeneration. If this suggestion be true then it would be possible, by scale examination, to determine the wounds received by and, in a general way, the hazards encountered by any individual. To add this additional index to the life history of a fish these experiments concerning the regenerated scale were performed.

The Killifish, *Fundulus heteroclitus* Linne, was selected for the experiment because of its abundance and its well known hardiness. Many fish of this species, at this season of the year (Aug.), were infected with a sporozoan parasite. This infection proved fatal in most cases, consequently great care had to be exercised in selecting material. The operation consisted in the removal of about six rows of scales from the left side between the posterior end of the dorsal fin and the anal fin. The fish were covered with clean cheese cloth which was kept wet with sea water; only a small area was exposed at any one time. The scales were lifted from their pockets with a scalpel, care being taken not to injure the inner wall of the pocket. If the circulatory system was injured in any noticeable degree sporozoan infection occurred.

¹The work was done while acting as scientific assistant in the laboratory of the U. S. Fish Com. at Woods Hole, Mass., and is published with the permission of the Hon. Geo. M. Bowers, Commissioner of Fisheries.

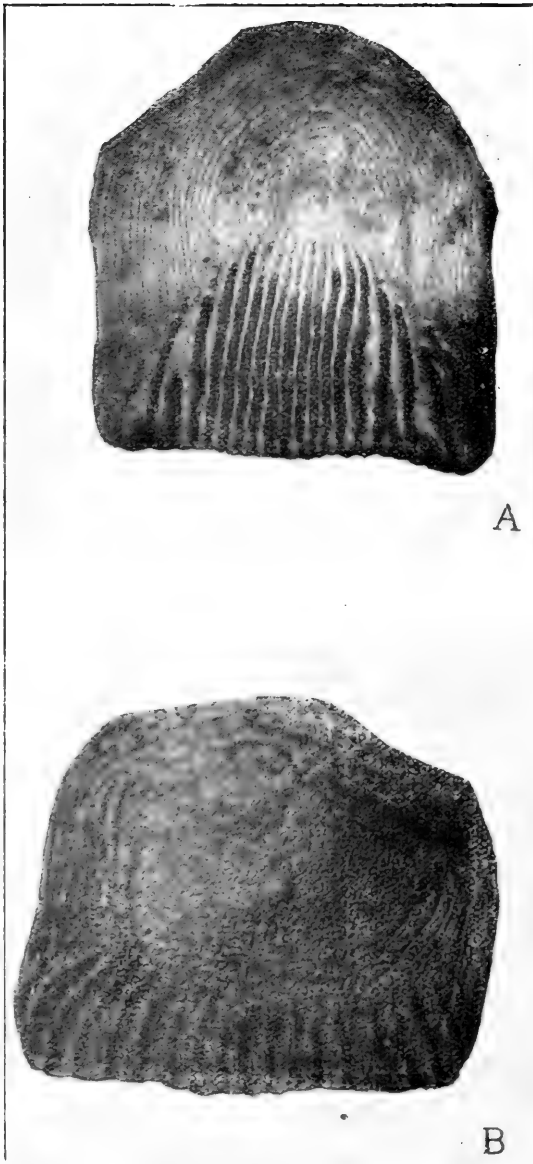

Plate I. Comparing (A) normal and (B) regenerated scale

Series A. On August 3, twenty-one fish varying from 91 m.m. to 114 m.m. were operated on and placed in tank A, in running sea water. The scales shown in plate II were all taken from this series. No fish from this series were lost during the experiment.

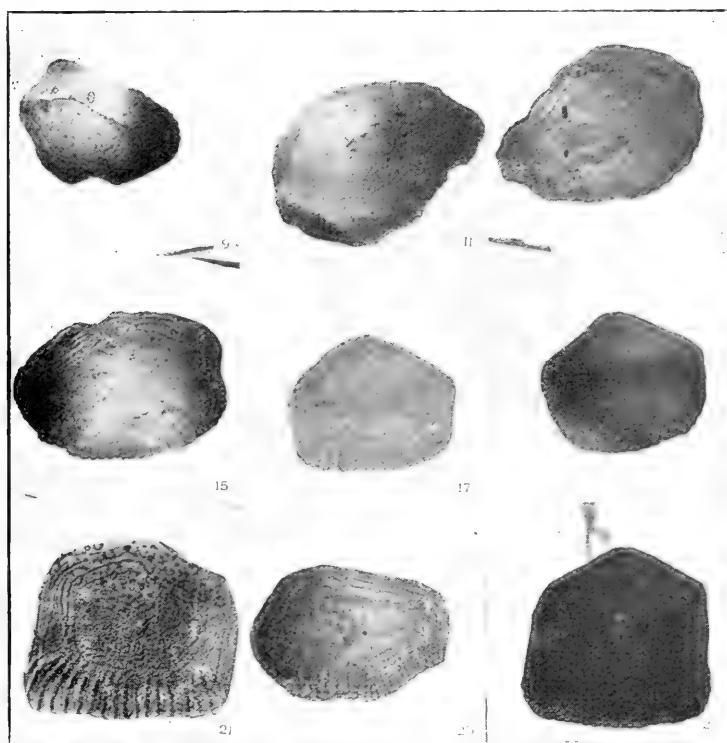

Plate II. Showing the process of differentiation in regenerating scales. All operations were performed on Aug. 3. Numbers in lower right hand corner indicate the day of the month on which the fish were killed.

Series B. August 3, twelve fish varying from 72 m.m. to 86 m.m. were operated on and placed in tank B. In this series two individuals were lost, one by sporozoan infection and one by being accidentally caught in the outlet of the tank.

Series C. On August 4, five fish were totally denuded of scales except a few accidentally left around the base of the fins. It was very



Plate III. Indicating that age and degree of injury do not influence differentiation in the regeneration of fish scales. (A) from the largest fish, 114 m.m. (B) from the smallest, 72 m.m. (C) from one of the fish in series C which were entirely denuded of scales.

difficult to remove so many scales without injuring the skin. Two fish suffered slight punctures in the operation and died of sporozoan infection two days later. The other three lived until the close of the experiment.

The scales regenerated to almost their normal size in twenty-five days. The rate will probably be found to vary in different species of fish. I was unable to dissect out the scales before the sixth day after the operation. On this date the scales were very thin and fragile; the cycloid sculpture was developed to the extent of three irregular yet fairly distinct lines which surrounded a relatively large unsculptured area.

The radiate sculpture which the normal scales of this fish have on their inner ends could not be detected on the sixth day. Faint traces of it appeared on the eighth and tenth days and by the twelfth it was very evident. From the twelfth day the sculpture developed as it does on the periphery of a normal scale except that the lines of the cycloid sculpture were slightly farther apart.

Scales from the largest of series A, 114 m.m., the smallest in series B, 72 m.m., and one of the fish that had all its scales removed are figured in plate III. These show no marked difference in the differentiation, indicating that age and degree of injury do not influence the process to any great extent, if at all.

It may be noted that no fatalities occurred which were referable to the osmotic pressure of the sea water. This fact is in direct opposition to the findings of Garrey, '05, but corroborates in part those of Sumner, '06, who repeated and extended the work of Garrey. The results may be harmonized by assuming that sporozoan infection occurred in Garrey's experiments of which he took no account. The histological study of this process has not yet been completed.

Garrey, W. E.

'05. The osmotic pressure of sea water and the blood of marine animals. *Biol. Bull.* Vol. VIII, No. 4.

Hoffbauer, —.

'99. Die Altersbestimmung des Karpfen an seiner Schuppe. *Jahresberichte des Schlesischen Fischerei-Verein.*

Hutton, J. Arthur.

'10. Salmon scale examination and its practical utility, with notes on Wye salmon fisheries and the photography of the scales. Sherratt and Hughes, London.

Johnston, H. W.

'05. The scales of salmon as indicative of age, growth and spawning habit. 26th Rep. Scot. Fish. Bd. Pt. II, App. II.

'08. The scales of salmon. 26th Rep. Scot. Fish. Bd. Pt. II, App. III.

'10. The scales of salmon. 28th Rep. Scot. Fish. Bd. Pt. II, App. III.

Sumner, P. B.

'06. The physiological effects upon fishes of changes in density and salinity of water. Bull. U. S. Fish. Com., Vol. XXV.

A CATALOGUE OF SCIENTIFIC PERIODICAL LITERATURE ON FILE IN
VARIOUS LIBRARIES OF THE STATE.*

COMPILED BY HOWARD J. BANKER AND WILL SCOTT.

Abbreviations used—

Bold faced figures = number of volume.

+ after volume number = all succeeding numbers on file and current numbers received.

Indices = numbers of an incomplete volume. Used in Academy list.

* = incomplete volume.

o.s. = old series.

n.s. = new series.

Roman numerals = series.

The year (e.g. '95) = date of volume. Used where volumes are not numbered serially or number of volume was unknown.

N.D. = Notre Dame.

W. = Wabash.

D. = DePauw.

R.P. = Rose Polytechnic.

S.N. = State Normal School.

F. = Franklin.

P. = Purdue.

B. = Butler.

E. = Earlham.

ACAD. = Indiana Academy exchanges deposited in the State Library at Indianapolis.

I.U. = Indiana University.

*At the meeting of the Indiana Academy of Science for 1911 the compilers of this catalogue were appointed to collect and publish in the proceedings of the Academy a list of the Scientific periodical literature on file in the college and university libraries of the State, together with the exchanges of the Academy deposited in the Indiana State Library at Indianapolis. The lack of uniformity in the lists submitted, the incomplete statement of titles, and the occasional inexact use of the terms "complete" and "current" have probably resulted in some errors. This list may be made the basis of a very complete and exact catalogue.

CATALOGUE.

- Abhandlungen der Königlich Preusschen Akademie der Wissenschaften.
I.U. 1+.
- Abstracts** of physical papers. P. 3.
- Academia** nacional de ciencias, Cordoba, Argentine Republic. *Actas*. ACAD. 5¹⁻³. *Boletín*. ACAD. 7^{1, 3, 4}, 8¹⁻³, 9, 10, 11¹⁻⁴, 12²⁻⁴, 13¹, 14^{1, 2}, 15¹⁻³, 16^{1, 4}.
- Academia** de ciencias medicas fisicas y naturales de la Habana, Havana, Cuba.
Anales. ACAD. 36^{4, 18-21, 24}.
- Academie** des sciences; Comptes rendus. I.U. 1.
- Academie** imperiale des sciences, St. Petersburg, Russia. *Bulletins*. ACAD. IV. 36^{1, 2}, V. 1-5, 6¹⁻⁵, 7^{1, 2}, 10⁵, 11-14, 15¹⁻⁵, 16¹⁻³, 22-25.
- Academy** of natural sciences of Philadelphia, Pa. *Proceedings*. N.D. 62+;
B. '56-'86, '88-'93, '95+; ACAD. 58+; I.U. 1+.
- Acetylene** journal. N.D. '08-'10.
- Acta** mathematica. I.U. 1+.
- Advanced** therapeutics. P. 23*, 24*.
- American** academy of arts and sciences, Boston. *Proceedings*. R.P. 1-7, 9-16;
S.N. 34-37; P. 40*, 41*; ACAD. 34+. *Memoirs*. R.P. n.s. 1-9; P. 13*.
- American** academy of medicine. I.U. 6+.
- American** anthropologist. I.U. 1+.
- American** antiquarian and oriental journal, Chicago, Ill. ACAD. 3², 6⁵, 11⁵, 14².
- American** architect. R.P. 21+.
- American** association for the advancement of science. *Proceedings*. W. 45+;
R.P. 1-41, 43-55, 59-61; S.N. 1-44; P. 29+; I.U. 1+.
- American** botanist, Joliet, Ill. N.D. 15+; D. 1+.
- American** chemical journal. N.D. 17+; W. 1+; D. 1+; R.P. 17+; P. 1+;
B. 8+; E. 39+; I.U. 8+.
- American** chemical society. *Journal*. N.D. '76+*; W. 15, 16, 24+; D. 15+;
R.P. 15+; P. 1+; I.U. 28. *Review of American chemical research*. P. '03-'06. *Chemical abstracts*. N.D. 1+; W. 1+; D. 1+; P. 1+. *Proceedings*. I.U. 31+.
- American** chemist. W. 1-4; R.P. 1-7.
- American** city. P. 1+.
- American** druggist. P. 14+.
- American** electrician. R.P. 11-17.
- American** electro-chemical society. *Transactions*. P. 1+.
- American** ephemeris of materia medica. P. 1-3.
- American** engineer. R.P. 9-21.

- American engineer and railroad journal.** R.P. 71+.
- American fern journal.** N.D. '10+.
- American forestry, Washington, D. C., (see Conservation).** D. 16+: P. 16+.
- American forestry association. *Proceedings.*** P: 10*, 12*.
- American forestry congress. *Proceedings.*** P. 4.
- American garden.** P. 1-10.
- American gas institute. *Proceedings.*** R.P. 2+.
- American geographical society, New York. *Bulletin.*** S.N. 34+: ACAD. 14⁶, 15⁷, 16⁵, 17^{1,2,4,5}, 18²⁻⁵, 19¹⁻³, 20¹⁻⁴: I.U. 1+. *Journal.* S.N. 28-33. Continued as the Bulletin.
- American geologist (continued as Economic geology *q.v.*).** W. 11-26: S.N. 12-36: E. 29+: B. 10-24.
- American health.** P. 1, 2.
- American homes and gardens (continuation of Scientific American, building edition).** R.P. 1+.
- American horticulturist.** I.U. '85-'86.
- American institute of the city of New York. *Transactions.*** P. 6.
- American institute of electrical engineers. *Proceedings.*** R.P. 24+. *Transactions.* R.P. 20-21, 28, 29.
- American institute of mining engineers. *Transactions.*** R.P. 1+.
- American journal of anatomy.** S.N. 1+: P. 5+: I.U. 1+.
- American journal of archaeology.** D. 1-11; II. 1+: I.U. 1+.
- American journal of conchology.** P. 1-7.
- American journal of diseases of children.** I.U. 1+.
- American journal of mathematics, Baltimore, Md.** W. 15+: D. 1-16: P. 1+: I.U. 1.
- American journal of medical science.** I.U. 133+.
- American journal of microscopy and popular science, New York.** D. 1, 2: R.P. 1-5.
- American journal of pharmacy.** R.P. III. 1-18; IV. 1, 2: P. 54, 55, 58+.
- American journal of physiology, Boston.** D. 15-20: S.N. 1+: P. 13+: I.U. 1+.
- American journal of psychology.** S.N. 1+: P. 19+: E. 2-6, 12, 14, 16, 17: I.U. 1+.
- American journal of public hygiene.** P. n.s. 1+.
- American journal of science.** W. 1-150, n.s. 1-28: R.P. 1+: S.N. 100+: P. 1+: B. III. 11-16, 19-50; IV. 1+: E. 27+: I.U. 1+.
- American journal of science and arts, New Haven, Conn.** D. 10, 11.

- American machinist.** R.P. 6+.
- American mathematical monthly.** W. 5+: S.N. 4+: P. 1-8, 12+: I.U. 1+.
- American mathematical society, New York.** *Bulletin.* W. 8+: D. II. 1-6:
S.N. 1, 3+: P. II. 1+: I.U. 1+. *Transactions.* P. 1+: I.U. 1+.
- American medical association.** *Journal.* P. 1-3, 9-22, 36, 38, 40+*: I.U. 41+.
- American microscopical society, Decatur, Iowa.** *Transactions.* W. 18+:
D. 30+.
- American midland naturalist, Notre Dame, Ind.** N.D. 1, 2.
- American monthly magazine.**† N.D. '17, '18.
- American monthly microscopical journal, Washington, D. C.** N.D. 1+*:
D. 1, 10-15, 18-23*: R.P. 1-2: P. 2.
- American museum journal.** N.D. '09+.
- American museum of natural history, New York.** *Bulletins.* P. 8: ACAD.
1¹⁻⁸. *Reports.* ACAD. '70-'89.
- American naturalist.** N.D. 1+: W. 1-34, 36-39, 43+: D. 1-5, 20+: S.N. 1+:
F. 1-4, 11-13: P. 1-8, 10*, 11+: E. 1-4, 7, 40+: B. 1-6, 11+: I.U. 1+.
- American pharmaceutical association.** *Bulletin.* P. 2+. *Proceedings.* P. 7,
10, 14, 15, 32+: I.U. '02+.
- American philosophical society, Philadelphia.** *Proceedings.* R.P. 1744-1838,
'76-'90: ACAD. 27-38, 47, 48, 51-156, 158, 197, 199-201.
- American physical education review.** I.U. 1+.
- American quarterly microscopical journal.** R.P. 1-3.
- American society of civil engineers.** *Transactions.* R.P. 43, 44, 60+.
- American society for psychical research.** *Journal.* S.N. 1, 2, 4+. *Proceed-
ings.* S.N. 1+.
- American society of mechanical engineers.** *Transactions.* R.P. 1+.
- American society for testing materials.** *Proceedings.* R.P. 2-8.
- Analyst.** P. 8+: I.U. 1-10.
- Analyst (Math.) continued as Annals of mathematics q. v.** P. 1-10.
- Anatomical record.** S.N. 5+: P. 1+.
- Anatomischer Anzeiger.** B. 13+: I.U. 1+.
- Annalen der Chemie (Liebig).** W. 285 350: D. 1+: P. 301+. *Supplement.*
D. 1-8.
- Annalen aus dem hirnanatomischer Institute in Zürich:** I.U. 1+.
- Annalen der Physik und Chemie.** W. 16+: P. III. 1+: I.U. 284. *Beiblätter.*
P. 31+: I.U. 17+.

† Contains writings of Rafinesque.

- Annales de chemie et de physique.** N.D. '99-'06: B. '73: I.U. VI. 28, 30; VII. 2-30, VIII. 1+.
- Annales de geographie.** S.N. 8+: I.U. 7+.
- Annales historico-naturales musei nationalis hungarici,** Budapest, Hungary. ACAD. 1-8.
- Annales de L'Institute Pasteur.** I.U. 20+.
- Annales de paleontologie.** I.U. 1+.
- Annales des ponts et chaussees.** R.P. VI. 15+.
- Annales des sciences naturelles botanique.** W. VII. 19, 20; VIII. 2-14.
- Annali di mathematica.** I.U. III. 17+.
- Annals of botany,** London, Eng. W. 7: D. 1-7, 20+: S.N. 1+: P. 1+: I.U. 1+.
- Annals of mathematics,** Charlottesville, Va. (see *Analyst, math.*). W. 1-12, n.s. 1-9: D. 1-6: R.P. 1+: P. II. 1+: I.U. o.s. complete, n.s. 1+.
- (L) **Annee biologique.** I.U. 1+.
- (L) **Annee psychologique.** I.U. 1+.
- Annual record of science and industry.** D. '71-'73.
- Annual report on the progress of chemistry.** B. 5-7.
- Annual of scientific discovery.** D. '50-'62, '65, '68-'71.
- Arboriculture.** P. 1-8*.
- Arbeiten aus der kaiserlichen Gesundheitsante.** I.U. 24+.
- Archiv für Anatomie und Physiologie.** I.U. '77+.
- Archiv für Entwicklungsmechanik der Organismen.** I.U. 1+.
- Archiv der Mathematik und Physik.** P. 9+: I.U. 1+.
- Archiv für die gesammte Physiologie des Menschen und der Thiere.** D. 27, 28: P. 106+: I.U. 1+.
- Archiv für microscopische Anatomie.** I.U. 17+.
- Archiv für pathologische anatomie und Physiologie und für klinische Medicine.** I.U. 1+.
- Archiv der Pharmacie.** I.U. '00+.
- Archiv für Rassen-und Gesellschaft—Biologie.** I.U. 1+.
- Archive für Schul Hygiene.** I.U. 1+.
- Archives de Biologie.** I.U. 11+.
- Archives de Medicine experimentale.** I.U. 18+.
- Archives de Parasitologie.** I.U. 10+.
- Archives de Zoologie experimentale.** I.U. 9-10.
- Archives of psychology.** I.U. 1+.
- Arkansas geological survey.** *Report.* P. 88-92*.

Art amateur. R.P. 17-45.

Asiatic society of Bengal, Calcutta, Bengal. *Proceedings.* ACAD. '85^{1-4, 5-6}, '86^{1-4, 5, 81-9}, '87¹⁻¹⁰, '88-'91, '92¹⁻⁹, '93^{2-5, 5-10}, '94¹⁻¹⁰, '95, '96, '97^{1-4, 2-11}, '98¹⁻¹¹, '99, '00¹⁻³.

Association of engineering societies. *Journal.* R.P. 1+.

Astronomical journal. W. 13-21: D. 7+: I.U. 1+.

Astronomical society of the Pacific. I.U. 1+.

Astronomische Gesellschaft. I.U. 1+.

Astronomische Nachrichten. D. 113-138: I.U. 55-58, 107, 111-118, 121-122, 124+.

Astronomy and astro-physics. W. 11-13: D. 11-13.

Astrophysical journal. W. 1-6, 17+: D. 1+: P. 7, 19-27, 29+: I.U. 1+.

Atti Della Reale Accademia dei Lincea. I.U. 11+.

Augustana library publications. P. 4-6.

Auk, The, Cambridge, Mass. ACAD. 26¹.

Australian association for the advancement of science, Sydney, Australia. *Report.* ACAD. 7-12.

Belfast natural history and philosophical society, Belfast, Ireland. *Report.* ACAD. '85-'88, '96-'01, '04-'06, '08-'10.

Berichte der deutschen botanischen Gesellschaft. W. 13-15.

Berichte der Saechsischen Gesellschaft der Wissenschaften Math. I. U. 63+.

Berichte der deutschen chemischen Gesellschaft. N.D. '96+: W. 1+: D. 7+: P. 1+.

Berliner Klinische Wochenschrift. I.U. '06+.

Bibliographia physiologica. P. 1+: I.U. 1+.

Bibliographia zoologica. I.U. 1+.

Bibliographic geographique annuelle. I.U. 7+.

Beiblätter zu den Annalen der Physik und Chemie. I.U. 17+.

Beiträge zur Psychologie und Philosophie. I.U. 1+.

Biological bulletin, Woods' Hole, Mass. D. 1+: S.N. 1+: F. 18-20: P. 14+: I.U. 1+.

Biochemisches Centralblatt. I.U. 4+.

Biometrica. I.U. 1+.

Biological society of Washington, D. C. *Proceedings.* ACAD. 1-23*.

Biologisches Centralblatt, Leipsig, Germany. D. 1-30: I.U. 1+.

Bird lore. W. 3+: F. 12+.

Birds and nature. S.N. 1-21.

Bolletino della arboricoltura Italiana. N.D. '09+.

- Boletino** del comite regional del Estado Durango, Mexico. N.D. '10+.
- Boston** journal of natural history. R.P. 1-6.
- Boston** society of natural history. *Memoirs*. ACAD. 5³. *Proceedings*. ACAD. 31⁶, 34⁷.
- Botanical** gazette, Chicago, Ill. W. 1+: D. 12+: S.N. 1, 2, 4, 6, 8+: P. 1+: E. 13-30, 33+: B. 26-50: I.U. 13+.
- Botanical** magazine. N.D. 12, 13, 15, 18, 27.
- Botanical** society of Edinburgh, Edinburgh, Scotland. *Transactions*. ACAD. 22¹⁻³, 23¹⁻⁴, 24¹, 25+.
- Botanische** Zeitung. W. 51-59: I.U. 1+.
- Botanischer** Jahresbericht (Just's). W. 1-20: D. 1-32.
- Botanischer** Verein der Provinz Brandenburg, Berlin, Germany. *Verhandlungen*. ACAD. 36-52.
- Botanisches** Centralblatt, Jena, Germany. W. 49-60, 89+: D. 1+: I.U. 1+.
- Botanisches** Centralblatt-Beihefte. D. 1+: I.U. 9+.
- Botaniska** notiser, Sweden. N.D. '09+.
- Brain**. S.N. 13, 15+: I.U. 12+.
- Brazil** museu Goeldi. *Boletin*. P. 4, 5².
- Breeder's** gazette. D. 55.
- Brickbuilder**. R.P. 9+.
- Bristol** naturalist's society, Bristol, England. *Proceedings*. ACAD. 1^{2,3}, 2^{1,2}.
- British** association for the advancement of science. R.P. '31+.
- British** medical journal. I.U. '06+.
- British** patents, abridgements. R.P. 1588+.
- British** journal of psychology. P. 2+.
- Brown** University. Studies from the biological laboratory. I.U. 1+.
- Bryn Mawr** college. *Monographs*. ACAD. 1^{2,4}, 5-7, 9.
- Bryologist**. N.D. 12+: D. 1+.
- Buffalo** society of natural sciences. *Bulletin*. P. 1, 2: ACAD. 1-4, 5^{1,2,5}, 6, 9³.
- Bulletin** astronomique. W. 15-17: I.U. 14+.
- Bulletin** de l'Institute Pasteur. I.U. 3+.
- Bulletin** de jardin botanique de L'etat a Bruxelles. N.D. '09+.
- Bulletin** of pharmacy. P. 14+.
- Bulletin** des sciences mathematique et astronomique. I.U. 1+.
- Bureau** of American ethnology. *Report*. P. 1+: *Bulletin*. P. 33+.
- California** academy of sciences. *Bulletins*. ACAD. 1⁴, 2³⁻⁵. *Memoirs*. ACAD. 4, 5¹. *Occasional papers*. ACAD. 1-9. *Proceedings*. ACAD. II. 1^{1,2}, 2, 3^{1,2}, 4^{1,2}, 5^{1,2}, 6; III. bot. 1¹⁻¹⁰, 2¹⁻¹¹; geol. 1¹⁻¹⁰, 2^{1,2}; math. and phys. 1¹⁻⁸; zool. 1¹⁻¹², 2¹⁻¹¹, 3¹⁻¹³, 4¹⁻³; IV. 1, 3.

- California** state board of forestry. *Bulletin*. P. 1. *Biennial reports*. P. 3.
- California** university chronicle. P. 11+.
- Canada** commission of conservation. *Report*. P. 1+.
- Canada** geological and natural history survey. *Summary reports*. P. '85-'87, '89, '91, '05, '06.
- Canada** geological survey. *Annual reports*. P. n.s. 1+. *Report of progress*. P. 20-27.
- Canada**, interior department, forestry branch. *Bulletin*. P. 1+.
- Canada**, superintendent of forestry and irrigation. *Report*. P. '09-'10.
- Canadian** entomologist, London, Ontario, Canada. D. 24-30*: P. 39+.
- Canadian** forestry association. *Report*. P. 11+.
- Canadian** institute, Toronto. *Reports*. ACAD. '86-'91. *Proceedings*. ACAD. 3²⁻⁴, 4^{1,2}, 5^{1,2}, 6^{1,2}, 7¹; n.s. 1¹⁻⁶, 2¹⁻⁶. *Transactions*. ACAD. 1^{1,2}, 2^{1,2}, 4², 5^{1,2}, 6^{1,2}, 7¹⁻³, 8¹⁻⁴, 9¹.
- Canadian** record of science. I.U. '96-'05.
- Carnegie** institute. *Annual reports*. P. 1+; ACAD. '98+. *Annals*. ACAD. '01+. *Memoirs*. ACAD. 1, 2, 3¹, 4¹⁻⁷. *Celebration of founder's day*. ACAD. '98-'00, '02-'05, '07+. *Prize essay contest*. ACAD. '99-'04.
- Cassier's** magazine. R.P. 5-33, 36+; S.N. 13+; F. 39+; I.U. 6+.
- Cellule**, Ia. N.D. 1+; I.U. 22+.
- Centralblatt** für normale Anatomie und Microtechnik. I.U. 1+.
- Centralblatt** für Bakteriologie. P. 36+.
- Centralblatt** für allgemeine und experimentelle Biologie. I.U. 1+.
- Centralblatt** für Electrotechnik. R.P. 7-10.
- Centralblatt** für Physiologie. W. 6: P. 19+.
- Central Park** menagerie, New York. *Reports*. ACAD. '88-'90.
- Central states** medical monitor. P. 5-11*.
- Chemical** abstracts. I.U. 1+.
- Chemical** engineer. N.D. 1+; P. 1+.
- Chemical** engineering and physical chemistry. B. 1+.
- Chemical** news. N.D. 79+; W. 1-6; D. 1-61; R.P. 71+; S.N. 39-52, 61-63, 68+; P. 33+.
- Chemical** society, London. *Journal*. N.D. 16-96; W. 65+; D. 24+; R.P. 28+; B. '06+. *Reports*. D. 1-6; P. 1+; B. '10.
- Chemisches** Centralblatt. N.D. 77+; R.P. '04+; P. 47+; I.U. 52+.
- Chemist** and druggist. P. 70+.
- Chicago** academy of sciences. *Bulletin*. ACAD. 1¹⁻¹⁰, 2²⁻⁴, 3¹⁻⁵. *Reports*. ACAD. '95-'97. *Bulletin of the natural history survey*. ACAD. 1-6, 7¹.

- Chicago** entomological society. *Memoirs*. ACAD. 1¹.
- Cincinnati** lancet-clinic. P. 16-24*.
- Cincinnati** society of natural history. *Journal*. ACAD. 11, 12¹⁻³, 15^{3,4}, 16²⁻⁴, 17-19, 21^{1,2}; I.U. 1-2.
- Cincinnati** university studies. P. II. 1+.
- Civil engineer's** journal. R.P. 1-25.
- Colorado** scientific society. *Proceedings*. P. 9+.
- Colorado** college, Colorado Springs. *Studies*. P. science ser. 13-20, 23-26, 30-32, 39+: ACAD. '91, '94.
- Colorado** scientific society, Denver. *Bulletin*. ACAD. '97¹⁰⁻¹¹, '98¹, '99^{3,4}, '00².
Proceedings. ACAD. 1, 2¹⁻³, 3¹⁻³, 5-9.
- Colorado** university. *Studies*. P. 1+.
- Columbia** university, New York. *Bulletin*. P. 1-20. *Quarterly*. P. 1+.
Ernest Kempton Adams fund for physical research, publications. P. 1.
- Comité** géologique, St. Petersburg, Russia. *Bulletins*. ACAD. 17-28, 29¹⁻⁴.
Memoirs. ACAD. 2², 7, 8³⁻⁴, 9³⁻⁵, 10³⁻⁴, 12³, 13²⁻⁴, 14, 15¹⁻⁴, 16^{1,2}, 17^{1,3}, 18¹⁻³, 19, 20^{1,2}, n.s. 1-38, 40-52, 56, 57, 59.
- Comissão** dos trabalhos geologicos, Lisbon, Portugal. *Communicacoes*. ACAD. 1-5, 6¹.
- Compressed** air. R.P. 9-11.
- Comptes** rendus hebdomadaires del'academie des sciences. R.P. 104+: P. 140+: I.U. 1+.
- Connecticut** academy of arts and sciences, New Haven. *Transactions*. ACAD. 8, 9², 10-16.
- Connecticut**, state geological and natural history survey. *Bulletin*. P. 1+.
- Connecticut**, commissioners of fisheries and game. *Report*. P. '09, '10.
- Connecticut**, shell-fish commissioners. *Report*. P. '09, '10.
- Conservation** (continued as American forestry *q. v.* See also Forestry and irrigation). P. 14, 15.
- Cuerpo** de ingenieros de minas, Lima, Peru. *Boletin*. ACAD. 1-21, 25-54, 56-59, 62-74, 76.
- Curtis'** botanical magazine. N.D. 1-12, 22, n.s. 6.
- Denison** university, Granville, Ohio. *Bulletin of the scientific laboratories*. ACAD. 2-5, 6¹, 9², 10, 11¹⁻⁸, 13¹⁻⁶, 14¹⁻¹⁸, 15, 16¹⁻¹⁷.
- Deutsche** Gesellschaft für Natur und Völkerkunde Ostasiens, Tokio, Japan. *Mitteilungen*. ACAD. 9³ supp. 2, 10¹⁻³, 11¹⁻⁴, 12^{1,2}, 13¹⁻³.
- Deutsche** Chemische-Gesellschaft zu Berlin-Berichte. I.U. '04+.
- Die landwirtschaftlichen Versuch-stationen. I.U. 35-47, 49+.

- Dingler's** polytechnisches journal. R.P. 259-262, 267-319.
- Economic geology** (see American geologist). S.N. 1+: E. 1+: I.U. 1+.
- Edinburg** mathematical society. Proceedings. I.U. '04+.
- Electrical engineer**, London. R.P. 1-32*.
- Electrical engineer**, New York (combined in 1899 with the Electrical world *q. v.*). R.P. 7-27.
- Electrical review**, London. R.P. 26+.
- Electrical review**, New York. R.P. 31+.
- Electrical world**. D. 3-4, 19+: R.P. 24+: S.N. 23+: E. 16, 17, 24, 25: I.U. 11+.
- Electrician**. D. 28-37: R.P. 47+: I.U. 51+.
- Electric journal**. R.P. 2+.
- Electrochemical** and metallurgical industry. See Metallurgical and chemical engineering.
- Elektrotechnische Zeitschrift**. R.P. 6, 7, 12+.
- Elisha Mitchell** scientific society of the university of North Carolina, Chapel Hill, N. C. *Journal*. ACAD. 1-3, 4¹, 5+.
- Engineer**. R.P. 1-28, 41, 69, 70, 97+.
- Engineering**. R.P. 3-42, 47+.
- Engineering** and mining journal. R.P. 20-36, 49+: I.U. 53+.
- Engineering digest**. See Industrial engineering and engineering digest.
- Engineering magazine**. R.P. 2+: S.N. 1+: F. 27-32: I.U. 1+.
- Engineering news**. R.P. 13+: I.U. '00+.
- Engineering record** and sanitary engineer. R.P. 12+: E. 51-60.
- English mechanic** and world of science. R.P. 45-77.
- Enseignement** mathématique. P. 5+: I.U. 11+.
- Entomological news**, Philadelphia, Pa. W. 9+: D. 1+.
- Entomological society** of America. *Annals*. W. 1+.
- Entomological society** of Ontario. *Reports*. S.N. '78, '81-'89, '91 '99. '00-'09.
- Entomologiska** föreningen, Stockholm, Sweden. *Entomologisk tidskrift*. ACAD. 13¹⁻⁴, 18-25, 26¹⁻⁴, 28-30, 31¹⁻⁴.
- Ergebnisse** der Anatomie und Entwicklungsgeschichte. I.U. 1+.
- Ergebnisse** der Physiologie. S.N. 1+: P. 1-5: I.U. 1+.
- Essex institute**, Salem, Mass. *Bulletin*. ACAD. 19¹⁻³, 20⁴⁻¹², 21-23, 24^{1-3, 7-12}, 25, 26⁴⁻¹², 27¹⁻⁶, 28-30⁷⁻¹⁰. *Report*. ACAD. '99, '00.
- Field** Columbian museum of natural history, Chicago, Ill. *Reports*. ACAD. 1, 2³⁻⁵, 3, 4¹. *Exchange catalogue*. ACAD. '96-'98. *Publications*. N.D. bot. ser. 1+: P. anthrop. ser. 1+; bot. ser. 1+; geol. ser. 1+; ornith,

ser. 1+; report ser. 1+; zoöl. ser. 1+: ACAD. anthrop. ser. 2¹⁻³⁻⁶, 3¹⁻⁴, 4 6¹, 7¹; bot. ser. 1¹⁻³⁻⁵, 2¹⁻³⁻⁷, 3²; geol. ser. 1¹⁻³⁻⁷, 2²⁻⁴⁻⁶⁻¹⁰, 3¹⁻⁹, 4¹; ornith. ser. 1¹⁻²⁻⁶; zoöl. ser. 1²⁻⁸⁻¹¹⁻¹⁷, 2², 3¹²⁻¹⁶, 4¹⁻², 5-10.

Flora. I.U. 86+.

Folia haematologica. I.U. 3+.

Folia serological. I.U. 1+.

Forester. P. 4-7.

Forestry and irrigation (continued as Conservation *q. v.*). P. 8-13.

Forestry quarterly. W. 3+.

Forschungs Berichte aus der biologisches Station zu Plön, von Dr. Otto Zacharias. Stuttgart. I.U. 1+.

Fortschritte der Physik. P. 4+.

Fort Wayne medical journal. P. 2, 22, 27, 28*.

Franklin institute. Journal. R.P. 5-47, 49-51, 86-97, 115+.

Gas engine. R.P. 4+*.

Geographische Zeitschrift. I.U. 5+.

Geographical journal. S.N. 1+.

Geographical society of America. Bulletin. S.N. 1+.

Geographical society of Philadelphia, Pa. Bulletin. S.N. 7+.

Geological magazine. I.U. 1+.

Geological society of America. Bulletin. E. 13+: I.U. 1+.

Geological society of London. I.U. 60+.

Geologisches Centralblatt. I.U. 1+.

Georgia forest association. Forest, fish and game (formerly Southern woodlands). P. 2, 3.

Georgia geological survey. Bulletin. P. 24, 25. *Report.* P. '93.

Giornale di Mathische. I.U. 1+.

Guide to nature. N.D. '09+: F. 3+.

Gulf biological station, Cameron, La. Bulletin. P. 3, 4, 6, 7, 9-11, 13+.

Hamburgische botanische staatsinstitute. Jahresberichte. N.D. '05+.

Hamilton scientific association, Hamilton, Ontario. Journal and proceedings. ACAD. 1¹, 14-19, 21-23, 25, 26.

Harvey society, New York. Lectures. P. '05+.

Harvard university. Publications from the Jefferson physical laboratory. P. 4, 6+. *Contributions.* E. 1+.

Havana university. Revista de la facultad de letras y ciencias. P. 3+.

Hawaii agricultural experiment station. Report and bulletin. N.D. '10+.

Histologisches und Histopathologische Arbeiten und die Grosshirnrinde. I.U. 1+.

- Historical** and scientific society of Manitoba, Winnipeg, Manitoba. *Reports*.
ACAD. '97-'06. *Transactions*. ACAD. 51-72.
- Horticultural** society of London. *Transactions*. N.D. 1-4.
- Hygienisches** centralblatt. I.U. 1+.
- Illinois** state geological survey. *Bulletin*. P. 3+.
- Illinois** state laboratory of natural history. *Bulletin*. N.D. '04+: S.N. 1-7:
ACAD. 1^{1,2,6}, 2^{1,3,4,7,8}, 5³⁻¹², 6¹, 7¹⁻¹⁰, 8¹⁻⁵, 9¹⁻⁴.
- Illinois** university, state water survey. *Bulletin*. P. 1+.
- Illinois** university. *Studies*. P. 1+*.
- Imperial** journal of arts, science, etc. F. 1-4.
- Index Medicus**. I.U. 3+.
- India**, inspector-general of forests. *Review of forest administration*. P. '07-'10.
- Indiana** academy of science, Indianapolis. *Proceedings*. N.D. 24+: S.N.
7-9, 14+: P. 7+: I.U. 1+.
- Indiana** geographical congress. *Reports*. S.N. 3, 6.
- Indiana** horticultural society. *Transactions*. D. '79.
- Indiana** medical journal. P. 3-27*: I.U. 7+.
- Indiana** medical association. *Journal*. P. 1+.
- Indiana** pharmaceutical association. *Proceedings*. P. '96, '99.
- Indiana** state board of forestry. *Report*. D. 6, 7, 10.
- Indiana** state medical society. *Transactions*. P. '79, '80, '91, '93, '95.
- Indiana** university. *Studies*. P. 1+: I.U. 1+.
- Indianapolis** medical journal. P. 12+.
- Industrial** engineering and engineering digest. R.P. 3+: E. 3, 4.
- Industries**. R.P. 1-15.
- Inland** architect. R.P. 30-52.
- Insect** life, Washington, D. C. D. 3-7*.
- Institut** international de bibliographie, Brussels, Belgium. *Bibliographia
physiologica*. ACAD. 1¹⁻⁵, 2^{1,2}.
- Instituto** medico nacional, Mexico City, Mexico. *Anales*. ACAD. 11¹⁻³.
- L'Intermediaire** des mathematiens. P. 18+: I.U. 1+.
- Internationale** Monatschrift für Anatomie und Physiologie. I.U. 1+.
- International** journal of microscopy and natural science. D. 2.
- Internationale** wochenschrift für Wissenschaft, Kunst, und Technik. I.U. 1+.
- Ion**. W. 1.
- Iowa** academy of sciences, Des Moines. *Proceedings*. ACAD. 11, 12, 17.
- Iowa** geological survey. *Bulletin*. P. 1.
- Iowa** state university. *Contributions from the physical laboratory*. P. 1*.
Natural history bulletins. P. 2-4. *Studies in psychology*. P. 1, 2.

- Iron and steel magazine** (formerly *Metallographist q.v.*). P. 7-11.
- Jahrbucher** für wissenschaftliche-Botanik. I.U. 14+.
- Jardin** Botanique de Buitenzorg; *Annales*. (Botanical and Zoological parts). I.U. 1+.
- Jahrbuch** der Chemie. P. 19+.
- Jahrbuch** über die Fortschritte der Mathematik. P. 1+: I.U. 1+.
- Jahresberichte** der deutschen mathematiker Verliniguna. I.U. 1.
- Jahresberichte** über die Fortschritt der Anatomie und Physiologie. I.U. 1-8.
- Jahresberichte** über die Fortschritte in der Lehre von den Pathogenen Microorganismen. I.U. 1+.
- Jahresbericht** über die Fortschritte der Chemie. P. '22-'74.
- Jahresbericht** über die Fortschritte der reinen pharmaceutischen und technischen Chemie, Physik, Mineralogie, und Geologie. I.U. 1+.
- Jahresbericht** über die Leistungen und Fortschritte auf dem Gebiete der Neurologie und Psychiatrie. I.U. 1+.
- Johns Hopkins hospital**. *Bulletin*. P. 17+: I.U. 1+.
- Johns Hopkins university**, Baltimore. *Circulars*. P. 17+: ACAD. 4-21*.
- Journal** of analytic and applied chemistry. W. 1-7.
- Journal** of analytical chemistry. R.P. 4-7: P. 4-7.
- Journal** de l'anatomie et de la physiologie. I.U. 1+.
- Journal** of anatomy and physiology. I.U. 1+.
- Journal** of abnormal psychology. I.U. 1+.
- Journal** of animal behavior, Cambridge, Mass. D. 1+: S.N. 1+: B. 1+: I.U. 1+. *Behavior monographs*. B. 1+: I.U. 1+.
- Journal** of applied microscopy, Rochester, N. Y. N.D. 1-6*: W. 1-6: S.N. 4-6: B. 2-6.
- Journal** of biological chemistry. I.U. 1+.
- Journal** of botany. P. 10. I.U. 1+.
- Journal** of comparative neurology, Philadelphia, Pa. D. 1+: S.N. 16+: I.U. 1+.
- Journal** de l'ecole polytechnique. I.U. '10+.
- Journal** of economic entomology. W. 2+: P. 1+.
- Journal** of educational psychology. P. 1+.
- Journal** of experimental medicine. I.U. 1+.
- Journal** of experimental zoölogy, Philadelphia, Pa. W. 2+: S.N. 1+: P. 1+: I.U. 1+.
- Journal** of geography. S.N. 1+: I.U. 1+.
- Journal** of geology. W. 1+: S.N. 1+: P. 1+: E. 1+: B. 7-18: I.U. 1+.

- Journal of mental science.** I.U. 40+.
- Journal of hygieo-therapy.** P. 1*: I.U. 1+.
- Journal of hygiene.** P. 6+.
- Journal of industrial and engineering chemistry.** N.D. 1-3: D. 1+: P. 1+: I.U. 1+.
- Journal of infectious diseases.** P. 1+.
- Journal de mathematique.** I.U. 1+.
- Journal of the mathematico-physical society of Tokyo.** I.U. '11+.
- Journal of medical research.** I.U. 6+.
- Journal of morphology, Philadelphia, Pa.** W. 17: D. 1+: P. 1+: B. 10+*: I.U. 1+.
- Journal of mycology, Columbus, Ohio.** N.D. 1-8: W. 9-12: D. 1-14.
- Journal of nervous and mental diseases.** I.U. 27+.
- Journal of pathology and bacteriology.** I.U. 1+.
- Journal of philosophy, psychology, and scientific methods.** P. 5+: E. 1-6: I.U. 1+.
- Journal of physical chemistry.** P. 6+: I.U. 1+.
- Journal de physiologie et pathologie.** I.U. 1+.
- Journal of physiology, Cambridge, England.** D. 1-6, 12-16: P. 32+.
- Journal de physique.** W. 2, 4, 5: P. 4+.
- Journal für Psychologie und Neurologie.** I.U. 1+.
- Journal für praktische Chemie.** W. 1-80.
- Journal of the royal sanitary institute.** P. 29+.
- Journal of school geography.** S.N. 1+.
- Journal of tropical medicine.** I.U. 6+.
- Kaiserlich königlich zoologisch-botanische Gesellschaft, Wien, Austria.**
Verhandlungen. ACAD. 38, 39¹⁻⁴, 40^{3,4}, 41-43, 44¹⁻⁴, 45¹⁻¹⁰, 46^{1-3,5,7,9,10}, 47¹⁻¹⁰, 49-60.
- Kaiserlich Leopoldinisch Carolinische deutsche Akademie der Naturforscher, Halle, Prussia.** *Abhandlungen.* ACAD. 68, 69^{1,2}, 70¹, 73³, 77¹, 79², 81^{1,3,6}, 82^{3,4}, 86^{1,2}, 88³, 90^{1,3,4}, 92¹, 93².
- Kansas academy of science, Topeka.** *Transactions.* E. 13, 15-18: ACAD. 9, 19-22, 24.
- Kansas geological survey.** *Report.* P. 3, 5, 6. *Mineral resources.* P. '99-'03.
- Kansas state department of fish and game.** *Bulletin.* P. 1+.
- Kansas university, Lawrence, Kan.** *Science bulletin.* P. 1+: ACAD. 1-5. *Quarterly.* P. 1-10*.
- Kentucky geological survey.** *Report of progress.* P. n.s. 1.

- Kongelige** norske videnskabers Selskab, Trondhjem, Norway. *Skifter*. ACAD. '97-'09.
- Kongliga** svenska vetenskaps-akademien, Stockholm, Sweden. *Arkiv*. ACAD. för kemi 1¹, 3¹⁻⁶, 4¹; för zoologi 1¹, 4, 5, 6¹⁻⁴, 7¹; för botanik 1¹⁻⁴, 2¹⁻³, 7, 8, 9¹⁻⁴. *Behang till handlingar*. ACAD. 12-28.
- Königlich** bayerische Akademie der Wissenschaften, Munich, Germany. *Sitzungsberichte*. ACAD. 1-15.
- Königliche** Gesellschaft der Wissenschaften zu Göttingen-mathematische physikalische Klasse. I.U. 61+.
- Koninklijke** natuurkundige vereeniging in Nederlandsch-Indie, Weltevreden, Dutch East Indies. *Natuurkundig tijdschrift*. ACAD. 52, 53, 55-69.
- Koninklijke** Akademie von Wettenschapen. I.U. 13+.
- Leland Stanford, Jr.** university. *Publications*. P. univ. ser. 1+. *Contributions to biology*. P. 1-8, 10-12, 14, 16, 18-30.
- Lens**. R.P. 1, 2.
- Linnean** society of New South Wales, Sidney, Australia. *Proceedings*. ACAD. 25, 26¹⁻⁴, 27²⁻⁴, 28¹⁻⁴, 29¹⁻².
- Linnaean** society of New York. *Abstract of proceedings*. ACAD. 1-4, 6-11. *Transactions*. ACAD. 1.
- Lister** institute of preventive medicine, London, England. *Collected papers*. ACAD. 2-6.
- Lloyd** library, Cincinnati. *Bulletins*. P. 1+: ACAD. bot. ser. 1; myc. ser. 1-4; Pharm. ser. 1-4; reproduc. ser. 1-6. *Notes*. P. 1-11, 14+: ACAD. 1-8, 19-26, 30-35.
- London** microscopical society. *Transactions*. R.P. 1-3.
- London** mathematical society proceedings. I.U. I., *complete*; II., 1+.
- London** physical society. *Proceedings*. P. 19+.
- Louisiana** conservation commission. *Report*. P. '10.
- Louisiana** geological survey. *Bulletin*. P. 1-5, 7-8. *Report*. P. '99, '02.
- Louisiana** state museum, New Orleans. *Report*. ACAD. '10.
- Louisville** medical monthly. P. 2*, 3*.
- Machinery**. R.P. 3+.
- Magyar** királyi természéttudom ányi társulat, Budapest, Hungary. *Megbizás-ábol*. ACAD. 1-3.
- Magyar** madártani központ folyóirata, Budapest, Hungary. *Aquila*. ACAD. 5-16.
- Magyar** nemzeti múzeum, Budapest, Hungary. ACAD. 1-3.
- Maine**, commissioners of inland fisheries and game. *Report*. P. '02, '06+.

- Maine**, commissioners of sea and shore fisheries. *Report*. P. '02+.
- Maine** forest commissioner. *Report*. P. 4+.
- Manual** training magazine. I.U. 6+.
- Marine** biological laboratory, Woods Hole, Mass. *Lectures*. S.N. '93-'99.
I.U. 1+.
- Maryland** geological survey. *Report*. P. 1+.
- Maryland** weather service. *Report*. P. 1+.
- Massachusetts** agricultural society. *Reports*. N.D. complete.
- Massachusetts** horticultural society, Boston. *Transactions*. ACAD. '92², '93^{1,2},
'94^{1,2}, '95¹⁻³, '96¹⁻³, '97^{1,2}, '98^{1,2}, '99^{1,2}, '00², '03², '04^{1,2}, '05^{1,2}, '06-'09,
'10^{1,2}, '11¹.
- Massachusetts** state forester. *Bulletin*. P. 1, 3-5. *Report*. P. 5+.
- Mathematical** gazette, London. S.N. '07+: I.U. 1+.
- Mathematical** magazine. W. 2.
- Mathematical** monthly. R.P. 1-3: P. 1-3.
- Mathematical** questions and their solutions, London. I.U. 1+.
- Mathematische** annalen. R.P. 1+: P. 1+: I.U. 1+.
- Mathematische** und naturwissen-schaftliche Berichte aus Ungaren, Budapest,
Hungary. ACAD. 1-12, 14-25: I.U. 1+.
- Mathesis**. I.U. 1+.
- Mechanics**. R.P. 1-11.
- Medical** brief. P. 14-24*.
- Medical** herald. P. 8, 9*.
- Medical** mirror. P. 6, 7*.
- Medical** review of reviews. P. 7-12*.
- Medical** standard. P. 17, 18*.
- Medical** and surgical monitor. S.N. 8-10.
- Medical** and surgical reporter. P. 50-53*.
- Medical** world. P. 8, 11, 13, 14*.
- Merck's** bulletin. P. 2-4*.
- Merck's** report. N.D. 1+: P. 4, 6+.
- Meriden** scientific association, Meriden, Conn. *Transactions*. ACAD. 1-6.
- Messenger** of mathematics, London and Cambridge, England (see Oxford,
Cambridge and Dublin messenger of mathematics). D. 1-22: R.P. 1+:
S.N. 26-36: I.U. n.s. 1-23.
- Metallographist** (continued as iron and steel magazine *q.v.*). P. 1-6.
- Metallurgical** and chemical engineering (formerly Electrochemical and metal-
lurgical industry *q.v.*). N.D. '07+: D. 2+: R.P. 1+*: P. 1+: I.U. 1+.

- Meyer** brothers druggist. P. 12, 15, 17, 18, 22, 28+.
- Michigan** academy of science. *Bulletin*. P. 1-3*. *Report*. P. 1+.
- Michigan** forestry commission. *Report*. P. 1+*.
- Michigan** state forestry commission. *Report*. P. 1.
- Microscope**, The, Washington, D. C. N.D. 1+*: D. 12.
- Milwaukee** public museum. *Reports*. ACAD. '98+.
- Mind**. S.N. 1+: P. 17+: I.U. o.s. complete, n.s. 1+.
- Mind** and body. S.N. 1+: I.U. 1+.
- Mineral** industry. P. 7-15.
- Minnesota** academy of natural sciences, Minneapolis. *Bulletins*. P. 3*:
ACAD. 2¹⁻⁵, 3³.
- Minnesota** botanical studies. S.N. 1, 2: P. 1+.
- Minnesota** forestry commissioner. *Report*. P. 1-2, 4-8, 11, 12, 14, 16.
- Minnesota** geological and natural history survey. P. 1-4. *Report*. P. 9, 24.
- Minnesota** waterways commission. *Reports*. P. 1+.
- Mississippi** geological survey. *Bulletin*. P. 8.
- Missouri** botanical garden, St. Louis. *Reports*. N.D. 1-12, 14+: D. 10, 13,
16-21.
- Missouri** bureau of geology and mines. *Report*. P. I. 3; II. 1+. *Biennial reports to the general assembly*. P. '01+.
- Missouri** university. *Studies*. P. 1, 2; science ser. 1+. *Bulletin*. P. science ser. 2+.
- Mitteilungen** der mathematischen Gesellschaft in Hamburg. I.U. 5+.
- Monatshefte** für mathematik und physik. I.U. 20+.
- Montana** agricultural college. *Science studies*. P. 1*.
- Montana** university. *Bulletin*. P. biol. ser. 15.
- Monthly** microscopical journal, London. R.P. 1-18.
- Morphologisches** Jahrbuch. I.U. 1+.
- Muhlenbergia**. N.D. 5+.
- Muchner** medizinische Wochenschrift. I.U. 53+.
- Municipal** engineering. R.P. 22-29, 33+.
- Municipal** journal and engineer. R.P. 28+.
- Museo** de la Plata, Buenos Aires, Argentine Republic. *Anales*. ACAD. II. 1¹⁻². *Revista*. ACAD. 11-17.
- Museo** de la Plata, La Plata, Argentine Republic. *Anales*. ACAD. sec. paleontologica 5; sec. botanica 1.
- Museo** nacional, Buenos Aires, Argentine Republic. *Anales*. ACAD. 4-14.
- Museo** nacional de historia natural, Mexico City, Mexico. *La naturaleza*. ACAD. 7¹⁶⁻¹⁸; II. 1^{1-3, 5, 6, 9, 10}, 2^{10, 11}, 3¹⁻¹⁰; III. 1^{1, 2}.

- Museo nacional**, Mexico City, Mexico. *Anales*. ACAD. 4^{1,2}.
- Museo nacional**, Montevideo, Uruguay. *Anales*. N.D. '09+: ACAD. 2, 3; II. 1³, 4³.
- Museu nacional**, Rio Janiero, Brazil. *Archivos*. ACAD. 11-13.
- Museu paulista**, Sao Paulo, Brazil. *Revista*. ACAD. 4-8.
- Museum of foreign literature and science**. W. 2, 4-7, 12, 23, 24.
- Muséum national d'histoire naturelle**, Paris, France. *Bulletin*. ACAD. 11-16.
- Museum of natural history**, Springfield, Mass. *Reports*. ACAD. '95, '96, '08, '10, '11.
- Mycologia**, New York. W. 1-2: D. 1+: S.N. 1+: I.U. 1+.
- Nassauischer Verein für Naturkunde**, Wiesbaden, Germany. *Jahrbücher*. ACAD. '99+.
- National academy of science**. S.N. '83-'89, '91, '94, '03, '07. *Annual*. P. '63-'66. *Biographical memoirs*. P. 6. *Memoirs*. P. 1+. *Reports*. P. '63, '82+.
- National association of boards of pharmacy**. P. 5+.
- National conservation commission**. *Bulletin*. P. 4.
- National conservation association**. *Bulletin*. P. 3.
- National druggist**. P. 18-22, 24, 26-31, 36+.
- National geographic magazine**. N.D. 18+: S.N. 1+: P. 18+: E. 15+: I.U. 16+.
- National museum**, Melbourne, Australia. *Memoirs*. ACAD. 1-3.
- Natural history society of Glasgow**, Scotland. *Transactions*. ACAD. 5^{2,3}, 6^{1,2}, 7³.
- Natural history society of New Brunswick**, St. Johns, New Brunswick. *Bulletin*. ACAD. 4⁵, 5^{1,5}, 6¹⁻³.
- Natural science**, London and New York. D. 1.
- Naturaliste canadien** Chicoutimi, Quebec, Canada. ACAD. 24^{6-9,12}, 25-28, 29^{1-3,5-12}, 30, 31, 32^{1-3,8-10,12}, 33-35, 36^{1,2,4-11}, 37, 38¹⁻⁴.
- Nature**, London and New York. W. 1+: D. 37+: R.P. 1+: S.N. 1+: F. 50-58: P. 1+: B. 13-46, 48+.
- Nature**, Paris. R.P. 1+.
- Nature study review**. N.D. 5+: W. 1+: S.N. 1+: F. 6+: P. 4+.
- Naturforschende Gesellschaft**, Basel, Switzerland. *Verhandlungen*. ACAD. 8³, 9^{1,3}, 10^{1,3}, 11-19, 20¹⁻³, 21.
- Naturforschende Gesellschaft**, Bern, Switzerland. *Mittheilungen*. ACAD. 1073, 1769.

- Naturforschende** Gesellschaft, Zurich, Switzerland. *Vierteljahrshrift*. ACAD. 43¹⁻⁴, 44^{1,2}, 45-55.
- Naturforschenden** Vereines in Brunn. *Verhandlungen*. N.D. 4.†
- Naturhistorische** Gesellschaft, Hanover, Prussia. *Jahresbericht*. ACAD. 49-59.
- Naturwissenschaftlich** medizinischer Verein, Innsbruck, Austria. *Berichte*. ACAD. 14, 15, 17, 18, 27-33.
- Naturwissenschaftlicher** Verein, Bremen, Germany. *Abhandlungen*. ACAD. 14³, 15^{2,3}, 16¹⁻³, 17^{1,2}, 18^{1,2}, 19³, 20^{1,2}.
- Naturwissenschaftlicher** Verein, Hamburg, Germany. *Abhandlungen*. ACAD. 19³⁻⁵. *Verhandlungen*. ACAD. III. 10-18.
- Naturwissenschaftlicher** Verein für Schwaben und Neuburg, Augsburg, Germany. *Berichte*. ACAD. 33-40.
- Nebraska** university. *Studies*. N.D. 10+: P. 1-4*: I.U. 1+.
- Neues** Jahrbuch für Mineralogie, Geologie, und Palaeontologie. I.U. 1+.
- Neurologisches** Centralblatt. I.U. 1+.
- Nevada** university. *Studies*. P. 1+.
- New Albany** medical herald. P. 15, 16*.
- New Hampshire** forestry commission. *Report*. P. '85, '99, '01-'04, '09+.
- New Hampshire** forests, Society for the protection of. *Report*. P. 7, 8.
- New Jersey** forest park reservation commission. *Report*. P. 1+.
- New** phytologist. I.U. 4+.
- New** remedies. P. 7-12.
- New York** academy of medicine. *Transactions*. P. II. 3-10.
- New York** academy of sciences, New York. *Transactions*. ACAD. 2¹⁻⁸, 3, 4, 5¹⁻⁸, 6-8, 9¹⁻⁸, 10¹⁻⁶, 11²⁻⁵. *Annals*. ACAD. 3^{9,10}, 4^{1-8, 10,12}, 5-9, 10¹⁻¹², 13¹⁻³, 14¹⁻⁴, 15¹⁻³, 17-20, 21¹⁻³.
- New York** botanical garden, New York. *Bulletin*. ACAD. 2^{7,8}, 3⁹⁻¹¹, 4^{12,14}, 5¹⁵⁻¹⁸, 6¹⁹⁻²², 7²³⁻²⁶. *Contributions*. P. 90, 95. *Journal*. P. 3*.
- New York** entomological society, New York. *Journal*. ACAD. 8^{1,3,4}, 9¹⁻⁴, 10¹⁻².
- New York** forest, fish, and game commission. *Bulletin*. P. 2, 3, 5. *Report*. P. '02-'06.
- New York** geological survey. P. 4-6, 9.
- New York** mathematical society, New York (continued as American mathematical society *q.v.*). *Bulletin*. D. 1-3: P. 1-3.
- New York** medical journal. P. 51-63, 74, 79-86*.

†Contains Gregor Mendel's original paper on plant hybrids.

- New York** microscopical society, New York. *Journal*. ACAD. 1^{1,4-9}, 2^{1,4}, 7, 9, 9a, 3, 4¹⁻⁴, 5¹⁻³, 6²⁻⁴, 7^{1,2,4}.
- New York** state museum of natural history, Albany, N. Y. *Bulletin*. N.D. '09+: D. 38, 47, 54, 67, 68, 70, 75, 86, 94, 105, 116, 429, 450: P. 40, 49. *Report*. P. 20+*.
- New York** state science teachers' association. *Proceedings*. S.N. '07+.
- New York** state veterinary college, Ithaca, N. Y. *Abstracts of work done in laboratory*. P. 1+.
- North American** notes and queries, Quebec, Canada. ACAD. 1^{1,2}.
- North Dakota** geological survey. *Biennial report*. P. 2+.
- North Dakota** school of forestry. *Bulletin*. P. 1.
- North Dakota** university. *Quarterly Journal*. P. 1.
- Nouvelles** annales de mathematique. I.U. 1.
- Nova Scotian** institute of science, Halifax, N. S. *Proceedings and transactions*. ACAD. 7-11, 12^{1,2}.
- Nyt** Tidskrift für Mathematik. I.U. 1.
- Oberlin** college library, Oberlin, Ohio. *Wilson bulletin*. P. 14+: ACAD. 14+. *Laboratory bulletin*. P. 3, 11-15.
- Observatoire** royal de Belgique, Brussels, Belgium. *Annales physique*. ACAD. 3¹. *Annales astronomique*. ACAD. 9¹, 11¹.
- Observatory**. W. 16-19, 21, 22: D. 8+: I.U. 7, 11-14, 23.
- Obstetric** gazette. P. 10-12*.
- Ohio** geological survey. *Report*. D. 1², 2¹, 6, 7: P. 1-4. *Bulletin*. P. IV. 1+.
- Ohio** mechanics institute. *Quarterly journal*. P. 1+.
- Ohio** naturalist. N.D. 1+.
- Ohio** state academy of science, Columbus. *Report*. ACAD. '00-'06. *Special papers*. ACAD. 3-13.
- Ohio** topographic survey. *Report*. P. '03.
- Ohio** state forestry bureau. *Report*. P. 4.
- Oklahoma** academy of science, Norman, Okla. *Proceedings*. ACAD. '09, '10.
- Oklahoma** geological survey. *Bulletin*. P. 1-3, 5+. *Circular*. P. 1+.
- Oklahoma** university. *Research bulletins*. P. 1+.
- Oregon** conservation commission. *Report*. P. '09+.
- Oregon** university. *Bulletin*. P. n.s. 3*.
- Ornithologische** Gesellschaft in Bayern, Munich, Germany. ACAD. 5-10.
- Ornithologisches** jahrbuch, Hallein, Austria. ACAD. 9, 12, 13, 15, 17, 19, 21.
- Ottawa** naturalist, Ottawa, Canada. N.D. '09+: ACAD. 1-15*.
- Oxford**, Cambridge and Dublin messenger of mathematics, Cambridge, England (continued as Messenger of mathematics *q.v.*). D. 1-5.

- Paginas** ilustradas, San Jose, Costa Rica. *ACAD.* 2, 3, 11, 12, 14, 15, 18, 30, 34-37, 47, 50-53.
- Peabody** museum of American archaeology and ethnology, Cambridge, Mass. *Papers.* *ACAD.* 1¹⁻⁶. *Memoirs.* *ACAD.* 1¹⁻⁵. *Reports.* *ACAD.* '89, '90.
- Pennsylvania** forestry department. *Report.* P. '01, '02, '05+.
- Pennsylvania** geological survey. *Report.* P. 1-3.
- Pennsylvania** university. *Contributions from the zoölogical laboratory.* P. 1*.
- Pharmaceutical** era. P. 1-8, 13-21, 23, 25+*.
- Pharmaceutical** journal. P. 41+*.
- Philadelphia** medical journal. P. 8.
- Philippine** Islands ethnological survey. *Publications.* P. 1*, 4*.
- Philippine** journal of science. P. (all ser.) 3+.
- Philosophical** magazine and journal of science. W. 5+: R.P. V. 1-4, 14+: P. V. 25+.
- Photo** era. R.P. 6-8, 24+.
- Photographic** bulletin, Anthony's. R.P. '00*.
- Photographic** times. R.P. '87-'10*.
- Photo-miniature.** R.P. 1-3, 10+.
- Physical** review. W. 24+: D. 1+: R.P. 1+: S.N. 8-18: P. 1+: E. 24+: I.U. 1+.
- Physical** society of London. *Proceedings.* I.U. 1+.
- Physikalische** zeitschrift. R.P. '05+.
- Phytopathology**, Ithaca, N. Y. W. 1+: D. 1+: I.U. 1+.
- Plant** world, New York and Tuscon, Ariz. P. 11+: *ACAD.* 6¹⁻⁸, 7², 8⁴, 13¹: I.U. 8+.
- Pomona** college journal of entomology. N.D. '09+.
- Pontificia** accademia romana dei Nuovi Lincei, Rome, Italy. *Atti.* *ACAD.* 51-57, 58²⁻⁷, 59-63.
- Popular** astronomy. D. 11, 12*, 20+: F. 10+: E. 1+: I.U. 1+.
- Popular** mechanics. F. 15+.
- Popular** science. F. 1-55, 63+.
- Popular** science monthly. W. 1+: D. 1+: R.P. 1+: S.N. 1+: P. 1+: E. 1-12, 15-19, 24-29, 31, 32, 34, 36, 37, 40, 41, 43-65, 67+: B. 1+: I.U. 1.
- Popular** science news. W. 21-24.
- Popular** science review. R.P. 1-13.
- Portland** society of natural history, Portland, Me. *Proceedings.* *ACAD.* 24^{1, 5, 8-9}.
- Post** graduate. P. 19-21*.

- Power.** R.P. 14+.
- Practical** druggist and pharmaceutical review of reviews. P. 1-6*.
- Practical** engineer. R.P. 13+.
- Prince** Edward Island forestry commissioners. *Report*. P. '04.
- Princeton** university. *Contributions to philosophy*. P. 1*. *Contributions to psychology*. P. 1*, 2*.
- Progressive** medicine. I.U. 9+.
- Psyche.** S.N. 2-4.
- Psychological** bulletin. P. 5+: E. 1+: I.U. 1+.
- Psychological** clinic. S.N. 1+: P. 4+: I.U. 1+.
- Psychological** monographs. S.N. 6+: I.U. 1+.
- Psychological** review. D. 1+: S.N. 1+: P. 15+.
- Psychologische** Arbeiten. I.U. 1+.
- Psychologische** Studien. I.U. 1+.
- Psychotherapy.** I.U. 1+.
- Pure** products. P. 4+.
- Quarterly** journal of microscopical science, London, England. D. n.s. 34-36, 38: R.P. o.s. 1-8; n.s. 1-14: B. 22-25: I.U. 32-45.
- Quarterly** journal of pure and applied mathematics. London, England. W. 28: D. 1-25: R.P. 1+: I.U. 1+.
- Quebec** department of lands and forests. *Report*. P. '08, '09.
- Queensland** museum, Brisbane, Australia. *Annals*. ACAD. 6-9.
- Quekett** microscopical club, London. *Journal*. R.P. 1-5.
- Radium (Le)**, I.U. 1+.
- Railroad** and engineering journal. R.P. 61-68.
- Railway** age gazette. R.P. 17+.
- Real** academia de ciencias y artes, Barcelona, Spain. *Boletín*. ACAD. 1¹⁶⁻³⁰, 2^{1, 3-11}, 3^{1, 2}. *Memoirs*. ACAD. 3, 4^{1, 2, 6-40}, 5¹⁻²⁷, 6¹⁻³³, 7¹⁻¹⁷, 8¹⁻³¹, 10¹.
- Real** academia de ciencias exactas físicas y naturales, Madrid, Spain. *Memoirs*. ACAD. 12, 13¹⁻³, 14, 15¹⁻³, 18¹, 20, 21², 22-25, 26^{1, 2}. *Anuario*. ACAD. '89, '08, '11. *Revista*. ACAD. 1¹⁻⁸, 2²⁻⁵, 3, 4¹⁻⁶, 5¹⁻⁴ 7-12, 6-9.
- Reale** accademia dei Lincei, Rome, Italy. *Atti*. ACAD. 9-20*.
- Registered** pharmacist. P. 10, 11*.
- Rediconti** del Circolo Mathematico di Palernio. I.U. 1+.
- Repertorium** novarum specierum. N.D. 1+.
- Revista** montserratina (Spain). N.D. '10+.
- Revue** des questions scientifiques. N.D. 1+.
- Revue** internationale der gesamte Hydrobiologie und Hydrographie: I.U. 1+.

- Rhode Island** commissioner of birds. *Annual report*. P. '11.
- Rhode Island** commissioners of inland fisheries. *Report*. P. 41.
- Rhode Island** commissioners of shell fisheries. *Annual report*. P. '91, '92, '94, '95, '99, '00, '05+.
- Rhodora**. N.D. '09+.
- Rochester** academy of science. *Proceedings*. ACAD. 1¹, 2¹⁻⁴, 3¹⁻³, 4+: I.U. 1+.
- Revue de Mathematiques speciales**. I.U. 20+.
- Revue Philosophique**. I.U. 1-42, 49.
- Rose** technic. R.P. 1+.
- Revue Semestrielle des Publications Mathematiques**. I.U. 1+.
- Royal Asiatic society** of Great Britain and Ireland, Shanghai, China. *Journal*. ACAD. 21³⁻⁶, 22, 23¹⁻², 24¹, 25, 26, 30, 31.
- Royal astronomical society**. *Memoirs*. I.U. 41, 47-49, 53.
- Royal botanical garden** review. N.D. '09+.
- Royal botanic society** of London, England. *Quarterly record*. ACAD. 3-10*.
- Royal geological society** of Cornwall, Penzance, England. *Transactions*. ACAD. 13²⁻⁷.
- Royal microscopical society**, London. *Journal*. W. '92-'03: D. '89, '91-'95: R.P. I. 1-11. I: P. '82+.
- Royal philosophical society** of Glasgow, Scotland. *Proceedings*. ACAD. 29-41.
- Royal physical society** of Edinburgh, Scotland. *Proceedings*. ACAD. sessions 115-120, 122-124, 128.
- Royal society** of Canada. *Transactions*. P. II. 8*, 9*; III. 1.
- Royal society**, Edinburgh, Scotland. *Proceedings*. R.P. 11-27: ACAD. 21-31. *Transactions*. R.P. 1+.
- Royal society**, London, England. *Proceedings*. W. 72-75; ser. A. 76+; ser. B. 76+: R.P. 7+: I.U. ser. A. 1+; ser. B. 1+. *Philosophical transactions*. R.P. complete: P. 158+.
- Royal society** of New South Wales, Sidney, Australia. *Journal*. ACAD. 19-44*.
- Royal society** of Queensland, Brisbane, Australia. *Proceedings*. ACAD. 13-22.
- St. Louis** academy of science. *Transactions*. P. 6*, 14*: ACAD. 4³⁻⁴, 5¹⁻⁴, 6¹⁻¹⁸, 7¹⁻²⁰, 8¹⁻¹⁰, 9¹⁻⁹, 10¹⁻¹¹, 11¹⁻¹¹, 12¹⁻¹⁰, 13¹⁻⁹, 14¹⁻⁸, 15¹⁻⁶, 16¹⁻⁸, 17¹⁻², 18¹⁻⁶, 19¹⁻¹¹, 20¹⁻⁶.
- Sanitary engineer**. See Engineering record.
- Sarawak** museum, Sarawak. *Journal*. ACAD. 1¹. *Report*. ACAD. '10.
- School of mines** quarterly. I.U. 12+.
- School science and mathematics**. N.D. 5+: S.N. 1-3, 8+: P. 1+: E. 9+: I.U. 1+.

- Schweizerische** botanische gesellschaft, Bern, Switzerland. *Berichte*. ACAD. 14-19.
- Schweizerische** naturforschende Gesellschaft, Basel, Switzerland. *Verhandlungen*. ACAD. 75, 77, 79-81, 83, 84, 87-89, 91, 93.
- Science**, New York. W. 5-24, n.s. 7-13, 19+: D. 1-22, n.s. 1+: R.P. complete: S.N. o.s. complete; n.s. 3+: P. 1+: E. o.s. 8, 9; n.s. 8, 9, 13+: I.U. o.s. complete, n.s. 1+.
- Science** abstracts. Sec. A. physics. W. 10+: R.P. 4+. Sec. B. electrical engineering. R.P. 4+: P. 1+: I.U. 1+.
- Science** News. P. 1.
- Scientific** american, New York. W. 1-31, 41-45, 48+: D. 1-25, 50+: R.P. 1+: S.N. 86+: F. 70-93, 96+: P. 34-43, 76+: E. 6-8, 11-14, 16-21, 23-26, 30, 31, 36-74: I.U. 44-45, 47-60, 63, 65, 90+.
- Scientific** american, building edition, New York (continued as American homes and gardens *q.v.*). R.P. 25-39.
- Scientific** american supplement, New York. W. 15-23, 35-54, 56, 58+: D. 1+: R.P. 13-20, 49+: S.N. 31+: F. 59-62, 71+: P. 1-4, 9-24, 29+: I.U. 1-27, 29-30, 32, 57.
- Scottish** geographical magazine. S.N. 1+.
- Secretaria** de fomento, colonizacion e industria de la Republica Mexicana, Mexico City. *Boletín del instituto geológico*. ACAD. 10-15.
- Siderial** messenger. D. 5-10: W. 1-10: I.U. 1-10.
- Smithsonian** institution, Washington, D. C. *Contributions to knowledge*. D. 1+: P. 6, 10, 20-32, 34+. *Miscellaneous collections*. D. 1-30, 32-38, 40-42, 43, 46-57*: P. 1-2, 4, 5, 8, 9, 11-27, 29, 32-41, 44+. *Report*. D. '53-'96, '98-'00, '02-'04, '07-'09: P. '53, '54, '56+.
- Smithsonian** institution, United States national museum, Washington, D. C. *Contributions from the U. S. national herbarium*. D. 10-15*: P. 1+. *Bulletin*. D. 6-8, 10, 12, 16, 29, 33-51, 53-61, 63-69, 71-76: P. 1-16, 20, 21, 24, 26, 33-38, 40-48, 50+. *Proceedings*. D. 10-22, 24-28, 32, 34-40: P. 1+. *Report*. P. '84+: B. '04.
- Sociedad** científica "Antonio Alzate," Mexico City, Mexico. *Memorias*. ACAD. 9⁹, 10, 10⁵⁻¹², 11, 12, 13¹⁻¹⁰, 14³⁻¹², 15, 16-18, 19⁶⁻¹², 20⁵⁻¹², 21-28, 29¹⁻⁶.
- Sociedad** científica argentina. Buenos Aires, Argentine Republic. *Anales*. ACAD. 45^{5, 6}, 46-72.
- Sociedad** de geografia y estadistica de la Republica Mexicana, Mexico City. *Boletín*. ACAD. 1¹⁻¹², 2¹⁻⁵.
- Sociedad** scientifica, Sao Paulo, Brazil. *Revista*. ACAD. 1¹⁻⁴, 2¹⁻⁸, 5¹⁻⁸.

- Societa** africana d'Italia, Naples, Italy. *Bullettino*. ACAD. 13-30*.
- Societa** entomologica italiana, Florence, Italy. *Bullettino*. ACAD. 34-41.
- Societa** italiana di scienze naturali e del museo civico di storia naturale, Milan, Italy. *Atti*. ACAD. 40-46, 47^{3,4}, 48^{1,2,4}, 49¹⁻⁴, 50¹.
- Societas** royale de botanique de Belgique. *Bullettino*. N.D. '09+.
- Société** belge de géologie de paléontologie et d'hydrologie, Brussels, Belgium. *Proces verbaux*. ACAD. 10-25*.
- Société** botanique, Geneva, Switzerland. *Bulletin*. ACAD. 8-9.
- Société** des sciences naturelles de L'ouest de la France, Nantes, France. *Bulletin*. ACAD. 7-10; II. 1-3, 4^{3,4}, 5-10.
- Société** entomologique de Belgique, Brussels, Belgium. *Comptereendu*. ACAD. 54-67.
- Société** entomologique de France, Paris. *Bulletin*. ACAD. '97+*.
- Société** géologique de Belgique, Liège, Belgium. *Memoires*. ACAD. 25¹⁻³, 26²⁻⁴, 27¹⁻⁴, 28¹⁻³, 29-38.
- Société** Helvétique des sciences naturelles, Geneva, Switzerland. *Comptereendu*. ACAD. '99-'07.
- Société** Helvétique des sciences naturelles, Lausanne, Switzerland. *Actes*. ACAD. '93, '95, '99, '02, '07, '09.
- Société** Hollandaise des sciences, La Hague, Holland. *Archives*. ACAD. 30^{4,5}; II. 1^{1,4,5}, 2-4, 6, 7¹⁻³, 8^{1,2,5}, 9-15; III. A. 1; III. B. 1.
- Société** impériale des naturalistes, Moscow, Russia. *Bulletins*. ACAD. 61-62; n.s. 1-10, 11^{1,2}, 13^{2,3}, 14, 15, 16^{3,4}, 17, 18²⁻⁴, 19-24. *Memoirs*. ACAD. 15⁶ 16^{3,4}, 17^{1,2}. *Beilage*. ACAD. '87.
- Société** mathématique de France, Paris. *Bulletin*. D. 1-20: I.U. 1+.
- Société** royale de botanique de Belgique, Brussels, Belgium. *Bulletin*. ACAD. 36-43, 45¹⁻³, 46^{1,2;4,5}, 47¹⁻⁴.
- Société** royale malacologique de Belgique, Brussels, Belgium. *Annales*. ACAD. 41-45. *Proces verbaux*. ACAD. 11-24*. *Bulletin*. ACAD. '00-'01.
- Society** of American foresters. *Proceedings*. P. 1+*.
- Society** of chemical industry. *Journal*. R.P. 23+: P. 1+: I.U. 1+.
- Society** of naval architects and engineers. *Transactions*. R.P. 1-15.
- Society** for psychical research. *Proceedings*. S.N. 1+: I.U. 1+.
- Society** of telegraph engineers. *Journal*. R.P. 1-14.
- South African philosophical society**, Cape Town, South Africa. *Transactions*. ACAD. 9², 10^{2,3}, 11¹⁻⁴, 12, 15¹⁻⁴, 16¹⁻⁴.
- South Dakota geological survey**. *Bulletin*. P. 4.
- South Dakota school of mines, department of geology**. *Bulletin*. P. 6, 9.

- Southern California academy of science**, Los Angeles. *Bulletin*. ACAD. 1¹⁻².
- Sveriges geologiska undersökning**, Stockholm, Sweden. *Afhandlingar och uppsatser*. ACAD. ser. C. 92-111, 113-134, 195, 196, 201-203; ser. Ca. 4, 5, 7. *Arsbok*. ACAD. '07-'09.
- Tacoma academy of sciences**, Tacoma, Washington. *Proceedings*. ACAD. '93.
- Technology review**. I.U. 1+.
- Tennessee geological survey**. P. '69. *Resources of Tennessee*. P. 1+.
- Terrestrial magnetism and atmospheric electricity**. I.U. 1+.
- Tennessee university**. *Record*. P. 10, 11, 15, 4-10.
- Texas academy of science**, Austin, Texas. *Transactions*. ACAD. 1¹⁻⁵, 2^{1,2}, 3, 4 pt. 2¹⁻⁹, 7, 9-11.
- Therapeutic notes**. I.U. 10+.
- Texas university**. *Bulletin*. P. 46, 51, 135, 165, 178, 189. *Mineral survey*. P. 3, 4, 7-9. *Record*. P. 2-4*.
- Toronto university**. *Studies*. P. anatomical ser. 1; geol. ser. 1, 2; biol. ser. 1-3; physiol. ser. 1-3; psychol. ser. 1, 2.
- Torrey botanical club**, New York. *Memoirs*. D. 1, 2, 4-11. *Bulletin*. N.D. 17, 18, 20, 23, 27, 37+: W. 19+: D. 19+: I.U. 18+: ACAD. 12-25. *Torreyana*. N.D. 9+: D. 1+.
- Trenton natural history society**, Trenton, N. J. *Journal*. ACAD. 1¹⁻³, 2¹.
- Tufts college**, Mass. *Studies*. P. scientific ser. 1+*: ACAD. 1^{2,4,6,8}, 2^{2,3}, 3¹.
- Universidad de Buenos Aires**. *Anales*. P. 1-3, 6-15.
- United States census bureau**, forest products. P. '07+.
- United States bureau of fish and fisheries**. *Bulletin*. P. 1+. *Documents*. P. 603+*. *Report*. P. '71-'77, '79-'88, '94+.
- United States forestry service**. *Bulletin*. P. 2, 4-10, 12-21, 24+*. *Circulars*. P. 11-13, 15+*. *Silvical leaflets*. P. 1+.
- United States geological survey**. *Annual report*. P. 2+. *Bulletin*. P. 1+. *Mineral resources*. P. '67, '68, '70, '73, '74, '76, '82-'93, '96, '97, '00+. *Monographs*. P. 1+. *Professional papers*. P. 1+. *Water supply and irrigation papers*. P. 1+.
- United States national board of health**. *Report*. P. '79, '80, '83.
- United States national museum**. See Smithsonian institution.
- United States naval medical bulletin**. P. 1*, 2+: I.U. 1+.
- United States patent office**. *Official gazette*. P. 1+*.
- United States public health and marine hospital service**. *Annual report*. P. '94+. *Hygienic laboratory bulletin*. P. 1+. *Public health reports*. P. 14+. *Transactions of annual conference of health officers*. P. 1+. *Yellow fever institute bulletin*. P. 1+.

- United States** bureau of standards. *Bulletin*. P. 1+. *Circulars*. P. 1+. *Annual conferences*. P. 1+.
- Universidad de Chile**. *Anales*. P. 82+*.
- Universita di Napoli**. *Bulletino dell orto botanico*. N.D. '03+.
- Universite catholique de Lyon**. N.D. n.s. 6-9.
- University de Rennes Travaux Scientific**. I.U. 1+.
- University of Iowa**. *Bulletin of the laboratories of natural history*. N.D. '99+.
- University of Pennsylvania, Philadelphia**. *Contributions from the botanical laboratory*. N.D. complete. *Contributions from the zoölogical laboratory*. I.U. 1+.
- University of California, Berkeley, California**. *Bulletin of the department of geology*. ACAD. 1^{8-11, 14}; I.U. 1+. *Publications of the department of physiology*. I.U. 1+.
- University of New Mexico, Albuquerque, N. M.** *Bulletins*. ACAD. biol. ser. 3^{12, 13}, 4¹; catalogue ser. 16-18, 20; educational ser. 1^{3, 4}; geol. ser. 3¹; language ser. 1^{1, 2}.
- University of Texas, Austin**. *Bulletins*. ACAD. medical ser. 2, 3; reprint ser. 2; scientific ser. 4, 6, 8, 10-17; official ser. 39.
- University of Toronto, Toronto, Canada**. *Studies*. ACAD. biol. ser. 4-9; geol. ser. 3-7; chem. ser. 40-52, 54-72, 74-93; physics ser. 18-36; psychol. ser. 2^{2, 4}, 3¹; physical science ser. 1-4; pathol. ser. 1; physiol. ser. 4-7.
- University of Upsala, Upsala, Sweden**. *Bulletin*. ACAD. 1-10*.
- University of Virginia, Charlottesville, Va.** *Bulletin of philosophical society*. ACAD. 1¹.
- Upper Iowa university**. *Contributions from the biology laboratory*. P. 1-3.
- Unterrichtsblaetter für Mathematik und Naturwissenschaften**. I.U. 1+.
- Vanderbilt university**. *Quarterly*. P. 1-8.
- Van Nostrand's chemical annual**. P. 1+.
- Van Nostrand's engineering magazine**. R.P. 1-35.
- Verein für Erdkunde, Leipzig, Germany**. *Wissenschaftliche veröffentlichungen*. ACAD. 3-7. *Mitteilungen*. ACAD. '84, '85, '94-'10.
- Verein für Naturwissenschaft, Braunschweig, Germany**. *Jahresbericht*. ACAD. '87-'09.
- Victoria institute of Trinidad, British West Indies**. *Proceedings*. ACAD. 1, 2, 4.
- Warren academy of science, Warren, Pa.** *Reports and papers*. ACAD. '07-'08. *Transactions*. ACAD. 1^{1 2}.
- Washburn college, laboratory of natural history, Topeka, Kan.** *Bulletin*. ACAD. 1¹⁻⁷, 2^{8, 9, 11}.

- Washington academy of science, Washington, D. C. *Journal*. P. 1+. *Proceedings*. R.P. 1+: S.N. 1+: P. 1+: ACAD. 1+.
- Washington university. *Record*. P. '09+. *Theses*. P. 7, 14.
- Washington university association. *Bulletin*. P. 1+.
- West American scientist, San Diego, Cal. ACAD. 1, 3-8, 10-15.
- Western druggist. P. 8+.
- Western electrician. R.P. 4+: I.U. 34+.
- Western society of engineers. *Journal*. R.P. 1+.
- West Virginia conservation commission. *Report*. P. 1+.
- Wisconsin academy of sciences, arts, and letters, Madison, Wis. *Transactions*. P. 3+: E. 3+: ACAD. 10-16.
- Wisconsin archeologist. I.U. 3+.
- Wisconsin geological and natural history survey. *Biennial reports*. P. 1-5. *Bulletin*. P. 2-17, 20+.
- Wisconsin natural history society, Milwaukee, Wis. *Bulletin*. ACAD. 1¹, 2, 2-9.
- Wisconsin forestry commission. *Report*. P. '06+.
- Wisconsin state conservation commission. *Report*. P. '10.
- Wisconsin state forester. *Report*. P. '06+.
- Wisconsin university. *Contributions from the department of pharmacy*. P. 1. *Bulletin*. P. science ser. 1+: E. science ser. 2; engineering ser. 2.
- Wyoming historical and geological society, Wilkes-Barre, Pa. *Proceedings and collections*. ACAD. 2¹, 2, 3.
- Yale University, New Haven, Conn. *Studies from the psychological laboratory*. S.N. 1-10: I.U. 1+.
- Zeitschrift für Aertzliche Fortbildung. I.U. 1+.
- Zeitschrift für analytische Chemie. W. 32-40: D. 32: R.P. 31+: I.U. 1+.
- Zeitschrift für angewandte Chemie. I.U. 1+.
- Zeitschrift für angewandte Psychologie. I.U. 1+.
- Zeitschrift für allgemeine Physiologie. I.U. 1+.
- Zeitschrift für anorganische Chemie. P. 1+.
- Zeitschrift für Biologie, München und Leipzig, Germany. D. 18.
- Zeitschrift für Botanik. I.U. 1+.
- Zeitschrift der Deutschen Geologischen-Gesellschaft. I.U. '04+.
- Zeitschrift für experimentelle Pathologie und Therapie. I.U. 3+.
- Zeitschrift für Instrumentenkunde. R.P. 5: P. 1+.
- Zeitschrift für Mathematik und Physik. I.U. 40-41.
- Zeitschrift für Mathematische und Naturwissenschaftlichen-unterricht. I.U. 41.

- Zeitschrift** für Morphologie und Anthropologie. I.U. 7+.
- Zeitschrift** für pädagogische Psychologie, Pathologie, und Hygiene. I.U. 3+.
- Zeitschrift** Physikalische Chemie. W. 1+: R.P. 47-56: P. 1. I.U. 1+.
- Zeitschrift** für physikalische und chemische Unterricht. R.P. 3-5.
- Zeitschrift** für physiologische Chemie. I.U. 1+.
- Zeitschrift** für Psychologie und Physiologie der Sinnesorgane. I.U. 1+.
- Zeitschrift** des Vereins deutscher Ingenieure. R.P. 43+.
- Zeitschrift** für wissenschaftliche Mikroskopie. Braunschweig. D. 1-10.
- Zeitschrift** für wissenschaftliche Mikroskopie. Braunschweig. D. 1-10: I.U. 21+.
- Zeitschrift** für wissenschaftliche Zoologie. W. 63-68: I.U. 47+.
- Zentralblatt.** See Centralblatt.
- Zoological** record, London, England. D. 1-24: I.U. 1+.
- Zoologischer** Anzeiger. Leipzig. D. 13-17: I.U. 1+.
- Zoologisches** Centralblatt. I.U. 1+.
- Zoologische** Station zu Neapel. *Mittheilungen.* I.U. 1+.



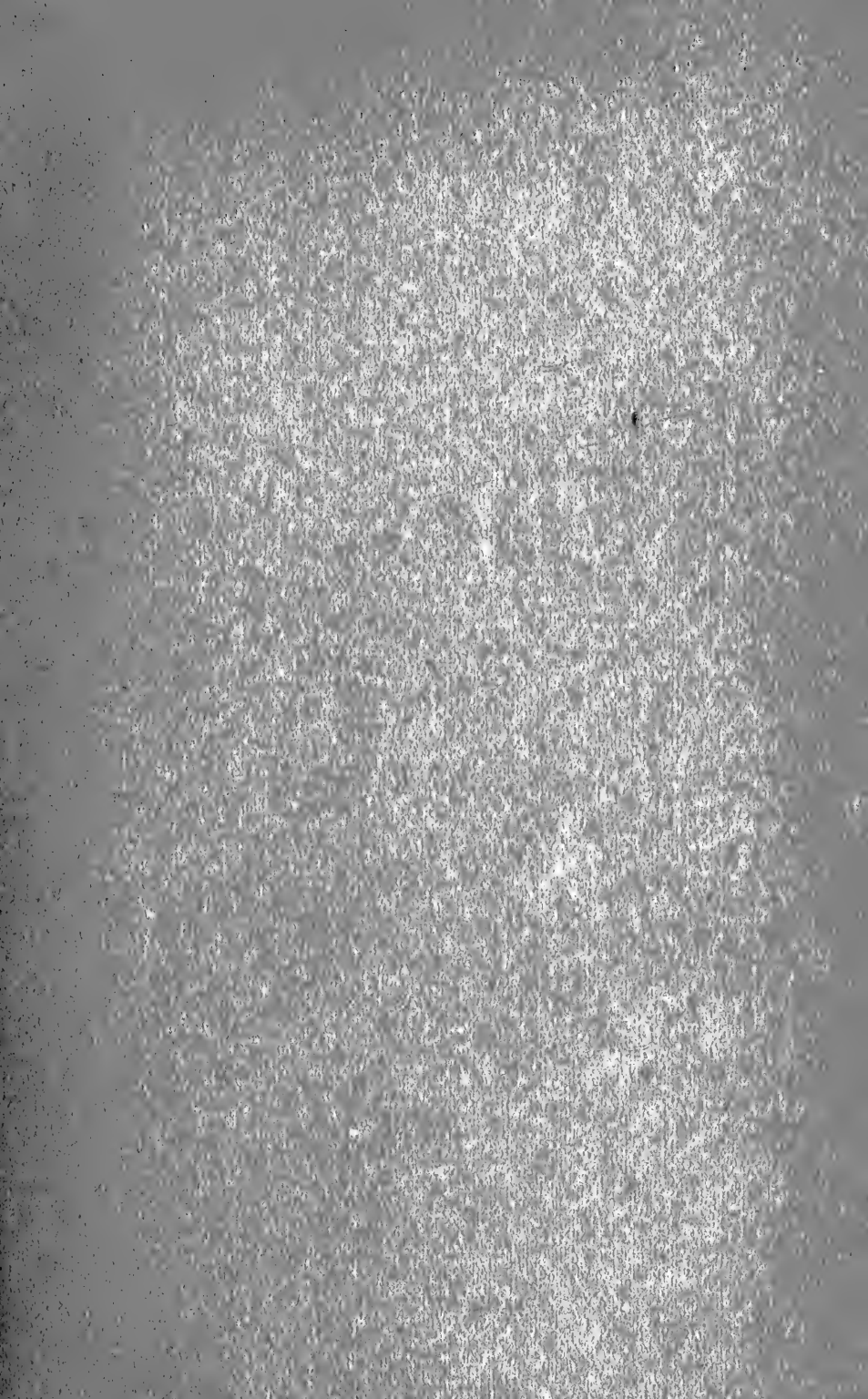

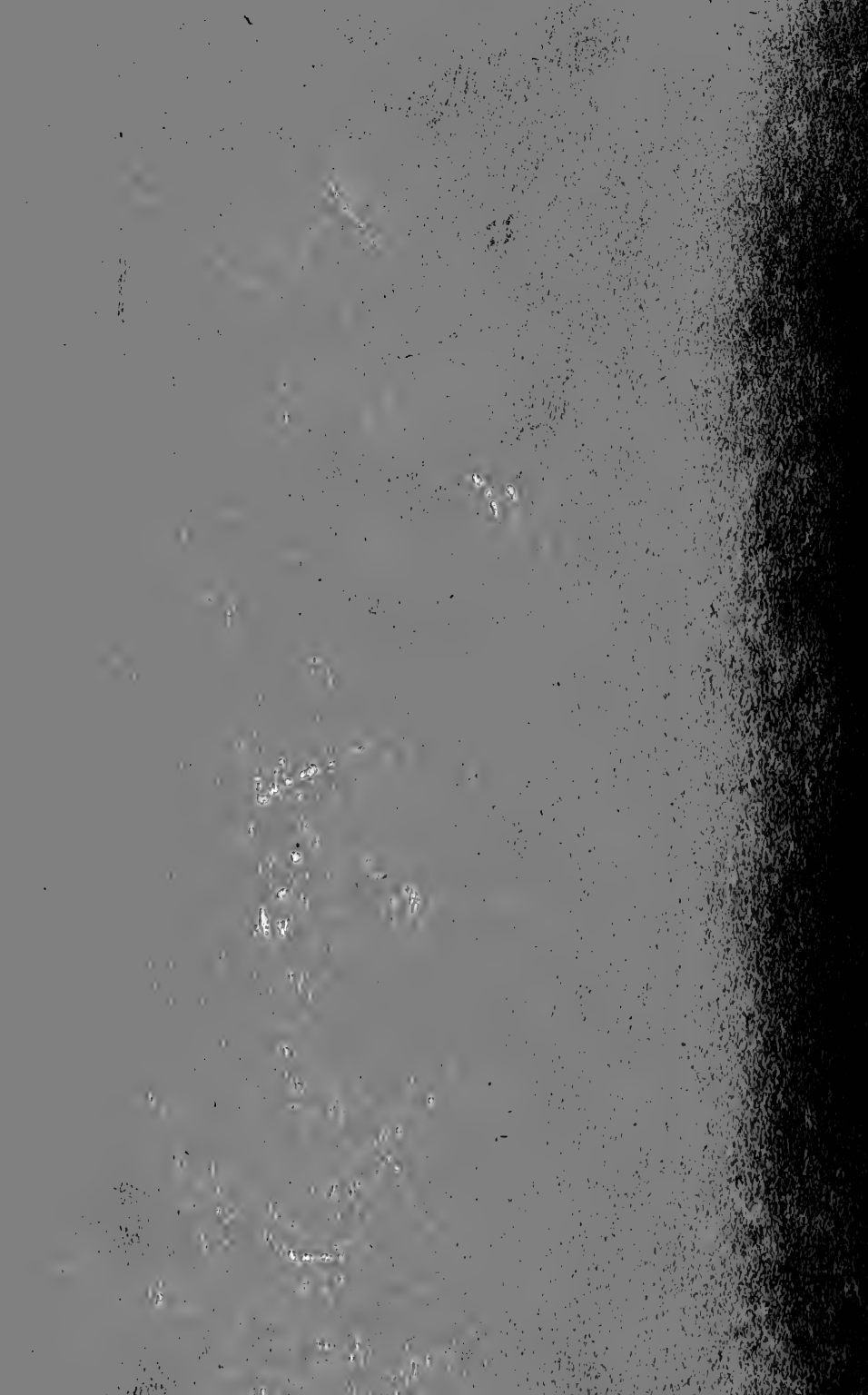

PROCEEDINGS

OF THE

**Indiana Academy
of Science**



1912



PROCEEDINGS

OF THE

Indiana Academy of Science

1912

CHAS. C. DEAM, Editor

INDIANAPOLIS :

WM. B. BURFORD, CONTRACTOR FOR STATE PRINTING AND BINDING

1913

TABLE OF CONTENTS.

	PAGE.
Constitution of the Indiana Academy of Science.....	5
By-laws of the Academy.....	7
An Act to provide for the publication of the proceedings and papers of the Indiana Academy of Science.....	7
An act for the protection of birds, their nests and eggs.....	9
An act to protect migratory birds.....	10
Officers of the Indiana Academy of Science for 1912-1913.....	11
Members.....	14
Minutes of the Twenty-eighth Annual Meeting.....	33
Program of the Twenty-eighth Annual Meeting.....	39
The water supply of Indiana, by H. E. Barnard.....	43
The protection of our rivers from pollution, by Jay Craven.....	47
Coniology, an abstract, by Robert Hessler.....	51
Birds that destroy grapes, by Amos W. Butler.....	53
A heronry near Indianapolis, by Amos W. Butler.....	57
Further notes on Indiana birds, by Amos W. Butler.....	59
Further notes of the seedless fruits of the common persimmon— <i>Diospyros</i> <i>virginiana</i> L., by David M. Mottier.....	67
The mosses of Monroe County, by F. L. Pickett and Mildred Nothnag ..	69
Length of life of <i>Arisaema triphyllum</i> corms, by F. L. Pickett.....	77
Acetic alcohol as a killing and fixing agent in plant histology, by F. L. Pickett.....	79
Plants not hitherto reported from Indiana, by Chas. C. Deam.....	81
The influence of certain environic factors on the development of fern pro- thalia, by David M. Mottier.....	85
Report of the work in corn pollination—IV, by M. L. Fisher.....	87
Conjugation in <i>Spirogyra</i> , by F. M. Andrews.....	89
An instructive modification of an old experiment, by Howard J. Banker..	93
Photosynthesis in submerged land plants by H. V. Heimberger.....	95
Indiana fungi—III, by J. M. Van Hook.....	99
Fungous enemies of the sweet potato in Indiana, by C. A. Ludwig.....	103
Notes on some puff balls of Indiana, by Frank D. Kern.....	105

DEC 20 1912

	PAGE.
The improvement of medicinal plants, by F. A. Miller.....	115
The structure and diagnostic value of the starch grain, by R. B. Harvey..	121
Butter fat and butter fat constants, by George Spitzer.....	127
Nascent state of the elements, by J. H. Ransom and R. A. Stevens.....	139
The penetration of wood, by Zinc chloride, by Edward G. Mahin.....	149
A biometric study of the Streptococci from milk and from the human throat, by C. M. Hilliard.....	155
On the atomic structure of energy, by A. E. Caswell.....	157
Notes on the system of crystallization and proper cutting of the synthetic corundum gems, by Frank B. Wade.....	169
On linear difference equations of the first order with rational coefficients, by Thomas E. Mason.....	181
A note on the intersection of osculating planes to the twisted cubic curve, by A. M. Kenyon.....	189
Wabash studies, by Charles R. Dryer.....	199
I. Terraces of the Wabash Valley in Parke, Vermillion and Vigo counties.....	199
II The Raccoon Valley, Parke County, Indiana.....	206
III A natural bridge in Parke County, Indiana.....	212
The determination of hydrogen, nitrogen and methane in gas by combus- tion in a quartz tube, by Frank C. Mathers and Ira Lee.....	215
New methods for the preparation of salts of selenic acid, by Frank C. Mathers and J. Otto Frank.....	221
A new method for the qualitative detection of chlorides in the presence of bromides and iodides, by Frank C. Mathers and Ira E. Lee.....	225

CONSTITUTION.

ARTICLE I.

SECTION 1. This association shall be called the Indiana Academy of Science.

SEC. 2. The objects of this Academy shall be scientific research and the diffusion of knowledge concerning the various departments of science; to promote intercourse between men engaged in scientific work, specially in Indiana; to assist by investigation and discussion in developing and making known the material, educational and other resources and riches of the State; to arrange and prepare for publication such reports of investigation and discussions as may further the aims and objects of the Academy as set forth in these articles.

WHEREAS, The State has undertaken the publication of such proceedings, the Academy will, upon request of the Governor, or of one of the several departments of the State, through the Governor, act through its council as an advisory body in the direction and execution of any investigation within its province as stated. The necessary expenses incurred in the prosecution of such investigation are to be borne by the State; no pecuniary gain is to come to the Academy for its advice or direction of such investigation.

The regular proceedings of the Academy as published by the State shall become a public document.

ARTICLE II.

SECTION 1. Members of this Academy shall be honorary fellows, fellows, non-resident members or active members.

SEC. 2. Any person engaged in any department of scientific work, or in original research in any department of science, shall be eligible to active membership. Active members may be annual or life members. Annual members may be elected at any meeting of the Academy; they shall sign the constitution, pay an admission fee of two dollars and thereafter an annual fee of one dollar. Any person who shall at one time contribute fifty dollars to the funds of this Academy may be elected a life member of the Academy, free of assessment. Non-resident members may be elected

from those who have been active members but who have removed from the State. In any case, a three-fourths vote of the members present shall elect to membership. Applications for membership in any of the foregoing classes shall be referred to a committee on application for membership, who shall consider such application and report to the Academy before the election.

SEC 3. The members who are actively engaged in scientific work, who have recognized standing as scientific men, and who have been members of the Academy at least one year, may be recommended for nomination for election as fellows by three fellows or members personally acquainted with their work and character. Of members so nominated a number not exceeding five in one year may, on recommendation of the Executive Committee, be elected as fellows. At the meeting at which this is adopted, the members of the Executive Committee for 1894 and fifteen others shall be elected fellows, and those now honorary members shall become honorary fellows. Honorary fellows may be elected on account of special prominence in science, on the written recommendation of two members of the Academy. In any case a three-fourths vote of the members present shall elect.

ARTICLE III.

SECTION 1. The officers of this Academy shall be chosen by ballot at the annual meeting, and shall hold office one year. They shall consist of a President, Vice-President, Secretary, Assistant Secretary, Press Secretary and Treasurer, who shall perform the duties usually pertaining to their respective offices and in addition, with the ex-presidents of the Academy, shall constitute an Executive Committee. The President shall, at each annual meeting, appoint two members to be a committee, which shall prepare the programs and have charge of the arrangements for all meetings for one year.

SEC. 2. The annual meeting of this Academy shall be held in the city of Indianapolis within the week following Christmas of each year, unless otherwise ordered by the Executive Committee. There shall also be a summer meeting at such time and place as may be decided upon by the Executive Committee. Other meetings may be called at the discretion of the Executive Committee. The Past Presidents, together with the officers and Executive Committee, shall constitute the council of the Academy, and represent it in the transaction of any necessary business not especially provided for in this constitution, in the interim between general meetings.

SEC. 3. This constitution may be altered or amended at any annual meeting by a three-fourths majority of the attending members of at least one year's standing. No question of amendment shall be decided on the day of its presentation.

BY-LAWS.

1. On motion, any special department of science shall be assigned to a curator, whose duty it shall be, with the assistance of the other members interested in the same department, to endeavor to advance knowledge in that particular department. Each curator shall report at such time and place as the Academy shall direct. These reports shall include a brief summary of the progress of the department during the year preceding the presentation of the report.

2. The President shall deliver a public address on the morning of one of the days of the meeting at the expiration of his term of office.

3. The Press Secretary shall attend to the securing of proper newspaper reports of the meetings and assist the Secretary.

4. No special meeting of the Academy shall be held without a notice of the same having been sent to the address of each member at least fifteen days before such meeting.

5. No bill against the Academy shall be paid without an order signed by the President and countersigned by the Secretary.

6. Members who shall allow their dues to remain unpaid for two years, having been annually notified of their arrearage by the Treasurer, shall have their names stricken from the roll.

7. Ten members shall constitute a quorum for the transaction of business.

AN ACT TO PROVIDE FOR THE PUBLICATION OF THE REPORTS AND PAPERS OF THE INDIANA ACADEMY OF SCIENCE.

[Approved March 11, 1895.]

WHEREAS, The Indiana Academy of Science, a chartered scientific association, has embodied in its constitution a provision that it will, upon the request of the Governor, or of the several departments of the State

government, through the Governor, and through its council as an advisory board, assist in the direction and execution of any investigation within its province, without pecuniary gain to the Academy, provided only that the necessary expenses of such investigation are borne by the State; and,

WHEREAS, The reports of the meetings of said Academy, with the several papers read before it, have very great educational, industrial and economic value, and should be preserved in permanent form; and,

WHEREAS, The Constitution of the State makes it the duty of the General Assembly to encourage by all suitable means intellectual, scientific and agricultural improvement; therefore,

SECTION 1. *Be it enacted by the General Assembly of the State of Indiana,* That hereafter the annual reports of the meetings of the Indiana Academy of Science, beginning with the report for the year 1894, including all papers of scientific or economic value, presented at such meetings, after they shall have been edited and prepared for publication as hereinafter provided, shall be published by and under the direction of the Commissioners of Public Printing and Binding.

SEC. 2. Said reports shall be edited and prepared for publication without expense to the State, by a corps of editors to be selected and appointed by the Indiana Academy of Science, who shall not, by reason of such service, have any claim against the State for compensation. The form, style of binding, paper, typography and manner and extent of illustration of such reports shall be determined by the editors, subject to the approval of the Commissioners of Public Printing and Stationery. Not less than 1,500 nor more than 3,000 copies of each of said reports shall be published, the size of the edition within said limits to be determined by the concurrent action of the editors and the Commissioners of Public Printing and Stationery: *Provided,* That not to exceed six hundred dollars (\$600) shall be expended for such publication in any one year, and not to extend beyond 1896: *Provided,* That no sums shall be deemed to be appropriated for the year 1894.

SEC. 3. All except three hundred copies of each volume of said reports shall be placed in the custody of the State Librarian, who shall furnish one copy thereof to each public library in the State, one copy to each university, college or normal school in the State, one copy to each high school in the State having a library, which shall make application therefor, and one copy to such other institutions, societies or persons as

may be designated by the Academy through its editors or its council. The remaining three hundred copies shall be turned over to the Academy to be disposed of as it may determine. In order to provide for the preservation of the same it shall be the duty of the Custodian of the State House to provide and place at the disposal of the Academy one of the unoccupied rooms of the State House, to be designated as the office of the Academy of Science, wherein said copies of said reports belonging to the Academy, together with the original manuscripts, drawings, etc., thereof can be safely kept, and he shall also equip the same with the necessary shelving and furniture.

SEC. 4. An emergency is hereby declared to exist for the immediate taking effect of this act, and it shall therefore take effect and be in force from and after its passage.

APPROPRIATION FOR 1912-1913.

The appropriation for the publication of the proceedings of the Academy during the years 1913 and 1914 was increased by the Legislature in the General Appropriation bill, approved March 9, 1909. That portion of the law fixing the amount of the appropriation for the Academy is herewith given in full:

For the Academy of Science: For the printing of the proceedings of the Indiana Academy of Science, twelve hundred dollars: *Provided*, That any unexpended balance in 1913 shall be available in 1914, and that any unexpended balance in 1914 shall be available for 1915.

AN ACT FOR THE PROTECTION OF BIRDS, THEIR NESTS AND EGGS.

SEC. 602. Whoever kills, traps or has in his possession any wild bird, or whoever sells or offers the same for sale, or whoever destroys the nest or eggs of any wild bird, shall be deemed guilty of a misdemeanor and upon conviction thereof shall be fined not less than ten dollars nor more than twenty-five dollars: *Provided*, That the provisions of this section shall not apply to the following named game birds: The Anatidæ, commonly called swans, geese, brant, river and sea duck; the Rallidæ, commonly called rails, coots, mud-hens, gallinules; the Limicolæ, commonly called shore birds, surf birds, plover, snipe, woodcock, sandpipers, tattlers and curlew; the Gallinæ, commonly called wild turkeys, grouse, prairie chickens, quails and pheasants; nor to English or European house spar-

rows, crows, hawks or other birds of prey. Nor shall this section apply to persons taking birds, their nests or eggs, for scientific purposes, under permit, as provided in the next section.

SEC. 603. Permits may be granted by the Commissioner of Fisheries and Game to any properly accredited person, permitting the holder thereof to collect birds, their nests or eggs for strictly scientific purposes. In order to obtain such permit the applicant for the same must present to such Commissioner written testimonials from two well-known scientific men certifying to the good character and fitness of such applicant to be entrusted with such privilege, and pay to such Commissioner one dollar therefor and file with him a properly executed bond in the sum of two hundred dollars, payable to the State of Indiana, conditioned that he will obey the terms of such permit, and signed by at least two responsible citizens of the State as sureties. The bond may be forfeited, and the permit revoked upon proof to the satisfaction of such Commissioner that the holder of such permit has killed any bird or taken the nest or eggs of any bird for any other purpose than that named in this section.

PUBLIC OFFENSES—HUNTING WILD BIRDS—PENALTY.

[Approved March 13, 1913.]

SECTION 1. *Be it enacted by the General Assembly of the State of Indiana,* That section six (6) of the above entitled act be amended to read as follows: Section 6. That section six hundred two (602) of the above entitled act be amended to read as follows: Section 602. It shall be unlawful for any person to kill, trap or possess any wild bird, or to purchase or offer the same for sale, or to destroy the nest or eggs of any wild bird, except as otherwise provided in this section. But this section shall not apply to the following named game birds: The Anatidae, commonly called swans, geese, brant, river and sea duck; the Rallidae, commonly known as rails, coots, mud-hens and gallinules; the Limicolæ, commonly known as shore birds, plovers, surf birds, snipe, woodcock, sandpipers, fattlers and curlews; the Galline, commonly called wild turkeys, grouse, prairie chickens, quails, and pheasants; nor to English or European house sparrows, blackbirds, crows, hawks or other birds of prey. Nor shall this section apply to any person taking birds or their nests or eggs for scientific purposes under permit as provided in the next section. Any person violating the provisions of this section shall, on conviction, be fined not less than ten dollars (\$10.00) nor more than fifty dollars (\$50.00).

Indiana Academy of Science.

OFFICERS, 1912-1913

PRESIDENT,

DONALDSON BODINE.

VICE-PRESIDENT,

SEVERANCE BURRAGE.

SECRETARY.

ANDREW J. PIGNEY.

ASSISTANT SECRETARY,

CHARLES M. SMITH.

PRESS SECRETARY,

FRANK B. WADE.

TREASURER,

W. J. MOENKHAUS.

EDITOR,

CHAS. C. DEAM.

EXECUTIVE COMMITTEE:

ARTHUR, J. C.,	EIGENMANN, C. H.,	MOTTIER, DAVID M.,
BIGNEY, A. J.,	EVANS, P. N.,	MENDENHALL, T. C.,
BLATCHLEY, W. S.,	DENNIS, D. W.,	NAYLOR, JOSEPH P.,
BODINE, DONALDSON,	FOLEY, A. L.,	NOYES, W. A.,
BRANNER, J. C.,	HAY, O. P.,	STUART, MILO H.,
BUTLER, AMOS W.,	HESSLER, ROBERT,	WALDO, C. A.,
COULTER, JOHN M.,	JOHN, J. P. D.,	WILEY, H. W.,
COULTER, STANLEY,	JORDAN, D. S.,	WILLIAMSON, E. B.,
CULBERTSON, GLENN,	MEES, CARL L.,	WRIGHT, JOHN S.,
DRYER, CHAS. R.,	MOENKHAUS, W. J.,	

CURATORS:

BOTANY.....	J. C. ARTHUR.
ENTOMOLOGY.....	W. S. BLATCHLEY.
HERPETOLOGY }.....	
MAMMALOGY }.....	A. W. BUTLER.
ORNITHOLOGY }.....	
ICHTHYOLOGY.....	H. C. EIGENMANN.

COMMITTEES, 1912-1913

PROGRAM,

J. W. BEEDE,	J. S. WRIGHT,	D. M. MOTTIER.
--------------	---------------	----------------

MEMBERSHIP,

E. R. CUMINGS,	E. S. JOHNNOTT,	F. B. WADE.
----------------	-----------------	-------------

NOMINATIONS,

R. R. RAMSEY,	P. N. EVANS,	H. J. BANKER.
---------------	--------------	---------------

AUDITING,

L. J. RETTGER,		EDWIN MORRISON.
----------------	--	-----------------

STATE LIBRARY,

H. E. BARNARD,	W. S. BLATCHLEY,	A. W. BUTLER.
----------------	------------------	---------------

RESTRICTION OF WEEDS AND DISEASES.

R. HESSLER,	J. N. HURTY,	A. W. BUTLER,
STANLEY COULTER,		D. M. MOTTIER.

BIOLOGICAL SURVEY,

STANLEY COULTER,	J. C. ARTHUR,	J. M. VAN HOOK,
C. H. EIGENMANN,		U. O. COX.

ACADEMY TO STATE,

R. W. MCBRIDE,	G. CULBERTSON,	C. C. DEAM,
A. W. BUTLER,		W. W. WOOLLEN.

DISTRIBUTION OF PROCEEDINGS,

H. E. BARNARD,	H. L. BRUNER,	G. W. BENTON.
W. J. MOENKHAUS,		A. J. BIGNEY.

PUBLICATION OF PROCEEDINGS,

C. C. DEAM, Editor,	L. J. RETTGER,	C. R. DRYER.
---------------------	----------------	--------------

OFFICERS OF THE INDIANA ACADEMY OF SCIENCE.

YEARS.	PRESIDENT.	SECRETARY.	ASST. SECRETARY.	PRESS SECRETARY.	TREASURER.
1885-1886	David S. Jordan	Amos W. Butler	{ Stanley Coulter		O. P. Jenkins.
1886-1887	John M. Coulter	Amos W. Butler	{ W. W. Norman		O. P. Jenkins.
1887-1888	J. P. D. John	Amos W. Butler	W. W. Norman		O. P. Jenkins.
1888-1889	John C. Branner	Amos W. Butler	A. J. Bigney		O. P. Jenkins.
1889-1890	T. C. Mendenhall	Amos W. Butler	A. J. Bigney		O. P. Jenkins.
1890-1891	O. P. Hay	Amos W. Butler	A. J. Bigney		C. A. Waldo.
1891-1892	J. L. Campbell	Amos W. Butler	{ Stanley Coulter		C. A. Waldo.
1892-1893	J. C. Arthur	Amos W. Butler	{ W. W. Norman		C. A. Waldo.
1893-1894	W. A. Noyes	C. A. Waldo	W. W. Norman		W. P. Shannon.
1894-1895	A. W. Butler	John S. Wright	A. J. Bigney		W. P. Shannon.
1895-1896	Stanley Coulter	John S. Wright	A. J. Bigney		W. P. Shannon.
1896-1897	Thomas Gray	John S. Wright	A. J. Bigney		J. T. Scovell.
1897-1898	C. A. Waldo	John S. Wright	A. J. Bigney	Geo. W. Benton.	J. T. Scovell.
1898-1899	C. H. Eigenmann	John S. Wright	E. A. Schultze	Geo. W. Benton	J. T. Scovell.
1899-1900	D. W. Dennis	John S. Wright	E. A. Schultze	Geo. W. Benton	J. T. Scovell.
1900-1901	M. B. Thomas	John S. Wright	E. A. Schultze	Geo. W. Benton	J. T. Scovell.
1901-1902	Harvey W. Wiley	John S. Wright	Donaldson Bodine	Geo. W. Benton	W. A. McBeth.
1902-1903	W. S. Blatchley	John S. Wright	Donaldson Bodine	G. A. Abbott	W. A. McBeth.
1903-1904	C. L. Mees	John S. Wright	J. H. Ransom	G. A. Abbott	W. A. McBeth.
1904-1905	John S. Wright	Lynn B. McMullen	J. H. Ransom	G. A. Abbott	W. A. McBeth.
1905-1906	Robert Hessler	Lynn B. McMullen	J. H. Ransom	Charles R. Clark	W. A. McBeth.
1906-1907	D. M. Motier	Lynn B. McMullen	J. H. Ransom	G. A. Abbott	W. A. McBeth.
1907-1908	Gleam Culbertson	J. H. Ransom	A. J. Bigney	G. A. Abbott	W. A. McBeth.
1908-1909	A. L. Foley	J. H. Ransom	A. J. Bigney	G. A. Abbott	W. A. McBeth.
1909-1910	P. N. Evans	Geo. W. Benton	A. J. Bigney	John W. Woodhams	W. J. Moenkhaus.
1910-1911	C. R. Dryer	A. J. Bigney	E. B. Williamson	Milo H. Stuart	W. J. Moenkhaus.
1911-1912	J. P. Naylor	A. J. Bigney	E. B. Williamson	Milo H. Stuart	W. J. Moenkhaus.
1912-1913	Donaldson Bodine	A. J. Bigney	C. M. Smith	F. B. Wade	W. J. Moenkhaus.

MEMBERS*.

FELLOWS.

- ††Abbott, G. A., Grand Forks, N. Dak. †1908
 Professor of Chemistry, University of North Dakota.
 Chemistry.
- Aley, Robert J., Orono, Me. 1898
 President of University of Maine.
 Mathematics and General Science.
- Anderson, H. W., 1 Mills Place, Crawfordsville, Ind. 1912
 Professor of Botany, Wabash College.
 Botany.
- Andrews, F. M., 744 E. Third St., Bloomington, Ind. 1911
 Assistant Professor of Botany, Indiana University.
 Botany.
- Arthur, Joseph C., 915 Columbia St., Lafayette, Ind. 1894
 Professor of Vegetable Physiology and Pathology, Purdue University.
 Botany.
- Barnard, H. E., Room 26, State House, Indianapolis, Ind. 1910
 Chemist to Indiana State Board of Health.
 Chemistry, Sanitary Science, Pure Foods.
- Beede, Joshua W., cor. Wall and Atwater Sts., Bloomington, Ind. 1906
 Associate Professor of Geology, Indiana University.
 Stratigraphic Geology, Physiography.
- Benton, George W., 100 Washington Square, New York, N. Y. 1896
 With the American Book Company.

* Every effort has been made to obtain the correct address and occupation of each member, and to learn what line of science he is interested in. The first line contains the name and address; the second line the occupation; the third line the branch of science in which he is interested. The omission of an address indicates that mail addressed to the last printed address was returned as uncalled for. Information as to the present address of members so indicated is requested by the secretary. The custom of dividing the list of members has been followed.

† Date of election.

††Non-resident.

- Bigney, Andrew J., Moores Hill, Ind. 1897
 Vice-President and Professor of Biology and Geology, Moores Hill
 College.
 Biology and Geology.
- Bitting, Catharine Golden, West Lafayette, Ind. 1895
 Microscopic Expert, Pure Food, U. S. Department of Agriculture.
 Botany.
- Blatchley, W. S., 155S Park Ave., Indianapolis, Ind. 1893
 Naturalist.
 Botany, Entomology and Geology.
- Bodine, Donaldson, Four Mills Place, Crawfordsville, Ind. 1899
 Professor of Geology and Zoölogy, Wabash College.
 Entomology and Geology.
- Breeze, Fred J., care American Book Company, New York, N. Y. . . . 1910
 With the American Book Company.
 Geography.
- Bruner, Harry Lane, 324 S. Ritter Ave., Indianapolis, Ind. 1899
 Professor of Biology, Butler College.
 Comparative Anatomy, Zoölogy.
- Burrage, Severance, care Eli Lilly Co., Indianapolis, Ind. 1898
 Charge of Biological Laboratory, Eli Lilly Co.
 Bacteriology, Sanitary Science.
- Butler, Amos W., 52 Downey Ave., Irvington, Ind. 1893
 Secretary, Indiana Board of State Charities.
 Vertebrate Zoölogy, Anthropology, Sociology.
- Cogshall, Wilbur A., 423 S. Fess Ave., Bloomington, Ind. 1906
 Associate Professor of Astronomy, Indiana University.
 Astronomy and Physics.
- Cook, Mel T., New Brunswick, N. J. 1902
 Professor of Plant Pathology, Rutgers College.
 Botany, Plant Pathology, Entomology.
- Coulter, John M., care University of Chicago, Chicago, Ill. 1893
 Head Department of Botany, Chicago University.
 Botany.
- Coulter, Stanley, 213 S. Ninth St., Lafayette, Ind. 1893
 Dean School of Science, Purdue University.
 Botany, Forestry.

- Cox, Ulysses O., P. O. Box 81, Terre Haute, Ind. 1908
 Head Department Zoölogy and Botany, Indiana State Normal.
 Botany, Zoölogy.
- Culbertson, Glenn, Hanover, Ind. 1899
 Chair Geology, Physics and Astronomy, Hanover College.
 Geology.
- Cummings, Edgar Roscoe, 327 E. Second St., Bloomington, Ind. 1906
 Professor of Geology, Indiana University.
 Geology, Paleontology.
- Davisson, Schuyler Colfax, Bloomington, Ind. 1908
 Professor of Mathematics, Indiana University.
 Mathematics.
- Dean, Charles C., Bluffton, Ind. 1910
 Druggist.
 Botany.
- Dennis, David Worth, Richmond, Ind. 1895
 Professor of Biology, Earlham College.
 Biology.
- Dryer, Charles R., 35 Gilbert Ave., Terre Haute, Ind. 1897
 Professor of Geography and Geology, Indiana State Normal.
 Geography, Geology.
- Eigenmann, Carl H., 630 Atwater St., Bloomington, Ind. 1893
 Professor Zoölogy, Dean of Graduate School, Indiana University.
 Embryology, Degeneration, Heredity, Evolution and Distribution
 of American Fish.
- Enders, Howard Edwin, 105 Quincy St., Lafayette, Ind. 1912
 Associate Professor of Zoölogy, Purdue University.
 Zoölogy.
- Evans, Percy Norton, Lafayette, Ind. 1901
 Director of Chemical Laboratory, Purdue University.
 Chemistry.
- Foley, Arthur L., Bloomington, Ind. 1897
 Head Department of Physics, Indiana University.
 Physics.
- Golden, M. J., Lafayette, Ind. 1899
 Director of Laboratories of Practical Mechanics, Purdue Uni-
 versity.
 Mechanics.

- ††Goss, William Freeman M., Urbana, Ill. 1893
Dean of College of Engineering, University of Illinois.
- Hathaway, Arthur S., 2206 N. Tenth St., Terre Haute, Ind. 1895
Professor of Mathematics, Rose Polytechnic Institute.
Mathematics, Physics.
- Hessler, Robert, Logansport, Ind. 1899
Physician.
Biology.
- Hurty, J. N., Indianapolis, Ind. 1910
Secretary, Indiana State Board of Health.
Sanitary Science, Vital Statistics, Eugenics.
- †Huston, H. A., Baltimore, Md. 1893
- Kern, Frank D., State College, Pa. 1912
Professor of Botany, Pennsylvania State College.
Botany.
- Lyons, Robert E., 630 E. Third St., Bloomington, Ind. 1896
Head of Department of Chemistry, Indiana University.
Organic and Biological Chemistry.
- McBeth, William A., 1905 N. Eighth St., Terre Haute, Ind. 1904
Assistant Professor Geography, Indiana State Normal.
Geography, Geology, Scientific Agriculture.
- †Marsters, V. F., Santiago, Chile 1893
- Mees, C. L., Terre Haute, Ind. 1894
President of Rose Polytechnic Institute.
- †Miller, John Anthony, Swathmore, Pa. 1904
Professor of Mathematics and Astronomy, Swathmore College.
Astronomy, Mathematics.
- Moenkhaus, William J., 501 Fess Ave., Bloomington, Ind. 1901
Professor of Physiology, Indiana University.
Physiology.
- Moore, Richard B., Denver, Colo. 1893
With U. S. Bureau of Mines.
Chemistry, Radio-activity.
- Mottier, David M., 215 Forest Place, Bloomington, Ind. 1893
Professor of Botany, Indiana University.
Morphology, Cytology.

- Naylor, J. P., Greencastle, Ind. 1903
 Professor of Physics, Depauw University.
 Physics, Mathematics.
- †Noyes, William Albert, Urbana, Ill. 1893
 Director of Chemical Laboratory, University of Illinois.
 Chemistry.
- Pohlman, Augustus G., 1100 E. Second St., Bloomington, Ind. 1911
 Professor of Anatomy, Indiana University.
 Embryology, Comparative Anatomy.
- Ramsey, Rolla R., 615 E. Third St., Bloomington, Ind. 1906
 Associate Professor of Physics, Indiana University.
 Physics.
- Ransom, James H., 323 University St., West Lafayette, Ind. 1902
 Professor of General Chemistry, Purdue University.
 General Chemistry, Organic Chemistry, Teaching.
- Rettger, Louis J., 31 Gilbert Ave., Terre Haute, Ind. 1896
 Professor of Physiology, Indiana State Normal.
 Animal Physiology.
- Rothrock, David A., Bloomington, Ind. 1906
 Professor of Mathematics, Indiana University.
 Mathematics.
- Scott, Will, 731 Atwater St., Bloomington, Ind. 1911
 Assistant Professor of Zoölogy, Indiana University.
 Zoölogy, Lake Problems.
- Shannon, Charles W., Norman, Okla. 1912
 With Oklahoma State Geological Survey.
 Soil Survey, Botany.
- Smith, Albert, 1022 Seventh St., West Lafayette. 1908
 Professor of Structural Engineering.
 Physics, Mechanics.
- ††Smith, Alexander, care Columbia University, New York, N. Y. 1893
 Head of Department of Chemistry, Columbia University.
 Chemistry.
- Smith, Charles Marquis, 910 S. Ninth St., Lafayette, Ind. 1912
 Professor of Physics, Purdue University.
 Physics.

- Stone, Winthrop E., Lafayette, Ind. 1893
 President of Purdue University.
 Chemistry.
- ††Swain, Joseph, Swathmore, Pa. 1898
 President of Swathmore College.
 Science of Administration.
- Van Hook, James M., 639 N. College Ave., Bloomington, Ind. 1911
 Assistant Professor of Botany, Indiana University.
 Botany.
- ††Waldo, Clarence A., care Washington University, St. Louis, Mo. . . . 1893
 Thayer Professor Mathematics and Applied Mechanics, Wash-
 ington University.
 Mathematics, Mechanics, Geology and Mineralogy.
- ††Webster, F. M., Kensington, Md. 1894
 Entomologist, U. S. Department of Agriculture, Washington, D. C.
 Entomology.
- Westlund, Jacob, 439 Salisbury St., West Lafayette, Ind. 1904
 Professor of Mathematics, Purdue University.
 Mathematics.
- Wiley, Harvey W., Enos Club, Washington, D. C. 1895
 Professor of Agricultural Chemistry, George Washington Univer-
 sity.
 Biological and Agricultural Chemistry.
- Woollen, William Watson, Indianapolis, Ind. 1908
 Lawyer.
 Birds and Nature Study.
- Wright, John S., care Eli Lilly Co., Indianapolis, Ind. 1894
 Manager of Advertising Department, Eli Lilly Co.
 Botany.

NON-RESIDENT MEMBERS.

- Ashley, George H., Washington, D. C.
- Branner, John Casper, Stanford University, California.
 Vice-President of Stanford University, and Professor of Geology.
 Geology.

- Brannon, Melvin A., 207 Chestnut St., Grand Forks, N. D.
 Professor of Botany.
 Plant Breeding.
- Campbell, D. H., Stanford University, California.
 Professor of Botany, Stanford University.
 Botany.
- Clark, Howard Walton, U. S. Biological Station, Fairport, Iowa.
 Scientific Assistant, U. S. Bureau of Fisheries.
 Botany, Zoölogy.
- Dorner, H. B., Urbana, Illinois.
 Assistant Professor of Floriculture.
 Botany, Floriculture.
- Duff, A. Wilmer, 43 Harvard St., Worcester, Mass.
 Professor of Physics, Worcester Polytechnic Institute.
 Physics.
- Evermann, Barton Warren, Bureau of Fisheries, Washington, D. C.
 Chief, Alaska Fisheries Service.
 Zoölogy.
- Fiske, W. A.
- Garrett, Chas. W., Room 718, Pennsylvania Station, Pittsburgh, Pa.
 Librarian, Pennsylvania Lines West of Pittsburgh.
 Entomology, Sanitary Sciences.
- Gilbert, Charles H., Stanford University, California.
 Professor of Zoölogy, Stanford University.
 Ichthyology.
- Greene, Charles Wilson, 814 Virginia Ave., Columbia, Mo.
 Professor of Physiology and pharmacology, University of Missouri.
 Physiology, Zoölogy.
- Hargitt, Chas. W., 909 Walnut Ave., Syracuse, N. Y.
 Professor of Zoölogy, Syracuse University.
 Hygiene, Embryology, Eugenics, Animal Behavior.
- Hay, Oliver Perry, U. S. National Museum, Washington, D. C.
 Research Associate, Carnegie Institution of Washington.
 Vertebrate Paleontology, especially that of the Pleistocene Epoch
- Hughes, Edward, Stockton, California.

- Jenkins, Oliver P., Stanford University, California.
 Professor of Physiology, Stanford University.
 Physiology, Histology.
- Jordan, David Starr, Stanford University, California.
 President of Stanford University.
 Fish, Eugenics, Botany, Evolution.
- Kingsley, J. S., Tufts College, Massachusetts.
 Professor of Zoölogy, Tufts College.
 Zoölogy.
- Knipp, Charles T., 913 W. Nevada St., Urbana, Illinois.
 Assistant Professor of Physics, University of Illinois.
 Physics, Discharge of Electricity thru Gases.
- MacDougal, Daniel Trembly, Tucson, Arizona.
 Director, Department of Botanical Research, Carnegie Institute, Wash-
 ington, D. C.
 Botany.
- McMullen, Lynn Banks, State Normal School, Valley City, North Dakota.
 Head, Science Department, State Normal School.
 Physics, Chemistry.
- Mendenhall, Thomas Corwin, Ravenna, Ohio.
 Retired.
 Physics, "Engineering," Mathematics, Astronomy.
- Newsom, J. F., Palo Alto, California.
 Mining Engineer.
- Purdue, Albert Homer, State Geological Survey, Nashville, Tenn.
 State Geologist of Tennessee.
 Geology.
- Reagan, A. B., Nett Lake School, Nett Lake, Minnesota.
 Superintendent and Special Distribution Agent, Indian Service.
 Geology, Paleontology, Ethnology.
- Slonaker, James Rollin, 334 Kingsley Ave., Palo Alto, California.
 Assistant Professor of Physiology, Stanford University.
 Physiology, Zoölogy.
- Springer, Alfred, 312 East 2d St., Cincinnati, Ohio.
 Chemist.
 Chemistry.

- Walker, Ernest, 524 Leverett St., Fayetteville, Arkansas.
 Horticulturist, College of Agriculture, Arkansas University.
 Horticulture.
- Wilson, Guy W

ACTIVE MEMBERS.

- Allison, Evelyn, Lafayette, Ind.
 Care Agricultural Experiment Station.
 Botany.
- Baine, H. Foster, 420 Market St., San Francisco, Cal.
 Editor, Mining and Scientific Press.
- Baker, Walter D., N. Illinois St., Indianapolis, Ind.
 Care Walcraft Co.
 Chemistry.
- Baker, Walter M., Amboy.
 Superintendent of Schools.
 Mathematics and Physics.
- Banker, Howard J., 306 Hanna St., Greencastle.
 Professor of Biology, DePauw University.
 Botany.
- Bareus, H. H., Indianapolis.
 Instructor, Mathematics, Shortridge High School.
- Barr, Harry L., Waveland.
 Student.
 Botany and Forestry.
- Barrett, Edward, Indianapolis.
 State Geologist.
 Geology, Soil Survey.
- Bates, W. H., 306 Russell St., West Lafayette.
 Associate Professor, Mathematics.
- Bell, Guido, 431 E. Ohio St., Indianapolis.
 Physician.
- Bellamy, Ray, Worcester, Mass.
- Bennett, Lee F., 825 Laporte Ave., Valparaiso.
 Professor of Geology and Zoölogy, Valparaiso University.
 Geology, Zoölogy.

- Bishop, Harry Eldridge, 1706 College Ave., Indianapolis.
Food Chemist, Indiana State Board of Health.
- Blanchard, William M., 1008 S. College Ave., Greencastle.
Professor of Chemistry, DePauw University.
Organic Chemistry.
- Bond, Charles S., 112 N. Tenth St., Richmond.
Physician.
Biology, Bacteriology, Physical Diagnosis and Photomicrography.
- Bourke, A. Adolphus, 1103 Cottage Ave., Columbus.
Instructor, Physics, Zoölogy and Geography.
Botany, Physics.
- Brossmann, Charles, 1616 Merchants Bank Bldg., Indianapolis.
Consulting Engineer.
Water Supply, sewage disposal, sanitary engineering, etc.
- Brown, James, 5372 E. Washington St., Indianapolis.
Professor of Chemistry, Butler College.
Chemistry.
- Bruce, Edwin M., 2401 North Ninth St., Terre Haute.
Assistant Professor of Physics and Chemistry, Indiana State Normal.
Chemistry, Physics.
- Bryan, William Lowe, Bloomington.
President, Indiana University.
Psychology.
- Bybee, Halbert P., Bloomington.
Graduate Student, Indiana University.
Geology.
- Canis, Edward N., 2221 Park Ave., Indianapolis.
Officeman with William Burford.
Botany, Psychology.
- Carmichael, R. D., Bloomington.
Assistant Professor of Mathematics, Indiana University.
Mathematics.
- Caswell, Albert E., Lafayette.
Instructor in Physics, Purdue University.
Physics and Applied Mathematics.
- Chansler, Elias J., Bicknell.
Farmer.
Ornithology and Mammals.

- Clark, Jediah H., 126 East Fourth St., Connersville.
Physician.
Medicine.
- Comner, S. D., West Lafayette.
- Cox, William Clifford.
- Crowell, Melvin E., 648 E. Monroe St., Franklin.
Dean of Franklin College.
Chemistry and Physics.
- Cutter, George, Broad Branch Road, Washington, D. C.
Retired. Manufacturer of Electrical Supplies.
Conchology.
- Daniels, Lorenzo E., Rolling Prairie.
Retired Farmer.
Conchology.
- Davis, Melvin K., Anderson.
Instructor, Anderson High School.
Physiography, Geology, Climatology.
- Deppe, C. R., Franklin.
- Dietz, Harry F., 2719 Shriver Ave., Indianapolis.
Deputy State Entomologist.
Entomology, Eugenics, Parasitology, Plant Pathology.
- Dolan, Jos. P., Syracuse.
- Drew, David Abbott, 817 East Second St., Bloomington.
Instructor in Mechanics and Astronomy.
Astronomy, Mechanics, Mathematics and Applied Mathematics.
- Duden, Hans A., 5050 E. Washington St., Indianapolis.
Analytical Chemist.
Chemistry.
- Dutcher, J. B., Bloomington.
Assistant Professor of Physics, Indiana University.
Physics.
- Earp, Samuel E., 24½ Kentucky Ave., Indianapolis.
Physician.
- Edmonston, Clarence E., Bloomington.
Graduate Student, Physiology, Indiana University.
Physiology.

- Ellis, Max Mapes, Boulder, Colo.
 Instructor in Biology, University of Colorado.
 Biology, Entomology.
- Evans, Samuel G., 1452 Upper Second St., Evansville.
 Merchant.
 Botany, Ornithology.
- Ewers, James E., Terre Haute.
 Instructor in High School.
 Geology.
- Felver, William P., 325½ Market St., Logansport.
 Railroad Clerk.
 Geology, Chemistry.
- Fisher, Martin L., Lafayette.
 Professor of Crop Production, Purdue University.
 Agriculture, Soils and Crops, Birds, Botany.
- Frier, George M., Lafayette.
 Assistant Superintendent, Agricultural Experiment Station, Purdue
 University.
 Botany, Zoölogy, Entomology, Ornithology, Geology.
- Fuller, Frederick D., 213 Russell St., West Lafayette.
 Chief Deputy, State Chemist, Purdue Experiment Station.
 Chemistry, Microscopy.
- Funk, Austin, 404 Spring St., Jeffersonville.
 Physician.
 Diseases of Eye, Ear, Nose and Throat.
- Galloway, Jesse James, Bloomington.
 Instruction, Indiana University.
 Geology, Paleontology.
- Gates, Florence A., 416 Irving St., Toledo, Ohio.
 Teacher of Botany.
 Botany and Zoölogy.
- Glenn, E. R., 535 North Walnut St., Bloomington.
 Instructor in Physics, Bloomington High School.
 Physics.
- Gottlieb, Frederic W., Morristown.
 Care Museum of Natural History. Assistant Curator, Moores Hill
 College.
 Archaeology, Ethnology.

- Grantham, Guy E., 437 Vine St., West Lafayette.
 Instructor in Physics, Purdue University.
- Greene, Frank C., Missouri Bureau of Geology and Mines, Rolla, Mo.
 Geologist.
 Geology.
- Grimes, Earl J., Russellville.
 Care U. S. Soil Survey.
 Botany, Soil Survey.
- Haggerty, Melvin K., Bloomington.
 Professor of Psychology, Indiana University.
 Psychology.
- Harding, C. Francis, 111 Fowler Ave., West Lafayette.
 Professor of Electrical Engineering, Purdue University.
 Mathematics, Physics, Chemistry.
- Harman, Mary T., 611 Laramie St., Manhattan, Kansas.
 Instructor in Zoölogy, Kansas State Agricultural College.
 Zoölogy.
- Heimbürger, Harry V., 701 West Washington St., Urbana, Ill.
 Assistant in Zoology, University of Illinois.
- Hendricks, Victor K., 855 Benton Ave., Springfield, Mo.
 Assistant Chief Engineer, St. L. & S. F. R. R.
 Civil Engineering and Wood Preservation.
- Hetherington, John P., 418 Fourth St., Logansport.
 Physician.
 Medicine, Surgery, X-Ray, Electro-Therapeutics.
- Hilliard, Curtis M., West Lafayette.
- Hinman, J. J., Jr., 507 East Eleventh St., Indianapolis.
 City Chemist.
 Chemistry.
- Hole, Allen D., Richmond.
 Instructor, Earlham College.
- Hubbard, Lucius M., South Bend.
 Lawyer.
- Hutton, Joseph Gladden, Brookings, South Dakota.
 Associate Professor of Agronomy, State College.
 Agronomy, Geology.

- Hyde, Roscoe Raymond, Terre Haute.
 Assistant Professor, Physiology and Zoölogy, Indiana State Normal.
 Zoölogy, Physiology, Bacteriology.
- Ibison, Harry M., Marion.
 Instructor in Science, Marion High School.
- Jackson, D. E., St. Louis, Mo.
 Assistant Professor, Pharmacology, Washington University.
- Johnson, A. G., Madison, Wisconsin.
- Jones, Wm. J., Jr., Lafayette.
 State Chemist, Professor of Agriculture and Chemistry, Purdue University.
 Chemistry, and general subjects relating to agriculture.
- Kenyon, Alfred Monroe, 315 University St., West Lafayette.
 Professor of Mathematics, Purdue University.
 Mathematics.
- Kleinsmid, R. B., Jeffersonville.
 Care Indiana Reformatory.
- Liebers, Paul J., 1104 Southeastern Ave., Indianapolis.
- Ludwig, C. A., 210 Waldron St., West Lafayette, Ind.
 Assistant in Botany, Purdue University.
 Botany, Agriculture.
- Ludy, L. V., 229 University St., Lafayette.
 Professor, Experimental Engineering, Purdue University.
 Experimental Engineering in Steam and Gas.
- Mason, T. E., Bloomington.
 Graduate Student, Mathematics, Indiana University.
 Mathematics.
- McBride, Robert W., 1239 State Life Building, Indianapolis.
 Lawyer.
- McCulloch, T. S., Charlestown.
- Markle, M. S., Richmond.
- Middletown, A. R., West Lafayette.
 Professor of Chemistry, Purdue University.
 Chemistry.
- Miller, Fred A., 534 E. Twenty-ninth St., Indianapolis.
 Botanist for Eli Lilly Co.
 Botany, Plant Breeding.

Montgomery, Hugh T., South Bend.

Physician.

Geology.

Moore, George T., St. Louis, Mo.

Director, Missouri Botanical Garden.

Botany.

Morrison, Edwin, 80 S. W. Seventh St., Richmond.

Professor of Physics, Earlham College.

Physics and Chemistry.

Mowrer, Frank Karlsten, Interlaken, New York.

Cooperative work with Cornell University.

Biology, Plant Breeding.

Muncie, F. W.

Myers, B. D., 321 N. Washington St., Bloomington.

Professor of Anatomy, Indiana University.

Nieuwland, J. A., The University, Notre Dame, Ind.

Professor, Botany, Editor Midland Naturalist.

Systematic Botany, Plant Histology, Organic Chemistry.

North, Cecil C., Greencastle.

O'Neal, Claud E., Bloomington.

Graduate Student, Botany, Indiana University.

Botany.

Orton, Clayton R., State College, Pennsylvania.

Assistant Professor of Botany, Pennsylvania State College.

Phytopathology, Botany, Mycology, Bacteriology.

Osner, G. A., Ithaca, New York.

Care Agricultural College.

Owen, D. A., 200 South State St., Franklin.

Professor of Biology (Retired.)

Biology.

Owens, Charles E., Corvallis, Oregon.

Instructor in Botany, Oregon Agricultural College.

Botany.

Petry, Edward Jacob, 267 Wood St., West Lafayette.

Instructor in Agriculture.

Botany, Plant Breeding, Plant Pathology, Bio-Chemistry.

Phillips, Cyrus G., Moores Hill.

Pickett, Fermen L., Bloomington.

Botany Critic, Indiana University Training School.

Botany. Forestry Agriculture.

Pipal, F. J., 114 S. Salisbury St., West Lafayette.

Price, James A., Fort Wayne.

Ramsey, Earl E., Bloomington.

Principal High School.

Schultze, E. A., Laurel.

Fruit Grower.

Bacteriology, Fungi.

Silvey, Oscar W., 437 Vine St., West Lafayette.

Instructor in Physics.

Physics.

Smith, Chas. Piper, College Park. Md.

Associate Professor, Botany, Maryland Agricultural College.

Botany.

Smith, Essie Alma, R. F. D. 6, Bloomington.

Smith, E. R., Indianapolis.

Horticulturist.

Spitzer, George, Lafayette.

Dairy Chemist, Purdue University.

Chemistry.

Steele, B. L., Pullman, Washington.

Associate Professor of Physics, State College, Washington.

Stoltz, Charles, 530 N. Lafayette St., South Bend.

Physician.

Stoddard, J. M.

Stuart, M. H., 3223 N. New Jersey St., Indianapolis.

Principal, Manual Training High School.

Physical and Biological Science.

Sturmer, J. W., 119 E. Madison Ave., Collingswood, N. J.

Dean, Department of Pharmacy, Medico-Chirurgical College of Philadelphia.

Chemistry, Botany.

Taylor, Joseph C., Logansport.

Wholesale merchant.

Thompson, Albert W., Owensville.

Merchant.

Geology.

- Thompson, Clem O., Salem.
Principal High School.
- Thorburn, A. D., Indianapolis.
Care Pitman-Myers Co.
Chemistry.
- Trueblood, Iro C. (Miss), 205 Spring Ave., Greencastle.
Teacher of Botany, Zoölogy, High School.
Botany, Zoölogy, Physiography, Agriculture.
- Tucker, W. M., 841 Third St., Chico, California.
Principal High School.
Geology.
- Turner, William P., Lafayette.
Professor of Practical Mechanics, Purdue University.
- Vallance, Chas. A., Indianapolis.
Instructor, Manual Training High School.
Chemistry.
- Voorhees, Herbert S., 2814 Hoagland Ave., Fort Wayne.
Instructor in Chemistry and Botany, Fort Wayne High School.
Chemistry and Botany.
- Wade, Frank Bertram, 1039 W. Twenty-seventh St., Indianapolis.
Head of Chemistry Department, Shortridge High School.
Chemistry, Physics, Geology and Mineralogy.
- Waterman, Luther D., Indianapolis.
Physician.
- Weems, M. L., 102 Garfield Ave., Valparaiso.
Professor of Botany.
Botany and Human Physiology.
- Weir, Daniel T., Indianapolis.
Supervising Principal, care School office.
School Work.
- Weyant, James E., Indianapolis.
Teacher of Physics, Shortridge High School.
Physics
- Wheeler, Virges, Montmorenci.
- Wiancko, Alfred T., Lafayette.
Chief in Soils and Crops, Purdue University.
Agronomy.

Williams, Kenneth P., Bloomington.

Instructor in Mathematics, Indiana University.

Mathematics, Astronomy.

Williamson, E. B., Bluffton.

Cashier, The Wells County Bank.

Dragonflies.

Wilson, Charles E., Bloomington.

Graduate Student, Zoölogy, Indiana University.

Zoölogy.

Wood, Harry W., 84 North Ritter Ave., Indianapolis.

Teacher, Manual Training High School.

Woodburn, Wm. L., 902 Asbury Ave., Evanston, Ill.

Instructor in Botany, Northwestern University.

Botany and Bacteriology.

Woodhams, John H., care Houghton Millin Co., Chicago, Ill.

Traveling Salesman.

Mathematics.

Yocum, H. B., Crawfordsville.

Young, Gilbert A., 725 Highland Ave., Lafayette.

Head of Department of Mechanical Engineering, Purdue University.

Zehring, William Arthur, 303 Russell St., West Lafayette.

Assistant Professor of Mathematics, Purdue University.

Mathematics.

Zeleny, Charles, University of Illinois, Urbana, Ill.

Associate Professor of Zoölogy.

Zoölogy.

Fellows	66
Members, Active	138
Members, Non-resident	29
	<hr/>
Total	233

MINUTES OF THE TWENTY-EIGHT ANNUAL MEETING
INDIANA ACADEMY OF SCIENCE

CLAYPOOL HOTEL, November 28, 1912.

The Executive Committee met at 7:30 p. m. in their annual session with Joseph P. Naylor, President, in the chair, and the following members present: Donaldson Bodine, A. L. Foley, W. S. Blatchley, W. A. Cogshall, D. M. Mottier, R. W. McBride, C. R. Dryer, W. J. Moenkhaus, L. J. Rettger, J. W. Beede, R. Hessler, J. S. Wright and A. J. Bigney.

The minutes of the meeting of the Executive Committee of 1911 were read and approved.

The reports of the standing committees were then taken up. The program committee, with J. W. Beede, Chairman, stated that their work had been performed as indicated by the published program.

The Membership Committee reported that they had sent out printed notices urging members to try to secure new members for the Academy. A goodly number of names would be reported on Friday.

On motion a committee consisting of Professors Bodine and Cogshall was appointed to revise the constitution.

The following persons were recommended as Fellows: Chas. W. Shannon, Brazil; H. W. Anderson, Crawfordsville; Chas. M. Smith, H. E. Enders, and Frank D. Kern, Lafayette.

Committees on Weeds and Biological Survey made no report.

The treasurer read a list of 47 members who were in arrears for dues for more than two years. On motion it was decided to drop these unless their dues are paid for by January 1, 1913.

J. S. Wright, reporting for the State Librarian, stated that not as many books had been bound as formerly on account of a lack of funds.

J. S. Wright also reported that of the 900 copies of the Proceedings printed, 108 had been sent to foreign exchanges, 88 to home exchanges, 200 to libraries, the remainder to the members and as reserves.

The Editor, L. J. Rettger, reported that his work had been completed as shown by the volume of Proceedings. He gave the committee some notion of the difficulty connected with this work.

The Treasurer made the following report:

Balance from 1911.....	\$263 70
Received from dues.....	236 50
	<hr/>
Total	\$500 20
Expenditures	225 82
	<hr/>
Balance	\$274 38

On motion, C. C. Deam was appointed Press Secretary, pro tem.

Dr. C. R. Dryer presented a communication from a Chicago committee relative to the conservation of Dune Park. On motion a committee was appointed to consider the communication. The following committee was appointed: Chas. R. Dryer, W. S. Blatchley, D. M. Mottier.

After discussing the general interest of the Academy, the committee adjourned.

GERMAN HOUSE, November 29, 1912.

The Indiana Academy of Science met in general session at 9:30 a. m. with President Joseph P. Naylor in the chair. The minutes of the Executive Committee were read and approved.

H. J. Banker stated that he had a number of separates of the List of Scientific Literature in College Libraries, as published in 1911 Proceedings, and that these were at the disposal of the members.

On motion the committee, consisting of H. J. Banker and Will Scott, was ordered to be continued.

On motion the powers of the above committee were extended to include other libraries in the State as they might deem wise and that the report should not be published until 1913 Proceedings.

The Committee on Revision of the Constitution reported through D. Bedline, the report to be acted upon next year. The report is as follows:

ARTICLE III.

SECTION 1. The President shall at each annual meeting appoint the standing committees.

SEC. 2. The annual meeting of the Academy shall be held in the city of Indianapolis on the Friday following Thanksgiving Day, unless otherwise ordered by the Executive Committee. There shall also be a summer meeting at such time and place as may be decided upon by the Program

Committee. Other meetings may be called at the discretion of the Executive Committee. The Executive Committee, together with the standing committees, shall constitute the Council of the Academy and represent it in the transaction of any necessary business not especially provided for in this Constitution: *Provided*, That no question of amendment shall be decided in the same session at which it is presented.

The Treasurer made the following report:

Balance from 1911.....	\$263 70
Receipts from dues.....	236 50
	<hr/>
Total	\$500 20
Expenditures	225 82
	<hr/>
Balance	\$274 38

Accepted and referred to Auditing Committee.

The Membership Committee reported the following applicants for membership:

Bryan, Wm. L.	Bloomington
Brown, James	Irvington
Bybee, Halbert P.	Bloomington.
Carmichael, R. D.	Bloomington.
Conner, S. D.	West Lafayette
Edmonson, C. E.	Bloomington
Hilliard, Curtis Morrison.....	West Lafayette
Himman, J. J., Jr.	Indianapolis, 507 E. Eleventh
Kleinsmid, R. B.	Jeffersonville
Mason, T. E.	Bloomington
North, Cecil C.	Greencastle
O'Neal, Claude E.	Bloomington
Phillips, Cyrus G.	Moore's Hill
Price, Hugh B.	Greencastle
Ramsey, Earl E.	Bloomington
Thomas, Cecil C.	Crawfordsville
Wilson, Chas. E.	Bloomington
Wood, Harry W.	Indianapolis
Yocum, Harry B.	Crawfordsville

On motion they were elected to membership.

The following members were elected as Fellows on recommendation of Executive Committee:

Anderson, H. W.	Crawfordsville
Enders, B. E.	West Lafayette
Kern, Frank D.	West Lafayette
Shannon, Chas. W.	Norman, Oklahoma
Smith, Chas. M.	West Lafayette

The Academy then took up the regular program in general session.

AFTERNOON SESSION.

Academy met in general session at 1:30.

On motion, H. J. Banker and L. J. Rettger were added to the Committee on Nominations.

President Naylor announced the following standing committees:

Program—J. W. Beede, J. S. Wright, D. M. Mottier.

Membership—E. R. Cumings, E. S. Johnmott, F. B. Wade.

Nominations—R. R. Ramsey, P. N. Evans, H. J. Banker.

Auditing—L. J. Rettger, Edwin Morrison.

State Library—H. E. Barnard, W. S. Blatchley, A. W. Butler.

Restriction of Weeds and Diseases—R. Hessler, J. N. Hurty, A. W. Butler, Stanley Coulter, D. M. Mottier.

Directors of Biological Survey—Stanley Coulter, J. C. Arthur, J. M. Van Hook, C. H. Eigenmann, U. O. Cox.

Relations of the Academy to the State—R. W. McBride, G. Culbertson, C. C. Deam, A. W. Butler, W. W. Woollen.

Distribution of Proceedings—H. E. Barnard, H. L. Bruner, A. J. Bigney, C. W. Benton, W. J. Moenkhaus.

Publication of Proceedings—C. C. Deam, Editor, L. J. Rettger, C. R. Dryer.

On motion the Program Committee was instructed to co-operate with the Executive Committee of the Conservation Commission in preparing a Symposium on Conservation to be presented as a part of the Academy program next year.

The State Librarian reported, per J. S. Wright, that foreign and home exchanges to the number of 305 volumes had been bound during the past year.

On motion it was decided to refer the preparation of a topographic map of Indiana to the committee on the Relation of the Academy to the

State, instructing them to urge the State Legislature to co-operate with the U. S. Government in making such a map.

The Committee on Nominations reported as follows:

Donaldson Bodine, President; Severance Burrage, Vice-President; A. J. Bigney, Secretary; C. M. Smith, Assistant Secretary; F. B. Wade, Press Secretary; W. J. Moenkhaus, Treasurer; C. C. Deam, Editor.

On motion of L. J. Rettger, the Program Committee was instructed to have the meeting next year late in October, or early in November. This closed the work of general session and the Academy passed to sectional meetings.

EVENING SESSION.

The Academy met in the Auditorium of the Y. M. C. A. Building. The following illustrated lectures were given and greatly appreciated:

An Experimental Investigation of Certain Pharmacological Reactions—
D. W. Jackson.

The Photography of Sound Waves—A. L. Foley.

A Brief Account of the Indiana University Expedition to Columbia, South America—C. H. Eigenmann.

Adjournment.

J. P. NAYLOR, President.

A. J. BIGNEY, Secretary.

PROGRAM OF THE TWENTY-EIGHTH ANNUAL MEETING
 INDIANA ACADEMY OF SCIENCE

GERMAN HOUSE, INDIANAPOLIS, INDIANA.

November 28, 29, 1912.

JOSEPH P. NAYLOR, President.

DONALDSON BODINE, Vice-President.

A. J. BIGNEY, Secretary.

W. J. MOENKHAUS, Treasurer.

THURSDAY, NOVEMBER 28, 7:30 P. M.

Meeting of the Executive Committee at the Claypool Hotel.

FRIDAY, NOVEMBER 29, 9:00 A. M.

Business.

Birds that Destroy Grapes, 10 m.....	Amos W. Butler
The Protection of Our Rivers from Pollution, 15 m.....	Jay Craven
The Potability of Surface and Ground Waters of Indiana, 15 m.....
.....H. E. Barnard
*The Problem of the Psychology of Adolescent Crime, 20 m.....
.....R. B. Kleinsmid
The Human Factor, 30 m.....M. E. Haggerty
Theory and Practice, 15 m.....W. L. Bryan
A Natural Bridge in Parke County, Indiana, 5 m.....Charles R. Dryer

FRIDAY, NOVEMBER 29, 1:30 P. M.

BUSINESS.

Sectional Meetings.

SECTION I.

A Heronry near Indianapolis. 10 m.....	Amos W. Butler
Further Notes on Indiana Birds. 15 m.....	Amos W. Butler
Food and Methods of Feeding of Fresh Water Mussels. 15 m.....
.....William R. Allen
Further Notes on the Seedless Persimmon in Indiana. 5 m.....	D. M. Mottier
A Revision of the Mosses of Monroe County, Indiana. 5 m.....	F. L. Pickett
On the Age of Corms in <i>Arisaema triphyllum</i> . 5 m.....	F. L. Pickett
Acetic Alcohol as a fixing Agent in Plant Histology. 5 m.....	F. L. Pickett
Plants New to Indiana. 15 m.....	Charles C. Deam

* Papers not presented.

The Influence of Certain Environic Factors on the Development of Fern Prothallia. 10 m.....	D. M. Mottier
Report of the work in Corn Pollination—IV. 5 m.....	M. L. Fisher
Conjugation in Spirogyra. 10 m.....	F. M. Andrews
An Instructive Modification of an Old Experiment. 3 m.....	Howard J. Banker
*Summer Conditions of Indiana Lakes. 15 m.....	Will Scott
Photosynthesis in Submerged Terrestrial Plants. 5 m.....	H. V. Heimberger
Indiana Fungi—III. 5 m.....	J. M. Van Hook
*Observations upon Some Onion Diseases in Indiana. 15 m.....	C. R. Orton
Fungous Enemies on the Sweet Potato in Indiana. 10 m.....	C. A. Ludwig
Notes on Some Puff-Balls of Indiana. 10 m.....	Frank D. Kern
*Further Studies of the Growth Rate of the White Ash in Indiana. 10 m.....	Stanley Coulter
The Cultivation and Improvement of Medicinal Plants. 10 m.....	F. A. Miller
The Diagnostic Value of Certain Characteristics of the Starch Grain. 10 m.....	R. B. Harvey
*Cocklebur. 10 m.....	F. J. Pipal

SECTION II.

An Experimental Investigation of Certain Pharmacorogical Reactions. (Lantern) 20 m.....	D. W. Jackson
Butter Fat Analysis. 20 m.....	George Spitzer
Nascent Elements. 15 m.....	J. H. Ransom
The Penetration of Wood by Zinc Chloride. 15 m.....	Edward G. Mahin
Coniology. 20 m.....	Robert Hessler
A Statistical Study of the Streptococci from Milk and from the Human Throat. 15 m.....	E. C. Stowell, C. M. Hilliard and M. J. Schlesinger
On the Atomic Structure of Energy. 15 m.....	A. E. Caswell
Some Observations upon the Crystal Habit of Synthetic Gems of the Corundum Type, with Application to the Problem of Proper Cutting of the Gems. 10 m.....	Frank B. Wade
On Linear Difference Equations of the First Order, with Rational Coefficients. 5 m.....	Thomas E. Mason
Notes on the Intersection of Osculating Planes to the Twisted Cubic. 10 m.....	A. M. Kenyon
Young's Modulus of Steel in a Magnetic Field. 10 m.....	Edwin Morrison
Terraces of the Wabash Valley in Parke, Vermilion and Vigo Counties. 10 m.....	Charles R. Dryer
The Raccoon Valley, Parke County, Indiana. 20 m.....	Charles R. Dryer

- *Notes on the Relation of the Native Vegetation to Surface Geology
as Observed in Indiana. By title.....C. W. Shannon
- *The Mansfield Sandstone Area of Indiana. By title.....C. W. Shannon
- Remarks on the Value of Core Drilling in Regions of Questionable
Stratigraphic Succession. 10 m.....J. W. Beede
- The Determination of Hydrogen, Methane and Nitrogen in Gas by
Combustion in Quartz Tube. 2 m.....F. C. Mathers and Ira Lee
- New Methods for the Preparation of Selenates. 2 m.....
.....F. Mathers and J. Otto Frank
- A New Qualitative Test for Chlorides in the Presence of Bromides
and Iodides. 2 m.....F. C. Mathers and Ira Lee
- Electroplating in Colloidal solutions. 10 m.....James E. Weyant

EVENING SESSION, 8:15 P. M.

- The Photography of Sound Waves. Lantern. 20 m.....A. L. Foley
- A Brief Account of the Indiana University Expedition to Columbia.
Lantern. 30 m.....C. H. Eigenmann
- Papers not Read at the Previous Sessions.

THE WATER SUPPLY OF INDIANA.

BY H. E. BARNARD.

In my discussion of the water supplies of Indiana I shall refer only to the waters used for drinking and domestic purposes, and for my data draw upon the thousands of analyses made at the Laboratory of Hygiene of the State Board of Health during the last seven years. The information we have collected far exceeds all other available data on the subject.

In the period the laboratories have been in operation we have analyzed 6,127 samples of water collected from every part of the State, and from all kinds of sources. Of the total number of examinations made 3,051 were from shallow wells, 1,908 from deep wells, 289 springs, 267 streams, 166 ponds and lakes, 196 cisterns, 201 miscellaneous and 49 sewage. Of all the supplies examined 3,537 have been potable, that is, free from sewage and chemically suitable for drinking and domestic purposes, 1,837 bad and 753 doubtful.

One thousand two hundred and forty samples have been sent to us from public supplies. Of this number 137 were derived from shallow wells, 593 deep wells, 251 streams, 61 springs, 140 ponds and lakes and 55 miscellaneous.

Four thousand, eight hundred and eight-seven samples were private supplies, that is, supplies used by a single family. A large number of these samples were collected in the district by local health officers, but many samples were sent in by the owners themselves and in the aggregate no small number represents private well supplies from city lots. Of the private supplies examined 3,029 samples were taken from shallow wells, 1,354 deep wells, 246 springs, 205 cisterns, 37 sewage and 16 miscellaneous.

Of the 614 public water supplies classed in another tabulation as deep wells 518 were of good quality, 31 bad and 66 doubtful.

Of the 136 shallow wells used as public supplies, 82 were good, 33 bad and 21 doubtful—that is, while about 15 per cent. of the deep well public supplies were either bad or doubtful, 40 per cent. of the shallow wells were either bad or doubtful.

Two hundred and forty samples represented stream waters used as public supplies. Of this number 146 were classed as good, 46 as bad and 48 as doubtful.

Of the 94 public springs 59 were of good quality, 18 were bad and 17 doubtful.

Of the 147 pond supplies, 94 were good, 23 bad and 30 doubtful.

One thousand, three hundred and seventy-seven samples of private water supplies were taken from deep wells. Of this number 1,091 were good, 160 were unqualifiedly bad and 126 were doubtful, in other words, about 20 per cent. of the deep well waters were either of bad or doubtful quality.

Of the 3,057 shallow wells examined, 1,331 were good, 1,391 were bad and 335 were doubtful or rather more than 56 per cent. of all the shallow well waters examined were unfit for drinking and domestic purposes.

Out of the mass of data collected, we are now able to determine with such a degree of accuracy that our statement is not a hypothesis but a fact that the well supply of the cities and towns of Indiana is not only to be viewed with suspicion, but in rather more than 50 per cent. of the cases, pronounced polluted.

If such a statement had been made the first or second year of our work, it would have undoubtedly been pointed out that the waters analyzed did not represent average conditions and that the samples sent in were from wells suspected of being impure, and that while many of these samples did prove to be polluted, by far the greater number of wells were pure and safe. But as year after year we have tabulated the results of our work, we have noticed the very singular fact that our results varied very little indeed. In fact the percentage of bad and doubtful well waters in the year 1912 is almost exactly the percentage reported the first year of our work in 1906. It is impossible to believe that the health officers after studying the well supplies in their community for many years, are still sending in only the worst waters, or that the individual owner is not asking for an analysis save when he suspects the purity of his supply. I am convinced that of the two million wells furnishing water to the citizens of Indiana, at least one million are not furnishing pure water, but a water contaminated by the wastes of the home and community. Of 4,959 wells examined in the last few years, 3,051 have been classified as shallow wells, and 1,908 as deep wells. This classification is not perfect for it is frequently impossible to get data sufficiently adequate to place a well in its proper class. We classify all dug wells as shallow wells, and all driven wells as shallow wells when it is evident that the well

does not pass through an impervious strata. In some parts of the State a layer of clay or hard pan may lie so close to the surface that a driven well not more than ten feet deep may in fact reach second water and so entitle it to be classed as a deep well. In other parts of the State, especially where sand and gravel deposits are deep, a well may be seventy-five or one hundred feet in depth and still tap only surface water. Obviously, when we do not know all the facts, our classification is subject to some inaccuracies.

The difference in the quality of the deep and shallow well is strikingly shown. If the actual facts were at hand, I have no doubt but what the proportion of deep wells of satisfactory character would be greatly increased. There is no real reason why every properly cased well which passes through an impervious strata should not furnish pure water, save in the isolated instances where sewage is poured through sink holes or abandoned gas wells into the lower levels. Such conditions do obtain in the cavernous regions in the southern part of the State, and they are not unknown in the so-called gas belt.

Indianapolis, Indiana.

THE PROTECTION OF OUR RIVERS FROM POLLUTION.

BY JAY CRAVEN.

It has only been in the last few years that the two closely connected problems—pure water supplies and sewage disposal—have been gaining rapidly, increasing attention from sanitarians and others interested in the welfare of the public. Formerly but little attention was paid to the sanitary condition of our rivers. They were taken to be the natural and intended channels for the disposition of sewage and manufacturing wastes. Before our population was so concentrated, sewage disposal by dilution was satisfactory from a physical standpoint, but now the condition of many of our streams has become such that for a part of the year at least the odors from them are quite obnoxious and a nuisance to the cities and to the population living along the banks, as well as a menace to their health. Even though the large rivers may not be offensive, yet where these rivers have to be used for water supplies, diseases that may be carried by water constitute an always present menace to the health of our people.

Like many other problems, the public is not aroused until their attention has been attracted by severe measures. Epidemics, more terrible because they were due to a preventable disease, have occurred in the last few years, carrying with them a needless sacrifice of money, and more important, of human life. Just to cite one case, let me give a few figures from the typhoid epidemic at Erie, Pa., the population of which was 68,000. From December 1, 1910, to May 10, 1911, 1,012 cases and 125 deaths were reported to the health department. For comparative purposes a value of \$5,000 has frequently been placed on a man's value to the community. The loss to Erie at this figure was \$625,000, not including the expenses, such as loss of time, doctor bills, medicine, etc., of the remainder of the 1,012 who recovered.

Different States have taken up the problem and considerable work has been done in Massachusetts, New York, New Jersey, Pennsylvania and Ohio. In our State a bill was passed in 1909 providing for the protection of the streams from pollution. Since that time, extensive surveys have

been made by the State Board of Health for the purpose of determining the condition of Indiana lakes and streams.

In the summer of 1911 a sanitary survey of the Ohio River along the southern boundary of Indiana was made. The work was started at Cincinnati and samples of the river water were analyzed from this point to the mouth of the Wabash River. They were collected at every mile with the exception of a short distance, where circumstances made it necessary to take them every two miles. A study of the water and sewer system in each city or town of sufficient size to have such improvements, was made. Analyses, chemical and bacterial, were made of all water supplies, especial attention being given to those using the river for their source of supply. Manufacturing plants were visited, and if they were emptying waste into the river, the kind, together with an estimate of the amount, was noted.

In the summer of 1912, a survey of the Wabash River from Bluffton to its mouth was made and similar data collected. On both surveys a houseboat equipped for the laboratory work and living quarters was used. The first summer a one-room houseboat was prepared, and although it was used throughout the summer, it was found to be rather small for the work. Last summer a two-room houseboat was built, special attention being paid to the design.

This boat was found to be so well suited to the purpose that a stern paddle and an engine were installed, and it is to be used on White River next summer.

Although no immediate results were looked for, yet an agitation was started in three places on the Ohio River resulting in a treated water supply for one city and a change from the river to a well supply in two towns, so that it is felt that the cost of the trip has more than been justified already.

Valuable work can be done by the different States with respect to the rivers lying wholly within their control, but a great number of our important rivers flow through many States, and instead of having a State problem we have an interstate one, which is far more difficult to handle. It is therefore not a problem for one State, nor for a few of the States along a river, but one which federal legislation will have to regulate.

At a joint meeting of two comparative new associations, the Great Lakes Pure Water Association, and the National Association for Preventing the Pollution of Rivers and Waterways, held at Cleveland, Ohio, last

October, a tentative report of the latter committee on the feasibility of establishing standards of purity for river and waterways, was read. The men comprising the committee have a national reputation and have given much time and study to the problem, and the following extracts from their report should be of interest:

"This committee finds that on account of the increasing population of the country, it is and always will be physically impossible to maintain waterways in their original and natural condition of purity. A reasonable degree of cleanliness should nevertheless be demanded.

"The discharge of raw sewage into streams and harbors should not be universally prohibited by law. The method of disposal of sewage by dilution is recognized as sound in principle and safe in practice if carried on with proper restrictions.

"For each waterway at any given point there is a limit to the amount of permissible discharge of waste matter, depending upon the use that is made of the river and the character of the territory through which it flows. No universal standard of purity can be wisely established or maintained. When the extent of the pollution is such as to affect the public health in any way by any reasonable use of the river the sanitary aspect of the situation should control and the degree of the pollution should be regulated accordingly. The courts must decide what is reasonable use. When the extent of the pollution is such as to cause sensible offense to public decency in the course of any reasonable use of the river, this aspect of the situation may properly control. When the extent of pollution is such as to cause material injury to fish or shellfish industries, or to the ice industry, this element may control. When the extent of the pollution is such as to cause the silting up of the channels of navigable streams, this element may control.

"Even when the demand of public health, offense to decency and interference with navigation are such as to place a limit to the pollution of the streams the economic aspect of the case should be considered in regulating the amount of permissible discharge of waste matter, the fundamental principle being that the results accomplished shall be reasonably commensurate with the cost of prevention of the pollution.

"While no universal standard of purity applicable to all rivers and waterways can be established, it is believed to be feasible to establish and maintain appropriate standards of a general nature for waters that fall within certain particular groupings.

"Inasmuch as the safety of public water supplies is the most important element in the problem of stream pollution at the present time, the following general principles should govern the discharge of sewage and waste matters into rivers and waterways:

"Streams from which water supplies are taken without purification should not receive any fecal matter, sewage, sewage effluent or wastes that will render the water a menace to health or otherwise impair its natural quality.

"Streams from which water supplies are taken and used after purification should not receive fecal matter, sewage, sewage effluent or waste matter in such quantities that the contamination of the water at any water-works intake would put an unreasonable burden upon the purification works, or in quantities sufficient to produce the conditions referred to in the next paragraph.

"Streams not used for water supplies may receive sewage wherever and in such quantities that its entrance will not sensibly offend decency in the reasonable public use of the stream, or cause interference with navigation, or with valuable fish industries, or the ice industry. When this cannot be done, the sewage or wastes should receive such treatment before discharge as to bring the effluent within this rule, due regard being given to the relative cost of the processes required and the benefit to be derived.

"While recognizing that the pollution of many rivers and waterways is inevitable and that absolute prevention of pollution is impossible, it is deemed imperatively necessary that some control over the discharge of waste matter into rivers and waterways be maintained. The committee heartily endorses, therefore, the movement that is being made to keep the pollution of streams within reasonable bounds."

The problem of protection of our streams from pollution is one in which a general interest should be taken by everyone. Although the people on a stream below a city are directly affected, yet the urban population is affected indirectly by the food products such as vegetables and dairy supplies from farmers adjacent to the streams. Rapid strides are now being made in the protection of our rivers from pollution, and it is hoped that problem can be effectually controlled before long.

CONIOLOGY.

BY ROBERT HESSLER.

(Abstract.)

In this paper, illustrated by charts, an attempt was made to shew the need for a new science, Coniology, the science that treats of dust.

Until recently the importance of dust was not understood and apparently no serious attempt has been made to bring together the literature. To write a treatise that does the subject justice would require the co-operation of many scientists, and the investigation of special problems would require the methods peculiar to different sciences. The aims and methods of the physicist, of the astronomer, the physician, of the bacteriologist, etc., differ radically.

There are all kinds of dust.¹

Cosmic, volcanic and desert dusts collectively are the dust of the physicist, the astronomer and the meteorologist. Dust is of great importance in the matter of light and shade, of sunshine and rain.

Dusts due to the activity of man are chiefly of three kinds, street, house and factory dust. These are concerned in the modern dust problem. The very practical aspect of the dust problem is of course that of keeping the house, the streets and cities clean; it is a constant warfare with dust and dirt.

With an increase in occupations there is an increase in the special kinds of occupational dusts; some of them are very injurious.

Dust particles in the air are estimated by the number per c.c. The first three forms of dust, the dust of the physicist, occur sparingly on high mountains; there may be from a few to several hundred particles per c.c. Over the ocean they run from a few hundred to several thousand. When we come to the dust of everyday life matters change. Street dust runs from tens of thousands to hundreds of thousands per c.c.; house dust from hundreds of thousands to millions. The amount of factory dust depends largely on ventilation, how fully it is carried off.

Dust on high mountains and over the ocean is usually sterile, that is free from microbes. Dust in crowded communities, on the other hand, is

¹ See Proceedings for 1911, page 415.

“full of germs.” Some of the microbes are pathogenic, capable of producing ill health and disease. The inhalation of infected dust produces Coniosis.¹

There is urgent need for an institution to study the Dust Problem, of Coniology and Coniosis, not only in making original investigation, but in collecting the literature and in gathering and distributing information.

In a new science any one can assist, even simple observations are useful.

¹ For a table on The Evolution of Dust see Proceedings for 1906, page 47.

BIRDS THAT DESTROY GRAPES.

BY AMOS W. BUTLER.

In my report on the Birds of Indiana, 1897,¹ I referred to my observations concerning the grape-eating habits of the English sparrow. On another page reference is made to a similar reported habit which I have never observed myself of the Baltimore Oriole.² Also note is made of the grape puncturing habit of the Tennessee Warbler,³ which I have since had excellent opportunities several times to note.

The fall of 1911, while an invalid, I spent much time in a large porch swing beneath our grape arbor at my home at Irvington, Indiana. In this way I had an excellent opportunity to observe the birds found among the grapevines and note their habits. In the fall of 1912, I made some further observations. We had both years the following kinds of grapes in bearing, Catawba, Concord, Brighton, Worden, Moore's Early, Delaware and an unknown variety. In 1912 we had in addition Niagara fruiting. Those trained upon the arbor were all of two kinds, Concord, and the unknown variety—mostly the former. In 1911 the vines bore very heavily and generally both bunches and berries were undersized. In 1912 the Catawba and ConCORDS upon the arbor bore fewer grapes, mostly of small size and ripened unevenly. The same varieties in other situations bore better fruit. The behavior of the birds too was different. While the first year mentioned there were a number of robins among the vines, the most notable visitors and by far the most destructive were two kinds of warblers, the Tennessee Warbler and the Cape May Warbler.

The second year these warblers were few and inconspicuous and there were more kinds of birds about the grapes. These included great numbers of robins, mostly migrants, together with many more English Sparrows and Bronzed Grackles, Flickers, and Blue Jays which feasted upon the fruit.

1911.

- Sept. 9. Cape May Warbler, one puncturing grapes.
 Sept. 10. Cape May Warbler, one puncturing grapes.
 Sept. 10. Tennessee Warbler, two.

¹ Report of state geologist, 1897, pp. 937-8.

² *Ibid.*, p. 904.

³ *Ibid.*, p. 1037.

- Sept. 11. Tennessee Warbler, number.
- Sept. 11. Cape May Warbler, two at grapes.
- Sept. 12. Tennessee Warbler, several at grapes.
- Sept. 12. Cape May Warbler, eating many insects about grapes.
- Sept. 13. Tennessee Warbler, two at grapes.
- Sept. 13. Cape May Warbler, one about grapes, catching many insects, pecking at bees among grapes that had been picked. Saw none caught. Does it puncture grapes to draw insects? Apparently it makes one incision in a grape, while the Tennessee seems to strike the berries with partly open bill, making two incisions at each stroke. The Cape May Warbler is a fighter, attacking Tennessee Warblers and driving them away. The latter show fear of it.
- Sept. 16. Tennessee Warbler, several.
- Sept. 16. Cape May Warbler, one at grapes.
- Sept. 17. Cape May Warbler, two, brighter plumage than those heretofore seen and more wary. Drove away a Tennessee Warbler.
- Sept. 18. Cape May Warbler, two.
- Sept. 18. Tennessee Warbler.
- Sept. 19. Tennessee Warbler, several at grapes.
- Sept. 20. Cape May Warbler.
- Sept. 20. Tennessee Warbler.
- Sept. 21. Tennessee Warbler.
- Sept. 23. Tennessee Warbler, several.
- Sept. 25. Tennessee Warbler, several.
- Sept. 26. Tennessee Warbler.
- Sept. 26. Cape May Warbler, last seen.
- Sept. 27. Tennessee Warbler, several.
- Sept. 29. Tennessee Warbler.
- Oct. 1. Tennessee Warbler, common.
- Oct. 2. Tennessee Warbler, common.
- Oct. 2. Robins. For several days they have been abundant in flocks in all phases of plumage and all these are among the grape vines eating grapes and grape seeds.

In 1912 the first bird seen eating early grapes was a Catbird on August 3d. August 23d the later grapes show evidences of birds' work, but have not been able to identify those engaged at it. September 15 the following birds observed eating Concord grapes: Robins, a number; Flicker, one;

English Sparrows, several. A Black Poll Warbler was catching insects among the grapevines and afterwards disappeared among the branches. Did not see it eat any grapes. The warblers were late in appearing about the grapevines this year. They were not in numbers except for a few days.

September 29 the following birds eating grapes: Flickers, Catbirds, Yellow Bellied Sapsucker (1), Tennessee Warblers, common, Cape May Warbler (1). These ate them on the vines, as did also many Robins here in all phases of plumage, young and old. These ate both from vines and ground, where berries had fallen, also berries of elder and poke. The Robins, Bronzed Grackles, English Sparrows, ate grapes on the ground. The Robins came in droves a week ago and have cleaned the vines of all ripe grapes. The Sapsucker seemed to eat insects as well as grapes. Today saw first Cape May and yesterday first Tennessee Warblers. Have suspected them for several days past from punctured grapes noted. The Cape May and Tennessee Warblers, when alarmed, fly to the thick foliage of some young maples, where they are quiet, and from whence they can overlook the grape arbors. The Cape May has less fear of man than the Tennessee, though both permit quite close approach. They descend from the top of the arbor or dart like an arrow from the maple trees to drive away the Tennessee. The latter evidently are much afraid of them. A Cape May Warbler was both puncturing the few remaining berries and sipping stale drops from old grape skins. It carefully observes the bees around the vines turning its head and bending its neck to look, but decides not to touch them. The Tennessee Warblers also fight among themselves. Today one drove another entirely away from the vines. About the vines, too, were Blue Jays in loud voice, the first real jaying this fall. An Olive-backed Thrush flew up from the ground beneath the trellis. A Blue-headed Vireo was active among vines on the arbor. There, too, was a black and yellow warbler looking for food. A Black-throated Green Warbler went among the vines where berries were thickest, catching insects, but was not observed to take a grape. The same may be said of a young Bay-breasted Warbler on another vine. The Sapsucker evidently was as interested in searching the joints in the arbor posts as the vines.

A HERONRY NEAR INDIANAPOLIS.

BY AMOS W. BUTLER.

Thirteen miles southeast of Indianapolis is a remarkable heronry occupied by a number of Great Blue Herons. The Indianapolis papers, a year ago last May, published accounts of this interesting bird colony, but



Great Blue Herons' Nests Near Indianapolis.

called them cranes. A few days later, May 24, 1911, Dr. B. S. Potter, Superintendent of the Marion County Asylum for the Insane at Julietta, very kindly drove me to it. This heronry is situated in Section 23, Township 5, Range 15, in Hancock County, Indiana. The land is owned by Anton Schildmeier, who came to it with his father in 1837, and it has been in the family ever since. The herons were first seen about five years before my visit. They occupied a timber tract of 70 acres, which remains to this day much as it was when the present owner came to it. It is a splendid bit of the primeval forest, containing some of the finest specimens of the characteristic trees of this latitude. No amount of money can tempt this old pioneer to part with his big trees, which he loves so dearly. Neither will he permit a hunter or other person who is liable to disturb the birds upon the premises.

When the herons first occupied these woods they built their nests in sycamore and other trees. More recently they have chosen and are occupying the largest oak trees.

At the time of my visit the leaves had come out so the opportunity for observation was not as good as it had been a little earlier. Dr. Potter reported that on a former visit that spring he had counted sixty-five nests. One tree contained thirteen. Those who have attempted to count them think there are about sixty birds. If this is true, some of the nests are old ones not occupied. Mr. Schildmeier, who is a careful observer, says they return every spring with the first few warm days in March. He has seen twelve to fifteen at one time feeding in the wet meadows along Doe run, which flows through the farm. When I visited the locality the eggs were hatched. The young were making a noise and egg shells were common under the large trees bearing the nests.

To one who knows what to look for, these birds may be seen not only by travelers along the Brookville road, but also from the steam and traction cars. Doubtless the nests are also visible when the leaves are off the trees. I am indebted to Paul Shideler for a very good photograph taken a short time before my visit. It is printed herewith.

FURTHER NOTES ON INDIANA BIRDS.

BY AMOS W. BUTLER.

The following notes on the birds observed in Indiana and adjacent states are worthy of record.

Prairie Warbler. *Dendroica discolor* (Vieill.)

Mr. Philip Baker shot a specimen of this warbler near Helmsburg, Brown County, July 7, 1910, and another near the same place July 15, 1910. Both of these were sent to me for verification. He learned their song. July 22, 1910, he heard another in a different locality. In 1911 he heard one on May 7 and another June 14. In 1912 he saw two on May 27, and June 25 heard five near Nashville. All of the above were in Brown County. Mr. Baker says they frequent the sassafras thickets of abandoned hillsides. He adds, "I have no doubt the birds could be found nesting in this and similar localities in Brown County." Some of the above dates, it will be observed, come within the breeding season.

Mr. Percival Brooks Coffin reports a male of this bird from Millers, Lake County, Ind., May 16, 1909. One was noted by Miss Hazel Heath at New Paris, Ohio, April 11, 1909. Prof. Norman A. Wood, Ann Arbor, Mich., notes one at that place May 11, 1909; next seen May 12. Rare. Does not breed.

Miss Caroline M. Carpenter, of Richmond, Ind., in a list of birds identified at Lake Maxinkuckee between May 8 and 16, 1911, reports this bird.

Yellow-headed Blackbird. *Xanthocephalus xanthocephalus* (Bonap.).

Mr. Percival Brooks Coffin of Chicago reports a Yellow-headed Blackbird at Millers, Lake County, Indiana., May 16, 1909. Mr. Clarence Guy Littell reports seeing one at Winona Lake, Kosciusko County, the summer of 1902. Ind. Univ. Bull. Vol. 1. No. 4, 1903, p. 57.)

White Pelican. *Pelecanus erythrorhynchos* Gmel.

Professor Glenn Culbertson, Hanover College, reports that a White Pelican was killed on the Ohio River near Hanover, Jefferson County, May 6, 1909. Miss Hazel Heath informs me of the occurrence of two of these birds at New Paris, Ohio, August 22 and 23, 1912.

Redpoll. *Acanthis linaria linaria* (Linn.).

One seen March 7 and again March 12, 1909, at Ft. Wayne, Ind., by Mr. Harry A. Dinins and Mr. Chas. A. Stockbridge. Two reported at Roanoke, Ind., by Mr. Harry A. Dinins December 10, 1911.

Mr. Norman A. Wood reported 500 seen at Ann Arbor, Mich., December 19, 1908; again noted December 28, and last seen March 3, 1909. They are noted as common some years; other years absent.

Prof. E. L. Moseley reports one at Sandusky, Ohio, April 26 and again May 13, 1911.

Eave Swallow: Cliff Swallow. *Petrochelidon lunifrons lunifrons* (Say).

About fifty of these swallows were seen by Mr. Harry A. Dinins and Mr. Charles A. Stockbridge at Ft. Wayne, Ind., April 30, 1909. They were again noted May 1. Reported as tolerably common at that station but not given as breeding. Bicknell, Ind., September 2, 1910. Breeds; getting rare, nesting at Bicknell, Knox County, in the summer of 1911, is a report of Mr. E. J. Chansler. Lyons, Greene County, seen September 5; next September 6; last seen September 17. Rare; does not breed. (Prof. W. B. Van Gorder.) The same writer also states, when a boy in Noble County, there was a barn one-half mile east of Avilla, which had over 100 nests of the Cliff Swallows. A half mile north of that town was another barn with some 40 or 50 nests. These birds all disappeared more than twenty-five years ago. Last August (1910) in Avilla, he found a little colony of Cliff Swallows and ten nests close in a row along the eave of a barn. Six of these birds were noted by Mr. Harry A. Dinins at Roanoke, Ind., August 23, 1911, where he reports them as common and breeding.

Wawaka, 1911. In this neighborhood there are three or four small colonies of Eave or Cliff Swallows. "About one mile from my home there is a small barn which has under its eaves fifty-three nests of this swallow." O. A. Renahan.

Prof. D. W. Dennis tells me of two localities in Wayne County where a few pairs still nest.

Where are the great numbers that formerly built their curious bottle-shaped nests of mud under the eaves of the farmers' barns?

White-winged Crossbill. *Loxia leucoptera* (Gmel.).

A number reported near Brookville, Ind., in the winter of 1909 and 1910, under date of February 14, 1910, by Mr. Joseph F. Honecker.

Wood Duck. *Aix sponsa* (Linn.)

Worthington, Ind. Female shot April 10, 1909. Reported by Prof. W. B. Van Gorder, who says it breeds in that vicinity. In a letter dated December 26, 1910, the same writer says a man while mowing clover near White River in June last, found a number of little ducks. He secured six. Three died. Some two months after he got them, one of these died. The remaining two were subsequently transferred to Mr. William Holton Dye, Noblesville, Ind. They proved to be young Wood Ducks.

Henslow's Sparrow. *Passerherbulus henslowi henslowi* (Aud.).

Mr. Norman A. Wood of Ann Arbor, Mich., reports finding a male Henslow's Sparrow dead at that place April 18, 1909. May 1, 1909, he reports two shot, one a female. Very rare. This is the first record for that locality.

Rough-legged Hawk. *Archibuteo lagopus sancti-johannis* (Gmel.).

Bicknell, Knox County, Indiana. First seen December 23, 1908; next seen December 24, and last seen December 29. Same locality November 12, 1910, one. Next seen November 15; last seen December 3. Noted as common that fall. E. J. Chansler.

Egret. *Herodias egretta* (Gmel.).

Mr. E. J. Chansler reports them from Bicknell, Ind., July 25, 1910, and last seen in that locality August 30, 1910, and says: "Common this fall on ponds and other good feeding places."

Greater Snow Goose. *Chen hyperboreus nivalis* (Forst.).

Mr. Chansler reports seeing two near Bicknell, October 23, 1910. He marks them as rare, and says: "These geese were observed in a flock of Canada Geese. Usually we find them either with Canada Geese or with Hutchins' Geese, but sometimes in a flock by themselves."

Wood Ibis. *Mycteria americana* (Linn.).

Prof. W. B. Van Gorder, Lyons, Greene County, Indiana, informs me that a Wood Ibis was killed on White River near that place June 27, 1910. It had been seen in that vicinity for a month prior to that time. The Indianapolis News, July 16, 1910, reported the killing of a Wood Ibis in Brown County. Upon my request, Mr. Philip Baker, an accurate and reliable observer, was asked to verify the record. He was able to secure for me the accompanying photograph of this bird from Mr. W. W. Frazer, Mt. Liberty, Ind.

Prof. W. B. Van Gorder says a number of Wood Ibises were seen in Greene County the summer of 1911. They arrived near Marco about the middle of June and left about September 10. "The person who shot

the one I reported last year told me there were several small droves of 15-20 and at one time he thought there must have been 40. Several were shot. They were about the trees and marshes along White River." *Evening Grosbeak*. *Hesperiphona vespertina vespertina* (W. Coop.).

Prof. E. L. Moseley, Sandusky, Ohio, reports an Evening Grosbeak was shot at Huron, Ohio, January 21, 1911. Mr. Robert S. Campbell reports six Evening Grosbeaks at South Bend, Ind., the morning of April 11, 1912, and adds: "They were feeding on the seeds of a box elder tree. They were very tame. I was within six feet of them."

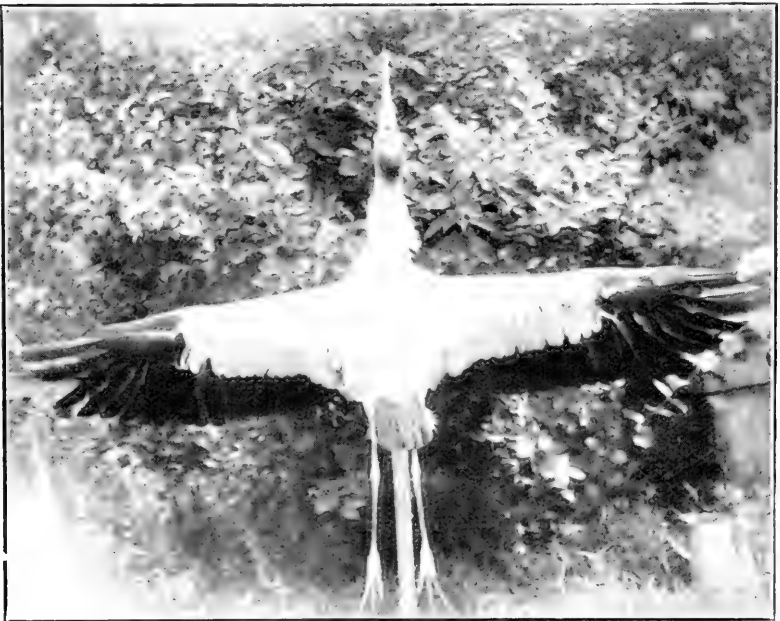

Wood Ibis Killed in Brown County, Indiana.

Mr. Norman A. Wood, Ann Arbor, Mich., writing under date of March 15, 1911, says, "A few Evening Grosbeaks were here this winter." *Prairie Chicken*. *Tympanuchus americanus americanus* (Reich.).

Knox County; rare resident; still found on Shaker prairie, western part of this county on the Wabash River. (E. J. Chanler.)

Mr. George W. Miles, State Commissioner of Fisheries and Game, is reported in the Indianapolis papers, October 22, 1912, as saying, "A con-

servative estimate of the number of prairie chickens now in Indiana is 100,000. The counties about the Kankakee basin hold the majority of the game birds. There are approximately five hundred birds in Kosciusko County, one thousand in Fulton County and between twelve thousand and fifteen thousand in White County. Other counties mentioned as having these birds in them are Pulaski, Jasper and Starke.

Wild Turkey. *Meleagris gallopavo silvestris* (Vieill.).

Knox County. Seen by Mr. Crow on a hill near the government dam on the Wabash River in the southern part of this county in 1909. The bird is probably extinct or nearly so. Mr. Mathias Pickel, of the extreme southern part of this county, on the Wabash, and a very wild locality, claims that he has not seen any Wild Turkeys since 1904. (E. J. Chausler).

The Indianapolis News, October 18, 1912, in an answer to a correspondent contains these words: "There is a man now living in the city (Indianapolis) who has shot wild turkeys between Washington and North streets. The Rev. J. C. Fletcher, son of Calvin, said that one day in 1834, when walking with his father, he saw a flock of wild turkeys light in a tree in what is now Military Park. In early times it was not uncommon for a hunter to kill fifteen or twenty in a day, and as late as 1841 one was captured in the Circle."

Snowflake: Snow Bunting. *Plectrophenax nivalis nivalis* (Linn.).

Indianapolis, Ind., December 23, 1901. Miss Florence Howe, who reported them says: "This is the only time I have seen the Snowflakes around here. There was a flock of about one hundred. The day was very snowy and the wind blowing. I stayed watching them for an hour or more and then they flew away."

Double-crested Cormorant. *Phalacrocorax auritus auritus* (Swains.).

A bird of this species was taken at Wawaka, Ind., October 24, 1912, according to Mr. O. A. Renahan, who has the skin in his possession.

Pileated Woodpecker. *Phlæotomus pileatus pileatus* (Linn.).

Mr. Philip Baker reports seeing one near Helmsburg, Brown County, Indiana, May 5, 1911.

Passenger Pigeon. *Ectopistes migratorius* (Linn.).

The Passenger Pigeon is probably now extinct. Many of us remember it as the Wild Pigeon of our childhood. Our parents told of the wonderful flights they had seen; of the enormous number which no one could count or approximately estimate; of roosts covering many square miles of woodland when the birds settled upon the trees in such numbers that great

limbs were broken by their weight. All these countless numbers of wild pigeons have disappeared, and notwithstanding hundreds of dollars have been offered for evidence of the occurrence or nesting of these birds in recent years, no authentic report has been received. Specifically, it may be said a reward of \$1,500 for knowledge of a nesting pair of Wild Pigeons was recently made by members of the National Association of Audubon Societies. The reward stood for two years closing December 1, 1911, and no one came forward to claim the prize.

In view of these facts it is appropriate to refer to the last reports of the occurrence of the Passenger Pigeon in Indiana, some of which have been previously printed.

Franklin County, near Oak Forest, July 13, 1898, nesting. October 23, 1898, seen. July 10, 1899, noted. May 18, 1906. July 13, 1906, several seen and reported nesting.

A bird of this species was taken in Shelby County, September 24, 1898, and was mounted and preserved. I have seen this specimen.

Other Indiana specimens of the Passenger Pigeon known to me are as follows:

One of two found dead in winter in the woods near Brookville, Ind., is still in the collection of the writer. The other was presented to a museum in Europe.

My information is there is a specimen now in Richmond, Ind., obtained by Albert Stauber in September, 1872; also another in the collection of Earlham College, obtained by John B. Dougan in the fall of 1873. Mr. Walter S. Ratliff says these were obtained at the great pigeon roost in Center Township, Wayne County, three miles west of Richmond.

The last verified record for this State is from Franklin County. Two birds were seen, and one was shot, near Laurel, April 3, 1902. The specimen taken was submitted to the writer for verification and was returned to Mr. C. K. Muchmore, the owner, at Laurel.

Hermit Thrush. *Turdus aonalaschkoe pallasii* (Cab.).

Mr. C. H. Smith reports one at New Castle, Ind., November 10, 1912.

Mr. Philip Baker took a bird of this species near Helmsburg, Brown County, Ind., January 9, 1911. He sent me the wings and tail for verification.

Ardea herodias wardi. Ridgway.

In his paper "A Revision of the forms of the Great Blue Heron

(*Ardea herodias* Linnaeus)¹ Mr. Harry C. Oberholser classes the birds that have been found breeding in the lower Wabash Valley under this form. He gives measurements of six specimens taken by Mr. Robert Ridgway at "Cypress Swamp near mouth of White River, southwestern Knox County, Ind." The breeding range of the typical form, *Ardea herodias* Linn., he gives as from Central Indiana northward.

¹ Proc. U. S. Nat. Mus., Vol. 43, pp. 531-559.

FURTHER NOTES ON THE SEEDLESS FRUITS OF THE COMMON
PERSIMMON—*Diospyros virginiana* L.

D. M. MOTTIER.

Persimmon trees grow in two different locations on the campus of Indiana University. All of these are pistillate. One group of trees stands near the center of the quadrangle, surrounded on all sides by large and small forest trees, chiefly of maple, elm and beech. Another tree grows at the edge of the grounds near a street. Other persimmon trees, both staminate and pistillate, occur in the town, the nearest being two blocks distant.

This year the tree near the street bore heavily, all the fruits being fine, large berries with seeds. The trees near the center of the quadrangle bore fruits, but in smaller quantities per tree. These fruits were smaller, ripening naturally later and containing, as a rule, fewer seeds per berry. Moreover, there were a number of purely seedless fruits. The proportion of fruits with only one or two seeds was much greater than in the case of the former tree. Seedless fruits and these with only one or two seeds are, as a rule, much smaller than those having several seeds.

According to experiments thus far carried out the seedless fruits of the common persimmon are due to a lack of pollination or, at least, of fertilization, and the seedless berries, which have the same flavor as those with seeds, represent cases of parthenocarpy. The trees near the center of the quadrangle, being surrounded by other trees, are doubtless less readily found by bees. The trees out on the farms in this county which bear seedless fruits in noticeable quantities are usually those that are some distance from staminate trees. To my knowledge there is no seedless strain of the common persimmon in Indiana.

An attempt to ripen the fruit artificially was successful. The method used is an exceedingly simple one, and consists in enclosing the fruits in Mason jars and allowing them to remain in a cool place in the basement, for from ten days to two weeks. The lids of the jars were screwed on without rubbers.

The fruits were taken from the trees soon after the leaves had begun to fall. The berries were fully developed, with very firm flesh, and astringent beyond description. When taken from the jars at the expira-

tion of the time mentioned, the fruits were soft, juicy and without a trace of astringency.

According to Lloyd (*Science*, N. S., 34: 924-928, 1911) the ripening is brought about or hastened by the action of carbon dioxide, produced, of course, by the fruits themselves in respiration.

THE MOSSES OF MONROE COUNTY.

BY F. L. PICKETT AND MILDRED NOTHNAGEL.

The only lists of Indiana mosses the writer has been able to find are as follows: A list of 69 species reported from Jefferson County by A. H. Young in 1876, and published in the *Botanical Gazette* of that date; a list of 13 species reported by W. S. Blatchley in March, 1887, and included in a thesis listing the plants of Monroe County under that date; a list of 49 species reported by L. M. Underwood in the *Proc. Ind. Acad. Sci.* for 1893; a list of 9 species reported by Guy Wilson from Hamilton County in the *Proc. Ind. Acad. Sci.* for 1894. Because of the meagerness of some of these lists and the changes in classification resulting from careful study of mosses since the publication of the first of these lists, there seems to be room for a new check list of Indiana mosses. As a beginning of such a list the present report is presented.

Early in 1911 a small collection of mosses maturing their spores in spring and early summer was made. A fuller collection of forms fruiting in fall and early winter was made in 1912. The material of this later collection has been carefully identified, and that of the earlier collection reidentified, altogether making a list of 51 species and 3 varieties from 34 genera and 12 families. With the exception of forms easily determined, only fruiting forms have been considered. The list as given includes but five sterile forms.

In every case herbarium preparations have been made. These are of two kinds. Fresh specimens of individual plants and of small typical groups were taken from a moist chamber and quickly dried under a pressure of 100 pounds to 150 pounds and then glued to cards for preservation in envelopes on herbarium sheets. Other specimens were allowed to dry without pressure in mats or tufts as they grew, and then kept in cardboard trays. The latter specimens are of special value as material for future comparison and to show the habit of the dried plants. Notes of time and place of collection, of substrata, appearance of the sporophyte at the time of collection, appearance of plants under normal conditions, and any peculiarities due to season and variation from type are recorded. Important observations touching these points are given under each species

in the list. Only Monroe County mosses are included in the present report, but it is hoped that there will be time and opportunity to later extend the list to include at least all the common mosses of Indiana.

In general it may be said that the past season has been unusually favorable for the growth and development of mosses, and as a result it has been possible to collect some very interesting forms. Among these should be mentioned *Anomodon attenuatus* with regularly pinnate to plumose habit due to strong secondary growth from lateral buds, the formation in fall of a second crop of spores by such spring fruiting forms as *Campyllum chrysophyllum*, *Funaria flavicans*, *F. hygrometrica* and *Weisia viridula*, and the presence of a fairly abundant supply of spore cases on such rare-fruited forms as *Leucobryum glaucum*, *Plagiothecium deplanatum* and *Thuidium delicatulum*.

The work of identifying mosses is tedious and time consuming, and in the main requires much careful observation with the use of a good compound microscope. The writer has found that only after the collector is quite well acquainted with group characters can he do any satisfactory work without a good microscope. The most helpful work on classification is A. J. Grout's "Mosses with a Hand-lens and Microscope," with its usable keys, distinctive descriptions and splendid illustrations. The older manual of Lesquersux and James is often of value for descriptions of varieties and of rarer forms not described in Grout's work. In preparing the list the arrangement and nomenclature of Grout have been used. Specially difficult specimens have been referred to Dr. Grout for identification, and his name appears in connection with such.

Order BRYALES.

Suborder NEMADONTEÆ.

Family *Polytrichaceæ*.

Catharina undulata (L.) W. & M. (37, 64). Mature spore cases October 27.

Common along shady roadsides and in light woods, on clay.

Pogonatum brevicaulis (Brid.) Beauv. (10). Mature capsules September 15.

On damp clay banks. Common.

Polytrichum commune L. (47). Spores in April.

On shady hillsides. Common.

P. ohioense R. & C. Spores in April.

On shady hillsides. This is the form usually met with in the neigh-

borhood of Bloomington, and is distinguished from *P. commune* by its longer and usually darker capsule.

P. piliferum Schreb (23). Sterile forms only.

On dry clay hillside in woods 3 miles northeast of Bloomington. Not common.

Suborder ARTHRODONTÆÆ.

Family *Fissidentacea*.

Fissidens bryoides (L.) Hedw. (44, 56). Mature capsules in November.

On damp rocks (limestone) in well shaded ravines. Common but easily overlooked because of minute size (3-5mm.).

F. cristatus Wils. (67). Mature capsules November 9. Determined by Dr. Grout.

This form usually matures spores in summer. Found in dense, dark green mats on quite damp soil in woods 5 miles southeast of Bloomington. Not common.

F. incurvus var. *minutulus*. Austin (45). Mature capsules November 9.

On damp limestone in same places and mingled with *F. bryoides*.

Family *Dicranacea*.

Dicranella heteromalla (L.) Schimp. (41). Mature capsules in November.

In small tufts with *Leucobryum glaucum* on dry hillside 6 miles southeast of Bloomington. Rare.

D. varia (Hedw.) Schimp. (30). Mature capsules in October.

In small, dense tufts on clay and cinder piles. Common.

Dicranum scoparium (L.) Hedw. (19, 65). Mature capsules September and October.

On soil and damp decayed wood in shady hillside woods. Common.

Leucobryum glaucum (L.) Schimp. (21). Mature capsules in October.

On shady clay bank at head of Huckleberry Ravine. The only fruiting specimen known to have been found in Monroe County was found by Miss Nothnagel as above stated on October 4.

Family *Tortulaceæ*.

Barbula unguiculata (Huds.) Hedw. (53). Mature capsules in November.

On shaded clay banks along roadside. Common.

B. unguiculata var. *obtusifolia* (Schultz.) B. & S. (29). Mature capsules in October. In crevices of walls of limestone quarry of Oölitic Stone Mills Company. Uncommon.

Didymodon rubellus (Hoffm.) B. & S. (63). Mature capsules in December.

On clay and stone near warm water near condensing tank of I. U. power house.

Weisia viridula (L.) Hedw. (28). Mature capsules April, 1911, also in October, 1912.

On thin clay soil over stone and in sunny pastures. Common.

Family *Orthotrichaceæ*.

Orthotrichum porteri Aust. (3). Mature capsules April, 1911.

This rare moss has been found freely fruiting and in considerable quantity on the limestone bordering the main stream feeding the I. U. Water-works pond.

Family *Funariaceæ*.

Funaria flavicans Mx. (32). Mature capsules in October.

On stone waste at quarry of Oölitic Stone Mills Company. This was probably a second growth specimen, as this species usually fruits in spring. Not common.

F. hygrometrica (L.) Sibth. (12). Mature capsules September 28.

On clay bank in Lively's woods. This form usually fruits in spring.

Physcomitrium immersum Sulliv. Mature capsules summer and autumn.

Very common on pots in greenhouse and on clay in fields.

P. turbinatum (Mx.) Brid. (4). Mature spores in spring and early summer.

Very common in lawns and pastures or old stubble fields.

Family *Aulocomniaceæ*.

Aulocomnium heterostichum (Hedw.) B. & S. (8, 13). Mature capsules May, 1911.

On damp humus between rocks, shady bank. Occasional.

Family *Bartramiaceæ*.

Bartramia pomiformis (L.) Hedw. (1, 66). Mature capsules in May.

In bright, yellowish green cushions on moist, shady banks. Common.

Family *Bryaceæ*.

Bryum argenteum L. (11). Mature capsules in September.

Very common on yellow clay. This is the small moss usually found in small silvery cushions between the bricks of sidewalks.

B. capillare L. (55).

Only one specimen found and that showing empty capsules November 22, 1912. Among lichens on damp clay bank "Huckleberry" Ravine. Rare.

Mnium affine ciliare (Grev.) C. M. (57). Mature capsules in March and April.

Large spreading mats on rotten wood in shady, damp places. Common.
M. cuspidatum (L.) Leyss. (36, 69). Mature capsules in April.

On damp, decaying wood in shade. Common.

Rhodobryum roseum (Weis.) Limpr. (60). Sterile.

On damp rotten wood and on damp soil. Occasional.

Pohlia nutans (Schreb.) Lindb. (5). Mature capsules in May.

On damp, shady clay bank, Griffy Creek. Uncommon.

Family *Leskeaceae*.

Anomodon attenuatus (Schreb.) Huebn. (52). Mature capsules in November.

In close mats on damp rocks and rotten wood. This was found fruiting plentifully although reported as rarely fruiting. Some beautiful regularly pinnate specimens were found.

A. rostratus (Hedw.) Schimp. (14). Mature capsules in October.

Coarse, green, velvety mats at base of trees. Common. Determined by Dr. Grout.

Thuidium delicatulum (L.) Mitt. (27, 50). Mature capsules in October.

Although this species does not commonly fruit, several collections of fruiting plants were made this season. This, in sterile form is quite abundant, forming wide-spreading mats of beautiful fernlike branches on damp, rotten logs.

T. pygmaeum Br. & Sch. (62). Mature capsules in November.

Found in but one place, but quite plentiful there. In mouth of cave on stone and clay, one and one-half miles north of Bloomington.

Thelia hirtella (Hedw.) Sulliv. (49, 61). Mature capsules in November.

On bark of dead and decaying logs in dry shaded places. Occasional.

Family *Hypnaceae*.

Amblystegium riparium B. & S. (51). Sterile form only.

Attached to stones and soil in shallow running water above I. U. Water-works.

Brachythecium oxycladon (Brid.) B. & S. (15, 39). Mature capsules in October and November.

On damp stones and rotten wood. Common.

B. plumosum (Sw.) B. & S. (16, 38). Mature capsules in November.

Thin spreading mats closely applied to damp rocks and clay.

B. rutabulum (L.) B. & S. (17). Mature capsules in November.

On wet rocks and soil.

- B. salebrosum* (Hoffm.) Br. & Sch. (54). Mature capsules in November.
On wet, rotten wood, Griffy Creek, shady bank.
- B. starkei* (Brid.) B. & S. (40). Mature capsules in November.
In shady ravine on damp decayed wood with *B. salebrosum*.
- Campylium chrysophyllum* (Brid.) Bryhn. (18). Mature capsules in October, although this species is supposed to mature its spores in early summer.
On damp clay-covered rocks in shady ravines. Common. Determined by Dr. Grout.
- Climacium americanum* Brid. (34). Sterile only.
One dry soil in shaded places. Occasional.
- Entodon cladorrhizans* (Hedw.) C. M. (31, 42). Mature capsules October.
On damp decaying logs in shade. Common.
- E. seductrix*. (Hedw.) C. M. (35). Mature capsules in October.
In close mats on dry, shaded rotten logs North Pike.
- Eurhynchium serrulatum* (Hedw.) Kindb. (43). Mature capsules empty in November.
In shady ravine on damp rotten log, near Jackson Creek.
- Hymnum curvifolium* Hedw. (2). Mature capsules in April.
On damp underbrush and decayed wood, shade, near water. Huckleberry Ravine.
- H. imponens* Hedw. (46). Mature capsules in November.
In shady ravine on damp decayed wood 6 miles east of Bloomington.
- Plagiothecium deplanatum* (Sch.) Grout. (22). Mature capsules in October.
This species, usually reported as rarely fruiting, was found with abundance of capsules. On damp soil, Huckleberry Ravine.
- P. geophilum* Aust. (58). Mature capsules in November.
Abundant on rocks in Huckleberry Ravine. Found fruiting plentifully
- Platygerium repens* (Brid.) B. & S. (25, 33, 68). Mature capsules in October.
At base of trees and on dry rotten logs. Common. Determined by Dr. Grout.
- Pylaisia schimperii* R. & C. (7, 24). Mature capsules in October.
On trees, living *Juglans cinerea*, Huckleberry Ravine.
- Raphidostegium carolinianum* (C. M.) J. & S. (26). Mature capsules in October.
On damp rocks in ravine. Common.

R. carolinianum var. **admixtum** Sulliv. (48, 59). Mature capsules in October.

On rocks on dry hillsides. Occasional.

Family *Leucodontaceae*.

Leucodon julaceus (Hedw.) Sulliv. (6). Sterile only.

On bark of living trees, Huckleberry Ravine.

NOTE.—The numbers given after the species are the numbers of the specimens as arranged and left in Indiana University herbarium.

I. U. Botanical Laboratory.

LENGTH OF LIFE OF *ARISAEMA TRIPHYLLUM* CORMS.

BY F. L. PICKETT.

In the summer of 1908 the writer's attention was called to the similarity in the number of growth periods of *A. triphyllum* corms coming from plants that must have been of widely different ages. Three years' observation of mature plants in the field and garden as well as a study of seedlings has led to the conclusion that the corm has a fairly well fixed life period.

The underground stem or corm of *A. triphyllum* is an irregular, flattened, oval body composed of an inner starch bearing parenchyma mass, traversed here and there by vascular strands, covered with a thin layer of brown, scurfy cork, and surmounted by a conical bud. The lower side is flattened, much wrinkled and often bears patches of loose, disorganizing cork tissue. The bud at the top is rather large—in mature plants measuring from 8.25mm. through the base—and contains the leaves and flowers for a succeeding year's growth inclosed completely by closely convolute, thick, fleshy scales. This bud is formed in late spring, within the petiole or petioles of the aerial leaves, but is left exposed by their decay. The roots grow out from the base of the bud scales and so are quite near the outside of the petiole bases.

The falling away of leaves and roots at the end of the growing season leaves a scar, marked by a depression in which the traces of vascular bundles are clearly visible, and extending entirely around that part of the corm just newly formed below the petiole bases. This large scar is a readily usable guide in counting the number of annual growth periods in a given corm. The number of growth periods may also be determined through the following facts. Vigorous plants usually form one or more lateral buds of varying size at the base of the petioles each year. These buds are carried down, with very little change in size or appearance, by the growth of each succeeding year, and so form a record. The interesting fact has been observed, that after a corm has reached four growth periods, its size seems to have nothing to do with the number of such periods, and that mature plants under observation for three years show the same number of record scars as at the beginning of the observation period. It has

also been observed that the lateral buds remain dormant until detached from the parent corm, and that four year old buds at the end of their fourth season are attached not to the corm but to the disorganizing cork fragments at its base.

An examination of the internal structure of mature corms at different times in a growing season shows the following features. At the beginning of growth in March the starch-filled parenchyma is a homogenous mass. When the flowers and leaves are just above ground a lower region of the parenchyma, corresponding to the four year old portion, shows signs of softening, becoming more translucent and containing less starch. As the season progresses this condition of change increases until at or soon after the time of fertilization of the flowers, there is little but disorganized parenchyma and scattered vascular strands in the oldest portion. Examination with the microscope at this time will show that a complete separatory layer of phellogen has been formed so as to extend between the three and four year old portions, cutting off the older and protecting the younger with a layer of cork cells.

The formation and growth of *A. triphyllum* corms is greatly influenced by food and climate. The variation in size of mature corms may very probably be the direct result of these influences. Certain it is that some corms lie dormant one year or longer and then grow vigorously. Then again conditions might require an extra amount of reserve food for the perfection of fruit in some unfavorable season and so shorten the time of some growth zones. In the majority of cases, barring very unusual conditions, regardless of the number of years since the germination of the seeds from which they sprung or since their separation as lateral buds from mature corms, the underground stems of *A. triphyllum* are four years old.

ACETIC ALCOHOL AS A KILLING AND FIXING AGENT IN PLANT HISTOLOGY.

BY F. L. PICKETT.

The writer has found a solution of 5-8% of glacial acetic acid in absolute alcohol a splendid killing and fixing agent in preparing histological material. For the best results the alcohol should be heated to its boiling point on the water bath before the addition of the acid and specimens. For large pieces of stems with well developed wood, the fixing agent is prepared in a flask and is allowed to boil after the specimens have been placed in it. Tight corking of the flask and immediate cooling causes the withdrawal of air from vessels and spaces and allows immediate penetration of the reagent. The acid should be washed out with three or four changes of alcohol and then the specimens imbedded in paraffin in the usual manner. Hard specimens should be washed in alcohol and then be placed in a mixture of three parts 80% alcohol and one part glycerine for preservation.

This solution has been used successfully with leaves, rust, stems, embryos in situ. It has the advantage over alcohol alone of causing less shrinking and of fixing cell contents quite well enough for this line of work. Specimens are not discolored by precipitates, as is often the case with chromic acid mixtures; and much time is saved by the elimination of long washing in water and dehydration before imbedding.

PLANTS NOT HITHERTO REPORTED FROM INDIANA.

BY CHAS. C. DEAM.

The following species are new to the flora of Indiana. The grasses and species of *Crataegus* were determined by the Department of Agriculture Washington, D. C.; the grasses by Agnes Chase, and the *Crataegi* by W. W. Eggleston. Duplicates of all of the species are deposited in the herbarium of that department. The *Carices* were determined by K. K. Mackenzie who retained duplicates for his herbarium. Other determinations are credited to the proper authorities.

Panicum Boscii molle H. & C.

Greene County, May 26, 1912. No. 10,676. In a woods about 1 mile southeast of Bushrod.

Panicum stipitatum Nash.

Washington County, August 16, 1912. No. 12,090. Abundant on the slopes of the bank and riffles of a very small creek, coursing through a cultivated field on the south side of the Henryville road about five miles east of Norris.

Calamagrostis cinnoides (Muhl.) Barton.

Marshall County, July 2, 1911. No. 9,014. In a ditch on the west side of the right of way of the railroad, about two miles south of Culver.

Poa Chapmaniana Scribn.

Clark County, May 8, 1912. No. 10,486. On the sterile wooded slope of the ravine just north of Tract 28 on the Forest Reserve.

Bromus inermis Leyss.

Howard County, July 12, 1912. No. 11,663. Abundant along the right of way of the Lake Erie Railroad for half a mile south of Dyer's Stop on the traction line, and along the roadside east of Dyer's Stop. It forms complete stands and is crowding out the blue grass along the railroad and roadside. The indications are that it may become a pernicious weed.

Flimbristylis Frankii Steud.

Laporte County, August 13, 1911. No. 9,590. On the sandy shore of
6-33213

Pine Lake near Laporte. Associated with *Hemicarpha micrantha*, *Scirpus Smithii* and *Juncus pelocarpus*. Determined by H. H. Bartlett.

Scirpus pedicellatus Fernald.

Brown County, October 15, 1911. No. 10,313. On the top of a hill along Bean Blossom Creek about one-half mile south of Trevlac, in a small depression in a beech woods. Determined by H. H. Bartlett.

Carex abscondita Mack. (*Carex ptychocarpa* Steud.)

Crawford County, May 26, 1911. No. 8,463. In a beech woods one-half mile north of English. Jennings County, June 23, 1912. No. 11,305. In a beech woods along the north fork of the Muscatatuck River about one-half mile above Vernon.

Carex Bebbii Olney.

Noble County, June 20, 1910. No. 6,723. In a swamp about one-half mile northwest of Rome City.

Carex caroliniana Schwein. (*Carex triceps Smithii* Porter).

Greene County, May 26, 1912. No. 10,726. In a moist woods one-mile north of Bushrod. Jackson County, June 6, 1911. No. 8,585. In a woods one-fourth mile south of Chestnut Ridge. Posey County, May 23, 1911. No. 8,304. On the wooded bank of the cypress pond near Bone bank along the Wabash River.

Carex chordorrhiza L. f.

Kosciusko County, June 5, 1912. No. 10,928. Growing in sphagnum moss in a tamarack swamp one mile south of Leesburg.

Carex Emoryi Dewey.

Hamilton County, May 19, 1912. No. 10,548. Collected by Mrs. Chas. C. Deam in a swamp about one-half mile northeast of Carmel.

Carex lacri-vaginata (Kuken) Mack. (*Carex stipitata lacri-vaginata* Kuken).

Decatur County, May 26, 1912. No. 10,738. Collected by Mrs. Chas. C. Deam in a wooded ravine along Flat Rock River about one-half mile above St. Paul. Hendricks County, June 1, 1912. No. 10,881. Collected by Mrs. Chas. C. Deam in a wooded creek bottom along Little Walnut Creek about two miles south of North Salem.

Carex prairiea Dewey. (*Carex diandra ramosa* (Boott) Fernald).

Noble County, June 20, 1910. No. 6,718. In a peat bog about one-fourth mile northwest of Rome City.

Dianthus Armeria L.

Brown County, June 16, 1912. No. 11,180. Roadside and pasture field about three-fourths mile south of Helmsburg. Well established in this place. Dubois County, July 6, 1912. No. 11,615. Roadside and an open woods about three-fourths mile east of Birdseye. Frequent in this locality. Reported by Dr. J. Schneck, in the Lower Wabash Valley.

Crataegus collina Chapman.

Dearborn County, September 21, 1912. No. 12,249. Bank of Laughery Creek about three miles west of Aurora.

Crataegus intricata Lange.

Vermillion County, September 29, 1912. No. 12,492. Bank of a wooded ravine about four miles west of Hillsdale.

Crataegus straminea Beadle.

Brown County, August 25, 1912. No. 12,214. Sterile wooded slope of a wooded ravine about one and half miles east of Helmsburg. Clark County, August 30, 1912. No. 12,253. A shrub about five feet high, on the Forest Reserve.

Potentilla arguta Pursh.

Jasper County, July 30, 1912. No. 11,801. Roadside about four miles west of Remington. Benton County, July 31, 1912. No. 11,819. Roadside about four miles northwest of Fowler. Frequent along roadside ditches in these counties.

Lespedeza Stuevei Nutt.

Posey County, September 18, 1911. No. 10,104. In sandy soil on the slope of a cut of the road through the woods, which is located near the Wabash River and about three miles south of New Harmony. Determined by K. K. Mackenzie.

Vitis rotundifolia Michx.

This species was erroneously credited to Indiana in last year's proceedings, and the citations should be referred to *Cissus Ampelopsis* Pers.

Vaccinium arboreum Marsh.

Martin County, June 30, 1912. No. 11,373. On top of the wooded sand stone cliffs of White River about two miles above Shoals. Determined by C. S. Sargent.

Bumelia lycioides (L.) Pers.

Perry County, July 4, 1912. No. 11,507. A shrub about eight feet

high. About three miles east of Cannelton at the base of the river bluffs and near the public road. Duplicate in herb. New York Botanical Gardens.

Mentha gentilis L.

Decatur County, August 13, 1911. No. 9,533a. Collected in the large stone quarry near St. Paul by Mrs. Chas. C. Deam. Determined by B. L. Robinson.

Viburnum Canbyi Rehder.

Clark County, September 24, 1910. No. 7,580. Frequent on or near the banks of some of the small creeks on the Forest Reserve. Ripley County, May 19, 1912. No. 10,558. Wooded bank of creek about one mile west of Morris. Jennings County, August 13, 1912. No. 12,030. Bank of roadside ditch about four miles northeast of Scipio. Brown County, June 16, 1912. No. 11,148. At the base of a wooded ravine about two miles east of Helmsburg. Determined by C. S. Sargent. It is believed that all references to *Viburnum molle* in Indiana should be referred to this species.

Bluffton, Indiana.

THE INFLUENCE OF CERTAIN ENVIRONIC FACTORS ON THE DEVELOPMENT OF FERN PROTHALLIA.

DAVID M. MOTTIER.

[Abstract.]

Spores of the following ferns were used in the experiments: *Onoclea struthiopteris* (L.) Hoffm. *Dryopteris stipularis* (Willd) Maxon and "Nephrodium molle."

Prothallia of *O. struthiopteris* which had developed numerous antheridia, but which were much too small to bear archegonia, were transplanted to separate dishes and allowed to grow under favorable conditions. Some of these developed into large prothallia and bore archegonia. The fact that female prothallia of this fern, if kept growing for some time without the fertilization of any of the egg-cells, may develop antheridia, has already been recorded in an earlier publication (Mottier, Bot. Gaz., 50; 209-213, 1910).

Spores of all of the above named species were found to germinate poorly, or not at all, if the cultures were kept in direct sunlight in the greenhouse from the time of sowing. In cultures in which prothallia developed, nearly all plants were small and bore only antheridia, a very few only becoming large enough to produce archegonia.

Three cultures, A, B, and C, of *Onoclea struthiopteris* were sown April 9, 1911. They were placed in a position to receive direct sunlight, but during the brighter hours of the day cheese cloth was placed over the bell jars under which the cultures were kept, to diminish somewhat the intensity of illumination. On April 30 all three cultures seemed to have made a favorable beginning, the majority of the prothallia being heart-shaped but not large enough to bear archegonia. A and B were now placed in a position in the greenhouse to receive good diffused light, but no direct sunlight save for only a short time in the early morning. Culture C was left in the original position of direct sunlight except the protection given by the cheese cloth from about 9:30 a. m. to 3:00 p. m. during days of bright sun. A and B developed into fine cultures, while in C nearly all plants remained small, bearing antheridia only.

All cultures were grown in earthen saucers upon earth which had been previously sterilized in a steam sterilizer. They were watered by means of sub-irrigation.

REPORT OF THE WORK IN CORN POLLINATION, IV.

BY M. L. FISHER.

A series of studies in corn pollination was begun in 1908. The results of these experiments have been reported from time to time. The present report will deal with the Sweet-Reid's Yellow Dent cross.

In 1911 the two types which arose from this cross were planted, but conditions were such that only enough for seed was obtained. There was no chance to determine the quality. In 1912 the two types were again planted. Only a small area of ground was available and it was necessary to resort to self-pollination again.

The germination from both types proved good and the plants grew vigorously. The light-colored type was the more vigorous of the two and produced a larger proportion of ears.

When the ears were in proper condition samples were taken for cooking and testing as to quality. The light colored type had large ears, white in color. Upon cooking the flavor was found to be excellent, being very sweet. The sweet flavor combined with a long grain makes this a very desirable type. The cooking test showed it to be superior to the corn bought on the market in West Lafayette.

The yellow type had a medium sized ear, creamy white in color and when cooked had also an excellent, sweet flavor. The flavor was considered not quite so good as that of the light colored type.

At maturity the light colored type showed itself quite true to type, having whitish kernels, red cobs, and large size. There were few yellow dent kernels, probably no more than due to cross-pollination from adjoining plats.

The yellowish type had smaller ears, mostly white cobs, yellowish kernels, and a larger proportion of yellow dent kernels than the other type. The yellowish type does not have the depth of kernel that the whitish type possesses.

The crop season of 1913 will be the final test for this experiment. The result of this season will determine whether the new types are worthy of extensive propagation.

Purdue University.

CONJUGATION IN SPIROGYRA.

BY F. M. ANDREWS.

A large quantity of *Spirogyra crassa* and *Spirogyra communis* were found in September in a pond and upon examining it both forms were found to be conjugating. Not only was the species *Spirogyra crassa* found conjugating together, but sometimes *Spirogyra crassa* was found conjugating with *Spirogyra communis*. The smaller one of the two filaments in Fig. 1 is *Spirogyra communis* and the larger one *Spirogyra crassa*. The contents of the majority of the cells pass from the larger species to the smaller ones forming a zygospore, and in other cases the contents of most of the cells of *Spirogyra communis* pass into the cells of *Spirogyra crassa*. Some of the forms here shown which had not begun to conjugate began and completed conjugation when brought into the laboratory. In an earlier paper I have called attention to the interesting facts the hybrid forms may show.¹

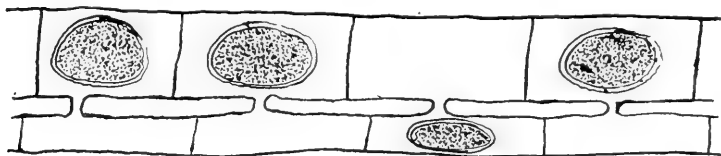

Figure 1.

Generally it is the case that when *Spirogyra* is conjugating the contents of the cells of one filament will all pass over into the cells of the other filament near it, as text-books and authors state. This is by no means always the case as is shown by Fig. 2.² In some cells, as will be seen at A and B, Fig. 2, the contents of the contiguous cells in the same filament go to corresponding contiguous cells in the other filament, but the contents of other cells as C and D, Fig. 2, do not do so, but go in the

¹ Andrews, F. M. Bulletin of the Torrey Botanical Club, Vol. 38, p. 296.

² Bennett and Murray. p. 266.

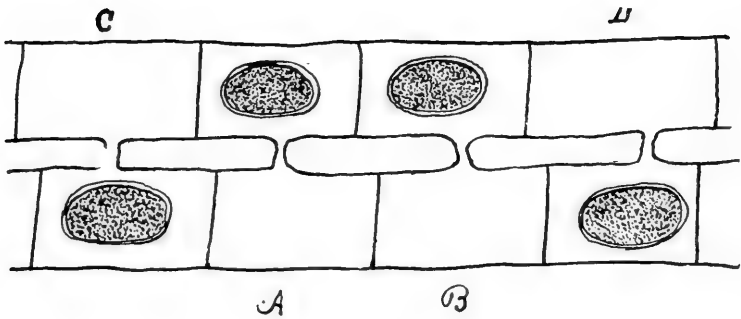

Figure 2.

opposite direction. A case of this kind is also shown by A. Tröndle¹ and in the above mentioned form.

In some other cases, as has been found before, three filaments of *Spirogyra crassa* conjugate with one another² without regularity, as is seen in Fig. 3. Part of the time the contents of the cells move from the filaments A to B, in some cases from B to A and in others from B to C.

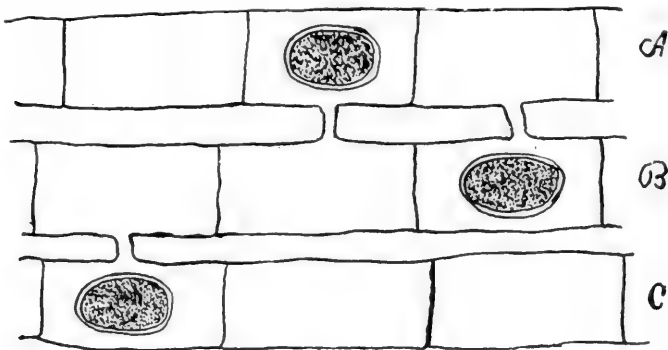

Figure 3.

In another instance in this material three filaments of *Spirogyra crassa* were found connected by conjugating tubes.³ In Fig. 4 the cells of the two outer filaments A and C were in some cases conjugating with the cells of the filament B, and thus forming a single Zygospore from the con-

¹ A. Tröndle—Über die Kopulation und Keimung von *Spirogyra* *Botanische Zeitung*, 1907. Vol. 65, p. 192.

² A. Tröndle l. c.

³ Bennett and Murray, *Cryptogamic Botany*, p. 267.

tents of three cells. In this case the Zygospore is not apparently much larger than where two cells fuse, so that the decrease of turgidity causing the contraction of the protoplast is in this case very great.

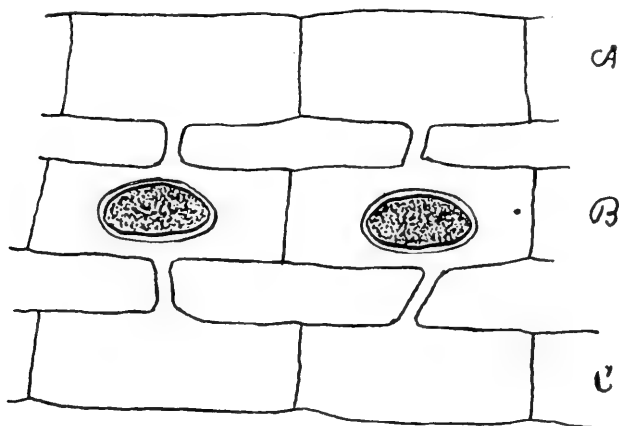

Figure 4.

In still another lot of the specimens, four filaments were found conjugating with one another as in the last case. Most of the cells were conjugating in the usual way, but others conjugated with each other in whatever filaments were near them without regard to regularity. They formed quite a mat of filament.

Some specimens were noticed each of whose cells in conjugating put out two conjugating tubes to the neighboring cell. Only one of these tubes, however, seemed to be completed and to serve as a channel for the transfer of one cell to the other.

AN INSTRUCTIVE MODIFICATION OF AN OLD EXPERIMENT.

 HOWARD J. BANKER.

We have long been familiar with the experiment in photosynthesis of pinning a cork on opposite sides of a green leaf and exposing to the light in order to show that no starch is formed in the leaf where the cork shuts off the action of the sunlight. The experiment, further, has excited no little comment and criticism because of the fact that the cork, tinfoil, or other opaque screen as usually applied not only shuts off the light but also interferes with the interchange of gases through the stomata. This

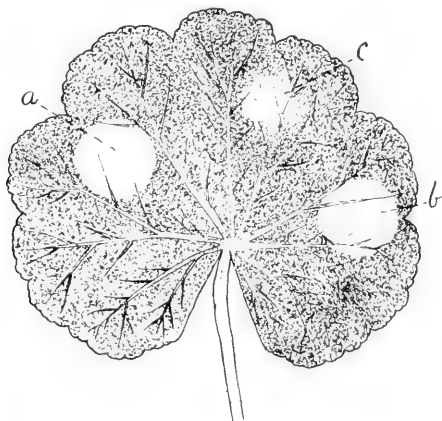

Starch Distribution in Geranium Leaf—*a*. Opaque disks in close contact with leaf, shutting off both light and air;—*b*. Opaque disks with air space shutting off light but not air;—*c*. Glass disks in close contact with leaf shutting off air but not light.

consideration has led to various modifications of the experiment and to the development of some highly accurate and scientifically constructed pieces of normal apparatus to correct the error of the original experiment. So far is this sometimes carried that the construction and adjustment of the apparatus has completely obscured the significance of the experiment. We need, therefore, to get back to first principles, that is, to experimenting upon the plant instead of upon the apparatus.

The following simple modification of this classic experiment will be instructive and will usually set the student to thinking to some purpose. Prepare several round disks from opaque paper or light cardboard. These may be readily made of about the right size with a gunwad cutter. Selecting a broad leaved plant of suitable size, place a pair of the disks one on each side of the leaf opposite each other and in close contact with the surface of the leaf, and fastened in place by a light spring clip, such as is commonly used to fasten loose sheets of paper. Attach another pair of disks in a similar manner but supported from the surface of the leaf by wax feet or other supports so as to allow a free circulation of air between the disks and the leaf. Now select a couple of cover glasses, such as are used in microscopic work, of approximately the same size as the paper disks and attach these in a similar manner so as to be in close contact with the surface of the leaf. The plant is now exposed to the sunlight and after a time the leaf is tested for starch in the usual way with iodine. The result as obtained recently by my own students is shown in the figure.

As is seen the place of the opaque disks is marked by a spot free from starch and bounded by a sharply defined line approximately at the edge of the disk in both cases, showing of how little significance in this form of the experiment is the question whether the stomata are covered or not. On the other hand, the glass disks are marked by only a small spot at the center without starch and the intensity of the starch reaction shades off gradually from the margin toward this central spot so that the boundary of the disk is not evident. It is hardly necessary to add that some care should be exercised in timing the exposure to the sunlight in order to get the most striking results. The phenomena afford a neat little problem for the student to explain. With a little thought most students can do this if they understand clearly the structure of the leaf.

The experiment may be further elaborated with instructive results by selecting leaves with stomata definitely distributed as upon only one side of the leaf and by using the disks, both the glass and opaque, singly instead of in pairs.

*DePauw University,
Greencastle, Ind.*

PHOTOSYNTHESIS IN SUBMERGED LAND PLANTS.

BY HARRY V. HEIMBURGER.

Detmer,¹ in his "Practical Plant Physiology," describes an experiment to show the evolution of oxygen in photosynthesis. He uses for this purpose a water plant which is placed under a glass funnel in a vessel of water and the evolved gas collected in a test tube. The same experiment is described in a number of text-books, mention usually being made that water plants must be used. *Elodea*, *Myriophyllum*, *Ceratophyllum*, *Hippuris*, *Polamogeton*, *Chara* and *Spirogyra* are suggested by various writers. It is to be inferred from most of the texts that no especial difficulty is met in performing this experiment, though a few of the authors consulted mention some difficulties and suggest that the experiment is not always entirely satisfactory. One writer says, "It is better to allow the apparatus to stand several days in the sunlight in order to catch a full tube of the gas."² Another says, "After two or three days of hot sun, enough of the gas can be obtained to make the oxygen test."³ Again we are told, "The glowing of the splinter shows that the gas is oxygen"⁴ intimating that a very pronounced test is not to be expected; though others say that the spark bursts at once into flame.

In one text⁵ the use of watercress in the experiment is recommended. A few of the texts examined, do not say definitely what sort of plants to use, but usually it is implied that water plants are required. In only one text, of those we have been able to examine, is it even intimated that land plants may be used. Doctor Coulter⁶ says, "If an active leaf or a water plant be submerged in a glass vessel, and exposed to the light, bubbles may be seen coming from the leaf surface and rising through the water." The illustration accompanying this text shows what appears to be the leaf of some tree or shrub. In several texts it is expressly emphasized that land plants will not serve for this purpose. Atkinson says,⁷ "Land plants,

¹ Detmer-Moor, Practical Plant Physiology, pp. 35-37.

² Atkinson, College Botany, p. 62.

³ Hunter, Essentials of Biology, p. 126.

⁴ Atkinson, Elementary Botany, p. 51.

⁵ Reynolds Green, Vegetable Physiology, p. 164.

⁶ Coulter, Plant Relations, pp. 29, 30.

⁷ Atkinson, Elementary Botany, p. 51.

however, will not do this when they are immersed in water, but it is necessary to set up rather complicated apparatus."

Doctor Ganong, who may be regarded as an authority in plant physiology, in commenting on this experiment criticises severely the statement that land plants may be used. He says, "An erroneous experiment, given in several text-books, accompanied by a false illustration, is that one in which leaves of land plants placed under water are represented as giving off bubbles of oxygen which rise through the water. It is true that leaves which are enveloped in a film of air do carry on some photosynthesis under water, but the amount is so small that it is doubtful if any visible bubbles of oxygen are released, the tiny quantities being taken directly into solution."

It is the purpose of this paper to show that some land plants do carry on photosynthesis, when submerged in water, and that for purposes of the experiment described above, are even better than the water plants ordinarily used.

In September of 1911 my attention was called to the fact that *Melilotus alba*, when submerged in water, could carry on photosynthesis, with considerable evolution of gas, and that the gas is particularly rich in oxygen. At the suggestion of Professor Howard J. Banker a number of simple preliminary experiments were carried on to test the power both in *Melilotus* and in several other land plants. It was intended that more careful experiments should be performed later to determine the percentage of oxygen in the gas and the rate of the evolution of the oxygen under varying conditions. While this quantitative work has not been done, the results so far obtained are so striking as to appear of interest and worthy of note.

In the experiments as performed, a few leaves of the plant under observation, were placed in the usual manner in a glass funnel which was inverted in a large glass jar full of water. A test tube of 30cc. capacity was used to collect the evolved gas. Carbon dioxide was generated by treating ordinary limestone with hydrochloric acid, and a stream of this gas was kept bubbling through the water outside the funnel. The whole apparatus was exposed to sunlight in a south window.

With *Melilotus alba*, using three or four vigorously growing shoots, having approximately one hundred leaves, from 60 to 80cc. of gas was

¹ Ganong, A Laboratory Course in Plant Physiology, p. 103.

obtained in four hours. This gas was so rich in oxygen that a glowing splinter thrust into the tube burst into flame with an explosive snap. The same leaves were left in the apparatus and on the second day yielded more than 30cc. of gas, giving a good spark test. On the third day, however, the water in the jar showed green and the plants were becoming macerated. Only a very little gas was evolved during this day, the quantity being insufficient for the spark test. With none of the plants used was any gas obtained after the second day, and sometimes only a little on the second day.

Similar tests were made with *Melilotus officinalis*, *Trifolium pratense*, *Trifolium repens*, *Lactuca canadensis*, *Arctium minus* and *Nepeta cataria*. With all these plants a good evolution of gas was obtained, at least during the first day. *Lactuca* and *Arctium* evolved very little gas during the second day and both showed considerable maceration after sixteen to twenty hours in the apparatus. With *Nepeta* the evolution of gas appeared to be more rapid than in *Melilotus*, though this might have been due to difference in light intensity or because of a greater leaf surface being exposed. No accurate measurements of leaf surface were made in any of the tests, but approximately the same leaf area was used in each case. In all the plants used, except *Nepeta*, there was less gas evolved than with *Melilotus*, but in every case there was a free evolution of the gas and not at all the tiny quantities that Doctor Ganong suggests. In all cases, too, the gas gave a very good spark test, showing it to be very rich in oxygen.

It will be noted that all the plants named above, have either a hairy or waxy covering to the leaves so that they do not become wet when immersed in water but are really enclosed in a thin film of air. When exposed to bright sun this film grows thicker and thicker until it becomes a bubble of considerable size. After a time a portion of the bubble breaks off and rises through the water into the test tube, this process continuing while the plant is in bright sunlight.

In the case of *Nepeta* and *Arctium* there are a number of minute bubbles formed on the surface of the leaf, these being more numerous and forming more rapidly on the under side. These bubbles increase in size, merging together to form large bubbles until they become so large that portions break off and escape into the tube. With *Melilotus*, *Trifolium* and *Lactuca* the film of air seems continuous and becomes a large bubble which practically encloses the leaf. The bubbles which rise into the test

tube are large, there being no streams of tiny bubbles as in the case of the water plants.

The rate of the evolution of the gas depends on the brightness of the light and the supply of carbon dioxide. If a part of the light is shut off the rate becomes slower and the evolution of gas ceases when the light becomes dim. The rate becomes slower if the bubbling of carbon dioxide through the water is stopped. Enough carbon dioxide diffuses into the water from the air for the evolution of gas to go on slowly, but a rapid evolution is not obtained unless the water is kept charged with the carbon dioxide.

In one experiment leaves of *Melilotus* were dipped for an instant into 50% alcohol and then immediately immersed in water. These leaves became wet, no film of air was present and no evolution of gas occurred though the plants were exposed to the sunlight for more than six hours.

These experiments were performed in May of 1912, after which time nothing further was done except that in October *Melilotus* and *Nepeta* were used in demonstration experiments before a class. A good quantity of gas was obtained. The rate of evolution was slower than in May, probably due in part to difference in light and part to difference in the condition of the plants. The plants used in May were young vigorous shoots, while only old plants could be found in October.

As a plant to use in demonstrating the evolution of oxygen in photosynthesis, I am quite sure that either *Melilotus* or *Nepeta* will prove entirely satisfactory. They are not only much easier to obtain than the aquatic plants, which are said to be necessary for this experiment, but the results are more quickly attained and are more striking than is usually the case with the conventional aquatics used for this purpose.

DePauw University,

Greencastle, Ind.

INDIANA FUNGI—III.

 J. M. VAN HOOK.

The season 1912 was one disappointing to the student of fleshy fungi in this region. The usual summer and fall study of this group had to be given up almost entirely. On the other hand, we obtained a very large number of parasitic species. Only a few of these have as yet been classified.

Some of the common economic parasitic species have appeared in this neighborhood this year as unusually destructive. The blight of tomatoes (*Septoria lycopersici*), has been severe, as have both the *Septoria* and *Gloeosporium* blights of gooseberry and currants. These bushes have, in many cases, been completely defoliated, in July and August and aside from a few leaves at the tip, very little development followed. Oat smut was generally prevalent and the crop loss large in the southern counties.

Lactarius indigo was found for the first time and in a location carefully hunted over for the last six years.

The following is a list of those classified during the past year and not heretofore reported:

USTILAGINEÆ.

Ustilago avenae (Pers.) Jens. Bloomington, Monroe County. (Date unknown.) 3438.

Ustilago tritici (Pers.) Rostr. On wheat, Monroe County, June 1912. Bourke. 3437.

UREDINEÆ.

Uromyces caryophyllinus (Schrank.) Winter. On living leaves of carnation, Monroe County, February 8, 1912. J. M. V. 3273.

Melampsora farinosa (Pers.) Schroet. On living leaves of *Salix nigra*, Brown County, August 25, 1908. J. M. V. 3270.

CLAVARIACEÆ.

Clavaria vermicularis Scop. On ground, woods, Monroe County, July 18, 1912. J. M. V. 3419.

Lachnocladium micheneri B. & C. On dead leaves in woods, Monroe County, July 19, 1912. J. M. V. 3416.

HYDNACEÆ.

Irpex fuscescens (Schw.) On oak limb, woods, Monroe County, July 19, 1912. J. M. V. 3416.

AGARICACEÆ.

Cortinarius lilacinus Pk. Ground, woods, Griffey Creek hills, Monroe County, July 12, 1912. J. M. V. 3410.

Cortinarius sanguineus Fr. Ground, woods, Griffey Creek hills, Monroe County, July 18, 1912. J. M. V. 3426.

Lactarius hygrophoroides B. & C. Ground, Trevalac, Brown County, July 20, 1912. J. M. V. 3430. (The stems of some of these plants attain a length of two and one-half inches and a thickness of seven-eighths inch, while the pileus is often four inches across.)

Lactarius indigo (Schw.) Fr. On ground, top of Hemlock Bluff, Trevalac, Brown County, July 20, 1912. J. M. V. 3427.

Lentinus suavissimus Fr. On twig of maple, Huckleberry Hills, Monroe County, July 18, 1912. J. M. V. 3421.

Panus strigosus B. & C. On limbs of fallen red oak, Unionville, Monroe County, July 7, 1912. 3421.

ASCOMYCETES.

Geoglossum glabrum Pers. Very rotten wood, point near Shuffle Creek, Monroe County, July 12, 1912. A. A. Bourke. 3434.

Holwaya gigantea (Pk.) Durand. On oak log, Third Street Pike, Monroe County, November 27, 1911. Sutton. 3233.

Leotia lubrica (Scop.) Pers. Ground, Griffey Creek hills, Monroe County, July, 1912. J. M. V. 3407.

Microglossum rufum (L. & S.) Underw. Very rotten wood, point near Shuffle Creek, Monroe County, July 27, 1912. A. A. Bourke. 3433.

Pseudopeziza Ribis Kleb. On currants, Monroe County, September 12, 1912. J. M. V. 3439.

Sarcocypha floccosa Schw. On rotten sticks covered with leaves, one mile north of Bloomington, Monroe County, July 10, 1912. Zetterberg.

Trichoglossum hirsutum (Pers.) Boud. Very rotten wood, point near Shuffle Creek, Monroe County, July 12, 1912. A. A. Bourke. 3435.

SPHAEROPSIDALES.

Ascochyta pisi Lib. On leaves, stems and pods of cultivated peas, Monroe County, summer of 1912. J. M. V. 3441.

Septoria ribis Desm. On gooseberry, near Bloomington, Monroe County, October 13, 1911. Sutton. 3450.

MELANCONIALES.

Cylindrosporium capsellae E. & E. On leaves of *Capsella Bursa-pastoris*, Monroe County, summer of 1912. Sutton. 3451.

Glocosporium rubi E. & E. On leaves of raspberry, Huckleberry Hill, Monroe County, November 3, 1911. Sutton. 3448.

HYPHOMYCETES.

Alternaria Dianthi S. & H. On leaves and stems of carnation, greenhouse, Monroe County, February 8, 1912. J. M. V. 3272.

Cercospora plantaginis Sacc. On *plantago lanceolata*, Fee Pike, Monroe County, October 12, 1911. Sutton. 3459.

Monilia cinerea Bon. On fruit of apple, Huntington County, December 9, 1911. Meier. 3244.

Indiana University, December, 1912.

FUNGOUS ENEMIES OF THE SWEET POTATO IN INDIANA.

BY C. A. LUDWIG.

In the spring of 1911, the writer began an investigation to determine the causal organism of a dry rot which does damage to sweet potatoes in storage at his home in Franklin County, Indiana. The work was continued the following winter as thesis work for a baccalaureate degree at Purdue University; and as no special study of the fungi affecting sweet potatoes in Indiana could be found, the subject was enlarged in scope to take in all the fungi of Indiana which are known to affect stored sweet potatoes. A number of forms which have been suggested as the cause of decay, and some not thus previously associated have been studied; and certain notes concerning them may not be without interest, in spite of the fact that the primary cause of the dry rot still remains in doubt. The work was carried on in the botanical laboratories of the Purdue Agricultural Experiment Station, and the writer wishes to acknowledge his indebtedness to the members of the botanical staff and to a number of other friends for various assistance.

The following fungi were found to affect stored sweet potatoes in Indiana:

PHYCOMYCETES.

Rhizopus spp.

ASCOMYCETES.

Nectria Ipomaea Hals.

Penicillium spp.

Diaporthe batatatis Harter and Field.

FUNGI IMPERFECTI

Sphaeronema fimbriatum (Ell. and Hals.) Sacc.

Fusarium spp.

Rhizopus nigricans Ehr. is the cause of a soft rot of sweet potatoes when they are kept too damp. It was determined as the cause of soft rot in some specimens from Tippecanoe County. Some other species of *Rhizopus* were also isolated from potatoes affected with soft rot, a circumstance which makes it probable that they may also be the cause of a soft rot when conditions are favorable for their growth.

Nectria Ipomaeae Hals.¹ has been observed in the vicinity of Bloomington, Ind., by Prof. J. M. Van Hook, of Indiana University. It is supposed to cause a stem and root rot of sweet potatoes in the field, a root rot in storage, and a stem rot of egg-plant in the field.

Penicillium spp. The prevalence of these fungi renders their attacks frequent. They are usually superficial, but may, however, penetrate more deeply, especially under conditions of considerable moisture. A wound of some sort is usually a further necessity for such an infection.

Diaporthe batatas Harter and Field. This is the organism originally described as *Phoma Batata* Ell. and Hals.² Harter and Field have recently secured the ascigerous stage and have named the organism.³ It was isolated several times from sweet potatoes raised in Tippecanoe County. The culture was determined by Mr. L. L. Harter, of the Bureau of Plant Industry. This appears to be the first time the species has been reported in Indiana. It is not listed in the report of the Biological Survey of the Academy in the Proceedings for 1893, nor, so far as I have been able to find, in the additions since.

Sphoronema fimbriatum (Ell. and Hals.) Sacc., This organism causes the disease known as "black shank." It was not found during the course of this work, but was reported in the 1907 Yearbook of the Department of Agriculture as having been present in this state during that year.

Fusarium spp. During the course of the work several species of *Fusarium* were isolated and studied. Some species are common members of the flora of decaying sweet potatoes, and the results indicate that one or more of them is partially responsible for the decayed condition. However, as the point has not been fully demonstrated, it seems best not to discuss it more fully here.

¹ Halsted, B. D. The Egg-plant Stem Rot. N. J. Exp. Sta. Rept. 12, pp. 281-283. 1891.

² Halsted, B. D. Some Fungous Diseases of the Sweet Potato. N. J. Exp. Sta. Bull. 76, pp. 23-25. 1890.

³ Harter, L. L., and Field, Ethel C. *Diaporthe*, the Ascogenous Form of Sweet Potato Dry Rot. *Phytopathology*, Vol. II, No. 3, pp. 121-124. June, 1912.

⁴ Halsted, B. D., and Fairchild, D. G. Sweet Potato Black Rot. *Jour. Myc.* 7, pp. 1-11, pls. 1-3. 1891.

Halsted, B. D. Some Fungous Diseases of the Sweet Potato. N. J. Exp. Sta. Bull. 76, pp. 8-14. 1890.

NOTES ON SOME PUFF-BALLS OF INDIANA.

 BY FRANK D. KERN.

Our largest fungi belong to the group popularly known as puff-balls. They receive this name because of the fact that most of them when mature and dry puff forth their spores in clouds upon the slightest disturbance. Those who are in the habit of thinking of mushrooms, toadstoods, or ordinary puff-balls as are large fungi may be somewhat surprised to learn that within our own State certain species of puff-balls frequently attain a size equal to the largest pumpkins. (See Fig. 1.) Notes concerning some of

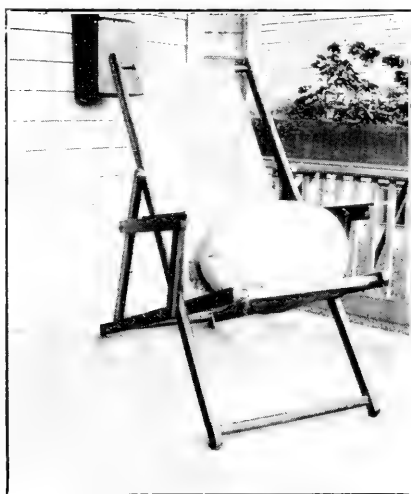

Figure 1. CALVATIA BOVISTA

A fresh specimen measuring 40 cm. in diameter and weighing 9 $\frac{3}{4}$ pounds.

these larger forms may therefore not be without interest, especially since they form an important part of our fungous food products.

There have been in the United States four important workers with puff-balls, Peck, Trelease, Morgan and C. G. Lloyd. Peck's work has been largely devoted to New York forms while Trelease's studies were confined

to Wisconsin species. Morgan and Lloyd, both residents of Ohio, have covered not only their own region but have made their studies more general. Lloyd has extended his observations to various parts of the world.

No special study of Indiana species has been made. In 1893 Underwood listed twenty-three species in the Report of the Botanical Division of the Indiana State Biological Survey, published in the Proceedings of the Academy for 1893, pp. 13-67 (1894). Presumably this includes all that were known to him in the state at that time. No additions were made either by Underwood or Arthur in their supplementary lists in the Proceedings for 1896. Reddick mentions four species in a paper in the 32d Annual Report of the Department of Geology and Natural Resources of Indiana, 1907, but none of them are additions to the Underwood list. Van Hook has published two lists of Indiana fungi, one in the Proceedings of the Indiana Academy for 1910, pp. 205-212 (1911), and another in the Proceedings for 1911, pp 347-354 (1912), which include references to seven species, only two of which were not in the previous lists. This makes a total of at least twenty-five species which have been reported for the state through the Academy. For the most part these are small or moderately small forms. It is certain that this is not a complete record but no effort has been made toward an exhaustive search of the literature. Various references to Indiana species occur in the writings of Morgan, Lloyd, McIlvane, and others, and so far as known to the writer several additional species may be mentioned.

A medium-sized species (4-8 cm. in diameter) said by Lloyd to occur in Indiana, but apparently not mentioned in any of the Academy records, is *Boristella Ohicensis*. This plant was twice collected in the vicinity of Lafayette in October, 1912, once by Mr. Henry Meigs and once by Prof. C. R. Orton and the writer. In the former collection, which was only about half mature when brought in, the peridia ranged from 5-8 cm. in diameter. Lloyd especially mentions a robust specimen in the Ellis herbarium (now at the N. Y. Botanical Garden) which he says was collected by Gentry in Indiana. This specimen is about 10 cm. in diameter but according to Lloyd it rarely occurs so large. While the specimens collected by Mr. Meigs do not equal the Gentry specimen in size they appear to approach it more nearly than usual. The specimens taken by Orton and the writer are considerably weathered but appear to have been of ordinary size, 4-6 cm. in diameter. They compare very favorably with Lloyd's Figs. 5 and C, Plate 86, accompanying his Mycological Notes, No. 23 (1906). A

good illustration of the species is also to be found in Hard's Mushroom Book, p. 533, *Fig. 473*. The peridium is subglobose or depressed pyriform. The outer coat, or cortex, consists of dense, soft warts or spines which fall away after a time, exposing the smooth, shining, thin inner coat. The spores are pale cinnamon-brown, slightly oval, $3-4 \times 4-5 \mu$, smooth, with slender hyaline pedicels $9-15 \mu$ long. The capillitium consists of separate, branched threads, $3-6 \mu$ in diameter, the branches gradually tapering to sharp points. Ellis and Morgan described this species in 1855 giving it the specific name of *Ohioense* but referring it to the genus *Mycenastrum*. In 1888 DeToni transferred it to *Scleroderma* in Saccardo's *Sylloge Fun-*

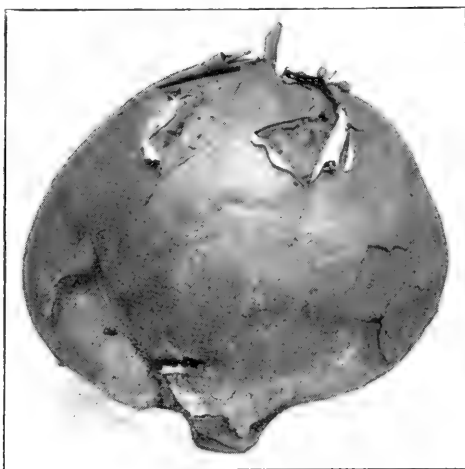

Figure 2. CALVATIA BOVISTA

A specimen which weathered for nearly a year in its place of growth. This specimen is now at all 30 cm. in diameter, and weighs $4\frac{1}{2}$ ounces.

gorum. Morgan later used it as the type of a new genus, *Bovistella*, calling this plant *Bovistella Ohioense*. This plant is more common southward and our locality is apparently in the extreme northern part of its distribution. Judging from the general distribution and from the Illinois and Ohio localities it would seem that this species is likely to be met with in the southern half of Indiana.

A considerably larger species (10-15 cm. in diameter), *Mycenastrum spinulosum*, which has never been reported for Indiana in the Academy proceedings, or elsewhere, so far as the writer knows, was collected near

Lafayette, October 16, 1905, by Dr. J. C. Arthur. Three specimens of this collection have been preserved. This is a common puff-ball on the plains west of the Mississippi River, and occurs also in the Rocky Mountains and on the Pacific Slope. I have collected it in Colorado west of the continental divide. In 1903 Lloyd wrote that he had not seen specimens of this plant from any station farther east than Chicago, Ill. Peck, however, in his Annual Report of the N. Y. State Museum for 1901 reports it from Crown Point, N. Y. His specimens were unsatisfactory and yet he considered them to be this species. With the exception of Peck's New York locality ours seems to be at the eastern limit of distribution. The species is notable in the character of both peridium and capillitium. Peck's



Figure 3. MYCENASTRUM SPINULOSUM

Showing the stellate splitting of the peridium and the unequal spreading of the rays. This specimen is 12 cm. in diameter.

description of the peridium as thick, firm, and gourd-like is well expressed, as is also his reference to the form of rupture as a stellate splitting from above followed by an unequal spreading and reflexing of the rays. (See Fig 3). One of the specimens in our Indiana collection was not ruptured, but the other two show the characteristic form. The peridium is hygroscopic, which often causes the rays to undergo sufficient movement to result in a movement of the whole plant. The capillitium consists of separate threads of comparatively large diameter, 10-12 μ , which are set with prominent spiny points. The spores are also large, 10-12 μ , slightly rough, and without evident pedicels. The spore-mass is a rich chocolate-

brown in color. Peck originally described this species as a *Bovista* in 1879 (Bot. Gaz. 4:170) but two years later transferred it to the genus *Mycenastrum* (Bot. Gaz. 6:240). It very evidently belongs in the group of tumblers, the mature plant becoming loosened from the place of growth. The *Bovistella* described in the foregoing paragraph normally remains attached. As to whether our American species *Mycenastrum spinulosum* is identical with any foreign species there is some diversity of opinion. Dr. L. Hollós, a Hungarian botanist, claims all forms of *Mycenastrum* to be one species, of which the oldest name is *M. Corium*, and he believes this species to be cosmopolitan. Lloyd at first disagreed but later practically accepted this disposition. Dr. Ed. Fischer, however, in Engler & Prantl, *Natürlichen Pflanzenfamilien* recognizes about thirteen species of *Mycenastrum*, *M. Corium* and *M. spinulosum* being considered distinct. McIlvaine in his book, *One Thousand American Fungi*, observes that he has no report upon the edibility of *M. spinulosum* but that it is probably good.

The largest species of all, which is also the largest species of fungus known, is commonly known as the "giant puff-ball." It passes under such a variety of scientific names that one scarcely knows which one to use. There appear to be three important specific names which have been proposed, *Bovista maxima*, and *gigantea*. The latter two appear more appropriate but the first evidently has priority. These specific names with some others have been variously combined with the genera *Lycoperdon*, *Bovista*, *Globaria* and *Calvatia* so as to make a long list of synonyms. In the Academy papers already cited it has been referred to as *Calvatia gigantea*, *Lycoperdon giganteum*, *L. Bovistum*, and *Calvatia Bovista*. Without attempting to enter into a discussion of the validity of the various genera it may be said that there appear to be good reasons for separating some forms from the old genus *Lycoperdon*, and if the genus *Calvatia Fries* should be maintained, a proper name for the species under discussion would appear to be *Calvatia Bovista* (L.) Underwood (Proc. Indiana Acad. Science 1893:63). In spite of the fact that Lloyd says it is of rather rare occurrence in the United States it seems to have been frequently collected in Indiana. Published accounts indicate collections from Montgomery, Noble, and Putnam Counties. To this list is now added Tippecanoe County.¹ On October 8, 1911, Mr. George Snyder brought in a fine specimen of this fungus which he found growing on wet, peaty soil in

¹ In addition, Johnson and Fulton counties were named by persons in the audience when this paper was being read.

rather open woods about five miles east of Lafayette. The specimen was immature, not yet having begun the formation of spores, and was firm, white, and solid. (See Fig. 1.) It measured about 40 cm. in diameter and weighed $9\frac{1}{2}$ pounds. The specimen was so large that it would not go into the ovens where heat could be applied and unfortunately spoiled before we devised a method of drying it. On October 9, 1911, Mr. F. J. Pipal and the writer visited the locality where the large specimen came from and found in the immediate vicinity a whole "colony" of large puff-balls varying from 10 or 12 cm. in diameter up to the size of the one described. Several were collected and some were preserved. On September 16, 1912, nearly one year later, this locality was again visited by Mr. Pipal and the writer with the hope of finding another crop of giant puff-balls. No fresh specimens were found, but nevertheless observations were made which may be of some interest. To our great surprise a number of old specimens of the crop of the previous season were still attached in their original position, and although somewhat weathered still retained their globose form and were in an excellent state of preservation. (See Fig. 2.) That such large frail objects would withstand weathering for so long a time had not occurred to us as at all likely. One of the best of these was brought in and is now in our collection. It is now 30 cm. in diameter and weighs only $4\frac{1}{2}$ oz. Judging from the size it is safe to say that this specimen must have weighed seven or eight pounds when fresh. The peridium is thin and papery and irregularly split and torn in the upper part, after the manner described by the older authors. Nees in his *Systema der Pilze* (1816) presents a very good illustration of this species, *Pl. 11, Fig. 124*. There can be no doubt that this plant normally remains attached to the place of growth. The capillitium is very unlike that of *Bovistella* or *Mycenastrum*, consisting of long, branching, intertwined threads which are uniform in size, 4-5 μ , and smooth. The spores are globose, medium-sized, 4-5 μ , smooth.

In October, 1905, when Dr. Arthur collected the *Mycenastrum* specimens near Lafayette, several other larger forms were brought in. Two of these which average about 18 and 23 cm., respectively, in size are preserved in our collection. The characters of these specimens are unusual and considerable difficulty has been experienced in reaching a conclusion concerning their identity. The capillitium and spores agree with the giant puff-ball, as does also their large size and the manner in which the peridium ruptures. The structure of the peridium, however, appears very different.

There are evidently three coats, or layers, to the peridium instead of the usual two. The first or outermost coat, which may be called the cortex, is more or less rough or warty; the second or intermediate coat is firm and thick, 1.5-2 mm.; the third or innermost layer is thin and membranous. The illustration (Fig. 4) brings out the features of the peridial coats. The thickness of the peridium proper suggests *Mycenastrum* but the other coats and the capillitium and spores are very different. The presence of the thin papery inner peridium seems to be unique among puff-balls and so far as I have been able to learn only one

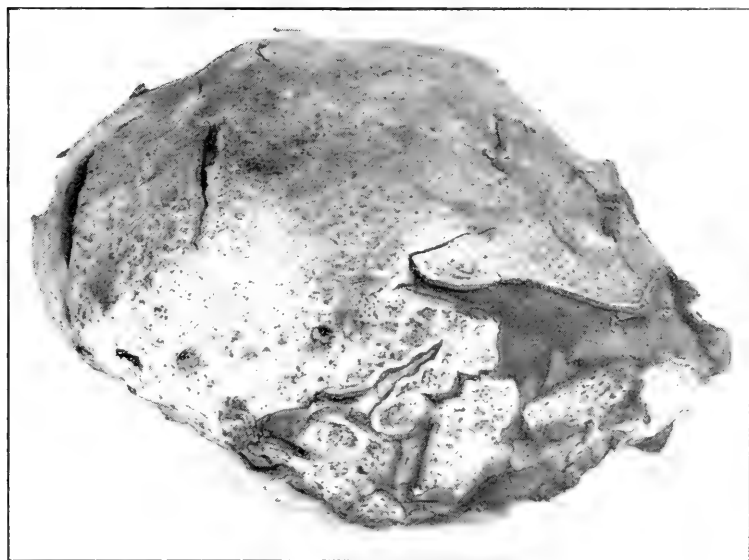

Figure 4. CALVATIA LEPIDOPHORA.

Showing the rough cortex, the thick intermediate coat, and the thin membranous inner lining which is now splitting and falling away in flakes.

species possessing this character has ever been described, viz., *Lycoperdon lepidophorum* Ellis and Ev. (Jour. Myc. 1:88. 1885). Mr. C. G. Lloyd, to whom I have sent material, agrees with me in the opinion that our specimens belong here, saying in a letter that "it is the second collection known of this very rare species. This is the first time I have ever received it, and have only previously seen the type in the Ellis collection [New York Botanical Garden]. The structure, spores, capillitium, and peculiar inner membrane covering the spores are exactly the same. The difference

in appearance of the cortex coat is due, I think, to Ellis' specimen being older than yours, and this coat having changed in drying. Your plant was evidently collected in its prime and the natural cortex coat well preserved." On account of the notable peridial characters of this species the generic standing has been uncertain. It was originally described by Ellis and Everhart as a *Lycoperdon* and was listed in Saccardo as a *Bocista*. When Mr. Lloyd published his "Genera of Gastromycetes" (Bull. Lloyd Library, Mycological Ser. No. 1) in 1902 he provided in his key for a genus *Hypoblema* separable from the genus *Calvatia* by the presence of an inner membrane such as this species possesses. On Pl. 11, Fig. 49, he illustrates what he calls *Hypoblema pachyderma*. About a year later in his Mycological Notes (No. 14, p. 140, March, 1903) he described fully the genus *Hypoblema* saying that it was based on *Lycoperdon lepidophorum*, and referred to *Hypoblema lepidophorum* as the only species. His earlier use of the specific name *pachyderma* was founded on the assumption that it was a prior name for the same species. Further investigation, however, convinced Lloyd that Peck's *Lycoperdon pachydermum* (Bot. Gaz. 7:54, 1882) was a distinct species, and he took up *lepidophorum* as the specific name under the genus name *Hypoblema*. Somewhat later the views concerning the validity of this genus were altered as is evidenced by a note (footnote 13, p. 14, Index Myc. Writings, vol. 2) to the effect that he would class *Hypoblema* as a subgenus under *Calvatia*. In a recent letter to the writer Mr. Lloyd has again expressed the opinion that the species should be referred to *Calvatia*. Morgan has already described the species as a *Calvatia*, but as he was also mistaken in thinking Peck's *L. pachydermam* was identical he used the name *Calvatia pachyderma*. This error was further perpetuated by McIlvaine (One Thousand American Fungi, p. 582) whose description clearly confuses the two plants. Believing with Mr. Lloyd that the peridial differences presented by this species can scarcely be considered sufficient for generic separation the combination **Calvatia lepidophora** is here adopted as the proper designation. The type specimens of Ellis and Everhart's *Lycoperdon lepidophorum* were collected at Huron, [South] Dakota, September, 1884, by Miss Nellie E. Crouch. As the Lafayette collection is the second known collection very little can be said about the distribution. It is evidently a very rare species. Both collections were made in the autumn. Nothing was said about the original habitat; ours was an open pasture with muck soil.

Agricultural Experiment Station, Purdue University, Lafayette, Ind.



Fig. 1. Commercial Test and Breeding Trials of Detomidon ...

Experimental Farm.

Eli Lilly & Co., Indianapolis, Ind.

THE IMPROVEMENT OF MEDICINAL PLANTS.

BY F. A. MILLER.

Certain suggestions were made before the last meeting of the Academy for the possible improvement of valuable medicinal forms through the application of breeding methods. Some of these suggestions have been carried out during the past summer upon experimental plots of belladonna, henbane, stramonium, digitalis and cannabis. The results, though only tentative, are extremely encouraging, and indicate a means of obtaining not only greater yields of the resulting drugs, but better and more reliable medicinal products.

Belladonna has shown great uniformity in morphological characters, but considerable variability in the percentage of alkaloids in selected plants. In a comparatively small number this variation was found to be over 50%, or from 0.52% to 0.87% total alkaloids as found in the highest and lowest yielding individuals. Much has been said concerning the variation in total alkaloids as influenced by various conditions. In fact some experimental work has been done upon the influence of such factors as food elements, light and shade, soils, meteorology, etc., upon the production of alkaloids and other active principles. It now seems apparent, however, that before such data can have any scientific bearing, or be utilized as a means of following the influence of given factors, uniform strains of the plants under investigation must first be obtained. This apparent necessity is due to the wide variations which have been found to exist between the individuals of a given group which have been grown under uniform conditions.

A group of individual plants varying over 50% when grown under uniform ecological conditions cannot be expected to behave uniformly when grown under varied conditions. Differences no greater than 50% have been reported as being due to certain external influences as affecting all plants upon a given area, while according to recent individual plant investigations, such an area might produce plants varying this much or more among themselves, and representing at the same time any possible mixture with reference to yield. It seems necessary, for this reason, to first obtain a

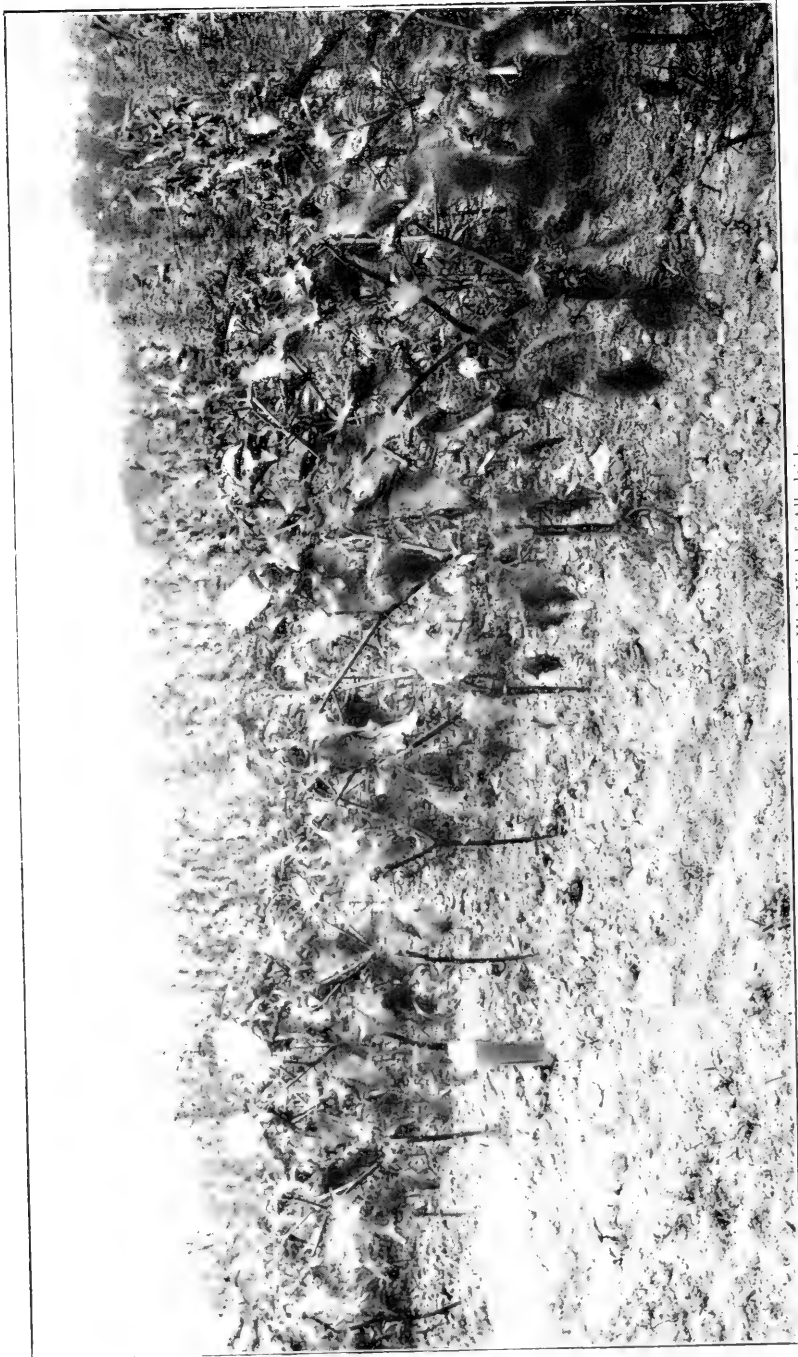

Fig. 2. Breeding Stramonium for High Yield of Alkaloids.
Experimental Farm.
Eli Lilly & Co., Indianapolis, Ind.

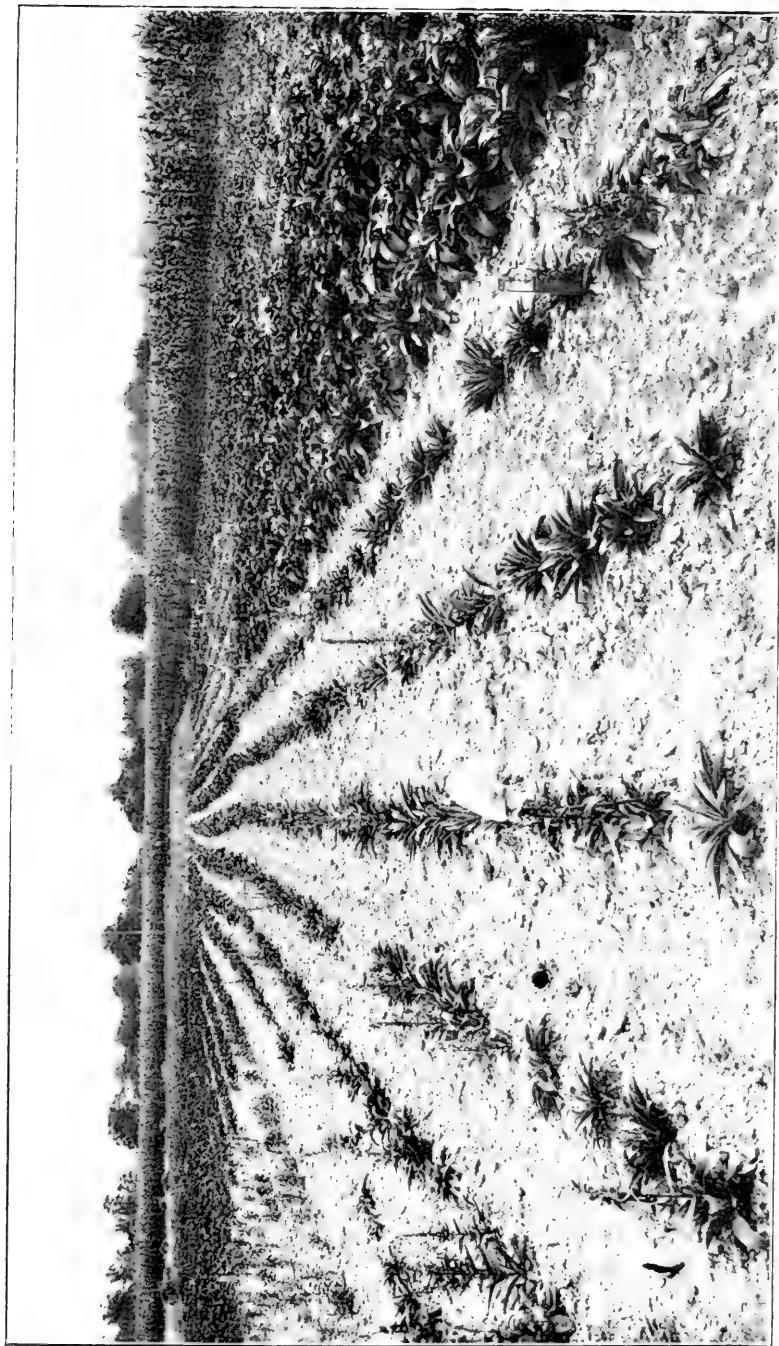

Figure 3. Testing and Breeding Plots of Various Species and Varieties of Digitalis.
Experimental Farm.

Eli Lilly & Co., Indianapolis, Ind.

strain of the form under investigation, the individuals of which will react uniformly to certain external conditions. To investigate this point, plants of known alkaloidal yield are being propagated both from inbred seeds and from vegetative cuttings. The progeny thus produced is being grown under the same conditions as the parent plants, as well as under widely different conditions. The alkaloidal yield of these plants will later be taken as a means of determining the results of the various treatments.

The highest yielding individuals from all groups examined are immediately selected as parent plants for possible high yielding strains. The propagation of these favorable individuals is continued throughout the year by means of greenhouse and cold-frame accommodations, and are tested as rapidly as sufficient material becomes available.

The production of henbane even upon a small experimental scale has proven extremely difficult. This difficulty is largely due to the ravage of insects, although cultural difficulties with this plant are not uncommon. It will not reproduce itself from open field sowings and transplants with uncertainty. However, a small number of biennial plants were grown and found to test 0.089% total alkaloids at the end of the first season's growth, while commercial drug has only averaged 0.067% for the past year. The Pharmacopœia requires that this drug be collected from plants of the second year's growth. The above figures indicate that it may be entirely unnecessary to grow this plant through the second year to obtain a high yield of alkaloids. The annual form was again observed, and though no tests were made, an abundance of seed was obtained from which plantings will be continued. The appearance of this annual form in many plantings of henbane of supposed biennial origin has led to much dispute. Its investigation is necessary from this point of view as well as the possibility for developing an annual form which would possess many cultural advantages over the biennial.

The selection of high yielding stramonium plants upon a basis of their contained alkaloids has been continued through two years. Averages as obtained from the progeny of selected parent plants have shown a marked increase over those from wild plants growing in the same locality. These averages are 0.61%, 0.50%, 0.60% and 0.64% from *Datura Stramonium* L., and 0.49%, 0.54%, 0.62% and 0.68% from *Datura tatula* L., as compared with 0.28% from wild plants of *Datura stramonium* L. and 0.42% from wild plants of *Datura tatula* L.

Thirty-two forms of the genus *Digitalis* are under cultivation. These

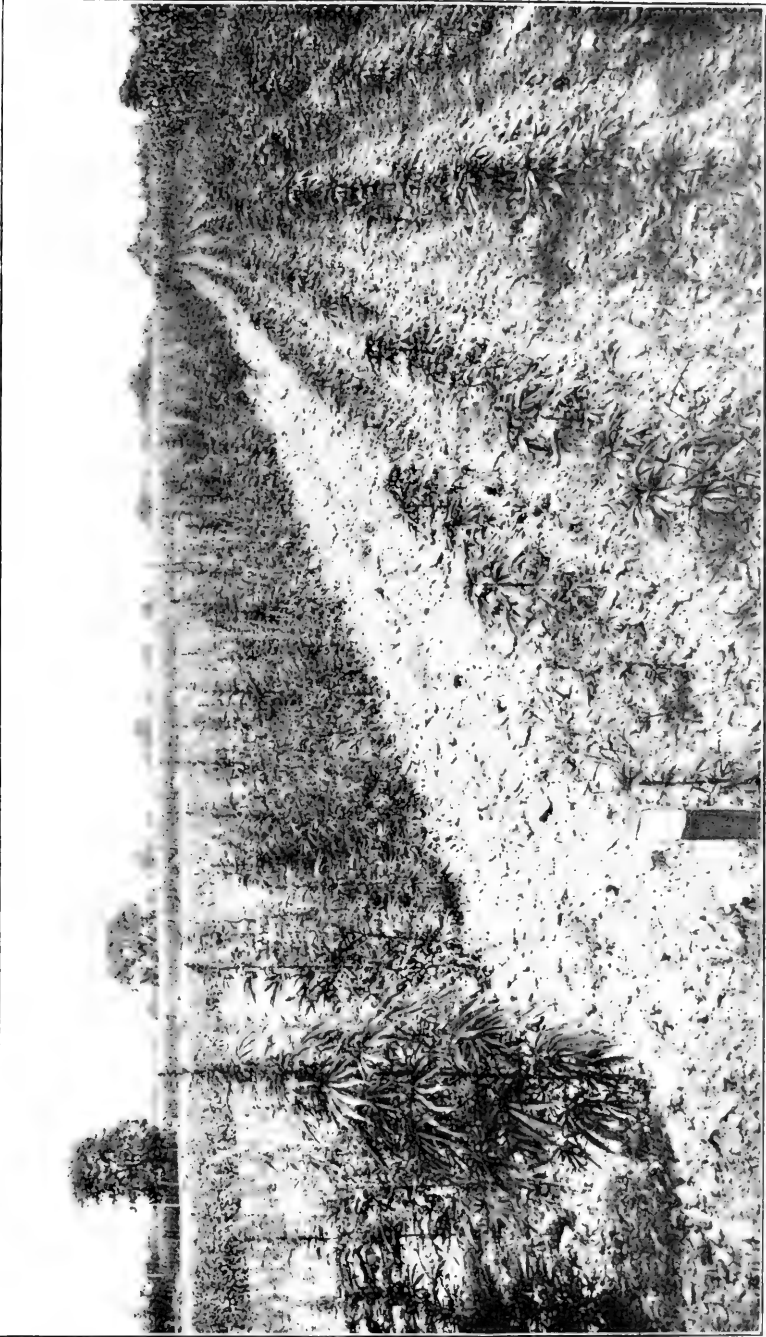

Fig. 1. Young Cannabis Indica from Different Geographical Sources.
Experimental Farm,
Eli Lilly & Co., Indianapolis, Ind.

consist of all the species and varieties so far obtainable. These must first be tested for identity before any extensive breeding operations can be performed. Physiological tests have been made which indicate great differences in the toxicity of some of the more accurately named species and varieties. Though more strictly biennial in habit, it has been found possible to bring a number of the varieties into flower the same year from seed, thereby shortening any breeding operations by one year.

It has been interesting and valuable to follow the effects of Indiana soil and climate upon the medicinal value of *Cannabis Indica*. This is an imported drug consisting of the flowering tops of *Cannabis sativa* L. It always contains more or less seeds of high percentage germination. Repeated tests have been made upon material obtained from plants grown from seed found in shipments of high testing drug. Without exception these tests have shown a decrease of from 40% to 60% in value as compared with the original shipments from which the seeds were obtained. One strain has been continued under cultivation in the same locality and upon the same soil for four consecutive years, and its value as indicated by physiological tests has fluctuated between 40% and 65%. This fluctuation has been intermittent, and not in the nature of a regular annual increase or decrease. During this time, however, a marked improvement has resulted in the size and character of the inflorescence. By selection this has become heavier, more compact, larger and less leafy. A dwarf form has also resulted which would greatly simplify the process of collection.

Figures No. I, II, III and IV show some of the experimental plots, and convey some idea of the scale upon which the work is being done. Large numbers of plants are being used, and these are observed throughout the entire growing season before any selections are made. In this manner the entire life history of the plant from the earliest seedling stage to maturity is made to serve as a record from which intelligent selections can be made.

Department of Botany,

Elk Lilly & Company, Indianapolis, Ind.

THE STRUCTURE AND DIAGNOSTIC VALUE OF THE STARCH GRAIN.

BY R. B. HARVEY.

In view of their common occurrence in plant tissues, starch grains have been used, especially in Pharmacognosy, to differentiate between plants. While there is a great variation in the size, shape and structure of starch grains, those of different members of a genus, or even of a family, often show a similarity. Hence, these group characteristics often may be used to identify a given starch as belonging to a certain group of plants. As medicinal action or value varies greatly between closely related members of the same genus, it is of the highest importance to establish the authenticity of the species, and in this determination the starch grain is often of the greatest diagnostic value.

The characters most often used in the identification of starches are the size, shape, and markings of the grains. The most distinct markings are the hilum and the concentric layers of starch. It is very commonly stated that the hilum is the point of attachment of the grain, and that it occupies a position on the surface, while in reality it is the part first formed, and is marked by a fissure or cleft in the interior, caused by the loss of moisture, and shrinking of the central portion.

The starch grain has a structure somewhat similar to that of the sphaero-crystal, and like it grows by the apposition of new materials. According to the best authorities, the grain is made up of minute crystals or miscelle of soluble starch, or granulose, imbedded in a frame work of starch cellulose. Alternate layers seen in many grains, contain a greater proportion of granulose, and hence stain more deeply with iodine solution. This structure of the grain was demonstrated by the action of such solvents as chloral hydrate or diastatic solutions which dissolve the granulose very rapidly, and leave a framework of starch cellulose, of the same size as the original grain, but lacking the substances which produce the characteristic color with iodine solution.

Hence, as was stated by Meyer that the soluble starch was distributed throughout the grain in very small crystals or trichites. A consideration of the behavior of the grain upon swelling certainly demands a structure of this nature. The methods used in the preparation of this paper, and the results obtained agree with this structure, but indicate that the crystals

or trichites of soluble starch may be of a considerable size. Since the crystals have nearly the same refractive index as the remainder of the grain, they cannot be detected without special treatment.

The structure of the starch grain is most easily seen in such grains as those of the common potato, or of arrowroot, which show the layers of starch most plainly, or those of Bamboo Brier root, which show the characteristics of the central portion. When these starches are stained with certain dyes, of which safranin is the best example, and the excess of stain is extracted, the central portion retains the stain, and the crystalline nature of this portion becomes evident. In the center of the grain crystals are seen arranged with their longer axes extending radially from the hilum. The clefts in this crystalline mass mark the hilum, and the fissures caused by the loss of moisture follow the longer axes of the crystals, forming the fan-shaped markings often seen in the unstained grain. Fig. 1. When the grains are kept moist at 50° C. for some time, the moisture passes through the outer layers, causing but little change in their structure, but when the crystalline portion is reached, this swells up and slowly dissolves from its surface, becoming surrounded by a zone which stains deeply with iodine solution, indicating the presence of soluble starch. The solution and swelling of this inner portion pushes upward the outer layers, which finally rupture at the thinnest point, that is, at the hilum end in eccentric grains. It therefore appears that the greater moisture content of this portion is due to its higher solubility, and indeed this part may be entirely dissolved and carried away in solution before the outer layers are affected. This is commonly the case in such grains as those of the common yam, or of Bamboo Brier root. Fig. 4.

Something of the chemical nature of the various layers of the grain can be determined by treating with the following easily reducible silver solution, which may be compared to Fehling's alkaline cupric tartrate solution:

Silver Nitrate.....	1 gm.
Water	15 cc.
Ammonia water	q. s.

Add the ammonia water to the solution of the silver nitrate until the precipitate first formed just dissolves.

Potassium and Sodium Tartrate.....	2 gm.
Water	15 cc.
Dissolve.	

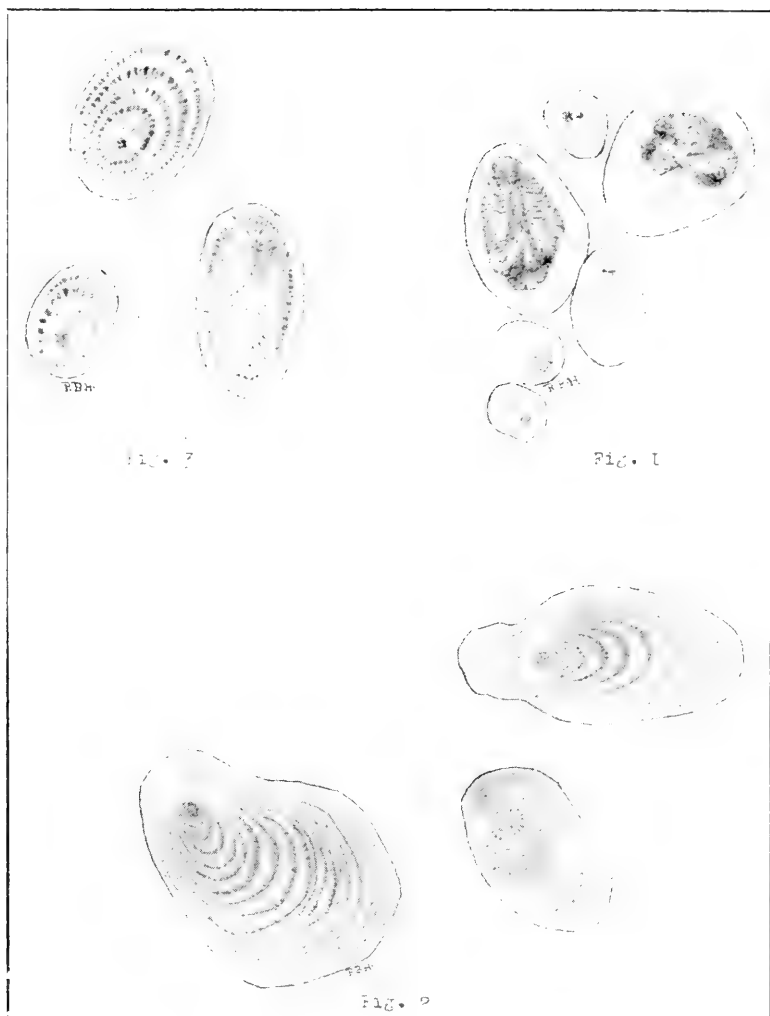

When starch grains are treated for a time with a small amount of the ammoniacal silver solution to allow the silver salt to be evenly distributed throughout the grain, and then an equal amount of the tartrate solution added, the silver salt is reduced by the granulose present in the grain, giving stains varying in color from purple through shades of brown to black, depending upon the state of reduction. Reduction occurs in a few hours at ordinary temperature, or may be quickly accomplished by warming very slightly although too strongly heating causes complete reduction of the solution and total blackening of the grain.

If it is desired to make permanent mounts by the above method, the starch should be stained in bulk until the proper depth of color is reached, and then the soluble and unreduced silver salt washed out with water to prevent further reduction. The grains may then be dehydrated and mounted permanently in balsam.

When starch grains are treated according to the above method, alternate layers and the central portion reduce the silver solution most rapidly, showing the presence of reducing substances which cause a deposit of silver. Fig. 2. The alternate layers which stain most deeply with iodine solution take on a granular appearance, and show the presence of crystals. The location and size of these crystals become more distinct upon further treatment of the mount with 1% chromic acid solution. Then they are seen to be of considerable size in some grains, and often to be arranged in a group with their longer axes radiating from the hilum. Quite large crystals occur toward the outer portion of each layer, and their presence accounts for the difference in refraction of the layers at this point, which produces the appearance of concentric rings. Fig. 3.

In double or compound grains a crystalline mass is seen at the center of each part, indicating that compound grains are formed by the deposition of material around a number of points of crystallization, and the subsequent growth of each part until fusion occurs. In the outer layer of the grain no crystals appear, and this portion seems to be made up for the greater part of starch cellulose, which explains its lesser solubility in diastatic solutions. Fig. 3.

An application of the differences in the structure of starch grains is of value in the examination of such closely related species as the common sarsaparillas of the genus *Smilax*. All the members of this group, which are commonly met with, have similar histological structures. All show the presence of raphides crystals of calcium oxalate and parenchyma cells

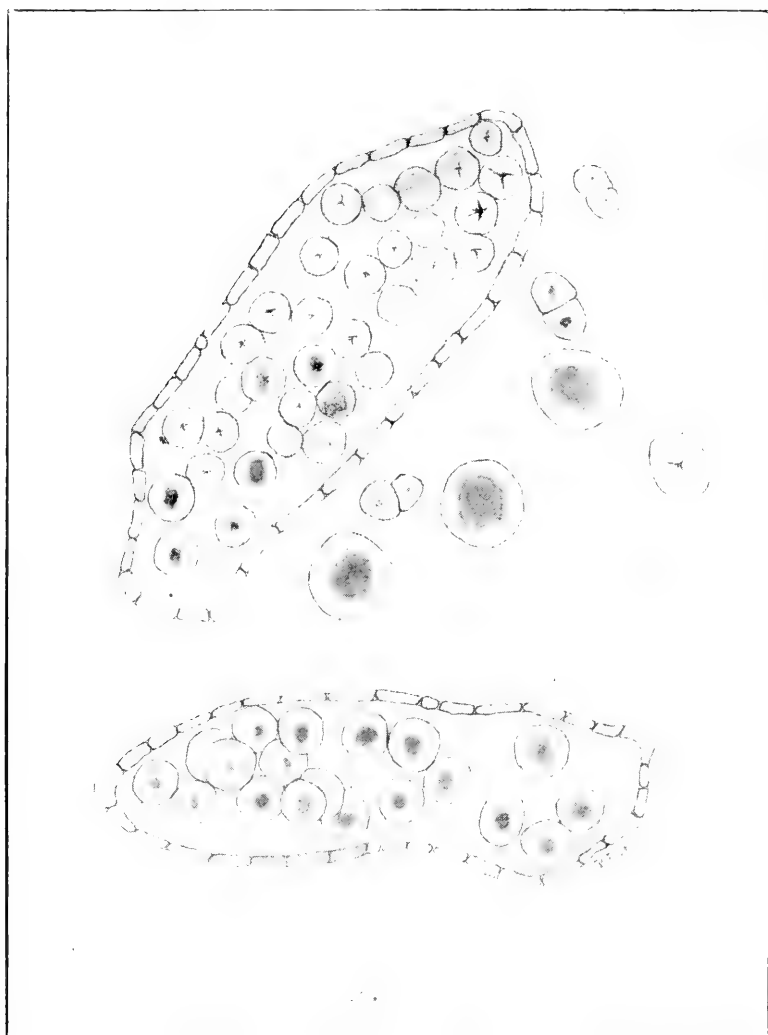

filled with starch grains, which are commonly spherical, or united in groups of two or three grains. Honduras sarsaparilla, *Smilax officinale*, is characterized by starch grains varying from 7 to 20 microns in diameter, and raphides crystals 6 to 8 microns in length. The common Bamboo Brier root shows similar characteristics when examined in fine powder, but shows a variation in the starch grain. The starch grains of this drug greatly resemble those of Honduras sarsaparilla, being either single or united in groups, and show a similar structure in the interior of the grain; but upon measurement they range in size from 9 to 40 microns, averaging 29 microns in diameter. Hence, this means may be used in the differentiation of these plants when the drug is examined as a fine powder.

By the application of the above or of similar methods, it is possible to differentiate between very closely related plants. As our knowledge of the structure of starch grains is more fully developed, their value in the differentiation of such closely related species becomes apparent, and they are recognized as one of the greatest aids in Pharmacognosy.

Department of Botany.

Eli Lilly & Company.

BUTTER FAT AND BUTTER FAT CONSTANTS

BY GEORGE SPITZER.

I.

When the greater portion of fat is removed from milk by skimming or separating, and the resulting cream subject to powerful mechanical treatment, the milk fat passes from the liquid into the solid state, by cooling the mixture below the melting point of butter fat. The fat globules thus collect and are formed into grains. By washing and working, the greater portion of buttermilk is removed and the substance called butter is left. Salt in suitable quantity is added according to the demands of the consumer. The analysis of butter, known as proximate analysis, consists in determining the per cent. of moisture, salt, proteids and fat.

The analysis of butter has reached a degree of great importance. The proximate analysis does not indicate whether the sample has been adulterated, but indicates its present condition, and may give some information as to the method of manufacture.

Since the enactment of the Pure Food Law, butter containing 16 per cent. or more moisture is held as adulterated butter. The composition of butter is a variable one, the proportion of different constituents, as fat, moisture, salt, etc., are variable, depending on methods of manufacture. Butter is then only a mixture of the above constituents, or properly speaking an emulsion of butter fat and water, containing salt, curd, and milk sugar. But when we treat of butter fat we have a substance of definite characteristic chemical composition. Both solid and liquid fats are formed by the combination of glycerol and fatty acids. Glycerol is a trihydric alcohol and consequently behaves as a trihydric base. It can then combine with the radicles of fatty acids expressed as follows:

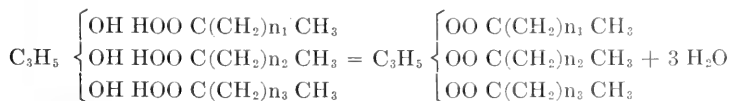

forming an ester of mixed fatty acids, also called mixed triglyceride. From

theoretical considerations, we can predict the existence of a simple triglycerides, where only one simple triglyceride can exist expressed as follows:

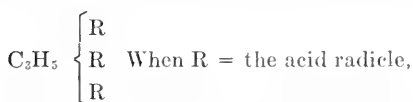

and this representation for each fatty acid. As glycerol is a trihydric alcohol, we might also expect mono and di-glycerides

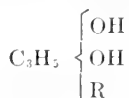

Mono glyceride

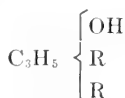

Di-glyceride

where R stands for any one fatty acid radicle and these are called mono or di-glycerids.

Wurtz, showed that it was inconsistent with the facts discovered. In nature only the triglycerids occur, while the mono and di-glycerids are as a rule rare, if they ever occur.

Butter fat consists of triglycerids of fatty acids, comprising butyric, caproic, caprylic, capric, lauric, myristic, palmitic, stearic, and oleic acids. All these fatty acids are mono basic and from theoretical consideration we might expect a mixture of simple triglycerids, such as tributyrin, triolein, etc. This combination of fatty acids with glycerol forming simple triglycerides in butter fat is disputed by Richmond and others.

If simple triglycerides existed as such in butter fat, we would expect a portion at least to be soluble in alcohol, at least the tributyrin which is quite soluble in alcohol. But when butter is dissolved in alcohol we find that only about 1% of fat goes into solution. And the portion soluble in alcohol consists of mixed triglycerides of fatty acids, indicated by the melting point and per cent of soluble acids. We conclude then that butter fat is a mixture of mixed triglycerides, expressed by the following formula,

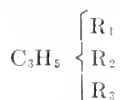

R_1 , R_2 , and R_3 , represent different acid radicles. But as stated above butter fat consists of at least nine different fatty acids, we have then a mixture of mixed triglycerides, consisting of a combination of two or three different acid radicles to each glycerole residue.

II.

CHEMICAL ANALYSIS OF BUTTER FAT.

Since butter fat represents complex mixtures of glycerides of the different fatty acids, complete fat analysis should embrace the separation of each fatty acid quantitatively. An attempt to detect and identify the individual fatty acids, in a way as is done in inorganic chemistry in determining individual elements, must be abandoned as a hopeless undertaking in fat analysis. However, in fat analysis the results obtained are not accurate in strict scientific language, they are relative rather than absolute. Methods have been worked out which answer all technical purpose. These methods consist in obtaining certain "values" or numbers. These numbers are characteristic of the fats depending on the nature and properties of the fatty acids.

These "numbers" or "values" have been termed quantitative reactions. When the methods are strictly followed, uniform results are obtained, and for that reason the "number" or "values" are called "constants," specific for each kind of fat. The "constants" in fat analysis are divided into

<i>Physical</i>	{	Solidifying point,	
		Melting Point,	
		Refractive index,	
		Sp. gravity.	
<i>Chemical</i>	{	Reichert-Meissl	value.
		Saponification	value.
		Iodine	value.
		Hener	value.
		Thermal or	
		Maumené	value.

III.

THE RELATION OF BUTTER FAT CONSTANTS AND CALCULATED DATA FROM THE CHEMICAL ANALYSIS.

In chemical analysis of butter fat it is often desirable to obtain data of relations other than the relations obtained directly by the determination of the chemical constants. From these data we are able to account and interpret some of the variation in the physical constants, where, owing to the complexity of the glycerides the chemical constants do not indicate in themselves the variation of the physical properties.

Three samples of butter fat were analyzed. The constants determined, both of the fat and fatty acids. In order to secure butter fat of extreme variation in the chemical and physical properties. Use was made of the fact that when fats are placed where the temperature is below the melting point of the softer glycerides crystallization takes place, the harder glycerides separating from the softer. By filtration, separating the soft portion and the process repeated, fractions of hard and soft fats are obtained whose constants differ widely. The three samples thus secured, i. e., the original butter fat and the soft and hard glycerides when analyzed gave the constants as enumerated in Table I.

TABLE I.

	<i>Butter fat.</i>	<i>Soft Portion.</i>	<i>Hard Portion.</i>
Reichert-Meissl.....	30.00	33.85	24.66
Iodine Value.....	39.82	43.55	33.08
Saponification Value.....	230.1	232.78	226.4
Mean Molecular Wt. Calc.....	732.	723.	744.9
Refractive Index ¹	{ 44.	44.8	43.
	{ 1.4552	1.4558	1.4545
Melting Point.....	32.5	13.2	38.1
Insoluble Acid ²	87.54	86.67	88.64
Soluble or Volatile Acids ³	6.9	6.90	5.17

Constants of the Insoluble Acids of the Samples in Table I.

Iodine Value.....	42.14	46.2	35.66
Saponification Value.....	220.53	221.6	218.7
Melting Point.....	39.2	35.3	42.4
Refraction Index ¹	{ 33.75	34.2	32.7
	{ 1.4479	1.4482	1.4471
Mean Molecular Wt. Calc.....	254.8	253.2	256.6

IV.

VOLATILE ACIDS.

The high per cent. of volatile acid in butter fat is one of its chief characteristics. By means of this fact it is possible to differentiate it from all other animal and vegetable fats, and it is natural that great importance is attached to the determination of volatile acids or Reichert-Meissl value.

¹Butyrofactometer reading at 40°C.

²Or Hehner value.

³Calculated as butyric acid.

The Reichert-Meissl value does not represent the total volatile or soluble acids, but only a reasonably constant fraction, provided the operation is conducted uniformly according to the prescribed method.

From the Reichert-Meissl value the total volatile acids can be calculated, with considerable degree of accuracy. By the Reichert-Meissl process of distillation from 85 to 89 per cent. of the total volatile acids are distilled. (See Richmond's Dairy Chemistry, p. 264; Lewkowitseh, Fats, oils and waxes Vol. 1, p. 332.) Then to calculate the total volatile or soluble acids⁴ we make use of the number of cubic centimeters of NaOH N/10 required to neutralize the volatile acids obtained from five grams of fat. Then for the per cent. of total volatile or soluble acids in the butter fat as recorded in Table I, calculated as butyric acid, we have $30.00 \times .0088 \div 5 \times 100/87 = 6.10$ per cent. of volatile acid as butyric acid, a result which agrees with the chemical analysis of the butter fat Table I. For the soft portion of fat the total volatile acids calculated from the Reichert-Meissl numbers gave 6.82 per cent., while that obtained by direct determinations was 6.90 per cent., a difference of .08 per cent.

For the hard portion the total volatile acids calculated from the Reichert-Meissl number gave 4.98 per cent., that found by direct determination 5.17, a difference of .19 per cent.

In the three analyses the total volatile acids calculated from the Reichert-Meissl number is a close approximation to that found by direct determination, assuming that 87 per cent. of the volatile acids are distilled.

The per cent. of volatile acids distilled vary with the rate of distillation, size of distilling flasks, etc. But when the relation of the Reichert-Meissl value and the total volatile acids are once determined, close approximations can be made in the calculation of total volatile or soluble acids.

The Reichert-Meissl value furnishes means to calculate the mean molecular weight of the volatile acids, and by the use of the mean molecular weight the relative proportion of the different volatile acids entering into the glycerides of butter are indicated. In Table I, in case of butter fat, we found the Reichert-Meissl value to be 30.00, i. e., it required 30 cubic centimeters of N/10 potassium hydrate to neutralize the volatile acids obtained from five grams of butter fat as determined by the Reichert-Meissl process. Since the 30 cubic centimeters represent only 87 per cent. of the total volatile acid, then for the total volatile acids present in five grams of fat it would require 34.48 cubic centimeters of N/10 potassium hydrate. Then to find the number

⁴For the purpose of calculating the total volatile acids, the factor 87 was used; this being in agreement with Richmond and the work done at the Purdue Dairy Chemistry Laboratory.

of grams of potassium hydrate to neutralize the volatile acids in 100 grams of butter fat, we have the following proportion:

$$.005612 \times 34.48 \times 20 = 3.86 \text{ grams of KOH}$$

In order to calculate the molecular weight of the volatile acids, we first calculate the weight of the soluble acids. To do this we make use of the amount of insoluble acid or Hehner Value. The per cent. of insoluble acid was found to be 87.54, mean molecular weight 254.8. The molecular weight of the glycerides of the insoluble acids would be $(254.8)3 + 38 = 802.4$ mean molecular weight of the insoluble acids as triglycerides.⁵

Then from the following proportion we obtain the per cent., or parts per hundred of the triglycerides of the insoluble acids. $764.4 : 802.3 :: 87.54 : x$, $x = 91.87$ grams per hundred of glycerides of the insoluble acids.

Now $100 - 91.87 = 8.13$ glycerides of the soluble acids. Since $3\text{KOH} = 92$ parts of glycerol or 38 parts of C_3H_2 , then from the quantity of KOH required to neutralize the soluble acids in 100 grams of fat, which was found to be equal to 3.86 grams, we can calculate the per cent. of C_3H_2 combined with the soluble acids by means of the following proportion; $186.36:3.86::38:x$, $x = .87$ per cent. of C_3H_2 . If we subtract this from the glycerides of the soluble acid we have then the amount of soluble acids in 100 grams of butter fat.

$$8.13 - .87 = 7.26$$

and therefore the molecular weight is determined from the following proportion:

$x:56.12::7.26:3.86$, $x = 104.5$ mean molecular of the volatile acids in this sample of butter fat.

The mean molecular weight of the volatile acids of butter varies from 96 to 130 as recorded by Richmond and Lewkowitsch. This is quite natural and from the molecular weight of the different volatile acids entering into the glycerids we can expect a variation in the mean molecular weight. A slight variation of the different acids would cause a marked increase or decrease in the mean molecular weight. The molecular weights of the different volatile acids entering into the glycerids we can expect a variation in the mean molecular weight. This fact adds weight to the assumption that the proportion of volatile acids are not constant. A slight variation of the different acids would cause a marked increase or decrease in the mean molecular weight. The molecular weights of the different volatile acids entering into the triglycerides of butter fat are as follows:

⁵For the saponification of a triglyceride by KOH is expressed by the following equation.

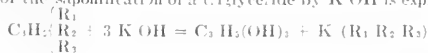

M. W. of $\text{C}_3\text{H}_5 = 41 \therefore 41 - 3 = 38$ since the 3 hydrogen atoms are taken by the acids.

Butyric acid.....	88
Capraic acid.....	116
Caprylic acid.....	146
Capric acid.....	172

V.

CALCULATION OF MIXED GLYCERIDES.

To calculate the mean molecular weight of the mixed glycerides of the butter fat we make use of the saponification value. This value represents the number of milligrams of potassium hydrate required to saponify one gram of fat. By use of the following equation for the saponification of any triglycerides.

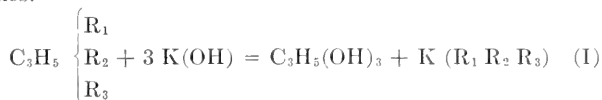

Then it follows directly that

$$x : 3(56.12) :: 1 : \text{Sap. Val. or } x \frac{3(56.12) \times 100}{\text{Sap. Val.}} \text{ mean molecular of the gly-}$$

ceride. Likewise we obtain the mean molecular weight of the mixed in-

$$\text{soluble acid } x = \frac{56.12 \times 100}{\text{Sap. Val.}^6} \text{ Mean molecular weight.}$$

VI.

CALCULATION OF GLYCEROL.

By making use of the saponification equation (I) in our calculation we can calculate the per cent. of glycerole in mixed triglycerides. From equation (I), $3 \text{K OH} = 92$ parts of glycerole, i. e., $3(56.12) = \text{C}_3\text{H}_5(\text{OH})_3 = 92$, molecular weight of glycerole or 56.12 grams of K OH correspond to 30.667 grams of glycerole, and from the saponification value we have the amount of K OH necessary to saponify one gram of fat. The amount of glycerole in one gram of fat is determined by use of the following proportion

$$56.12 : 30.667 :: \text{Sap. Val.} : x, x = \frac{30.667 \times \text{Sap. Val.}}{56.12}$$

amount of glycerole in one gram of fat and multiplying this by 100 gives the

⁶Saponifications values are expressed in milligrams in the calculations.

amount in 100 grams or the per cent. If in the above we substitute the saponification value as found in table I, for pure butter fat, we have

$$\frac{30.667 \times 230.1 \times 100}{56.12} = 12.57 \text{ per cent. of glycerole.}$$

The per cent. found by chemical determination was 12.58.

If we calculate the per cent. of C_3H_2 from the above relations (eq. I) and subtract this from 100 the difference give the total per cent. of both soluble and insoluble acids. This is apparent from the following equation by rearranging the molecule of the triglyceride.

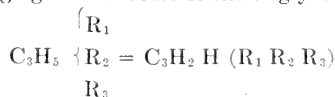

Referring to equation (I) we see that $3 (K OH) = C_3H_2$ where $C_3H_2 = 38$ therefore 56.12 grams of K OH corresponds to 12.667 grams of C_3H_2 and from the following relation we can calculate then the amount of C_3H_2 in one gram

$$\text{of fat. } 56.12 : 12.667 :: \text{Sap. Val.} : x, x = \frac{12.667 \times \text{Sap. Val.}}{56.12} = \text{grams of } C_3H_2$$

and multiplying this by 100 gives the amount per 100 grams or per cent. By using the saponification value as used in calculating the glycerole we have

$$\frac{12.667 \times 230.1 \times 100}{56.12} = 5.19$$

per cent. of C_3H_2 . This amount when subtracted from 100 gives the per cent. of mixed fatty acids

$$100 - 5.19 = 94.81$$

By chemical analysis the insoluble acids of pure butter fat (Table I) was 87.54, and from the method of calculation (p. 130) the soluble acids were found to be 7.26 per cent. The total acids then would be 94.80 per cent., while the total acids calculated from the value obtained for C_3H_2 would be 94.81 involving an error of .01 per cent.

VII.

THE RELATION OF THE MAUMENE VALUE TO THE IODINE VALUE.

From numerous determinations of the Maumené value and its relation to the unsaturated fatty acids, there undoubtedly exists a relation between the rise of temperature and the iodine value when adding concentrated sulphuric

acid to oils. The higher the iodine value the higher the rise of temperature. To obviate small variations of the strength of sulphuric acid, Thompson and Ballentyne (Chem. Zeit. 1909) proposed to refer the rise of temperature with fifty grams of fat and ten c.c. of sulphuric acid to the rise of temperature with fifty grams of water under exactly the same conditions and in the same vessel. The ratio of the rise of temperature of the fat to the rise of temperature of water, they express as the "specific temperature reaction" that is⁷

$$\frac{\text{Rise of temperature of fat} \times 100}{\text{Rise of temperature of water}}$$
 Specific temperature reaction. The follow-

ing table gives the rise of the temperature of butter fat (Maumené value), specific temperature reaction, iodine value and ratio of the Sp. T. R. to the iodine value.

TABLE II.

No.	Rise of Temp.	Specific Temp. Reaction.	Iodine Value.	Ratio of Specific Temp. Reaction to Iodine Value.
1	34.7° C	83.6	46.36	1.8
2	39.5° C	95.2	56.00	1.74
3	30.8° C	74.2	39.43	1.88
4	32.0° C	77.1	36.29	2.1
5	30.5° C	73.5	39.22	1.84
6	27.0° C	65.1	31.21	2.08
7	23.5° C	56.6	30.00	1.88
8	23.4° C	56.6	28.54	1.98
9	25.8° C	62.2	32.73	1.9

Rise of temperature of water 41.5° C.

From results recorded in Table II the ratio is quite uniform except Nos. 4 and 6. If no other factors would influence the rise of temperature except the unsaturated fatty acids it would seem possible to determine a factor

⁷This ratio is multiplied by 100 to avoid decimals.

such that when the Sp. T. R. is divided by this factor the quotient would express the iodine value, this seems possible with fresh oils or fats, but when fats are exposed to air, partial oxidation takes place and this increases the rise of temperature. The values in Table II, were determined from butter fat of different degree of freshness, which had not been exposed to the air.

In considering other constants both physical and chemical no fixed relation exists. While it is true that the per cent. of olein influences the refractive index, no quantitative relation exists between the refractive index and the per cent. of olein or oleic acid. This shows that oleic acid is not the only varying factor in butter fat influencing the refractive index. Since each acid entering into the glycerids of butter fat has its own specific refractive index, and from what has been said with reference to the mean molecular weights of the volatile acids, we must expect the physical properties to vary as the proportion of acids vary, which enter into the formation of a molecule of the triglyceride. The same reasoning applies to the insoluble acids. This variation of the proportion of the different fatty acids entering into the glycerides of butter fat, must also exert a varying influence on the physical properties, such as the refractive index, melting point, congealing point, specific gravity, etc.

DESCRIPTION OF CHEMICAL AND PHYSICAL CONSTANTS.

Solidifying Point.—The solidifying point indicates the temperature at which butter fat solidifies. When butter fat is heated to 40° C. or 50° C., then allowed to cool slowly, a point is reached when the temperature remains stationary. This depends on the property, that when substances solidify on cooling, the latent heat of fusion, is liberated and the rise of temperature due to the latent heat equals the lowering of the temperature of the fat. When the temperature reaches this stationary point, the reading of the thermometer is taken and is called the *solidifying point*.

Melting Point.—The melting point indicates the temperature at which butter fat melts. Various methods are used in determining the melting point. To obtain comparable results the same method must be used. It must also be borne in mind that fats do not show their normal melting point shortly after being melted and then cooled. After butter fat has been melted it should be allowed to cool at least twelve hours before the melting point is determined.

Refractive Index.—The refractive index expresses the ratio of the velocity of light in vacuum to that of the velocity of light in the medium under inves-

tigation. When light passes from a rarer medium into one of greater optical density the rays of light on entering the denser medium deviate towards the normal, the ratio of this deviation from the normal for the two media is constant and is called the refractive index with reference to the two media.

Specific Gravity.—Specific gravity expresses the ratio between masses of equal volumes of a substance and that of water taken as a standard. The masses of two bodies are proportional to their weights, the specific gravity

of a substance can be expressed thus: Specific gravity = $\frac{X}{Y}$, where X and Y rep-

resent the weights respectively of equal volumes of the substance and water.

Reichert-Meissl Value.—The Reichert-Meissl value expresses the number of cubic centimeters of decinormal solution of Sodium or Potassium hydrate required to neutralize the volatile acids obtained from five grams of butter fat by the Reichert-Meissl distillation Process. The Reichert-Meissl value does not represent the absolute amount of volatile soluble acids, but only indicates the relative amount of the volatile acids.

Saponification Value.—The saponification value expresses the number of milligrams of potassium hydrate required to saponify one gram of fat, its value depends on the molecular weight of the fatty acids. The lower the molecular weight the higher the saponification value.

Iodine Value.—The iodine value indicates the per cent. of iodine or iodine chloride absorbed by the fat. All unsaturated fatty acids have the property of absorbing iodine forming substitution compounds. In butter fats the oleic acid is the only unsaturated acid.

Insoluble Acids or Hehner Value.—This value represents the insoluble acids in fats. Inasmuch as fats are composed of mixed glycerides of fatty acids both soluble and insoluble, on saponification of the mixed glycerides, the fatty acids form salts with the liberation of glycerol. When the salts thus formed are decomposed by some mineral acid, the insoluble acids can be separated from the soluble acids and the per cent. of insoluble acids is called the *Hehner value*.

Maumene Value.—When mixing sulphuric acid with oils the temperature rises and varies with the source of the oils and their chemical composition, the rise being also greater for the drying oils than for the nondrying oils.

The rise of temperature for different oils is called the *Maumene value* of the oils.

Purdue University.

NASCENT STATE OF THE ELEMENTS.

BY J. H. RANSOM AND R. A. STEVENS.

It is well known that some of the elements at the instant of liberation from their compounds or when in contact with certain other materials are more chemically active than under other conditions. This so-called "nascent state" has for more than sixty years been assumed to be due to the atomic as distinguished from the molecular condition of the elements. In some of the more recent texts this explanation has been replaced either by one based upon thermodynamics or by that known as "contact or catalytic action."

The principle of thermodynamics is that those reactions will be most apt to occur which are accompanied with the greatest degradation of energy. On this principle is explained the fact that hypochlorous acid is a better oxidizing agent than free oxygen. The former decomposes with the evolution of heat and therefore the total energy evolved during oxidation with it is that much greater than would be produced with the use of free oxygen. Or as Mellor (*Inorganic Chem.*, p. 460) says regarding nascent hydrogen, "Its greater activity is ascribed to the energy of the reaction being available for inaugurating another reaction rather than being frittered away as heat." This is a fundamental principle and no doubt influences if it does not determine the course of reactions. But it does not seem to explain why iodic acid, which decomposes with the absorption of almost as much heat (per atom of oxygen) as hypochlorous acid evolves, oxidizes hydrogen iodide, in solution, much more rapidly than does free oxygen.

The contact explanation assumes that the presence of certain substances in contact with reacting materials increases the velocity of the action between those materials *solely* by its presence. According to this theory the increased activity of nascent hydrogen is due to its contact with the metal at the instant of liberation. If the presence of the contact agent forms the only difference between the active and inactive hydrogen then it would seem that intimate contact of the latter with the more positive metals should cause it to become active. This explanation of activity appears less fundamental than that due to the atomic condition of the

elements, but it is claimed that it offers a better explanation for the varying degrees of activity of hydrogen obtained from different sources and that it also explains the activity of hydrogen absorbed in metals.

The experiments described in this paper are designed to study the activity of hydrogen from various sources as shown in its action on chromic acid and chromates as well as on hydrogen peroxide and permanganates. These were chosen because they are not the most readily reduced or because their disappearance may be easily determined by color reactions. The attempt was made to study the effect of each of the substances which would need to be present for the reduction of the substance by nascent hydrogen. In the preparation of free hydrogen for use care was taken to remove any foreign material which might act as an oxidizing or reducing agent. Very dilute solutions of the oxidizing agents were used in order that a slight color change might be the better noticed. The acid was 30% C. P. sulphuric. Pure stick zinc was used, a dozen or more being bound together so that the lower end of the pile was concave, thus allowing hydrogen to collect and work its way up between the sticks. The results with potassium dichromate solution were as follows: Purified hydrogen passed into the aqueous or acidified solution caused only a very slight reduction in several hours of time. With zinc rods in the aqueous solution a very slight reduction could be noticed at the end of eight hours passage of the hydrogen. Nascent hydrogen generated in the solution caused a much more rapid reduction of the chromate.

Next a solution of chromium trioxide was made, the zinc rods were suspended in the solution and especially purified hydrogen caused to pass up around the bundle of rods several hours a day until the time amounted to 205 hours. During the time the air was excluded and the space above the liquid (the rods were only partly submerged) was an atmosphere of hydrogen. At the end of this time the solution was still distinctly yellow though slightly lighter in color than at the commencement.

The same kind of an experiment was repeated with potassium dichromate but platinum foil was substituted for the zinc rods. In order that the hydrogen might be divided into small bubbles and come into contact with as much platinum as was possible a platinum filtering cone was sealed into the end of the delivery tube and just above this was fastened a rosette made of strips of platinum foil. The hydrogen bubbles bumped against this foil as they rose through the liquid. Connection was made so that this platinum might be made the negative electrode for the production of nascent

hydrogen. In this series the hydrogen passed through the solution for only four hours. Little or no reduction occurred except when the platinum was made the negative electrode from a battery. Then reduction was quite rapid.

When zinc dust or platinum black was suspended in the liquid and hydrogen passed in the reduction approached the rapidity due to nascent hydrogen.

Similar experiments were carried out using carbon instead of platinum. New arc-light carbons were purified by first soaking them in acid and then heating them to redness for twenty minutes. They were then placed in a solution of acidified potassium dichromate until no reduction of the latter was observed. After thorough washing they were bound into a bundle and used in the same way as were the zinc rods. In the aqueous solution containing the carbons hydrogen produced little or no reduction of the dichromate in four and one-half hours. When the carbons were made the negative electrode from a battery reduction was complete in from fifteen to thirty minutes.

Finely divided carbon suspended in the solution of dichromate did not increase the reducing power of hydrogen led into the solution.

An attempt was made to duplicate the conditions for the production of nascent hydrogen by having both zinc and acid in the dichromate solution and then to prevent the formation of nascent hydrogen at the surface of the zinc by connecting the latter by wire to a piece of platinum placed in a different part of the solution and prevent diffusion of hydrogen by surrounding the zinc with a porous cup. The zinc was also made the positive electrode from a weak battery. But local action around the zinc produced a small amount of nascent hydrogen so that a slow reduction always occurred. It is still hoped that this may be made successful.

In this connection it is interesting to note that in order to eliminate local action amalgamated zinc rods were tried. But in the presence of these hydrogen caused a more rapid reduction of the dichromate than when they were made the negative electrode from a battery. The reason for this has not been determined and will be the subject of further inquiry.

The reduction of hydrogen peroxide was attempted using the platinum rosette as contact agent. No change in the amount of the peroxide could be detected with the usual tests for that substance after hydrogen had passed for four and one-half hours. But when the platinum was made the

negative electrode complete reduction occurred in about one-third the time.

In order further to compare the activity of nascent hydrogen made in contact with different metals pieces of sheet copper, tin and platinum as nearly equal in exposed area as possible were each made the negative electrode from a battery giving practically the same current. The cell contained the same quantity, in solution, of acidified dichromate. The hydrogen in all cases reduced the solution in about the same time.

Finally a glass tube about five feet long and one centimeter bore, sealed at one end, was filled with a good grade of granulated zinc whose surface had been cleaned by washing, in turn, with acid, water, ammonium hydroxide and large quantities of distilled water. A solution of chromic acid was made by dissolving a small quantity of chromium trioxide in water which had been purified by re-distilling ordinary distilled water from alkaline permanganate and using only the middle fraction which was again brought to boiling for a few minutes immediately before using. The tube containing the zinc was filled with this solution and then one-half of it replaced by well purified hydrogen free from air. The open end of the tube was connected to a smaller tube leading to a vessel of mercury to prevent the escape of hydrogen and to indicate any change in the volume of the latter. The tube was then placed on a table in a horizontal position so that one-half of the zinc was in the liquid and one-half in contact with the hydrogen. The tube remained in this position from January ninth to October seventeenth last. Except for two months during the summer the tube was observed daily. No change in pressure occurred except that due to changes of temperature, and no amount of hydrogen was evolved. The solution perhaps, became slightly lighter in color. On opening the tube the hydrogen burned quietly. A little sulphuric acid added caused the solution to become as dark as at the beginning. A little sediment was found in the tube which looked like zinc oxide. Acid and zinc added to the solution caused rapid reduction.

In connection with the same subject some preliminary work has been done on the reduction of potassium permanganate. Purified hydrogen passed into a dilute aqueous solution of the permanganate decolorized the solution in less than twelve hours forming a brown deposit. In the presence of platinum foil the reduction was more rapid, sometimes being complete in one hour. If the platinum were allowed to remain in contact with the solution for some time the reduction with hydrogen seemed to be even

more rapid. To get some idea of the part the metal might be playing a strip of platinum foil about a foot long was thoroughly cleaned and put into a glass tube. A dilute solution of permanganate was poured in to cover the metal, and the tube stoppered. Gradually a brown deposit appeared on the platinum and floating in the liquid. In twelve days the color was discharged. Treated with hydrochloric acid the brown solid gave the odor of chlorine. The same result was obtained when hydrogen was passed into a solution of permanganate containing granulated zinc. The colorless filtrate from the zinc was strongly alkaline, contained potassium, but only a trace of manganese.

In order to study this action more in detail some granulated zinc was allowed to stand in contact with a solution of the permanganate. Gradually reduction occurred the zinc becoming covered with a gold-yellow deposit. The reduction became slower as the deposit on the zinc increased. Finally the solution became colorless and gave an alkaline reaction.

In a roughly quantitative experiment two grams of permanganate were dissolved in especially purified water and this solution placed with a large quantity of zinc. The mixture was shaken periodically. In a month the liquid had become colorless. The liquid was filtered from the zinc and the latter thoroughly washed. Titration of this liquid with methyl orange, against a standard acid, gave 89 per cent. of the theory for the hydrolysis of the permanganate. As much as possible of the yellow solid was removed from the zinc and this with the finer particles was treated with nitric acid to dissolve any zinc. On treatment the solid darkened. Its weight was .9077 grams, and it gave chlorine with hydrochloric acid.

In order to understand what was the reducing agent in the above reaction a quantity of well cleaned zinc was placed in a flask with especially purified water. The flask was connected with a eudiometer filled with the same kind of water. The eudiometer was arranged so that the water might be displaced by a gas. Gradually hydrogen was formed. By stirring the zinc about the hydrogen passed into the eudiometer. In 35 days twenty-five cubic centimeters of hydrogen had collected. This burned quietly showing no admixture with oxygen. The experiment was then discontinued.

The results of the experiments with permanganate indicate that its solution is hydrolized and that the free acid is then reduced either directly by the zinc or by the nascent hydrogen produced by the action of zinc on

water or on the acid. The instability of the acid apparently plays a part especially in the presence of something which can combine with the oxygen or absorb it (in the case of platinum) and thus prevent equilibrium.

Very little work seems to have been done to determine the cause or causes of the increased activity of nascent elements. Most of the workers have assumed the atomic state as a sufficient explanation. Pattison Muir (*Prin. of Chem.*, p. 105) points out the need of considering all the reacting substances rather than that of the element only, and cites the work of Tommasi (*Pogg. Beiblätter* 2:205) who found that sodium amalgam would not reduce a solution of potassium chlorate but that hydrogen from zinc and dilute sulphuric acid would do so. Muir afterwards found that magnesium, sodium and even a copper-zinc couple would reduce (presumably slowly) an aqueous solution of potassium chlorate; but he seems to have overlooked the fact that with zinc and acid the substance reduced is not the chlorate but chloric acid, a much less stable material and consequently more easily reduced. Thorpe has found (*C. S. Journ. Trans.* 1882, 289) that the rate of reduction of ferric sulphate varies with the chances which hydrogen has of coming in contact with the material, and that the rate of reduction in unit time decreases with increased rate of hydrogen evolution. He also observed that the presence of certain salts, as zinc sulphate, decreased the rate of reduction, and that the nature of the metal used influenced the rate. Perhaps the most enlightening results were obtained by Traube (*Ber.* 15, 659, 2421, 2434; 16, 1201) in his work on the constitution of hydrogen peroxide. He found that when palladium is charged with hydrogen and made the positive pole of a battery no peroxide is formed but the nascent oxygen is reduced to water. But when such palladium is made the negative pole and molecular oxygen is bubbled around the pole peroxide is produced. If non-hydrogenized palladium is used the greatest amount of the peroxide is formed (only at the negative pole) when all the hydrogen produced is absorbed by the palladium, and the amount decreases as the amount of hydrogen more than this increases. With carbon poles no peroxide was produced at either pole. There seems to be no evidence, however, that hydrogen evolved from carbon poles did not reduce the oxygen, and it is probable that it was reduced to water either directly or through the peroxide as an intermediate product. The latter is the more probable since nascent hydrogen rapidly reduces the peroxide.

From the foregoing experiments the following conclusions appear justifiable. First, nascent hydrogen obtained from varying sources and in contact with different substances has about the same reducing power. And, second, gaseous hydrogen in contact with metals used to make nascent hydrogen is not made more active by that contact. If these conclusions *are* justifiable the argument upon which the "contact" explanation is based becomes greatly weakened. And it becomes still weaker when the first part of the work of Traube, described above, is considered. For if contact with palladium is the only cause of the activity of nascent hydrogen there is no reason why the same substance should not have formed at the two poles. It remains to show that the activity of absorbed hydrogen is not due to contact action.

Much work has been done in investigating the phenomena of absorption of gases by metals. From the volume of gas absorbed by different metals, as platinum, silver and nickel, Sieverts (*Zeit. fur Phys. Chem.* LX, 129 and LXVIII, 115) concluded that the absorbed element was in the atomic state. Richardson (*Phil. Mag.* VI, 266 and VIII, 1), in his studies on the diffusion of gases through metals came to the same conclusion, saying "This result can be explained by supposing that the hydrogen is dissociated and that the dissociated atoms pass freely through the platinum." Gladstone and Tribe in their work on "The Action of Substances on Nascent and Occluded Hydrogen" (*C. S. Journ.* 1879, 179, *Trans.*) say "Among other results of this investigation we may claim to have established still more fully the close likeness of character and therefore of condition between hydrogen usually denominated nascent and hydrogen occluded by metals." Also Bain in his work on the absorption of hydrogen by carbon (*Zeit. fur Phys. Chem.* LXVIII, 471) concludes that the absorbed hydrogen is in the atomic state. If these conclusions are justified the activity of absorbed hydrogen need not be longer considered as due to "contact" action. But if it still be found that contact does modify the activity of elements is it not a condition of chemical activity or a means of altering the velocity of a chemical change rather than an explanation? Does not the question remain, "Why, and in what manner they do so? Manganese dioxide accelerates the decomposition of potassium chlorate, but this fact does not throw any light on the mechanism of the reaction nor does it explain why the oxygen at the instant of separation is a better oxidizing agent than ordinary oxygen at the same temperature. Heat is a necessary condi-

tion for the rapid reduction of copper oxide by gaseous hydrogen, but it is in no sense an explanation of the chemical changes. To explain these it may be said that at the high temperature the molecules become unstable or actually begin to decompose into the various atoms and that these then combine to form molecules more stable at the temperature. The presence of acids makes possible the decomposition of water by electricity. The ionic theory offers a satisfactory explanation.

In contradistinction to the "contact explanation" stands the atomic-molecular idea. It is based upon established and almost universally accepted theories involving atoms and molecules, the relations between which have been used to explain differences in properties, and to account for constitutional and space isomerism, unsaturation and chemical activity. Assuming molecules then the atoms follow as a perfectly logical deduction. And if atoms they must separate from molecules as such during chemical reactions, for in many cases there is less than a molecule of the element in a molecule of the compound and even if there is they are not often united in the molecule. Moreover the ionic condition of the elements necessitates that the atoms exist at the instant of discharge of the electricity. Likewise combinations must often, if not always be preceded by decomposition of molecules into the constituent atoms. The addition of hydrogen to unsaturated molecules, as ethylene, must be preceded by the formation of atoms of hydrogen for these are found in different parts of the new molecule. The combination of sulphur dioxide with oxygen in the presence of platinum black must be preceded by the formation of atoms of oxygen for the new molecule contains but a half molecule of oxygen and at the high temperature the double molecule, S_2O_2 , is probably not formed. Even the formation of the molecules of water from hydrogen and oxygen must be preceded by the decomposition of both kinds of molecules, for in the molecule of water there is but half a molecule of oxygen and the atoms of hydrogen are not united to each other. The combination of ammonia with hydrogen chloride may be cited as another example for the hydrogen and chlorine are not united in ammonium chloride. It is doubtful if any molecules as such ever have any tendency to combine or to interact in any way. The conditions under which material is placed in order to stimulate chemical action is conceivably for the purpose of starting the decomposition of molecules into atoms which by combining evolve the energy to continue the decomposition. The ther-

mochemical change would not be affected by such a process because it depends only on the initial and final products.

Objection is made to the atomic-molecular explanation (Smith Inorganic Chemistry, p. 424) because it is used to explain the oxidizing activity of hypochlorous acid but is not often used to explain that of sulphuric acid or of double decompositions, as the action of sulphuric acid on salt. Concerning the former it may be said that it should be applied as rigidly in one case as the other. The pre-heating in the case of sulphuric acid may be considered as necessary for the decomposition of the acid to form atomic oxygen, and is often so considered. Concerning such actions as that of acid on salt it may be replied that they are explained by as "fairy" a theory, viz., the electron modification of the ionic theory.

Even if the activity of nascent hydrogen is finally found to vary greatly with the sources of its production the atomic-molecular explanation will still be sufficient. For the absorbing or atomizing power of the elements varies greatly; and for those having little atomizing power the smoothness and other characteristics of the superficial surfaces must determine the relative chances of the atoms meeting to form molecules or of acting on the other material present.

The investigation of the subject will be continued as opportunity offers.

THE PENETRATION OF WOOD BY ZINC CHLORIDE.

BY EDWARD G. MAHLN.

During the last fifteen years the supply of all kinds of sawed lumber has rapidly diminished. The consequent rise in prices has stimulated the use of methods for prolonging the life of structural timbers that are exposed to excessive weather conditions. Treatment of such timbers to prevent decay has been practically limited, in a commercial sense, to impregnation of the wood with creosote oils or with antiseptic salt solutions, the salt most extensively used being zinc chloride. Against the use of creosote oils two objections have been urged, these being the somewhat excessive cost of the preserving material and the tendency of the lighter fractions of the oils to evaporate under the influence of wind and sun.

While the cost of the zinc chloride would not prohibit its use, it has been noticed for a long time that exposure for a term of years seemed to cause a loss of the efficiency of the preservative. This was long thought to be due to the fact that from moist wood the zinc chloride was gradually lost through a process of outward diffusion similar to that causing "efflorescence" of salts on brick walls. This theory was apparently confirmed by the fact that analysis of old treated wood showed the presence of little zinc chloride in the interior of the piece. In order to remove this objection a process¹ was devised abroad and in 1908 was patented in the United States, for treating wood with zinc chloride, with the addition of aluminium sulphate. It was thought at the time and was originally claimed by the patentees that this process resulted in a fixation of the zinc salt within the wood fibers in such a manner as to practically prevent the outward diffusion and consequent loss of the preservative. It was their theory that some sort of compound was produced between the cellulose of the wood cells and the aluminium sulphate, this compound resulting in a retaining action upon the zinc chloride. The action was likened to the imperfectly understood action of aluminium salts when used as mordants in dyeing. Experiments with washing treated sawdust did not confirm this theory but later unpublished investigations showed that solutions of zinc chloride containing aluminium sulphate, under the same conditions of treatment, penetrated wood ties farther than did solutions of zinc chloride alone, the zinc salt having the same concentration in the two solutions.

¹ The Bruning-Marmetschke process. U. S. patent No. 898,246.

It is a well known fact that zinc chloride in solution hydrolyzes to a considerable extent so that zinc hydroxide or basic zinc chloride precipitates, often in large quantities. The addition of a strong acid redissolves the precipitate, as does also the addition of aluminium sulphate. This solvent action of aluminium sulphate is, without doubt, due to the fact that it also hydrolyzes readily in solution, the resulting sulphuric acid thereby acting to repress the hydrolysis of the zinc chloride. The concentrations of the two salts used in the new process are zinc chloride 3%, aluminium sulphate 1.5%. Such a solution is usually clear, so far as any visible precipitate is concerned. Aluminium sulphate is thus seen to be of use in preventing the precipitation and consequent loss of zinc chloride in the impregnating solution, but there remains unexplained the reason why two *clear* solutions, containing the same concentration of zinc, should penetrate the wood substance to different depths, the solution of the two salts apparently always going farther than the solution of the single salt. It was in order to find, if possible, an explanation of this difference in penetrating power, that the experiments later described were undertaken.

The colloidal character of both zinc hydroxide and aluminium hydroxide is well known. It seemed likely at the outset that even in clear solutions of zinc or aluminium salts there must exist products of hydrolysis in a colloidal condition, consisting of sols of basic salts or even of the hydroxides themselves. If this were the case, since the hydrolysis of zinc chloride is repressed by the presence of the sulphuric acid formed by the hydrolysis of aluminium sulphate, the clear solution of the composite solution should contain less colloidal and more crystalloidal zinc salt than the single solution. The cellulose composing the wood cells is a vegetable colloid and it is not possible for other colloids to diffuse through it. In other words, the wood cells will act as membranes in carrying on a process of dialysis, retaining colloidal material and allowing crystalloidal material to pass. If the solutions possess the difference in character as above described it is easy to see that a difference in penetrating power must follow. The following experiments were undertaken to determine whether zinc chloride solutions in water contain more crystalloidal zinc when aluminium sulphate is present than when it is not present.

EXPERIMENTAL.

Two solutions were prepared, each containing exactly 3% of zinc chloride. To one of these aluminium sulphate was added to the amount of 1.5%.

In making the solutions a quantity of zinc chloride was weighed out and dissolved in such an amount of water as to make a solution somewhat stronger than 3%. Some precipitate was formed and this was filtered out, the remaining clear solution being then standardized and diluted to the required strength. Colloidal membranes were prepared by coating vegetable parchment, of as uniform thickness as possible, with collodion. These were fastened on the ends of tubes having a diameter of about five centimeters, the tubes being of equal cross-section. Of the respective solutions 50 cc. were placed in separate tubes and the latter were immersed in separate beakers of distilled water, adjustment being made so that the water outside was at the same level as the solutions inside. No attempt was made to keep the temperature constant but changes in temperature affected the tubes alike. After certain periods of time, as stated in the tables below, the beakers containing the water and the diffused zinc salt were removed and substituted by beakers containing fresh water. The zinc which had diffused through the membranes was determined by titration with standard solution of potassium ferrocyanide, uranium nitrate being used as indicator. The amount of water placed outside the membranes was, in every case, 100 cc. The standard solution of potassium ferrocyanide was of such concentration that 1 cc. was equivalent to 0.00455 gram of zinc.

In order to correct for any possible difference in thickness or permeability of the two membranes the solutions were interchanged after 234 hours, each solution thereafter diffusing through the membrane that had previously held the other.

In the tables the symbols have the following significance:

B. M. = solution of zinc chloride 3% and aluminum sulphate 1.5%,

B. P. = solution of zinc chloride 3%,

t = hours for each period of diffusion,

T = total hours before reversal of membranes,

T_r = total hours after reversal of membranes,

m = milligrams zinc chloride diffused each period, B. M.,

M = total milligrams zinc chloride diffused, B. M.,

M_r = total milligrams diffused after reversal, B. M.,

p = milligrams zinc chloride, diffused each period, B. P.,

P = total milligrams diffused, B. P.,

P_r = total milligrams diffused after reversal, B. P.,

C_m = milligrams zinc chloride left in B. M. = 1500 — M,

C_p = milligrams zinc chloride left in B. P. = 1500 — P.

TABLE SHOWING RESULTS OF DIALYSIS.

t	T	Tr	m	M	Mr	p	P	Pr	m/p	p/m	Cm	Cp	$\frac{m.Cp}{p.Cm}$	$\frac{p.Cm}{m.Cp}$
18	18	...	12.74	12.74	5.00	5.00	2.55	1487	1495	2.56
24	42	...	9.10	21.84	3.64	8.64	2.50	1478	1491	2.52
24	66	...	20.93	42.77	5.91	14.55	3.54	1457	1485	3.61
27	93	...	29.57	72.34	14.11	28.66	2.09	1528	1471	2.22
24	117	...	24.57	96.91	15.47	44.13	(1.59)	1403	1456	(1.65)
24	141	...	35.21	130.12	13.19	57.32	2.52	1370	1443	2.65
20	161	...	26.85	156.97	11.83	69.15	2.27	1343	1431	2.42
24	185	...	34.12	191.09	14.10	83.25	2.42	1309	1417	2.62
24	209	...	31.85	222.94	14.10	97.35	(1.61)	1277	1403	(1.76)
25	234	...	35.95	258.89	15.02	112.37	2.39	1241	1388	2.76
23	...	23	15.47	274.36	15.47	31.39	143.76	31.39	2.03	1226	1326	1.83
34	...	57	19.11	293.47	34.58	25.93	169.69	57.32	1.36	1207	1330	1.23
18	...	75	12.74	306.21	47.32	19.11	188.80	76.43	1.50	1194	1311	1.37
25	...	100	15.01	321.22	62.33	18.65	207.45	95.08	1.24	1179	1293	1.13
21	...	121	12.74	333.96	75.07	17.75	225.20	112.83	1.39	1166	1275	1.27
24	...	145	12.29	346.25	87.36	24.57	249.77	137.40	2.00	1154	1250	1.85
48	...	193	11.83	358.08	99.19	20.47	270.24	157.87	1.73	1142	1230	1.61
32	...	225	15.47	373.55	114.66	31.39	301.63	189.26	2.03	1126	1198	1.91

$$\text{Average } \frac{m.Cp}{p.Cm} = 2.45,$$

$$\text{Average } \frac{p.Cm}{m.Cp} = 1.52$$

The average relative rates of diffusion of the zinc in the two solutions will depend upon two conditions: (a) the relative permeability of the membranes and (b) the relative concentrations of zinc salt. If the relative concentrations should undergo no change, through the more rapid diffusion of one solution, the reversal of membranes should change the rates of diffusion so that the value of m/p before reversal should exactly equal the value of p/m after reversal. An inspection of the table shows that the membrane in which B. M. was enclosed before reversal was thinner or less dense, or, from some other reason, more permeable than the other, so that more rapid diffusion took place through this membrane and the solution so enclosed was more rapidly diluted than the other. In order to correct for the resultant change in concentrations the relative rates of diffusion, m/p and p/m , were divided by the relative concentrations, C_m/C_p and C_p/C_m the resultant corrected values being tabulated as $\frac{m}{p} \cdot \frac{C_p}{C_m}$ and $\frac{p}{m} \cdot \frac{C_m}{C_p}$. Since the actual concentration of zinc was the same in the two original solutions, the average corrected ratios should be equal unless the zinc were partly in the colloidal, and hence non-diffusible, condition and this to a different extent in the two solutions. The table shows that the average corrected ratio of diffusion of B. M. to B. P. before reversal was 2.45 while the average corrected ratio of diffusion of B. P. to B. M. after reversal was 1.52. The actual concentration of diffusible zinc was therefore greater in the B. M. solution. This actual concentration of diffusible, crystalloidal zinc will be called the "effective concentration."

Let M_e = effective concentration of zinc in B. M.,

P_e = effective concentration of zinc in B. P.,

T = thickness (or density) of membrane first containing B. M.,

T' = thickness of membrane first containing B. P.,

D_m = average rate of diffusion of B. M. before reversal,

D_p = average rate of diffusion of B. P. before reversal,

D_m' = average rate of diffusion of B. M. after reversal,

D_p' = average rate of diffusion of B. P. after reversal,

k = a constant, depending upon the temperature;

also let $a = D_m/D_p = 2.45$ and

$$b = D_p'/D_m' = 1.52.$$

Using these symbols,

$$M_e = kD_m T = kD_m' T',$$

$$P_e = kD_p T' = kD_p' T;$$

$D_m = Me/kT$, $D_p = Pe/kT'$, $D_m' = Me/kT'$, $D_p' = Pe/kT$; therefore

$$a = MeT'/PeT \text{ and } b = PeT'/MeT,$$

$$a/b = Me/Pe.$$

$$Me/Pe = a/b.$$

Substituting the values of a and b as given above, $Me/Pe = 2.45/1.52 = 1.27$.

This ratio of effective concentrations confirms the hypothesis that even clear solutions of zinc chloride contain colloidal products of hydrolysis. Aluminum sulphate, through its own hydrolysis and the formation of free sulphuric acid, causes a partial repression of the hydrolysis of zinc chloride and in 3% zinc chloride solutions, such as are used in wood preserving, there is approximately 80% as much zinc present in true solution as is the case when 1.5% of aluminum sulphate has been added. The remaining zinc is in the form of a hydrosol of basis zinc chloride or of zinc hydroxide and cannot pass into the interior of treated wood but must be left in the outer layers. It is to be expected that any other easily hydrolyzed salt of a strong acid would have a similar effect upon the penetration of zinc salts into wood. The use of free acid itself would have the same effect if it were used intelligently.

Further experiments are now in progress.

Purdue University,
November, 1912.

A BIOMETRIC STUDY OF THE STREPTOCOCCI FROM MILK AND FROM THE HUMAN THROAT.*

BY C. M. HILLIARD.

Two hundred and forty-two pure strains of streptococci isolated from milk and from the human throat have been compared as to their morphology, Gram stain and gentian violet reaction by the plate method, and their quantitative acid production in seven carbohydrate and related organic media. Hemolysis was studied with 92 strains.

We have been able to make no correlation between the length of chain or the relation to violet stain with any other character.

Seventeen out of 92 cultures gave hemolysis when streaked on blood agar plates. Five of these cultures came from normal milk, five—the most vigorous hemolizers—were from milk where udder trouble was indicated in the cow, and seven were normal throat forms.

The seven substances tested showed a definite order of availability for acid production. This order ("metabolic gradient") and the per cent. of cultures yielding 1.2% or more of acid when grown at 37 C for three days is shown in the following table:

Glucose (Monosaccharide)	98.0%
Lactose (Disaccharide)	76.0%
Saccharose (Disaccharide)	65.5%
Salicin (Glucoside)	42.7%
Raffinose (Trisaccharide)	37.5%
Inulin (Starch)	9.0%
Mannite (Hexahydric alcohol)	1.5%

It will be noted that the degree of availability is closely associated with the size and complexity of the substance.

According to the positive reaction—over 1.2% acid—in the test substances, 88% of the cultures may be placed in eight groups.

The following features separate milk from throat streptococci: (1) Milk organisms yield over 2.5% acid in lactose and saccharose at 37 C. (2) They seldom ferment a substance higher in the metabolic series

*Full Report in Jour. Ind. Dis. Vol. XII, No. 2.

than saccharose. (3) They readily ferment dextrose, lactose, and saccharose at 20 C. On the other hand, throat streptococci (1) seldom yield over 2.5% acid in any substance. (2) Over 40% of the cultures yield over 1.2% acid in either salicin or raffinose. (3) At 20 C they almost never attack any of the seven test substances.

ON THE ATOMIC STRUCTURE OF ENERGY.

BY A. E. CASWELL.

For a number of years it has been well known that a number of the theoretical results of the classical thermodynamics are not in accord with experiment. This is especially true in domains of radiation and specific heats, and does not mean that these results are invalid, but, rather, while they contain truth they do not contain the whole truth. Eminent physicists have endeavored to formulate a theory the conclusions of which shall be true to fact. The "Quantum Hypothesis" of Planck, which involves certain assumptions relating to energy, seems to furnish the basis for such a theory. It is

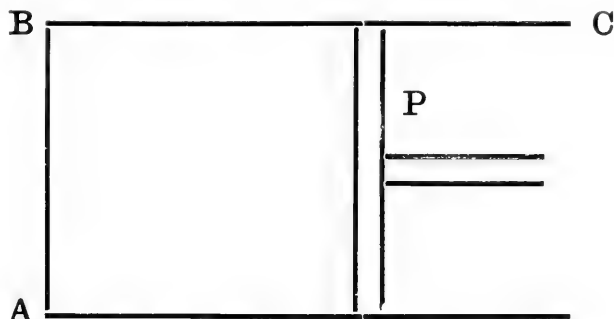

Figure 1.

A. E. Caswell—On the Atomic Structure of Energy.

the purpose of this paper to present some of the difficulties which are insurmountable on the basis of the older theory but are explainable on the basis of this hypothesis, and to indicate some of the results of the new theory and its bearing upon our conception of the nature of energy.

Two important laws of radiation which have been derived from the older theory are the Stefan-Boltzmann¹ Law and the Wien² Displacement Law. The former was proposed by Stefan in 1879 and was based upon the fact that Tyndall had found the ratio of the energy radiated by a platinum wire at 1200° C. to that radiated at 525° C. to be 11.6. The law states that *the energy radiated by a black body is proportional to the fourth power of the absolute*

¹Wien. Akad. Sitz. 79, p. 391, 1879; Wied. Ann. 22, pp. 31 and 291, 1884.

²Ann. der Physik, 58, p. 662, 1896.

temperature, or $E = k(T^4 - T_0^4)$. The law has been amply verified for a black body by the experiments of Lummer and Pringsheim³, but is not strictly true for other bodies. Boltzmann deduced the law theoretically in the following manner.

According to the electromagnetic theory of light, light exerts a pressure on any perfectly reflecting plane surface which is perpendicular to the direction of the light numerically equal to the energy density of the radiation. When light is incident in all directions we may assume one-third of it traveling in each of three mutually perpendicular directions, and so the pressure exerted upon the walls of a perfectly reflecting vessel filled with radiation would be equal to one-third of the energy density. Let AC (Fig. 1) be a cylinder of unit cross-section and length a , having perfectly reflecting sides and a perfectly reflecting piston P, but the end AB is a perfectly black body at a temperature T . Then the space between AB and P will be filled with radiation of energy density u corresponding to the temperature T . When equilibrium is established replace AB by a perfectly reflecting plate, and push the piston P in from a point distant x from AB to a point distant $(x - dx)$. The total amount of energy supplied, dQ , is equal to the increase of the internal energy, dU , plus the external work performed, dW . Therefore

$$dQ = dU + dW = d(xu) + p \, dx = x \, du + \frac{4}{3}u \, dx.$$

If φ is the entropy, then

$$d\varphi = \frac{dQ}{T} = \frac{x}{T} \, du + \frac{4u}{3T} \, dx = \frac{\partial \varphi}{\partial u} \, du + \frac{\partial \varphi}{\partial x} \, dx.$$

$$\therefore \frac{x}{T} = \frac{\partial \varphi}{\partial u} \text{ and } \frac{4u}{3T} = \frac{\partial \varphi}{\partial x}, \text{ or } \frac{\partial^2 \varphi}{\partial u \partial x} = \frac{\partial}{\partial x} \left(\frac{x}{T} \right) = \frac{\partial}{\partial u} \left(\frac{4u}{3T} \right).$$

Since T is independent of x

$$\frac{1}{T} = \frac{4}{3} \left(\frac{1}{T} - \frac{u \, dT}{T^2 \, du} \right), \text{ or } \frac{du}{u} = \frac{4dT}{T}.$$

(1) $u = kT^4$, where k is a constant.

Suppose that instead of the case above considered we take the case of a small radiating body at the center of a hollow sphere having perfectly reflecting walls. Then ur^2 will be constant, where r is the distance from the center of the sphere. Then $U = 4\pi \int_0^r ur^2 dr = 4\pi r^3 u$, u being in this case the energy density at the surface of the sphere. The radiation pressure on the

³Ann. der Physik, 63, p. 395, 1897.

whole surface is $4r^2u$, since all the radiation is incident normally. Then if the radius of the sphere decreases by a small amount dr

$$(2) \quad dQ = dU + dW = 4\pi[d(r^2u) + r^2u \, dr] = 4\pi r^2 (r \, du + 4u \, dr).$$

Proceeding as before we may deduce the Stefan-Boltzmann Law from this equation, showing that the law is true for radiation from a point source.

The second law mentioned above is the Wien Displacement Law which states that *the product of the wave-length and the absolute temperature is a constant*, or $\lambda T = \text{constant}$. In other words, if radiation of a particular wave-length is adiabatically altered to another wave-length the temperature changes in the inverse ratio. To prove this let us consider the sphere of the preceding paragraph. Let it expand with a constant radial velocity v , and let the velocity of the radiation be V . Then, by Doppler's principle, the wave-length will be increased at each reflection. Let $\lambda_0 =$ the original wave-length, $\lambda_n =$ wave-length after n reflections, and $t =$ time elapsing between the instant when one wave is reflected and the instant when the next succeeding wave is reflected. Then

$$\lambda_1 = \lambda_0 + 2vt = \lambda_0 + 2v \left[\frac{\lambda_0 + vt}{V} \right], \text{ or eliminating } t$$

$$\lambda_1 = \lambda_0 + \frac{2v\lambda_0}{V-v} = \left[\frac{V+v}{V-v} \right] \lambda_0.$$

$$\therefore \lambda_n = \lambda_0 \left[\frac{V+v}{V-v} \right]^n.$$

While the surface of the sphere moves out a distance dr the wave will travel

a distance $\frac{V \, dr}{v}$, and since the diameter is $2r$, the number of reflections which

will occur is $n = \frac{V \, dr}{2rv}$. Consequently $\lambda_n = \lambda_0 \left[\frac{V+v}{V-v} \right]^{\frac{V \, dr}{2rv}}$, and the value

of λ corresponding to an expansion dr is $\lambda = \text{Limit of } \lambda_0 \left[\frac{V+v}{V-v} \right]^{\frac{V \, dr}{2rv}}$, or λ

$= \lambda_0 \left[1 + \frac{dr}{r} \right]$, when $\frac{V}{2v}$ approaches infinity and the squares and higher

powers of $\frac{v}{V}$ and $\frac{dr}{r}$ are neglected.

Put $d\lambda = \lambda - \lambda_0$, and $\frac{d\lambda}{\lambda} = \frac{dr}{r}$, or since $dQ = 0$, $r \, du + 4u \, dr = 0$, by

equation (2), and $\frac{du}{u} + 4\frac{d\lambda}{\lambda} = 0$. On integration this gives

$$(3) \left(\frac{\lambda}{\lambda_0} \right)^4 = \frac{u_0}{u} = \frac{T_0^4}{T^4}, \text{ or}$$

$$(4) \lambda T = \lambda_0 T_0 = \text{constant.}$$

Wien's displacement law may be extended so as to give a general formula for the distribution of energy in the spectrum, viz., $E_\lambda = C\lambda^{-5} f(\lambda T)$, where E_λ is the emissive power for radiation of wave-length λ and C is a constant. To prove this let r_0 change to r , then radiations of wave-lengths between λ_0 and $(\lambda_0 + d\lambda_0)$ will be changed to those of wave-lengths between λ and $(\lambda + d\lambda)$.

$$\text{Also } \lambda = \frac{r}{r_0} \lambda_0, \text{ and } \lambda + d\lambda = \frac{r}{r_0} (\lambda_0 + d\lambda_0), \text{ whence } \frac{d\lambda}{d\lambda_0} = \frac{r}{r_0} = \frac{\lambda}{\lambda_0}.$$

From (3) $\frac{du}{du_0} = \left(\frac{\lambda_0}{\lambda} \right)^4$. But du is proportional to $E_\lambda d\lambda$. Therefore

$$\frac{E_\lambda d\lambda}{E_{\lambda_0} d\lambda_0} = \frac{du}{du_0} = \left(\frac{\lambda_0}{\lambda} \right)^4, \text{ or } \frac{E_\lambda}{E_{\lambda_0}} = \frac{\lambda_0^5}{\lambda^5}. \text{ Since equation (4) holds we may write}$$

$$(5) E_\lambda = \lambda^{-5} E_{\lambda_0} \lambda_0^5 = C\lambda^{-5} f(\lambda T).$$

All general distribution formulae must satisfy this equation. It remains to determine the form of the function $f(\lambda T)$. The particular form will depend upon the assumptions made. Wien found

$$f(\lambda T) = e^{-\frac{C}{\lambda T}}, \text{ or } E_\lambda = C_1 \lambda^{-5} e^{-\frac{C_2}{\lambda T}}.$$

For large values of λ and T this formula fails. Lord Rayleigh proposed the formula $E_\lambda = C_1 \lambda^{-4} T e^{-\frac{C_2}{\lambda T}}$. This formula fails for small values of λ and T . About 1901 Planck proposed the formula

$$E_\lambda = \frac{C_1 \lambda^{-5}}{\left(e^{\frac{C_2}{\lambda T}} - 1 \right)}.$$

This formula agrees with experiment and approaches the formulæ of Wien and Rayleigh for the range of values for which each holds best. It has already supplanted Wien's to a considerable extent in commercial practice with high temperature furnaces.

This formula is based on a new and startling hypothesis which has come to be known as the "Quantum Hypothesis," to which reference has already been made. The importance of the new hypothesis is made apparent by the following quotations. Nernst⁴ says, "If Newton, when he created modern mechanics, paved the way to the results of theoretical physics, if Dalton in the atomic theory gave physics and chemistry their most fruitful logical

⁴Preuss. Akad. Wiss., Berlin, Sitz. Ber. 4, pp. 65-90, 1911.

tools, then Planck in the quantum hypothesis has in his turn discovered a wholly new method of scientific calculation, and in fact this hypothesis, already so useful, is not a mere atomic theory of energy but in reality something wholly new, because the quantum can assume any chosen value from zero upward according to the motion of the atom concerned." The late Henri Poincaré wrote concerning it: "The new conception is seductive from a certain standpoint: for some time the tendency has been toward atomism. Matter appears to us as made up of indivisible atoms; electricity is no longer continuous, not infinitely divisible, it resolves itself into equally charged electrons; we have also now the magneton, the atom of magnetism. From this point of view the quanta appear as atoms of energy."⁵

The physical assumptions which Planck makes may be summarized as follows:⁶

(1) A system of many linear Hertzian oscillators, having a common period of vibration and so spaced as not to exert direct influences upon one another, are contained in a vacuum bounded by perfectly reflecting surfaces and filled with stationary black radiation.

(2) These oscillators only absorb and emit energy in the form of electrodynamic wave radiation.

(3) The vibration energy of an oscillator is given by the equation

$$U = \frac{1}{2} Kf^2 + \frac{1}{2} L \left(\frac{df}{dt} \right)^2, \text{ where } f = \text{electric moment of the oscillator, and } K$$

and L are positive constants.

(4) Emission only occurs when the vibration energy U is any whole number of times the energy-element, the so-called "*Elementar-quantum*,"

$E = h\nu_0$, where ν_0 is the frequency of the oscillator and is equal to $\frac{1}{2\pi} \sqrt{\frac{K}{L}}$, and h is a universal constant, the so-called "*Wirkungs-quantum*," and is equal to $6.55 \div 10^{-27}$ erg-seconds.

Whether the oscillator will actually absorb or emit energy at such times depends upon circumstances. If, however, emission occurs then the whole energy of vibration is emitted and the vibration ceases. Then through new absorption the energy again increases. Some writers on the "quanta theory" argue that the oscillators must absorb as well as emit energy in discrete amounts. It is claimed, for instance, that Einstein's formula for specific

⁵Journ. de Phys. 2, Ser. 5, pp. 5-34, 1912; *ibid* 2, Ser. 5, pp. 347-360, 1912.

⁶Ann. der Phys. 4, pp. 553-563, 1901; *ibid* 31, pp. 758-768, 1910; *ibid* 37, pp. 65-90, 1911.

heats, mentioned below, is not true unless this is so. This, apparently, is not Planck's view as he seems to consider the oscillators as absorbing energy continuously.

(5) The law of emission is: *The ratio of the probability that emission shall not occur, to the probability that emission shall occur, is proportional to the intensity of the vibration exciting the oscillator.* This intensity is defined by the equation $E_z^2 = \int_n^{\infty} \bar{I}_\nu d\nu$, where E_z = the component of the electric intensity in the direction of the axis of the oscillator, and as before ν = frequency of the vibration. The constant of proportionality for any given period may be determined by means of Rayleigh's law of energy distribution.

By means of these assumptions the properties of the stationary state, the entropy and temperature of a system of oscillators as well as the distribution of energy in the spectrum of black-body radiation are completely determined. Planck bases his expression for absorption on electrodynamic considerations, those for emission and energy distribution upon statistical ones.

Planck's calculations will not be reproduced here, the mathematical processes being merely indicated and some of the results stated. Basing his investigation relating to the absorption of energy upon the equations given under assumptions (3) and (5) and the additional equation

$$Kf + L \frac{d^2f}{dt^2} = E_z, \text{ Planck finds that in the interval of time between two}$$

successive emissions the energy U increases uniformly according to the

$$\text{equation } \frac{dU}{dt} = \frac{I_0}{4L}.$$

The mode of emission will obviously depend upon the theory of probability. Planck finds that, when P_n is the probability that the energy of an oscillator lies between $n\epsilon$ and $(n+1)\epsilon$ and τ is the probability that the energy of the oscillator shall be a whole number of times ϵ , the average energy of an oscillator is given by the equation

$$U = \sum_0^{\infty} P_n \left(n + \frac{1}{2} \right) \epsilon = \left(\frac{1}{\tau} - \frac{1}{2} \right) \epsilon.$$

$$\text{Also } U = \left(pI + \frac{1}{2} \right) \epsilon, \text{ or } \frac{1}{\tau} = 1 + pI.$$

The value of p is found to be $\frac{3e^2}{32\pi^2\nu^3h}$, where c is the velocity of light.⁷

⁷Verh. Deutsch. Phys. Ges., 5, 3, Feb. 1911.

The entropy of a system of N oscillators is also shown to be

$$S_n = -kN \sum_0^{\infty} P_n \log P_n^s, \text{ and since } P_n = (1 - \eta)^n \eta,$$

$$\frac{1}{T} = \frac{dS}{dU} = \frac{k}{E} \log \left(\frac{U + \frac{1}{2}}{\frac{U}{\epsilon} - \frac{1}{2}} \right), \text{ or since } E = h\nu, U = \frac{\nu h}{2} \left(\frac{e^{\frac{h\nu}{kT}} + 1}{\frac{h\nu}{e^{kT}} - 1} \right)$$

Finally, the vibration intensity of black-body radiation is

$$I = \frac{1}{\nu} \frac{1}{\left(e^{\frac{h\nu}{kT}} - 1 \right)_j}$$

When $T = 0$, $I = 0$, but $U = \frac{h\nu}{2}$. This "Energierest," or energy residue⁹

is independent of the temperature, and is of importance in connection with specific heats and radio-active transformations. Planck's radiation formula readily follows from the above equation.

Planck finds the following values for k and h . $k = 1.35 \div 10^{-16}$, and $h = 6.55 \div 10^{-27}$ in C. G. S. units. Using these values together with

$$\frac{e}{m} = 1.77 \div 10^8, e = 4.69 \div 10^{-7}, c = 4.68 \times 10^{10}, \text{ and } e = 3 \times 10^{10}, \text{ the}$$

mean number of undisturbed vibrations is found to be $1.37 \cdot 10^{11} \lambda e^{\frac{1.46}{\lambda T}}$,

or $1.37 \times 10^7 e^{\frac{14600}{\lambda T}}$, if λ is measured in μ . In the same units the emission

number of an oscillator per second is $2.18 \times 10^7 e^{-\frac{14600}{\lambda T}}$, and the mean ac-

cumulation time is $4.58 \times 10^{-8} \lambda^2 e^{\frac{14600}{\lambda T}}$. The equations used to obtain the three preceding results are, respectively:

$$\text{Number of vibrations} = \frac{3e^3 L}{8\pi^2 \nu} e^{\frac{h\nu}{kT}}$$

$$\text{Emission number} = \frac{8\pi^2 \nu^2}{3e^3 L} e^{-\frac{h\nu}{kT}} N,$$

⁹Berliner Ber., 5, 13, July, 1911.

⁹Ann. der Physik, 26, p. 30, 1908.

$$\text{Time between two successive emissions} = \frac{3e^3 L}{8\pi^2 \nu^2} e^{-\frac{h\nu}{kT}}$$

Larmor¹⁰ in an expansion and generalization of ideas implied in Planck's theory divides a system which is a seat of energy into elementary receptacles of energy called "cells." The "element of disturbance" possessing the element of energy under consideration is as likely in its travels to occupy any one of these cells as any other. Instead of the relation $\epsilon = h\nu_0$, which Planck obtains, Larmor finds that the ratio of the energy-element to the extent of his standard cell is an absolute physical quantity. Larmor claims that his theory evades an atomic constitution of energy although this seems to be open to argument. Planck believes that his constant h provides for Larmor's "elements of disturbance." Larmor's radiation formula reduces to that of Planck.

Jeans¹¹ has worked out a rather complete and satisfactory electron theory of metals, but when applied to radiation his results, expressed in terms of a single universal constant, are in conflict with experiment. Planck considers that Jeans' formula requires a second universal constant which he identifies with h , the "wirkungs-quantum," Jeans' formula being a special case where $h = 0$.

Let us now turn to some of the experimental facts which can be accounted for on the basis of the quantum hypothesis. The agreement with the experimental facts of radiation has already been mentioned.

The experimentally determined specific heats of crystalline substances, especially at low temperatures, do not agree with the older theories, but Einstein¹² by applying the quantum hypothesis to this case has deduced the

$$\text{formula } c = 3R \sum \frac{\epsilon^{\nu}}{e^{\frac{\epsilon^{\nu}}{T}} - 1}, \text{ where } R \text{ is the gas constant, } \epsilon \text{ a positive constant, and } \nu \text{ and } T \text{ as before, are the vibration frequency and the absolute temperature.}$$

Nernst and Magnus have found that this formula is only approximate and have added a term bT^3 .¹³ This formula agrees with the results

¹⁰Roy. Soc. Proc., Ser. A, 83, pp. 82-95, 1909.

¹¹Phil. Mag., 17, pp. 773-794, 1903; *ibid* 18, pp. 209-226, 1903.

¹²Ann. der Physik, 22, 1, pp. 189-190, 1906.

¹³Journ. de Phys., 9, pp. 721-749, 1910; Zeitschr. Elektrochem., 17, pp. 265-275, 1911; Ann. der Physik, 36, 2, pp. 395-439, 1911.

obtained by Nernst, Lindemann and others for the specific heats of a large number of substances including such anomalous substances as diamond. Moreover, by means of Einstein's formula it is possible to calculate the frequency of the radiation emitted from the specific heat of a substance and the results so obtained agree very well with the frequency as determined by optical methods. It may be noted that the classical thermodynamics would lead one to expect the specific heat of a substance to become zero at the absolute zero of temperature. This is not the case and Planck's "energierest" would lead one to suspect the truth.

Stark¹⁴ has found that when secondary cathode rays are generated by X-rays that the electrons in the secondary rays possess energy of the same order of magnitude as those in the primary cathode rays which produce the X-rays and that this does not depend upon the intensity of the X-rays. The number of electrons in the secondary stream, however, does vary with the intensity of the X-rays. This can be accounted for by saying that the quantum possessed by an electron in the primary stream is handed on by the X-rays to an electron in the secondary stream. Thus when secondary rays are produced the velocity of the individual electrons will not depend upon the intensity of the X-rays but upon the size of the quantum. With more intense X-rays more quanta are transmitted and more electrons set free.

Pasehen found that when canal rays were examined for the Doppler effect that, instead of having the original spectral line displaced to one side or broadened on one side, he had a "rest," or undisplaced, and *two* displaced lines. Stark¹⁵ has pointed out that according to Planck's theory a positive ion will only radiate when its kinetic energy of translation is some multiple of the "elementar-quantum." Consequently the ions which are radiating have perfectly definite velocities depending upon the number of quanta they possess, and so we should expect to find a displaced line corresponding to each of these velocities. Stark has also been able to calculate the velocity of the radiating ions and finds that the results tend to confirm Planck's theory.

Haber¹⁶ has applied the quantum hypothesis to the absorption spectra of solids and obtains an equation relating the wave-length in the infra-red, λ_r , the wave-length in the ultra-violet, λ_v , and the molecular weight, viz., $\lambda_r = \lambda_v \times 42.81 \sqrt{M}$. This formula holds for regular crystalline substances such as NaCl, KCl, and fluorspar.

¹⁴Phys. Zeitschr., 10, pp. 902-913, 1909.

¹⁵Verh. Deutsch. Phys. Ges., 10, 20, pp. 713-715, 1908.

¹⁶Verh. Deutsch. Phys. Ges., 13, 24, pp. 1117-1136, 1911.

One of the most useful theorems in thermodynamics is a sort of supplement to the Second Law, and is due to Nernst. It states that *the entropy of a substance at the absolute zero of temperature is zero*. This theorem is amply justified by experiments on specific heats, thermo-neutral chemical reactions, and so forth. Boltzmann has shown that if the energy be subdivided into a large number of equal parts a quantity can be calculated, by means of the theory of probability, which is proportional to the entropy as deduced with the aid of Nernst's theorem, the proportionality factor depending upon the magnitude of the elementary amounts of energy. Some value of this amount should give the value of the entropy exactly. This value, according to Planck, would be the "elementar-quantum." Nernst's theorem may then be considered as another ground for belief in the basic truth of Planck's theory.¹⁷ Additional evidence in favor of the theory is to be found in the phenomena of fluorescence, the photo-electric effect, and others.

We shall now examine Planck's assumptions and attempt to interpret them physically. We know that Hertzian waves only differ in wave-length from the luminous waves emitted by an incandescent body. What is then more natural than to assume that the atoms of bodies contain tiny Hertzian resonators, or oscillators? We say "atoms" because the spectral lines of an element appear in the spectra of its compounds. The "perfectly reflecting walls" may be nothing more than a useful mathematical fiction, or may represent true physical boundaries corresponding to the cell walls of Larmor's elementary receptacles of energy. The assumption of a mechanical model is of vastly less interest than those implying at least an atomic structure of energy. If there are atoms of energy do they preserve their identity? Are they invariable? Planck assumes a discontinuous emission but a more or less continuous absorption of energy. May we not ask the question: "Are these discontinuities due to the oscillator or to the energy itself"? If the energy exists in discrete quantities, why is it not absorbed as well as emitted in multiples of the "elementar-quantum"? If absorbed in discrete amounts are these identical with those emitted? Apparently not, for in the phenomena of fluorescence the fluorescent light is nearly always of lower frequency than the light which causes the fluorescence, or, speaking in terms of Planck's hypothesis, the emergent quanta are smaller than the incident quanta, for the so-called *atoms of energy* are larger in proportion to the frequency of the light, so that "atoms" corresponding to blue light are larger than those corresponding to red light. If, then, we are to account for fluorescence by means

¹⁷Preiss. Akad. Wiss. Berlin, Sitz. Ber., 4, pp. 65-91, 1911.

of the quantum hypothesis we must conclude that energy is absorbed in amounts differing from those in which it is emitted or may even be absorbed continuously. If energy exists in the form of atoms these must undergo some change in the oscillator analogous to the chemical transformation of oxygen into ozone, or *vice versa*. Furthermore, it would appear that there would need to be as many different sorts of energy as there are wave-lengths of electro-dynamic wave radiation.

An alternative which has occurred to me is that the discontinuities in the radiation are due to the mechanical form of the oscillator, that is, they are not due to an atomic structure of the energy itself but rather to the oscillator. Imagine, if you will, a circuit consisting of a condenser, inductive resistance and spark gap in series, and in addition assume that the system can absorb energy falling upon it in the form of radiation. For some potential difference, V , the dielectric in the spark gap will break down and a discharge will occur, all of the electric energy, $\frac{1}{2}CV^2$, where C = capacity of system, being transformed into radiant energy of the wave-train produced, or into heat. The discharge will be oscillatory when $CR^2 < 4L$, R being resistance and L

inductance, and its frequency will be $\nu = \frac{1}{2\pi} \sqrt{\frac{1}{CL} - \frac{R^2}{4L^2}}$. If we further as-

sume that R is negligible when compared with the other quantities, we have

$\nu = \frac{1}{2\pi} \sqrt{\frac{1}{CL}}$. Let E = energy of system at the instant discharge occurred,

then $E = \frac{1}{2} CV^2 = \frac{1}{2} CV^2 \cdot 2\pi \sqrt{CL} \cdot \nu$, or $E = \pi C^{\frac{3}{2}} V^2 L^{\frac{1}{2}} \nu$.

This equation is identical with Planck's equation, $E = h\nu$, if we put

$h = C^{\frac{3}{2}} V^2 L^{\frac{1}{2}} = \text{constant}$. Thus the energy is proportional to the frequency. Some such oscillator may provide a means of escape from the conclusion that energy is atomic.

The emission law follows at once from the conception that the oscillator will not be as apt to radiate into a space where the radiant energy is dense as into one where it is rare.

Whatever our conception as to the nature of energy itself there is abundant reason for believing that it is emitted by bodies in discrete amounts. Experimental verification is to be found in widely-separated fields of research. The quantum idea has gained such a foothold that Einstein and Stark would abandon the electromagnetic theory of light for a corpuscular energy theory

although Planck himself considers this unnecessary. Concerning the hypothesis the late Henri Poincaré has said, "The present state of the question is as follows: the old theories, which hitherto seemed to account for all known phenomena, have met with an unexpected obstacle. An hypothesis has presented itself to M. Planck's mind, but so strange a one that one is tempted to seek every means of escaping it; these means, however, have been sought vainly. The new theory, however, raises a host of difficulties, many of which are real and not simply illusions due to the inertia of our minds unwilling to change their modes of thought."

NOTE—Since this paper was read Professor Millikan has given a masterly presentation of the various atomic theories of radiation. See *Science*, Jan. 24, 1913.

NOTES ON THE SYSTEM OF CRYSTALLIZATION AND PROPER CUTTING OF
THE SYNTHETIC CORUNDUM GEMS.

— — — — —
BY FRANK B. WADE.
— — — — —

It is with some hesitation that I am attempting to present before the Physical Science Section of the Indiana Academy of Science a paper upon so technical a subject as the system of crystallization of the synthetic corundum gems, when my study of them has been but the recreation of one whose serious work lies in another direction.

It was while attempting to learn how to produce the best possible results in the way of richness and depth of color in cutting synthetic ruby that I made a study of the crystalline form of the rough ruby boules. The best lapidaries, in cutting natural ruby, long ago learned that, to produce the deepest and richest color it was necessary to lay the table of the cut stone parallel with the basal planes of the natural hexagonal crystal. Fortunately this method of cutting usually gave also the largest possible cut stone from the rough material, as the natural ruby has a tabular habit, with the greatest diameters parallel to the basal planes of the hexagonal prism.

Now—although the rough boule of synthetic ruby has the appearance of an amorphous mass—it is in reality crystalline, in fact a single crystal. Hence in cutting it proper regard should be had for its optical properties if the best results are to be obtained. The Boules, however, although single crystals, have no well defined crystal faces or cleavages to reveal the system of crystallization or the direction of the optical axes.

It was in the endeavor to work out methods of determining these matters that I began a study of the rough boules. I first looked up the literature that was available upon the subject of artificial corundum gems, and for the sake of refreshing your memory along this line I will briefly review that part of it which leads toward the subject of this paper.

The earlier workers attempted to obtain rubies by the fusion of alumina, either in glass or porcelain furnaces or by means of the oxyhydrogen blowpipe. M. Gaudin, in 1837, using the oxyhydrogen blowpipe

to produce fusion, got tiny crystals of ruby when the melt was slowly cooled. These crystals, like those of nature, were in the hexagonal system, as shown by their external form. St. Clair de Ville and Caron produced rubies by fusion of alumina mixed with a little chromium oxide and, on one occasion they got both rubies and sapphires in the same crucible. These were very minute and had the usual crystal form of the natural stones. Fremy, by means of a high temperature continued for eight days, got rubies of the weight of one-third karat each. These also were regular crystals. No success was had by any of these earlier workers in obtaining rubies of commercial size.

About 1885 there began to come on the market, from Geneva, Switzerland, it is now said, some rubies which at first were sold as natural stones, but which, it developed later, were made by fusing together small natural rubies by means of the oxyhydrogen blowpipe. These rubies were generally bubbly, and the bubbles, unlike those in natural rubies, were spherical. There were also other signs by means of which the artificial character of these so-called "reconstructed" rubies might be detected. They were generally too low in specific gravity, probably owing to their bubbly character, and the color was a bit unnatural to the eye of an expert. They were, however, crystallized alumina. I have not had the opportunity of examining any of the drops thus produced while in the uncut condition, so that I am unable to speak in regard to their crystal structure. The cut stones are feebly double refracting and show dichroism like the natural rubies.

It was not long before the use of small natural rubies was discontinued and pure alumina mixed with a little chromium oxide was substituted. It was in 1904 that Verneuil published his method of producing true synthetic rubies by heating the above mixture in the flame of the oxyhydrogen blowpipe. The method employed by him in introducing the powdered material was exceedingly ingenious. A receptacle with a sieve bottom was constantly tapped by a mechanical tapper and the dust fell into the stream of oxygen and passed with it through the flame, which was directed vertically downward upon a support below. Upon this support the boule grew, first the slender stem, then, with proper manipulation of the flame the wider and wider dome, until, in some cases, the boule weighed over one hundred karats. The crystal character of these boules and of the blue and pink and white and yellow ones which later came to be made, forms the principal subject of this paper.

The blue color was obtained only after long study and experimentation on the part of Verneuil and an American assistant, Mr. I. H. Levin. They found that the attempt to blend cobalt as a colorant failed, the cobalt volatilizing or else floating out when the boule cooled. Picard, in 1907, and Louis Paris, in 1908, succeeded in getting boules of a fine blue color by blending magnesia or lime with the alumina and adding cobalt. They were, however, not true sapphires. Some of these boules were sent to a friend of mine, an enthusiastic gem collector, Mr. Wm. H. Huse, of Manchester, N. H., and at his request I tested them and found that they were too low in specific gravity, too soft, and their system of crystallization was the regular or cubic system. They were singly refracting and showed no dichroism. They were, in fact, artificial spinels. Their color also was of too piercing a blue. This was afterwards remedied by adding a trace of chromium oxide, but then the color as seen by artificial light was unnatural.

In January, 1910, Verneuil and Levin succeeded in obtaining true sapphires by adding to 98% of alumina 2% of a mixture of ferric oxide and titanium oxide and keeping the boule in a reducing atmosphere. A paper in regard to these boules was read by Verneuil in 1910 before the French Academy. It quoted M. Wyruboff, who examined them before they were submitted to the Academy. He said of them: "They take the form of a single crystal which is uniaxial, optically negative and little birefractive, consequently having all the optical properties of the natural sapphires. Furthermore, their composition and crystalline construction must evidently lead to the conclusion that these stones are in every other respect identical with the natural sapphires. They even show the parti-colored effects like the natural stones."

In connection with this report of Wyruboff I will quote here the report of Bauer, the great German gem expert, on the synthetic ruby boules. In a paper read before the German Chemical Society of Frankfurt, A. M. Bauer says: "The ruby bulb, in spite of its round shape, shows a true crystalline formation. In specific weight, in hardness, as well as in all the optical properties, it is identical with the natural stone; in color and brilliancy it vies with the best specimens from the Orient."

Some of the new blue sapphires were sent to this country and were submitted to Prof. Alfred Moses of Columbia University, who says: "The chemical analysis shows the material submitted to be nearly pure alumina with, however, a measurable quantity of titanite oxide. The crystallo-

graphic and optical tests show that the material submitted is crystallized and that the cone by all tests is one homogeneous faceless (anhedral) crystal. The crystalline, optical and other characteristics determined are closely those of natural sapphire. In the absence of natural faces or cleavages the crystalline system, as determined by the optical tests, may be either hexagonal or tetragonal. The parting figures point to the hexagonal system. Any two natural substances which were as nearly identical in chemical and crystallographic characters as the specimens submitted and natural sapphires would be called identical. The difference is one of origin."

While expert mineralogists are agreed that these synthetic products are identical with the natural in all their properties, yet the synthetic stones may in nearly every case be distinguished from the natural by one who is trained in seeking minute differences due to the difference in origin. As is now well known in the trade, the synthetic stones frequently contain bubbles which are always round or rounding in form. Natural corundum gems also frequently contain bubbles, but these are always bounded by crystal planes and are hence angular in appearance. Lacking the bubbles striae may be seen in the synthetic stones, especially in the rubies, and these striae, while parallel like those so often seen in natural stones, are, unlike the latter, not straight but curving. The color, too, in the case of the ruby, is not quite equal to that of the best natural stones, although in this respect I hope to show that the defect is probably due to improper cutting rather than to any real difference in the material. The synthetic rubies seem also to interfere with the passage of light through them to a greater extent than the natural stones when the latter are clear. This results in a sort of general illumination of the interior of the stone. One might say that the material was not optically a vacuum and that the Tyndall effect was produced. The flashes of light produced by total reflection from the rear facets of the stone are therefore seen against a background of faintly illuminated material instead of against a dark background, as in the natural ruby. This detracts from the beauty of the synthetic ruby somewhat, and it is this phenomenon I believe which enables an expert to tell by inspection without the aid of a lens whether a stone is a natural or a synthetic ruby. Some experts have claimed that they could tell by the touch alone whether a stone was a synthetic or a natural one. This difference I believe to be due to the very hasty manner

in which the synthetic stones are cut. They are cut abroad so cheaply that they can be sold in America for less than the price per carat charged for cutting alone by the American lapidary. It is thus probably the inferior surface finish of the synthetic stone that reveals itself to the trained touch of the expert. I have carefully polished a specimen of synthetic ruby to determine this point, and while I can feel a difference between the synthetic stone of commerce and the natural stone, I am unable to distinguish any difference between my finely polished synthetic stone and a natural one.

I have shown that gem experts have decided that the boules of synthetic corundum gems are single crystals and that they crystallize either in the hexagonal or in the tetragonal system. Professor Moses of Columbia University said also that the parting figures suggested the hexagonal system. The experts also said that the crystals were anhedral or faceless. I wish now to add some evidence from my study of them that indicates that the boules are not altogether faceless, and then to advance evidence along two different lines to prove that the crystals *are* of the hexagonal system, as was indicated by the parting figures.

Observation of a considerable number of the boules shows that there is a flattening on one side of nearly every boule, and an optical study of the boules shows that this flattening is nearly parallel to the basal planes of the crystal. Viewed with the dichroscope perpendicularly to the flattened place there is no dichroism. The depth of color, too, is greatest when viewed in this direction, and that would be true of natural ruby when viewed perpendicularly to the basal planes of the hexagonal prism. On grinding the surface parallel to the flattened place a slightly pearly effect is seen, and this surface thus produced is more difficult to polish than a surface that cuts across the grain in any other direction. This is generally true when working parallel to the cleavage of a natural crystal, and thus indicates that the flattened place on the boule represents the base of the prism. On this flattened face markings appear, indicating distortion of the edges of the layers of the material. There is a drawing down and curving of the edges of the layers as they cross the basal plane as though some force had distorted the layers as they arrived. These markings go far down toward the stem of the boule, indicating that the direction of crystallization is early determined. In a few boules the flattening is absent, and then I have found that the optical axis lies up

and down the boule and that the top of the boule is flatter than in the other type. In such boules there is also evident a tendency toward forming a hexagonal prism with faces and angles roughly apparent. Where the flattening occurs on the side of the boule, which is the usual case, it does not form a perfect plane, being apparently interfered with—perhaps by the surface tension of the semi-plastic mass. The longest horizontal diameter of the boules (they are made with the stem of the pear acting as a vertical support) is invariably parallel to the flattened face. On the side of the boule opposite to the flattened face there is sometimes another and smaller flattened face approximately parallel to the first. This, too, shows evidence of distortion of the lines representing the edges of the strata of accretion.

From what has been advanced in regard to these imperfectly developed basal faces I think that the term anohedral as used to describe the boule should be qualified. The boules are nearly anohedral, but not quite so. The forces of crystallization succeeded in forming a single crystal in spite of the adverse forces acting upon the boule, but they were unable to face up the crystal except imperfectly, as has been described.

I will now pass to my next topic and offer evidence of the hexagonal character of the boules. On examining the flattened surfaces described above, by means of a compound microscope with a magnification of several hundred diameters, I found that by proper focusing I was able to trace the outlines of minute crystals which formed a species of frost work upon the surface of the boule. These crystals were all of similar orientation, and their orientation was nearly that of the boule itself. When viewed perpendicularly to the flattened place on the boule the minute crystals had hexagonal forms (Figs. I a and b). When viewed at right angles to the basal plane of the boule rectangular figures representing the edges of hexagonal plates were seen (Figs. II a and b). The evident hexagonal form of these minute components of the crystal and their common orientation would seem to prove the hexagonal character of the boule on a crystallographic basis independently of the optical evidence.

I find also that by examining fractured surfaces of ruby boules with similar magnification (i. e., several hundred diameters) I can find sharp hexagonal cavities out of which hexagonal plates have been torn by the fracture as though there had been a species of molecular cleavage. This, too, would seem to confirm from a crystallographic basis the hexagonal structure of the boule.

As further evidence of this structure I find that in the case of a cabochon cut (smooth, convex upper surface) ruby which I myself cut from a fragment of a boule, I can plainly see a six-pointed star when viewed in direct sunlight or even when seen by the light of a single candle. This star effect is due to the presence in the material of microscopic bubbles, which produce somewhat the same effect as is produced by dust

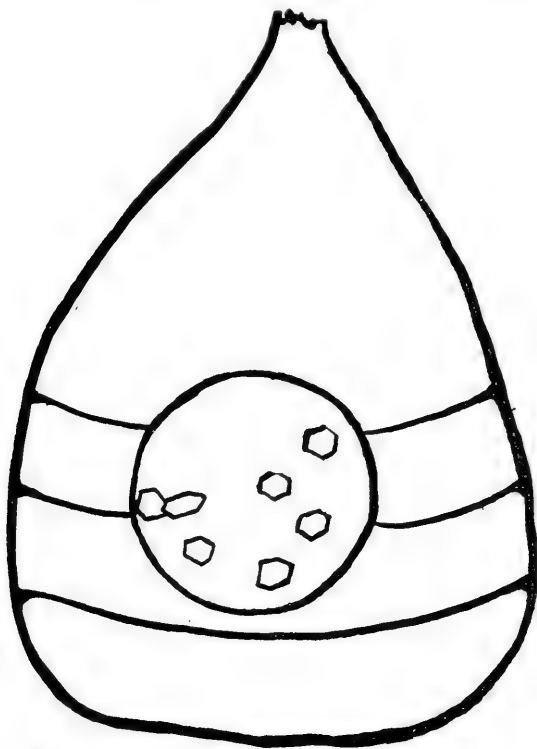

Figure IA Ruby
Viewed on flat side.

particles in a beam of light crossing a darkened room. The six-pointed character of the star plainly indicates that the material has the hexagonal arrangement, as a tetragonal crystal under similar conditions would produce a cross rather than a six-pointed star.

Having, as I believe, sufficiently shown that—as would be expected from its resemblance to the corundum gems of nature—the artificial gem corundum forms single hexagonal crystals, I will now briefly indicate how practical advantage may be taken of this fact in the cutting of fine gems. The lapidary may now by mere inspection of the boule determine

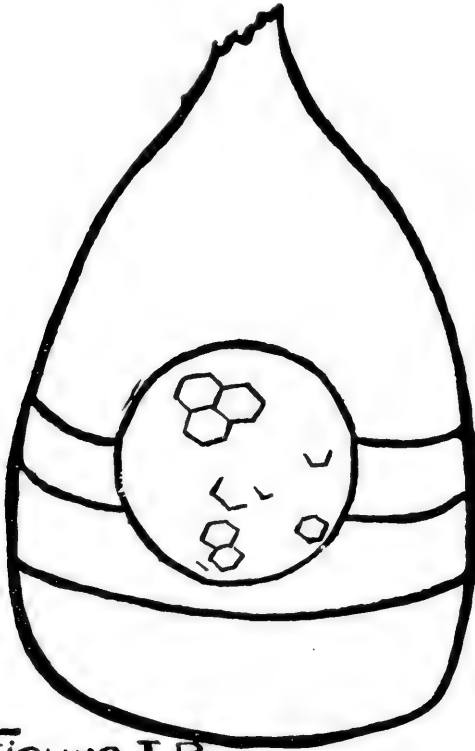

Figure 1 B
Yellow Sapphire
Viewed on flattened side.

(by finding the flattened side) the location of the basal planes of the crystal. He should then cut the stone so that the finished product will have the table (large top facet) parallel to the flattened place on the boule (i. e., parallel to the basal planes of the crystal). Now a study

of hundreds of cut stones of the synthetic type has shown that rarely if ever is one cut in accordance with this rule. Hence the fine deep color of the best specimens, of natural ruby, for example, is almost never equalled in the synthetic stones. By roughing out a ruby to nearly its finished form myself and then having a skilled lapidary facet it I have obtained a cut stone which I believe to be as deep and pure in color as the best of the natural stones. The synthetic stones of commerce seem to

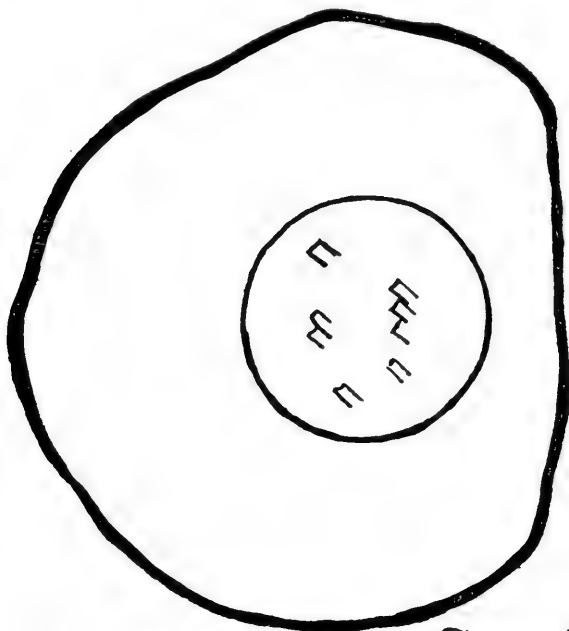

Fig II A Yellow Sapphire
Viewed on top

be cut as the boules break, and I find by opening boules myself that they nearly always break in such a direction that to cut the finished stone as it should be cut would waste two-thirds of the material; that is, a much greater spread in the finished stone may be had by cutting it as it breaks rather than by cutting it as it should be cut to obtain the best color. I have tried to guide the break by using the natural edge of a diamond crys-

tal so as to split the boule to favor the correct cutting, but the crack tends to turn around to the other side of the boule. I suspect that this is due to the following fact: As was said above, the flattened face of the boule is almost always parallel to the longer axis of the oval cross-section of the boule. Now natural ruby tends to cleave parallel to the basal planes, but only feebly so. The boules are under internal strain, somewhat as Prince Rupert's drops are, and when the surface of the boule is abraded even slightly, cracking follows and the strain is relieved.

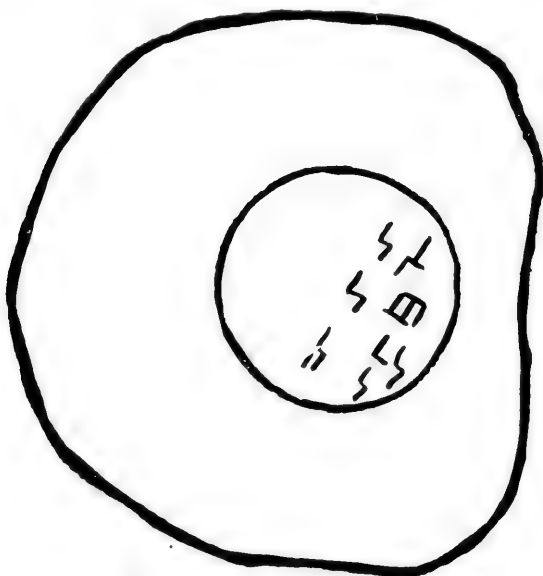

Figure II B. Ruby
viewed on top.

By cracking along the length of the boule at right angles to the plane of the flattened surface a smaller cross-section is made than would be made were the boule to split parallel to the basal planes. The natural cleavage is so feeble that I suspect the split follows the other direction as a line of least resistance. At any rate the boules split contrary to the natural cleavage and disadvantageously as regards cutting to produce the best color. By slitting with the diamond saw after the break has occurred

the practical lapidary can still utilize the material advantageously and, keeping run of the position of the basal planes by means of the flattened place, can indicate in some manner upon the surfaces of the fragments where the table of the finished stone should be laid.

By giving due attention to this matter, synthetic rubies and sapphires equal in depth and purity of color to the fine stones of nature can be produced. They will necessarily be sold at a higher price than most of those now on the market, but they will be worth more and should find a moderately large market among people of taste and discernment who have always loved to look upon fine natural sapphires and rubies, but who were unable to possess them at the prices commanded by the rare natural product.

Shortridge High School.

Indianapolis, Ind., Nov. 27, 1912.

ON LINEAR DIFFERENCE EQUATIONS OF THE FIRST ORDER WITH
RATIONAL COEFFICIENTS.

BY THOS. E. MASON.

This paper treats of the behavior of the solutions of a first order linear difference equation with rational coefficients as the variable approaches infinity in a strip parallel to the axis of imaginaries. A unique characterization of certain solutions is obtained to within the determination of a finite number of constants. The same problem has been discussed by Mellin.* The treatment here given is much shorter and simpler. The proof has been simplified by making use of the asymptotic expansion for the gamma function and by lemma II found in §1 of this paper. The use of this lemma has also permitted the removal of some restrictions made by Mellin.

Carmichael† has shown that certain solutions of the first order homogeneous linear difference equation are uniquely characterized by their behavior as the variable approaches infinity in the positive or the negative direction parallel to the axis of reals.

§1. LEMMAS.

LEMMA I. *If* $x = z + iz^1$, $x_j = u_j + iv_j$, $x_j^1 = u_j^1 + iv_j^1$, *then*

$$\lim_{z^1 \doteq \pm \infty} \left| \frac{\sqrt{(x-x_1)} \dots \sqrt{(x-x_m)}}{(x-x_1^1) \dots (x-x_n^1)} z^1 \right| e^{\frac{m-n}{2} \pi |z^1|} \left| \frac{(m-n)(-z+\frac{1}{2})-k}{e^{O+(m-n)z+k}} \right| = c,$$

where

$$O_j = \tan^{-1} \frac{z^1 - v_j}{z - u_j}, \quad O_j^1 = \tan^{-1} \frac{z^1 - v_j^1}{z - u_j^1} \quad \text{and} \quad O = \sum_{j=1}^n v_j^1 O_j^1 - \sum_{j=1}^m v_j O_j.$$

and where‡

$$k = \sum_{j=1}^n R(x_j^1) - \sum_{j=1}^m R(x_j).$$

*Acta Mathematica 15 (1891): 317-384. See §§1-3 of the paper. In §3 of an article in Mathematiskhe Annalen 68 (1910): 305-337, Mellin has defined a function by means of the linear homogeneous equation

$$F(x+1) - r(x)F(x) = 0,$$

where $r(x)$ has the particular form

$$r(x) = \frac{(x-x_1) \dots (x-x_m)}{(x-x_1^1) \dots (x-x_n^1)}$$

†Transactions of the American Mathematical Society 12 (1911): 99-134.

‡ $R(x)$ is used to denote the real part of x .

We make use of the following form of Stirling's formula:

$$\frac{1}{(x - x_1)} = (x - x_1)^{x - x_1 - \frac{1}{2}} \frac{e^{-x + x_1}}{e^{\sqrt{2\pi} (1 + E_x)}}$$

where E_x approaches zero as x approaches infinity in such way that its distance from the negative axis of reals approaches infinity.

Then we have

$$\lim_{x \rightarrow \infty} \left| \frac{1}{(x - x_1)} \cdot (x - x_1)^{-x + x_1 + \frac{1}{2}} \frac{e^{-x + x_1}}{e^{\sqrt{2\pi} (1 + E_x)}} \right| = e.$$

Set $x = z + iz^1$ and $x_1 = u_1 + iv_1$, where z, z^1, u_1, v_1 are real, and let x approach infinity, $A < R(x) < A + 1$; then we have

$$\lim_{z^1 \rightarrow \infty} \left| \frac{1}{(x - x_1)} \cdot (z + iz^1 - u_1 - iv_1)^{-z - iz^1 + u_1 + iv_1 + \frac{1}{2}} \frac{e^{-z - iz^1 + u_1 + iv_1}}{e^{\sqrt{2\pi} (1 + E_x)}} \right| = e.$$

Hence

$$\lim_{z^1 \rightarrow \infty} \left| \frac{1}{(x - x_1)} \cdot e^{(-z - iz^1 + u_1 + iv_1 + \frac{1}{2}) (\log \sqrt{(z - u_1)^2 + (z^1 - v_1)^2} + iO_1)} \frac{e^{-z - u_1}}{e^{\sqrt{2\pi} (1 + E_x)}} \right| = e,$$

where

$$O_1 = \tan^{-1} \frac{z^1 - v_1}{z - u_1}.$$

Now $z - u_1 > 0$, therefore when $z^1 \rightarrow \infty$, $O_1 \rightarrow \frac{\pi}{2}$ and when $z^1 \rightarrow -\infty$,

$O_1 \rightarrow -\frac{\pi}{2}$. Thus in the above limit after multiplying the factors in the

exponent of e , we can replace $z^1 O_1$ by $\frac{\pi}{2} |z^1|$. Then by rearrangement and simplification we can write

$$\lim_{z^1 \rightarrow \infty} \left| \frac{1}{(x - x_1)} \cdot (z + iz^1 - u_1 - iv_1)^{-z + u_1 + \frac{1}{2}} \frac{e^{-z + u_1}}{e^{\frac{\pi}{2} |z^1|}} \frac{e^{-z - u_1 - O_1 v_1}}{e^{\sqrt{2\pi} (1 + E_x)}} \right| = e.$$

Making use of limits of this form for each of the gamma functions in the expression in the lemma, we have the lemma.

LEMMA II. If $p(x)$ is a periodic function of period 1 which is analytic everywhere in the finite plane and as $z^1 \rightarrow \infty$ ($x = z + iz^1$) satisfies the relation*

$$(1) \lim_{z^1 \rightarrow \infty} \left| \frac{1}{p(x)} \frac{e^{-t\pi |z^1| - Qz^1}}{e^{\sqrt{2\pi} (1 + E_x)}} \right| = b,$$

b finite, t positive, then $p(x)$ may be written in the form

$$(2) p(x) = \sum_{j=-r}^q B_j e^{2\pi i j x}$$

* $L_{z^1 \rightarrow \infty} = e$ denotes the greatest value approached as $z^1 \rightarrow \infty$.

where q is the greatest integer $< \frac{t}{2} - \frac{Q}{2\pi}$ and r is the greatest integer $< \frac{t}{2} + \frac{Q}{2\pi}$; and conversely, every periodic function of period 1 which can be written in the form (2) is analytic in the finite plane and satisfies a relation of the form (1).

Since $p(x)$ is periodic of period 1, it takes in any period strip all the values it takes anywhere in the finite plane. The transformation

$$w = e^{2\pi i x}$$

carries a single period strip of the x -plane into the whole w -plane, $z^1 \doteq + \infty$ corresponding to $w \doteq 0$, and $z^1 \doteq -\infty$ to $w \doteq \infty$.

We can now write

$$p(x) = f(w)$$

and since $f(w)$ can have only the singular points zero and infinity it is expandible in a Laurent series

$$f(w) = \sum_{j=-\infty}^{\infty} B_j w^j$$

valid throughout the finite plane except at zero.

Using the fact that

$$|w| = e^{-2\pi z^1}$$

we get

$$\left| p(x) e^{-t\pi |z^1| - Q z^1} \right| = \left| f(w) w^{\frac{t}{2} + \frac{Q}{2\pi}} \right|$$

when z^1 is positive, and

$$\left| p(x) e^{-t\pi |z^1| - Q z^1} \right| = \left| f(w) w^{-\left(\frac{t}{2} - \frac{Q}{2\pi}\right)} \right|$$

when z^1 is negative. As $z^1 \doteq +\infty$, $w \doteq 0$ and

$$\lim_{w \doteq 0} \left| f(w) w^{\frac{t}{2} + \frac{Q}{2\pi}} \right| = b.$$

Hence the part of the series $f(w)$ with negative exponents can not have coefficients different from zero for j greater than the greatest integer $< \frac{t}{2} + \frac{Q}{2\pi}$.

As $z^1 \doteq -\infty$, $w \doteq \infty$ and

$$\lim_{w \doteq \infty} \left| f(w) w^{-\left(\frac{t}{2} - \frac{Q}{2\pi}\right)} \right| = b.$$

Hence the part of the series $f(w)$ with positive exponents can not have coefficients different from zero for j greater than the greatest integer $< \frac{t}{2} - \frac{Q}{2\pi}$.

Therefore we can write

$$p(x) = \sum_{j=-r}^q B_j w^j = \sum_{j=-r}^q B_j e^{2\pi i j x}$$

where q is the greatest integer $\leq \frac{t}{2} - \frac{Q}{2\pi}$ and r is the greatest integer $< \frac{t}{2} + \frac{Q}{2\pi}$. From the definition of Q given in §2 the values of q and r will not differ by more than 1 in the problem of this paper.

The converse is obvious.

§2. HOMOGENEOUS EQUATIONS.

THEOREM. Every first order linear homogeneous difference equation with rational coefficients, as

$$F(x + 1) - r(x) F(x) = 0,$$

where $r(x)$ can be written in the form

$$r(x) = a \frac{(x - x_1) \dots (x - x_m)}{(x - x'_1) \dots (x - x'_n)}, \quad a = h e^{iQ}, \quad -\pi < Q < \pi,$$

has a solution $F(x)$ which has the following properties, provided that each of the numbers $\frac{m-n}{4} \pm \frac{Q}{2\pi}$ is greater than zero, or in case $m = n$ that $Q = 0$ and

$$k = \sum_{j=1}^n R(x'_j) - \sum_{j=1}^m R(x_j) < 0.$$

I. $F(x)$ is analytic in the finite part of the x -plane defined by $R(x) > D$, where D is the greatest among the real parts of x_1, x_2, \dots, x_m .

II. As x approaches infinity in the strip parallel to the axis of imaginaries defined by $A < R(x) < A+1$ ($A > D$) the absolute value of $F(x)$ remains finite.

Every such function $F(x)$ can be written in the form

$$F(x) = a^x \frac{(x - x_1) \dots (x - x_m)}{(x - x'_1) \dots (x - x'_n)} \sum_{j=-r}^q B_j e^{2\pi i j x},$$

where q is the greatest integer* $< \frac{m-n}{4} - \frac{Q}{2\pi}$ and r the greatest integer* $< \frac{m-n}{4} + \frac{Q}{2\pi}$.

*The inequality sign should be replaced by the equality sign in case each quantity $\frac{m-n}{4} \pm \frac{Q}{2\pi}$ is an integer and at the same time the exponent of z^1 in the expression in lemma I, §1, is > 0 , that is when $(m-n) (-z+1/2) - k \geq 0$ for all values of x in the strip defined in condition II of the theorem.

The quantity $a F(x)$ evidently satisfies the difference equation of the theorem, where

$$F(x) = \frac{\overline{|\overline{(x - x_1)} \dots \overline{(x - x_m)}}}{\overline{|\overline{(x - x_1')} \dots \overline{(x - x_n')}}}$$

$a F(x)$ also satisfies I since in the region defined the gamma functions in the numerator are analytic and in the denominator are different from zero. $a F(x)$ being a particular solution of the difference equation, the general solution is

$$F(x) = p(x)a F(x),$$

where $p(x)$ is an arbitrary periodic function of period 1.

From the limit in Lemma I, §1, it is evident that I and II will be satisfied if, and only if, $p(x)$ is chosen so that it is analytic everywhere in the finite plane and when $x \doteq \infty$, $A < R(x) < A + 1$, satisfies the relation

$$L_{z^1 \doteq \infty} \left| \frac{\begin{matrix} x \\ a p(x) \end{matrix}}{\begin{matrix} (m - n)(-z + \frac{1}{2}) - k \\ e^{O + (m - n)z + k} \end{matrix}} \frac{m - n}{e^{\frac{m - n}{2} \pi |z^1|}} \pi |z^1| \right| = b,$$

where b is finite. This can be written $\left[\left| \frac{x}{a} \right| = h \frac{z - Qz^1}{e} \right]$

$$L_{z^1 \doteq \infty} \left| \frac{\begin{matrix} p(x) e^{-\left(\frac{m - n}{2}\right) \pi |z^1|} - Qz^1 h^z \end{matrix}}{\begin{matrix} (m - n)(-z + \frac{1}{2}) - k \\ e^{O + (m - n)z + k} \end{matrix}} \right| = b.$$

The use of Lemma II, §1, gives the form which $p(x)$ must take to satisfy this relation and thus completes the proof of the theorem.

$F(x)$ will in general be uniquely determined if its value is known at $q+r+1$ different points at which it is analytic. For then we should have a set of $q+r+1$ equations linear in the B_j 's from which we could determine the constants B_j .

The form of the periodic function $p(x)$ obtained by Mellin is

$$p(x) = \sin \pi(x - c_1) \dots \sin \pi(x - c_p) \left[\frac{A_1}{\sin \pi(x - c_1)} + \dots + \frac{A_p}{\sin \pi(x - c_p)} \right],$$

where the c 's are arbitrary with the exception that no two can differ by an integer. Mellin restricted a to be a real positive quantity and in case this is done the q and r of this paper become equal. In that case the identity of the periodic function of Mellin and the periodic function of this paper can be

shown by making the transformation $w = e^{2\pi i x}$ and equating the coefficients of like powers of w in the two transformed expressions for $p(x)$. This gives a system of p linear equations to determine A_1, A_2, \dots, A_p , where the p of Mellin's paper is equal $2q+1$.

§3. NON-HOMOGENEOUS EQUATIONS.

THEOREM. *If $r(x)$ and $s(x)$ are rational functions of the form**

$$r(x) = a \frac{(x - x_1) \dots (x - x_m)}{(x - x^1_1) \dots (x - x^1_n)}, \quad s(x) = b \frac{(x - x^{11}) \dots (x - x^{1g})}{(x - x^1_1) \dots (x - x^1_n)},$$

where $m > n$, then the series

$$S(x) = \sum_{t=0}^{\infty} \frac{s(x+t)}{r(x+t)r(x+t-1)\dots r(x)}$$

is always uniformly convergent for $|a'| > 1$ and for $|a'| = 1$ when $m > n$, and is uniformly convergent for $|a| = 1, m = n$, when $k - (g - n) > 1$, where

$$k = \sum_{j=1}^n R(x_j^1) - \sum_{j=1}^m R(x_j).$$

If the conditions for the uniform convergence of $S(x)$ are fulfilled, then every first order linear non-homogeneous difference equation with rational coefficients, as

$$F(x+1) - r(x)F(x) = s(x),$$

has a solution $F(x)$ which has the following properties:

I. $F(x)$ is analytic in the part of the finite x -plane defined by $R(x) > D$, where D is the greatest among the real parts of x_1, x_2, \dots, x_m .

II. If x is confined to the strip parallel to the axis of imaginaries defined by $A < R(x) < A+1$ ($A > D$) the absolute value of $F(x)$ remains finite as x approaches infinity.

Every such solution $F(x)$ can be written in the form

$$F(x) = a^x \frac{(x - x_1) \dots (x - x_m)}{(x - x^1_1) \dots (x - x^1_n)} \sum_{j=-r}^{q_1} B_j e^{2\pi i j x} \sum_{t=0}^{\infty} \frac{s(x+t)}{r(x+t)r(x+t-1)\dots r(x)},$$

r and q_1 being defined as in the theorem in §2.

In the equation

$$F(x+1) - r(x)F(x) = s(x)$$

make the substitution

$$F(x) = f(x)u(x),$$

where $f(x)$ is the solution of the homogeneous equation given in the theorem

*If $r(x)$ and $s(x)$ do not already have a common denominator they can easily be reduced to expressions with a common denominator.

in §1. This gives

$$f(x+1)u(x+1) - r(x)f(x)u(x) = s(x).$$

Since $f(x+1) - r(x)f(x) = 0$ we can divide by $r(x)f(x)$ and we have

$$u(x+1) - u(x) = \frac{s(x)}{r(x)f(x)}$$

or

$$u(x) = p(x) - \sum_{t=0}^{\infty} \frac{s(x+t)}{r(x+t)f(x+t)}$$

where $p(x)$ is an arbitrary periodic function of period 1. Now

$$f(x+t) = r(x+t-1)f(x+t-1) = \dots = r(x+t-1)r(x+t-2) \dots r(x)f(x).$$

Making this substitution in the preceding equation we have

$$u(x) = p(x) - \sum_{t=0}^{\infty} \frac{s(x+t)}{r(x+t)r(x+t-1)\dots r(x)f(x)}.$$

If we choose $p(x) = 0$ we have

$$F(x) = f(x)u(x) = - \sum_{t=0}^{\infty} \frac{s(x+t)}{r(x+t)r(x+t-1)\dots r(x)}.$$

$F(x)$ is then a solution satisfying I and II provided that

$$S(x) \equiv u_0(x) + u_1(x) + u_2(x) + \dots, \quad u_n(x) = \frac{s(x+n)}{r(x+n)r(x+n-1)\dots r(x)},$$

is analytic. $S(x)$ is analytic provided that it converges uniformly in any closed region T lying in the strip defined by the relation $\underline{A} < \underline{R}(x) < \overline{A} + 1$.

In the region T in the strip under consideration the following ratio of the $(t+1)$ th term to the t -th term holds for every value of x in that region.

$$(5) \quad \left| \frac{u_{t+1}}{u_t} \right| = \left| \frac{1}{r(x+t)} \frac{s(x+t)}{s(x+t-1)} \right| \\ = \left| \frac{1}{a} \left\{ t^{n-m} [k - n - m R(x)] t^{n-m-1} + \dots \right\} \right. \\ \left. \left\{ 1 + \frac{l}{t} + \frac{l_1(x)}{t^2} + \dots \right\} \right|,$$

where k has the same meaning as in §1 and $l = g - n$. When $n = m$ (5) becomes

$$(6) \quad \left| \frac{u_{t+1}}{u_t} \right| = \frac{1}{|a|} \left\{ 1 + \frac{-k+1}{t} + \dots \text{terms in } \frac{1}{t^2}, \frac{1}{t^3}, \text{ etc.} \right\}.$$

In considering the value of this ratio we shall need to examine the following cases:

(1). When $n > m$ (5) shows the ratio to be greater than 1 and therefore the series $S(x)$ diverges.

(2). When $n < m$ (5) shows that for increasing t the ratio approaches zero and therefore the series $S(x)$ converges.

(3). When $n = m$ we see from (6) that the convergence of the series depends on the value of $|a|$.

If $|a| > 1$ the ratio ultimately approaches a quantity less than 1 and therefore $S(x)$ converges.

If $|a| < 1$ the ratio is greater than 1 and $S(x)$ diverges.

If $|a| = 1$ the series will converge when $k - l > 1$.

In the cases where $S(x)$ converges, except where $n = m$ and $|a| = 1$, the ratio u_{t+1}/u_t has been shown to approach a quantity which is less than 1 for every x in T . Hence an M and an r can be found such that

$$M + Mr + Mr^2 + Mr^3 + Mr^4 + \dots$$

is a convergent series of positive constant terms which is greater term by term than the series

$$(7) \quad u_0 + u_1 + u_2 + u_3 + \dots$$

for every x in T . Therefore the series $S(x)$ converges uniformly in T and is an analytic function in that region since each term is analytic in T . In case $n = m$ and $|a| = 1$ we see from (6) that the coefficient of $1/t$ does not contain x but that the coefficients of higher powers of $1/t$ do. These coefficients are polynomials in x . If we replace each x by a quantity which is greater than the greatest absolute value of x in T and replace the coefficients of the powers of x by their absolute values, then the ratio (6) is increased but is still such that a series of positive constants can be constructed which is convergent and is term by term greater than the series (7). Hence $S(x)$ converges uniformly in T when $n = m$ and $|a| = 1$ and is therefore analytic in T . But T is any closed region in the strip and hence $S(x)$ is analytic throughout the strip.

Under the conditions of the theorem $S(x)$ has been shown to be a solution of the difference equation of the theorem with the required properties I and II. The general solution having those properties will be obtained by adding to this particular solution the general solution of the homogeneous equation as found in the theorem of §2 which has the same properties. This completes the theorem.

*In accordance with a theorem of Gauss. See Opera, vol. 3, p. 139.

A NOTE ON THE INTERSECTION OF OSCULATING PLANES
TO THE TWISTED CUBIC CURVE.

BY A. M. KENYON.

On page 15 of his Differential Geometry Eisenhart proposes an exercise to show that on any plane there is one and only one line through which can be drawn two osculating planes to the twisted cubic.

§1.

The twisted cubic

$$\begin{aligned} x &= \frac{a_0 + a_1 t + a_2 t^2 + a_3 t^3}{d_0 + d_1 t + d_2 t^2 + d_3 t^3} \\ y &= \frac{b_0 + b_1 t + b_2 t^2 + b_3 t^3}{d_0 + d_1 t + d_2 t^2 + d_3 t^3} \\ z &= \frac{c_0 + c_1 t + c_2 t^2 + c_3 t^3}{d_0 + d_1 t + d_2 t^2 + d_3 t^3} \end{aligned}$$

$$\begin{vmatrix} a_0 & a_1 & a_2 & a_3 \\ b_0 & b_1 & b_2 & b_3 \\ c_0 & c_1 & c_2 & c_3 \\ d_0 & d_1 & d_2 & d_3 \end{vmatrix} \neq 0 \quad (\text{since the curve is twisted})$$

is carried over by the nonsingular linear transformation:

$$\begin{aligned} x &= \frac{a_1 x' + a_2 y' + a_3 z' + a_0}{d_1 x' + d_2 y' + d_3 z' + d_0} \\ y &= \frac{b_1 x' + b_2 y' + b_3 z' + b_0}{d_1 x' + d_2 y' + d_3 z' + d_0} \\ z &= \frac{c_1 x' + c_2 y' + c_3 z' + c_0}{d_1 x' + d_2 y' + d_3 z' + d_0} \end{aligned}$$

into the cubic

$$x' = t \quad y' = t^2 \quad z' = t^3;$$

planes, straight lines, and points, go over into planes, straight lines, and points, respectively, and in particular, osculating planes go into osculating planes.

The equation of the osculating plane to the cubic

$$x = t \quad y = t^2 \quad z = t^3$$

at the point whose parameter value is t , is

$$3t^2x - 3ty + z - t^3 = 0$$

There is no line in space through which pass three such planes:

$$\begin{aligned} 3t_1^2x - 3t_1y + z - t_1^3 &= 0 \\ 3t_2^2x - 3t_2y + z - t_2^3 &= 0 \\ 3t_3^2x - 3t_3y + z - t_3^3 &= 0 \end{aligned} \quad t_1, t_2, t_3, \text{ all different,}$$

for the determinant of the coefficients of x, y, z , is equal to

$$9(t_1 - t_2)(t_2 - t_3)(t_3 - t_1) \neq 0$$

and therefore the three planes are linearly independent.

§2.

Given a real* plane

$$E: \quad ax + by + cz + d = 0 \quad a, b, c, \text{ not all zero}$$

and the cubic

$$K: \quad x = t \quad y = t^2 \quad z = t^3$$

The equations of the planes which osculate K at any two distinct points $P_1(t_1), P_2(t_2), t_1 \neq t_2$, determine a line

$$L: \quad x = s/3 + u \quad y = p/3 + su \quad z = 3pu \dagger$$

where $s = t_1 + t_2, p = t_1 t_2$, and u is a parameter.

That L lie on E , it is necessary and sufficient that

$$(1) \quad \begin{aligned} a s + b p + 3 d &= 0 \\ b s + 3 c p + a &= 0 \end{aligned}$$

Write the matrix of the coefficients of equations (1)

$$M: \quad \begin{vmatrix} a & b & 3d \\ b & 3c & a \end{vmatrix}$$

and set

$$A = \begin{vmatrix} a & b \\ b & 3c \end{vmatrix}, \quad B = \begin{vmatrix} a & 3d \\ b & a \end{vmatrix}, \quad C = \begin{vmatrix} b & 3d \\ 3c & a \end{vmatrix}$$

§3.

Suppose $A \neq 0$. Equations (1) have the unique solution:

$$s = C/A \quad p = -B/A$$

whence t_1 and t_2 are the roots of the quadratic equation

$$(2) \quad A t^2 - C t - B = 0$$

Therefore if two distinct planes osculate K and intersect on E , (in case $A \neq 0$), it is necessary that $4AB + C^2 > 0$, and that the parameter values of their points of osculation be the roots of the quadratic (2).

This condition is also sufficient, for if $A \neq 0$, and if $4AB + C^2 > 0$ equation (2) determines two real numbers t_1 and t_2 , and if we set $s = t_1 + t_2, p = t_1 t_2$, these numbers satisfy equations (1), and the line $x = s/3 + u$,

*This problem is treated throughout as a problem in Geometry, not one in Algebra.

†These equations hold even if one of t_1, t_2 , is zero.

$y = p/3 + su$, $z = 3pu$, lies on E and is the intersection of two planes which osculate K . Moreover, since under these conditions, t_1 , t_2 , s , p , are uniquely determined, there is no other line on E through which pass two planes which osculate K .

If $4AB + C^2 \leq 0$, equation (2) has one real root, or no real root, and there exists on E no line through which can be drawn two planes which osculate K .

§4.

Suppose $A = 0$ but B and C are not both zero. Equations (1) have no solution. There is no line on E through which pass two osculating planes.

The results of §3 and §4 may be combined into a theorem:

If not all the determinants of M vanish, there is exactly one line on E , or no line on E , through which pass two osculating planes, according as the equation $A t^2 - C t - B = 0$ has or has not two real roots.

§5.

Suppose all the determinants of M vanish. Under these conditions E itself osculates K ; for, in order that the equation $a t + b t^2 + c t^3 + d = 0$ have three equal linear factors, it is necessary and sufficient that $A=B=C=0$.

The plane $z = 0$ osculates K at the origin. If E osculates K , the point of osculation is $(-a/b, a^2/b^2, -a^3/b^3)$ if $b \neq 0$, but $(0, 0, 0)$ if $b = 0$.

The number of osculating planes which can be drawn to K from a point $P(x, y, z)$ is equal to the number of real roots of the equation in t

$$(3) \quad t^3 - 3xt^2 + 3yt - z = 0$$

Write down the matrix*

$$M' : \begin{vmatrix} 1 & -x & y \\ -x & y & -z \end{vmatrix}$$

and set $A' = \begin{vmatrix} 1 & -x \\ -x & y \end{vmatrix}$, $B' = \begin{vmatrix} 1 & y \\ -x & -z \end{vmatrix}$, $C' = \begin{vmatrix} -x & y \\ y & -z \end{vmatrix}$

then the discriminant of (3) is

$$D = 3 \begin{vmatrix} 2A' & B' \\ B' & 2C' \end{vmatrix}$$

The points of the plane E may be classified as follows:

(1) Suppose at a point P of E , $D > 0$.

*Reduced from $\begin{vmatrix} 3 & -6x & 3y \\ -3x & 6y & -3z \end{vmatrix}$

Equation (3) has three real roots, t_1, t_2, t_3 ; one of these t_1 say, determines E itself; the other two determine a pair of osculating planes:

$$3 t_2^2 x - 3 t_2 y + z - t_2^3 = 0$$

$$3 t_3^2 x - 3 t_3 y + z - t_3^3 = 0$$

distinct from E and from each other; their intersection does not lie on E, else would the three osculating planes be linearly dependent. Therefore, these two planes cut out from E a pair of lines intersecting in P, through each of which passes a pair of osculating planes. E itself and one other.

(2) Suppose at a point P of E, $D = 0$ but A', B', C' , are not all zero.

Equation (3) has only two *roots, both real; one of these determines E and the other determines an osculating plane distinct from E which intersects E in a line through P.

(3) Suppose at a point P of E, $A' = B' = C' = 0$; then is $D = 0$.

There is in fact only one point on E at which $A' = B' = C' = 0$, for from these equations follow $x = x, y = x^2, z = x^3$; therefore P is on K and is therefore the point of osculation of E and K. Under these conditions equation (3) has only one† root and that determines E.

(4) Suppose at a point P of E, $D < 0$.

Equation (3) has only one real root and that determines E.

These results may be combined into a theorem:

If all the determinants of M vanish, E itself osculates K. Through every point of E at which $D > 0$ there may be drawn a unique pair of lines on E, through each of which pass two osculating planes; through every point of E at which $D = 0$ (except the point where E osculates K) there may be drawn a unique line on E through which pass two osculating planes; through every other point of E (including the point of osculation) there exists no line on E through which pass two osculating planes.

§6

Examples:

1. E: $3x + 3y - 2z - 5 = 0$

M: $\begin{vmatrix} 3 & 3 & -15 \\ 3 & -6 & 3 \end{vmatrix}$, $A = -27, B = 54, C = -81$.

(2) $t^2 - 3t + 2 = 0$ $t_1 = 1, t_2 = 2, s = 3, p = 2$.

L: $x = 1 + u, y = 2/3 + 3u, z = 6u$.

Through L pass the two osculating planes:

$$3x - 3y + z - 1 = 0,$$

$$12x - 6y + z - 8 = 0.$$

*That is, two equal linear factors distinct from the third linear factor.

†That is, three equal linear factors.

$$2. \quad E: \quad x + 3y + z = 0.$$

$$M: \quad \begin{vmatrix} 1 & 3 & 0 \\ 3 & 3 & 1 \end{vmatrix} \quad A = -6, \quad B = 1, \quad C = 3.$$

$$(2) \quad 6t^2 + 3t + 1 = 0. \quad \text{No real root: no line.}$$

$$3. \quad E: \quad x + 2y + z = 0.$$

$$M: \quad \begin{vmatrix} 1 & 2 & 0 \\ 2 & 3 & 1 \end{vmatrix} \quad A = -1, \quad B = 1, \quad C = 2.$$

$$(2) \quad t^2 + 2t + 1 = 0 \quad \text{Only one root: no line}$$

$$4. \quad E: \quad 3x + 3y + z - 1 = 0$$

$$M: \quad \begin{vmatrix} 3 & 3 & -3 \\ 3 & 3 & 3 \end{vmatrix}, \quad A = 0, \quad B = 18, \quad C = 18$$

$$(2) \quad t + 1 = 0 \quad \text{Only one root: no line.}$$

$$5. \quad E: \quad 3x - 3y + z - 1 = 0$$

$$M: \quad \begin{vmatrix} 3 & -3 & -3 \\ -3 & 3 & 3 \end{vmatrix} \quad A = B = C = 0.$$

E osculates K at $(1, 1, 1)$ i. e. where $t = 3/3 = 1$, see §5.

a) Consider the point P $(-2, 1, 10)$ on E

$$M': \quad \begin{vmatrix} 1 & 2 & 1 \\ 2 & 1 & -10 \end{vmatrix} \quad A' = -3, \quad B' = -12, \quad C' = -22,$$

$D = 360$; two lines on E through P;

$$(3) \quad t^3 + 6t^2 + 3t - 10 = 0 \quad t_1 = 1, \quad t_2 = -2, \quad t_3 = -5$$

Lines through P:

$$L_1: \quad x = -2 - u, \quad y = 1 + u, \quad z = 10 + 6u$$

through which pass osculating planes

$$3x - 3y + z - 1 = 0, \quad 12x + 6y + z + 8 = 0.$$

$$L_2: \quad x = -2 - u, \quad y = 1 + 4u, \quad z = 10 + 15u.$$

through which pass osculating planes

$$3x - 3y + z - 1 = 0, \quad 75x + 15y + z + 125 = 0.$$

b) Consider the point P $(2, 3, 4)$ on E

$$M': \quad \begin{vmatrix} 1 & -2 & 3 \\ -2 & 3 & -4 \end{vmatrix}, \quad A' = -1, \quad B' = 2, \quad C' = -1, \quad D = 0,$$

$$(3) \quad t^3 - 6t^2 + 9t - 4 = 0, \quad t_1 = 1, \quad t_2 = 4$$

Line through P:

$$L: \quad x = 2 + u, \quad y = 3 + 5u, \quad z = 4 + 12u.$$

through which pass osculating planes

$$3x - 3y + z = 1, \quad 48x - 12y + z = 64$$

c) Consider the point $(0, 0, 1)$ on E:

$$M': \begin{vmatrix} 1 & 0 & 0 \\ 0 & 0 & -1 \end{vmatrix} A' = 0, \quad B' = -1, \quad C' = 0, \quad D = -3. \quad \text{No line.}$$

In case E is an osculating plane different from $z = 0$, and P is on E, $t = -a/b$ is a root of equation (3), which can consequently be depressed to the quadratic

$$(4) \quad (bt)^2 - (a + 3bx)bt + a(a + 3bx) + 3b^2y = 0$$

and the number of osculating planes through P which are distinct from E is equal to the number of real roots of this equation which are different from $-a/b$.

d) Consider again the point P $(-2, 1, 10)$ on $3x - 3y + z = 1$

$$(4) \quad t^2 + 7t + 10 = 0 \quad t_1 = -2 \quad t_2 = -5$$

both different from 1; therefore two lines as before under a).

e) Consider the point P $(-1, 0, 4)$

$$(4) \quad t^2 + 4t + 4 = 0 \quad t = -2$$

one root different from 1; therefore one line

$$L: \quad x = -1 - u, \quad y = u, \quad z = 4 + 6u$$

through which pass osculating planes

$$3x - 3y + z - 1 = 0, \quad \text{and} \quad 12x + 6y + z + 8 = 0$$

§7.

The case where E is an osculating plane may also be treated geometrically by making use of certain considerations given in a later chapter of Eisenhart's book. The equation of the envelope F, of the osculating planes to K is obtained by equating to zero the discriminant D of equation (3):

$$(5) \quad 3x^2y^2 + 6xyz - 4x^3z - z^2 - 4y^3 = 0$$

Since $x = t, y = t^2, z = t^3$, satisfies (5) for all values of t, K itself lies on F; in fact, K is the edge of regression of F.

A given osculating plane E not only touches F, but in general cuts out from F a plane curve H, which passes through the point where E osculates K. Every osculating plane different from E, cuts E in a line tangent to H; conversely through every straight line on E tangent to H passes an osculating plane which is distinct from E.* The curve H divides E into two or more regions throughout each of which D is always positive or always negative and therefore serves to classify the points of E into those through which can be drawn two lines, or one line, or no line respectively, which is the intersection of two osculating planes,

*Unless perchance this line is a part of H, as is the case with the x-axis on the plane $z = 0$.

On the osculating plane $z=0$ the curve H consists of the x -axis and the parabola $3x^2 = 4y$. It divides the plane into four regions: R_1 , the top half plane; R_2 , that part of the lower left quarter plane which is "outside" the parabola; R_3 , that part of the lower right quarter plane which is "outside" the parabola; R_4 , that part of the lower half plane which is "inside" the parabola. Throughout the first three regions, $D > 0$, while in the fourth region, $D < 0$; everywhere on H itself of course $D = 0$.

Any other osculating plane $3t^2x - 3ty + z - t^3 = 0$, $t \neq 0$, cuts the plane $z = 0$ in the line $3tx - 3y - t^2 = 0$. This equation represents the one parameter family of lines which envelope the parabola $3x^2 = 4y$. The parameter t , is in fact the slope of these tangents.

From any point in R_{123} two tangents can be drawn to the parabola and through each of these pass two osculating planes; from no point in R_4 can a tangent be drawn to the parabola and through this region of $z = 0$ there passes no line which is the intersection of two osculating planes. Through any point on the parabola itself one and only one tangent can be drawn and (excepting the tangent at the origin) this is the intersection of two osculating planes. Through any point (except the origin) on the x -axis, which is a part of H , two tangents can be drawn to the parabola but one of these is in all cases the x -axis itself, through which passes no osculating plane distinct from $z = 0$. Therefore through any point (except the origin) on the x -axis there passes one line which is the intersection of two osculating planes.

Examples on the osculating plane $z = 0$.

a) Consider the point $(0, -3, 0)$ in R_1

$$3tx - 3y - t^2 = 0 \quad \text{gives } t_1 = 3 \quad t_2 = -3$$

L_1 : $3x - y - 3 = 0$ through which pass osculating planes
 $27x - 9y + z = 27$ and $z = 0$

L_2 : $3x + y + 3 = 0$ through which pass
 $27x + 9y + z + 27 = 0$, and $z = 0$

b) Consider the point $(1/2, -3/2, 0)$ in R_1

$$3tx - 3y - t^2 = 0 \quad \text{gives } t_1 = 3 \quad t_2 = -3/2$$

L_1 : same as L_1 under a)

L_2 : $6x + 4y + 3 = 0$ through which pass
 $54x + 18y + 4z + 27 = 0$ and $z = 0$

c) Consider the point $(2, 3, 0)$ on the parabola

$$3tx - 3y - t^2 = 0 \quad \text{gives } t = 3$$

L : same as L_1 under a)

d) Consider the point $(1, 0, 0)$ on the x-axis

$$3tx - 3y - t^2 = 0 \quad \text{gives} \quad t_1 = 0 \quad t_2 = 3$$

$t = 0$ determines the x-axis; $t = 3$ determines the line

L: same as L_1 under a).

These examples are illustrated by the accompanying figure.

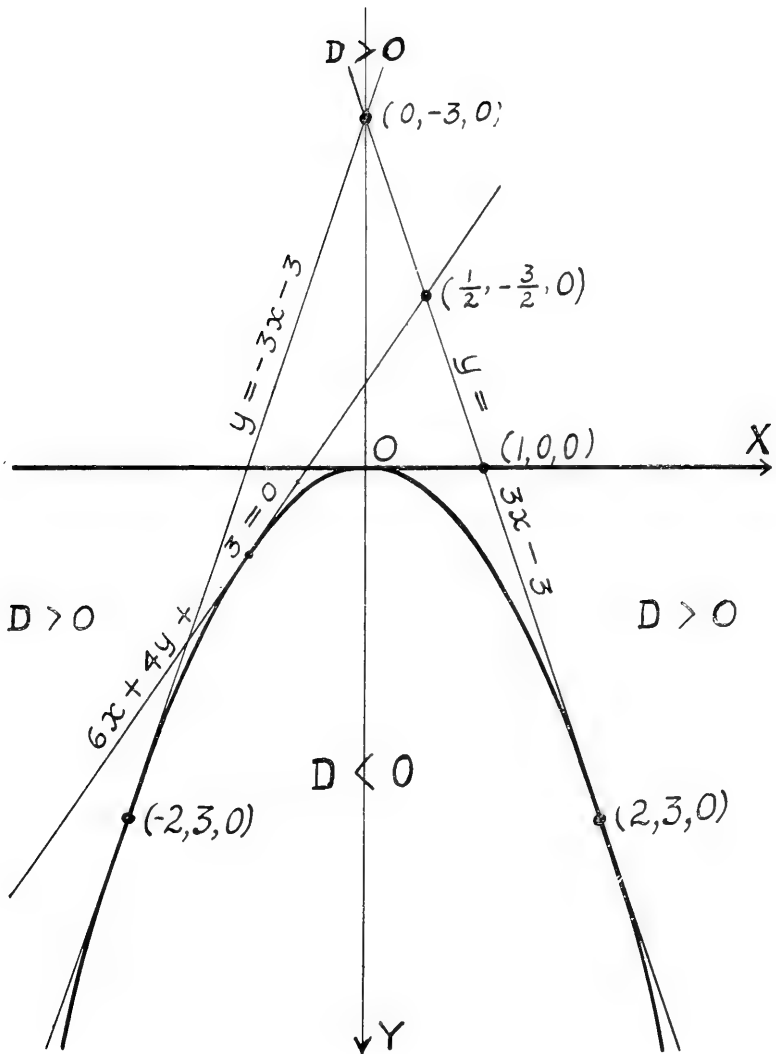

Purdue University;
 November 29, 1912.

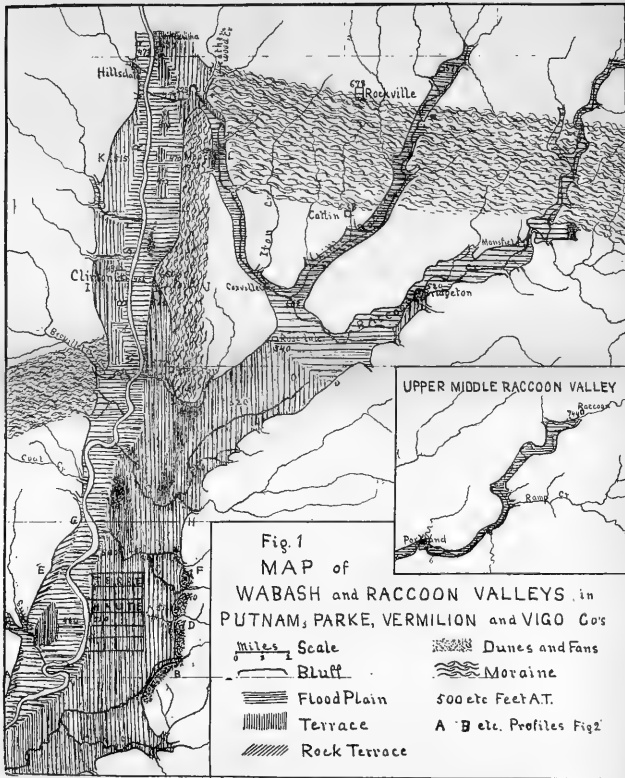

WABASH STUDIES.

CHARLES R. DRYER.

I.

TERRACES OF THE WABASH VALLEY IN PARKE, VERMILLION AND VIGO COUNTIES.

The most conspicuous features of the lower Wabash Valley are the heavy gravel terraces, which are almost everywhere present on one side or



Figure 4. Bluff Slope from Island Terrace.

the other, and sometimes on both sides. During the last two years, with the help of my students, I have extended the study of the Terre Haute area up the river as far as Montezuma. The results are shown in the accompanying sketch map. (Fig. 1.)

The Montezuma Terrace has been studied only at its lower end from Montezuma to its southern termination. It is complex, rising by two or three steps to a height of 45-50 feet above the flood plain or about 525 feet A. T. At Montezuma its width is $1\frac{1}{2}$ miles.

The Clinton Terrace has not been fully studied, but is known to extend from near Hillsdale to the mouth of Brouillet's creek, a distance of 12 miles. It is two miles or more in width and lies at two levels, the lower in the southern half about 30 feet above flood plain or 495 feet A. T. Near Summit Grove it rises by a distinct bench 20 feet higher.

Island Terraces. Between Clinton and Montezuma there is a line of mid-valley terraces divided by cross-depressions into five islands. They are generally flat-topped with a rather sharp border 20-30 feet high on the river side and a less definite boundary on the bluff side, where they slope gently to a depression lower than the river banks. (Fig. 4.) The southernmost member of the series is unique. Its surface presents a confused



Figure 5. Clinton Kame Terrace.

assemblage of hills and hollows, the highest point rising 40 feet above flood plain. (Fig. 5.) The surface is fine clean sand which may be a wind deposit, a conclusion which the topography alone would justify. The sand is underlaid at a depth of 8 to 12 feet by coarse gravel. If the topography is determined by gravel deposits they are not alluvial, but can be classified only as a kame with an eolian veneer. If the island is wholly eolian it is difficult to imagine why the wind should be so efficient there and without effect anywhere else. If it is glacio-fluvial, at core a kame, it means that when the ice sheet covered the valley bottom, this point was the mouth of a sub-glacial stream. In any case, it is one of the most interesting features

of the valley. Its peculiar sand dune flora intensifies its insular character and makes it as fine a field for the student of plant ecology as for the student of geology.

An island terrace at West Terre Haute originally occupied about one square mile, one-fourth of which has been removed by the railroad companies for ballast.

Rock Terraces. In the vicinity of Terre Haute the front of the west bluff is bordered for five or six miles by a rock terrace 10-20 feet high and in some places a quarter of a mile wide. This is due to a thin stratum of flinty limestone which has resisted erosion more effectually than the shales which lie above it.

The Terre Haute Terrace occupies the eastern part of the valley from



Figure 6. Atherton Island—West Bluff.

Lyford, opposite Clinton, to the southern boundary of Vigo County, a distance of about 27 miles. Its width is generally 3-4 miles, but near its northern end it is divided by the south end of a piece of highland which we call Atherton Island. (Fig. 6.) The eastern branch, $2\frac{1}{2}$ miles wide, extends through a gap in the Wabash bluff 5 miles northeastward to Rosedale, where it becomes continuous with the floor of the valley of Big Raccoon Creek. The western branch, between the west side of Atherton Island and the river, tapers to a point opposite Clinton. At Terre Haute the surface of the terrace lies 500-510 feet A. T. or 40-50 feet above flood plain and is diversified by a series of longitudinal ridges 10-20 feet high which resemble sandbars. These are shown in the series of four transverse

profiles, drawn at intervals of two miles. (Fig. 2.) They are in some places broad, flat and irregular, but have the habit of growing narrower and higher to the south, where they end abruptly. Their topography can be shown only by a closely contoured map, which is in process of con-

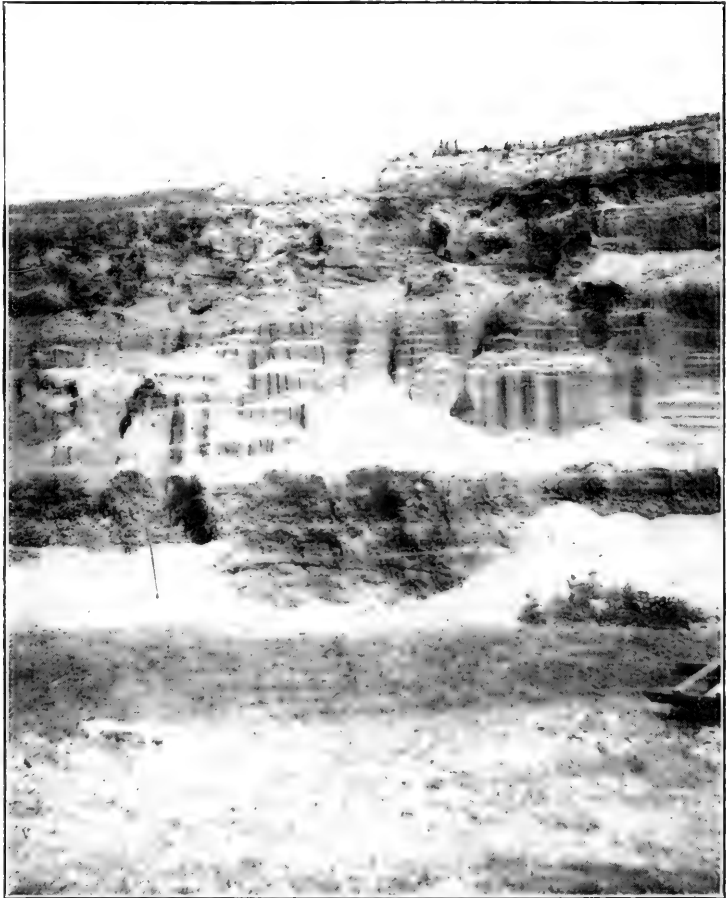
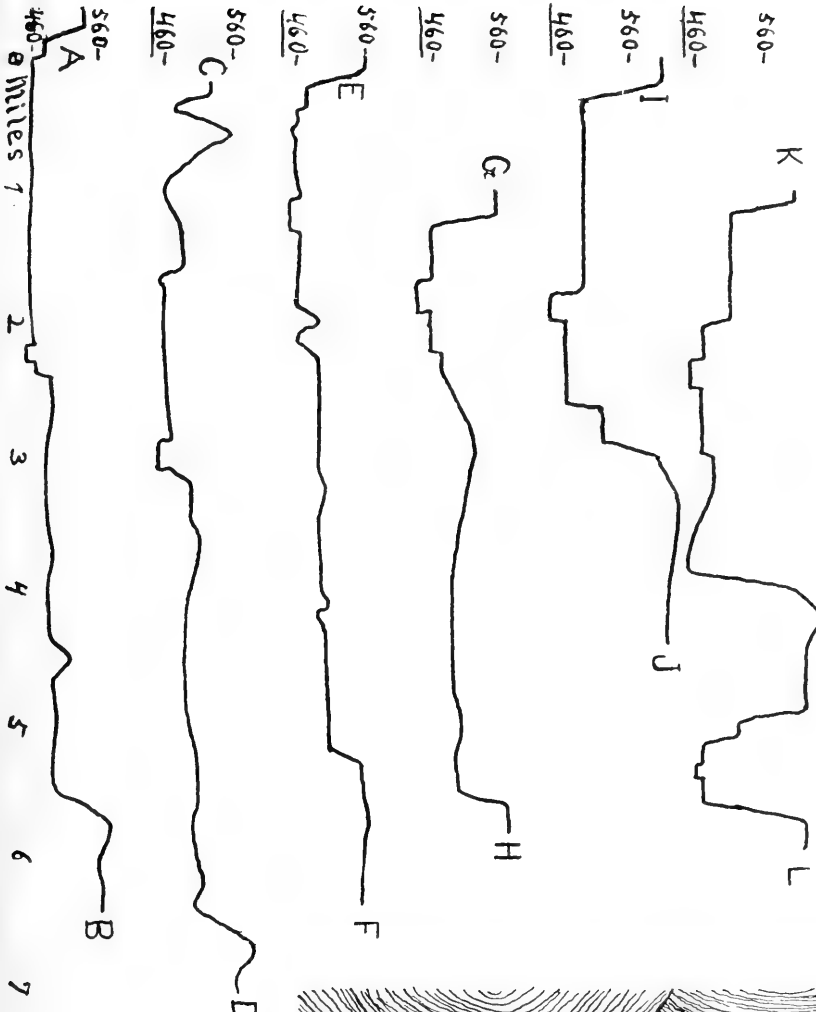

Figure 7

struction but not completed. In the northern part the river edge of the terrace rises 75-80 feet above flood plain, or to 535-540 feet A. T. A broad ridge extending southward from Atherton island reaches 550 feet A. T.

Feet A.T.
660-

Fig. 2



Section
in
Gravel Pit
at
Lyford

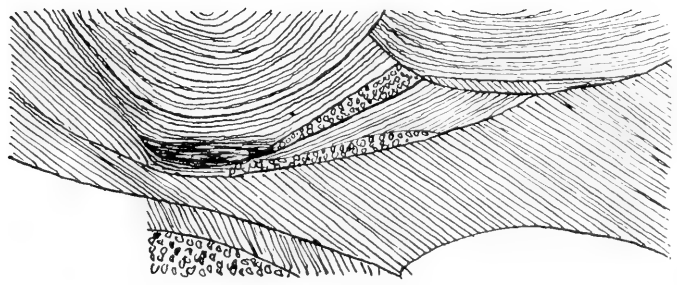

Borings at Terre Haute pass through 130-150 feet of gravel and at Lyford 160 feet. The structure as exposed in excavations is coarse sand and fine gravel, poorly stratified and exhibiting a great variety of cross-bedding in which the dip is nearly everywhere down stream. At Terre Haute the principal bedding is nearly regular, the average thickness of each bed seldom being more than one foot. (Fig. 7.) At Lyford the material is distinctly coarser and gives evidence of having been laid down by turbulent and rapidly changing streams, as shown in the section. (Fig. 3.) Imbedded in the gravel are crystalline boulders up to 2 or 3 feet in diameter and many rounded masses of boulder clay up to 10 feet in diameter. Here also are found numerous fragments of hard limestone, Mansfield sandstone, bituminous shale and coal which are absent or rare in the vicinity of Terre Haute.

Surface drainage on the terrace is wanting or very imperfect. Small streams which come down through the bluff are unable to make their way across the terrace and are lost in the shallow depressions between the ridges. Stronger streams, like Otter Creek and Spring Creek, have cut deep valleys through the terrace and maintain a perennial flow.

The Terre Haute terrace is only one among many similar features, but in many respects belongs to a class by itself. It alone is moraine-headed, holding the relation of a valley train to the Shelbyville moraine. It possesses some, but not all, of the characteristics of a typical valley train. It thins out from 160 feet in depth at Lyford to nothing at its lower end, which gives it a longitudinal slope from 550 feet A. T. to about 450 feet, or a fall of 100 feet in 27 miles. It is composed of somewhat coarser material at its head than at Terre Haute, and near the moraine its surface is pitted with a few small pond basins where detached ice blocks may have melted away. Its longitudinal sand bars are evidence that its surface topography is due to a broad stream which once entirely covered it, standing above 520 feet A. T. This greater Wabash was fed not only by the main Wabash stream, but also by a tributary half as large from the present Raccoon Valley to be described in another paper. These two streams came together at the south end of Atherton Island and built up between them a bar 5 miles long and a mile wide with characteristic mounds and undrained saucer shaped hollows. The old Raccoon channel between this bar and the east bluff is a depression a mile wide and 30 feet deep, now occupied by a nameless tributary of Otter Creek.

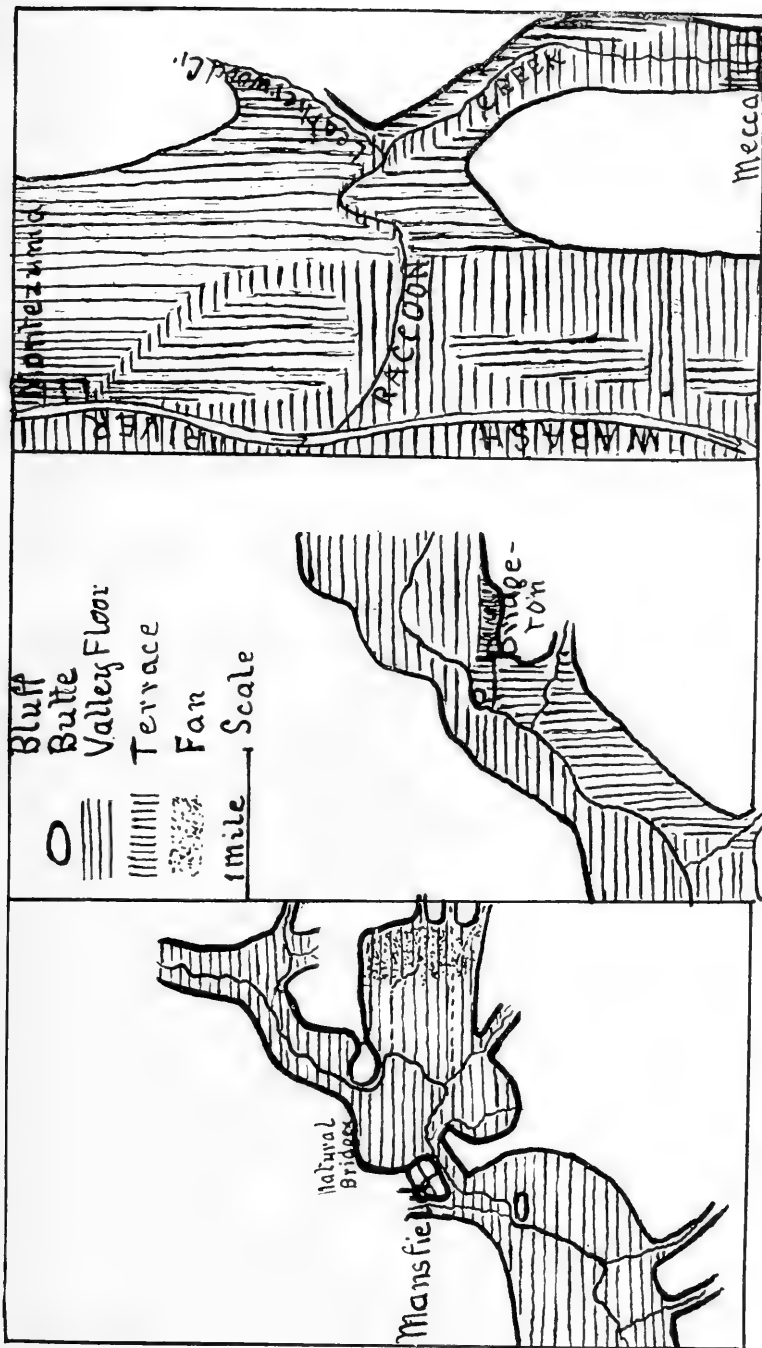

Fig. 3 B C

A

Summary. In Parke, Vermillion and Vigo counties the Wabash Valley is bordered by massive alluvial terraces, which alternate from one side to the other, but overlap. They were deposited by a loaded, shifting, braided stream, (Fig. 8) changing rapidly in volume and speed, and represent the outwash from the waning Wisconsin ice sheet. They are remnants of a once more extensive deposit which filled the valley from bluff to bluff to the height of the terrace tops. The present flood plain is the valley cut out of this deposit by a stream of larger volume, smaller load and possibly



Figure 8. A Temporary Loaded and Braided Stream in a Gravel Pit.

greater fall and speed than the glacial Wabash. The outlet of glacial lake Maumee would fairly meet these requirements.

II.

THE RACCOON VALLEY, PARKE COUNTY, IND.

Big Raccoon Creek rises in Boone County and flows southwest across Montgomery, Putnam and Parke counties to Rosedale, a distance in a straight line of about 45 miles. Near Rosedale it turns to a little west of north and flows 12 miles to its junction with the Wabash. Its upper course

for 20 miles is in the Knobstone, its middle course for an equal distance is through the Mansfield sandstone, and its lower course for 17 miles is in the shales and sandstones of the coal measures. Its upper course has not been studied. The middle course from Raccoon village to near Mansfield is interesting but not abnormal. (Fig. 1.) The valley is about a quarter of a mile wide, expanding at the mouths of tributaries and bounded by steep bluffs 50-80 feet high. The corn-covered bottom lands, enclosed by forested bluffs, and the frequent changes in the curve of the stream and in the width of the valley combine to give this part a picturesque charm unsur-



Figure 9. Middle Raccoon Valley.

passed in Indiana. It is unfortunate that no artist has yet found it. (Fig. 9.)

A mile above Mansfield the stream enters an east and west valley three-quarters of a mile wide and is joined by Rocky Fork, a large tributary from the south. (Fig. 3A.) The locality presents several peculiar features. The wide valley extends a mile east from the mouth of Rocky Fork and ends in a square cul-de-sac, bounded on three sides by high, smooth bluffs. It is traversed by two insignificant wet weather streams whose tributaries have built a fan across the end. There is no sign, and apparently no possibility, that it ever contained meander curves of the Raccoon. Directly in the course of the Raccoon at its entrance to this

expansion, stands a hill or butte 100 feet high, of oval outline with diameters of one-quarter and three-eighths of a mile. (Fig. 10.) It is of sandstone up to 80 feet and the eastern half is capped with 20 feet of boulder clay. The whole arrangement is very suggestive of the ileo-caecal junction of the intestine, in which the butte plays the part of the valve. On the west the expanded valley is bounded by a curved ridge, through which the Raccoon passes by a gorge 1,000 feet wide between sandstone bluffs 40 feet high. (Fig. 11.) At the village of Mansfield the gorge ends and the valley expands abruptly to one mile. In its midst, just below Mansfield, stands a



Figure 10. Upper Mansfield Butte.

second butte somewhat smaller than the one previously described, 60 feet high, its lower half of sandstone, its upper of glacial clay full of large boulders. (Fig. 12.)

The mile-wide valley floor continues five miles to Bridgeton, (Fig. 3B), where it narrows to less than a quarter of a mile, being pinched by a terrace on the south side, half a mile wide and two miles long. In the stream bed and base of the terrace up to 35 feet a soft gray micaceous sandstone is exposed in thin beds dipping to the south. On the edge of the terrace an isolated mound of alluvial sand and gravel rises to 50 feet.



Figure 12. Lower Butte at Mansfield, 60 ft. high.

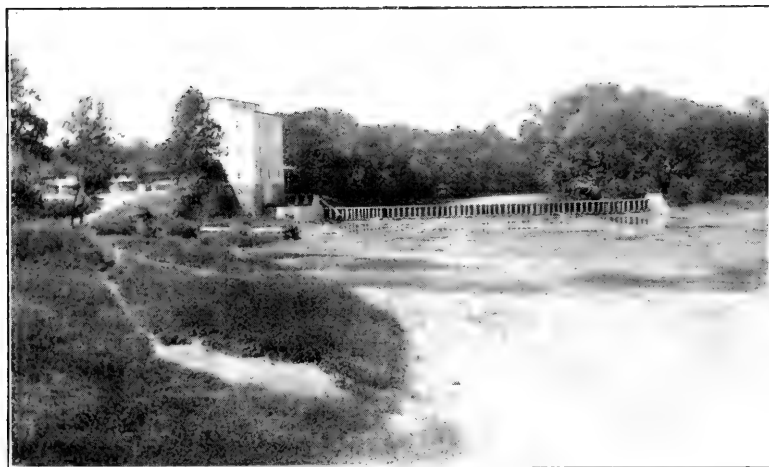

Figure 11. Mouth of Mansfield Gorge.

The surface of the terrace at the village of Bridgeton stands at 554 feet A. T., but slopes gently upward toward the bluff, where it reaches within 25-30 feet of the top. Below Bridgeton the valley widens to $1\frac{1}{2}$ miles and is bounded by bluffs 75 feet high, with many blunt salient and re-entrant angles. (Fig. 13.) In this part of its course the Raccoon has cut in the valley floor a flood plain 5-15 feet below the general level. It is heavily loaded and at low water wanders through a wide belt of sand bars and islands. (Fig. 14). At Rosedale the valley widens to three miles and, continuing to the southwest, opens into the Wabash Valley, as described in another paper. But the stream, turning abruptly to the northwest, leaves this valley and enters another which narrows at Coxville to less than one-quarter of a mile. Thence it maintains a width of about a half mile to its emergence through the Wabash bluff at Armiesburg. The lower Raccoon Valley is bounded by bluffs 140-150 feet high. At Mecca a narrow alluvial terrace on the west side is 40 feet high and one mile long. A little below Mecca a similar terrace begins on the east side and continues to the mouth of Leatherwood Creek. The gap in the Wabash bluff through which the Raccoon-Leatherwood stream passes is $1\frac{1}{2}$ miles wide and blocked by the Montezuma terrace 50 feet high. The cut through the terrace is only 750 feet wide. (Fig. 3C.)

The abnormalities of the Raccoon present many interesting problems. Obviously, the middle Raccoon Valley once transmitted a stream as large as White River directly to the Wabash below Atherton Island. The course of its tributaries, Little Raccoon, Iron Creek and lesser streams are wholly abnormal to the present course of the lower Raccoon and accordant only with a trunk stream flowing southwest to the Wabash. Where did a river of such magnitude come from? The present upper Raccoon was only a modest tributary to it. The cul-de-sac above Mansfield points to a possible and I think probable answer. The preglacial Raccoon was a large river with a course of hundreds of miles and a basin second in extent to no other tributary of the Wabash. What is left of its valley begins two miles above Mansfield, where it is filled and obliterated by the Shelbyville moraine which lies across it, and by the Wisconsin drift sheet which stretches away to Canada. No effort to trace the valley east of the Mansfield cul-de-sac has been made. Such an effort would probably be fruitless for lack of well borings.

The ridge across the valley at Mansfield seems at one point to be

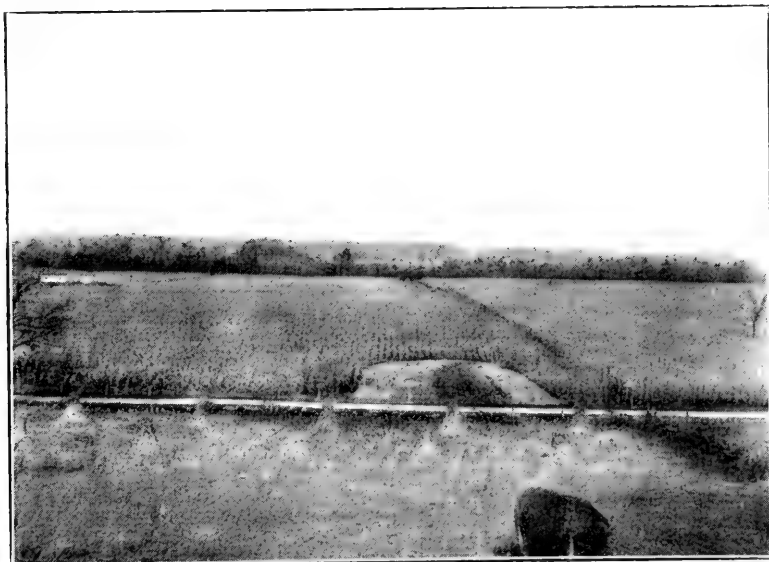

Figure 13. Raccoon Valley below Bridgeton.



Figure 14. Low Water in Raccoon below Bridgeton.

wholly composed of drift, and is probably a remnant of the moraine which dammed the valley and compelled the stream to cut the gorge through sandstone, perhaps by the retreat of a waterfall.

The Bridgeton terrace is about 30 feet above the present divide between the Raccoon and the Wabash at Rosedale and demands some kind of a dam of corresponding height at that point. Such a dam would also account for the turning of the Raccoon over a col at Coxville into the valley of a northward flowing tributary of Leatherwood, and solve the problem of the lower Raccoon and its reversed tributaries. Such a dam once existed and does not now exist. Very large dams which vanish at a convenient time are usually made of ice. I therefore postulate an ice dam across the space between Atherton Island and the east bluff of the Wabash. The lake held up by such a dam found its lowest outlet to the north near Coxville. The dam lasted long enough to permit the aggradation of the valley to the height of the Bridgeton terrace and the subsequent cutting down of the outlet to its present level or lower. The whole valley is filled with sand and gravel to depths which borings alone can reveal. Wells on the valley floor are usually very shallow. One is reported near Bridgeton to have passed through 150 feet of gravel, which is not improbable. The ice dam may have been a part of the Illinoian ice sheet and the valley cutting of the lower Raccoon may have proceeded during the long interglacial interval. Among all the changes and chances of two glacial periods and one interglacial, a part of the Wabash water may have followed that valley, making Atherton Island truly insular. The present fall from Rosedale to the mouth of Raccoon is 75 feet, which could be easily reversed by removal of filling.

During the climax and retreat of the Wisconsin ice sheet, the valleys of the Wabash and its tributaries were aggraded to the present terrace levels. For a time the present mouth of the Raccoon was blocked by ice and the stream flowed over the terrace directly to the Wabash. By the final withdrawal of the ice margin from the Shelbyville moraine the northern outlet was left a little lower than the Rosedale divide, and the present conditions came into existence.

III.

A NATURAL BRIDGE IN PARKE COUNTY, IND.

About two miles northeast of Mansfield, Parke County, there is a natural bridge of sufficient interest to be noticed. A small tributary of Raco-

coon Creek has cut a ravine in the Mansfield sandstone bluff and originally fell over a ledge about six feet high. A joint plain 20 feet back from the brink of the fall permitted the stream to descend and work its way under the stratum. The result is a natural bridge 60 feet long, 20 feet wide, 2 feet thick in the middle, with a span of 30 feet and a clear height of 6 feet underneath. (Fig. 15.)



Figure 15. Natural Bridge, Mansfield, Ind.

THE DETERMINATION OF HYDROGEN, NITROGEN AND METHANE IN GAS BY COMBUSTION IN A QUARTZ TUBE.

BY FRANK C. MATHERS AND IRA E. LEE.

The purpose of this research was to devise a more convenient and a more accurate method for the determination of hydrogen, nitrogen and methane in gas. Many different methods¹ have been advocated for making this analysis. The Drehschmidt method² of burning the gas residue mixed with oxygen, by passing it through a hot platinum capillary tube is perhaps the best scheme. However, the high cost of the platinum capillary tube together with the rapid deterioration of the apparatus makes a modification desirable. The experiments described in this paper show that a quartz tube filled with pieces of scrap platinum is an entirely satisfactory substitute for the platinum capillary tube in the Drehschmidt apparatus.

The quartz tube was 30.5 cm. long, 7.25 mm. outside and 3.38 mm. inside diameter. Its volume, determined by the weight of mercury required to fill it, was 3.317 cc. The platinum scrap which was used as a contact substance in the quartz tube was prepared by cutting pieces of ordinary scrap platinum wire, which every laboratory has in quantity, into as short pieces as possible with a shears. These small fragments were then placed upon stiff paper which was passed through a cornet roll mill a number of times. These flattened pieces of platinum presented a large surface to the passing gas and at the same time offered very little resistance to the passage of the gas. Two pieces of scrap platinum gauze were used, one in each end of the quartz tube, to keep the small pieces of platinum in position. The platinum weighed 11.189 grams and had a volume of 0.522 cc. The platinum occupied 21.6 cm. of the length of the tube.

The data concerning the many preliminary experiments which merely served to detect the errors, will be omitted. The following form of apparatus and manipulation were found to be satisfactory.

A mercury pipet holding the gas to be burned and the oxygen required for the combustion, was connected to one end of the quartz tube by a

¹"Review of progress in gas analysis," *Chemiker Zeitung*, 32:801 and 817 (1908).

²Hempel-Dennis, "Gas Analysis," p. 140.

suitable capillary tube with rubber connections. A mercury buret, arranged to receive the gas, was connected to the other end of the quartz tube in a similar manner. Pinch cocks, one on the buret and one on the pipet, controlled the connections with the quartz tube. The buret was provided with a water jacket which was connected at its lower end with a level bottle so arranged that the water could be drawn out and then passed back into the water jacket. This circulation and thorough mixing of the water were necessary to prevent unequal temperatures between the top and bottom of the buret. The water jacket was improvised from the outside of a Liebig condenser. A thermometer, which showed the temperature of the water and gas, was suspended about midway of the buret inside of the water jacket. The quartz tube was heated by a bunsen burner provided with a wing tip which produced a broad flame. An asbestos board was suspended about 5 mm. above the quartz tube, to lessen the radiation of heat. The manipulation was: The temperature of the gas in the pipet, that is the temperature at which it was measured, was carefully read. The pinch-cock connecting the buret to the quartz tube was opened and the burner was lighted for three minutes. The increase in volume of the air in the quartz tube produced by the heat, was cared for in the buret. The pinch-cock connecting the pipet to the quartz tube was opened and the level bottle was raised so that the gas and oxygen passed slowly and regularly over the glowing platinum, generally about three minutes being required. In no case was there any indication of an explosion in the pipet even when the velocity of the gas was greatly increased. The level tube on the buret was raised and the level bottle on the pipet was lowered so that the gas was forced back from the buret into the pipet. The gas was then again passed through the quartz tube over the glowing platinum into the buret. The flame and the asbestos board were removed and water was poured upon the quartz tube to cool it. After the quartz tube had reached room temperature, the pinchcock connecting the buret and quartz tube was closed. The mercury in the buret and level tube was leveled. The water in the water jacket was passed back and forth by means of the level bottle until the thermometer in the water jacket showed constant temperature. The mercury in the buret and level tube was again carefully leveled and the volume of gas was read. The final gas volume was always corrected for variation from the initial temperature.

The process as described above was tried with pure hydrogen gas, which was prepared by the action of boiled dilute sulphuric acid upon

pieces of zinc contained in a gas double pipet for solids. The pipet was filled with boiled distilled water to displace the air. The sulphuric acid was added through a glass tube which entered through the opening for the introduction of solids into the pipet. The hydrogen gas was allowed to escape completely from the apparatus several times before any was saved for analysis. This form of generator very effectively protected the hydrogen gas from the diffusion of air. The results are given in the following table:

Hydrogen Used.	Air Added.	Volume after Combustion.	Time of Experiment.	TOTAL CONTRACTION	
				Experimental	Theory
26.02	90.6	77.6	2.5 minutes	39.03	39.03
21.06	77.9	66.75	2.3	31.6	31.59
20.4	77.9	67.7	3.5	30.6	30.6

The following table shows the results which were obtained in the analysis of gas residues:

Residue cc.	Oxygen cc.	Volume after Combustion.	Time	Total Contraction.	Carbon Dioxide.	Hydrogen	Nitrogen	Methane
51.9	80.4	50.2		82.1	18.8	29.7	3.4	18.8
52.3	71.3	42.4	3	81.4	17.5	29.4	4.25	18.65
52.16	67.18	38.	2	81.34	17.77	29.	3.9	18.9

The result in experiment 1 was obtained with the ordinary combustion pipet. This value was taken as the standard. Experiment 2 in the table shows 17.5 per cent. of carbon dioxide, which was of course obtained by the absorption of the carbon dioxide which was in the buret. This value must be corrected for the amount of carbon dioxide which remained in the quartz tube. The total gas residue after combustion (including the air originally in the quartz tube) was 42.4 plus 2.795 (the volume of the quartz tube which was unoccupied by platinum) which was 45.195. So 93.8. ($42.4 \div 45.195$), was the per cent. of the gas which was measured in the buret.

All of the results given in the tables show that the quartz tube is as accurate as the combustion pipet. It was found necessary to pass air through the quartz tube to remove the carbon dioxide produced by one experiment if another experiment was to be made at once. If only total contraction was desired the carbon dioxide did not need to be removed. If nitrogen was to be determined the gas remaining in the tube from a previous experiment had to be removed by passing air.

This apparatus gave an excellent method of determining the total nitrogen in gas. The gas was mixed with an excess of oxygen whose nitro-

gen contents was accurately determined. After combustion in the quartz tube, the gas was passed into potassium hydroxide and alkaline pyrogallol pipets. The unabsorbed residue consisted of the nitrogen in the gas and the nitrogen which was in the oxygen. The results are as follows:

Gas	Oxygen.	Nitrogen added in Oxygen	Total Nitrogen	Nitrogen in Gas Taken	Nitrogen per cent.
49.9	76.4	7.10	8.68	1.58	3.17
50.0	74.05	6.95	8.62	1.67	3.34
49.93	78.04	7.19	8.78	1.58	3.20

Other tests showed that under the conditions of the experiment less than 67.7 cc. of the oxygen (63.4 cc. of pure oxygen) did not give complete combustion with 50 cc. of the gas. This was 12 cc. of pure oxygen in excess.

SUMMARY.

Gas residues after the addition of oxygen gas were burned by passing them through a heated quartz tube which contained pieces of scrap platinum. The results are very accurate.

The advantages of this apparatus over the standard combustion pipet are:

1. The quartz tube and pieces of platinum are not easily broken or damaged during use. The quartz tube, however, is brittle and will break if struck a blow. The combustion pipet is very easily broken and the small platinum wire often burns out even when great care is exercised by the operator.

2. No metal or other substance which can be oxidized or acted upon by any of the gases is present in the quartz tube during the burning. In the combustion pipet, mercury, an oxidizable metal, is always present. In some of the experiments during this research, the conditions were such that very serious errors were made by the absorption of gases by the mercury. Everyone is familiar with the formation of oxides upon the mercury and upon the sides of the combustion pipet.

3. Small cracks in the glass tubes, or leaks around the rubber stopper or places where glass tubes enter, in the combustion pipets cause serious errors. There is very little chance for leaks in the quartz tube apparatus.

4. Platinum scrap such as short lengths of wire which is generally plentiful in laboratories, is used in this apparatus. The quartz tubes are cheap.

The disadvantages of this new process are:

1. The gas becomes heated during the combustion, so care must be taken to determine the final temperature at which the gas is measured. Corrections must be made for all temperature changes.

2. A correction must be made for the carbon dioxide which remains in the quartz tube after the combustion. This disadvantage can be overcome perhaps by the use of a smaller bore capillary quartz tube in which the volume is so small that a correction is unnecessary.

Indiana University, Bloomington.

NEW METHODS FOR THE PREPARATION OF SALTS OF SELENIC ACID.

BY FRANK C. MATHERS AND J. OTTO FRANK.

The purpose of this paper is to describe the preparation of metallic selenates from ammonium selenate. Ammonium selenate is the best starting material on account of the very satisfactory method¹ by which it may be prepared. An outline of the method for preparing ammonium selenate is as follows: Selenic acid was first prepared by oxidizing a solution of selenium in nitric acid with potassium permanganate. This solution after the removal of the manganese dioxide precipitate by filtration was precipitated with lead nitrate. The lead selenate thus formed was washed thoroughly until free from soluble salts. The treatment of this solid lead selenate with an excess of a strong solution of ammonium carbonate produced lead carbonate and ammonium selenate in solution. Pure ammonium selenate crystallized from the filtrate upon evaporation while the excess of ammonium carbonate was volatilized.

There are three methods by which this ammonium selenate may be changed into metallic selenates. They are as follows:

1. The crystallization of a solution of ammonium selenate with a metallic nitrate will give crystals of the most insoluble salt which can be formed by any combination of the four ions in solution. The most soluble combination of the ions will remain in the mother liquor. The solubility of the possible combinations of the four ions is in this order beginning with the most soluble, ammonium nitrate, metallic nitrate, ammonium selenate, and ammonium metallic selenate or metallic selenate. Whether the metallic selenate or the double ammonium salt is formed depends upon their relative solubility except that by increasing the amount of ammonium selenate the double salt may be produced in cases where the metallic salt is ordinarily formed. For example, equivalent amounts of ammonium selenate and copper nitrate give copper selenate while two equivalents of the ammonium selenate to one of copper nitrate gives the ammonium copper selenate.

¹ Mathers and Bonsib, Jour. Amer. Chem. Soc., 33,703 (1911); Indiana University Studies, 841 (1910).

The following table shows the quantities of materials used, the salts formed and the yields :

Weight of ammonium selenate used.	Formula of nitrate and grams used.	Molecules of ammonium selenate to one of the nitrate.	Formula of Salt formed.	Grams of salt formed.	Theoretical yield.
30.....	Cu (NO ₃) ₂ ·3H ₂ O.58	1 : 1	Cu SeO ₄ ·5H ₂ O.....	49.6	50.
40.....	NiONO ₃ ·6H ₂ O.32.	2 : 1	NH ₄ ·Ni(SeO ₄) ₂ ·6H ₂ O....	48.5	54.
40.....	Co(NO ₃) ₂ ·6H ₂ O.32.	2 : 1	NH ₄ ·Co(SeO ₄) ₂ ·6H ₂ O....	52.1	54.
40.....	Mn(NO ₃) ₂ ·6H ₂ O.32.	2 : 1	NH ₄ ·Mn(SeO ₄) ₂ ·6H ₂ O....	52.1	54.
20.....	Zn(NO ₃) ₂ ·6H ₂ O.33.	1 : 1	NH ₄ ·Zn(SeO ₄) ₂ ·6H ₂ O....	27.1	27.6
20.....	Al(NO ₃) ₃ ·9H ₂ O.42	2 : 1	NH ₄ Al(SeO ₄) ₂ ·12H ₂ O....	115.	122.

The following table shows the volume of the solution used in the preparation of each selenate, the amount of selenate present, and the amount which crystallized upon standing over night. This table gives an idea of the relative solubility of these selenates and shows the volumes of solution to use in preparing them:

TABLE IV.

Formula of salt crystallized.	Weight of Salt Present.	Volume of solution.	Weight of Salt Crystallized.
CuSeO ₄ ·5H ₂ O.....	49.63 grams.....	150 C. C.....	18 grams.
Ni·NH ₄ ·(SeO ₄) ₂ ·6H ₂ O.....	48.52 grams.....	225 C. C.....	4.93 grams.
Co·NH ₄ ·(SeO ₄) ₂ ·6H ₂ O.....	52.60 grams.....	98 C. C.....	4.42 grams.
Mn·NH ₄ ·(SeO ₄) ₂ ·6H ₂ O.....	52.12 grams.....	65 C. C.....	9.80 grams.
Zn·HNH ₄ ·(SeO ₄) ₂ ·6H ₂ O.....	27.10 grams.....	110 C. C.....	8.13 grams.
Al·NH ₄ ·(SeO ₄) ₂ ·12H ₂ O.....	115.00 grams.....	150 C. C.....	13.52 grams.

The following table gives the results of analyses which were made to determine the formulas of the salts:

Formula.	Per cent Found		Per cent. From Theory.	
	NH ₄	Metal.	NH ₄	Metal.
CuSeO ₄ ·5H ₂ O.....		21.5		21.4
NH ₄ ·Ni(SeO ₄) ₂ ·6H ₂ O.....	6.7	11.9	6.9	12.
NH ₄ ·Co(SeO ₄) ₂ ·6H ₂ O.....	6.8	12.3	6.7	12.
NH ₄ ·Mn(SeO ₄) ₂ ·6H ₂ O.....	6.9	11.3	7.0	11.3
NH ₄ ·Zn(SeO ₄) ₂ ·6H ₂ O.....	6.6	13.2	7.1	13.6
NH ₄ Al(SeO ₄) ₂ ·12H ₂ O.....	3.1	4.9	3.1	4.9

2. Ammonium selenate can be decomposed by basic metallic oxides with the formation of the metallic selenate and volatilization of the free ammonia. For example:

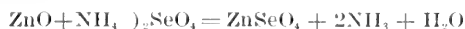

Zinc oxide was selected because of its pronounced basic properties. Ammonium selenate, dissolved in water, was treated with an excess of zinc oxide. The evolution of ammonia was slow at room temperature but was more rapid at the boiling point. Zinc selenate and not the double salt was obtained by crystallization of the solution. The yield was only about 25 per cent. of the theory. Analysis of the $\text{ZnSeO}_4 \cdot 7\text{H}_2\text{O}$ showed 18.8 per cent. zinc while the theory is 19.4.

3. This method makes use of copper selenate prepared as described above. Any metal more electropositive than copper will precipitate copper from a copper selenate solution and form a selenate of the metal that was used. This is the best method of making the metallic selenates since a pure solution of the metallic selenate can be obtained. The previous preparation of the copper selenate from the ammonium selenate is exceptionally easy. Selenates of cadmium and zinc were prepared by treating solutions of 15 grams copper selenate dissolved in 50 cc. of water with an excess of metallic cadmium and metallic zinc respectively. The yield of cadmium selenate was 14.1 grams and of zinc selenate 16.7 grams while the theory was 14.7 and 16.3 respectively.

SUMMARY.

Ammonium selenate, on account of the very satisfactory method for its preparation, is the most suitable starting material for the making of metallic selenates. The three methods that were tried for preparing metallic selenates from ammonium selenate are:

1. Crystallization of a solution containing ammonium selenate and a metallic nitrate will produce crystals of the double ammonium selenate (or the metallic selenate in some cases) since this salt is the most insoluble which can be produced by any possible combination of the four ions. The yields are good.

2. Ammonium selenate can be decomposed by basic metallic oxides with the formation of the metallic selenate and of free ammonia. This is not a satisfactory method and the yields are low.

3. The treatment of copper selenate solution with any metal which is more electropositive than copper will precipitate metallic copper and form the corresponding metallic selenate. This is a very satisfactory method and the yields are practically quantitative.

A NEW METHOD FOR THE QUALITATIVE DETECTION OF CHLORIDES IN THE PRESENCE OF BROMIDES AND IODIDES.

BY FRANK C. MATHERS AND IRA E. LEE.

Most of the schemes for the separation of chlorides from bromides and iodides depend upon one of two general methods.

1. Most of the qualitative manuals direct the treatment of the solution of the halogens with an oxidizing agent of such a strength that iodine and bromine but not chlorine are set free. The liberated bromine and iodine may be removed from the solution by boiling, or by a current of air or by shaking out with some solvent such as carbon bisulphide. Experiments conducted by advanced students in this laboratory with this general method have been fairly successful, except that some chlorine is always set free if the reaction is carried far enough to remove all of the bromine. This method was found to be a failure in the hands of inexperienced students in qualitative analysis, perhaps on account of the necessity of exceptionally close adherence to directions.

2. The other general scheme for the separation depends upon the fact that silver chloride is soluble and silver iodide and bromide are insoluble in ammonium carbonate solution. After filtration from the undissolved silver bromide and iodide, the silver chloride is reprecipitated by neutralizing the ammonium carbonate with nitric acid. However, silver bromide, is soluble enough to produce a strong turbidity upon addition of the nitric acid. This is very confusing to the students. In addition to this trouble, the method is so very delicate that traces of chlorides which are present in most chemical reagents as impurities, will give a distinct turbidity so that the student is forced to decide from the quantity of precipitate whether chlorides have been added or not.

In the scheme described in this paper, the residue of silver chloride, bromide and iodide is treated with dilute ammonium hydroxide or carbonate, and the filtrate is treated with ammonium chloride, which will produce a turbidity or precipitate if silver chloride is present. This precipitation is caused by the action of the ion Cl from the ammonium chloride upon the common ion Cl from the silver chloride. The ammonium chloride

causes the amount of chlorine as ion in the solution to exceed the saturation concentration of the chlorine ion in equilibrium with silver, so some of the silver chloride must precipitate. Silver bromide is not affected because there is no common ion in this case.

In the following table, the ammonium hydroxide (1 : 100) solution was saturated by warming with an excess of freshly precipitated silver chloride. The ammonium chloride solution contained 25 grams per 100 cc.

Cc. of Ammonium Hydroxide-Silver Chloride Used.	Cc. of Ammonium Hydroxide (1:100) Added.	AMMONIUM CHLORIDE 25% REQUIRED TO		
		Produce a Precipitate.	Give Maximum Precipitation.	Redissolve Precipitate.
10	0	1 drop	5 drops	12 cc.
10	10	1 drop	5 drops	20 cc.
10	17	1 drop	10 drops	
10	19	5 drops		
10	20	1 cc.		

This table shows that the ammonium hydroxide silver chloride solution should be nearly saturated with the silver chloride, since large amounts of the ammonium hydroxide make precipitation impossible or very difficult.

In the following table, the ammonium hydroxide silver chloride solution was made by dissolving the silver chloride from 10 cc. of 0.8 N KCl in 100 cc. of 10 per cent. ammonium hydroxide. This solution was then diluted to 1000 with water. Each cc. of this solution contained 0.28 mg. of chloride.

Cc. of Ammonium Hydroxide Silver Chloride Used.	Cc. of Ammonium Hydroxide (1:100) Added.	AMMONIUM CHLORIDE (25%) SOLUTION REQUIRED TO	
		Produce a Precipitate	Give Maximum Precipitation
10	0	1 drop (good)	5 drops
10	10	1 drop (slight)	10 drops
10	20	2 drops (slight)	20 drops
10	30	several drops	never good
10	40	40 drops	never good

One cc. of the ammonium hydroxide silver chloride solution containing 0.28 mg. chlorine gave a good precipitate when treated with the ammonium chloride solution. Dilution of the ammonium hydroxide silver chloride solution with water did not prevent the formation of the precipitate. However, the addition of ammonium hydroxide solution made the precipitation more difficult. 0.3 mg. of chlorine as silver chloride per 10 cc. of ammonium hydroxide (1:100) does not give a precipitate when am-

monium chloride is added. This means that traces of chlorides which occur as impurities in so many reagents will not cause trouble by giving tests by this method. Smaller quantities of chlorine may be detected by using more dilute ammonium hydroxide in dissolving the silver chloride.

Corresponding solutions prepared with silver bromide in place of silver chloride gave no precipitates with ammonium chloride. In every case they produced a turbidity when acidified with nitric acid.

SUMMARY.

This paper describes a new method for the qualitative separation and detection of chlorides in the presence of bromides and iodides.

The mixed silver halids are digested with ammonium hydroxide (10 per cent.). The filtrate is diluted with 10 volumes of water and treated with a few drops of ammonium chloride solution. If silver chloride is present a precipitate is produced.

This method has the advantages over other methods that:

1. Bromides do not give any precipitate.
2. The concentration of the ammonium hydroxide solution is great enough that traces of chlorides occurring as impurities will not give tests. The method becomes more delicate when more dilute solutions of ammonium hydroxide are used.

Indiana University, Bloomington.

INDEX.

	Page
Acetic Alcohol as a Killing and Fixing Agent in Plant Histology, by F. L. Pickett.....	79
An Instructive Modification of an Old Experiment, by Howard J. Banker	93
Arisema Triphyllum Corms; Length of Life of.....	77
Biometric Study of the Streptococci from Milk and from the Human Throat, by C. M. Hilliard.....	155
Birds: Laws in Indiana for the Protection of Birds, Their Nests and Eggs	9
Birds of Indiana, Notes on Some Species.....	59
Birds that Destroy Grapes, by Amos Butler.....	53
Butter Fat and Butter Fat Constants, by George Spitzer.....	127
By-laws of the Indiana Academy of Science.....	7
Chlorides, A New Method for the Qualitative Detection of, in the Presence of Bromides and Iodides.....	225
Coniology, by Robert Hessler.....	51
Conjugation in Spirogyra, by F. M. Andrews.....	89
Constitution of the Indiana Academy of Science.....	5
Contents of this Volume.....	3
Corn Pollination. Studies in.....	87
Corundum, System of Crystallization and Proper Cutting of Synthetic Gems of.....	169
Determination of Hydrogen, Nitrogen and Methane in Gas by Com- bustion in a Quartz Tube, by Mathers and Lee.....	215
Elements, Nascent State of.....	139
Energy, On the Atomic Structure of.....	157
Fern Prothalia, Some Environic Factors Influencing Their Develop- ment	85
Fungi of Indiana Not Heretofore Reported.....	99
Fungous Enemies of the Sweet Potato in Indiana, by C. A. Ludwig.....	103
Further Notes on Indiana Birds, by Amos Butler.....	59

	Page
Gas, the Determination of Hydrogen, Nitrogen and Methane by the Combustion of in a Quartz Tube.....	215
Heronry near Indianapolis, by Amos Butler.....	57
Improvements of Medicinal Plants, by F. A. Miller.....	115
Indiana Fungi—III, by J. M. Van Hook.....	99
Influence of Certain Environic Factors on the Development of Fern Prothalia, by D. M. Mottier.....	85
Length of Life of Arisæma Triphyllum Corms, by F. L. Pickett.....	77
Members of the Indiana Academy of Science.....	14
Minutes of the Twenty-eighth Annual Meeting.....	33
Mosses of Monroe County, by F. L. Pickett and Mildred Nothnagel....	69
Nascent State of the Elements, by Ransom and Stevens.....	139
Natural Bridge in Parke County, by Chas. R. Dryer.....	212
New Method for the Preparation of Salts of Selenic Acid, by Mathers and Frank.....	221
New Method for the Qualitative Detection of Chlorides in the Presence of Bromides and Iodides, by Mathers and Lee.....	225
Notes on the Intersection of Osculating Planes to the Twisted Cubic Curve, by A. M. Kenyon.....	189
Notes on the Seedless Fruits of the Common Persimmon, by D. M. Mottier	67
Notes on Some Puff-Balls of Indiana, by F. D. Kern.....	105
Notes on the System of Crystallization and the Proper Cutting of the Synthetic Corundum Gems, by Frank B. Wade.....	169
Officers for 1912-1913.....	11
On the Atomic Structure of Energy, by A. E. Caswell.....	157
On the Linear Difference Equations of the First Order with Rational Coefficients, by Thos. E. Mason.....	181
Penetration of Wood by Zinc Chloride, by E. G. Mahin.....	149
Persimmon. Notes on the Seedless Fruits of.....	67
Photosynthesis, an Experiment in.....	93
Photosynthesis in Submerged Land Plants, by Harry V. Heimburger....	95
Planes, Notes on the Intersection of Osculating Planes to the Twisted Cubic Curve.....	189
Plants, Improvement of Medicinal.....	115
Plants Not Hitherto Reported from Indiana, by Chas. C. Deam.....	81

	Page
Program of the Twenty-eighth Annual Meeting.....	39
Protection of Our Rivers from Pollution, by Jay Craven.....	47
Puff-Balls of Indiana, Some Notes on.....	105
Raccoon Valley, Parke County, Indiana, by Chas. R. Dryer.....	206
Report of the Work in Corn Pollination, by M. L. Fisher.....	87
Rivers of Indiana, Protection from Pollution.....	47
Selenic Acid, New Methods for the Preparation of the Salts of.....	221
Spirogyra, Conjugation of.....	89
Starch, Structure and Diagnostic Value of.....	121
Streptococci from Milk and the Human Throat, Biometric Study of....	155
Structure and Diagnostic Value of the Starch Grain, by R. B. Harvey..	121
Terraces of the Wabash Valley in Parke, Vermillion and Vigo Counties, by Chas. R. Dryer.....	191
Water Supply of Indiana, by H. E. Barnard.....	43
Wood, Penetration of by Zinc Chloride.....	149



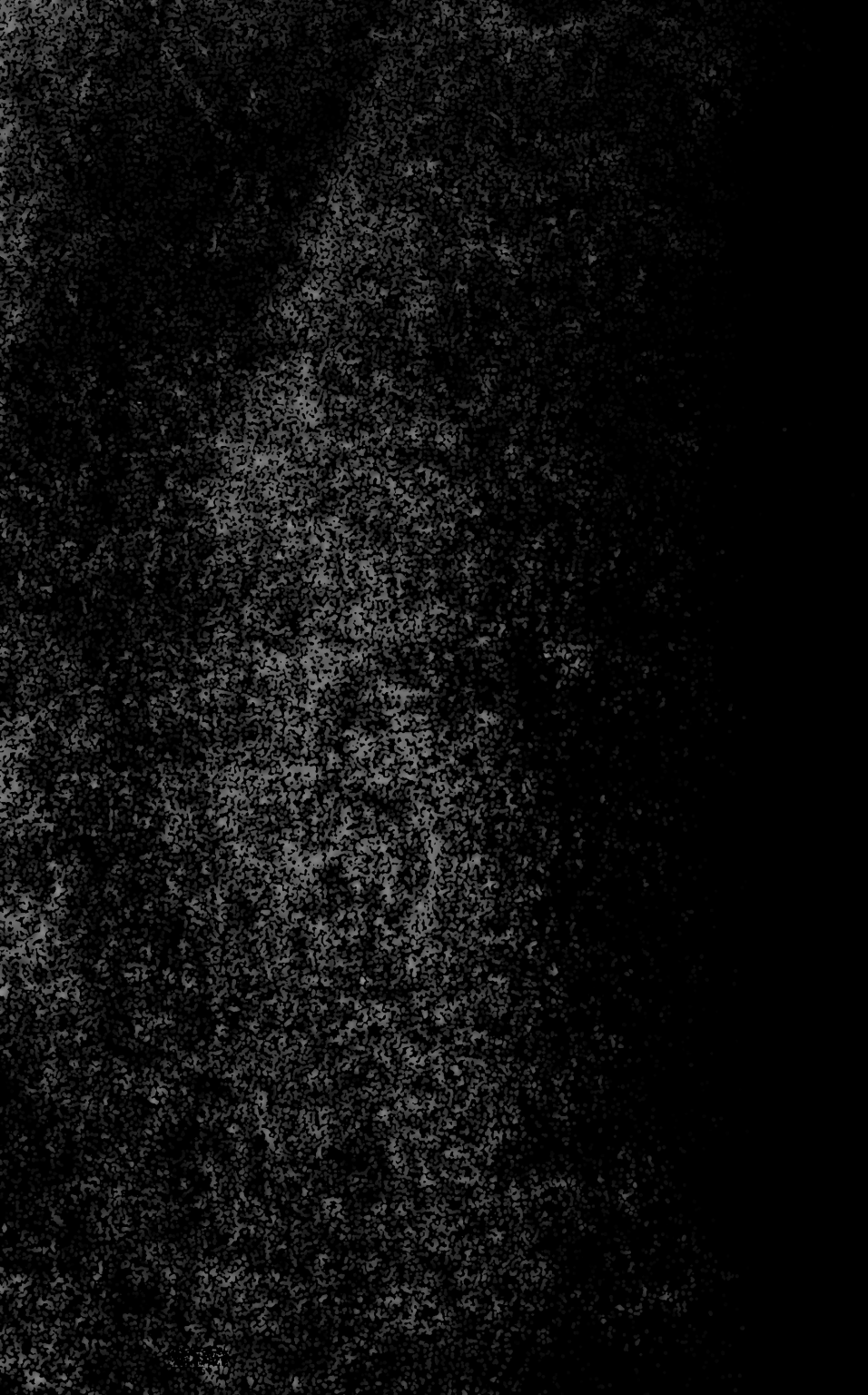

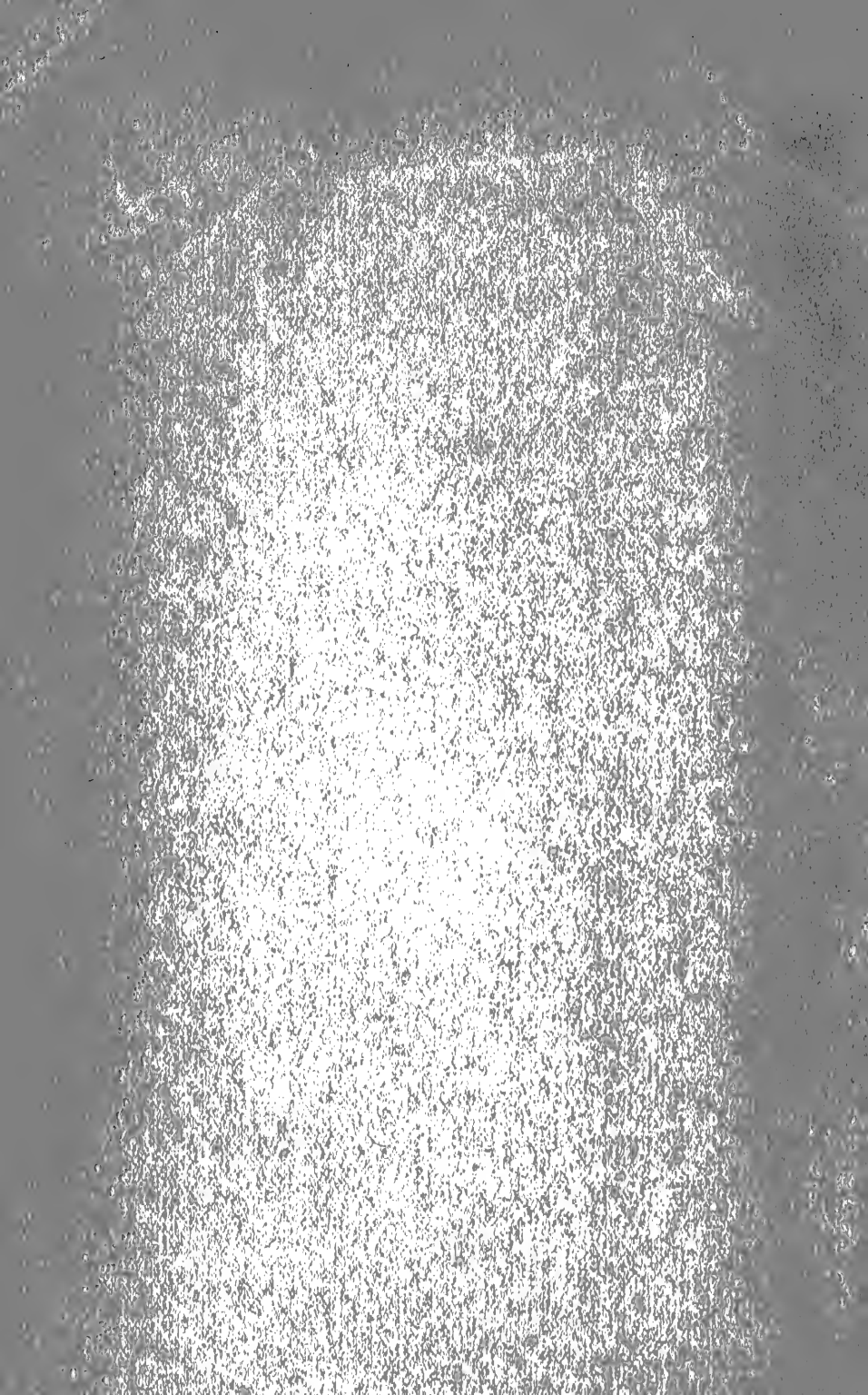

PROCEEDINGS

OF THE

Indiana Academy of Science

1913

H. E. BARNARD - - - - - EDITOR

INDIANAPOLIS :
WM. B. BURFORD, CONTRACTOR FOR STATE PRINTING AND BINDING
1914

TABLE OF CONTENTS.

	PAGE
Constitution	5
By-laws	7
Appropriation for 1913-1914.....	9
An Act for the Protection of Birds, Their Nests and Eggs.....	9
Public Offenses—Hunting Wild Birds—Penalty.....	10
Officers, 1913-1914	11
Executive Committee	11
Curators	11
Committees Academy of Science, 1914	12
Officers of the Academy of Science (A Table of).....	13
Members	14
Fellows	14
Active Members	22
Resolution of Sympathy to Charles W. Fairbanks.....	34
Minutes of Spring Meeting	35
Minutes of the Twenty-ninth Annual Meeting Indiana Academy of Science	37
President's Address: Work of the Indiana Academy of Science. Don- aldson Bodine	43
Wabash Studies, IV: The Flood of March, 1913, at Terre Haute. Charles R. Dryer.....	55
The Flood of March, 1913, Along the Ohio River and Its Tributaries in Southeastern Indiana. Glenn Gulbertson	57
The Wabash River Flood of 1913, at Lafayette, Indiana. R. L. Sackett	63
The Selective Action of Gentian Violet in Bacteriological Analysis. C. M. Hilliard	69
An Epidemic of Diarrhoea, Presumably Milk-borne. P. A. Tetrault...	75
On the Vertical Distribution of the Plankton in Winona Lake. Glen- wood Henry	77
A Simple Apparatus for the Study of Phototropic Responses in Seed- lings. George N. Hoffer	93
A Test of Indiana Varieties of Wheat Seed for Fungus Infection. George N. Hoffer	97
Pyropolyporus Everhartii (Ellis and Gall) Murrill as a Wound Para- site. George N. Hoffer.....	99
The Mosses of Monroe County, Indiana, II. Mildred Nothnagle and F. L. Pickett	103

	PAGE
Ecological Notes on Certain White River Algae. Paul Weatherwax...	107
Aphanomyces Phycophilus De Bary. Paul Weatherwax	109
Inheritance of the Length of Life in <i>Drosophila Ampelophila</i> . Roscoe R. Hyde	113
The Germination of Seeds of <i>Arisaema</i> . F. L. Pickett	125
Studies of <i>Camptosorus Rhizophyllus</i> , an Abstract of the Development of the Prothallium of <i>Camptosorus Rhizophyllus</i> , and the Resist- ance of the Prothallia of <i>Camptosorus Rhizophyllus</i> to Desiccation. F. L. Pickett	129
Irish Potato Scab (<i>Oospora Scabies</i>) as Affected by Fertilizers Con- taining Sulphates and Chlorides. S. D. Conner	131
Wabash Studies, V. Topographic Map of the Terre Haute Area. Chas. R. Dryer	139
Center of Area and Center of Population of Indiana. W. A. Cogshall..	141
The Shrinkage of Photographic Paper. R. R. Ramsey	143
Acyl Derivatives of O-Aminophenol. J. H. Ransom and R. E. Nelson.	145
Boiling and Condensing Points of Alcohol Water Mixtures. P. N. Evans	151
On the General Solution and So-Called Special Solutions of Linear Non-homogeneous Partial Differential Equations. L. L. Steimley.	157
A Modified Permeameter. Edwin Morrison and B. D. Morris	159
Sanitary Survey of Indiana Rivers. Jay A. Craven, C. E.....	167
The Relation of Lakes to Floods, with Special Reference to Certain Lakes and Streams of Indiana. Will Scott.....	173
First Steps in Indiana Forestry. Stanley Coulter.....	189
The Taxation of Forest Lands in Indiana. H. W. Anderson.....	197
Forests and Floods. F. M. Andrews.....	203
The Relation of County Tuberculosis Hospitals to Conservation of Public Health. James Y. Welborn, M. D.....	213
Playgrounds and Recreation Centers as Factors in Conservation of Human Life. Dr. W. A. Gekler.....	215
Public Toilets, Public Drinking Fountains and Public Spitting in rela- tion to the Conservation of Human Life. C. M. Hilliard.....	219
Power Economy in the Southern Indiana Quarry Industry. G. C. Mance	223
Report of the Committee on "A List of the Scientific and Technical Serials in the Libraries of the State of Indiana".....	237
List of Scientific and Technical Serials in the Libraries of Indiana....	240

CONSTITUTION.

ARTICLE I.

SECTION 1. This association shall be called the Indiana Academy of Science.

SEC. 2. The objects of this Academy shall be scientific research and the diffusion of knowledge concerning the various departments of science: to promote intercourse between men engaged in scientific work, especially in Indiana; to assist by investigation and discussion in developing and making known the material, educational and other resources and riches of the State; to arrange and prepare for publication such reports of investigation and discussions as may further the aims and objects of the Academy as set forth in these articles.

WHEREAS, The State has undertaken the publication of such proceedings, the Academy will, upon request of the Governor, or of one of the several departments of the State, through the Governor, act through its council as an advisory body in the direction and execution of any investigation within its province as stated. The necessary expenses incurred in the prosecution of such investigation are to be borne by the State; no pecuniary gain is to come to the Academy for its advice or direction of such investigation.

The regular proceedings of the Academy as published by the State shall become a public document.

ARTICLE II.

SECTION 1. Members of this Academy shall be honorary fellows, fellows, non-resident members or active members.

SEC. 2. Any person engaged in any department of scientific work, or in original research in any department of science, shall be eligible to active membership. Active members may be annual or life members. Annual members may be elected at any meeting of the Academy; they shall sign the constitution, pay an admission fee of two dollars and thereafter an annual fee of one dollar. Any person who shall at one time contribute fifty dollars to the funds of this Academy may be elected a life member of the Academy, free of assessment. Non-resident members may be elected

from those who have been active members but who have removed from the State. In any case, a three-fourths vote of the members present shall elect to membership. Application for membership in any of the foregoing classes shall be referred to a committee on application for membership, who shall consider such application and report to the Academy before the election.

SEC. 3. The members who are actively engaged in scientific work, who have recognized standing as scientific men, and who have been members of the Academy at least one year, may be recommended for nomination for election as fellows by three fellows or members personally acquainted with their work and character. Of members so nominated a number not exceeding five in one year may, on recommendation of the Executive Committee, be elected as fellows. At the meeting at which this is adopted, the members of the Executive Committee for 1894 and fifteen others shall be elected fellows, and those now honorary members shall become honorary fellows. Honorary fellows may be elected on account of special prominence in science, on the written recommendation of two members of the Academy. In any case a three-fourths vote of the members present shall elect.

ARTICLE III.

SECTION 1. The officers of this Academy shall be chosen by ballot at the annual meeting, and shall hold office one year. They shall consist of a President, Vice-President, Secretary, Assistant Secretary, Press Secretary and Treasurer, who shall perform the duties usually pertaining to their respective offices and in addition, with the ex-presidents of the Academy, shall constitute an Executive Committee. The President shall, at each annual meeting, appoint two members to be a committee, which shall prepare the programs and have charge of the arrangements for all meetings for one year.

SEC. 2. The annual meeting of this Academy shall be held in the city of Indianapolis within the week following Christmas of each year, unless otherwise ordered by the Executive Committee. There shall also be a summer meeting at such time and place as may be decided upon by the Executive Committee. Other meetings may be called at the discretion of the Executive Committee. The past Presidents, together with the officers and Executive Committee, shall constitute the council of the Academy, and represent it in the transaction of any necessary business not especially provided for in this constitution, in the interim between general meetings.

SEC. 3. This constitution may be altered or amended at any annual meeting by a three-fourths majority of the attending members of at least one year's standing. No question of amendment shall be decided on the day of its presentation.

BY-LAWS.

1. On motion, any special department of science shall be assigned to a curator, whose duty it shall be, with the assistance of the other members interested in the same department, to endeavor to advance knowledge in that particular department. Each curator shall report at such time and place as the Academy shall direct. These reports shall include a brief summary of the progress of the department during the year preceding the presentation of the report.

2. The President shall deliver a public address on the morning of one of the days of the meeting at the expiration of his term of office.

3. The Press Secretary shall attend to the securing of proper newspaper reports of the meetings and assist the Secretary.

4. No special meeting of the Academy shall be held without a notice of the same having been sent to the address of each member at least fifteen days before such meeting.

5. No bill against the Academy shall be paid without an order signed by the President and countersigned by the Secretary.

6. Members who shall allow their dues to remain unpaid for two years, having been annually notified of their arrearage by the Treasurer, shall have their names stricken from the roll.

7. Ten members shall constitute a quorum for the transaction of business.

AN ACT TO PROVIDE FOR THE PUBLICATION OF THE REPORTS AND PAPERS OF THE INDIANA ACADEMY OF SCIENCE.

[Approved March 11, 1895.]

WHEREAS, The Indiana Academy of Science, a chartered scientific association, has embodied in its constitution a provision that it will, upon the request of the Governor, or of the several departments of the State

government, through the Governor, and through its council as an advisory board, assist in the direction and execution of any investigation within its province, without pecuniary gain to the Academy, provided only that the necessary expenses of such investigation are borne by the State; and,

WHEREAS, The reports of the meetings of said Academy, with the several papers read before it, have very great educational, industrial and economic value, and should be preserved in permanent form; and

WHEREAS, The Constitution of the State makes it the duty of the General Assembly to encourage by all suitable means intellectual, scientific and agricultural improvement: therefore,

SECTION 1. *Be it enacted by the General Assembly of the State of Indiana,* That hereafter the annual reports of the meetings of the Indiana Academy of Science, beginning with the report for the year 1894, including all papers of scientific or economic value, presented at such meetings, after they shall have been edited and prepared for publication as hereinafter provided, shall be published by and under the direction of the Commissioners of Public Printing and Binding.

SEC. 2. Said reports shall be edited and prepared for publication without expense to the State, by a corps of editors to be selected and appointed by the Indiana Academy of Science, who shall not, by reason of such service, have any claim against the State for compensation. The form, style of binding, paper, typography and manner and extent of illustration of such reports shall be determined by the editors, subject to the approval of the Commissioners of Public Printing and Stationery. Not less than 1,500 nor more than 3,000 copies of each of said reports shall be published, the size of the edition within said limits to be determined by the concurrent action of the editors and the Commissioners of Public Printing and Stationery: *Provided,* That not to exceed six hundred dollars (\$600) shall be expended for such publication in any one year, and not to extend beyond 1896: *Provided,* That no sums shall be deemed to be appropriated for the year 1894.

SEC. 3. All except three hundred copies of each volume of said reports shall be placed in the custody of the State Librarian, who shall furnish one copy thereof to each public library in the State, one copy to each university, college or normal school in the State, one copy to each high school in the State having a library, which shall make application therefor, and one copy to such other institutions, societies or persons as may be designated by the

Academy through its editors or its council. The remaining three hundred copies shall be turned over to the Academy to be disposed of as it may determine. In order to provide for the preservation of the same it shall be the duty of the Custodian of the State House to provide and place at the disposal of the Academy one of the unoccupied rooms of the State House, to be designated as the office of the Academy of Science, wherein said copies of said reports belonging to the Academy, together with the original manuscripts, drawings, etc., thereof can be safely kept, and he shall also equip the same with the necessary shelving and furniture.

SEC. 4. An emergency is hereby declared to exist for the immediate taking effect of this act, and it shall therefore take effect and be in force from and after its passage.

APPROPRIATION FOR 1913-1914.

The appropriation for the publication of the proceedings of the Academy during the years 1913 and 1914 was increased by the Legislature in the General Appropriation bill, approved March 9, 1909. That portion of the law fixing the amount of the appropriation for the Academy is herewith given in full:

For the Academy of Science: For the printing of the proceedings of the Indiana Academy of Science twelve hundred dollars: *Provided*, That any unexpended balance in 1913 shall be available in 1914, and that any unexpended balance in 1914 shall be available in 1915.

AN ACT FOR THE PROTECTION OF BIRDS, THEIR NESTS AND EGGS.

SEC. 602. Whoever kills, traps or has in his possession any wild bird, or whoever sells or offers the same for sale, or whoever destroys the nest or eggs of any wild bird, shall be deemed guilty of a misdemeanor and upon conviction thereof shall be fined not less than ten dollars nor more than twenty-five dollars: *Provided*, That the provisions of this section shall not apply to the following named game birds: The Anatidæ, commonly called swans, geese, brant, river and sea duck; the Rallidæ, commonly called rails, coots, mud-hens, gallinules; the Limicolæ, commonly called shore birds, surf birds, plover, snipe, woodcock, sandpipers, tattlers and curlew; the Gallinæ, commonly called wild turkeys, grouse, prairie chickens, quails and pheasants; nor to English or European house sparrows.

crows, hawks or other birds of prey. Nor shall this section apply to persons taking birds, their nests or eggs, for scientific purposes, under permit, as provided in the next section.

SEC. 603. Permits may be granted by the Commissioner of Fisheries and Game to any properly accredited person, permitting the holder thereof to collect birds, their nests or eggs for strictly scientific purposes. In order to obtain such permit the applicant for the same must present to such Commissioner written testimonials from two well-known scientific men certifying to the good character and fitness of such applicant to be entrusted with such privilege, and pay to such Commissioner one dollar therefor and file with him a properly executed bond in the sum of two hundred dollars, payable to the State of Indiana, conditioned that he will obey the terms of such permit, and signed by at least two responsible citizens of the State as sureties. The bond may be forfeited, and the permit revoked upon proof to the satisfaction of such Commissioner that the holder of such permit has killed any bird or taken the nest or eggs of any bird for any other purpose than that named in this section.

PUBLIC OFFENSES--HUNTING WILD BIRDS--PENALTY.

[Approved March 13, 1913.]

SECTION 1. *Be it enacted by the General Assembly of the State of Indiana.* That section six (6) of the above entitled act be amended to read as follows: Section 6. That section six hundred two (602) of the above entitled act be amended to read as follows: Section 602. It shall be unlawful for any person to kill, trap or possess any wild bird, or to purchase or offer the same for sale, or to destroy the nest or eggs of any wild bird, except as otherwise provided in this section. But this section shall not apply to the following named game birds: The Anatidæ, commonly called swans, geese, brant, river and sea duck; the Rallidæ, commonly known as rails, coots, mud-hens and gallinules; the Limicolæ, commonly known as shore birds, plovers, surf birds, snipe, woodcock, sandpipers, fattlers and curlews; the Gallinæ, commonly called wild turkeys, grouse, prairie chickens, quails, and pheasants; nor to English or European house sparrows, blackbirds, crows, hawks or other birds of prey. Nor shall this section apply to any person taking birds or their nests or eggs for scientific purposes under permit as provided in the next section. Any person violating the provisions of this section shall, on conviction, be fined not less than ten dollars (\$10.00) nor more than fifty dollars (\$50.00).

Indiana Academy of Science.

OFFICERS, 1913-1914.

PRESIDENT,
SEVERANCE BURRAGE.

VICE-PRESIDENT,
A. L. FOLEY.

SECRETARY,
ANDREW J. BIGNEY.
ASSISTANT SECRETARY.

H. E. ENDERS.

PRESS SECRETARY,
FRANK B. WADE.

TREASURER,
W. A. COGSHALL.

EDITOR,
H. E. BARNARD.

EXECUTIVE COMMITTEE:

ARTHUR., J. C.,	DRYER, CHAS. R.,	MOTTIER, DAVID M.,
BIGNEY, A. J.,	EIGENMANN, C. H.,	MENDENHALL, T. C.,
BLATCHLEY, W. S.,	EVANS, P. N.,	NAYLOR, JOSEPH P.,
BODINE, DONALDSON,	DENNIS, D. W.,	NOYES, W. A.,
BRANNER, J. C.,	FOLEY, A. L.,	STUART, MILO H.,
BURRAGE, SEVERANCE,	HAY, O. P.,	WADE, F. B.,
BUTLER, AMOS W.,	HESSLER, ROBERT,	WALDO, C. A.,
COGSHALL, W. A.,	JOHN, J. P. D.,	WILEY, H. W.,
COULTER, JOHN M.,	JORDAN, D. S.,	WILLIAMSON, E. B.,
COULTER, STANLEY,	MEES, CARL L.,	WRIGHT, JOHN S.,
CULBERTSON, GLENN,	MOENKHAUS, W. J.,	

CURATORS:

BOTANY.....	J. C. ARTHUR.
ENTOMOLOGY.....	W. S. BLATCHLEY.
HERPETOLOGY }	A. W. BUTLER.
MAMMALOGY }	
ORNITHOLOGY }	
ICHTHYOLOGY.....	H. C. EIGENMANN.

COMMITTEES ACADEMY OF SCIENCE, 1914.

Program.

JOHN S. WRIGHT, Indianapolis
 CHAS. STOLTZ, South Bend
 W. M. BLANCHARD, Greencastle

Nominations.

DONALDSON BODINE, Crawfordsville
 J. W. BEEDE, Bloomington
 EDWIN MORRISON, Richmond

State Library.

W. S. BLATCHLEY, Indianapolis
 STANLEY COULTER, Lafayette
 AMOS W. BUTLER, Indianapolis

Biological Survey.

C. C. DEAM, Bluffton
 WILL SCOTT, Bloomington
 GEO. N. HOFFER, Lafayette
 U. O. COX, Terre Haute
 J. A. NIEUWLAND, Notre Dame

Distribution of Proceedings.

A. J. BIGNEY, Moores Hill
 AMOS W. BUTLER, Indianapolis
 P. N. EVANS, Lafayette
 D. M. MOTTER, Bloomington
 JOHN S. WRIGHT, Indianapolis

Membership.

F. M. ANDREWS, Bloomington
 A. M. KENYON, Lafayette
 FRED MILLER, Indianapolis

Auditing.

JOHN C. DEAN, Indianapolis
 L. J. RETTGER, Terre Haute

Restriction of Weeds and Diseases.

J. C. ARTHUR, Lafayette
 ROBERT HESSLER, Logansport
 J. N. HURTY, Indianapolis
 STANLEY COULTER, Lafayette
 D. M. MOTTER, Bloomington

Academy to State.

R. W. McBRIDE, Indianapolis
 GLENN CULBERTSON, Hanover
 H. E. BARNARD, Indianapolis
 AMOS W. BUTLER, Indianapolis
 W. W. WOOLEN, Indianapolis

Publication of Proceedings.

H. E. BARNARD, Editor, Indianapolis
 C. M. HILLIARD, Lafayette
 F. B. WADE, Indianapolis
 C. R. DRYER, Terre Haute
 M. K. HAGGERTY, Bloomington

OFFICERS OF THE INDIANA ACADEMY OF SCIENCE.

YEARS.	PRESIDENT.	SECRETARY.	ASST. SECRETARY.	PRESS SECRETARY.	TREASURER.
1885-1886	David S. Jordan.	Amos W. Butler			O. P. Jenkins.
1886-1887	John M. Coulter.	Amos W. Butler			O. P. Jenkins.
1887-1888	J. P. D. John.	Amos W. Butler			O. P. Jenkins.
1888-1889	John C. Branner.	Amos W. Butler			O. P. Jenkins.
1889-1890	T. C. Mendenhall.	Amos W. Butler			O. P. Jenkins.
1890-1891	O. P. Hay.	Amos W. Butler			C. A. Waldo.
1891-1892	J. L. Campbell.	Amos W. Butler			C. A. Waldo.
1892-1893	J. C. Arthur.	Amos W. Butler	{ Stanley Coulter.		C. A. Waldo.
1893-1894	W. A. Noyes.	C. A. Waldo.	W. W. Norman		W. P. Shannon.
1894-1895	A. W. Butler.	John S. Wright	A. J. Bigney		W. P. Shannon.
1895-1896	Stanley Coulter.	John S. Wright	A. J. Bigney		W. P. Shannon.
1896-1897	Thomas Gray.	John S. Wright	A. J. Bigney		W. P. Shannon.
1897-1898	C. A. Waldo.	John S. Wright	A. J. Bigney	Geo. W. Benton	J. T. Scovell.
1898-1899	C. H. Eigenmann.	John S. Wright	E. A. Schultze	Geo. W. Benton	J. T. Scovell.
1899-1900	D. W. Dennis.	John S. Wright	E. A. Schultze	Geo. W. Benton	J. T. Scovell.
1900-1901	M. B. Thomas.	John S. Wright	E. A. Schultze	Geo. W. Benton	J. T. Scovell.
1901-1902	Harvey W. Wiley.	John S. Wright	Donaldson Bodine	Geo. W. Benton	J. T. Scovell.
1902-1902	W. S. Blatchley.	John S. Wright	Donaldson Bodine	G. A. Abbott	W. A. McBeth.
1903-1904	C. L. Mees.	John S. Wright	J. H. Ransom	G. A. Abbott	W. A. McBeth.
1904-1905	John S. Wright.	Lynn B. McMullen	J. H. Ransom	G. A. Abbott	W. A. McBeth.
1905-1906	Robert Hessler.	Lynn B. McMullen	J. H. Ransom	Charles R. Clark	W. A. McBeth.
1906-1907	D. M. Mottier.	Lynn B. McMullen	J. H. Ransom	G. A. Abbott	W. A. McBeth.
1907-1908	Gleam Culbertson.	J. H. Ransom	A. J. Bigney	G. A. Abbott	W. A. McBeth.
1908-1909	A. L. Foley.	J. H. Ransom	A. J. Bigney	G. A. Abbott	W. A. McBeth.
1909-1910	P. N. Evans.	Geo. W. Benton	A. J. Bigney	John W. Woodhams	W. J. Moenkhaus.
1910-1911	C. R. Dryer.	A. J. Bigney	E. B. Williamson	Milo H. Stuart	W. J. Moenkhaus.
1911-1912	J. P. Naylor.	A. J. Bigney	E. B. Williamson	Milo H. Stuart	W. J. Moenkhaus.
1912-1913	Donaldson Bodine.	A. J. Bigney	C. M. Smith	F. B. Wade	W. J. Moenkhaus.
1913-1914	Severance Burrage.	A. J. Bigney	H. E. Endlers	F. B. Wade	W. A. Cogshall.

MEMBERS.*

FELLOWS.

- ††Abbott, G. A., Grand Forks, N. Dak. †1908
 Professor of Chemistry, University of North Dakota.
 Chemistry.
- Aley, Robert J., Orono, Me. 1898
 President of University of Maine.
 Mathematics and General Science.
- Anderson, H. W., 1 Mills Place, Crawfordsville, Ind. 1912
 Professor of Botany, Wabash College.
 Botany.
- Andrews, F. M., 744 E. Third St., Bloomington, Ind. 1911
 Assistant Professor of Botany, Indiana University.
 Botany.
- Arthur, Joseph C., 915 Columbia St., Lafayette, Ind. 1894
 Professor of Vegetable Physiology and Pathology, Purdue University.
 Botany.
- Barnard, H. E., Room 20, State House, Indianapolis, Ind. 1910
 Chemist to Indiana State Board of Health.
 Chemistry, Sanitary Science, Pure Foods.
- Beede, Joshua W., cor. Wall and Atwater Sts., Bloomington, Ind. 1906
 Associate Professor of Geology, Indiana University.
 Stratigraphic Geology, Physiography.
- Benton, George W., 100 Washington Square, New York, N. Y. 1896
 With the American Book Company.

*Every effort has been made to obtain the correct address and occupation of each member, and to learn what line of science he is interested in. The first line contains the name and address; the second line the occupation; the third line the branch of science in which he is interested. The omission of an address indicates that mail addressed to the last printed address was returned as uncalled for. Information as to the present address of members so indicated is requested by the secretary. The custom of dividing the list of members has been followed.

† Date of election.

†† Non-resident.

- Bigney, Andrew J., Moores Hill, Ind. 1897
 Vice-President and Professor of Biology and Geology, Moores Hill
 College.
 Biology and Geology.
- Bitting, Catharine Golden, Washington, D. C. 1895
 Microscopic Expert, Pure Food, National Canners Laboratory.
 Botany.
- Blatchley, W. S., 1558 Park Ave., Indianapolis, Ind. 1893
 Naturalist.
 Botany, Entomology and Geology.
- Bodine, Donaldson, Four Mills Place, Crawfordsville, Ind. 1899
 Professor of Geology and Zoology, Wabash College.
 Entomology and Geology.
- Breeze, Fred J., care American Book Company, New York, N. Y. 1910
 With the American Book Company.
 Geography.
- Bruner, Harry Lane, 324 S. Ritter Ave., Indianapolis, Ind. 1899
 Professor of Biology, Butler College.
 Comparative Anatomy, Zoology.
- Burrage, Severance, care Eli Lilly Co., Indianapolis, Ind. 1898
 Charge of Biological Laboratory, Eli Lilly Co.
 Bacteriology, Sanitary Science.
- Butler, Amos W., 52 Downey, Ave., Irvington, Ind. 1893
 Secretary, Indiana Board of State Charities.
 Vertebrate Zoology, Anthropology, Sociology.
- Cogshall, Wilbur A., 423 S. Fess Ave., Bloomington, Ind. 1906
 Associate Professor of Astronomy, Indiana University.
 Astronomy and Physics.
- Cook, Mel T., New Brunswick, N. J. 1902
 Professor of Plant Pathology, Rutgers College.
 Botany, Plant Pathology, Entomology.
- Coulter, John M., care University of Chicago, Chicago, Ill. 1893
 Head Department of Botany, Chicago University.
 Botany.
- Coulter, Stanley, 213 S. Ninth St., Lafayette, Ind. 1893
 Dean School of Science, Purdue University.
 Botany, Forestry.

- Cox, Ulysses O., P. O. Box 51, Terre Haute, Ind. 1908
 Head Department Zoology and Botany, Indiana State Normal.
 Botany, Zoology.
- Culbertson, Glenn, Hanover, Ind. 1899
 Chair Geology, Physics and Astronomy, Hanover College.
 Geology.
- Cumings, Edgar Roscoe, 327 E. Second St., Bloomington, Ind. 1906
 Professor of Geology, Indiana University.
 Geology, Paleontology.
- Davisson, Schuyler Colfax, Bloomington, Ind. 1908
 Professor of Mathematics, Indiana University.
 Mathematics.
- Deam, Charles C., Bluffton, Ind. 1910
 Druggist.
 Botany.
- Dennis, David Worth, Richmond, Ind. 1895
 Professor of Biology, Earlham College.
 Biology.
- Dryer, Charles R., 35 Gilbert Ave., Terre Haute, Ind. 1897
 Professor of Geography and Geology, Indiana State Normal.
 Geography, Geology.
- Eigenmann, Carl H., 630 Atwater St., Bloomington, Ind. 1893
 Professor Zoology, Dean of Graduate School, Indiana University.
 Embryology, Degeneration, Heredity, Evolution and Distribution of
 American Fish.
- Enders, Howard Edwin, 105 Quincy St., Lafayette, Ind. 1912
 Associate Professor of Zoology, Purdue University.
 Zoology.
- Evans, Percy Norton, Lafayette, Ind. 1905
 Director of Chemical Laboratory, Purdue University.
 Chemistry.
- Foley, Arthur L., Bloomington, Ind. 1897
 Head Department of Physics, Indiana University.
 Physics.
- Golden, M. J., Lafayette, Ind. 1899
 Director of Laboratories of Practical Mechanics, Purdue Uni-
 versity.
 Mechanics.

- ††Goss, William Freeman M., Urbana, Ill. 1893
Dean of College of Engineering, University of Illinois.
- Haggerty, M. E., Bloomington, Ind. 1913
- Hathaway, Arthur S., 2206 N. Tenth St, Terre Haute, Ind. 1895
Professor of Mathematics, Rose Polytechnic Institute.
Mathematics, Physics.
- Hessler, Robert, Logansport, Ind. 1899
Physician.
Biology.
- Hilliard, C. M., Lafayette, Ind. 1913
- Hoffer, Geo. N., West Lafayette, Ind. 1913
- Hurty, J. N., Indianapolis, Ind. 1910
Secretary, Indiana State Board of Health.
Sanitary Science, Vital Statistics, Eugenics.
- †Huston, H. A., New York City 1893
- Kern, Frank D., State College, Pa. 1912
Professor of Botany, Pennsylvania State College.
Botany.
- Lyons, Robert E., 630 E. Third St., Bloomington, Ind. 1896
Head of Department of Chemistry, Indiana University.
Organic and Biological Chemistry.
- McBeth, William A., 1905 N. Eighth St., Terre Haute, Ind. 1904
Assistant Professor Geography, Indiana State Normal.
Geography, Geology, Scientific Agriculture.
- †Marsters, V. F., Santiago, Chile 1893
- Mees, C. L., Terre Haute, Ind. 1894
President of Rose Polytechnic Institute.
- †Miller, John Anthony, Swarthmore, Pa. 1904
Professor of Mathematics and Astronomy, Swarthmore College.
Astronomy, Mathematics.
- Moenkhaus, William J., 501 Fess Ave., Bloomington, Ind. 1901
Professor of Physiology, Indiana University.
Physiology.
- Moore, Richard B., Denver, Colo. 1893
With U. S. Bureau of Mines.
Chemistry, Radio-activity.

- Mottier, David M., 215 Forest Place, Bloomington, Ind. 1893
 Professor of Botany, Indiana University.
 Morphology. Cytology.
- Naylor, J. P., Greencastle, Ind. 1903
 Professor of Physics, Depauw University.
 Physics, Mathematics.
- †Noyes, William Albert, Urbana, Ill. 1893
 Director of Chemical Laboratory, University of Illinois.
 Chemistry.
- Pohlman, Augustus G., 1100 E. Second St., Bloomington, Ind. 1911
 Professor of Anatomy, Indiana University.
 Embryology, Comparative Anatomy.
- Ramsey, Rolla R., 615 E. Third St., Bloomington, Ind. 1906
 Associate Professor of Physics, Indiana University.
 Physics.
- Ransom, James H., 323 University St., West Lafayette, Ind. 1902
 Professor of General Chemistry, Purdue University.
 General Chemistry, Organic Chemistry, Teaching.
- Rettger, Louis J., 31 Gilbert Ave., Terre Haute, Ind. 1896
 Professor of Physiology, Indiana State Normal.
 Animal Physiology.
- Rothrock, David A., Bloomington, Ind. 1906
 Professor of Mathematics, Indiana University.
 Mathematics.
- Scott, Will, 731 Atwater St., Bloomington, Ind. 1911
 Assistant Professor of Zoology, Indiana University.
 Zoology, Lake Problems.
- Shannon, Charles W., Norman, Okla. 1912
 With Oklahoma State Geological Survey.
 Soil Survey, Botany.
- Smith, Albert, 1022 Seventh St., West Lafayette. 1908
 Professor of Structural Engineering.
 Physics, Mechanics.
- ††Smith, Alexander, care Columbia University, New York, N. Y. 1893
 Head of Department of Chemistry, Columbia University.
 Chemistry.

- Smith, Charles Marquis, 919 S. Ninth St., Lafayette, Ind. 1912
 Professor of Physics, Purdue University.
 Physics.
- Stone Winthrop E., Lafayette, Ind. 1893
 President of Purdue University.
 Chemistry.
- ††Swain, Joseph, Swarthmore, Pa. 1898
 President of Swarthmore College.
 Science of Administration.
- Van Hook, James M., 639 N. College Ave., Bloomington, Ind. 1911
 Assistant Professor of Botany, Indiana University.
 Botany.
- ††Waldo, Clarence A., care Washington University, St. Louis, Mo. . . . 1893
 Thayer Professor Mathematics and Applied Mechanics, Wash-
 ington University.
 Mathematics, Mechanics, Geology and Mineralogy.
- ††Webster, F. M., Kensington, Md. 1894
 Entomologist, U. S. Department of Agriculture, Washington, D. C.
 Entomology.
- Westlund, Jacob, 439 Salisbury St., West Lafayette, Ind. 1904
 Professor of Mathematics, Purdue University.
 Mathematics.
- Wiley, Harvey W., Cosmos Club, Washington, D. C. 1895
 Professor of Agricultural Chemistry, George Washington Uni-
 versity.
 Biological and Agricultural Chemistry.
- Woollen, William Watson, Indianapolis, Ind. 1908
 Lawyer.
 Birds and Nature Study.
- Wright, John S., care Eli Lilly Co., Indianapolis, Ind. 1894
 Manager of Advertising Department, Eli Lilly Co.
 Botany.

NON-RESIDENT MEMBERS.

Ashley, George H., Washington, D. C.

Branner, John Casper, Stanford University, California.

Vice-President of Stanford University, and Professor of Geology.
Geology.

Brannon, Melvin A., 207 Chestnut St., Grand Forks, N. D.

Professor of Botany.
Plant Breeding.

Campbell, D. H., Stanford University, California.

Professor of Botany, Stanford University.
Botany.

Clark, Howard Walton, U. S. Biological Station, Fairport, Iowa.

Scientific Assistant, U. S. Bureau of Fisheries.
Botany, Zoology.

Dorner, H. B., Urbana, Illinois.

Assistant Professor of Floriculture.
Botany, Floriculture.

Duff, A. Wilmer, 43 Harvard St., Worcester, Mass.

Professor of Physics, Worcester Polytechnic Institute.
Physics.

Evermann, Barton Warren, Bureau of Fisheries, Washington, D. C.

Chief, Alaska Fisheries Service
Zoology.

Fiske, W. A.

Garrett, Chas. W., Room 718, Pennsylvania Station, Pittsburgh, Pa.

Librarian, Pennsylvania Lines West of Pittsburgh.
Entomology, Sanitary Sciences.

Gilbert, Charles H., Stanford University, California.

Professor of Zoology, Stanford University.
Ichthyology.

Greene, Charles Wilson, 814 Virginia Ave., Columbia, Mo.

Professor of Physiology and Pharmacology, University of Missouri.
Physiology, Zoology.

Hargitt, Chas. W., 909 Walnut Ave., Syracuse, N. Y.

Professor of Zoology, Syracuse University.
Hygiene, Embryology, Eugenics, Animal Behavior.

- Hay, Oliver Perry, U. S. National Museum, Washington, D. C.
 Research Associate, Carnegie Institution of Washington.
 Vertebrate Paleontology, especially that of the Pleistocene Epoch.
- Hughes, Edward, Stockton, California.
- Jenkins, Oliver P., Stanford University, California.
 Professor of Physiology, Stanford University.
 Physiology, Histology.
- Jordan, David Starr, Stanford University, California.
 President of Stanford University.
 Fish, Eugenics, Botany, Evolution.
- Kingsley, J. S., Tufts College, Massachusetts.
 Professor of Zoology, Tufts College.
 Zoology.
- Knipp, Charles T., 913 W. Nevada St., Urbana, Illinois.
 Assistant Professor of Physics, University of Illinois.
 Physics, Discharge of Electricity thru Gases.
- MacDougal, Daniel Trembly, Tucson, Arizona.
 Director, Department of Botanical Research, Carnegie Institute, Wash-
 ington, D. C.
 Botany.
- McMullen, Lynn Banks, State Normal School, Valley City, North Dakota.
 Head Science Department, State Normal School.
 Physics, Chemistry.
- Mendenhall, Thomas Corwin, Ravenna, Ohio.
 Retired.
 Physics, "Engineering," Mathematics, Astronomy.
- Newsom, J. F., Palo Alto, California.
 Mining Engineer.
- Purdue, Albert Homer, State Geological Survey, Nashville, Tenn.
 State Geologist of Tennessee.
 Geology.
- Reagan, A. B., Nett Lake School, Nett Lake, Minnesota.
 Superintendent and Special Distribution Agent, Indian Service.
 Geology, Paleontology, Ethnology.

Slonaker, James Rollin, 334 Kingsley Ave., Palo Alto, California.
 Assistant Professor of Physiology, Stanford University.
 Physiology, Zoology.

Springer, Alfred, 312 East 2d St., Cincinnati, Ohio.
 Chemist.
 Chemistry.

— —

ACTIVE MEMBERS.

Allen, William Ray, Bloomington, Ind.

Allison, Evelyn, Lafayette, Ind.
 Care Agricultural Experiment Station.
 Botany.

Baine, H. Foster, 420 Market St., San Francisco, Cal.
 Editor, Mining and Scientific Press.

Baker, Walter D., N. Illinois St. Indianapolis, Ind.
 Care Walcraft Co.
 Chemistry.

Baker, Walter M., Amboy.
 Superintendent of Schcols.
 Mathematics and Physics.

Banker, Howard J., 306 Hanna St., Greencastle.
 Professor of Biology, DePauw University.
 Botany.

Barcus, H. H., Indianapolis.
 Instructor, Mathematics, Shortridge High School.

Barr, Harry L., Waveland.
 Student.
 Botany and Forestry.

Barrett, Edward, Indianapolis.
 State Geologist.
 Geology, Soil Survey.

Bates, W. H., 306 Russell St., West Lafayette
 Associate Professor, Mathematics.

- Bell, Guido, 431 E. Ohio St., Indianapolis.
Physician.
- Bellamy, Ray, Worcester, Mass.
- Bennett, Lee F., 825 Laporte Ave., Valparaiso.
Professor of Geology and Zoology, Valparaiso University.
Geology, Zoology.
- Bishop, Harry Eldridge, 1706 College Ave., Indianapolis.
Food Chemist, Indiana State Board of Health.
- Blanchard, William M., 1008 S. College Ave., Greencastle.
Professor of Chemistry, DePauw University.
Organic Chemistry.
- Bond, Charles S., 112 N. Tenth St. Richmond.
Physician.
Biology, Bacteriology, Physical Diagnosis and Photomicrography.
- Bourke, A. Adolphus, 1103 Cottage Ave., Columbus.
Instructor, Physics, Zoology and Geography.
Botany, Physics.
- Brossmann, Charles, 1616 Merchants Bank Bldg., Indianapolis.
Consulting Engineer.
Water Supply, Sewage Disposal, Sanitary Engineering, etc.
- Brown, James, 5372 E. Washington St., Indianapolis.
Professor of Chemistry, Butler College.
Chemistry.
- Brown, Hugh E., Bloomington, Ind.
- Bruce, Edwin M., 2401 North Ninth St., Terre Haute.
Assistant Professor of Physics and Chemistry, Indiana State Normal.
Chemistry, Physics.
- Bryan, William Lowe, Bloomington.
President, Indiana University.
Psychology.
- Bybee, Halbert P., Bloomington.
Graduate Student, Indiana University.
Geology.
- Canis, Edward N., 2221 Park Ave., Indianapolis.
Officeman with William B. Burford.
Botany, Psychology.

Carmichael, R. D., Bloomington.

Assistant Professor of Mathematics, Indiana University.
Mathematics.

Caswell, Albert E., Lafayette.

Instructor in Physics, Purdue University.
Physics and Applied Mathematics.

Chansler, Elias J., Bicknell.

Farmer.
Ornithology and Mammals.

Clarke, Elton Russell, Indianapolis.

Clark, Jediah H., 126 East Fourth St., Connersville.

Physician.
Medicine.

Conner, S. D., West Lafayette.

Cox, William Clifford.

Crowell, Melvin E., 648 E. Monroe St., Franklin.

Dean of Franklin College.
Chemistry and Physics.

Cutter, George, Broad Branch Road, Washington, D. C.

Retired Manufacturer of Electrical Supplies.
Conchology.

Daniels, Lorenzo E., Rolling Prairie.

Retired Farmer.
Conchology.

Davis, Melvin K., Anderson.

Instructor, Anderson High School.
Physiography, Geology, Climatology.

Deppe, C. R., Franklin.

Dietz, Harry F., 408 W. Twenty-eighth St., Indianapolis.

Deputy State Entomologist.
Entomology, Eugenics, Parasitology, Plant Pathology.

Dolan, Jos. P., Syracuse.

Drew, David Abbott, 817 East Second St., Bloomington.

Instructor in Mechanics and Astronomy.
Astronomy, Mechanics, Mathematics and Applied Mathematics.

- DuBois, Henry, Bloomington, Ind.
- Duden, Hans A., 5050 E. Washington St., Indianapolis.
Analytical Chemist.
Chemistry.
- Dutcher, J. B., Bloomington.
Assistant Professor of Physics, Indiana University.
Physics.
- Farp, Samuel E., 24½ Kentucky Ave., Indianapolis.
Physician.
- Easley, Mary, Bloomington, Ind.
- Edmonston, Clarence E., Bloomington.
Graduate Student, Physiology, Indiana University.
Physiology.
- Ellis, Max Mapes, Boulder, Colo.
Instructor in Biology, University of Colorado.
Biology, Entomology.
- Evans, Samuel G., 1452 Upper Second St., Evansville.
Merchant.
Botany, Ornithology.
- Ewers, James E., Terre Haute.
Instructor in High School.
Geology.
- Felver, William P., 325½ Market St., Logansport.
Railroad Clerk.
Geology, Chemistry.
- Fisher, Martin L., Lafayette.
Professor of Crop Production, Purdue University.
Agriculture, Soils and Crops, Birds, Botany.
- Frier, George M., Lafayette.
Assistant Superintendent, Agricultural Experiment Station, Purdue
University.
Botany, Zoology, Entomology, Ornithology, Geology.
- Fuller, Frederick D., 213 Russell St., West Lafayette.
Chief Deputy State Chemist, Purdue Experiment Station.
Chemistry, Microscopy.

- Funk, Austin, 404 Spring St., Jeffersonville.
 Physician.
 Diseases of Eye, Ear, Nose and Throat.
- Galloway, Jesse James, Bloomington.
 Instruction, Indiana University.
 Geology. Paleontology.
- Gates, Florence A., 416 Irving St., Toledo, Ohio.
 Teacher of Botany.
 Botany and Zoology.
- Gillum, Robert G., Terre Haute, Ind.
- Glenn, E. R., 535 North Walnut St., Bloomington.
 Instructor in Physics, Bloomington High School.
 Physics.
- Gottlieb, Frederic W., Morristown.
 Care Museum of Natural History. Assistant Curator, Moores Hill
 College.
 Archaeology, Ethnology.
- Grantham, Guy E., 437 Vine St., West Lafayette.
 Instructor in Physics, Purdue University.
- Greene, Frank C., Missouri Bureau of Geology and Mines, Rolla, Mo.
 Geologist.
 Geology.
- Grimes, Earl J., Russellville.
 Care U. S. Soil Survey
 Botany, Soil Survey.
- Harding, C. Francis, 111 Fowler Ave., West Lafayette.
 Professor of Electrical Engineering, Purdue University.
 Mathematics, Physics, Chemistry.
- Harman, Mary T., 611 Laramie St., Manhattan, Kansas.
 Instructor in Zoology, Kansas State Agricultural College.
 Zoology.
- Harvey, R. B., Indianapolis.
- Heimbürger, Harry V., 701 West Washington St., Urbana, Ill.
 Assistant in Zoology, University of Illinois.

- Hendricks, Victor K., 855 Benton Ave., Springfield, Mo.
 Assistant Chief Engineer, St. L. & S. F. R. R.
 Civil Engineering and Wood Preservation.
- Hennel, Cora, Bloomington, Ind.
- Hennel, Edith A., Bloomington, Ind.
- Hetherington, John P., 418 Fourth St., Logansport.
 Physician.
 Medicine, Surgery, X-Ray, Electro-Therapeutics.
- Hinman, J. J., Jr., University of Iowa, Iowa City, Ia.
 Chemist, Dept. Public Health and Hygiene.
 Chemistry.
- Hole, Allen D., Richmond.
 Instructor, Earlham College.
- Hubbard, Lucius M., South Bend.
 Lawyer.
- Hufford, Mason E., Bloomington, Ind.
- Hutton, Joseph Gladden, Prockings, South Dakota.
 Associate Professor of Agronomy, State College.
 Agronomy, Geology.
- Hyde, Roscoe Raymond, Terre Haute.
 Assistant Professor, Physiology and Zoology, Indiana State Normal.
 Zoology, Physiology, Bacteriology.
- Ibison, Harry M., Marion.
 Instructor in Science, Marion High School.
- Jackson, D. E., St. Louis, Mo.
 Assistant Professor, Pharmacology, Washington University.
- Johnson, A. G., Madison, Wisconsin.
- Jones, Wm. J., Jr., Lafayette.
 State Chemist. Professor of Agriculture and Chemistry, Purdue University.
 Chemistry, and general subjects relating to agriculture.
- Kenyon, Alfred Monroe, 315 University St., West Lafayette.
 Professor of Mathematics, Purdue University.
 Mathematics.

- von KleinSmid, R. B., Tucson, Ariz.,
President University of Ariz.
- Liebers, Paul J., 1104 Southeastern Ave., Indianapolis.
- Ludwig, C. A., 210 Waldron St., West Lafayette, Ind.
Assistant in Botany, Purdue University.
Botany, Agriculture.
- Ludy, L. V., 229 University St., Lafayette.
Professor, Experimental Engineering, Purdue University.
Experimental Engineering in Steam and Gas.
- Mason, T. E., Bloomington.
Graduate Student, Mathematics, Indiana University.
Mathematics.
- McBride, Robert W., 1239 State Life Building, Indianapolis.
Lawyer.
- McEwan, Mrs. Eula Davis, Bloomington, Ind.
- McClellan, John H., Gary, Ind.
- McCulloch, T. S., Charlestown.
- Mance, Grover C., Bloomington, Ind.
- Markle, M. S., Richmond.
- Middletown, A. R., West Lafayette.
Professor of Chemistry, Purdue University.
Chemistry.
- Miller, Fred A., 534 E. Twenty-ninth St., Indianapolis.
Botanist for Eli Lilly Co.
Botany, Plant Breeding.
- Montgomery, Hugh T., South Bend.
Physician.
Geology.
- Moore, George T., St. Louis, Mo.
Director, Missouri Botanical Garden.
Botany.
- Morrison, Edwin, 80 S. W. Seventh St., Richmond.
Professor of Physics, Earlham College.
Physics and Chemistry.

- Morrison, Harold, Indianapolis, Ind.
- Mowrer, Frank Karlsten, Interlaken, New York.
Cooperative work with Cornell University.
Biology, Plant Breeding.
- Muncie, F. W.
- Myers, B. D., 321 N. Washington St., Bloomington.
Professor of Anatomy, Indiana University.
- Nieuwland, J. A., The University, Notre Dame, Ind.
Professor, Botany, Editor *Midland Naturalist*.
Systematic Botany, Plant Histology, Organic Chemistry.
- North, Cecil C., Greencastle.
- Northnagel, Mildred, Gary, Ind.
- O'Neal, Claude E., Bloomington.
Graduate Student, Botany, Indiana University.
Botany.
- Orton, Clayton R., State College, Pennsylvania.
Assistant Professor of Botany, Pennsylvania State College.
Phytopathology, Botany, Mycology, Bacteriology.
- Osner, G. A., Ithaca, New York.
Care Agricultural College.
- Owen, D. A., 200 South State St., Franklin.
Professor of Biology. (Retired.)
Biology.
- Owens, Charles E., Corvallis, Oregon.
Instructor in Botany, Oregon Agricultural College.
Botany.
- Payne, Dr. F., Bloomington, Ind.
- Petry, Edward Jacob, 267 Wood St., West Lafayette.
Instructor in Agriculture.
Botany, Plant Breeding, Plant Pathology, Bio-Chemistry.
- Phillips, Cyrus G., Moores Hill.
- Pickett, Fernan L., Bloomington.
Botany Critic, Indiana University Training School.
Botany, Forestry, Agriculture.

- Pipal, F. J., 11 S. Salisbury St., West Lafayette.
- Price, James A., Fort Wayne.
- Ramsey, Earl E., Bloomington.
Principal High School.
- Shriver, Dr. Will, Indianapolis, Ind.
Director, State Laboratory of Hygiene.
- Shockel, Barnard, Professor, Terre Haute, Ind.
- Schultze, E. A., Laurel.
Fruit Grower.
Bacteriology, Fungi.
- Silvey, Oscar W., 437 Vine St., West Lafayette.
Instructor in Physics.
Physics.
- Smith, Chas. Piper, College Park Md.
Associate Professor, Botany, Maryland Agricultural College.
Botany.
- Smith, Essie Alma, R. F. D. 6, Bloomington.
- Smith, E. R., Indianapolis.
Horticulturist.
- Snodgrass, Robert, Crawfordsville, Ind.
- Spitzer, George, Lafayette.
Dairy Chemist, Purdue University.
Chemistry.
- Steele, B. L., Pullman, Washington.
Associate Professor of Physics, State College, Washington.
- Steinley, Leonard, Bloomington, Ind.
- Stoltz, Charles, 530 N. Lafayette St., South Bend.
Physician.
- Stoddard, J. M.
- Stuart, M. H., 3223 N. New Jersey St., Indianapolis.
Principal, Manual Training High School.
Physical and Biological Science.

- Sturmer, J. W., 119 E. Madison Ave., Collingswood, N. J.
Dean, Department of Pharmacy, Medico-Chirurgical College of Philadelphia.
Chemistry, Botany.
- Taylor, Joseph C., Logansport.
Wholesale merchant.
- Thompson, Albert W., Owensville.
Merchant.
Geology.
- Thompson, Clem O., Salem.
Principal High School.
- Thornburn, A. D., Indianapolis.
Care Pitman-Moore Co.
Chemistry.
- Trueblood, Iro C. (Miss), 205 Spring Ave., Greencastle.
Teacher of Botany, Zoology, High School.
Botany, Zoology, Physiography, Agriculture.
- Tucker, W. M., 841 Third St., Chico, California.
Principal High School.
Geology.
- Turner, William P., Lafayette.
Professor of Practical Mechanics, Purdue University.
- Vallance, Chas. A., Indianapolis.
Instructor, Manual Training High School.
Chemistry.
- Voorhees, Herbert S., 2814 Hoagland Ave., Fort Wayne.
Instructor in Chemistry and Botany, Fort Wayne High School.
Chemistry and Botany.
- Wade, Frank Bertram, 1039 W. Twenty-seventh St., Indianapolis.
Head of Chemistry Department, Shortridge High School.
Chemistry, Physics, Geology and Mineralogy.
- Walters, Arthur L., Indianapolis.
- Warren, Don Cameron, Bloomington, Ind.
- Waterman, Luther D., Indianapolis.
Physician.

- Webster, L. B., Terre Haute, Ind.
- Weatherwax, Paul, Bloomington, Ind.
- Weems, M. L., 102 Garfield Ave., Valparaiso.
Professor of Botany.
Botany and Human Physiology.
- Weir, Daniel T., Indianapolis.
Supervising Principal, care School office.
School Work.
- Weyant, James E., Indianapolis.
Teacher of Physics, Shortridge High School.
Physics.
- Wheeler, Virges, Montmorenci.
- Wiancko, Alfred T., Lafayette.
Chief in Soils and Crops, Purdue University.
Agronomy.
- Williams, Kenneth P., Bloomington.
Instructor in Mathematics, Indiana University.
Mathematics, Astronomy.
- Williamson, E. B., Bluffton.
Cashier, The Wells County Bank.
Dragonflies.
- Wilson, Charles E., Bloomington.
Graduate Student, Zoology, Indiana University.
Zoology.
- Wood, Harry W., 84 North Ritter Ave., Indianapolis.
Teacher, Manual Training High School.
- Woodburn, Wm. L., 902 Ashbury Ave., Evanston, Ill.
Instructor in Botany, Northwestern University.
Botany and Bacteriology.
- Woodhams, John H., care Houghton Mifflin Co., Chicago, Ill.
Traveling Salesman.
Mathematics.
- Wootery, Ruth, Bloomington, Ind.
- Yocum, H. B., Crawfordsville.

Young, Gilbert A., 725 Highland Ave., Lafayette.

Head of Department of Mechanical Engineering, Purdue University.

Zehring, William Arthur, 303 Russell St., West Lafayette.

Assistant Professor of Mathematics, Purdue University.

Mathematics.

Zeleny, Charles, University of Illinois, Urbana, Ill.

Associate Professor of Zoology.

Zoology.

Zufall, C. J., Indianapolis, Ind.

Fellows	70
Members, Active	162
Members, Non-resident	27
	—
Total	259

INDIANA ACADEMY OF SCIENCE

IN JOINT SESSION WITH THE

INDIANA CONSERVATION ASSOCIATION

WHEREAS, We have learned of the death of Mrs. Fairbanks, the wife of Hon. Charles W. Fairbanks, who was to have participated in this meeting, and the value of whose service in the cause of Conservation is well known: Therefore be it

Resolved, That we hereby express our sympathy with him and his family in this time of bereavement, and our regret at his unavoidable absence from our meetings, and direct that a copy of this resolution be sent to him, and that it be spread upon the minutes of the respective organizations.

A. W. BUTLER,

For the Indiana Academy of Science.

SEVERANCE BURRAGE,

For the Indiana Conservation Association.

MINUTES OF SPRING MEETING.

CRAWFORDSVILLE, INDIANA.

MAY 15, 16 AND 17, 1913.

The 1913 spring meeting of the Academy was held at Crawfordsville and the Shades May 15 to 17.

The scientific program consisted of a lecture Thursday, May 15, 8 p. m., by Professor G. Frederick Wright, of Oberlin, on "Thirty Years' Progress in Glacial Geology." The lecture was an attractive and instructive presentation of an interesting subject and was much enjoyed by those present.

Friday, May 1, was taken up with an excursion to the Shades of Death. This was of especial interest to geologists, botanists, and zoologists, but the natural grandeur of the place and the outing were appreciated by all. At noon the local committee served lunch at the Shades Hotel without cost to the members. Following the lunch a short business session was held, about forty members being present. The following were elected to membership: Charles H. Baldwin, Indianapolis; Francis Daniels and H. E. Ashby, Crawfordsville, and E. L. Marerum, Waveland. There was some discussion of the matter of the Donaldson Farm, which was to have been left to the State as a park but which has been in uncertain control on account of legal complications. It was moved that "It is the sense of this Academy that the Donaldson Farm should become the property of Indiana University, that the Academy use its influence to that end, and that the President of the Academy and Dr. C. H. Eigenmann constitute a committee to prepare a suitable memorial to present to the proper authorities." This was carried unanimously. It was moved that the thanks of the Academy be extended to Professor Wright for his lecture. Carried by a rising vote. President Bodine presided.

Friday evening after returning to Crawfordsville a very enjoyable dinner was served at the Crawford House, at 8:30, by the Academy without cost to the members. The dinner was followed by informal talks, Mr.

Amos Butler acting as toastmaster and responses being made by Messrs. Cogshall, Bodine, Macbeth, Kern, Culbertson, Barrett, Enders, J. S. Wright, Stoltz, Morrison and Eigenmann. Various items of interest relating to the trip to the Shades were brought out by the speakers.

Saturday morning, May 17, was taken up by field trips along Rock River (Sugar Creek) to the crinoid beds and other places of interest. Many members also took advantage of the opportunity to visit the Gen. Lew Wallace place.

FRANK D. KERN,

Secretary, *pro tem.*

MINUTES OF THE TWENTY-NINTH ANNUAL MEETING
INDIANA ACADEMY OF SCIENCE,

CLAYPOOL HOTEL, INDIANAPOLIS, INDIANA.

OCTOBER 24, 1913.

The Executive Committee of the Indiana Academy of Science met in Parlor T and was called to order by the President, Donaldson Bodine of Crawfordsville. The following members were present: Donaldson Bodine, A. W. Butler, Severance Burrage, W. A. Cogshall, W. S. Blatchley, J. W. Beede, D. M. Mottier, G. Culbertson, C. R. Dryer, C. C. Deam, R. W. McBride, C. H. Eigenmann and A. J. Bigney.

The minutes of the Executive Committee of 1912 were read and approved.

The reports of the standing committees were then taken up. The program committee, J. W. Beede, chairman, reported the work completed as indicated by the printed program, with several additional papers.

The Treasurer, W. J. Moenkhaus, having gone abroad, left his work in charge of A. G. Pohlman, but he, not being able to be present, delegated his power to W. A. Cogshall, who reported as follows:

Balance from 1912	\$273.38
Dues	148.00

Total	\$421.38
Expenditures	166.60

Balance.....	\$254.78

On motion W. A. Cogshall was appointed Treasurer *pro tem*.

The following auditing committee was appointed: Severance Burrage, C. R. Dryer, J. W. Beede.

The Editor, C. C. Deam, reported that the work had been completed and the copy was in the hands of the printer.

The nominating committee was appointed as follows: **A. W. Butler**, **W. A. Cogshall**, **G. Culbertson**.

The President stated he had received a letter from an Austrian scientist applying for a certain correspondence position in the Academy. Since such a position does not exist in our Academy the Secretary was directed to reply to that effect.

A letter was read from **Dr. Stultz**, of South Bend, inviting the Academy to hold its spring meeting in that city. It was referred to the program committee.

President **Bodine** suggested that the standing committees be appointed by the incoming president. After some discussion a motion was made and carried that the incoming president appoint his committees except those necessary for carrying on the business of the Academy, such as auditing, nominating, etc.

Judge McBride, of the committee on relations of Academy to the State, reported that they had succeeded in keeping the appropriation at \$1,200.

On motion **Mr. Butler** was appointed to act with a committee from the Conservation Association to draft suitable resolutions on the death of **Mrs. Fairbanks**, a copy to be sent to **Hon. C. W. Fairbanks** and a copy spread on the minutes.

On motion the Secretary was ordered to purchase a new secretary book and to have the old one bound.

On motion the Secretary and **A. W. Butler** were appointed to ask the State Librarian for permission to deposit the records of the Academy in his safe for security.

Adjournment.

A. J. BIGNEY, Secretary.

DONALDSON BODINE, President.

— — — — —
PALM ROOM, CLAYPOOL HOTEL.

October 24, 1913.

The Indiana Academy of Science met in general session at 1:30 p. m. and was called to order by the President, **Donaldson Bodine**.

Business items were first taken up. **J. W. Beede**, of the Program Committee, reported work completed as printed.

Severance Burrage of the Auditing Committee reported the books of the Treasurer correct.

and

ollow-

polis;

polis;

; Dr.

Bloom-

Arthur

Bois,

ington;

aster,

rwax,

fance,

illum,

ington.

ESSRS.

ta on

: had

had

and

vork.

pub-

ident

INDIANA STATE NORMAL SCHOOL
 DEPARTMENT of GEOGRAPHY and GEOLOGY
TOPOGRAPHIC MAP of TERRE HAUTE AREA

CHAS R DRYER
 MELVIN R DAVIS
 GARL H BARKER
 and WILLIAM H
 SURVEYED 1871-1873
 WEST
 MARYS

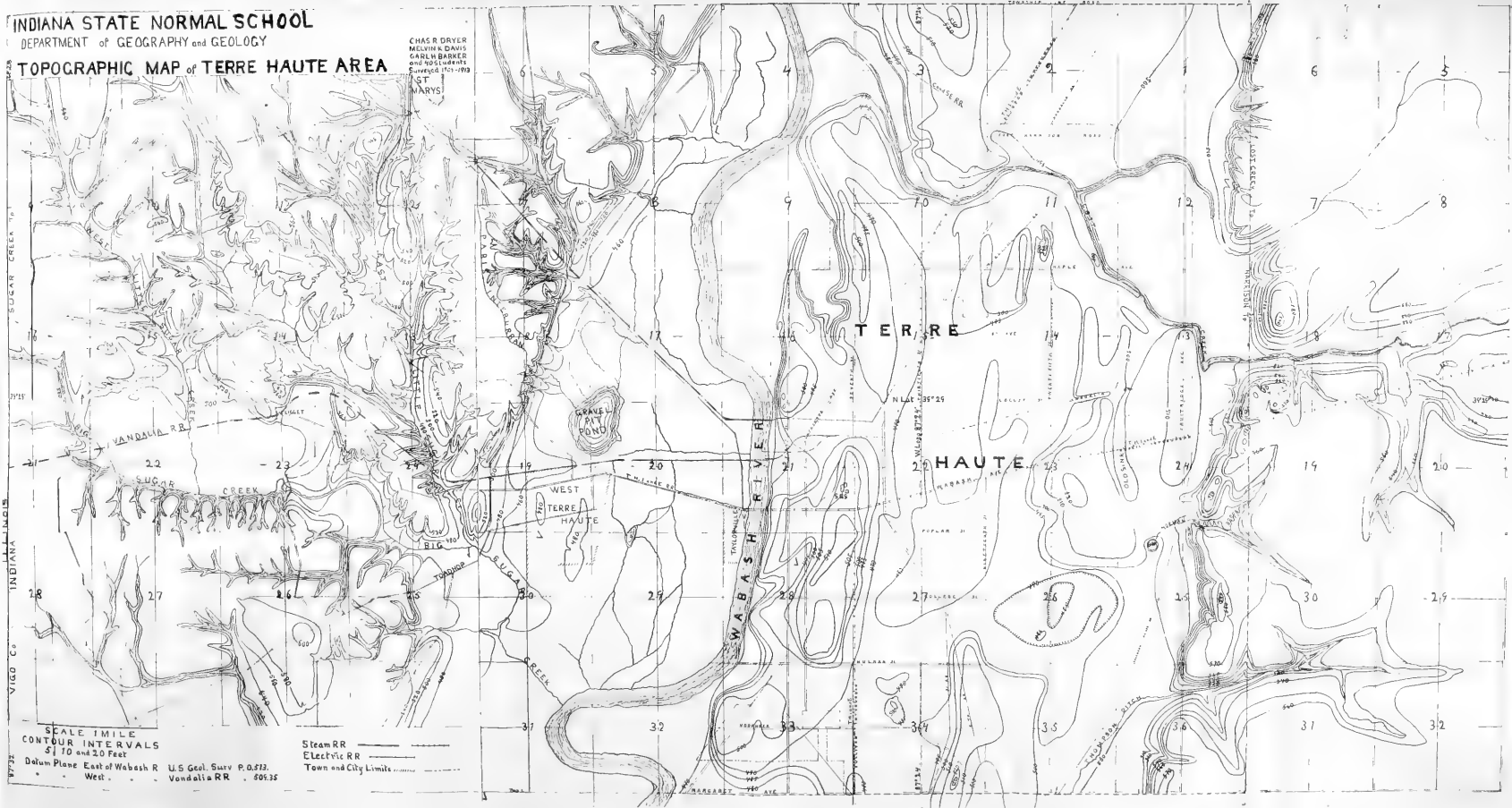

SCALE 1 MILE
 CONTOUR INTERVALS
 5' 10 and 20 Feet

Datum Plane East of Wabash R U.S. Geol. Surv. P.O. 573.
 West Vandalia R.R. 50635

Steam RR —————
 Electric RR ————
 Town and City Limits ————

The Editor, C. C. Deam, made a complete report of his work, and stated that the copy was in the hands of the state printer.

E. R. Cumings, of the Membership Committee, reported the following names for membership: Dr. Will Shimer, State House, Indianapolis; Elton Russell Clarke, Indianapolis; Harold Morrison, Indianapolis; Robert Snodgrass, Crawfordsville; Leonard Steimley, Bloomington; Dr. F. Payne, Bloomington; Ruth Wootery, Bloomington; Cora Hennel, Bloomington; Edith A. Hennel, Bloomington; C. J. Zufall, Indianapolis; Arthur L. Walters, Indianapolis; Mason E. Hufford, Bloomington; Henry DuBois, Bloomington; Hugh E. Brown, Bloomington; Mary Easley, Bloomington; John H. McClellan, Gary; R. B. Harvey, Indianapolis; L. B. Webster, Terre Haute; Don Cameron Warren, Bloomington; Paul Weatherwax, Bloomington; Prof. Bernard Shockel, Terre Haute; Grover C. Mance, Bloomington; Mrs. Eula Davis McEwan, Bloomington; Robert G. Gillum, Terre Haute; Mildred Northnagel, Gary; William Ray Allen, Bloomington.

On motion the persons named were elected members.

The Treasurer *pro tem*, W. A. Cogshall, reported as follows.

Balance from 1912.....	\$273.38
Dues	148.00

Total	421.38
Expenditures	166.60

Balance	\$254.78

Dr. C. H. Eigenmann made a brief report of the expedition of Messrs. Hemm and Wilson to Colombia that went out under his direction.

Dr. H. J. Banker reported that he had collected 268 pages of data on the scientific literature in the libraries in the State. Many difficulties had been encountered but progress had been made. He stated that he had incurred an expense of \$18.75 in this work.

On motion the Academy ordered the Treasurer to pay this bill and extend to Dr. Banker the thanks of the Academy for his efficient work. The committee was continued.

On motion the papers of the Conservation Association were ordered published in the Proceedings of the Academy.

The regular program was then taken up, beginning with President Bodine's address.

PROGRAM.

FRIDAY AFTERNOON, 1:30.

Presidential Address.....	Donaldson Bodine
The Flood of March, 1913:	
At Terre Haute.....	Charles R. Dryer
At Fort Wayne.....	L. C. Ward
On the Ohio River in Southeastern Indiana.....	Glenn Culbertson
On East and West Forks of White River.....	H. P. Bybee
The Wabash River Flood of 1913 at Lafayette, Indiana.....	R. L. Sackett

SECTIONAL MEETINGS.

Section A. Biology.

The Selective Action of Gentian Violet in Bacteriological Analysis.	C. M. Hilliard
An Epidemic of Diarrhœa, Presumably Milk-borne.....	P. A. Tetrault
The Vertical Distribution of Plankton in Winona Lake....	Glenwood Henry
A Test of Indiana Varieties of Wheat Seed for Internal Fungous infection.....	George N. Hoffer
<i>Pyropolyporus everhartii</i> (E. & G.) Murrill, as a Wound Parasite.....	George N. Hoffer
A Simple Apparatus for the Study of Phototropic Responses in Seedlings.....	George N. Hoffer
Mosses of Monroe County, Indiana, II.....	Mildred Nothnagel
Observations on the Aquatic Plant Life in White River Following the Spring Flood of 1913.....	Paul Weatherwax
The Occurrence of <i>Aphanomyces phycophites</i> upon the Campus of Indiana University	Paul Weatherwax
Inheritance Length of Life in <i>Drosophila anpolophila</i>	Roscoe R. Hyde
Oral Respiration in <i>Amphiana</i> and <i>Cryptobranchus</i>	H. J. Bruner
Respiration and Smell in Amphibians.....	H. L. Bruner
General Outline of Trip of 1913 for the Purpose of Collecting the Fish Fauna of Colombia, S. A.....	Charles E. Wilson

Section B. Miscellaneous.

A Topographic Map of the Terre Haute Area.....	Charles R. Dryer
Center of Area and Center of Population of Indiana.....	W. A. Cogshall
On the Shrinkage of Photographic Paper.....	R. R. Ramsey
Acyl Derivatives of O-Aminophenol.....	J. H. Ransom

Boiling and Condensing Points of Alcohol- Water Mixtures.....	P. N. Evans
Additional Notes on an Almost Extinct Native Disease, Trembles.....	
.....	Robert Hessler
Race Suicide.....	Robert Hessler
A Psychologist's Investigation in the Field of Crime Among Adolescents	
.....	R. B. von KleinSmid
Agricultural Work in Southern Indiana.....	C. C. Phillips
Some Remarkable Wells in Bean Blossom Valley, Monroe County.....	
.....	J. W. Beede
On the General Solution and so-called Special Solutions of Linear, Non-	
homogeneous, Partial Differential Equations.....	H. L. Steimley
A Modified Permeameter.....	Edwin Morrison and B. D. Morris

FRIDAY EVENING, 6.

Members of the Academy and Conservation Association so inclined will have dinner together at tables in the Claypool Hotel.

FRIDAY EVENING, 7:45.

Business session of the Academy of Science.
Election of Officers, etc.

PROGRAM.

The germination of <i>Arisaema dracontinus</i> . Lantern.....	F. L. Pickett
The Prothallium of <i>Camptosorus rhizophyllus</i> . Lantern.....	F. L. Pickett
Irish Potato Scab as Affected by Fertilizers Containing Sulphates and Chlorides. Lantern.....	S. D. Conner
Newly Discovered Phenomena Connected with the Electric Discharge in Air. Lantern.....	A. L. Foley

JOINT CONFERENCE ON CONSERVATION.

SATURDAY, 8:30 TO 12:30.

Water Conservation.

A Sanitary Survey of Indiana Rivers.....	Jay Cravens, C. E.
The relations of the Lakes of Northern Indiana to Problems of Flood Control.....	Will Scott
(The papers on flood damage and control are listed under the regular program of the Indiana Academy of Science.)	

Forest Conservation.

First Steps in Indiana Forestry.....	Stanley Coulter
Taxation of Forest Lands.....	H. W. Anderson
Forests and Floods.....	F. M. Andrews

Conservation of Human Life.

County Tuberculosis Hospital as a Factor in the Conservation of Human Life.....	James Y. Welborn
Playgrounds and Recreation Centers as Factors in the Conservation of Human Life.....	W. A. Gekler
Public Toilet Facilities, Drinking Fountains and Public Spitting in Relation to the Conservation of Human Life.....	C. M. Hilliard

Mineral Resources.

Possible Dangers from Drilling for Oil and Gas in Coal Measures.....	Edward Barrett
Power Economy and the Utilization of Waste in the Quarry Industry.....	G. C. Mance

In the evening session the Membership Committee reported the following persons for election as Fellows of the Academy: George N. Hoffer, West Lafayette; C. M. Hilliard, Lafayette; M. E. Haggerty, Bloomington.

The Committee on Nominations reported the following for officers for the ensuing year:

President—Severance Burrage, Indianapolis.
 Vice-President—A. L. Foley, Bloomington.
 Secretary—A. J. Bigney, Moores Hill.
 Assistant Secretary—H. E. Enders, Lafayette.
 Press Secretary—F. B. Wade, Indianapolis.
 Treasurer—W. A. Cogshall, Bloomington.
 Editor—H. E. Barnard, Indianapolis.

On motion they were elected as reported.

The program was then completed.

Adjournment.

A. J. BIGNEY, Secretary.

DONALDSON BODINE, President.

PRESIDENT'S ADDRESS: THE WORK OF THE INDIANA
ACADEMY OF SCIENCE

DONALDSON BODINE.

Not the least among the agencies that make for the betterment of a state are such organizations as the Indiana Conservation Association and the Indiana Academy of Science. Their officers and members receive no salary, they attend the meetings at their own expense and there formally and informally discuss together problems which have to do with the development of the commonwealth. Doubtless the greatest immediate gain comes to the individual who takes advantage of the opportunity for fellowship and the mutual interchange of thought and opinion, but through the individual the state also reaps its reward. It is as true in science as in morals that the level of the state is determined by the level of the individuals who compose the larger body. The primitive law of life is competition—a competitive struggle for existence and advancement. The work of Darwin, and more especially that of his followers, has given sufficient emphasis to the importance and universal application of this law; but even in the lower realms of life, we find the beginnings of a higher law, cooperation—a mutual aid in the struggle. Kessler, Kropotkin, and others have shown the equal if not greater importance of this later principle and have called attention to the fact that in all groups of animals those who have developed this mutual aid in the largest degree have shown the greatest progress. In social evolution also the greatest advances have come since competition has given way to, or at least has been modified by, cooperation, and the greatest teacher the world has known founded his plan for the salvation of the individual and the race upon the principle of mutual service. This mutual service should be the watchword of the members of the Academy.

The constitution of the Academy provides that the President shall deliver an address on the morning of one of the days of the meeting at the expiration of his term of office, and in obedience to that provision and in conformity with the idea of true conservation, which means the best,

most intelligent and therefore the most efficient use of resources, I beg to bring to your attention some questions which I believe to be of vital importance to the Academy and to its greatest efficiency as a state organization. This is an age of organization, and associations of various sorts are rapidly multiplying. Everyone must feel the burden of the demands of societies, local, state and national, upon his time, attention and means; and to secure and maintain the loyalty and devotion of its members, any society must prove its value in substantial returns. It has been my privilege to belong to the Academy since my advent into Hoosierdom, and nearly two decades of membership have given me a high appreciation of its value. I offer no excuse, therefore, for bringing to your attention some features of the work of the Academy and in asking your consideration of some suggestions which may be of service in making it of still greater usefulness to its members.

Societies, like individuals, must be undergoing a continuous development, unless indeed they are moribund. They must be adapted to the needs and demands of the times and from time to time readjustments are imperative if a vigorous life is to be maintained. Not too infrequently, then, should we pause to take stock of our present condition and consider ways and means by which greater effectiveness can be secured. A few years ago one of our distinguished past presidents, Dr. Jordan, said that the fight for the recognition of science in the educational field and in the world at large was a potent factor in binding together the members of the Academy in a common cause. Times have changed. No longer is it necessary for the man of science to assert his rights. The theoretic chemistry of yesterday is at the foundation of modern industry; the "plaything" of the physicist of yesterday, today lights the world and puts distant peoples into instant communication; the marvels of the biologist's microscope and culture tubes have become the dependence of the modern world for the maintenance of its life and health, and the public has become well-nigh too credulous of the powers of science. The old field of battle has been won, but there are other and greater promised lands of usefulness which must be entered and possessed, and the new conquests require new adjustments and new weapons.

Section 2 of Article I of the constitution sets forth the purposes of the Academy as follows: "The objects of this Academy shall be scientific research and the diffusion of knowledge concerning the various departments of science, to promote intercourse between men engaged in scientific

work, especially in Indiana; to assist by investigation and discussion in developing and making known the material, educational and other resources and riches of the State; to arrange and prepare for publication such reports of investigations and discussions as may further the aims and objects of the Academy as set forth in these articles."

The first provision for the encouragement of research and the diffusion of knowledge concerning the various departments of science is an important one. Examination of the printed volumes of the Proceedings will disclose a long list of original contributions and reports of investigations of the natural resources of our state and of the development of various phases of scientific progress. The record is one of which we may well be proud. Many of the papers have been an inspiration to those who heard their presentation, and they remain an invaluable, permanent record of current problems or of conditions long since passed away. Still it is worth while to raise the question whether it may not be possible to increase the value and interest of the papers presented at our regular meetings by making them part of well considered and carefully prepared programs.

In connection with this problem there appears a serious defect in the practice which obtains in the organization of the committees upon which the Academy must depend for the direction of its work. The constitution provides that "The President shall at each annual meeting appoint two members to be a committee which shall prepare the programs and have charge of the arrangements for the meetings for one year." Current practice so interprets this provision that the retiring president chooses this and other committees which must work with the newly elected officers. This I consider a seriously unfortunate usage. Under such conditions there is no reason to anticipate the same sense of common interest and responsibility for the work of officers and committees as would obtain if the acting president had the appointment of his own committees. As an illustration I may cite the fact that one year within the writer's knowledge the chairman of the program committee, which so far as the immediate interests of the Academy are concerned is the most important committee, was not even informed of his appointment till so late as to make arrangements for the spring meeting altogether impracticable. Had the acting president selected his own committees there certainly would have been a closer cooperation and a fuller sense of responsibility and therefore more efficient service. This statement is made not in adverse criticism of either officers or committees, but of the unwise practice of the Academy. Cou-

mittees are the organs of a society, and without their efficient action even an enthusiastic membership can avail but little. In the interest of a closer cooperation and better service I would commend to the Academy a change in its practice to the end that the incoming president may choose and appoint the committees with which he is to work and for whose action he is in large measure responsible.

May I also add a word here to emphasize the fact that it is a matter of vital importance to the Academy that each committee should organize promptly and carry on its work with some energy. Except during its regular meetings the Academy is a discrete body and must therefore delegate the performance of its necessary work to special or standing committees and must rely upon them for its proper and timely accomplishment. In the case of the standing committees, some of the members are carried over from year to year and are therefore somewhat familiar with the work they are expected to do. On the other hand the president is elected for one year and comes to the office with no special knowledge of the organization of the Academy or of the immediate duties of his office. In addition to this, the membership being state-wide in its distribution, there are few opportunities for personal conference in planning or carrying on the work. It is practically necessary, then, for the chairmen to take the initiative and to assume the responsibility to the president and the Academy for the efficient performance of the work devolving upon their several committees.

If the work of the committees be neglected or indifferently performed, the Academy suffers and has little opportunity to repair the failure. Fortunately, members are loyal and try to render excellent service. The chief difficulty comes from a failure to realize the time-consuming nature of the accomplishment of work through correspondence and the delays incident to widely separated residence of different members of committees. Every committee, therefore, should organize at once and make early preparation for their work.

The committee of most immediate importance to the Academy is the program committee and it is so fundamental that I may be pardoned a comment or two regarding its work. Personally I do not believe it is sufficient that this committee simply issue a call for contributions. Plans for a definite program should be made at once, and by personal invitation and correspondence the cooperation of members should be secured in carrying it out. This year's program affords an illustration of this plan, and I be-

lieve will prove its value. A definite idea should be developed as to the principal feature of the program, and the participation of individual members should be secured to treat of its various phases lying within the range of their several fields of work. This involves much labor, but the results will justify the effort, and I am sure the committee will be willing to give the necessary time and energy to the accomplishment of the plan. The writer does not believe that the papers form the most important part of the work of the Academy, but it goes without saying that a well-planned, attractive program is of first importance in gaining attendance and interest at the meetings, and without these all other ends will suffer defeat.

One result of the specialization of today is the narrowing of the interests of workers to smaller and smaller limits within the fields of their special activities. I quote in part from the address of Dr. John M. Coulter to the Academy on the occasion of the celebration of its twenty-fifth anniversary. There is "a tendency to become narrow in our vision and lose our perspective of the whole field not only of science but also of education. You will find that as scientific men become less and less interested in other fields of work, as they grind their own grooves deeper and deeper, they become less and less effective as teachers and less and less influential with their students. You will find men with broad outlook, clear and wide vision, men with sympathy—men can only get these things by coming in contact with larger fields than their own—are the men who win with students." So spoke one of Indiana's most effective teachers, and we must all be quite in accord with his opinion. Since we recognize this tendency, I would point out that a program which by its general interest and excellence will provoke thought and discussion in other than immediate individual fields of activity would be of inestimable value in the work of the Academy for its members. To this end may we not expect and demand the hearty cooperation of officers and committees and a ready and enthusiastic support from the whole membership?

One other consideration in connection with the regular programs is worth a passing mention. Modern photography and improved projection apparatus afford an important addition to the means of clear and interesting presentation of results of work, and in connection with this visual method I venture to suggest that more attention be given to the exhibition of specimens, apparatus, or preparations. The greater part of our members are teachers or are in some way closely identified with educational work, and the display of apparatus or preparations that have proven help-

ful in actual use would be of great practical value. Such displays have become one of the most acceptable features of the meetings of the sections of the American Association and of its affiliated societies and with our smaller and more intimate membership they might well prove of equal or greater value. Reference is not made here to the elaborate display of a single worker so much as to the exhibition of a number of less pretentious bits of apparatus or ingenious devices or illustrative specimens. For example, one scarcely ever visits a laboratory for the first time without seeing some ingenious device that has been worked out to meet a real need. Usually the same need is found elsewhere, and the display of the device at such a meeting as ours would command an appreciative welcome and be both suggestive and helpful.

The most important function of the Academy lies outside of the regular program, though in a large measure the latter conditions its success. I refer to the social side of the meetings—the intercourse of members for personal association and inspiration. The testimony of all older members agrees upon this as the pleasantest and most profitable feature of the Academy. During the business or teaching year we are largely isolated from each other. Sometimes a want of sympathy with or even distrust of the work of others arises from a lack of personal acquaintance and a knowledge of what they are doing. President Wilson has said that “Unless the hearts of men are bound together, the policies of men will fail; because the only thing that makes classes in a great nation is that they do not understand that their interests are identical.” Personal acquaintance will do more than any other one thing to bring about a common good fellowship and mutual appreciation which will insure that the other objects of the Academy will flourish through stimulus to thought and work and wider usefulness. The political boundaries of a state may not serve best as limits to a scientific organization, but at least they do serve to bind together into a practical working unit for the purpose of acquaintance, friendship, and cordial relations the scientific workers of a limited geographical community. This alone is an all-sufficient justification for the existence of our state organization.

Man is a social being, and nothing else is so potent in his development as personal contact with his fellows. Wagner has made much of isolation as a factor in evolution. Jordan insists upon its necessity if animals are to maintain themselves and develop into a species. This

isolation, however, is not that of the individual, but of a society. Isolation of the individual kills; of the society, vivifies. Segregation, with its consequent freedom from intimate contact with distracting forces and especially with its consequent interaction of varying kinds and degrees of like tendencies and interests, is of paramount importance in the development of the individual. This kind of segregation is just what our organization can and should accomplish. As members we are each interested in some particular field of work and too many of us find it difficult to keep in touch with the broad fields of which ours is but a part. No other agency can do so much to help us here as the personal contact which our meetings make possible. During the last two decades the pendulum has swung too far in the direction of intense specialization to the exclusion of the broader training, and already clearer minds are calling us back to the fact that science is one great field, and that to succeed in any part, one must have a broad view and a fair knowledge of the whole. The distinguished president of the British Association laid emphasis upon this in his address upon "Continuity" at the Birmingham meeting last month. President Van Hise says that for the training of a geologist there must be intimate knowledge of at least two basal sciences with a broad knowledge in other fields. "No man," says he, "may hope for the highest success who does not continue special studies and broadening studies to the end of his career. Besides the broad training in language which is essential in every field, there must be an intensive training in chemistry, physics, mineralogy, and biology." In other words the study of geology alone cannot make a competent geologist. Professor Bessey, whose word always commands the thoughtful attention of all teachers and students in America, contends that the fundamental training of a botanist may well be limited in the special botanical field to three years of university work, so that time and energy may be spared to the acquisition of the broader foundation necessary for subsequent specialization. With such a wide training the student is able to take up his special work with an intelligence and understanding that is impossible to one trained in a narrower fashion. In his presidential address to the Academy three years ago Dr. Evans said: "He is a poor chemist, who is only a chemist." Further testimony from experts in the scientific and educational fields could be cited, but I believe we all agree as to the value of broad training and the maintenance of broad inter-

ests along with any degree of specialization that may be attained. In view of this belief may I repeat that the personal interchange of ideas and the comradeship that our meetings afford can do much to nourish and keep alive this wider interest in different fields that all too readily becomes deadened by the isolation of the individual in his own work. In this service the Academy has a peculiar advantage over associations organized to promote some particular purpose. Its interests are broad, its members are recruited from widely varying fields, and yet all are bound together by their common interest in scientific work. In this respect no other organization has quite so much to offer to its members. The working out of the problem involves grave difficulties, but I believe there should be some way of putting larger emphasis upon the social side of the meetings. If possible the program committee should make some provision for greater opportunity for social intercourse. Short recesses in the regular sessions might be of service. The examination and discussion of exhibits such as previously suggested would be admirable for the purpose and would be not less effective than more elaborately planned occasions which are likely to become more or less formal and thus miss their real object. A greater cordiality on the part of the older members toward the younger, especially those who have recently joined the ranks of the Academy, would count for much. We should be of one large family and not stand too much upon formality.

In this connection let me remark that the Academy is not living up to its privileges. It should have a much larger membership. Indiana has many scientists engaged in industrial work. Pure and applied science, if we may use as still tenable that distinction of Huxley's, go hand in hand and we should do well if we could enlist in the service of the Academy many of the workers in the fields of the practical application of science. There should be some systematic effort by the membership committee to seek out these men and to show them the advantages of a connection with the Academy. In this work the committee must have the hearty cooperation of every member. It should be possible to enlist in our service the members of the various state departments of science who are doing valiant service in promoting the welfare of the people through work in agriculture, entomology, forestry, geology, health, hygiene, and sanitation. They would greatly help the Academy and in turn would unquestionably be well repaid by the advantages of membership.

In connection with the social side of the work of the Academy, one

other feature needs special mention. Conversation with the various members has shown that too little is known of the regular spring meetings. Comparatively few attend, but of those who do it is the common testimony that they are both most enjoyable and profitable. May I urge their claim upon your attendance? They are held in a different place each year and are in the nature of field excursions. This plan offers two great advantages. It gives occasion for members to visit different parts of the state and in association with others, some of whom are familiar with the territory, to become acquainted with the characteristic features of the locality. Through a series of years opportunity is given to acquire a personal knowledge of the more interesting and representative parts of the state which one scarcely would or could attain by individual travel or excursions. Field trips of this sort also afford the very best opportunities for gaining mutual acquaintance and for interchange of ideas and discussion. As one who has rarely missed a spring meeting and then only with regret and by reason of necessity, let me urge upon all the pleasure and advantages of attendance. That many other demands upon time and attention, especially at that time of the year, are pressing is recognized, but the value of such meetings will well repay the sacrifice of trouble and expense, and it is hoped that many who have not as yet attended these excursions into the field will in the near future find it possible to take part in them. I have endeavored to outline some ways in which immediate work may be done in the interests of enlarging the usefulness of the Academy. I am convinced that such work should be undertaken and have therefore turned from a more attractive theme as the subject of my address because it seemed to me a proper time and occasion to call attention to the necessity of some changes if we are to maintain and increase our membership and to serve it efficiently and well. With opportunity comes responsibility; and responsibility well discharged, brings yet larger opportunity. With an increased and united membership we could take an important part in the educational work of our state which, on its scientific side, needs direction and encouragement.

In closing allow me to propose one definite undertaking which I believe the Academy should give careful consideration. The end to be gained we would all welcome, and the effort toward its attainment would in itself be of value and incidentally bring other happy results. It seems to me that the Academy of Science is the proper body to urge a movement toward the establishment as part of our educational system of an adequate organi-

zation of a state museum for the collection, exhibition and preservation of our fauna and flora, our geological and archaeological history, and our natural resources. Such a museum would become the center of the scientific work of the state and the depository of the materials brought together by the state surveys. I do not mean to advocate a museum in the old sense of the word, to be a mere custodian of rare or curious specimens and records, but an organized department which shall exhibit our natural resources and point out the possibilities of their development in the interests of the people. Such a museum would fill a large place in the educational system of the state.

The rise of the museum in the city, state, and nation is the latest phase in the educational evolution of our day. It is only necessary to point to the work of such institutions as The National Museum at Washington, The New York State Museum at Albany, The Museum of Natural History at New York, The Carnegie Museum at Pittsburgh, and The Field Museum at Chicago, to prove its value in modern life. Its method of teaching is direct and impressive and it is the only method that is able to reach many of the people of a community. "The truest measure of civilization and of intelligence in the government of a state." I quote from an address of Professor Henry Fairfield Osborn, "is the support of its institutions of science, for the science of our time in its truest sense is not the opinion or prejudices, the strength or weakness of its votaries; it is the sum of our knowledge of nature with its infinite applications to state welfare, to state progress, and to the distribution of human happiness." In the development of this side of our educational system Indiana—we must admit it with regret—is far behind other and neighboring states. New York State is the leader and has evolved an ideal organization. Beginning in 1836 with the establishment of an official Natural History Survey, she has made successive and progressive changes until in 1894 a consolidation under the State Department of Education placed the museum at the head of all the scientific interests of the state. It directs all surveys, archeological, botanical, entomological, geological, paleontological, topographical, and zoological, and with the consolidation has come a great gain. It has succeeded not only in building up a museum worthy of a great state, but it has also taken a place in the educational work which no other organization could fill equally well. By means of instructive exhibits it has become a great teaching force, and through its traveling collections and the furnishing of materials and specimens to schools and societies it has widened its

sphere of usefulness till it reaches every part of the state and has the sympathy and active support of a wide constituency.

Our own state in 1869 organized a Department of Geology and Natural History and much good work has been accomplished. The energies of the department have been largely confined to investigations in the geological field, however, and its official title has been changed to The Department of Geology and Natural Resources. Little has been done in other fields and practically nothing in an educational way to gain the interest and support of the people of the state as a whole. It has been unable, therefore, to obtain adequate financial support from the state or to enlist the cooperation of other departments and organizations which should assist in building up an institution of which we might be proud and which would take a large place in the educational system of the state. Indiana now has a number of state departments or boards for the control or prosecution of work in various fields of pure or applied science, but for the most part they are independent in organization and work and there is lacking that cooperation and solidarity we should expect and without which the highest effectiveness cannot be attained. Let me say again that this statement of fact is not made in the spirit of criticism of the officers or personnel of any department; the purpose is simply to call attention to the situation as it exists and to point out the desirability of a change in the organization to bring about a condition more fitting to present conditions and therefore more advantageous to all departments and to their work for the state. I believe it would be wise and proper for the Academy, together with the different scientific departments and boards of the state, to consider some plan for the consolidation of the scientific agencies of the state which would render their work more effective and more extensive and thus gain the sympathy of the people and the necessary increased financial and other material support from the legislature. What is everybody's business is nobody's business, but some body or some organization should make it its business at least to consider some method of encouraging and forwarding the organized scientific activities of the state, and by reason of its character and standing the Academy of Science might well lead the way. For such action the third purpose of the organization as laid down in the constitution provides abundant warrant, and it is the belief of the speaker that through such action the Academy would render large and lasting service to the state.

WABASH STUDIES. IV: THE FLOOD OF MARCH, 1913, AT TERRE HAUTE.

CHARLES R. DRYER.

The natural channel of the Wabash at Terre Haute is 700 feet wide and 15 feet deep, low water standing at 446 feet A. T. The flood plain which becomes a channel at high water is 460 feet A. T. and from 9,000 to 13,000 feet wide. The bluff on the west rises to about 550 feet and the terrace on the east to 490 feet. An island terrace, a mile long and a quarter of a mile wide, rising to 480 feet, stands in the flood plain near the west side.

The city of Terre Haute occupies the terrace along the east bank of the Wabash, 45 to 65 feet above low water and 30 to 50 feet above the flood plain. West Terre Haute (population 6,000) stands on the island terrace 10 to 20 feet above the flood plain. Taylorville, a slum district (population 600), is built on the flood plain at the west bank of the river. Toadhop (population 200) is a workmen's village in the flood plain where Sugar Creek breaks through the west bluff.

The grade of the Big Four Railroad, fifteen feet high, crosses the flood plain diagonally to the northwest, but has an opening midway 200 or 300 feet wide, crossed by a trestle. The grade of the Vandalia Railroad, of equal height, crosses the plain at right angles without a break except an underpass about fifteen feet wide for the Paris interurban line near the west end. The Wabash avenue grade to West Terre Haute parallels the Vandalia and forms a complete dam, paved with brick. Each of these roads crosses the river by a steel bridge about 700 feet long resting on four or five piers.

On March 24, 1913, the river gauge stood at 17 feet and the water was out of the channel, flooding Taylorville. On March 27th the river had risen to 31.25 feet (477 feet A. T.), where it stood for about fourteen hours. Taylorville and Toadhop were submerged and the waters occupied West Terre Haute except two small islands. The railroad grades were washed

out for about half a mile and water a foot deep poured over the whole length of the Wabash-avenue grade, forming a waterfall about two feet high upon the interurban track on the south side. A bayou which cuts into the terrace on the northwestern edge of Terre Haute was flooded and about sixty houses were covered or floated away. The flood still lacked thirteen feet of reaching the lowest levels of the Terre Haute terrace, but threatened or reached the basements of several public utility stations along its river edge. The water-works pumping station did not suspend operation, although the filtering plant was unusable. The station which furnishes city light and power for car lines was protected by a temporary levee and out of business but a few hours. The gas works shut down fourteen hours.

Terre Haute was without railroad communication for about a week, but mail and passengers were transferred two miles by boat. One of the peculiar and interesting marks left by the flood was the spreading out of the gravel from the broken Vandalia grade into a great fan, which buried many houses in West Terre Haute up to the second story in gravel. The railroad and street grades acted as so many dams to compel the flood water to pass through the normal channel 700 feet wide. If they had been provided with adequate openings high water would have been several feet lower, the grades would have been left intact and West Terre Haute uncovered by water or gravel. During midsummer low water the discovery was made that the piers of the Wabash-avenue bridge had been seriously undermined and they had to be strengthened with concrete. The discharge of flood water under the bridges has been estimated at 300 times as great as the normal, a contingency for which the bridge engineers had not provided.

THE FLOOD OF MARCH, 1913, ALONG THE OHIO RIVER AND ITS TRIBUTARIES IN SOUTHEASTERN INDIANA.

GLENN CULBERTSON.

Upon investigation it was found that the floods of the tributaries of the Ohio River in southeastern Indiana, resulting from the unusual rainfall of March 23-27, 1913, were not so remarkable as those of the streams of central Indiana and Ohio.

Two reasons may be given for this. The first is that the precipitation in the basins of the tributaries of the Ohio in southeastern Indiana during the above period did not exceed seven or seven and a half inches, except in very small areas. In the basin of the tributaries of the east and west forks of White River the rainfall in places reached nine or more inches during the same period. The second reason is, that while the precipitation was excessive, yet the heaviest showers of two or three inches, coming within a period of a few hours, were sufficiently separated in time to permit the "immediate runoff" to pass into the larger streams and on to the Ohio River. This was done the more readily inasmuch as the gradients of the tributaries of the Ohio in this region are very high. In these streams a period of a few hours only is needed to carry off an excess of water that in the more level parts of central and northern Indiana would require almost as many days.

Two or three excessive rainfalls of this period added greatly to the destructive erosion of the steep hillsides, where unprotected by forest growth or other vegetation. The soil of these slopes, loosened by the winter's frost and in too many cases entirely without protection, was swept away by the hundreds and thousands of tons. Along with the finer materials much gravel and small stones were deposited over the valuable bottom lands along the larger streams, adding greatly to this destructive work which has taken place during every great flood since the forests were removed from the hills.

The flood of the Ohio River during early April, resulting from the rains of March, was not the greatest known, being exceeded by that of

1884. That of March, 1913, however, was noted especially in two respects, viz: the remarkable rapidity of its rise, and the very great quantity of sediment carried.

From ten days to two weeks are usually required for the Ohio River to reach a flood stage such as that of March, 1913, but in that case such was the rapidity of the rise, that flood stage was reached in four or five days. Because of the unusually rapid rise there was a destruction of movable property much greater than ordinarily occurs.



Slide Covering Madison and Hanover Pike.

The deposits left on the bottom lands of the Ohio by the floods of last March were by far the greatest known. In many places the silt or mud was laid down to the depth of six, eight, and even twelve inches. The immediate effect of this deposit was the complete destruction of all wheat and alfalfa growing in the bottoms below high water mark, where covered with flood waters for several days. In many of the Ohio bottoms alfalfa is one of the most valuable crops and its destruction was a serious loss to the farmers. Where the soil could be broken and cultivated all the bottom

lands, whether previously sown to wheat or alfalfa, were plowed and planted in corn. Where the deposits were eight to twelve inches, however, and in some cases even of less depth, it was found to be impossible to get the soil in condition for a crop in 1913, a winter's freezing and thawing being necessary to produce the proper texture in the soil for the cultivation and production of a crop. The materials, soil and silt, left by the 1913 flood, like all those of more recent years, are found to be not nearly so fertile as were the deposits of the past, when much of the basin of the Ohio was still largely forested.



Landslide on Steep Hillside Upon Which Tobacco Had Been Grown. This Picture Shows a Great Mass of Soil, etc., Heaped Up Below the Break.

The most important results of the very unusual precipitation of last March, on the steep slopes of the Ohio and its tributaries in southeastern Indiana, from a geological standpoint and probably from an economic also, was the very great number and size of the landslides. Those occurring as a result of the rains of last March were tenfold more numerous than those following any heavy rains of the past. Every few hundred yards along the slopes facing the Ohio and its larger tributaries, these slides occurred.

In some places great cracks extending for several hundreds of feet were formed in the earth, and the soil moved a few feet only. In other places hundreds of tons of soil broke away to the depth of from three to five or six feet, and moved to more gentle slopes below, leaving a great tangle of soil, roots, branches and trunks of small trees in huge mounds. Valuable tobacco or other lands were rendered unfit for cultivation, or roadways were so completely covered that the use of dynamite alone could remove the material and open the roads for traffic.

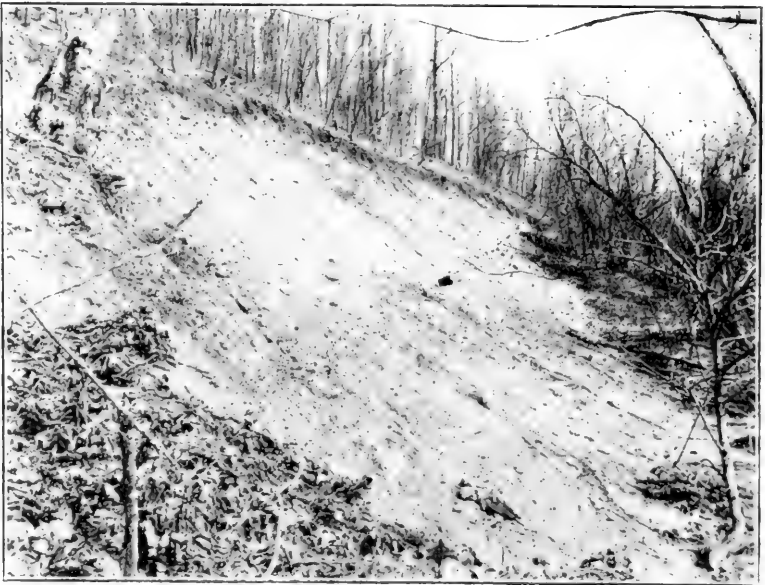

Slide Covering One-half Acre on a Slope Covered with Growth of Small Trees.

In other cases the slides began well up the slopes and continued to the bottom of the valley, carrying hundreds of tons of rocks, soil, and vegetable debris. The slides were fully as frequent on the forested slopes where the larger trees had been removed, and only shrubs and small trees remained, as on the hillsides covered with blue grass. In a few cases it was noticed that a black walnut or a white oak, although not more than a foot in diameter, was able to hold the soil even in the midst of a comparatively large landslide. The large tap roots of these trees extended far

below the materials loosened, and hence held their positions and the soil embraced by them.

Very much more extensive than the slides themselves was the creep of the hillside soils. The effect of the creep was the removal of thousands of tons of soil on a single slope to the distance of a few inches or a foot or so down the slope.

The one great lesson taught by the excessive rainfall of March, 1913, so far as the steep slopes of southeastern Indiana are concerned, is that



Extensive Slide on a Steep Slope Covered with Blue Grass Sod.

the only adequate protection against disastrous soil loss is in the reforestation of such localities with the larger varieties of trees. The planting of such trees as the black walnut and the white oak and others with very large tap roots is especially desirable.

THE WABASH RIVER FLOOD OF 1913, AT LAFAYETTE, IND.

R. L. SACKETT.

The principal factors affecting the flood discharge of rivers in cubic feet per second per square mile are:

- The duration and intensity of rainfall.
- The topography of the watershed.
- The geology of the watershed.
- Temperature and condition of the soil and surface.
- Presence of lakes.
- Slope and general character of the channel.

Data has not yet been collected so carefully and for long enough periods to permit predicting flood stages with any accuracy.

Tiefenbacher gives the following estimate of the flood discharge of European streams in cubic feet per second (See Ency. Brit., Eleventh Ed., Vol. XIV, p. 77):

- In flat country 8.7 to 12.5 cubic feet second per square mile.
- In hilly country 17.5 to 22.5 cubic feet second per square mile.
- In moderately mountainous districts 36.2 to 45.0 cubic feet second per square mile.
- In very mountainous districts 50 to 75 cubic feet second per square mile.

Various formulas have been proposed to express the maximum flood flow such as

O'Connell proposed, Q equals $K\sqrt{M}$ where K varies "from 0.43 for small rivers draining meadow land" to 67.5 for the Danube.

Q is the discharge in cubic feet per second.

M is the area in square miles.

Fanning proposed, Q equals $200 M$ for New England Rivers.

Dredge gives, Q equal $1300 \frac{M}{L^2}$ where L is the length of the catchment area in miles.

Kuichling plotted available data and derived the following formulas:

$$Q = \left(\frac{44000}{M + 170} + 20 \right) M, \text{ for floods exceeded occasionally;}$$

$$\text{and } Q + \left(\frac{127000}{M + 370} + 7.4 \right) M, \text{ for floods exceeded rarely.}$$

In U. S. Geolog. Survey Bulletin No. 147,

$$Q = \left(\frac{46790}{M + 320} + 15 \right) M, \text{ is proposed.}$$

Many other formulas have been proposed and are given in a paper by Mr. Fuller in the Trans. Amer. Soc. C. E., Vol. XXXIX, p. 1063.

When applied to the Wabash they give widely varying results because none of them was made for the topographical and meteorological conditions which characterize our floods.

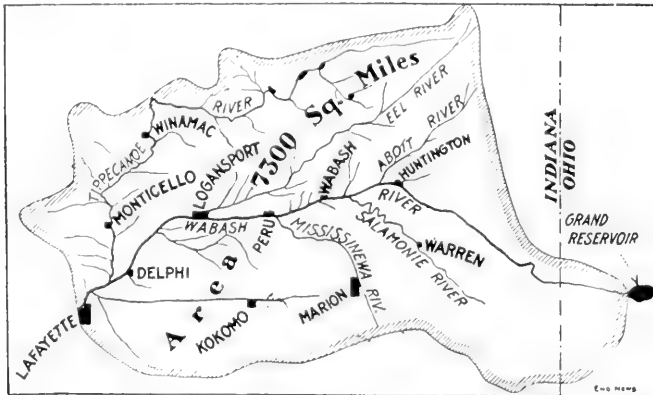

Fig. 1. Drainage Area of the Wabash River above Lafayette, Ind.

The following extract from an article by the author in Engineering News, April 24, 1913, will explain the conditions causing and accompanying this flood.

A series of heavy rains, extending over the entire drainage area of the Wabash River, commenced March 21 and continued at intervals until March 26, raising the river to unprecedented heights, causing the loss of many lives and the destruction of several million dollars of property.

Previous floods which did much damage occurred June 11, 1858, August

5, 1878, February 17, 1883, and March 15, 1907. The flood of 1913 reached a mark 22 inches higher than the record of 1883 at Lafayette, Ind., and exceeded all records at Peru and Logansport by as high as 8 feet. The flood of 1883 was produced at Lafayette by an ice jam which formed about a mile below the city. The damage done was due to slack water, while the present flood caused the partial destruction of three large steel bridges by extraordinary erosion of the river bottom in the restricted sections.

One student lost his life in an attempt to rescue men marooned on the Brown-street levee, when the latter washed out on the west of them and the bridge fell on the east of them. High water closed the gas works, the two water-works pumping stations, the city heating and lighting plant and many industries; one light and power plant continued in operation although its condensers and pumps were under 7 feet of water.

The drainage area with its tributaries above Lafayette, as shown in Fig. 1, includes an area of about 7,300 square miles, of which 400 are in Ohio. The whole of this area is in a glaciated area, the depth gradually decreasing east of this point until near Logansport, Ind., the bed of the river is in rock. East of that point the deposit varies in thickness.

The drainage area is practically clear of forests and under cultivation. The average fall of the river is about 18 inches per mile here and increases in the upper portions. There are numerous islands and sand bars which form and are swept away in periods of high water. The soil wash is high and the loss therefrom is a matter of great moment. The high turbidity is, of course, a factor in the erosive action which is so characteristic of the rivers of the Mississippi Valley.

The elevation of the head waters above M. H. T., New York harbor, is about 1,000 feet; at Huntington, 699 feet; at Logansport, 583 and at Lafayette, 500 for low water.

Rainfall data preliminary to the hydrograph, Fig. 3, are given in Table I.

TABLE I. RAINFALL DATA OVER WABASH RIVER DRAINAGE AREA.

(Measured by Experiment Station at Purdue University.)

Date	Inches.
Average annual precipitation	50
Greatest annual precipitation, 1909	55
Greatest monthly precipitation June, 1902	11.37
Greatest precipitation in twenty-four hours, August 12, 1912	4.30
Rainfall for March, 1913	7.05

The hydrograph shows a remarkable relationship between rainfall and runoff for a watershed of this area—7,300 square miles. From March 1 to

March 20 inclusive, only 0.94 inches of rain fell. From Fig. 3 it is apparent that according to the government rain gage at Purdue, and a private gage, about 1 inch of water fell preceding the 23d, enough to thoroughly saturate the soil. On the 23d, 1.75 inches of rain fell; another inch on the 24th; 1.35 on the 25th-26th and snow on the 26th, which did not immediately melt. While there are no other rain gages on the watershed above this point from which records were obtainable, it is quite probable that the diagram represents average conditions. (See Table in *Engineering News*, April 3, 1913, p. 381.)

The daily maximum temperature during the flood period is also shown on Fig. 3. While there had been no snow the saturated condition of the ground, which was free from frost, the temperature and the distribution of rainfall caused the highest known stage of the river.

Gagings of the Wabash River here have been made by students at Purdue University for several years and by the Weather Bureau and U. S. Geological Survey.

From these we find the following greatest annual discharge:

<i>Date.</i>	<i>Max. for Year in Cu. Ft. per Sec.</i>
1904, March 27.....	70,000 (estimated.)
1907, March 15.....	41,500
1908, March 7.....	57,000
1909, February 25.....	44,000
1910, January 19.....	49,000
1911, January 29.....	31,000
1912, March 20.....	15,900
1913, March 26*.....	95,400 (including flow over levee.)

From the above data it is evident that the flood of 1913 was greater than any other recent one.

The maximum flood rate at Lafayette was less than 20 cubic feet per second per square mile. For Logansport, the flood of 1904 gave less than 20 cubic feet per second per square mile.

These are low rates and as the rainfall did not average as great as has been recorded for equal areas otherwheres it was not a flood which would occur only once in a hundred years, but may be expected more frequently than that.

*NOTE.—A more extended investigation of the flood gagings indicates that the maximum discharge may have reached 130,000 cubic feet per second.

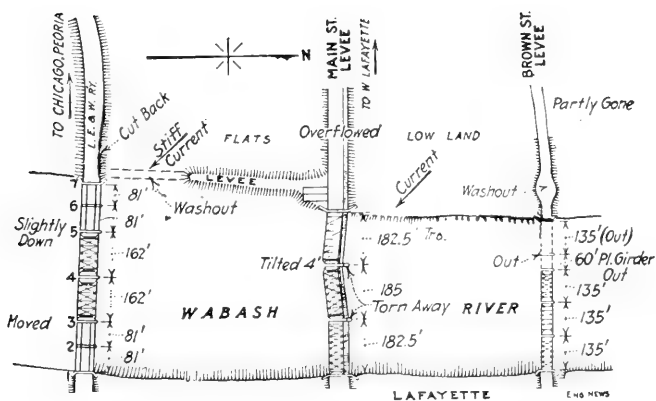

Fig. 2. The Three Bridges Across the Wabash at Lafayette.

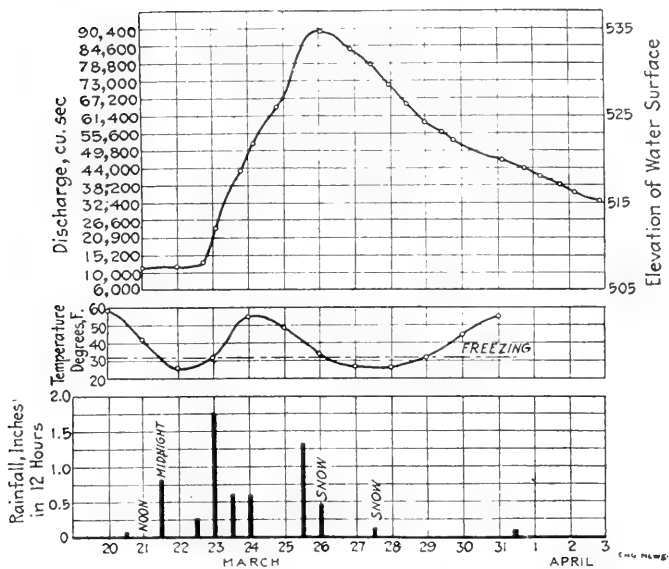

Fig. 3. Hydrograph of the Wabash River, Lafayette, Ind., March 20-April 2, 1913.

From the data so far available for floods in the Ohio River Valley, Fuller proposes as the maximum 24 hour flow:

Q equals $150 M$, where M is the catchment area in square miles and Q is total cubic feet per second.

As a result the maximum expected flood flow here would be 180,000 cubic feet per second.

The average flood is given as, Q equals $75 M$, which equals the recorded discharge of last March.

Another method of discussing the question of future floods is by their expected frequency. For those eastern streams where data has been collected for some time it appears that a flood of twice the average flood discharge may be expected about once in 40 years.

THE SELECTIVE ACTION OF GENTIAN VIOLET IN BACTERIOLOGICAL ANALYSIS.

C. M. HILLIARD.

In 1912 Churchman¹ reported a new differential test for the *Schizomyces*, depending upon the selective bactericidal action of gentian violet. The action of this stain in high dilution upon various organisms planted in media containing the dye was found to correspond closely to the Gram staining reaction, the forms inhibited—"violet positive"—being in the majority of cases forms that retain the stain; those growing—"violet negative"—usually being strains that decolorize when treated by the Gram method. His actual results on 318 different strains of bacteria are shown in the following table:

318 Strains.	Gram positive.	Violet positive.	Violet negative.
	182	165 (90%)	17 (10%)
	Gram negative.		
	136	15 (11%)	121 (89%)

The characteristic behavior of bacteria cultivated in the presence of the dye in high dilution (1:100,000) is "so constant and clear cut that it must be regarded as a fundamental biological characteristic." The Gram stain has ever been an unsatisfactory test with certain groups of organisms, especially the Coccaceæ. Differences in the age of the cultures, time of application of the various reagents, and the temperature may influence the result. It is sometimes extremely difficult to interpret the result of the stain as, some individual cells will retain the stain and others in the same field or even in the same chain as contiguous cells will have decolorized. As an instance of discrepancy in interpretation of results we may cite Kligler's work² who by the same method (Churchman's) recorded 13 of 17 strains of saprophytic cocci as certainly Gram negative, while four stained uncertainly, as opposed to Churchman's recording of all 17 strains as Gram positive. In my own work on 240 strains of streptococci I found 21 to stain irregularly and occasionally successive stains of the same culture at different times would give totally

¹ Jour. of Exp. Med., Vol. XVI, No. 2, p. 221.

² Jour. of Exp. Med., Vol. XVII, No. 6, p. 653.

opposite results. The violet reaction is in striking contrast to this "notoriously uncertain" staining test and though not assuming to be a parallel or substitute test, it is a valuable differential reaction.

Work on various other staining agents has shown many to exhibit a definite selective inhibitive action. The Conradi-Drigalski medium for isolation of *B. typhosus* from water, stools, etc., has as its basis the restraining action of the crystal violet towards various cocci and bacilli, without influencing at all the growth of the typhoid-colon group. Krumwiede³ and Pratt⁴ and Churchman⁵ have made observations on the growth of bacteria on media containing various closely related aniline dyes and have found their action to correspond closely to that of the gentian violet. Smith⁶ has shown the violet test to be specific for certain of the phytopathological bacteria.

Aside from the significance of this test as a classificatory feature of great value it might be expected to have some practical application in sanitary bacteriological analysis, as most of the intestinal bacteria that we presume indicate pollution by sewage are Gram negative and, therefore, with few exceptions, are violet negative. Many of the common saprophytic bacteria found normally in water and in milk are Gram positive and so would in the majority of cases fail to grow in the presence of the stain. Churchman in his work on the collection at the American Museum of Natural History found the following organisms to be Gram negative and with two exceptions also violet negative:

- 3 strains of *B. coli communis*.
- 5 strains of *B. coli communior*.
- 5 strains of *B. paracoli*.
- 2 strains of *B. coli varietas*.
- 14 strains of *B. typhosus*.
- 18 strains of *B. paratyphosus*.
- 5 strains of *Vibrio cholerae*.
- 3 strains of *B. dysenteriae*.
- 5 strains of *B. enteritidis*.
- 3 strains of *B. cloaca*.

Curiously enough *B. welchii* and *B. sporogenes*, both Gram positive, proved to be violet negative. *Subtilis*, *mycoïdes*, *megatherium*, *liodermos*, *mesentericus* and many of the saprophytic cocci are violet positive.

³Ztschr. of Hyg., Vol. XXXIX, p. 283.

⁴Proc. N. Y. Path. Soc., Vol. XIII, p. 43.

⁵Jour. Exp. Med., Vol. XVII, No. 4, p. 373.

⁶Phytopathology, Vol. II, No. 5, p. 213.

A priori, then, we might expect that the addition of gentian violet to our culture media in proper dilution would result in eliminating many saprophytic bacteria, still permitting those forms of sewage origin to flourish. If we used a sugar medium and added litmus we could still further emphasize the colon group, as these are acid-forming organisms. The violet stain partly masks the coloration of the litmus indicator, but not sufficiently to make the picture of acid fermentation uncertain.

My work to date has not been extensive enough to warrant any definite conclusions, but it is at least suggestive. I have analysed various samples of water taken chiefly from the Wabash River, which is rather highly polluted at Lafayette. Duplicate plates of proper dilutions have been made of litmus-lactose agar and litmus-lactose-violet agar, the latter being the same as the former with the exception of the addition of a standardized loop full of gentian violet solution to the agar tube just before pouring. The plates have been examined after 24 hours incubation at 37° C. The total number of organisms growing, the total number of red colonies—acidifiers—and the presumptive coli colonies growing on the two media have been recorded. The suspected coli growths have been “fished” and planted in lactose-peptone-bile for confirmation and almost without exception the fermentation of this media has checked the presumptive colony growth.

The colonies on the violet plates appear somewhat smaller and the acid production is less distinct. The stain is picked up by the cells so that the colonies appear, especially the sub-surface colonies, as distinctly purple growths. Viewed under the microscope the cells show a light purple color, indicating vital staining.

So far I have found pretty generally what was expected, viz., that the total count is materially reduced on the violet plates but that the number of red colonies, and especially of coli, are approximately the same on the two media. It has been found possible to plate a larger sample of water and to intensify the picture of presumptive pollution by the use of the violet. A few typical examples of actual tests will illustrate this:

<i>Sample.</i>	<i>Media.</i>	<i>Total counts.</i>	<i>Total red.</i>	<i>Coli.</i>
Wabash (polluted).	L. L. A.	15,000	5,000	3,000
	L. L. V. A.	8,000	6,000	6,000
Wabash.....	L. L. A.	10,000	1,800	600
	L. L. V. A.	3,100	1,100	500

<i>Sample.</i>	<i>Media.</i>	<i>Total counts.</i>	<i>Total red.</i>	<i>Coli.</i>
Wabash.....	L. L. A.	3,500	2,000	700
	L. L. V. A.	1,500	1,300	600
Wabash.....	L. L. A.	8,700	2,600	1,600
	L. L. V. A.	4,200	2,000	1,550
Tap (driven wells).	L. L. A.	16	0	0
	L. L. V. A.	0	0	0

The last test noted in the above table suggests that the ratio of the count on lactose agar with and without the violet present may be a valuable diagnostic feature. Polluted waters show about 50 per cent. reduction of the total count on violet media, while unpolluted water containing more of the saprophytic violet positive organisms show a much greater reduction; 100 per cent. in the case of the tap water at Lafayette. Gram stains of centrifuged specimens of fresh sewage shows the ratio of Gram positive to Gram negative cells to be anywhere from 1:5 to 1:100. This does not check the 50 per cent. reduction very closely but many factors of a variable nature enter into the two tests. The significant point is that the majority of sewage organisms are Gram negative and therefore may be expected to be violet negative.

Further work is being done to determine the quantitative relations of pure strains of typhoid and coli studied by this method and to test the effect of attenuation of these forms in relation to the violet when held in suspension in water under various conditions of temperature, light, etc. So far the results seem to indicate that sojourn of a week or more has no selective inhibitive effect; in fact, the violet media seems to be favored by the organisms after this treatment.

One interesting point has been brought out by this latter study. In working with several strains of coli suspended in water, variation in counts on the two media—lactose agar plus violet, and without the violet—was so great that I decided to test the individual strains. I found one, No. 41 received from the American Museum of Natural History and thoroughly tested by myself, to be absolutely inhibited by the violet stain. A study of the culture showed it to be a motile, Gram negative bacillus, fermenting bile rather weakly, not liquefying gelatin after ten days, and giving other characteristics typical of coli. Churchman and Michael⁷ have described work on

⁷ Jour. Exp. Med., Vol. XVI, No. 6, p. 822.

B. enteritidis where one form, indistinguishable from the others by any morphological, cultural or agglutination characters was singled out nevertheless by this delicate affinity of the violet dye. The observation, he states, is an isolated one, but my experience with this colon culture seems to confirm the fineness of this selective affinity.

Although my work is too meagre to warrant any definite conclusions, yet it seems to be suggestive, at least, of the value of selective bactericidal or bacteriostatic dyes as valuable adjuncts in sanitary bacteriological analysis.

AN EPIDEMIC OF DIARRHŒA, PRESUMABLY MILK-BORNE.

P. A. TETRAULT.

MILK-BORNE EPIDEMICS IN GENERAL.

Milk-borne epidemics, as a rule, show certain characteristics which distinguish them from all other epidemics.

1. A very sudden outbreak and a gradual decline.
2. The first cases appear among milk users.
3. The severity of the outbreak depends on the distribution of the infected milk and the amount of infection present in the milk.
4. The length of the epidemic varies with the period of incubation of the disease, the length of time the milk is infected, and contagiousness of the disease.
5. Secondary cases very often occur.

THE DUBLIN EPIDEMIC.

On August 5, 1913, there broke out in Dublin, N. H., an epidemic of diarrhœa exhibiting all of these above-named characteristics. At first the outbreak was localized along one milk route, but soon became general and spread throughout the entire community. During the first few days of the epidemic there was a sudden rise in the number of cases reported and the total jumped from a few cases to thirty-one, all of which were in households taking milk from this one milkman.

The Dublin Chemical and Bacteriological Laboratory had been making routine bacteriological tests of all the milk sold in Dublin. On August 4th the milk from this particular barn was found to be infected with *B. coli*. Up to this time the total count had been very low, with absence of coli and streptococci. Immediately a survey of the barn and surroundings was made and the following data collected:

Two members of the family had had diarrhœa on the evening of August 3d. One of these persons handled the milk in the milk room.

An open privy, which had been overlooked up to this time, was discovered in the horse stable immediately adjoining the milk room. Flies were in great abundance, and it was admitted by a member of the family that they were frequently found in the milk room.

The milk continued to show coli until August 8th, when it cleared up entirely.

THE NATURE OF THE DISEASE.

The disease showed a very rapid onset accompanied by pain, high temperature, nausea and vomiting. Diarrhœa always followed. Secondary cases were numerous, especially among children.

THE SPREAD OF THE EPIDEMIC.

Until about August 12th, all cases occurred along the suspected milk route. Over 60 per cent. of these milk users were infected. On that date one of the neighbors of an infected household came down with the disease. From then on the contagion spread from one family to another, probably through contagion, until nearly every home in the community had or had had the disease.

Nothing was done to investigate the causes, although the State Board of Health was asked to look over the situation.

It might be said, to eliminate as many probable causes as possible, that the town of Dublin does not have a common water supply. Most of the water comes from driven wells or from the lake. Dublin is a summer resort and everything is done to keep the town in as sanitary a condition as possible.

CONCLUSION.

The epidemiology of this outbreak has not been studied carefully enough to permit us to draw any positive conclusions. I have tried to show the relation of the epidemic to the milk infected with coli. The evidences seem to incriminate the milk, although a positive diagnosis of a milk-borne epidemic cannot be reached from the data at hand.

ON THE VERTICAL DISTRIBUTION OF THE PLANKTON IN WINONA LAKE.

GLENWOOD HENRY.

During the summer of 1912, while studying at the Biological Station of Indiana University, I undertook to make a quantitative determination of the vertical distribution of the plankton in Winona Lake. A study was also made of the significant physical and chemical conditions associated with it. The lake was mapped by A. A. Norris ('02), and some of its physical features were considered by Juday ('03).

Winona Lake is a small temperate lake of the deeper type. Its maximum length is 1.4 miles. Its maximum width is 1.2 miles and its maximum depth is 81 feet. It is large enough to present all of the usual plankton problems and small enough to make their study at critical times easily possible. All forms taken were determined, at least generically, and their abundance estimated. The exact quantitative work was limited to the eleven genera and groups, *Ceratium*, *Tribonema*, *Anabaena*, *Diatomus*, *Fragilaria*, *Microcystis*, *Lyngbya*, *Cyclops*, *Nauplii*, *Cladocera*, and *Rotifera*. The *Cladocera* were represented by the following forms: *Daphnia hyalina*, *Daphnia pulcr.*, *Daphnia retrocurva*, *Chydorus*, *Bosmina*, *Pleuroxus procurvatus*. The following *Rotifera* were identified: *Anuraea cochlearis*, *Anuraea aculeata*, *Notholca longispina*, *Brachionus pala*, and *Hexarthra polyptera*. Weekly catches, July 11th to August 13th, were taken of the eleven forms at ten levels, ranging from surface to 23 meters. The temperature, also the amount of dissolved oxygen, carbon dioxide, and carbonates were determined for the different depths.

I desire to express my thanks to Dr. Will Scott, acting director of the Station, for the many courtesies and helpful suggestions extended to me in the collection of the data for this paper. Scott Edwards made the temperature observation and G. N. Hoffer determined the dissolved gases. To these gentlemen I am under obligation for permission to use these data.

PHYSICAL CONDITIONS.

Turbidity.

The turbidity of the lake was determined by means of a Seechi's disk. The water was clearest on July 24th, when the disk disappeared at 4 m. The minimum depth, 2.7 m., occurred several times during the summer.

Temperature.

Temperature readings were made by means of a thermophone, and were taken simultaneously with the plankton catches. The temperature of the surface water, during the summer, varied from 21° to 26° C. At the bottom of the lake, only a slight variation ranging from 8.3° C. to 9° C. occurred. The thermocline was about 6 or 7 m. in thickness. The epilimnion was 5.5 m. thick on July 1st; by the middle of August it had descended to 14.5 m. This descent of the thermocline was associated with the high wind and cloudy days of the latter part of August. The average vertical readings are given in the accompanying temperature graph. They were taken in the deepest part of the lake at various times during the day.

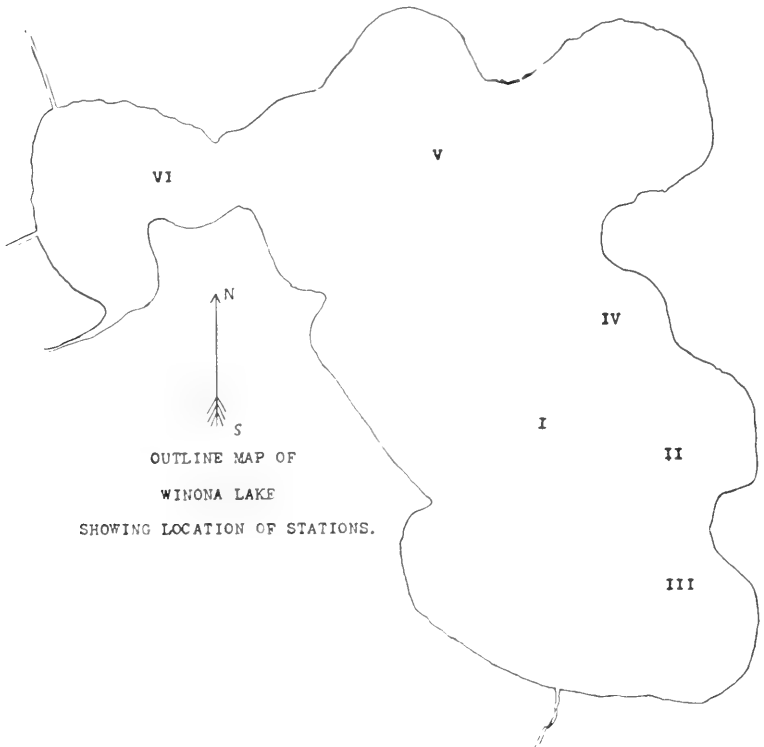

Weather.

The summer of 1912 exhibited very unsettled weather conditions in the vicinity of the lake. Strong winds prevailed much of the time, especially

during the month of August, and heavy rains often raised the surface of the lake several inches above its normal level. The winds, which were generally accompanied by cloudy weather, blew the surface of the water into waves of considerable magnitude for a small lake, and caused a piling up of the surface water on the leeward side. Detailed records cannot be given because the only anemometer available was adapted to winds of low velocity only, which rendered it useless during the high winds which prevailed.

Dissolved Gases.

A study of the dissolved gases revealed the fact that there was sufficient carbon dioxide present for photosynthesis, and that oxygen was present in sufficient quantities to support animal life at all depths. At the surface of the lake there were 5 c. c. of dissolved oxygen per liter; in the upper layer of the epilimnion there were 4.25 c. c. present; in the middle of the thermocline 2.35 c. c., and at the bottom of the lake there was 1.5 c. c. of dissolved oxygen per liter of water.

The carbon dioxide increased from .8 c. c. at the surface to 8.75 c. c. at the bottom. It increased from 2.5 c. c. to 5.5 c. c. from the top to the bottom of the thermocline.

METHOD USED IN PLANKTON CATCHES.

Six stations, position of which are indicated on the outline map, were established. They were located in positions which best showed the effect of the wind upon the plankton. The depths of the stations varied from 7.5 to 23 m. The catches for this report were mostly made at Station 1, depth 23 m., the other stations being used as a check upon the results obtained at that station. Weekly catches were made by the use of a brass pump, known in the trade as "The Barnes Hydroject Pump," a three-fourths inch garden hose, and a plankton net, the straining part of which was made of No. 20 Dufour bolting cloth. These weekly catches were taken respectively at the surface, 1 m., 2 m., 4 m., 6 m., 8 m., 10 m., 14 m., 20 m., and 23 m. The quantity of water, 10.4 liters, strained for each catch, was the amount produced by 50 strokes of the pump. The ordinary counting method was used to determine the number of organisms. In most cases 20 per cent. of the material was counted, but all individuals of forms readily recognized by the naked eye were counted.

PLANKTON DISTRIBUTION IN REFERENCE TO THE EPIILIMNION, THERMOCLINE, AND
HYPOLIMNION.

Seventy-four and six-tenths per cent. of the plankton inhabited the epilimnion. The per cent. of the eleven forms studied quantitatively are: *Rotifera* 87.4, *Lyngbya* 80.7, *Ceratium* 88.6, *Microcystis* 76.5, *Anabaena* 84.8, *Tribonema* 64.3, *Nauplii* 60.5, *Diaptomus* 71.2, *Fragilaria* 76.7, *Cyclops* 38.8, *Cladocera* 31.6.

Seventy-three and three-tenths per cent. of the phytoplankton and 83.3 per cent. of the zooplankton inhabited the epilimnion.

The thermocline contained 21.8 per cent. of the plankton of the lake. The following synopsis gives the per cent. of each of the eleven forms: *Diaptomus* 23.8, *Fragilaria* 19.5, *Cyclops* 34.4, *Cladocera* 40.7, *Tribonema* 26.6, *Nauplii* 18.7, *Microcystis* 20.3, *Anabaena* 14.4, *Ceratium* 10.3, *Lyngbya* 18, *Rotifera* 10.8. Of the zooplankton 12.3 per cent., and of the phytoplankton 22.6 per cent. lived in the thermocline.

The hypolimnion contained 3.5 per cent. of the plankton, 4.3 per cent. of the zooplankton, and 3.4 per cent. of the phytoplankton. The per cent. of each form in the hypolimnion was: *Cladocera* 27.7, *Cyclops* 26.7, *Fragilaria* 3.5, *Nauplii* 20.8, *Diaptomus* 5, *Anabaena* .8, *Tribonema* 9.1, *Microcystis* 3.2, *Lyngbya* 1.1, *Rotifera* 1.7, *Ceratium* 1.1.

At 23 m. there were more forms per liter than at 20 m. This was probably due to the presence of some dead organisms that by the loss of activity had sunk to the bottom. The end of the hose at 23 m. was very close to the bottom.

THE EFFECTS OF PHYSICAL FACTORS UPON DISTRIBUTION.

The large per cent. of plankton in the epilimnion was due to the presence of sunlight and plenty of food. In the upper half (best lighted part) of this stratum, there was sufficient carbon dioxide to permit rapid photosynthesis. Apstein ('96) found light to be the most important factor in explaining the presence of fifty-six times as much plankton from 0-2 m. as in the remainder of the water. That direct sunlight has a repelling effect upon some plankton, was demonstrated by the fact that 53 per cent. inhabited the first two meters, while only 12 per cent. lived at the surface, *i. e.*, in the surface meter. Other factors enter into the explanation of the prolific life in the epilimnion. Many organisms were too heavy to sink into the cold heavy waters of the thermocline. Juday in his work on the Wisconsin

Lakes, determined that the vast amount of algae collecting at the top of the thermocline, at certain times, so increased the process of photosynthesis, that 300 per cent. oxygen saturation occurred. It is also to be remembered that the lowering of the thermocline in August increased the depth of the epilimnion one meter.

Four factors must be taken into consideration in accounting for the rapid decrease of organisms below the epilimnion: First, the lower temperature (20° C. at the top of the thermocline and 9.6° C. at the bottom during July, 21.1° C. and 10.7° C. respectively being the average temperatures for August); second, the decrease in the amount of oxygen from 4.25 c. c. per liter of water at six meters to 2.50 c. c. at the bottom of the thermocline; third, the decrease in the amount of food; and, fourth, the limited amount of sunlight.

In the hypolimnion the physical conditions were so uniform that the plankton was very evenly distributed in this stratum.

SEASONAL DISTRIBUTION OF THE PLANKTON.

Six weeks is too short a time to obtain results of much value concerning seasonal distribution. However, the data collected indicate the following facts: The plankton, as a whole, increased in amount in August. *Ceratium*, *Fragilaria*, *Microcystis*, and *Lyngbya* increased gradually to August 13th, the date of the last observation. *Diaptomus* reached its maximum August 1st; *Nauplii* and *Anabacna* on August 5th. The *Cladocera* and *Rotifera* increased rather suddenly in August and were most numerous on the date of the last collection.

THE EFFECTS OF WIND UPON DISTRIBUTION.

As mentioned earlier in this paper, six stations were established to determine whether or not the plankton of the whole lake at a given level was homogeneous at all times. Repeated catches at different stations under ordinary conditions indicate that the plankton at the different levels was uniform.

SUMMARY.

Oxygen sufficient for respiration occurs at all levels of the lake, and probably is not a limiting factor.

Carbon dioxide was present in sufficient quantities for photosynthesis.

The epilimnion contained 74.6 per cent. of the plankton, the thermocline 21.8 per cent. and the hypolimnion 3.5 per cent.

Plankton was more abundant in August than in July.

So far as these observations go, wind has no appreciable effect upon the distribution of the plankton.

EXPLANATION OF FIGURES.

Figures 1 to 15, inclusive, indicate the distribution of the organisms. The numbers at the bottom indicate the date.

Figure 16 shows graphically the amount of dissolved gases at different depths.

Figure 17 indicates the maximum, minimum, and average temperatures.

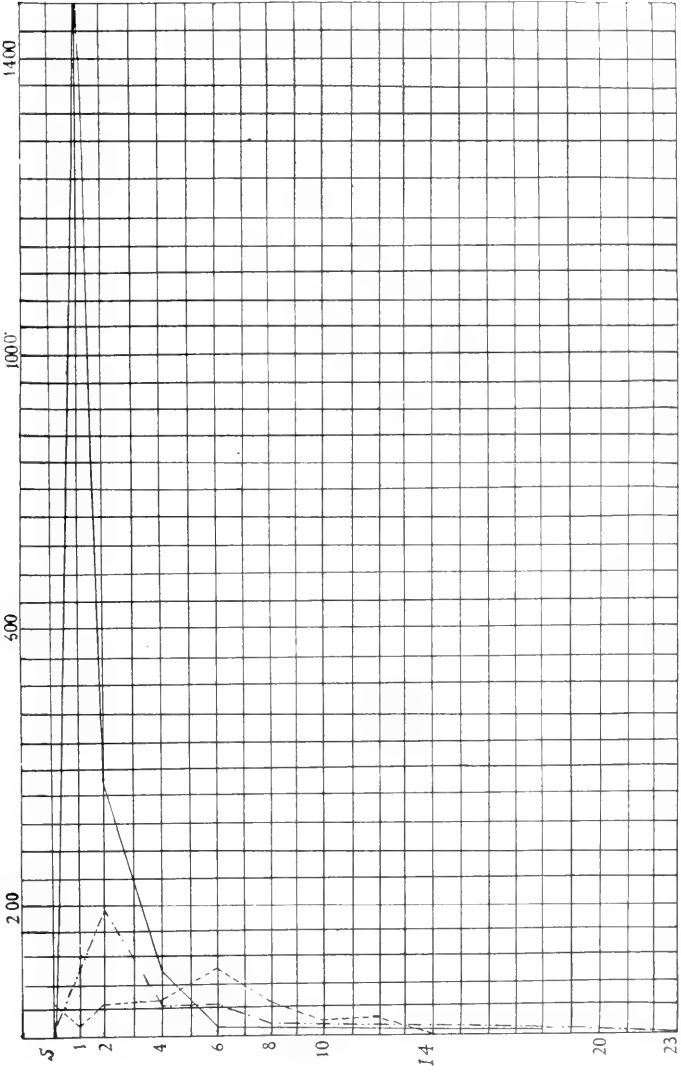

Fig. 1. --- Ceratium.
7-11. - - - - -
8-1. - · - · -
8-13. ·····

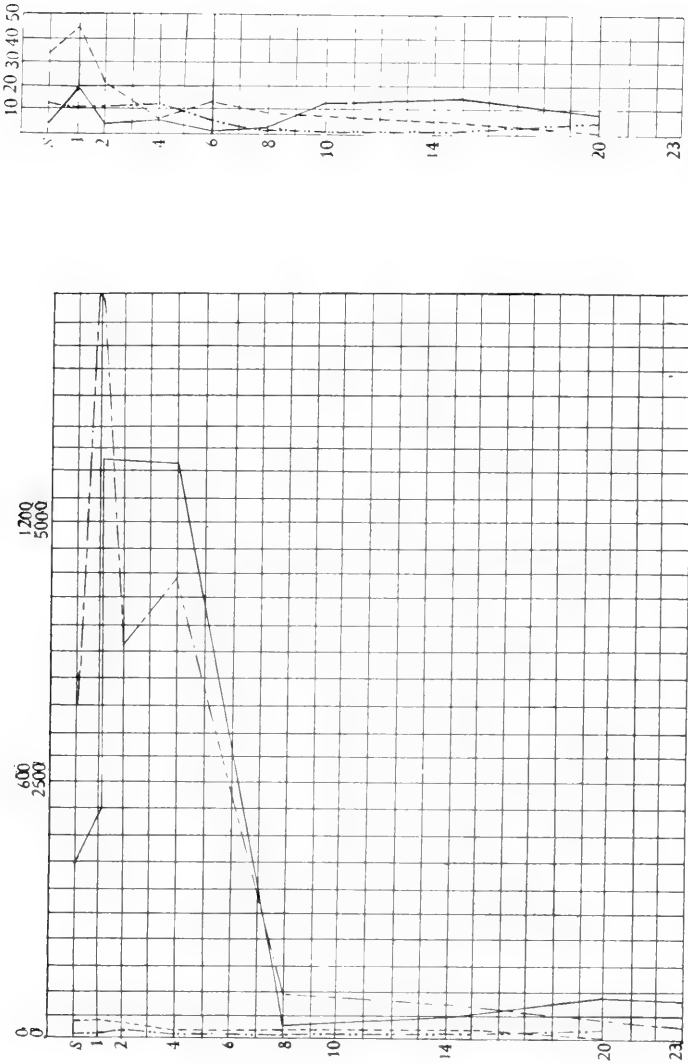

Fig. 2. --- Fragilaria and Microcystis.
 Fragilaria. 7-11.
 Fragilaria. 8-13. -----
 Microcystis. 7-11. -----
 Microcystis. 8-13. ——

Fig. 3. --- Nauplius.
 7-11.
 8-13. -----
 8-13. ——

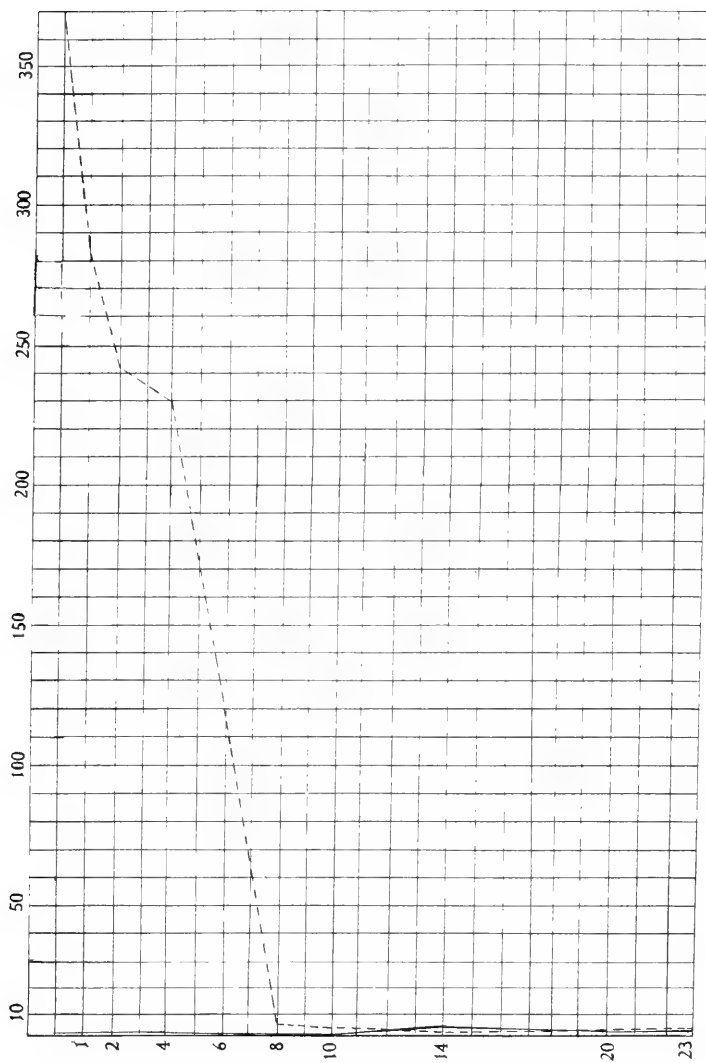

Fig. 4. --- Anabaena.

7-11. ———

8-8. - · - · -

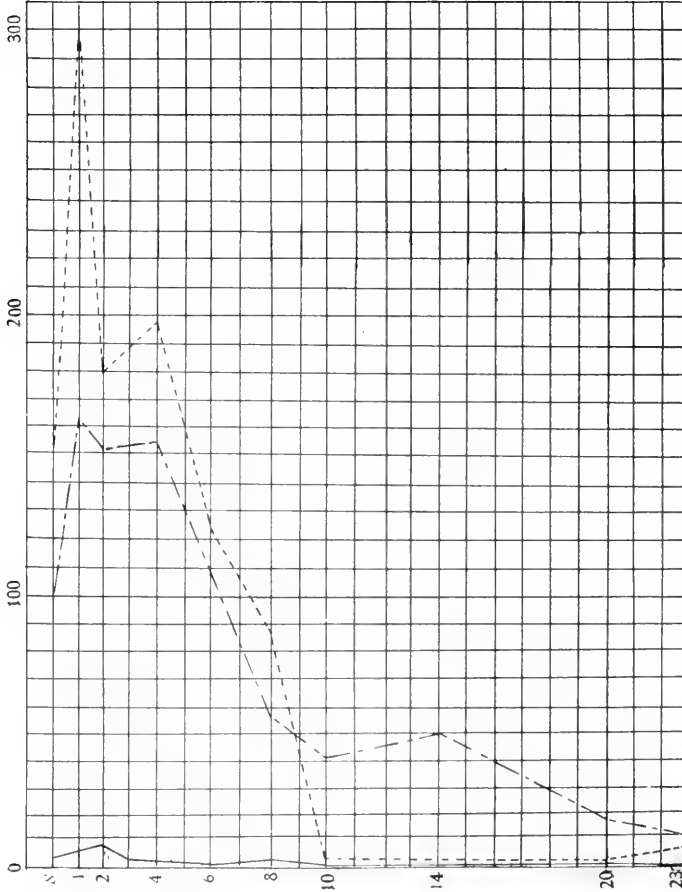

Fig. 6. --- Sribonema.
 7-11. -.-
 8-8. -.-
 8-13. —

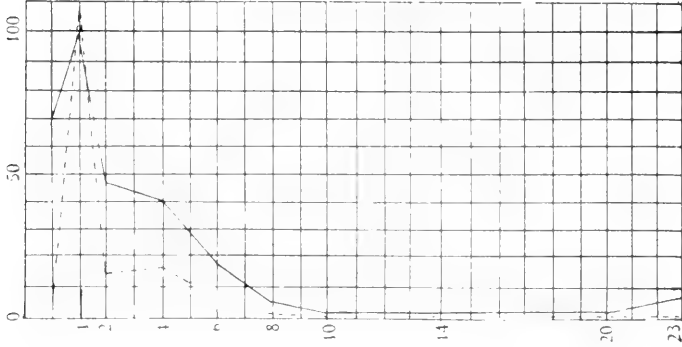

Fig. 5. --- Lyngbye.
 7-11. -.-
 8-8. -.-
 8-13. —

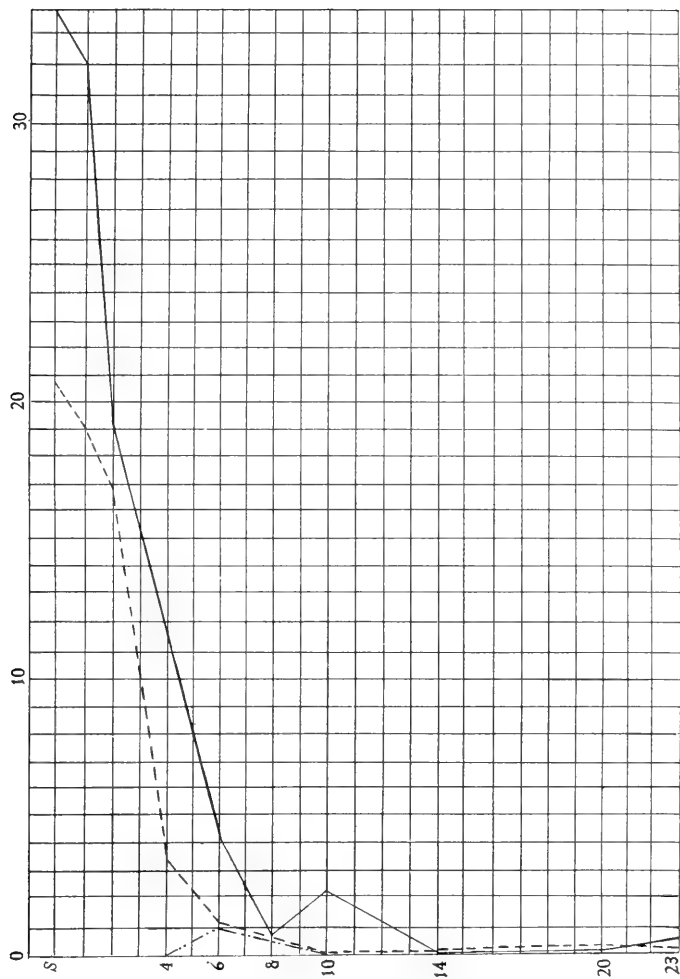

Fig. 8. --- Rotifera.
 7-11. ·····
 8-8. - - - -
 8-13. ———

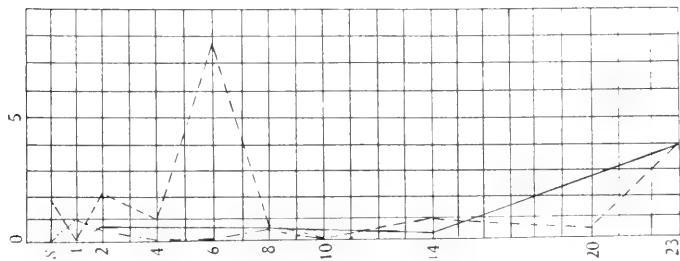

Fig. 7. --- Cladocera.
 7-11. ·····
 8-8. - - - -
 8-13. ———

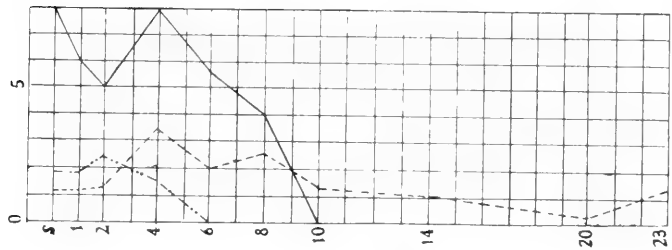

Fig. 9. --- Diaptomus.

7-11.
 8-6. ---
 8-13.

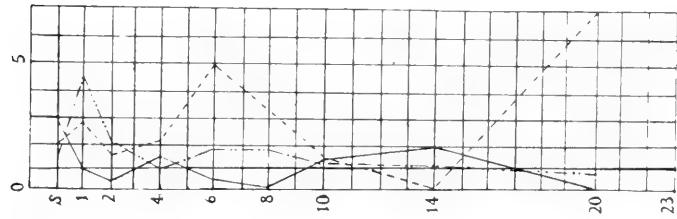

Fig. 10. --- Cyclops.

7-11.
 8-6. ---
 7-18.

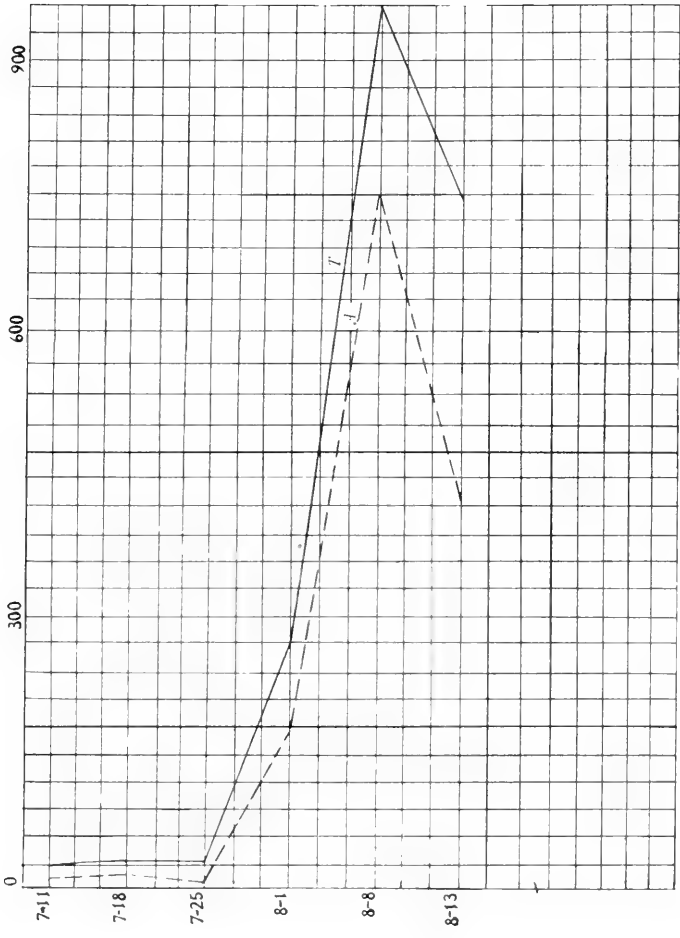

Fig. 11. --- Tribonema and Anabaena.
 Tribonema.
 Anabaena. ---

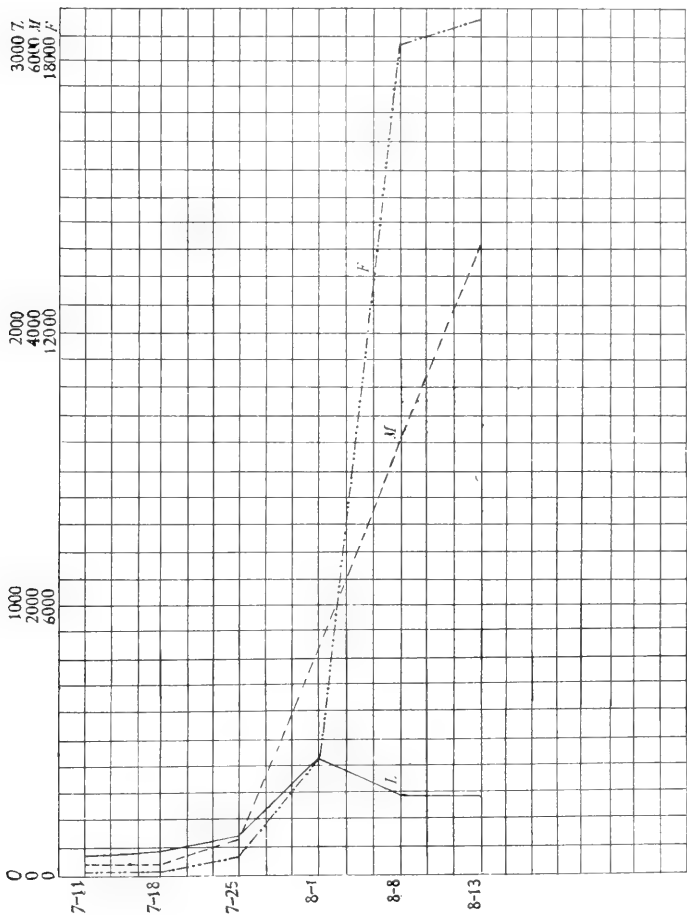

Fig.12. ---Fragilaria, Microcystis, and Lyngbya.
 Fragilaria ----Microcystis----Lyngbya

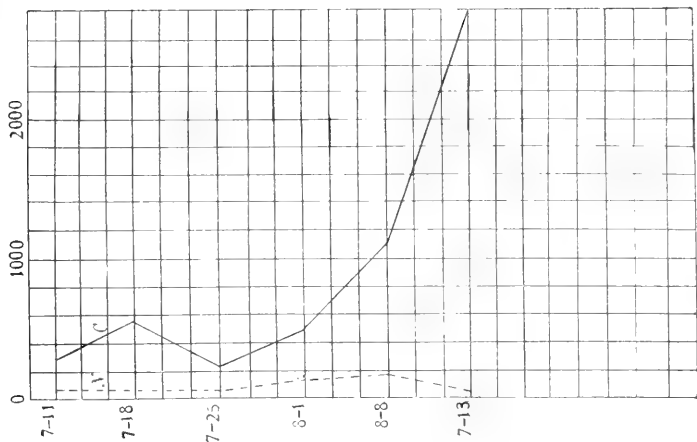

Fig.13. --- Ceratium and Nauplii.
 Ceratium. ---- Nauplii. ----

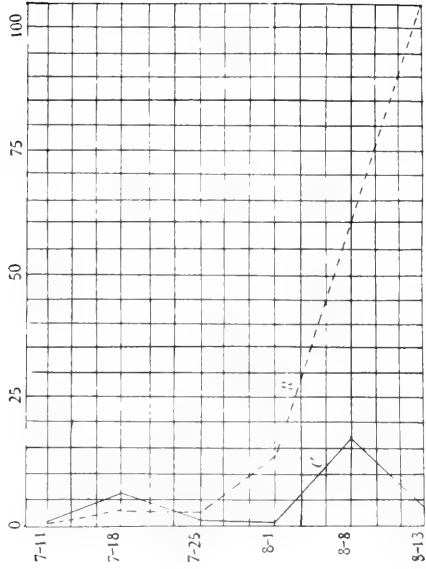

Fig. 15. --- Cladocera and Rotifera.
Cladocera. --- Rotifera.

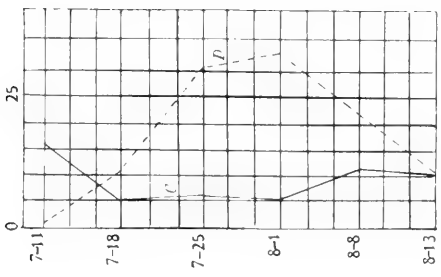

Fig. 14. --- Diaptomus-Cyclops
Diaptomus. --- Cyclops.

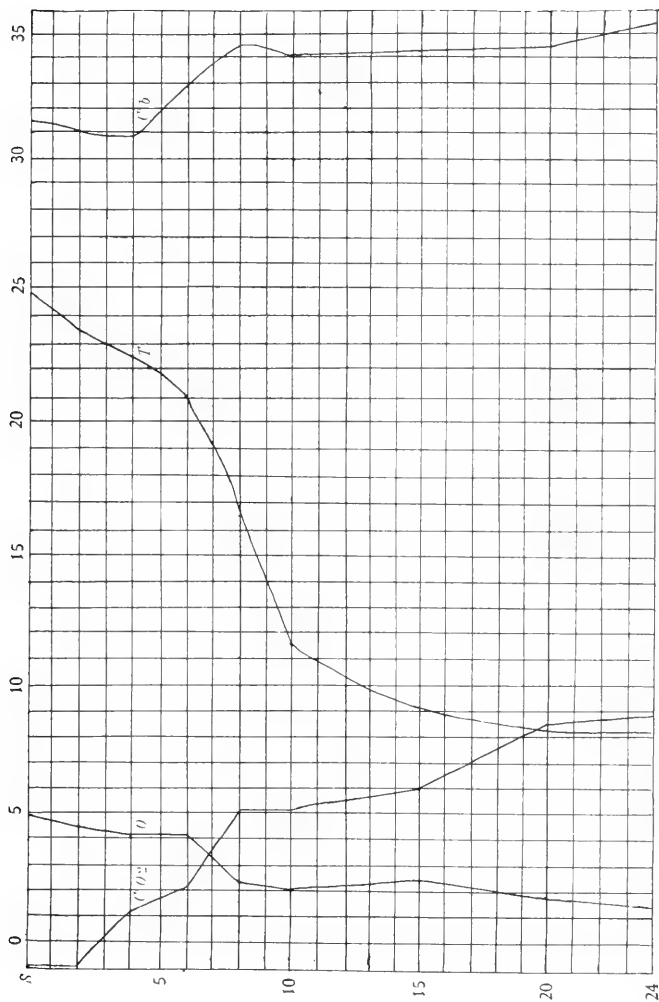

Fig. 16. *Chemical* chart of Winona Lake, Aug. 21, 12. (By George E. Hoffer)

Scale, 1 Vertical space=1 meter. CO

CO, = read in cc per liter.

O = " " " "

T = " " " " Centigrade

Ch = " " " " grams per liter.

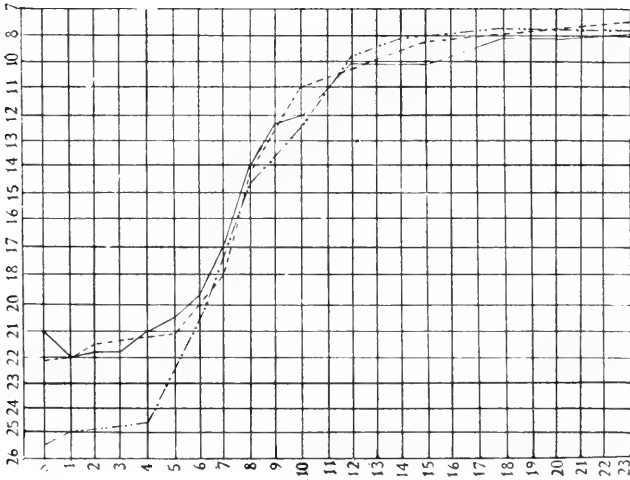

Fig 17 Seasonal Temperature Graph.
 Horizontal spaces=degrees of temperature.
 Vertical spaces=depth in meters.
 Average temperature. ———
 Maximum temperature - - - - -
 Minimum temperature ———

A SIMPLE APPARATUS FOR THE STUDY OF PHOTOTROPIC RESPONSES IN SEEDLINGS.

GEO. N. HOFFER.

- - - - -

The purpose of this apparatus is to determine the minimum quantity of light, acting as a lateral stimulus, that will produce a curvature response in seedlings of various kinds as well as some of the fungi, such as *Phycomyces* and *Pilobolus*.

Any kind of light may be used, but in the comparative studies I use direct sunlight. The quantity of light is regulated by opening and closing an iris diaphragm with various-sized apertures for definite lengths of time.

The apparatus is made from a microscope carrying case. As shown in the photograph, Fig. 1, the outside attachments are the drawtube and rack and pinion of a microscope removed from the base and attached to one side of the box. The tube works through a hole in the side of the box. The opening is made light proof by a velvet collar, Fig. III, VC, glued to the rim and held to the tube of the scope by rubber bands.

Into another hole is fitted a hemispheric, revolving iris diaphragm, Fig. III, I. This is on the adjacent side of the box close to the microscope and on the same level with the objective of the microscope. A mirror is attached to the box to reflect light directly into it through the iris and onto the plant. A micrometer eyepiece in the microscope is the index by which all of the readings are made. The illumination for the readings is supplied by the light which passes through the bottle, Fig. III, K, into a solid glass rod, SG, and conducted by the rod to within a half inch of the plane in which the plant is held and ends directly opposite to the objective of the microscope. This glass rod should be approximately one-half of an inch in diameter so as to present a field of sufficient size.

The bottle contains a saturated solution of bichromate of potassium in water. This solution is to absorb the active blue-violet rays of light. The glass rod is covered with black tape, Fig. III, T, and the opening into the box through which the rod extends is sealed against the admission of light

by a velvet collar. A black cardboard collar, Fig. III, BC, slips over the bottle and rests upon the platform below the bottle. A piece of white cardboard on the platform serves as a reflector for the light entering the bottle. It is this dull red light which is carried to the objective of the microscope and used to make the readings. This light enters only when making the readings and has not, in the number of cases tried, produced any stimulus that would effect the experiment and alter the response to the normal light stimulus. However, I have yet to try experiments on *Phalaris*.

The internal construction of the box, Fig. II, consists merely of a vertical rod on which works a burette clamp. The rod is so placed that a test tube containing the plant under study can be adjusted easily into position opposite both the iris and the objective of the microscope. The door of the box is fitted with strips of velvet so as to make it light proof.

To use the apparatus, seedlings are grown in soil, sawdust, etc., in test tubes in the dark room. These culture tubes should always be held in a vertical position while being adjusted in the box for study. The box is "loaded" in the dark room and the plants placed so as to be in the field of the microscope. The iris is closed and the door of the box is locked. The plant is then brought into focus using the illumination secured by raising the collar, BC, to a sufficient height and thus permitting the reflected light to enter the bottle from below. Readings are taken at intervals of several minutes before opening the iris in order to be certain that no geotropic stimuli other than the normal are acting. When no readings are being taken the collar rests upon the platform.

The plant is then laterally stimulated by opening the iris to any desired size for a definite length of time. The mirror reflects the light through the iris onto the plant.

The microscope is kept covered at all times with a photographer's focusing cloth. All of the readings are made under this cloth. This prevents any light from passing through the microscope and being focused onto the plant.

To record the results a graphic record may be made, using the ordinates to denote the extent of curvature in spaces on the micrometer eye-piece, and the abscissas to denote the time of stimulation, or presentation period, the latent period, and the length of time for the completion of the response. Figure IV illustrates such a record:

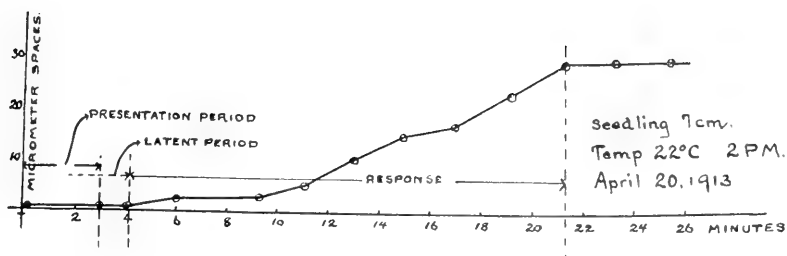

Fig. IV. Study of *Arena sativa*.

The ventilation of the box is unimportant for the short periods required for each study. A wet sponge placed inside of the box serves to keep the air moist. The temperature of the apparatus can also be recorded and all tests made under equitemperatures.

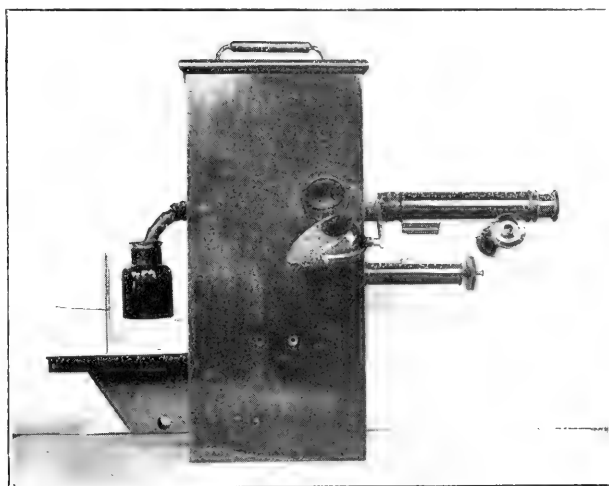

Fig. I. External View of Apparatus.

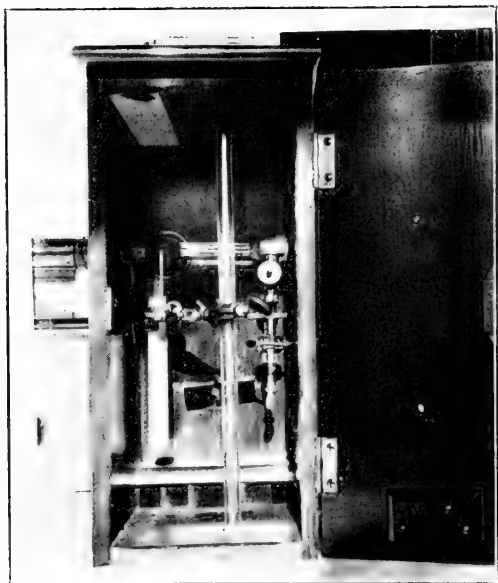

Fig. II. Internal View of Apparatus.

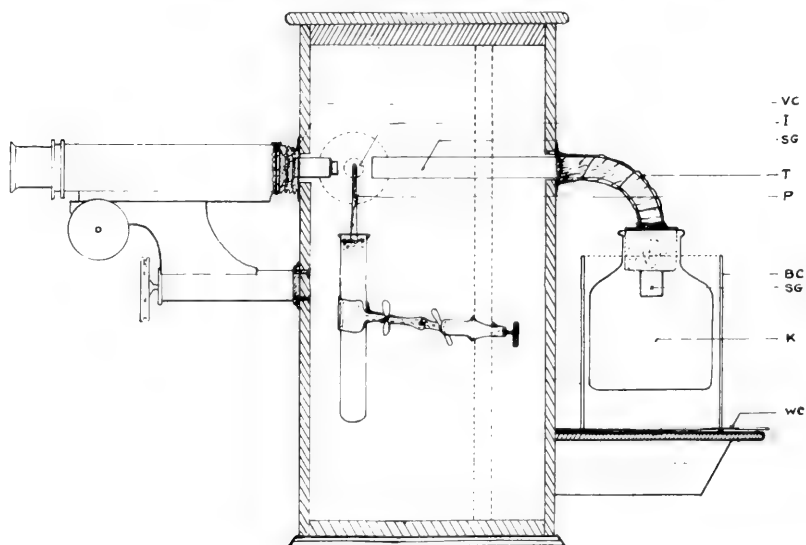

Fig. III. Cross section of the apparatus to show the position of the plant and its relation to the microscope and the glass rod; VC, velvet collar sealing the aperture through which the microscope works; I, the iris diaphragm; SG, the glass rod; T, tape covering the glass rod to make it light proof; P, the plant; BC, the collar which slips over the bottle; K, the bottle containing the saturated solution of bichromate of potassium; WC, the white cardboard to reflect light into bottle.

A TEST OF INDIANA VARIETIES OF WHEAT SEED FOR FUNGOUS INFECTION.

GEO. N. HOFFER.

"Indiana grows annually more than 2,500,000 acres of wheat. The average yield for the past ten years has been 15.1 bushels per acre. — *Op.* No. 23, Purdue University Agr. Exp. Sta.

The economic significance of any factor which plays a part in causing a decrease in the quantity of the yield, even though this decrease may be represented by a fractional part of one per cent. of the yield, is considerable. The mere presence, then, of internally infecting fungi in the wheat seed studied in the laboratory may be indicative of very important problems in the field.

In Bulletin No. 203 of the Ohio Agricultural Experiment Station, T. F. Manns has described a method for detecting fungi internally infecting wheat and other small grain. The method in brief, consists in sterilizing the outside of the grain by means of a solution of corrosive sublimate in 50 per cent. alcohol and then placing the seeds in sterile petri dishes on agar-agar. This allows germination of the plant embryo when viable. Cultures or growths of the fungi surviving internally in the seed develop at the same time. The fungi in these cultures can then be identified.

The results of laboratory tests at the Ohio station "show an amazing amount of disease transmission in seed wheat as well as the proof of scab infection by both germinating and dead wheat kernels." A study of field conditions showed "that many seedling wheat plants were killed by the scab fungus (*Fusarium roseum*) conveyed in the seed or retained by the soil." This verified the laboratory conclusions.

In the report of the botanist of the North Dakota Agricultural Experiment Station for 1911, Dr. H. L. Bolley concludes from the results of numerous tests of seeds that "our experiments, taken as a whole, tend to prove definitely that the soil is not often materially depleted, but that the deterioration in yield and quality of grain is more specifically to be assigned to troubles caused by internal seed infection and soil infection."

The genera of fungi which Bolley regards as being of pathogenic interest are *Colletotrichum*, *Fusarium*, *Helminthosporium*, and possibly *Macrosporium*.

In Circular No. 3 of the Purdue University Experiment Station the statement is made that "the average (yield of wheat) on the station farm for the past twenty-five years has been 28.04 bushels per acre." This is nearly thirteen bushels above the average for the state.

The question naturally arises, knowing the results obtained elsewhere by studies of the internally infecting fungi of seed wheat, whether Indiana varieties taken at random from a single locality may be similarly infected?

Following the method used by T. F. Manns, thirty-four different varieties of wheat seed were tested by me. I shall summarize briefly the results of the test and hold them tentatively against further studies on both the wheat plants and seed.

Of the thirty-four varieties, fourteen were free from fungi of any kind. Thirteen of the varieties were found to be infected with a *Fusarium*. Four of the varieties showed an internal *Macrosporium*, and three varieties showed both a *Fusarium* and *Macrosporium* infection.

The meagerness of these data, however, precludes the formation of any definite conclusions, but does indicate a fertile field for study.

PYROPOLYPORUS EVERHARTII (ELLIS & GALL.) MURRILL
AS A WOUND PARASITE.

GEO. N. HOFFER.

During the fall of 1912 and the spring of this year many observations of various species of oaks infected with *Pyropolyporus Everhartii* were made by my class in forest pathology working in the vicinity of Lafayette, Indiana. The finds from the first were very interesting because of considerable deformation of trees of *Quercus imbricaria* Mich.

The fungus is reported in Bulletin No. 149 of the Bureau of Plant Industry. Here it is described as a wound parasite on *Quercus marylandica* Muench., blackjack oak. Murrill describes the fungus as attacking living trunks of *Quercus nigra* and *Fagus* species. In a recent communication G. G. Hedgecock tells me that the fungus is very common in the lower Mississippi valley. In Phytopathology, Vol. 2, No. 2, Mr. Hedgecock records the hosts for this fungus. The list includes all of the oak species upon which I found the fungus with the exception of *Quercus alba* L. This species is a new host in this locality.

Plate I shows a number of sporophores from three different hosts. Plate II shows the bole of a *Quercus imbricaria* badly deformed. Large knotty growths have developed and, in the centers of these, sporophores have formed. Plate III shows a sporophore developing on a living tree of *Quercus velutina* Lamarck. Plate IV shows a stub of a killed tree of *Quercus alba* L.

The other species upon which the fungus has been found in this vicinity are *Quercus rubra* L. and *Quercus macrocarpa* Michaux. The effect on these trees has been generally the killing of branches of the trees.

The distribution of the fungus within the state has not been worked out. It has been observed by me in Kosciusko County during the past summer. The species upon which I found it in this locality was *Quercus velutina* Lam. It was frequently found on both dead and living trees. Examinations of some of the dead trees showed no signs of borer attacks.

From these observations I believe that the fungus may be of considerable economic importance within the state.

The photographs from which the plates have been made were taken by P. H. Teal, class of 1913, Purdue. Mr. Teal made a study of the fungi affecting the oaks in this country as his thesis subject.

PLATE I

considerable
large knots
of Quercus
in the vicinity
of these
worked
and some
years ago
obtained
considerable
amount
of fungi

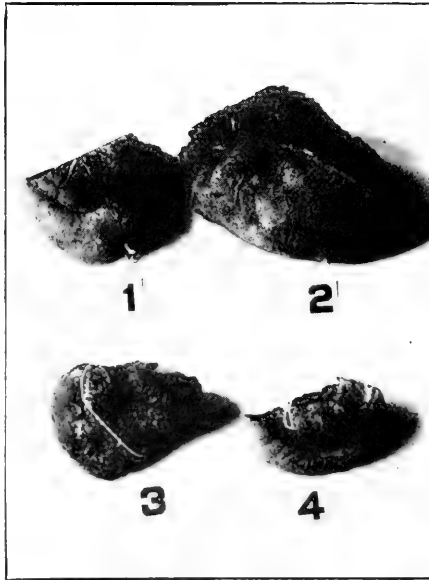

Plate I. Sporophores (1 and 2) from Quercus imbricaria; (3) from Quercus rubra; (4) from Quercus velutina.

of Quercus
in the vicinity
of these
worked
and some
years ago
obtained
considerable
amount
of fungi



Plate II. Tree of Quercus imbricaria Attacked by Fungus.



Plate III. Sporophores on *Quercus velutina*.



Plate IV. Stub of *Quercus alba* with Fungus.

THE MOSSES OF MONROE COUNTY, INDIANA, II.

MILDRED NOTHNAGEL AND F. L. PICKETT.

At the winter meeting of the Indiana Academy of Science in 1912 the authors presented a list of the mosses of Monroe County, made up principally of fall-fruiting forms. That list appears in the Proceedings for 1912, pp. 69-75. In the spring of 1913 the collection and identification of the mosses in the neighborhood of Bloomington was resumed. The following list is the result of that work and includes fourteen new species, among which are representatives of one family and three genera not represented in the previous list.

Material has been prepared, as described in the former paper, and left in the herbarium of the Botanical Department of Indiana University. Full notes of habitat, time and locality of collection, as well as of condition of the specimens, are on file to make the material of value for comparison. In this, as in the previous list, the numbers in parenthesis after each specie indicate the accession numbers in the herbarium.

In this list some species are included which were in the former list. This has been done to indicate noteworthy differences in time of fruiting, or of habitat, and to show the herbarium numbers of such species as were not given numbers in the first list.

To those interested in making permanent collections, the following plan for preparing microscopic slides of species for convenient reference and examination may be of use. The dissections of leaves from different parts of a plant as well as peristome, operculum and calyptra, are mounted in a 10 per cent. glycerin solution in water for examination. If satisfactory, the slide, with the specimens well covered with the dilute glycerin, is carefully protected from the dust until the glycerin is concentrated. Then a cover glass on which a small piece of glycerin-jelly has been melted is carefully placed on the previously warmed slide. Such mounts are very convenient for quick reference, and are quite firm if covers at least 22 mm. by 32 mm. are used. In the writers' collections the quick reference to such prepara-

tions is further facilitated by giving the slides the same accession numbers as the regular herbarium specimens.

Doubtful specimens have been sent to Dr. A. J. Grout of Brooklyn for identification, and due notice given in the list.

Order. BRYALES.

Suborder NEMATODONTE.E.

Family *Polytrichaceæ*.

Polytrichum Commune L. (105).

P. Ohioense R. & C. (106).

Suborder ARTHRODONTE.E.

Family *Fissidentaceæ*.

Fissidens taxifolius (L.) Hedw. (77). Determined by Dr. Grout.

Mature spores in late fall and winter. Dark green mats on clay, Huckleberry ravine. Common.

Family *Dicranaceæ*.

Ditrichum pallidum (Schreb.) Hampe. (111). Mature spores in May. Dense yellow-green tufts on clay, dry wooded hillsides, common.

Family *Grimmiaceæ*.

Grimmia apocarpa (L.) Hedw. (70). Mature spores in March and April. On limestone slabs and cliffs forming almost black cushions, abundant.

Family *Tortulaceæ*.

Weisia viridula (L.) Hedw. (72). Mature spores in April, abundant.

Barbula unguiculata (Huds.) Hedw. (103). Spores mature from late fall to early spring.

Family *Funariaceæ*.

Funaria flavicans Mx. (79). Mature spores in April. Rare.

F. hygrometrica (L.) Sibth. (101). Mature spores in May. Common.

Physcomitrium immersum Sulliv. (122).

Family *Bryaceæ*.

Bryum capillare L. (112). Mature spores in July. Occasional on wooded hillsides.

B. intermedium Brid. (108). Mature spores in May. On limestone wall of Oolitic Stone Mills Company's reservoir.

Mnium affine Rand. (83). Determined by Dr. Grout. Mature spores in April. On damp soil in Huckleberry Ravine. Not common.

M. rostratum Schrad. (92). Sterile. Rare, on very damp rocks or in running water.

Family *Hypnaceæ*.

Amblystegium fluviatile (Sw.) B. & S. (98). Mature spores in May. Light green tufts in running water; common, but rarely found fruiting.

A. kochii B. & S. (80). Mature spores in April. Common. Indiana University campus.

A. orthocladon (P. B.) Kindb. (107). Mature spores in May. On stones in running water, common.

A. varium (Hedw.) Lindb. (81, 99). Thin, loose mats with light green branches; on soil; common. Mature spores in April.

Family *Leucodontaceæ*.

Forsstroemia trichomitria (Hedw.) Lindb. (119). High on living *Juglans cinerea* near I. U. water-works reservoir. Mature spores from late summer to midwinter.

Indiana University Botanical Laboratory.

ECOLOGICAL NOTES ON CERTAIN WHITE RIVER ALGÆ.

PAUL WEATHERWAX.

During the summer of 1913, while assisting in a sanitary survey* of the West Fork of White River, the writer took advantage of the opportunity to make a study of the algæ in the stream. The work was begun at Martinsville, Ind., near the close of June, and ended at Mt. Carmel, Ill., about the middle of September, more or less hurried investigations being made along the river near several of the larger towns.

Only such forms were considered as were present in quantities sufficient to be conspicuous to the unaided eye, no attempt being made to secure specimens by filtration. The striking condition was the general scarcity of algæ, especially along the lower part of the river.

For four or five miles in the neighborhood of Martinsville the shallow parts of the river were choked with a growth of *Cladophora glomerata* Kg. and *Hydrodictyon utriculatum* Roth.; and large masses composed of species of Oscillatoria, Desmids, and Diatoms were continually floating down the river. This material had evidently been broken loose from where it had grown further up the river or some of its tributaries, for it did not continue in a growing condition but eventually broke up and disappeared. The *Cladophora* gradually became less noticeable in the deeper water a few miles below Martinsville and was afterwards seen only occasionally and in small quantities. The *Hydrodictyon* was in well-defined locations in water that was comparatively quiet, and, although it was rapidly reproducing, and the young nets were seen floating even far below Spencer, it apparently did not find suitable conditions for growth far below Martinsville. *Spirogyra*, *Mesocarpus*, and *Zygnema* were found in small quantities in a few places, but they were not fruiting and usually showed signs of disintegration. Numerous species of Diatoms were present in the shallower places all along the river.

* This survey was conducted by the Indiana State Board of Health Water Laboratory. To State Water Chemist, Jay A. Craven, I am much indebted for some of the data and other information that have led to the publication of this paper.

The scarcity of algae can best be explained by considering the nature of the river itself. Along the lower part of the West Fork and the entire course after the two branches unite the river follows a meandering course through a loose, sandy soil; and, by a gradual process of cutting the bank on one side and piling up sandbars on the other, it is continually changing its course. Then, along the straight parts of the stream the banks are generally steep, and there is little shallow water. When we consider at the same time that the current is comparatively swift, it is seen that only when the river is at its lowest stage are conditions at all favorable for the growth of algae. Moreover, the conditions just preceding these investigations had been the worst possible, for the exceptional flood of the preceding spring had made such changes in the river bed that several years will be required to bring the plant life of the stream back to a normal condition.

The abrupt disappearance of algal growth just below Martinsville was accompanied by an improved sanitary condition of the water. These two conditions were due, in part, to a series of long, deep stretches of quiet water which acted as septic basins for the polluted water and were also too deep for algae. It is probable, too, that the algae above these deep parts aided materially in purifying the water by releasing large amounts of oxygen which went into solution and hastened the putrefaction of organic matter.

APHANOMYCES PHYCOPHILUS DE BARY.

PAUL WEATHERWAX.

While some experiments were being made with algæ about the first of March, 1913, it was noticed that some *Spirogyra* that had been kept for ten days in distilled water had been attacked by a fungus. Attention was at once given to this parasite, which was rapidly destroying the alga. In about a week it was producing oospores, thus making possible its identification as *Aphanomyces phycophilus* De Bary.

This fungus, which is one of the few parasitic forms of the Saprolegniaceæ, was first described by De Bary in 1860, and as late as 1892 Humphrey* noted that it had not yet been reported from America. Since then, as far as we have been able to learn, no one has mentioned finding it in this country.**

It is clear that the plant is a parasite, and, in this instance, it seemed confined to the one species of host. As well as could be determined from the sterile filaments the host was *Spirogyra dubia* Kg. Scattered filaments of other species of *Spirogyra* in the same vessel were not attacked, and all attempts to inoculate other species failed.

The mycelium traverses the algal filament lengthwise, sometimes as a single thread, but more often as two, side by side. (Fig. 5.) Branches may grow for some distance inside the filament of the alga, or they may at once grow through the cell wall of the host and extend for some distance into the water. Decomposition of the alga begins soon after the fungus attacks it; the chloroplasts draw together into a mass and begin to decay, and the cell walls break down.

The mycelium is regular in size and shape, sparingly branched and non-septate except where reproducing. The diameter of the filaments is from 9 to 16 microns; the branches are usually as large as the main filaments.

*James Ellis Humphrey, The Saprolegniaceæ of the United States.

** Since writing this article attention has been called to a set of unpublished drawings made by Prof. D. M. Mottier, of an unidentified fungus that he found in 1893. These drawings and the location in which the fungus was found indicate very clearly that it was the same species as the one herein described.

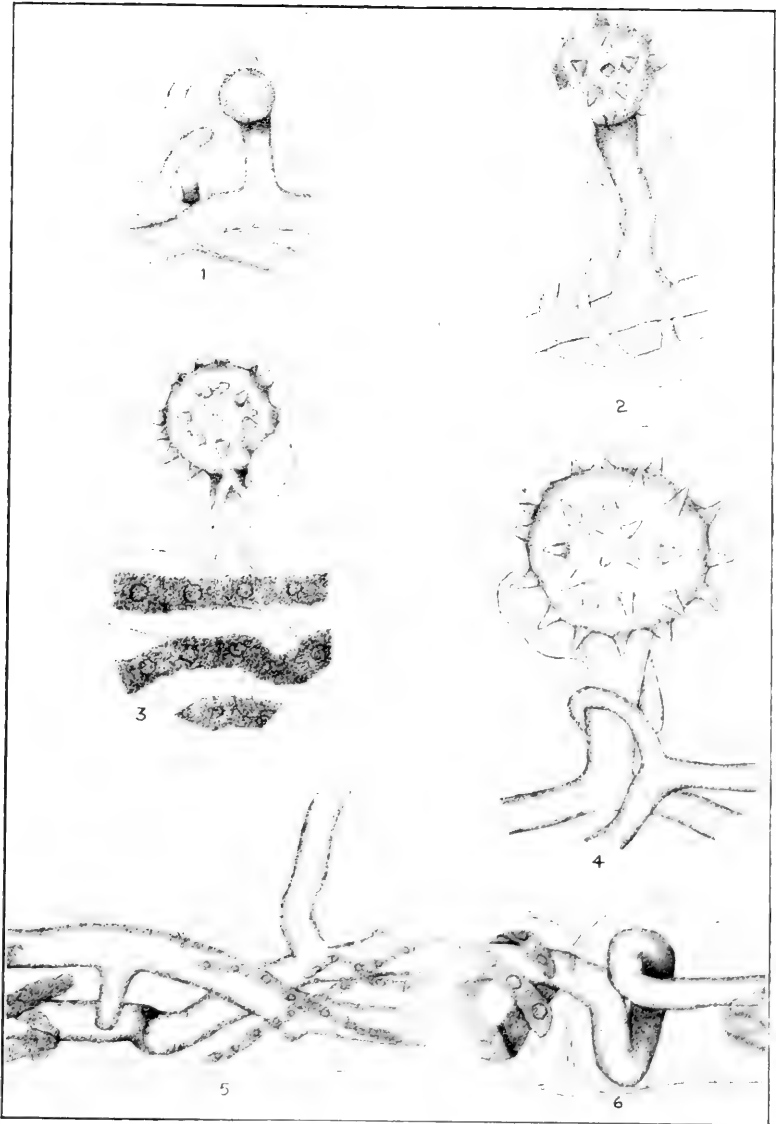

Aphanomyces phycophilus.

The protoplasm in all parts of the plant is gray, and of a coarse, granular nature.

The mycelium evidently meets with some resistance in passing from cell to cell of the host, for at these places it is often more or less knotted or bent, always on the same side of the cell wall with reference to the direction of growth in the filament, as if it had not been able to penetrate the cross wall immediately. (Fig. 6.) These penetrations of the cross wall are seldom through the center, but usually far to one side of the filament.

The plant is described as producing zoospores in long slender sporangia, but, in this case, no asexual spores of any kind were observed. Oospores, however, were produced in abundance by the union of gametes which, in no case, were found to arise from the same filament.

The sex organs arise as the enlarged ends of short lateral branches of the mycelium and usually apply themselves to each other very early. (Fig. 1.) The oogonium immediately develops rather large, conical projections all over its surface. (Fig. 2.) The antheridium remains small, club-shaped, and nearly transparent even to maturity.

The conjugating tube is formed when the oogonium is still young and before all its oily content has been organized into the egg. (Fig. 3.) At about this time the oogonium is cut off by a cross wall, but, to all appearances, the antheridium remains continuous with the rest of the mycelium.

The mature oospore is about 36 microns in diameter; the spines are from 5 to 8 microns in length. (Fig. 4.) The heavy wall of the spore, 3 to 4 microns in thickness, is a very serviceable adaptation for enabling the plant to live through conditions unfavorable for its growth.

The writer is indebted to Professors Mottier and Van Hook for assistance in indentifying this fungus and for valuable suggestions as to methods of studying it.

of a coarse gran-

in passing from
or less knotted
ce to the fine-
penetrate the
in gross wall
the filament.
at sporangia.
I. Oospores,
es which in

: branches of
only (Fig.
in projections
as small, club-

will young and
(Fig. 3). *M.*
to all appear-
the mycelium.
: the spines are
of the spore;
or enabling the

look for assist-
es to methods

INHERITANCE OF THE LENGTH OF LIFE IN *DROSOPHILA AMPELOPHILA*.

ROSCOE R. HYDE.

1. INTRODUCTION.

I have been experimenting with two different strains of the fruit fly that differ to a marked degree with respect to the length of life. The first or Inbred stock lives an average of about 37 days. The second or Truncate stock lives an average of about 21 days. In both stocks the average life of the male is somewhat longer than that of the female. It is the purpose of this paper to show the behavior of the shortened length of life of the Truncates in heredity. The evidence bears especially on the behavior of the F_1 and F_2 generations that result from crossing the Inbred and Truncate stocks. I shall also present evidence that bears on the question as to whether or not any relation exists between the length of life and the number of offspring produced by these flies.

The data upon which this paper is based grew out of a study of fertility and sterility in these strains. It was found necessary in connection with these studies to keep a careful record of the length of life of the parents. This paper is an analysis of that record. The data includes the record of 898 individuals that were bred in pairs from September, 1911, to April 1913.

The flies were in all cases used as the parents of the next generation and consequently bred in pairs. Accordingly a male and a female were in each case exposed to exactly the same environmental conditions. It is not to be overlooked that the flies live for several weeks, and since the pairs were constantly being made up the environmental influences would be practically constant. I made it a rule to transfer these flies to new bottles every ten days. It is necessary to transfer the parents more frequently in very warm weather, since offspring will hatch which cannot be distinguished from the parents.* As a matter of fact it is safe to say that in

* I have had *Drosophila ampelophila* to complete development from the egg to a fully formed fly within seven days at Woods Hole, Mass., in July, 1913.

these experiments not more than 15 per cent. of the transfers were made before the tenth day. A census was taken of the parents practically every day. In a few cases five days may have elapsed before a record was entered. In case a fly was dead the sex was noted and recorded.

This record, then, includes the length of life of the relatively long-lived Inbred stock; the short-lived Truncate stock; the hybrid offspring between the two stocks and the life of the grandchildren.

2. ANALYSIS OF THE DATA.

The curves which follow are plotted from the life records of 898 flies which are recorded in Part I and Part II of my Studies on "Fertility and Sterility in *Drosophila ampelophila*."* The length of life is expressed in days and is indicated by the abscissa, while the number of individuals is in each case expressed by the ordinate.

Curve A shows the distribution of the mortality of the Inbred stock. The curve is drawn from the records of 191 individuals. The average life of this lot is 37.4 days. The 94 males lived an average of 40.5 days; 97 females lived an average of 34.5 days. The males lived six days longer than the females.

Curve B shows the distribution of mortality of the 272 Truncates, the average life of which was 21.4 days. The 96 males averaged 26.9 days; the 176 females 18.5 days. The males of this stock lived 8.4 days longer than the females. It is to be noted that the flies of this stock live approximately half as long as those of the Inbred stock.

The hybrid that results from crossing the Truncate and Inbred stocks lives longer than either parent, as is brought out in curve C'. For, while the parents live 21.4 and 37.4, respectively, the offspring from the cross live 47 days. This record is based on 42 flies. Thirteen males lived 47.8 days, while 29 females lived 46.4 days. The data is too small to base any safe conclusion in regard to any difference that may exist in the length of life between the male and the female. That the hybrid lives longer than either parent is also borne out by curve C, where a partial record is given of 218 flies. The experiment was discontinued after thirty days, at the end of which time it was found that only 19 per cent. of the flies had died. The mortality in this case corresponds fairly well with the mortality in the case as shown in the curve C', in which seven in 42 died within the first thirty days, a mortality of 17 per cent.

* Journal of Experimental Zoology, 1914. Vol. XVII, Nos. 1 and 2.

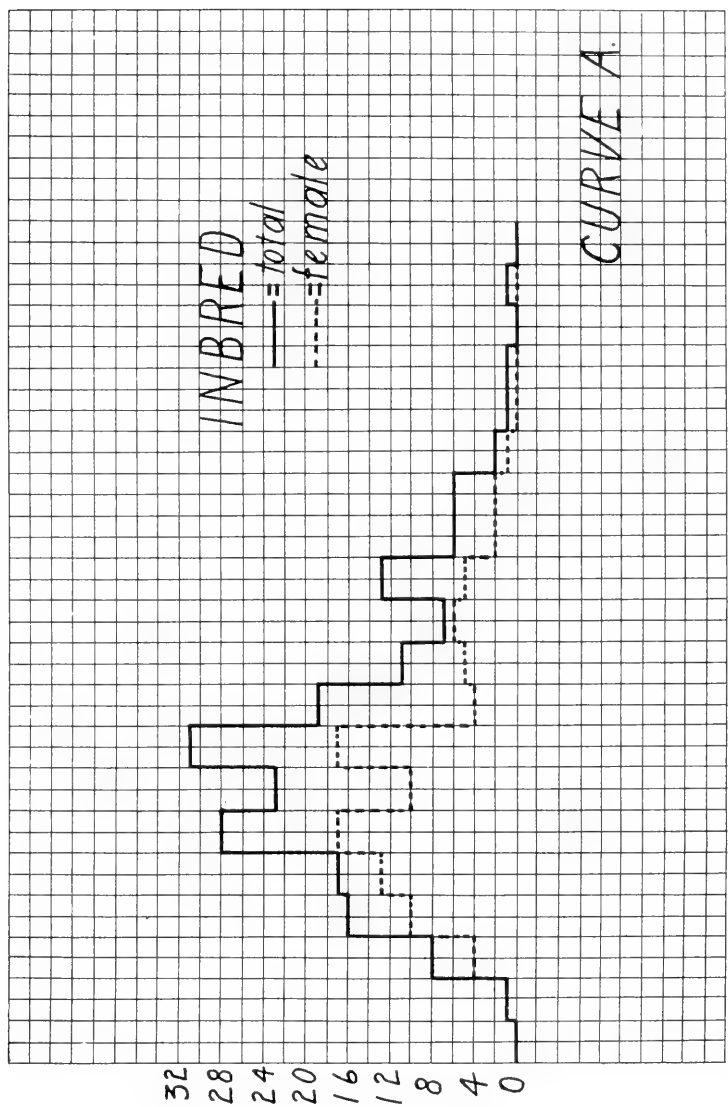

0 5 10 15 20 25 30 35 40 45 50 55 60 65 70 75 80 85 90 95 100

A study of curves D and E shows that the shortened length of life of the Truncates reappears again, and this is true whether the grandchildren have descended from the Truncate male or Truncate female. The 128 flies descended from the Truncate grandmother lived an average of 29.5 days. The 66 males lived 32.8 days, while 62 females lived 25.9 days. The 89 flies that descended from the Truncate grandfather lived an average of 29.3 days. There were 45 males which lived 31.1 days, while 44 females lived 27.3 days.

3. DISCUSSION.

The foregoing data brings out the fact that when the Truncate stock with an average life of 21.4 is crossed to the Inbred stock with an average life of 37.4 days, the hybrid that results lives 47 days. If the complex of factors or whatever concerned upon which the length of life in these flies depends, behaves anything like Mendelian characters in the sense that segregation and recombination takes place, then we should expect the shortened length of life of the Truncates to reappear among the grandchildren. A study of the curves verifies the expectation, for the grandchildren live an average of only 29.5 days.

A study of the curves will show in each case three modes which correspond with three periods of the greatest mortality. The meaning of such a phenomenon is obscure, and had the experiment not extended over a long period of time I would be inclined to doubt its reality. There is a possibility, however, that these depression periods correspond with the output of the sex products. My experience in isolating eggs day by day laid by over 200 females seems to indicate that the eggs are laid in cycles—that is, a female begins to lay eggs when two or three days old. Her egg production gradually rises to a maximum, and then it declines almost to zero. In fact she may cease to lay eggs for a day or two and then a new cycle begins which runs the same course, and this in turn is followed by a third. In the period when the female ceases to lay eggs she is most likely to die. However, if a female survives such a period at the close of the third cycle she will as a rule live to a ripe old age, depositing a few eggs occasionally. It is barely possible that these mortality periods correspond to the depression periods in the egg-laying cycles. It must be admitted however, that critical evidence is hard to obtain, since the egg production seems to be influenced by several factors. Moreover it is not evident that such an explanation applies to the male.

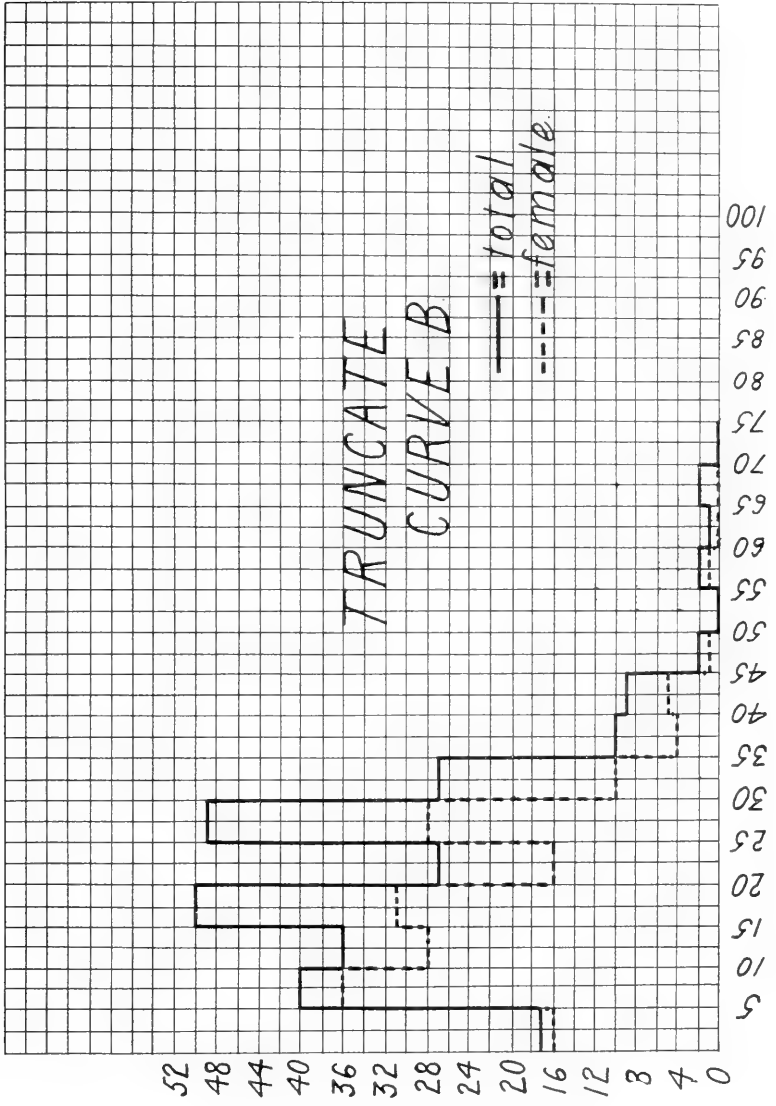

4. LENGTH OF LIFE AND PRODUCTIVITY.

I shall here analyze the data with respect to the productivity of these stocks as determined by breeding in pairs. It is obvious that if a female that would give rise to a large number of offspring should for some reason meet premature death, there would be a correlation between the length of life and the number of offspring produced. The problem, however, is more complicated. In the case of the Truncates it is not evident just how much such a factor as the shortened length of life enters into the results, for I have been able to show that this stock is deficient not only in egg production, but also that marked incompatibility exists between egg and sperm.

In the following curves, F, G, II, I, evidence is brought together that shows the productivity of the F, Truncates. G. The Inbred. H. The Hybrid that results from crossing F and G; and I. The F_2 generation that results from crossing F and G.

In these curves vertical distances express the number of pairs, while horizontal distances express the number of offspring produced. A glance at Curve II, which gives the productivity of the hybrids when the individuals expressed by curves F and G are crossed, moves decidedly to the right. This is evident despite the fact that the experiment was discontinued at the end of thirty days. Curve I expresses the output of the F_2 generation. It is evident that the low production of the Truncates reappears among the grandchildren.

This evidence goes to show that the complex upon which productivity depends is inherited in the sense that low productivity skips a generation when crossed into a high producing strain. In fact the productivity of the hybrid fly is greater than the productivity of both parents combined. I have demonstrated in previous studies that the increased productivity on the part of the hybrid is not due in this case to the increased fertilizing power of the gametes beyond that of the highest producing stock, but is due to a greatly increased output of eggs.

As a matter of fact the fertilizing power of the gametes of the hybrid (*inter se*) is lower than the fertilizing power of the gametes of the high-producing parent. It is evident that the low productivity of the Truncate reappears in the F_2 generation and that this holds true in both the cross and its reciprocal.

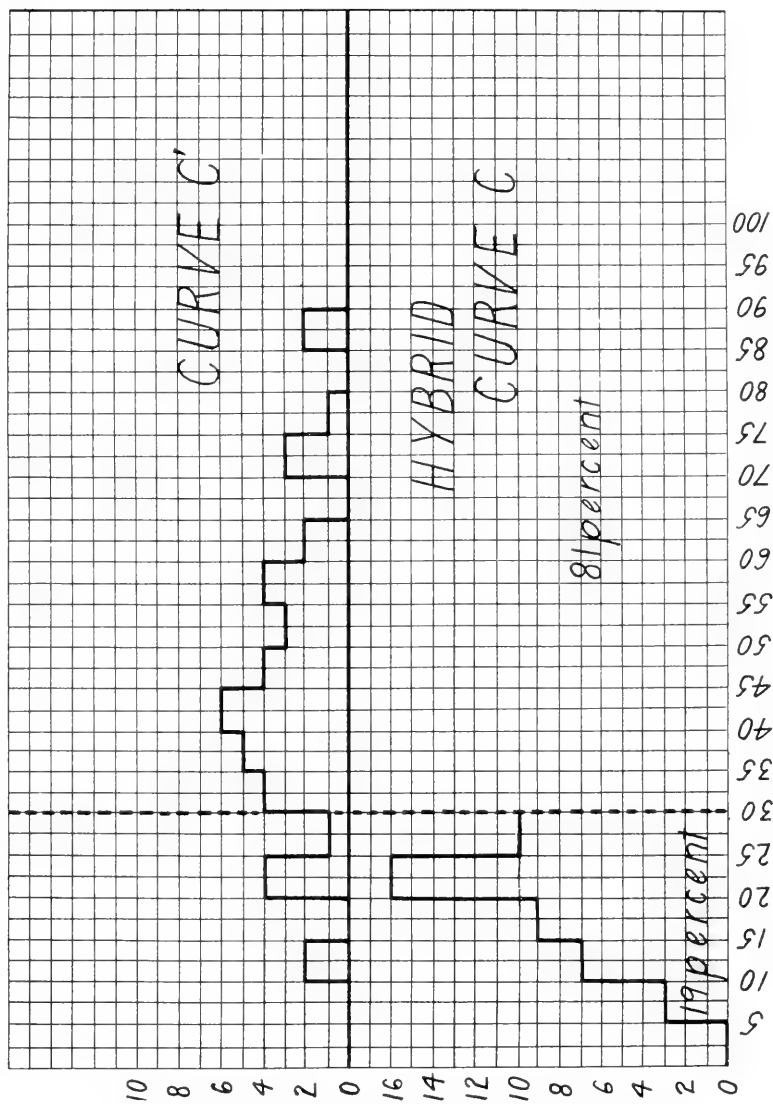

5. GENERAL DISCUSSION.

The following is offered by way of explanation of the foregoing facts. Let it be assumed that the complex upon which the length of life of the wild fly depends is expressed by the formula AB. The Truncate stock arose as a mutation from the wild stock and possibly some factor has changed to a. Consequently its formula would be aB. The inbred stock had been in captivity for some time, and it is possible that the B had changed to b. Its formula would be Ab. On crossing these two stocks a hybrid would result, the formula for which is abAB. Consequently in the hybrid, normal conditions are restored, and a fly results that lives longer than either parent. The same explanation holds in the case of the increased egg production to be seen in the hybrid. If this is true we should expect to find wild stocks that live about fifty days and with high egg production and high fertilizing power of the gametes combined. They should be very high producers. The number of factors, however, is not looked upon to be as simple as the formula would seem to indicate. Instead of two factors as the formula shows, there may be many hundreds, but the principle is the same. The things lost or changed in the germ plasm of one stock are compensated in the hybrid by the factors transmitted by the other stock, and thus normal conditions are restored.

6. CONCLUSIONS.

1. Hybrids between the Truncate stock and the Inbred stock are more vigorous than either parent as shown by the fact that the hybrid lives 47 days while the parents live 21.4 and 37.4 days respectively.

2. The flies from the Truncate stock live 21.4 days. The females live 18.4 while the males live 26.4 days.

3. The flies from the Inbred stock live 37.4 days. The females live 34.5 days while the males live 40.5 days.

4. The shortened length of life of the Truncate stock reappears among the grandchildren after skipping a generation when crossed to the Inbred stock. The grandchildren lived an average of 29.5 days. Those descended from the Truncate grandmother lived 29.5 days. The males lived 32.8 days and the females lived 25.9 days. The flies descended from the Truncate grandfather lived 29.3 days. The males lived 31.1 days, while the females lived 27.3 days.

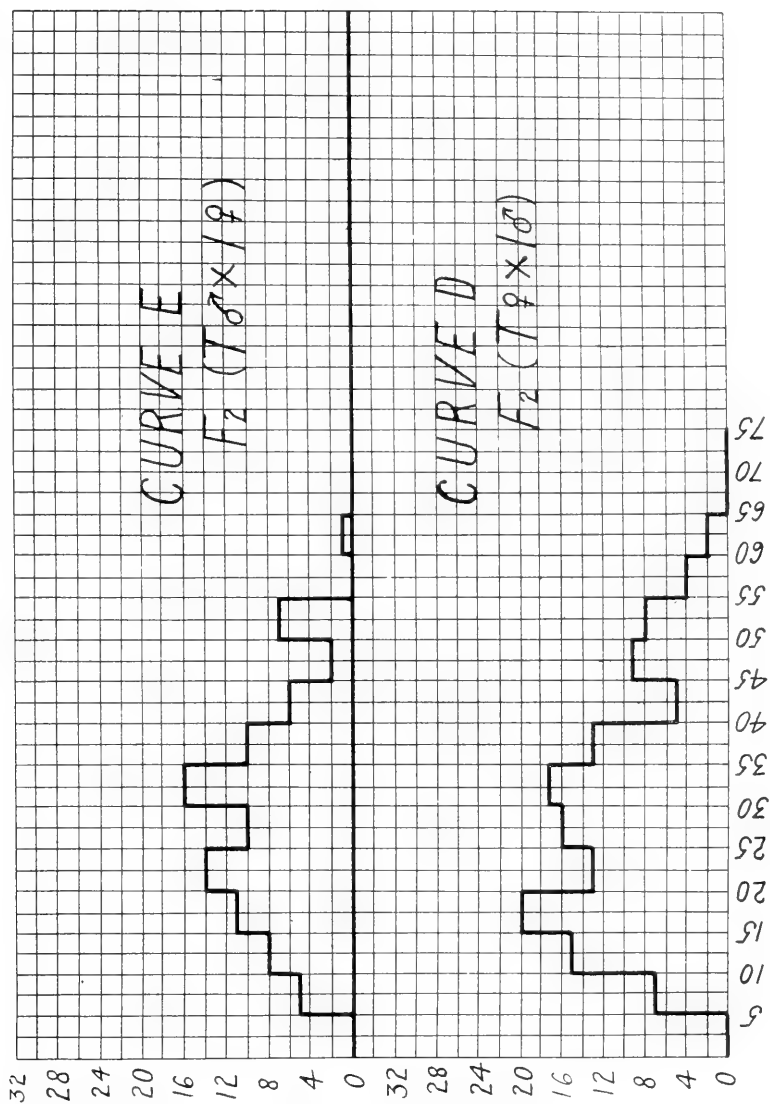

5. It seems not improbable that the length of life and the coming to maturity of the germ cells may be in some way physiologically connected.

6. The low productivity of the Truncate skips a generation when crossed to a high-producing strain and reappears in the F_2 generation. It is difficult to correlate the length of life in these strains with the number of offspring produced, because it is evident from my other studies that the fertilizing power of the gametes as well as egg production are involved as variable factors in productivity.

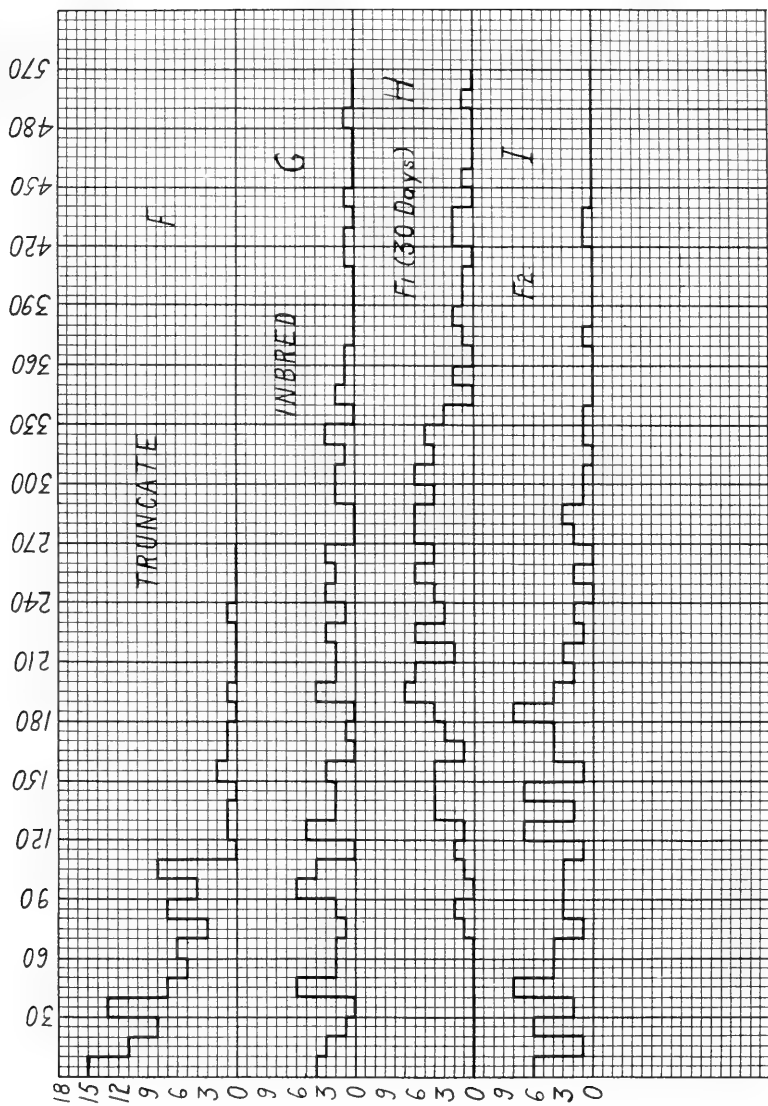

THE GERMINATION OF SEEDS OF ARISÆMA.

F. L. PICKETT.

The corms of *Arisæma triphyllum* grown for the study of form and development showed great variation in size, and there was a seeming discrepancy between the number of leaves above ground and the number of corms found in the soil after the leaves had withered. Following these observations arrangements were made to check up carefully the points suggested.

On December 26, 1912, 900 seeds of *Arisæma triphyllum* were planted in rich, loose loam in large clay flower pots and subsequently subjected to three sets of conditions as noted below. As leaves appeared above the soil they were counted, one to three times per week, until no more appeared, and a record kept for comparison with the number of corms found after the growing season was over. In every case the seeds were carefully washed from the fruit pulp before planting, and when planted were covered with sandy loam to a depth of 2 cm., this being approximately the condition in natural planting.

One bunch of 300 seeds was placed in the greenhouse at a temperature of 75 to 80 deg. Fahr. immediately after planting. From this planting 208 leaves appeared between January 15 and March 19, 1913. No leaves appeared after the last date.

A second bunch of 300 seeds planted as the first, was left in the greenhouse vestibule at a temperature of 50 to 60° Fahr. From this planting 226 leaves appeared between February 19 and April 25, 1913. No leaves appeared after the last date.

A third bunch of 300 seeds, planted as the first, was placed in a cold frame until March 13, 1913, where the temperature fell slightly below the freezing point, and was then removed to the greenhouse. From this planting 209 leaves appeared.

In the summer of 1913 when the leaves of the cultures were dead the corms were carefully removed and counted. The number of corms and the number of leaves from each culture are given below.

Lot No. 1 showed 260 corms, 208 leaves, i. e., 52 "blind" corms. Total germination 86.6 per cent.

Lot No. 2 showed 246 corms, 226 leaves, i. e., 20 "blind" corms. Total germination 83 per cent.

Lot No. 3 showed 261 corms, 209 leaves, i. e., 52 "blind" corms. Total germination 87 per cent.

It is not the purpose of this paper to discuss the variations which may be due to different temperature conditions, but merely to show the high percentage of germination and to indicate the fact that some seeds germinate "blindly," that is, the embryo grows, a corm and roots are produced, and food is transferred from seed to corm without the formation of leaves or other photosynthetic organ. At the end of the growing season the connection with the seed is broken off, leaving the new plant independent.

A glance at the corms from these cultures at once suggests a difference in their food supply and growth. Some are three to six times as large as others. While the numbers of large and small corms are not exactly the same as the numbers of leafy and leafless plants, they are nearly enough so to suggest a relation.

A similar set of experiments was arranged in which seeds of *Arisaema Dracontium* were used. The seeds were prepared and planted December 26, 1912, the same as in the case of *A. triphyllum*. Lot No. 1 was left in the main room of the greenhouse, and showed, between February 6 and March 8, 1913, eight leaves. On June 19, 200 corms and 24 seemingly good seeds were removed.

Lot No. 2 was left in the cold-frame from December 26 to March 15 and then removed to the greenhouse. This culture showed eleven leaves between April 3 and April 25. On June 20, 179 corms and one sound seed were removed.

Lot No. 3 was left in the greenhouse vestibule until March 12, and then removed to the greenhouse. Between April 23 and June 20 four leaves appeared, and on the last date 187 corms were removed. These results are tabulated below.

Lot No. 1. 300 seeds, 8 leaves (2.66 per cent.), 279 (93 per cent.) corms and viable seeds.

Lot No. 8. 200 seeds, 11 leaves (6.11 per cent.), 180 (90 per cent.) corms and viable seeds.

Lot No. 3. 200 seeds, 4 leaves (2 per cent.), 187 (93.5 per cent.) corms and viable seeds.

These corms have been replanted and their further development will be reported later.

Because of the "blind" germination seeming to be the normal thing with *A. Dracontium*, a brief account will be given.

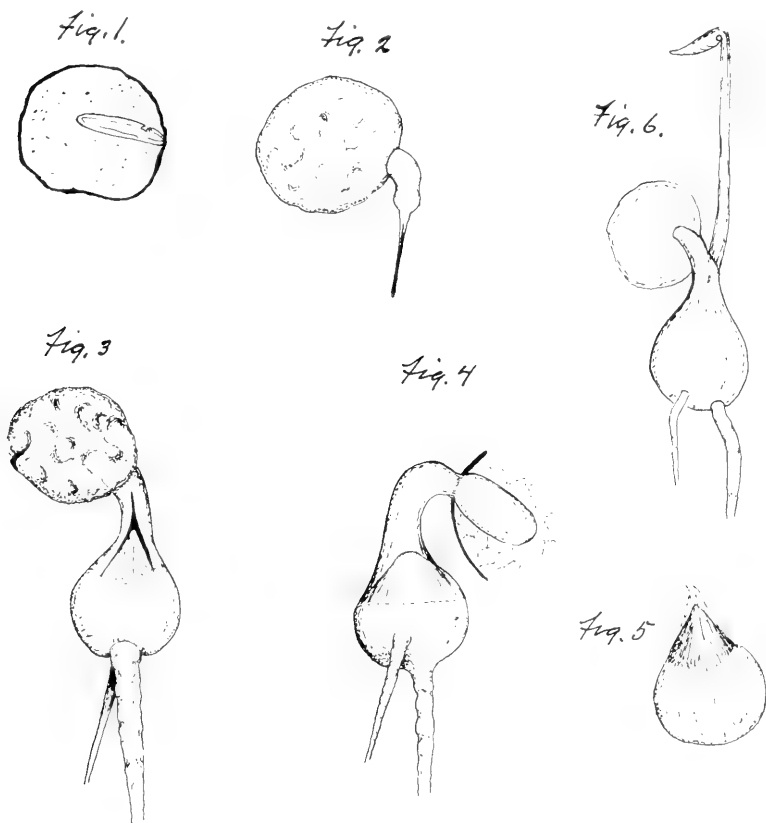

The Germination of Seeds of *Arisema*.

One to five seeds are borne in each berry of the aggregate fruit. Each seed is two to three millimeters wide and three to four millimeters long, and is composed of a hard testa covering a flinty gelatinous endosperm, in which is imbedded the almost straight, cylindrical embryo, Fig. 1. Under

proper conditions the seed absorbs water and the embryo lengthens by growth both above and below the plumule. The growth of the cotyledonary petiole is more rapid than that of the radicle, so that the radicle, with the plumule, is soon pushed outside the seed coat. The cotyledonary petiole reacts to the stimulus of gravity so that the radicle is soon directed downward, Fig. 2. The one cotyledon remains inside the seed as an absorbing agent, Fig. 4. The radicle grows down rapidly to form a primary root. Later one or two other roots may be formed. Immediately after the establishment of a root system or water absorbing system, the portion just below the plumule becomes enlarged by the storage of food stuff transferred from the endosperm of the old seed, Figs. 3 and 4.

In case the germination is complete, the formation of a root system is followed by the growth of the single simple leaf up from the plumule, through the cotyledonary petiole to the light, Fig. 6. Usually, however, only scales are formed around the bud. In either case, when the food material has been absorbed, the tissues connecting seed and seedling shrivel up, leaving the young plant independent. After a period of about eight weeks from the beginning of germination the corms will be found free from the seed and with the roots detached and broken down, all ready for a period of rest, Fig. 5.

It may be of interest to note that *A. Dracontium* gives other evidence of incomplete response to seasonal changes. During the summer of 1913 the corms of a considerable colony were dug up for experimental purposes. Although these corms were scattered in the soil but a few inches apart, and some had shown very vigorous growth of stem and leaves, about half of them had made no start toward growth. The conditions were certainly the same for all individuals of the colony, and were good, as shown by the growth just mentioned. Whether this plant is subject to definite periodicity requiring more than the usual rest season, or is controlled by some as yet unconsidered influence, can only be left a question.

STUDIES OF *CAMPTOSORUS RHIZOPHYLLUS*, AN ABSTRACT
 OF THE DEVELOPMENT OF THE PROTHALLIUM OF
CAMPTOSORUS RHIZOPHYLLUS,* AND THE
 RESISTANCE OF THE PROTHALLIA OF
CAMPTOSORUS RHIZOPHYLLUS
 TO DESICCATION.†

F. L. PICKETT.

As is well known the Walking Fern, *Camptosorus rhizophyllus*, is found chiefly on rocky ledges in more or less shaded places, where the water supply is irregular and slight at all times. The colonies in the neighborhood of Bloomington, Ind., have abundant water supply only at times of heavy rain and of course enjoy such supplies for but brief periods. The fact that this fern could not only withstand the many longer or shorter periods of drought but could multiply in the regular way under such conditions suggested the probability of some special structural or physiological adaptation. The scheme for vegetative increase by means of stoloniferous leaves is well known and gives the plant its specific name. But the presence of many small plants which could not have had such origin and so must have been produced through the production of the prothallial or sexual stage, along with the fact that the prothallia of many of our ferns cannot survive the lack of a normal supply of moisture for more than a few hours, suggested another possible adaptation as well as a point of attacking the problem.

Cultures were made of sowing spores on sterilized soil in clay saucers protected under bell jars. Both the peculiarities of form and the resistance to desiccation were studied.

The following peculiarities of form and development have been noted. The development of a plate of cells is not uniform, beginning sometimes immediately after the germination of the spore and at other times not

* Bot. Gaz., 57: 228-238, Mar., 1914.

† Bull. Torr. Bot. Club, 40: 641-645, Nov., 1913.

until a protonemal thread of two to five cells has been formed. The differentiation of an apical cell or group is late and irregular, resulting in unsymmetrical growth. The marginal cells show unusual growth, producing variously formed outgrowths, sometimes bearing antheridia and occasionally producing extra growing regions which may even become independent proliferations.

With reference to drought resistance the following facts have been noted: Allowing a culture to become dry for one or two days in the normal air of the greenhouse seems in no way to injure the plants beyond checking growth during the dry period. One culture left in dry air with slight additions of water once a week showed nearly all the prothallia alive and in good condition after a period of three months. The major part of the plants of another culture are in good shape and have produced a number of sporophytes although subjected to such irregular moisture conditions for a period of nine months. In a culture receiving only air which had been dried by passing through pure glycerine, most of the prothallia were in good condition after four weeks and a few survived such treatment for a period of six weeks.

In conclusion, the two specially important adaptive features are, the unusual power of promiscuous growth of prothallial cells, and the ability to resist extreme desiccation in intermittent periods.

IRISH POTATO SCAB (*OOSPORA SCABIES*) AS AFFECTED BY FERTILIZERS CONTAINING SULPHATES AND CHLORIDES.

S. D. CONNER.

In the spring of 1911 a pot experiment with Irish potatoes was started at the Purdue Experiment Station by the author. It was the intention to investigate the composition and quality of potatoes grown in several types of soil with different fertilizers, the ordinary silt loam of the station farm being the principal soil used. Peat and sandy soils were also used, as well as eight pots containing pure silica sand. The principal fertilizers studied were sulphate of potash and chloride of potash. Two varieties of potatoes were used, Early Ohio, one of the best early varieties, and Carmen No. 3, a good late variety.

The experiment was not planned to cover an investigation of potato scab, although this development of the research may be one of the most significant features noted. The seed potatoes planted the first year did not show any scabbiness and no attempt was made to prevent it. When the potatoes were harvested, however, it was seen that formalin should have been used, as the crop was badly affected by the scab fungus *Oospora scabies*. The scab was very much worse in the brown peat than in the other soils, as will be seen from Fig I. There was also a slightly greater amount of scab in the pots where chloride of potash was used than there was where sulphate was used, the unfertilized pots being affected the worst of all. In 1912, to prevent scab the seed potatoes were all treated with formalin and one-half the pots, which are in duplicate, were given an application of flowers of sulphur, which is a treatment that has been reported as a success by certain investigators.* No great differences as to scabbiness were seen in the crop of 1912, and photographs were not taken.

In 1913 the seed potatoes were again treated with formalin, but no sulphur was added. When the potatoes were harvested this year a sur-

* B. D. Halsted, Bul. 112, N. J. Agr. Exp. Sta.; also Bul. 120 N. J. Exp. Sta.

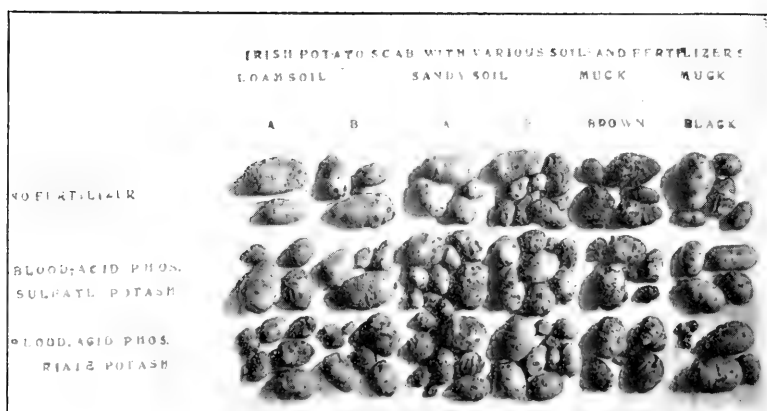

Fig. I. Potatoes Grown in Pots, 1911. Various Soils and Fertilizers Affecting Scab.

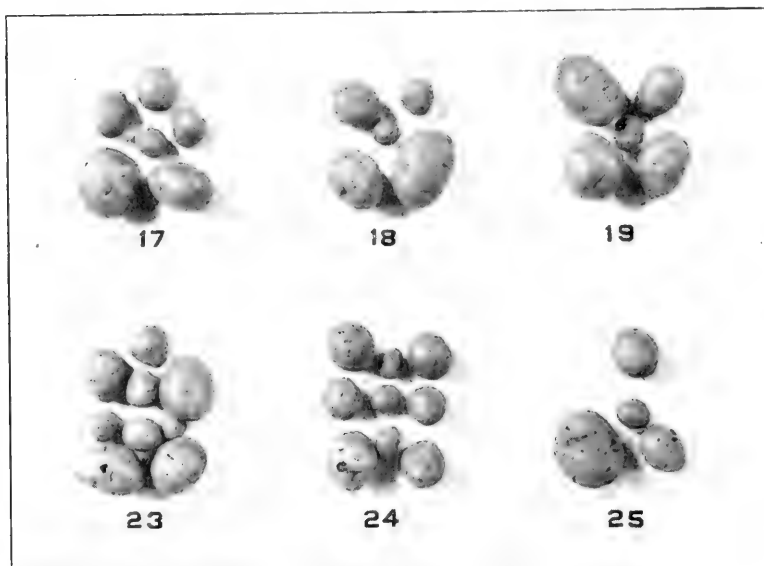

Fig. II. Potatoes Grown in Pots, 1913. Loam Soil. Very Little Scab. See Table I, for Treatment.

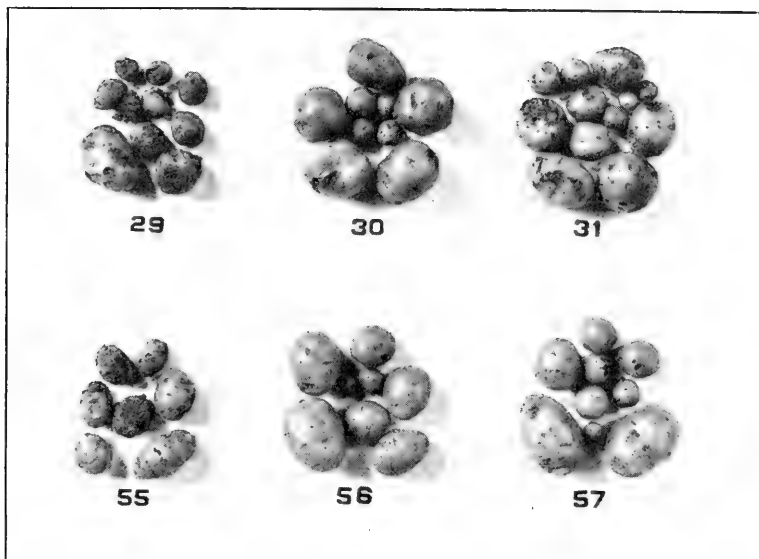

Fig. III. Potatoes Grown in Pots, 1913. Peat Soil. See Table I, for Treatment Affecting Scab.

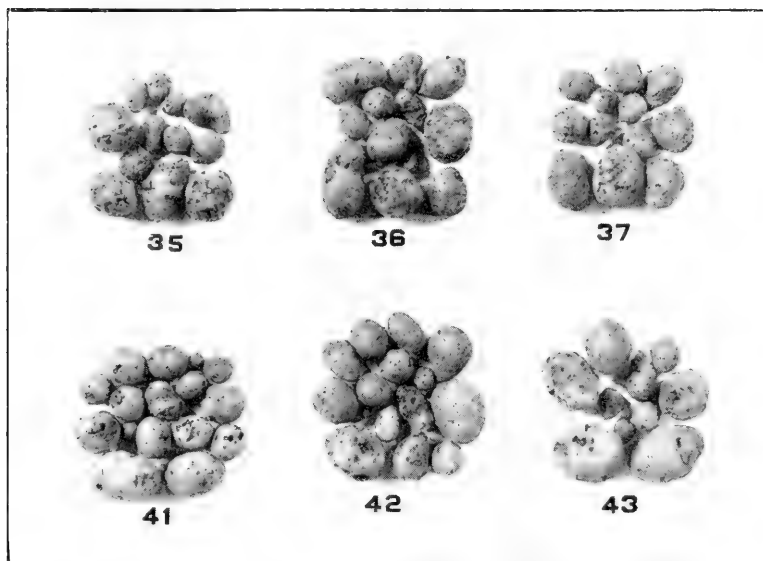

Fig. IV. Potatoes Grown in Pots, 1913. Sandy Soil. See Table I, for Treatment Affecting Scab.

prisingly large amount of scab was noted. The soil, the treatment, and the approximate percentage of scabbiness are given in Table I and photographs of the early potatoes are shown in Figs. II, III, and IV.

As the seed potatoes had been treated it is evident that the scab spores had lived over the winter in the pots which were left out in the ground. It appears that very little scab had survived the climate and soil conditions in the loam soil, while in the soils of more open texture such as peat and sand, the spores had been able to survive.

The unfertilized soils in most cases are affected to the greatest extent. In every case flowers of sulphur, which had been applied in 1912, has had a deterrent effect in the development of scab. In the fertilizer treatment sulphates have kept the scab down while the chloride has apparently encouraged it.

The variations noted in the amount of scab on the potatoes grown in silica sand merit special attention, as in these pots all factors except soil treatment have been eliminated and there are four pots which have not had chloride in any form either in the original sand (the soils all have more or less chlorine naturally) or in any treatment. The sulphur factor was more nearly controlled in these pots than in the soil pots as di-calcic phosphate was used in 1913 in place of acid phosphate. Acid phosphate which contains more or less calcium sulphate was used in all soil pots that were fertilized; it was also used the first season in the silica sand pots, and it was necessary that some sulphate should be added as a plant food. The treatment of each pot and the amount of scab on the potatoes grown in silica are shown in Table II. Fig. V is a photographic reproduction of all the potatoes grown in the silica pots in 1913. It will be noted from the accompanying table and illustrations that sulphur has had a marked influence in reducing scab, but that sulphates have not. On the other hand, wherever chloride has been added either with or without sulphates very much scab was always present. This seems to indicate that chlorides are needed in the development of the scab fungus. The fact that chlorides are present in quite large amounts in soils, especially those near the sea coast, may account for the fact that chlorides have not been found to increase scab in experiments where such effects were noted.*

* H. J. Wheeler and G. M. Tucker, Bul. 40, R. I. Exp. Sta.; also G. E. Stone, 20th Ann. Rep. Mass. Agr. Exp. Sta., 1908.

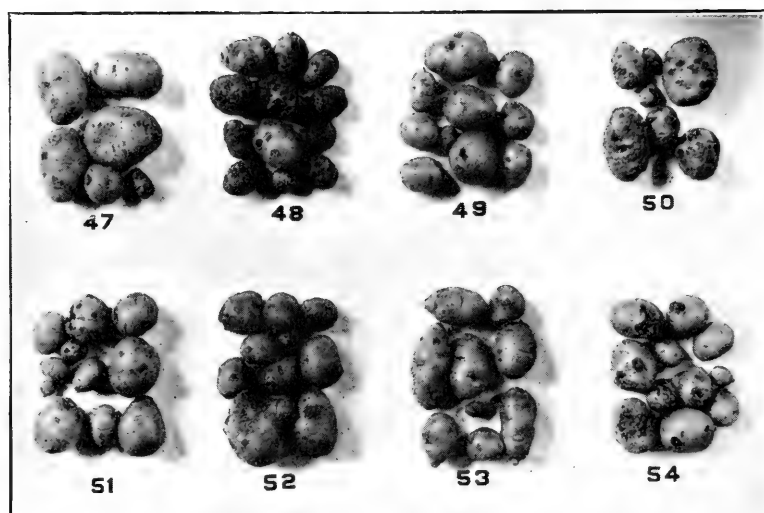

Fig. V. Potatoes Grown in Pots, 1913. Silica Sand. See Table II, or Treatments Affecting Scab.

TABLE I.

POTATO SCAB (*OOSPORA SCABIES*) POT CULTURES, 1913.

Kind of Soil.	Treatment of Soil.	Early Ohio Variety.		Carmen No. 3 Variety.	
		Pot No.	Per Cent. of Scab.	Pot No.	Per Cent. of Scab.
Silt Loam.	None.....	17	1	20	0
	N P K ₂ SO ₄	18	1	21	0
	N P KCl.....	19	1	22	2
	None.....sulfur	23	3	26	1
	N P K ₂ SO ₄sulfur	24	1	27	0
	N P KCl.....sulfur	25	1	28	1
Brown Peat.	None.....sulfur	29	60	32	5
	N P K ₂ SO ₄sulfur	30	15	33	10
	N P KCl.....sulfur	31	25	34	15
Black Peat.	None.....sulfur	55	50	58	1
	N P K ₂ SO ₄sulfur	56	3	59	3
	N P KCl.....sulfur	57	15	60	5
Sandy Soil.	None.....	35	80	38	30
	N P K ₂ SO ₄	36	65	39	50
	N P KCl.....	37	75	40	50
	None.....sulfur	41	28	44	3
	N P K ₂ SO ₄sulfur	42	20	45	3
	N P KCl.....sulfur	43	24	46	5

N = 7 gr. dried blood + 6.7 gr. nitrat soda per pot.

P = 12.8 gr. acid phosphate per pot.

K₂SO₄ = 3.6 gr. sulphate of potash per pot.

K Cl = 3.6 gr. chloride of potash per pot.

Sulfur = 8 gr. sulfur per pot.

Per cent. of scab is an approximation of the surface of the tubers affected.

TABLE II.

POTATO SCAB (*OOSPORA SCABIES*) IN SILICA SAND POT CULTURES.

Treatment of Soil	Pot No.	Per Cent. of Scab.
N P K ₂ SO ₄	47	4
N P KCl.....	48	75
N P K ₂ SO ₄ + Na ₂ SO ₄	49	4
N P K ₂ SO ₄ + NaCl.....	50	75
N P K ₂ SO ₄ + sulfur.....	51	8
N P KCl + sulfur.....	52	25
N P K ₂ SO ₄ + Na ₂ SO ₄ + sulfur.....	53	2
N P K ₂ SO ₄ + NaCl + sulfur.....	54	20

N = 7 gr. dried blood plus 6.7 gr. nitrate soda per pot.

P = 5.1 gr. di-calcic phosphate per pot.

K₂SO₄ = 3.6 gr. sulfate of potash per pot.

KCl = 3.6 gr. chloride of potash per pot.

Na₂SO₄ = 3.4 gr. sulfate of soda per pot.

NaCl = 2.8 gr. chloride of soda per pot.

Sulfur = 8 gr. per pot or approximately 360 lbs. per acre.

All pots had a treatment of 100 gr. calcium carbonate per pot.

Early Ohio potatoes treated with formalin were planted.

WABASH STUDIES. V. A TOPOGRAPHIC MAP OF THE TERRE HAUTE AREA.

CHARLES R. DRYER.

The west sheet, covering an area about five miles square, was presented to the Academy in 1909 and a poor photographic copy of it was published in the Proceedings for that year. The east sheet, covering an area six by seven miles, is now completed. The two sheets cover a strip five to six miles wide north and south and twelve miles long east and west extending across the Wabash valley. The original draught and tracing are on a scale of six inches to the mile and the contour intervals are five, ten and twenty feet, according to the relief. The datum planes used for the west sheet were the levels of the Vandalia and Big Four railroads. After that was completed the United States Geological Survey established bench marks in the area which were used for the east sheet, although found to be 3.65 feet above those of the west sheet.

On the east sheet levels were run with a dumpy level along east-west lines one mile apart and the intervening spaces were filled in with a hand level used on a staff. The levels of the city engineer's office reduced to U. S. G. S. datum, were used wherever available. The work was all done by students of the Department of Geography and Geology of the Indiana State Normal School. In all about forty different persons worked upon it during periods varying from six weeks to thirty-six weeks each. Of these Melvin K. Davis and Garl H. Barker became the most proficient, and to them was assigned the plotting and final draft of the map.

The map is not good enough for sewer, drainage or hydraulic work, but would be of some value for highway and railroad location. For geographic and geological purposes it is far better than none. Its final displacement by a better one will not destroy the values of the experience obtained by its makers or the facility it affords for general field work.

CENTER OF AREA AND CENTER OF POPULATION OF INDIANA.

W. A. COGSHALL.

The center of area and the center of population for the State of Indiana were determined lately for the Board of State Charities. The process in the determination of the center of area was to draw two lines at right angles across as good a map of the State as could be found, the intersection falling at the estimated center. The areas of the north and south sections were then measured with a planimeter and the east and west lines shifted till the two measured the same. The areas on each side for north and south line were treated in the same manner and the result checked by measurement on several different maps. The intersection of these lines is near the village of Traders Point, in Pike Township, Marion County.

The center of population is really a problem in center of gravity. It is not a point about which the population is equally distributed, but a point such that if a map of the State were loaded in proportion to the population of each locality, the map could be supported by that point and would balance. The population of any one locality is therefore only one factor in determining the location of the center, the other factor being the distance of such locality from the center.

In this determination the statistics used were supplied by Mr. Butler and consisted of the population of each township of each county. I assumed that the population would be evenly distributed over the township in the cases where no towns existed. Where a township had a large part of its population concentrated in a town, I estimated the center of gravity of the township accordingly. The distance of these township centers from a pair of arbitrary east-and-west, and north-and-south lines was measured on a large scale map. The solution for the center of gravity gave the distance of such center from the intersection of the arbitrary lines. This

intersection was eleven miles north of Lebanon and the corrections found as the result of the computation placed the real center of population in Eagle Township, Boone County, about $1\frac{1}{2}$ miles southwest of the Station of Zionsville.

It is a remarkable fact that the centers of area and population are so close together.

THE SHRINKAGE OF PHOTOGRAPHIC PAPER.

R. R. RAMSEY.

In mounting some spectrograph prints I was very much chagrined to find that they were at different lengths, as if they had been taken on different spectrographs. These prints had been printed on developing paper, developed, washed, dried and then soaked and mounted wet. It had happened that the paper used came in quite large sheets and in cutting down to size it was economical to cut some pieces lengthwise of the paper, while other pieces were cut crosswise. Several prints were made and the best were selected for mounting. In this chance selection some were lengthwise and others were crosswise of the paper. The expansion and contraction in the process of developing and washing was different in the different directions and it was necessary to make a new set of prints, care being taken to have the paper all cut the same way. The mounting was done before drying, to prevent excessive expansion.

I thought it might be of interest to experiment with several brands of paper to determine if this fault was found in all brands of paper or in this particular brand alone.

An 8x10-inch plate was exposed to sunlight and then developed, giving a very dense film. On the edges millimeter scales were ruled with the dividing engine. A space of 20 centimeters was ruled on the long edge and a 15 centimeter space on the short edge of the plate. Thus by printing and developing I had a photograph of the scale, and measurement would give the amount of shrinkage or expansion. Five different papers were used. All were printed, developed, fixed, and washed in the usual manner. After washing, a sample of each brand was mounted on cardboard. The others were stuck back side to glass and allowed to dry. When dried measurements were taken of the length and breadth. Then samples of each brand were selected from the unmounted photographs, soaked in water and mounted on cardboard. After drying, these were also measured.

The accompanying table will give the results:

PAPER.	Dried on Glass.		Mounted Wet on Cardboard.		Dried, Soaked and Mounted Wet on Cardboard.	
	Length.	Breadth.	Length.	Breadth.	Length.	Breadth.
Darko-Matt.....	-.55%	-.51%	2.3%	.23%	2.6%	.5%
Velox C.....	-.32%	-.45%	.52%	1.4%	.8%	1.8%
Velox S.....	-.2%	-.31%	1.6%	.3%	1.9%	.7%
Azo C.....	-.075%	-.18%	1.8%	.3%	2.1%	.66%
Azo E.....	-.06%	-.23%	.28%	1.5%	.52%	1.8%

The results show that all brands act very much alike. When dried on glass there is a trifle shrinkage. The mounted photographs show considerable expansion and in every case a larger amount in one direction than in the other. In some cases the per cent. of expansion is ten times that in the other direction.

ACYL DERIVATIVES OF O-AMINOPHENOL.

J. H. RANSOM AND R. E. NELSON.

In an extended piece of work published some years ago the senior author (*Amer. Chem. Journ.*, **23**, 1) found that when *o*-nitro phenylethylcarbonate was reduced with tin and hydrochloric acid a urethane was obtained, soluble in alkalis and evidently having the carbethoxy group attached to nitrogen. By modifying the conditions he was able to isolate an isomeric basic material in which the carbethoxy group was attached to oxygen. On standing this rapidly changed to the urethane. The same urethane was obtained on treating *o*-aminophenol, in ether solution, with chlorcarbonicethylether. A similar rearrangement occurs when *o*-nitro phenylbenzoate is reduced in acid solution (Böttcher, *Ann. Chem. Pharm.*, **210**, 384). In determining the constitution of the oxyphenyl urethane Ransom made the diacyl derivative by using benzoyl chloride in alkaline solution. He also found that the same substance was produced when Böttcher's benzoyl *o*-aminophenol was treated with chlorcarbonicethylether in alkaline solution. In both cases saponification gave benzoic acid and oxyphenylurethane, indicating that in the latter case a molecular rearrangement of the diacyl derivative had occurred, so as to leave the lighter group attached to nitrogen. Other diacyl derivatives of *o*-aminophenol were made and in every case the lighter group was found attached to the amide nitrogen. If one of the amide hydrogens is first replaced by a hydrocarbon radical no rearrangement occurs, but isomeric substances are formed when the acyl groups are introduced in reverse order. The same is true when the amide and hydroxyl groups are in the meta or para position to each other.

It seemed desirable to determine whether the carboxylester group would become attached to nitrogen in the presence of a carbonyl group already attached to the same nitrogen; also whether of two carboxyl groups introduced the lighter one would go to the nitrogen. Finally it seemed of interest to determine if rearrangement would occur in case the radicals introduced were nearly of the same weight. If the rearrangement did not occur or proceeded more slowly than the others it was thought there would be a chance of studying more thoroughly the mechanism of the rearrangement.

OXYPHENYLISOAMYLURETHANE.

O-aminophenol was prepared by the reduction of the nitrophenol. Two grams of this were suspended in ether and the calculated amount (2 mol.) of chlorcarbonicisoamylether slowly added. The hydrochloride of one molecule of the aminophenol precipitated. After filtering, the ether solution was evaporated, leaving about two grams of a solid. It crystallized from ligroin in white needles melting at 68.5° - 69.5° . It is insoluble in cold water and acids, but is sparingly soluble in hot water and very soluble in chloroform, benzol, alcohol and ether. It is also quite soluble in dilute alkalis and from this solution is precipitated by acids thus showing its acid character.

The same substance was also produced by the reduction, with tin and acids, of o-nitrophenylisoamylcarbonate made by Ransom's method (*loc. cit.*). The melting point was the same, and a mixture of the two had the same melting point as either.

Another sample of the nitroisoamylcarbonate was reduced, but as soon as the action was complete the product was thrown into a concentrated (1:1) solution of potassium hydroxide kept cold in a freezing mixture. This solution was quickly extracted with ether and the ether solution dried with solid potassium hydroxide. When dry the ether solution was saturated with dry hydrochloric acid gas. A voluminous white precipitate separated which was filtered out and quickly dried on a porous plate in a desiccator. The melting point was 133° - 134° and the substance was quite soluble in cold water and acids, but alkalis precipitated an oil from the mixture. A small amount of this was dissolved in warm water and allowed to stand. Soon an oil separated which was extracted with ether. On evaporating the ether a solid remained which was soluble in alkalis and had all the properties of the urethane described above. Evidently the substance melting at 133° was the hydrochloride of o-aminophenylisoamylcarbonate which changed to the urethane on being warmed with water. In the dry condition the hydrochloride is moderately stable.

BENZOYL O-OXYPHENYLISOAMYLURETHANE.

One and five-tenths grams of the oxyphenylisoamylurethane were dissolved in a slight excess of a 10 per cent. solution of potassium hydroxide, and to this was added 0.8 grams (one mol.) of benzoyl chloride. Slowly a brown oil separated which solidified in an ice box. After extracting with ether and recrystallizing several times from dilute alcohol white needle shaped

crystals were obtained which melted at 64°-65.5°. It is insoluble in water, dilute acids and alkalis, but soluble in ether, chloroform, benzol, and alcohol. 0.2591 grams gave 10 c. c. of nitrogen at 22.5° and 748 mm. pressure. This is equivalent to 4.39 per cent nitrogen. Calculated for $C_{19}H_{21}NO_4$ equals 4.28 per cent.

To one gram of this diacyl derivative 2 c. c. of a 10 per cent. solution of alcoholic potash were added. Saponification began at once and when all had passed into solution it was acidified and extracted with ether. The ether solution was washed with a solution of sodium bicarbonate and the ether evaporated. The residue after recrystallization from ligroin melted at 68.5°-69.5°, and when mixed with the urethane having the same melting point no depression of melting point was observed. From the sodium bicarbonate solution, on acidifying, benzoic acid separated and was identified in the usual way. The result indicates that the benzoyl group was attached to oxygen.

ACTION OF CHLORCARBONICISOAMYLETHER ON BENZOYL O-AMINOPHENOL.

Benzoyl o-aminophenol was prepared following the method of Ransom. Two grams of this were dissolved in excess of a 10 per cent. solution of potassium hydroxide and 1.6 grams of chlorcarbonicisoamyl ether slowly added. On shaking, an oil slowly separated and this was extracted with ether. From the ether an oily residue was obtained which after several recrystallizations from alcohol formed a white solid melting at 64°-65.5°. A mixture with the supposed isomer had the same melting point. Saponification resulted in the production of benzoic acid and the urethane (m. p. 64°-65.5°). Evidently the benzoyl group in this, as in the former case, is attached to oxygen and must have shifted from its original attachment to nitrogen.

ACTION OF CHLORCARBONICETHYLETHER ON OXYPHENYLISOAMYLURETHANE.

One and one-fourth grams of oxyphenylisoamylurethane were dissolved in 4 c. c. of a 10 per cent. solution of potassium hydroxide and to this was added 0.7 grams of chlorcarbonicethylether. A heavy red oil separated. This was extracted with ether and the ether solution washed successively with dilute alkali, dilute acid and water. It was then dried with calcium chloride and the ether allowed to evaporate. The oil did not solidify. It was distilled under a pressure of 16 mm. at 185°-200°, the distillate soon solidifying to a yellow crystalline mass. After several recrystallizations

from dilute alcohol the crystals became white and melted at 65°-66°. It is insoluble in water, acids and alkalis, but soluble in alcohol, ether, chloroform, and benzol.

ACTION OF CHLORCARBONICISOAMYLETHER ON OXYPHENYLETHYLURETHANE.

The ethylurethane was prepared according to Ransom's method and two grams of it were dissolved in a slight excess of potassium hydroxide. To this was added the calculated amount (1 mol.) of chlorcarbonicisoamylether. After shaking, a light yellow oil separated which became darker on standing. This was extracted with ether and the ether allowed to evaporate. An oil remained which refused to solidify even in a freezing mixture. It was distilled under a pressure of 15 mm. at 184°-190°, the distillate solidifying to a crystalline mass. After several recrystallizations it became white and melted at 65°-66°. It has all the properties of its supposed isomer above described. On saponifying some of the impure material two substances were obtained. A part melted at 133°-134° and is probably carbonylamino-phenol produced from the urethane by loss of alcohol. The other part after purification melted at 84°-85° and on mixing with oxyphenylethylurethane (m. p. 86-87) the melting point was raised slightly. Evidently the carbethoxy group remains attached to nitrogen and no rearrangement occurs in preparing the diacyl derivative by this method. Since the supposed isomer is identical with this, there must have been a rearrangement during its preparation in the sense that the two carboxyl radicals exchanged places, the lighter changing from oxygen to nitrogen. The following equations express the reactions involved and the rearrangement that must have occurred in one case. $\text{KOC}_6\text{H}_4\text{NHCOOC}_5\text{H}_{11} + \text{ClCOOC}_2\text{H}_5 > \text{C}_2\text{H}_5\text{OOCOC}_6\text{H}_4\text{NHCOOC}_5\text{H}_{11} + \text{KClC}_2\text{H}_5\text{OOCOC}_6\text{H}_4\text{NHCOOC}_5\text{H}_{11} > \text{C}_5\text{H}_{11}\text{OOCOC}_6\text{H}_4\text{NHCOOC}_2\text{H}_5$. The final product is *o*-oxyphenylethylurethaneisoamylecarbonate.

SUMMARY.

The work here outlined, together with that previously reported, shows that when two carboxyl radicals (COOR and COOR_1) are introduced into the molecule of ortho aminophenol the lighter one becomes attached to the amide nitrogen, the position not being influenced by the order in which the groups are introduced. And that to accomplish this a molecular rearrangement occurs in one case. This is also true when both radicals are carbonyls (COR and COR_1). In case one radical is carbonyl and the other carboxyl the latter

becomes attached to nitrogen without being influenced by the relative weights of the entering groups. The hope that the introduction of radicals of nearly the same weight (C_6H_5CO — 105, $C_5H_{11}COO$ — 115) would result in the formation of isomeric substances was not realized, the velocity of the rearrangement being almost instantaneous in every case. Consequently the mechanism of the rearrangement cannot be explained. It is possible that there is an equilibrium of the two isomeric forms and that one of them is in large excess, but there is little evidence to support this view. Work already begun with the orthoaminomercaptans may throw light upon the problem.

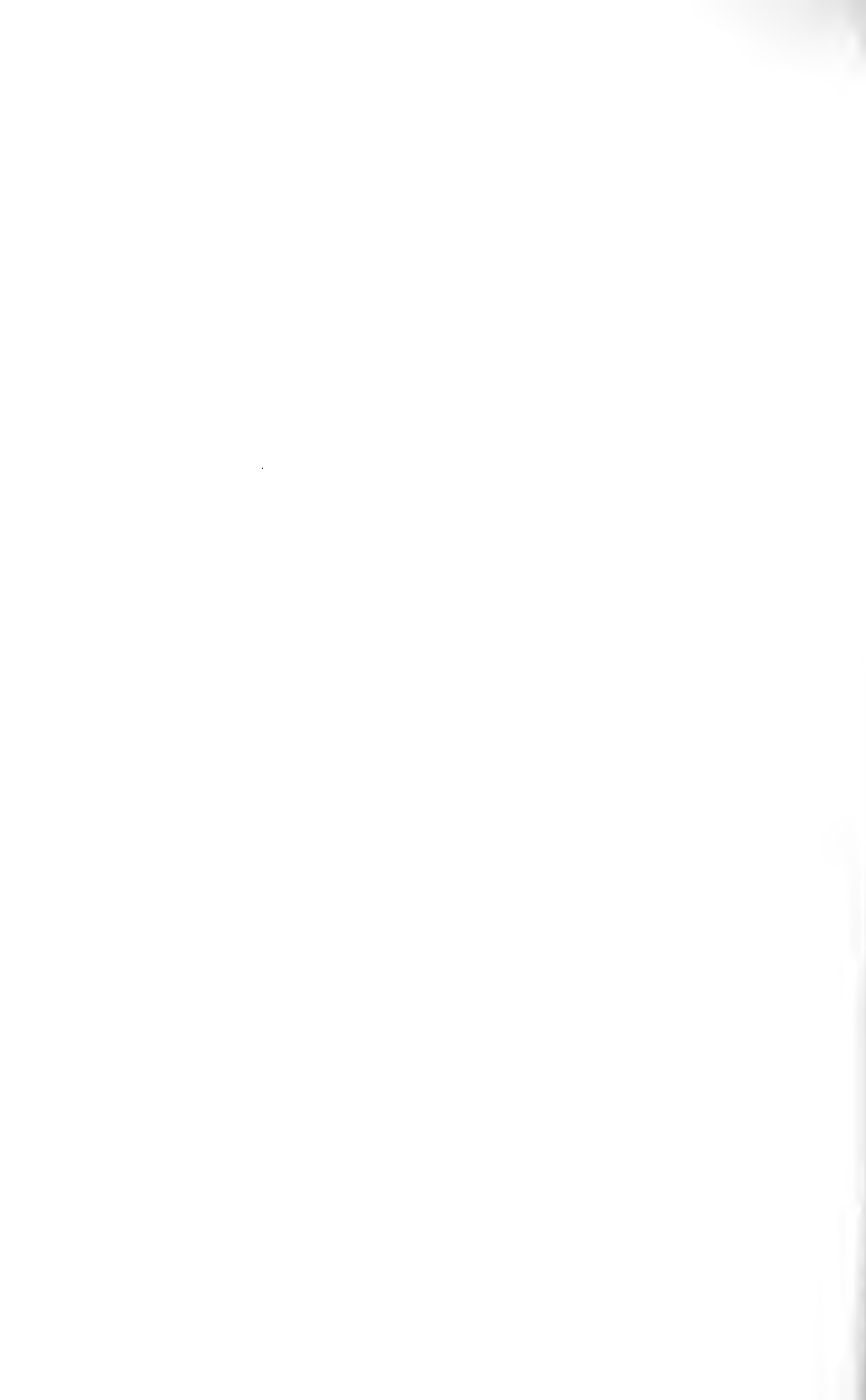

BOILING AND CONDENSING POINTS OF ALCOHOL WATER MIXTURES.

P. N. EVANS.

The boiling points of mixtures of alcohol and water depend on the proportions of the constituents and range from about 70° C. for pure ethyl alcohol to 100° C. for pure water. Except at a concentration of about 92 per cent. alcohol by weight (about 96 per cent. by volume) any mixture of alcohol and water when boiled gives off a vapor of different composition from the liquid, the vapor being richer or poorer in alcohol than the liquid when the latter contains respectively less or more than 92 per cent. of alcohol. The vapor has, of course, a condensing point identical with the true boiling point of the liquid from which it is given off.

The purpose of the work here reported was to ascertain experimentally the relation between the boiling point (or condensing point) and the composition of both the liquid and vapor phases, so that with the information so obtained it would be possible by observation of the corrected boiling point to learn the composition of the boiling liquid and of the condensing vapor.

PROCEDURE.

The gravity and temperature of a strong alcohol were determined with a Westphal balance, and the weight-per cent. of alcohol calculated by means of Mendelejeff's table. Five hundred cubic centimeters were placed in a one-liter distilling flask with an accurate thermometer graduated in tenths of a degree placed with its bulb just below the side-neck. The liquid was then slowly distilled at a uniform rate of about one drop per second until 15 c. c. had passed over, the distilling temperature being read when 7.5 c. c. had collected in the graduated receiver. The per cent. of alcohol in the distillate and in the residue was determined from the gravity as before.

The average of the percentages found in the liquid in the flask before and after distillation was taken as that of the liquid phase, and the percentage in the distillate as representing the vapor phase at a moment half-way through the distillation when the boiling point was observed.

The original volume of the liquid in the flask was restored by the addition of 15 c. c. of water, and the slightly more dilute mixture so obtained was used for the next experiment. Forty-three mixtures were investigated in this way, ranging from 91 to 0 per cent. of alcohol.

Corrections were introduced in the temperature readings for the barometric pressure and for the exposed column of mercury in the thermometer, assuming that the barometer effect would be the same as in the case of water—an assumption very nearly in accordance with the facts, as shown by the tables of Regnault and Classen given in Biedermann's *Chemiker-Kalender*.

RESULTS.

The temperature results are probably accurate within 0.2 degrees, and the concentrations within 2 per cent.

The results obtained are given in the following table:

Number.	Gravity before distillation.	Temperature during gravity determination.	Per cent. alcohol before distillation.	Gravity of residue.	Temperature during gravity determination.	Per cent. alcohol in residue.	Average per cent. alcohol in liquid.	Gravity of distillate.	Temperature during gravity determination.	Per cent. alcohol in distillate.	Observed temperature of distillation.	Barometer.	Barometer correction in boiling point.	Room temperature.	Correction for exposed mercury column.	Corrected boiling point.
1	.815	20	91.1	.812	23	91.1	91.1	.811	22	91.8	77.2	750	.4	23	.6	78.2
2	.822	22	87.7	.821	23	87.7	87.7	.815	23	90.0	77.2	750	.4	22	.6	78.2
3	.829	23	84.6	.829	23	84.6	84.6	.819	22	89.6	77.4	750	.4	22	.6	78.4
4	.836	24	81.5	.838	22	81.5	81.5	.823	22	88.0	77.6	748	.5	22	.6	78.7
5	.845	22	78.7	.843	25	78.8	78.8	.825	22	86.5	77.7	743	.7	22	.6	79.0
6	.852	22	75.8	.851	23	75.8	75.8	.827	22	85.8	77.8	740	.8	22	.6	79.2
7	.857	24	72.9	.860	21	72.9	72.9	.829	23	84.6	78.1	741	.8	22	.6	79.5
8	.864	23	70.4	.866	23	69.6	70.0	.832	22	83.8	78.4	741	.8	23	.6	79.8
9	.873	21	67.5	.873	21	67.5	67.5	.833	20	84.2	78.6	743	.7	21	.6	79.9
10	.879	21	65.0	.880	21	64.6	64.8	.835	20	83.5	78.9	743	.7	21	.6	80.2
11	.884	21	62.7	.885	23	61.4	62.0	.838	19	82.7	79.1	743	.7	21	.6	80.4
12	.891	22	59.2	.893	20	59.2	59.2	.839	20	81.9	79.5	750	.4	21	.6	80.5
13	.898	20	57.1	.899	21	57.5	57.3	.839	21	81.5	79.6	750	.4	21	.6	80.6
14	.904	21	54.1	.904	23	53.2	53.6	.839	23	80.8	80.2	757	.1	23	.6	80.9
15	.908	23	51.4	.910	22	51.0	51.2	.840	21	81.2	80.3	756	.2	22	.6	81.1
16	.915	22	48.6	.916	22	48.2	48.4	.842	21	80.4	80.5	756	.2	22	.6	81.4
17	.920	22	46.4	.923	22	45.0	45.7	.843	20	80.4	80.8	756	.2	22	.6	81.7
18	.926	23	43.8	.928	22	42.5	43.1	.844	21	79.6	81.0	756	.2	22	.6	81.8

Number.	Gravity before distillation.	Temperature during gravity determination.	Per cent. alcohol before distillation.	Gravity of residue.	Temperature during gravity determination.	Per cent. alcohol in residue.	Average per cent. alcohol in liquid.	Gravity of distillate.	Temperature during gravity determination.	Per cent. alcohol in distillate.	Observed temperature of distillation.	Barometer.	Barometer correction in boiling point.	Room temperature.	Correction for exposed mercury column.	Corrected boiling point.
19	.923	22	40.5	.932	25	40.0	40.2	.845	20	79.6	81.2	755	.2	19	.6	82.0
20	.936	24	38.0	.938	23	37.5	37.7	.848	19	78.8	81.5	755	.2	20	.6	82.3
21	.940	24	36.0	.942	23	35.5	35.7	.846	20	79.2	81.6	755	.2	20	.7	82.5
22	.945	23	33.9	.947	22	33.3	33.6	.849	19	78.3	82.0	755	.2	20	.7	82.9
23	.949	23	31.7	.950	23	31.1	31.4	.851	20	77.1	82.4	755	.2	21	.7	83.3
24	.952	24	30.0	.955	23	28.1	29.0	.853	20	76.2	82.7	756	.2	21	.7	83.6
25	.956	23	27.5	.956	25	26.9	27.2	.853	21	75.8	82.5	748	.5	20	.7	84.0
26	.958	24	26.2	.961	22	24.7	25.4	.856	22	74.2	83.4	748	.5	22	.8	84.7
27	.962	23	23.7	.964	23	22.3	23.0	.858	19	73.7	83.7	750	.4	21	.8	84.9
28	.965	23	21.7	.966	23	21.0	21.3	.859	20	73.7	84.3	750	.4	21	.8	85.7
29	.966	23	21.0	.969	23	18.9	19.9	.860	22	72.5	84.8	747	.5	22	.8	86.1
30	.970	23	17.9	.972	22	16.7	17.3	.866	22	70.0	85.5	745	.6	23	.8	86.9
31	.973	22	15.8	.974	24	14.4	15.1	.865	23	70.0	86.2	747	.5	23	.8	87.5
32	.975	24	13.3	.977	25	12.3	12.8	.873	23	66.7	86.9	756	.6	24	.9	88.4
33	.977	25	12.3	.979	25	11.0	11.6	.882	24	62.5	88.1	748	.5	25	.9	89.5
34	.980	22	11.0	.982	23	9.3	10.1	.891	21	60.0	89.1	750	.4	22	.9	90.3
35	.982	23	11.0	.984	24	7.9	9.4	.901	20	55.8	90.1	750	.4	22	.9	91.4
36	.985	22	7.9	.987	22	6.4	7.1	.910	22	51.4	91.1	750	.4	22	.9	92.4
37	.987	22	6.4	.989	20	5.0	5.7	.919	22	46.8	92.2	750	.4	23	.9	93.5
38	.990	21	4.4	.991	23	3.9	4.1	.927	22	43.7	93.1	747	.5	21	.9	94.5
39	.991	23	3.9	.992	24	2.8	3.3	.947	21	33.5	94.3	747	.5	22	.9	95.7
40	.992	24	2.8	.994	22	2.2	2.5	.953	21	30.6	95.2	747	.5	22	.9	96.6
41	.995	22	1.7	.996	21	1.1	1.4	.964	21	23.6	96.0	747	.5	22	.9	97.4
42	.996	22	1.1	.996	23	0.9	1.0	.972	22	16.7	96.8	751	.4	22	.9	98.1
43	.998	25	-0.5	.999	22	-0.3	-0.4	.999	21	-0.1	98.7	753	.3	22	.9	99.9

The last experiment (No. 43) was with water only.

The relations existing between the boiling point or condensing point and the composition of the liquid and vapor phases are shown clearly by the following plot:

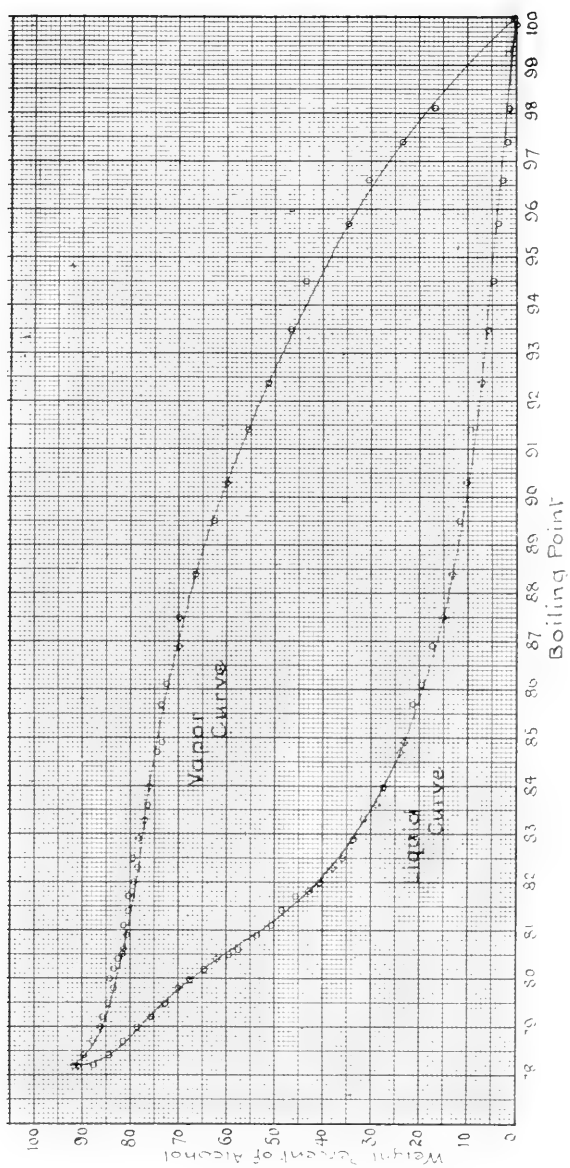

A convenient table of results estimated from the curves is here given:

Boiling Point.	Weight Per Cent. Alcohol in		Boiling Point.	Weight Per Cent. Alcohol in	
	Liquid.	Vapor.		Liquid.	Vapor.
78.2	91	92	86.5	18	71
78.4	85	89	87.0	17	70
78.6	82	88	87.5	16	69
78.8	80	87	88.0	15	68
79.0	78	86	88.5	13	67
79.2	76	85	89.0	12	65
79.4	74	85	89.5	11	63
79.6	72	84	90.0	10	61
79.8	69	84	90.5	10	59
80.0	67	83	91.0	9	57
80.2	64	83	91.5	8	55
80.4	62	82	92.0	8	53
80.6	59	82	92.5	7	51
80.8	56	81	93.0	6	49
81.0	53	81	93.5	6	46
81.2	50	80	94.0	5	44
81.4	47	80	94.5	5	42
81.6	45	80	95.0	4	39
81.8	43	79	95.5	4	36
82.0	41	79	96.0	3	33
82.5	36	78	96.5	3	30
83.0	33	78	97.0	2	27
83.5	30	77	97.5	2	23
84.0	27	76	98.0	1	19
84.5	25	75	98.5	1	15
85.0	23	74	99.0	0	10
85.5	21	73	99.5	0	5
86.0	20	72	100.0	0	0

The information here given enables one to determine quickly the approximate concentration of any alcohol-water mixture by observation of its boiling point, with corrections for barometric pressure and exposed mercury column. The accuracy is, of course, less than by the usual and more difficult analytical method of distillation and the determination of the gravity of the distillate with a pycnometer.

It is also possible to tell the approximate composition of both liquid and vapor (or distillate) at any moment during the distillation of a mixture. This application has proved interesting in interpreting the behavior of alcohol-water mixtures during distillation and partial condensation in the writer's laboratory classes.

It is the intention to continue the experiments by examining mixtures containing over 92 per cent. of alcohol; the observations will require greater accuracy, and a differential thermometer graduated in hundredths of a degree will be employed.

*Purdue University,
Lafayette, Ind.*

(Abstract.)

ON THE GENERAL SOLUTION AND SO-CALLED SPECIAL SOLUTIONS OF LINEAR NON HOMOGENEOUS PARTIAL DIFFERENTIAL EQUATIONS.

L. L. STEINLEY.

The integrals of a partial differential equation of the first order were first classified by Lagrange, who separated them into three groups, namely, the general, the complete, and the singular integrals. For a long time this classification was thought to be complete. In fact, Forsyth in his *Differential Equations*, published first in 1885, gives a supposed proof of a theorem stating that every solution of such a differential equation is included in one or other of the three classes named. This error is also carried through the second and third English editions and the two German editions, the last one being published in 1912.

In 1891 Goursat pointed out in his *Equations aux derivees partielles du premier ordre*, that solutions exist which do not belong to any of these three classes and showed indeed that the existing theory was not complete even for the simplest forms.

In November, 1906, Forsyth, in his presidential address to the London Mathematical Society, emphasized the fact that the theory is incomplete, and in his closing remark says: "It appears to me that there is a very definite need for a re-examination and a revision of the accepted classification of integrals of equations even of the first order; in the usual establishment of the familiar results, too much attention is paid to unspecified form, and too little attention is paid to organic character, alike of the equations and of the integrals. Also, it appears to me possible that, at least for some classes of equations, these special integrals may emerge as degenerate form of some semi-general kinds of integrals; but it is even more important that methods should be devised for the discovery of these elusive special integrals."

Forsyth also in an address delivered by request, at the 4th International Congress of Mathematicians, takes advantage of the opportunity offered, to

again emphasize the incompleteness of the existing theory of partial differential equations of the first order.

In attacking this problem the logical place to begin is with the simplest case, namely, with the linear equation. This is the equation dealt with in the paper. It can be written in the form

$$\sum_{i=1}^n \chi_i \left[\mathbf{z}, X_1, X_2, \dots, X_n \right] = \mathbf{Z} \left[\mathbf{z}, X_1, X_2, \dots, X_n \right].$$

The restrictions made on this equation are that all common factors have been removed from $\mathbf{Z}, X_1, X_2, \dots, X_n$; that there is also a set of values of the variables $\mathbf{z}, X_1, X_2, \dots, X_n$ in the vicinity of which the functions X_i and \mathbf{Z} have no branch points and otherwise behave regularly.

Forsyth, in his treatise on *Partial Differential Equations* published in 1906 goes to much labor to give solutions that are examples of the so-called special integrals. In the present paper a means is developed by which all the elusive special integrals can be readily determined and a new and complete classification is given of all the integrals of the equation.

A MODIFIED PERMEAMETER.

EDWIN MORRISON AND B. D. MORRIS.

In his work on the Magnetic Induction in Iron and Other Metals, Ewing briefly describes a permeameter. (See page 247, Art. 148.) The instrument is for the purpose of determining the magnetisation of a metal by means of the tractive force. In Ewing's work the permeameter method constitutes the fourth method of measuring the magnetic properties of a metal, that of the ballistic, the direct magnetometric, and the optical methods having been

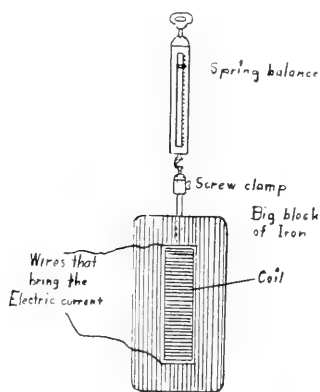

Fig. 130.

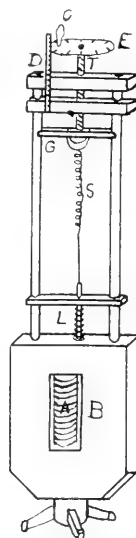

Fig. 1

previously described. After describing the apparatus and developing the equations the author closes his discussion thus: "The tractive method is at best inexact, but it affords a ready means of making rough measurements, especially for purposes of comparison."

Two primary objects were sought in modifying the Thompson Permeameter as shown in Ewing's work, Fig. 130, page 249: First, to render the instrument more accurate, and Second, to avoid complexity such as is necessary in the ballistic method so that the magnetic properties of iron may be introduced earlier in a students' course.

The modified apparatus is shown in Fig. 1. The solenoid (A) is surrounded by a cast iron field (B) which furnishes a metal path for the return lines of force. The lug (L) is separated from the core of the solenoid by a very thin piece of paper. The core of the coil can be easily replaced by a core of a different metal, thus giving a different test. The force required to separate the lug from the core is measured by means of the spring (S). Since the pull exerted by a spring is directly proportional to the distance it is stretched it becomes necessary simply to measure accurately the distance the spring is stretched in separating the lug (L) from the core. The upper end of the spring is attached to a sliding guide bar (G), to which is fastened a micrometer screw (T). By turning this micrometer screw the spring may be stretched sufficiently to pull the lug away from the core which is being tested. The number of whole turns of the screw may be read from the index bar (D), and the fractional part of a turn to one-tenth of a turn may be read from the disk (E.) By standardizing the spring and reading micrometer by means of known weights the force in screw turns may be reduced to grams or pounds.

The permeameter with the auxiliary apparatus is set up as shown in Fig. 2.

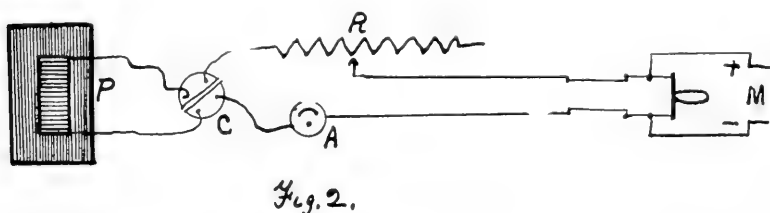

P, is the permeameter.

C, is a rotary commutator by means of which an alternating current may be thrown through the solenoid, thus demagnetizing the core.

R, is a variable resistance by means of which the current may be varied from zero to twenty-five amperes.

A, is an ammeter.

M, represents the source of current, which is the ordinary 110 volt direct lighting current.

The method of obtaining data is as follows: First demagnetize the core specimen to be tested by rotating the rotary commutator, thereby causing an alternating current to flow through the solenoid. When the specimen is demagnetized it will exert no pull on the lug (L). Next pass a very slight current through the solenoid, place the lug in contact with the core and turn the crank until the lug and core are separated. The number of turns can be read directly from the slide index (D) and the disk (E). The current strength is read from the ammeter. The current is then increased and the force measured which is required to separate the lug and core. This process is continued, noting in each instance the current strength and the pulling force of the spring, until the pulling force ceases to increase with an increase of current, indicating that the core is saturated. The current is now decreased step by step and the pulling force and the current strength noted in each case. When the current reaches zero it is reversed and the process indicated above is repeated. When the current is again brought back to zero it is reversed the second time and increased to the point of saturation. Thus data for the complete hysteresis loop may be taken.

The equations for transforming the results from a permeameter into the B and H values for plotting the hysteresis loop are as follows. (See Ewing's work page 248.)

$$\text{Pull in lbs.} = \frac{(B - H)^2 \times S(\text{sq. cm.})}{11183000}$$

$$\text{or } B = 3344 \sqrt{\frac{\text{Pull in lbs.}}{S(\text{sq. cm.})}} + H$$

$$\text{or } B = 1317 \sqrt{\frac{\text{Pull in lbs.}}{S(\text{sq. cm.})}} + H$$

The value of H may be determined by the following equation, in which N is the number of turns, I the current strength in amperes and l is the length of the solenoid in cm.

$$H = \frac{1.26 N I}{l}$$



Fig. 5.

DATA.

Length of solenoid, 9.5 cm. Number of turns, first coil 176, second coil 273. The force of the spring represented by one turn of the micrometer screw is 13 grams or 0.028 lb.

Record for a Cold Rolled Steel Rod 0.5 in. Diam. Coil 176 Turns.

Amp. I.	Pull in Turns.	Pull in Pounds.	Amp. I.	Pull in Turns.	Pull in Pounds.	Amp. I.	Pull in Turns.	Pull in Pounds.
0.0	0.0	0.0000	0.0	1.0	0.028	0.0	1.0	0.028
0.4	0.4	0.0112	0.4	0.3	0.008	0.4	0.2	0.006
0.8	3.0	0.0840	0.8	2.5	0.060	0.8	2.0	0.056
1.2	10.5	0.294	1.2	9.0	0.262	1.2	8.5	0.238
1.6	17.0	0.4761	1.6	18.0	0.484	1.6	19.0	0.541
2.0	22.0	0.6160	2.0	26.0	0.628	2.0	25.0	0.700
2.5	28.0	0.7840	2.5	28.5	0.798	2.5	30.0	0.840
3.5	35.0	0.9800	3.5	36.0	1.008	3.5	35.0	0.980
4.5	36.0	1.0080	4.5	40.0	1.120	4.5	39.0	1.094
5.0	38.0	1.0640	5.0	40.0	1.120	5.0	40.0	1.120
5.5	38.0	1.0640	5.5	40.0	1.120	5.5	41.0	1.18
6.0	39.0	1.0940	6.0	40.0	1.120	6.0	41.0	1.148
5.5	39.0	1.0940	5.5	40.0	1.120			
5.0	38.0	1.0640	5.0	40.0	1.120			
4.5	39.0	1.0940	4.5	40.0	1.120			
3.5	37.0	1.0360	3.5	8.0	1.064			
2.5	32.0	0.8960	2.5	36.0	1.008			
2.0	28.0	0.7840	2.0	31.0	0.868			
1.6	27.5	0.7700	1.6	28.0	0.784			
1.2	23.0	0.6440	1.2	24.0	0.672			
0.8	17.0	0.4761	0.8	18.0	0.484			
0.4	6.0	0.1642	0.4	8.0	0.204			
0.0	1.0	0.0280	0.0	1.0	0.028			

Above Results Converted into H and B Values.

Amp.			Amp.			Amp.		
I.	H.	B.	I.	H.	B.	I.	H.	B.
0.0	0.00	0.00	0.0	0.00	497.79	0.0	0.00	497.79
0.4	9.32	324.14	0.4	9.32	307.82	0.4	9.32	239.75
0.8	18.64	878.84	0.8	18.64	742.27	0.8	18.64	747.30
1.2	27.96	1642.76	1.2	27.96	1550.66	1.2	27.96	1480.26
1.6	37.28	2137.28	1.6	37.28	2106.88	1.6	37.28	2225.33
2.0	46.60	2381.40	2.0	46.60	2404.10	2.0	46.60	2525.60
2.5	58.25	2692.25	2.5	58.25	3039.95	2.5	58.25	2617.25
3.5	81.55	3025.75	3.5	81.55	3173.05	3.5	81.55	3025.75
4.5	104.85	3000.95	4.5	104.85	3253.05	4.5	104.85	3216.35
5.0	116.50	3185.10	5.0	116.50	3264.70	5.0	116.50	3264.70
5.5	128.15	3196.75	5.5	128.15	3276.35	5.5	128.15	3315.50
6.0	139.80	3255.30	6.0	139.80	3288.00	6.0	139.8	3327.15
5.5	128.15	3243.65	5.5	128.15	3276.35			
5.0	116.50	3185.10	5.0	116.50	3264.70			
4.5	104.85	3220.35	4	104.85	3253.05			
3.5	81.55	3162.25	3.5	81.55	3150.05			
2.5	58.25	2874.15	2.5	58.25	3149.75			
2.0	46.60	2680.60	2.0	46.6	2818.10			
1.6	37.28	2647.60	1.6	37.28	2671.28			
1.2	27.96	2451.96	1.2	27.96	2466.56			
0.8	18.64	2071.04	0.8	18.64	2088.24			
0.4	9.32	1215.02	0.4	9.32	1352.92			
0.0	0.00	497.79	0.0	0.00	479.79			

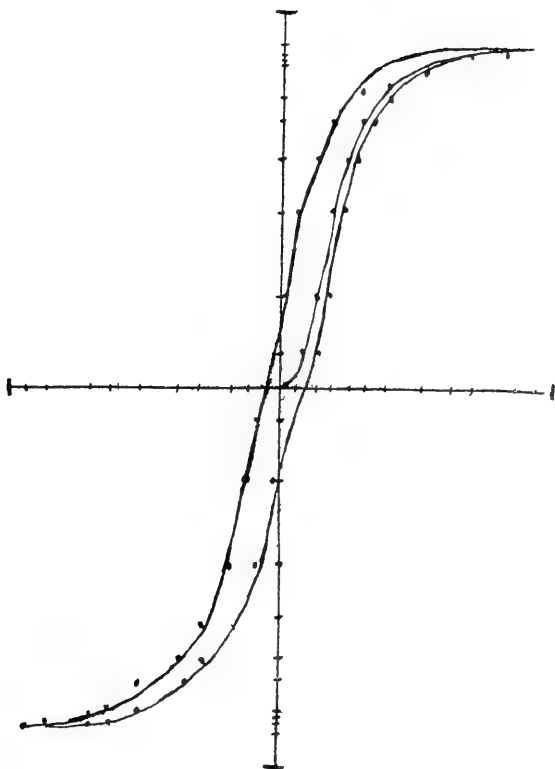

Fig. 4. Hysteresis Plot.

CONCLUSIONS.

The plot here given establishes the fact that the magnetic properties of iron and steel can be obtained by the permeameter method to a reasonable degree of accuracy, sufficient for student purposes.

From a number of tests which have been made the permeameter establishes in an interesting way the fact that a much stronger current is required to bring a hard metal to magnetic saturation than a soft metal.

The permeameter test also demonstrates that the magnetic pull exerted by a soft metal is much stronger than that of a hard metal under the influence of the same current.

These peculiarities are more easily shown by this instrument than any toher, owing to the fact that different metals can be examined under the same conditions.

Physical Laboratory, Earlham College.

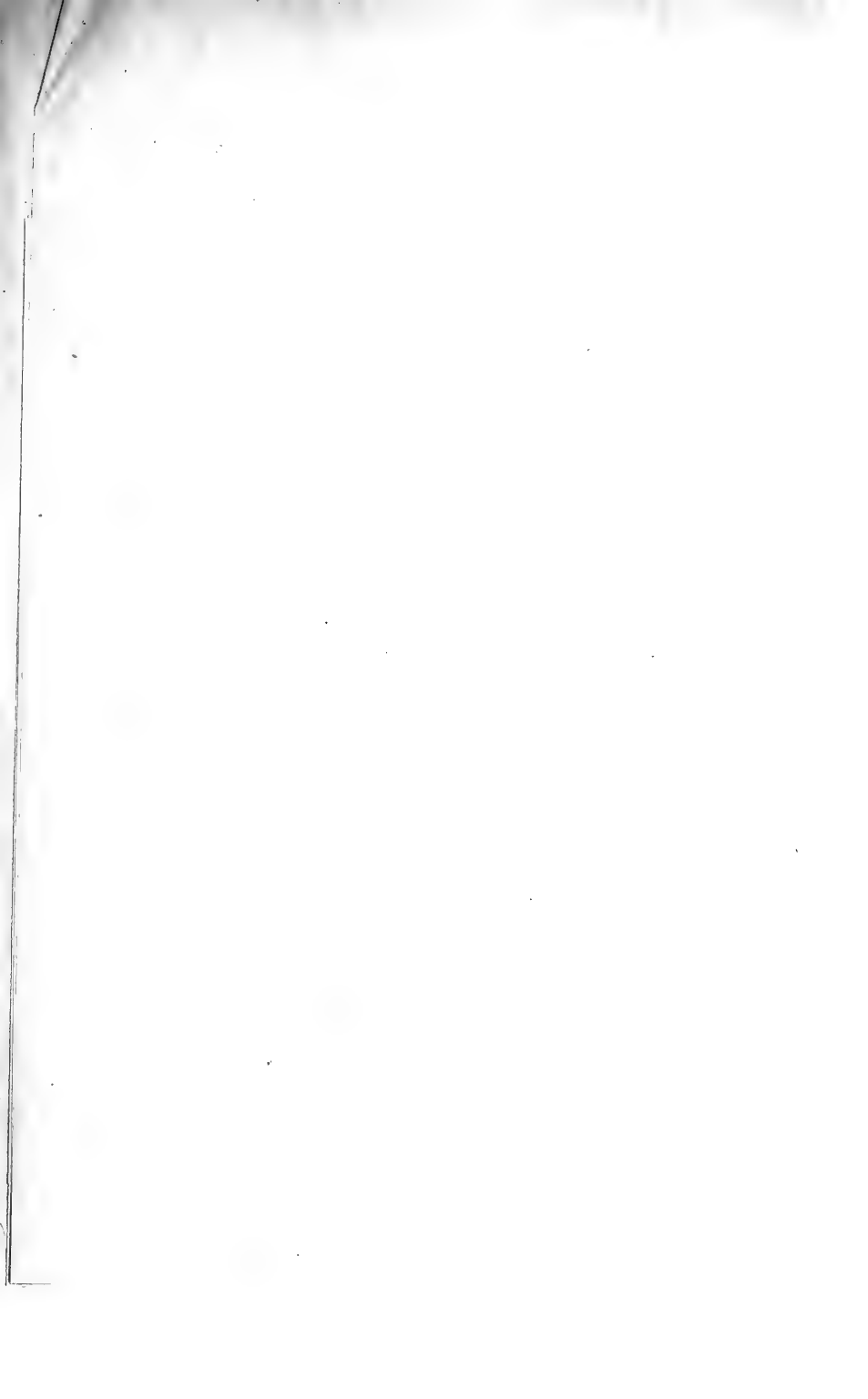



**SPECIAL
WATER AND SEWAGE
INVESTIGATIONS**

WATER - - ●
SEWAGE - - ○

OCT. 1, 1907, TO OCT. 1, 1913

SANITARY SURVEY OF INDIANA RIVERS.

JAY A. CRAVEN, C. E.

In August, 1908, the investigation by the Indiana State Board of Health of the southern end of Lake Michigan bordering Indiana revealed a serious condition. It was found that the Lake water was "grossly polluted and unfit for use as a source of water supply for drinking and domestic purposes." The zone of pollution extended for five miles from shore. Although Indiana Harbor, East Chicago, Whiting and a portion of Hammond contributed domestic sewages directly to the Lake, it was found that this apparently had little influence on the character of the Lake waters. The main source of pollution was found to be the Calumet River with its great volume of sewage and manufacturing wastes. The portion of the lake investigated is readily seen on the accompanying map.

The deplorable situation called for a more thorough survey of the condition, and to this end preparations and plans were made for an investigation of the Calumet River, to determine the "exact condition of the river, the amount and kind of pollution entering it from the Indiana cities, how it was disposed of, and if possible, through its report to lend assistance for the final solution of the problem which faces the Indiana cities and also a part of Chicago."

About twenty-five miles of the Grand Calumet River was surveyed in the summer of 1910. It has a varying width of from twenty-five to three hundred feet and an average depth of six to eight feet until it reaches Lake Calumet, from which point it averages twenty-five feet. It receives most of the sewage and trade wastes from the four cities along its banks, together with a portion of that of Chicago. Many large manufacturing concerns contributed a large part of the most offensive refuse.

Forty-three sampling points were established in the East Chicago canal, the Grand Calumet River, The Little Calumet River and Lake Michigan. Samples for the putrescibility reaction, oxygen consumed and dissolved, were collected at all the sampling points and sewer outlets over

a period extending from June 29th to August 1st. In addition to this, bacterial analyses were made on river samples during that period. The portion of the river investigated is shown on the map of Indiana.

The results of this work were summarized as follows: "It appears that the Calumet River is, for a part of its course, a septic tank, in which the sewage entering it travels but a short distance from its point of entrance before undergoing putrefaction." As the conditions were serious, involving the health of the people of several cities and extending over a large territory, it was thought that the problem could be more advantageously dealt with by the formation of a sanitary district to study the conditions and reach a final solution, and it was so recommended.

At the same time these conditions along the lake were being investigated, the states bordering the Ohio River were much concerned with the condition of the river and a preliminary survey had been made of that portion of it bordering Ohio by the Ohio State Board of Health. Indiana was next in line in doing similar work along its borders, and in the summer of 1911 that portion of the river lying between Cincinnati, Ohio, and the mouth of the Wabash River, a distance of 357 miles, was surveyed. A houseboat was equipped for the survey in which living and working quarters were provided, and it was found to be admirably adapted to the work.

The total drainage basin to the Ohio-Indiana line is 80,947 square miles, and the population located on this area was about 8,000,000. Four hundred and fourteen samples were collected for chemical and bacterial analysis, 333 of which were river samples.

With the exception of three or four points in the river, and these at or near the entrance, the analysis did not show a serious condition to exist, one which at the stage of water encountered would create a nuisance. At no point along the river was the raw water found to be fit for drinking purposes, however.

One noticeable feature that should be mentioned is the high typhoid death rate in the cities using raw river water, and the decrease in the rate after the introduction of filter plants where this step had been taken. At Cincinnati for three years before filtered water was used the average rate was 64.0 per 100,000 and the average rate for the three years following the introduction of filtered water was 12.6.

As an Indiana problem alone, future investigations could be limited

to Cincinnati, Louisville or Evansville, and as the former are much the larger, contributing therefore a much larger amount of sewage and wastes, active steps toward an abatement of the problem at these two places will have to be taken before Indiana is affected. The question of the disposal of manufacturing wastes is a comparatively easy one for Indiana manufacturers. It is an individual problem for each concern to solve, but there are very few where a treatment of the waste would be required, and then only after the problem has been taken up at all points along the river.

In the report made in 1911 it was said that the problem was not one for the individual states, but that it would have to be controlled by the Federal Government, and preparations are now being made by the Government for a thorough survey of the entire river.

Continuing the policy of surveying our rivers, and therefore our natural water supplies, a survey of the Wabash River was made in the summer of 1912. From the experience gained the previous summer, a two-roomed houseboat was built, one room to be used for the laboratory work and the second for living quarters. The work covered the river from Bluffton near its source to the mouth, a distance of 450 miles. Because of the shallowness of the river at the upper end, this portion was covered in a rowboat, and samples shipped to Lafayette to the houseboat laboratory. From this point down, the houseboat was used. Eight hundred and twenty-three samples were collected for a chemical and bacterial analysis, 696 of them from the river.

At no point was the river seriously polluted; i. e., a nuisance did not exist. At a few places, however, as at Wabash, where a large strawboard plant is located; at Lafayette, where there is another one; at Terre Haute, with many manufacturing concerns, and at Vincennes, with its strawboard works and distilleries, considerable pollution was found. As this condition was always below the cities and they were not bothered, and the natural purification of the river remedied this condition before the cities and towns below were reached, no complaints were heard. The population on the watershed is not large in comparison with its size, and the flow is sufficient to care for the sewage and wastes by dilution.

Although from a physical standpoint the river was found to be in good condition, the analyses showed that it was unfit in its raw state for drinking and domestic purposes, and that it would be necessary to filter

the water to make it potable. The great burden imposed upon a filtration plant by the use of the river for the disposal of sewage and manufacturing wastes in constantly increasing quantities, should be lessened as much as possible. Some degree of purification of all manufacturing wastes and domestic sewage should be required. Partial purification, such as screening or the passing the sewage and wastes through Imhoff tanks, will give a satisfactory effluent for some time to come. Some such treatment should therefore be required of all cities and towns and manufacturing concerns, and it was so recommended.

Last summer similar work was done on White River from Winchester, near the source, to the mouth, a distance of about 388 miles being covered. From Winchester to Muncie the trip was made on foot; from Muncie to Indianapolis a rowboat was used; between Indianapolis and Martinsville, information and samples were collected in an auto, and from Martinsville down, the houseboat which had been used on the Wabash River was again put in service. It had been brought up to this point during the early spring.

Navigation was more difficult than had been previously experienced, and many obstructions in the way of snags and sand bars were met. Altogether 779 samples were collected, 334 of them from the river. The river for about 100 miles below Indianapolis was found to be in a serious condition, due to the great amount of sewage and manufacturing wastes introduced into the river at Indianapolis. The flow of the river during dry seasons is entirely too small to care for this great amount of sewage, and the only remedy for the situation is the treatment of this refuse, which has already been begun in an experimental way. When Indianapolis has relieved its portion of the pollution, other cities will have to do likewise, and in this way, the condition of the river will gradually be restored to as near its original state as possible.

Altogether, a total distance of 1,195 miles were covered in the survey of the last three rivers, and over 2,000 samples were analyzed, 1,363 of them river samples. The work done has revealed serious conditions on two of the rivers, the Calumet and White, steps for the improvement of which have already been taken. In the case of the other two, steps for the restoration of the water to its former condition should be taken, and future pollution prohibited. The accompanying map shows the extent of the work done on Indiana rivers.

These surveys have shown the need of more legislative power, to be vested in a central authority, naturally the State Board of Health, whereby the rivers, our natural water resources, can be saved for future generations. At the present time control of streams is given where they are used for water supplies, but no steps can be taken by the Board of Health unless petitioned by the health officer or citizens of the locality affected. The time is coming, and the sooner such control is given the easier will be the solution of the problem. The data collected will be invaluable in the future for comparative purposes, when the people become awakened to the seriousness of stream pollution.

THE RELATION OF LAKES TO FLOODS, WITH SPECIAL REFERENCE TO CERTAIN LAKES AND STREAMS OF INDIANA.

WILL SCOTT.

The problem of flood prevention is a part of a larger problem which we have considered either in a fragmentary way or not at all. This larger problem is the development of the waters of our state as a natural resource. To regard a river as a menace because its higher stages, under present conditions, are destructive; or to consider a lake to be a waste area because it can not be plowed, indicates a very limited insight or selfish motives. Some of the factors that must be considered in the development of this resource are power sites, building sites, water supply for cities, water for irrigation, places for recreation, avenues for transportation, and fish production.

It may be regarded as self-evident, that a whole drainage system must be treated as a unit. It is impossible to develop one power site, without affecting another; floods prevented in the upper course of a stream will make them less destructive in its lower course, etc.

The thing that affects most fundamentally these elements of value in a stream is its rate of discharge. The work of Tucker ('11) has shown that not nearly all of the power sites in Indiana are developed; and that those that are developed are limited in value because of the low minimum discharge. High banks along streams are worth much more for building sites than for farm land. The more constant the stream level is, the more these sites are worth. And so with all of the values that attach to a stream; the more regular the discharge, the greater these values are.

The attention of every one is attracted to the great losses that are caused by floods; but few recognize the decreases in value that are occasioned by the low stages of streams. The losses by floods are sudden and dramatic. They are more or less irregular in their occurrence, while the losses caused by low stages are constant and inconspicuous. The losses



North Side. Former Fish Breeding Ground. Now a Rocky and Unproductive Waste.



Plate I. Lingle Lake. Marsh in the Foreground and Middle Distance. A Fish Feeding Ground Spoiled by Lowering the Lake.

of the first class represent developed resources; while those of the second class represent resources that are for the most part undeveloped. This accounts for the difference in the attention that each receives. The problem is not the prevention of floods but the production of regular discharge in our streams. The rainfall is irregular, and if it is allowed to run off as it falls an irregular discharge must result. Each drainage system presents a different set of conditions that must be met in solving this problem. The solution of the problem in northern Indiana is intimately associated with the development of our lakes.

This paper is limited to a discussion of some lakes of Kosciusko County and their relation to the Tippecanoe drainage system of which they form a part.

That the Tippecanoe River has a more regular flow than the Wabash is due to the fact that the Tippecanoe has many more lakes and swamps in its headwaters. (The closer proximity of the Wabash to bed-rock probably has some influence on the irregularity of its flow.)

Some of the facts concerning the Wabash at and above Logansport, and the Tippecanoe River at and above Delphi are as follows:

	DRAINAGE AREA, Sq. Miles.	DISCHARGE, 1901.		SEC. FT. PER SQ. MILE.	
		Maximum, Sec. Ft.	Minimum, Sec. Ft.	Maximum.	Minimum.
Tippecanoe at Delphi.....	1,890	15,430	269	8.164	.142
Wabash at Lo- gansport.....	3,163	48,080	260	15.02	.081

That is, the minimum discharge per square mile of drainage basin in the Wabash is 57.7 per cent of that of a square mile in the Tippecanoe, while the maximum discharge per square mile of basin is 183 per cent of that of the Tippecanoe. This indicates roughly the value of lakes under natural conditions.

The most important factor in the economy of lakes is the treatment of the outlet. This may be left in a natural condition, it may be dredged, or it may be dammed. I wish to describe the effect of these three conditions on the drainage systems below the lake and upon the lake itself.

A lake with a natural outlet usually impounds water early in the year. With the first warm months their outlets become obstructed with

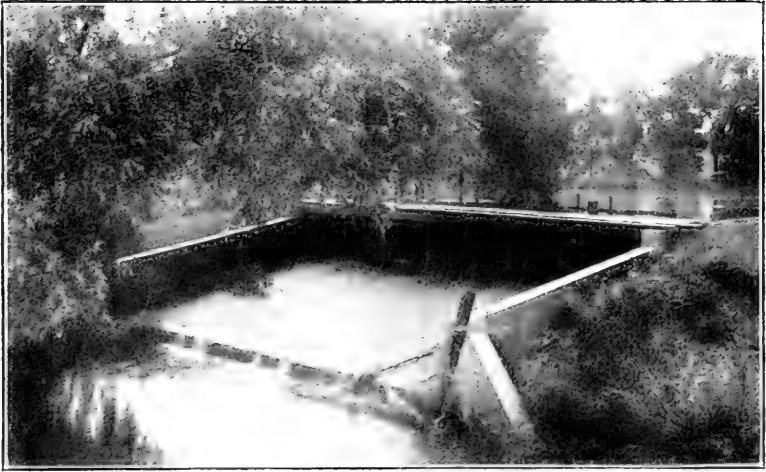

Spillway and Dam.



Plate II. Webster Lake. Fish Feeding Ground Formed by Damming the Lake.

gradu-

res to
 . On
 s the
 there
 l for

basin
 that
 was
 on of
 two
 feet,

ction
 east
 sun-
 used.
 which
 lture
 1 in-

akes,
 illiar.
 (ke),
 con-
 vely
 um.
 Tip-

ould
 the
 cess
 ased

; dis-

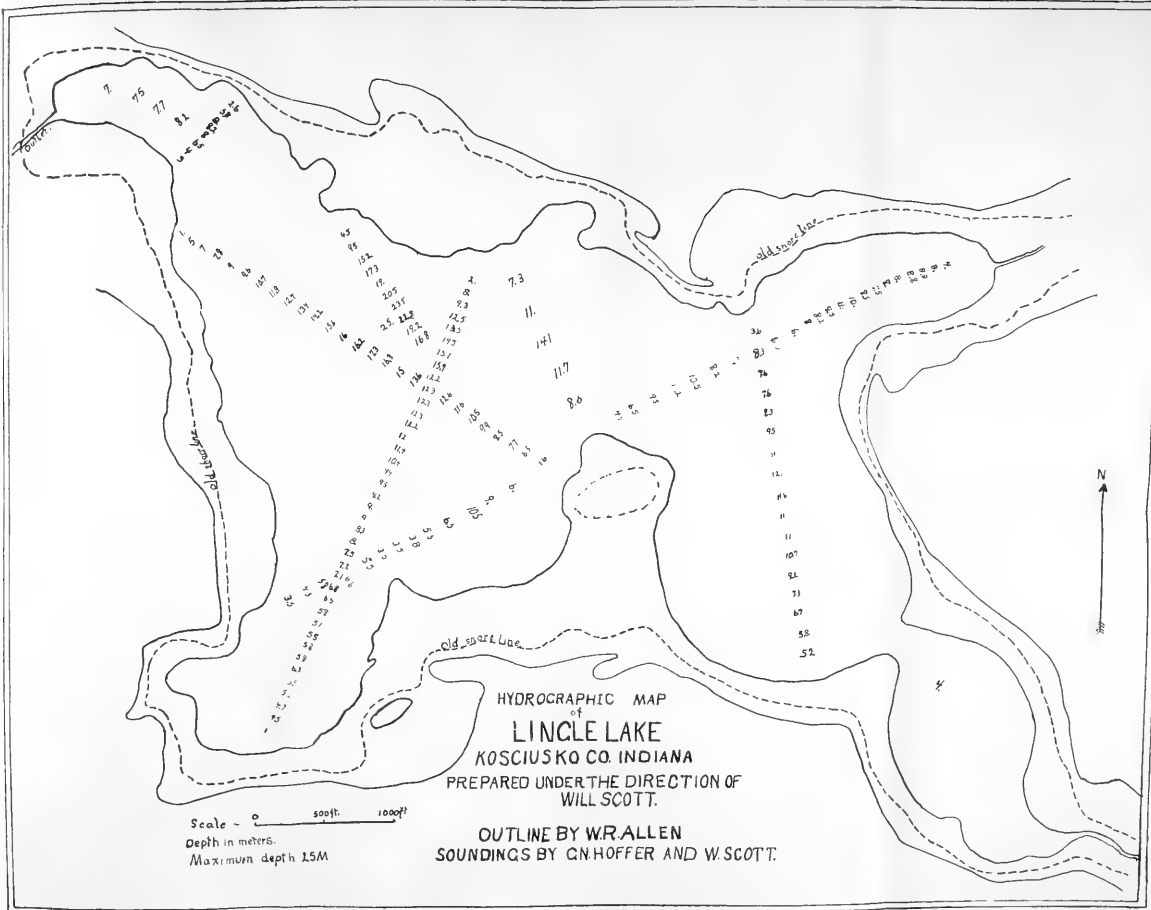

Scale - 0 500ft. 1000ft.
 Depth in meters.
 Maximum depth 15M

HYDROGRAPHIC MAP
 of
LINCLE LAKE
 KOSCIUSKO CO. INDIANA
 PREPARED UNDER THE DIRECTION OF
 WILL SCOTT.

OUTLINE BY W.R. ALLEN
 SOUNDINGS BY C.N. HOFFER AND W. SCOTT.

plants* growing in them so that the excess of water is discharged gradually during the months that follow.

To leave the outlet of a lake undisturbed has many advantages to the lake. First of all, it insures a shore line of considerable age. On the windward side there is usually a wave-cut terrace, which forms the natural breeding ground for most of our lake fish. On the lee side there are usually plants which furnish protection and feeding ground for fish.

If the outlet is dredged the capacity of the lake as an impounding basin is decreased. The plants which obstruct the outlet are destroyed, so that the excess of water is rapidly discharged. For example Lingle Lake was lowered four feet by dredging. Caving of the banks and the obstruction of the outlet by waves has raised the water to within approximately two feet of its original level. This has decreased its area 10,152,800 square feet, and its capacity 40,107,600 cubic feet. See accompanying map.

The present area of Lingle Lake is .537 square miles. This reduction in level has exposed a large area of wave-cut terrace on the north and east shores, and thus destroyed the best nesting places for fish (especially sunfish and bass). None of this land is used and apparently cannot be used. On the south and west extensive marl deposits were exposed on which sedges grow, forming an inferior pasture. The possibilities of aquiculture have been limited, while the available area for agriculture has been increased to a much less degree.

To illustrate the effect of damming lakes, I shall discuss five lakes, whose area is accurately known, and with whose environs I am familiar. These are Eagle Lake (Winona Lake), Little Eagle Lake (Chapman Lake), Webster Lake, Tippecanoe Lake, and Palestine Lake. If dams were constructed so that the level of these lakes could be fluctuated respectively 2, 3, 3, 5, 3 feet they would store and control 27.289 sec. feet per annum, distributed as follows: Eagle 2.02, Little Eagle 4.359, Webster 3.039, Tippecanoe 12.99, Palestine 4.509.

If this excess were discharged during the driest three months it would produce 109.156 sec. feet for that period. The minimum discharge for the Tippecanoe River at Delphi during 1904 was 269 sec. feet. If the excess just cited had been available during that period it would have increased the minimum discharge 40.5 per cent.

* This stream obstruction by plants may be excessive. It accounts for part, if not all, of the discrepancy between rainfall and discharge noted by Tucker ('11, p. 507).



Mill and Race. (See Text.)



Plate III. Webster Lake. Head of Race and Mill.

It is a well-established fact that the value of a power site is largely determined by the minimum rate of discharge. This means that the value of the water power along the Tippecanoe would be increased more than 40 per cent. by treating five lakes as I have suggested. Not only would this value be enhanced; but it would afford a better avenue of transportation, a more delightful place for recreation, and its yield of fish would be increased. By properly controlling all of the lakes in this basin, it is probable that the minimum rate of flow could be more than doubled. (The exact data for the remaining lakes in this system we hope to collect during the present year.)

The effect upon flood conditions is evident. The increase of the minimum discharge decreases the maximum discharge. Since it is the top of the flood that does the damage, it will be possible to practically eliminate excessive destruction along this stream. This will improve conditions in some degree along the streams to which the Tippecanoe is tributary.

It is very evident that handling lakes as I have indicated will make the streams that drain them more valuable and less destructive. It remains to determine, as accurately as the available data will permit, the effect upon the lakes themselves and their environs. Raising the level of any lake will of course inundate some land. The value of this land must be considered in determining the advisability of manipulating lake levels. These lakes are all intramorainal and are surrounded by moraines, rising rather abruptly from the water; or by marshes, which in most cases have been formerly a part of the lake.

Where the shore rises abruptly a narrow strip would be submerged by raising the level of the water. In many cases these slopes are used for the sites of summer homes, and it is only a question of time until all of them will be so utilized. The raising of the water along these sites would make boat landing less difficult and would not injure the facilities for bathing.

It is on the wave-cut terraces, which are formed along these moraines that most of the fish of the lake breed. This breeding ground would be narrowed at first, on account of the increased depth of the outer margin; but in a short time it would be more extensive than ever because of the increased width of the terrace.

The marsh land on the margin of lakes is often worthless and never valuable. It is sometimes used for pasture and occasionally it is mowed



The West Side, a Marsh.



Plate IV. Chapman Lake. The East Side, a Barren Slope. This Lake Has Recently Been Lowered Three Feet.

for marsh hay. The products in each case are coarse and of little worth. When these marshes are flooded they produce excellent feeding grounds for fish.

The damming of a lake would be sufficient, in many instances, for the development of water power. This could be used at the site of the dam or it could be converted into electricity and delivered to the property owners whose holdings abut the lake. The power thus produced would be sufficient in most lakes to offset the damage caused by the overflow of marshes, provided a just appraisalment could be secured. The owners of the high ground around the lake would very generally favor the change, because of the value added to the cottage sites.

THE EFFECT UPON THE PARTICULAR LAKES UNDER CONSIDERATION.

Webster Lake.—Webster lake has an area of 1.5 square miles. It has already received the treatment that I have outlined. I have been unable to determine the date of the first dam. The present dam was constructed in 1905. It gives a head of nine feet when the water is flowing over the spillway. The power is used to run a flouring mill owned by Mr. John Strombeck. One large turbine and two smaller ones are used. The large wheel delivers sixty horse-power at a nine-foot head and forty horse-power at a six-foot head. The ratings of the smaller wheels were not available. The dam is an earthen one except the spillway with its apron and wings, which are of concrete.

With the dam out the present lake would be cut into a number of smaller ones, connected by marshes. This former marsh land now furnishes excellent feeding ground for fish. As a direct result of this, Webster Lake has become one of the finest lakes in the state for bluegill fishing. I have counted forty fishing boats in view at once; and from fifty to eighty fish are counted a good string for a half day's fishing.

The present level makes it possible to use the surrounding moraines for the building of summer homes and resorts. One large hotel and several cottages have already been erected on the south shore. The town of North Webster has easy access to the lake. Many good building sites remain to be developed.

It is difficult to estimate the value of the power, the increased value of the adjoining real estate, and the augmented fish production; but this certainly would exceed the value of the marsh land that would be exposed if there were no dam. For map see Large ('96).



A Shallow Lake Which Produces Enormous Amounts of Fish Foods.



Plate V. Palestine Lake. Note the Close Proximity of Cultivated Land to the Water. No Waste Area as in Partially Drained Lakes.

Tippecanoe Lake.—Tippecanoe has an area at present of 1.71 square miles. If the level were raised five feet the area would be increased to 2.93 square miles. Its maximum depth is 121 feet, which is probably the greatest depth in any Indiana lake. The lake is bordered along most of its shoreline by moraines that rise rather abruptly to considerable height. The rest of the shore is bordered by marshes. Raising the level five feet would submerge most of the marsh land and a very narrow strip along the steeper shores. One building would be affected, but \$600 would easily replace it. The bathing beaches would be narrowed, but the action of the waves would soon broaden them. These are the items of loss.

By overflowing the marshes the shore line would be brought to other good building sites. This would increase its value from that of ordinary farm land to that of water-front building site. The value of the former is about \$100 per acre, while that of the latter is at present between \$500 and \$1,000 per acre.

The great depth of Tippecanoe Lake and the steep slope of much of its bottom make the area available for fish breeding and feeding very limited. The fish production could probably be doubled by utilizing the marsh land for feeding grounds and the wider wave-cut terraces as breeding ground.

The basin that discharges through the outlet of Tippecanoe Lake has an area of 136 square miles. One inch run-off from this basin would produce 10 sec. feet for one year. Twelve or fifteen inches run-off could be expected which would produce, respectively, 120 and 150 sec. feet for one year. The five-foot fall that would be produced by the dam could be increased two or three feet by building a race a quarter of a mile in length. For map see Large ('96).

Eagle Lake.—Eagle Lake has an area of .87 square miles. The swamp land that surrounds it covers about one-half square mile. A part of this swamp land has been filled by Winona Assembly and now forms very valuable real estate. This would make it rather impracticable to raise the lake more than two feet above its present level. But little of the remaining low land is used. About twenty acres are mowed for marsh hay and a similar amount is used for pasture, of which it produces a very inferior grade.

The outlet has been dredged so that the land below the lake could be drained. A dam has been built across this ditch, making a difference in level of six feet. By raising the dam two feet a fall of eight feet would be secured. The catchment basin discharging through the outlet of this lake contains forty square miles.



The Dam From Above.



Plate VI. Palestine Lake. General View of the Dam and Mill.

feet
uld

t of
its
vel

fort
me
for

rel-
the
are
rop-
the

orig-

1.71
s 30
arts
con-
old
the

bine

and
ould
able
ould
sing
ped.
ring
e of
fore

N

HYDROGRAPHIC MAP OF LITTLE EAGLE LAKE

KOSCIUSKO CO. INDIANA

PREPARED UNDER THE DIRECTION OF
WILL SCOTT

OUTLINE BY WRALLEN.
SOUNDINGS BY W. SCOTT, CHOFFER
AND M. SCOTT

Scale $\overline{\hspace{1.5cm}}$ 500ft. 1000ft.

Depth in meters.

Maximum depth 11.6 meters.

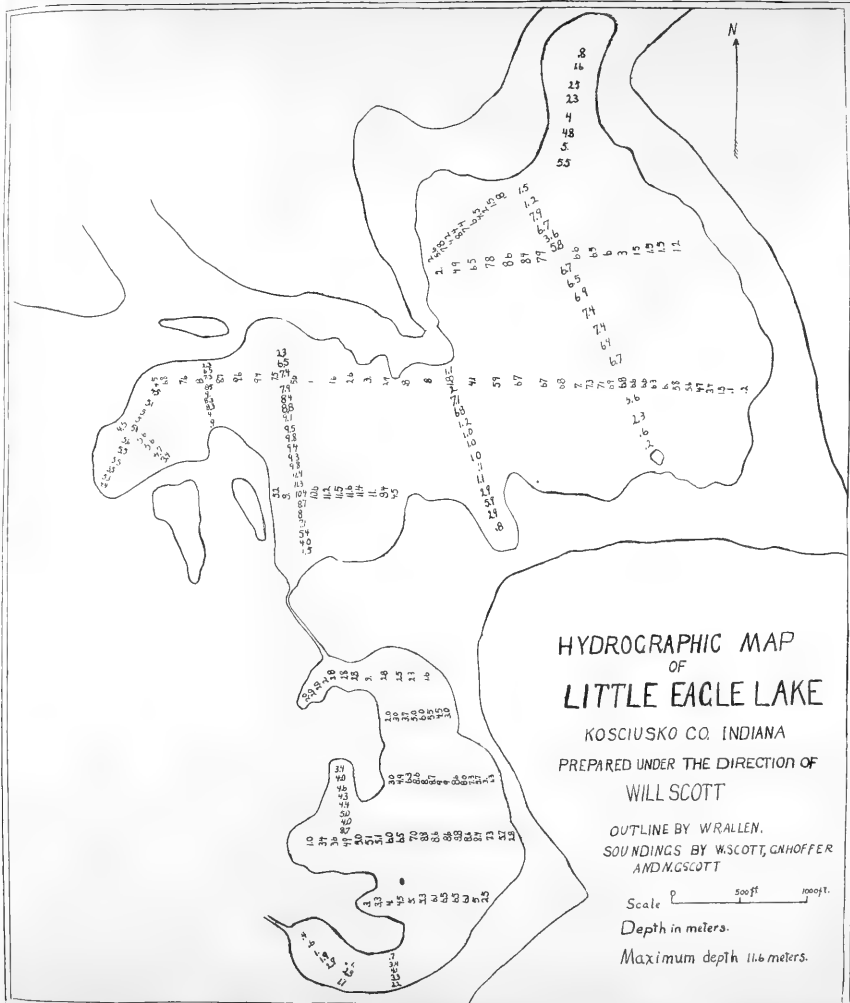

The changes produced in Eagle Lake by raising the dam two feet would not be very great. Fishing would be improved and some power could be developed with an almost negligible loss of property.

Little Eagle Lake.—Little Eagle Lake (Chapman Lake) has an area of .822 square miles. It has a maximum depth of 38 feet. Along most of its shore line the bottom slopes rather gently, so that a slight change in level makes a marked change in area.

In recent years the outlet of this lake has been dredged, in an effort to reclaim some marsh land on the south and west of the lake. Some onions have been raised on this land, but most of it is not productive, for all of the lowland lying west of the lake is composed of marl.

This dredging of the outlet has exposed many acres of fine fish breeding ground on the east side and it has reduced the feeding ground on the west side. The east side has many good building sites, some of which are developed. The lowering of the lake has reduced the value of these properties by making the landing with boats more difficult and by making the shore line more distant.

The changes proposed for this lake would just about restore the original conditions. See accompanying map.

Palestine Lake.—Palestine Lake is said to contain 1,100 acres or 1.71 square miles. There are two small depressions whose maximum depth is 30 feet, but the most of the lake is less than ten feet deep. All shallow parts of the lake, comprising about five-sixths of it, are filled with an almost continuous mass of water plants. These shallows evidently formed an old flood plain or marsh that has been covered with water by damming the outlet.

The water from the dam is used to run a flouring mill. The turbine delivers forty-seven horse-power at a seven-foot head.

We have not completed the sounding and mapping of this lake and until this is finished it is impossible to say with certainty just what would be the best treatment for this lake to receive. It is certainly a valuable impounding basin as it is; and it seems that a small amount of land would be submerged by raising the water above its present level; thus increasing its efficiency as an impounding basin, and the amount of power developed.

On the other hand, this is one of the few lakes in which the lowering of the outlet would expose a relatively large amount of land. Because of this exceptional condition, it is necessary to collect all of the data before

MAP OF KOSCIUSKO COUNTY, INDIANA. SHOWING THE LOCATION OF THE LAKES DISCUSSED IN THIS PAPER.

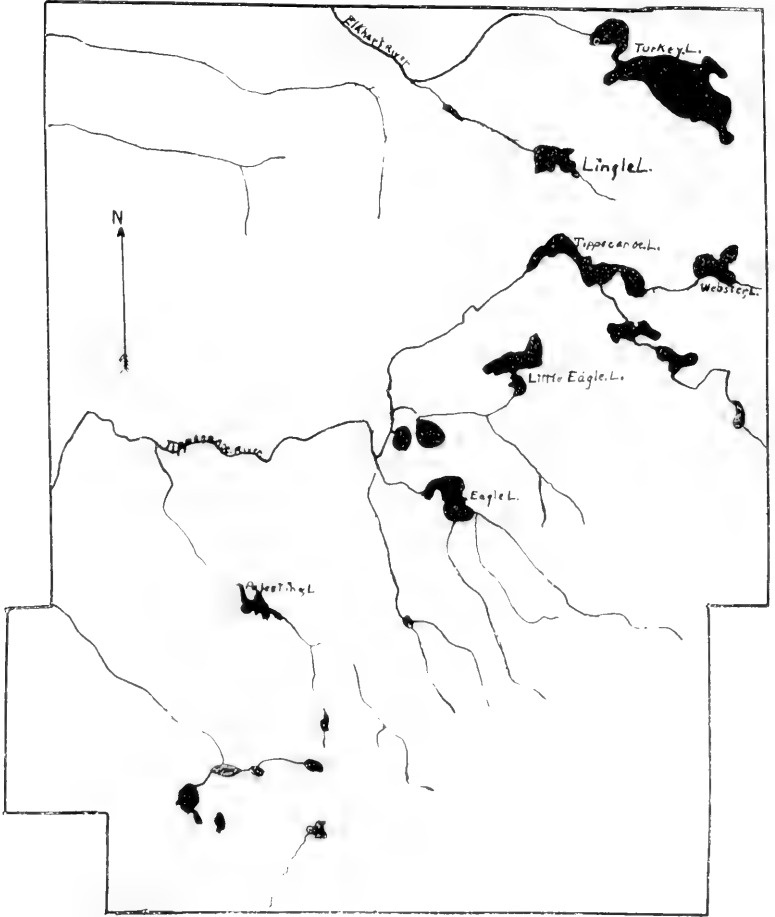

a just estimate of the various values can be made. It may be more economical in this case to remove the dam, in order to secure land for farming; but the evidence at present indicates that the dam should be raised rather than lowered.

CONCLUSION.

From the data presented, it is evident that the storage capacity of lakes can be increased by damming, and that by properly manipulating these dams the excess accumulated can be discharged during periods of minimum rainfall. This will benefit the streams to which the lakes are tributary (1) by decreasing the maximum discharge, thus preventing floods, and (2) by increasing the minimum discharge, which will add to all the elements that have been enumerated in stream valuation.

By analyzing the conditions carefully in each lake these changes can be made so that the value of the lakes and the property adjoining, when considered as a whole, will be increased.

Many details are yet to be worked out, but the advisability of this procedure is already apparent.

REFERENCES.

- Large, Thomas: Map of Webster Lake. Proc. Ind. Acad. Sci. '96.
Map of Tippecanoe Lake. *Ibid.*, '96.
Norris, A. A.: Map of Winona, Pike and Center Lakes. Proc. Ind. Acad. Sci. '01, p. 117.
Tucker, W. M.: Water power of Indiana. Rept. Ind. Dept. Geol. and Nat. Res. '11, pp. 469-538.

FIRST STEPS IN INDIANA FORESTRY.

STANLEY COULTER.

It is not meant by the title chosen to intimate that much preparatory work along forestal lines has not been done in the state. The work of awakening popular interest in forestry has been well done, it not, perhaps, overdone. In the schools by direct instruction, through the stimulus of arbor day exercises and by the wise and vigorous activity of the Indiana Forestry Association, practically every community has been reached. Upon the Forest Reserve the State Board of Forestry has conducted a large series of experiments and has collected a vast mass of data touching practically every phase of wood-lot management. Its reports and press bulletins, together with its educational contests, have served to increase and intensify interest in the movement for the conservation of our remaining forests. I suggested that perhaps this preparatory phase of the work had been over-accented, for there is such a thing, on the one hand, as spending so much time on preparation as to leave none for accomplishment, and on the other, by overstimulus to incite to ill-considered and poorly planned efforts. In Indiana the latter has been the case. An examination of the facts shows a very large number of instances of tree planting; plantings running up to the hundreds in number, into the thousands of acres in area and containing hundreds of thousands of trees. A review of the inspection of plantations as given in the reports of the State Board of Forestry reveals an activity in tree planting that is positively marvelous and almost incredible when the returns or rather lack of returns are taken into account. It is a sad fact but a true one that approximately 70 per cent of these plantings are total failures. In them, the total crop sold at the highest price would not equal the cost expended upon them. The remaining 30 per cent can only be regarded as partially successful. Only in a small fraction of the cases can the stand be regarded as representing the full capacity of the area. The schools also have had arbor day exercises for years, exercises which have doubtless been helpful and stimulating in many ways, but

the school yards in the main are as destitute of trees as they were before arbor day was projected.

All of this shows interest; it further shows a willingness to expend time and effort and money in tree planting, but it also shows with equal clearness that there has been enthusiasm without knowledge, and that in Indiana the first steps in forestry from the standpoint of results are yet to be taken. Incidentally it may be remarked that tree planting is not necessarily forestry, it is merely a single phase of forestry.

For the purpose of this paper we may omit the consideration of ornamental plantings, whether of streets or lawns or parks, and confine the discussion to the wood-lot and to the denuded area which is to be reforested. In the management of the wood-lot from the standpoint of conservation three things are sought: (1) The largest amount of timber per acre that the land will carry; (2) the best quality of timber possible; (3) the production of this maximum quantity and optimum quality in the shortest time possible. If these ends are accomplished there is evidently need of a technical knowledge which is usually not possessed by the landowner, and which in the multiplicity of his activities he has no time to acquire. If the largest quantity and best quality possible is secured from a given area it will be because those species of trees are selected which are adapted to the conditions of soil, of moisture, and of climate. It will also be in part because of species equally adapted to a given locality, those which make the more rapid growth, are more immune to insect and fungus invasion, which are less sensitive to unfavorable climatic conditions, have been chosen for encouragement. In a general way conditions which make for a vigorous and healthy growth make also for the best quality of timber, whether we consider weight or strength or direction of fibre or beauty of grain. In the large range of species available, in the variety, indeed, found in the average wood-lot, how many landowners have a sufficiently accurate knowledge upon these points to enable them to select species for encouragement with such certainty as to insure profitable returns? Taking the plantings referred to above, the failures came from lack of knowledge, not from lack of interest or enthusiasm. Most of the plantings were of black locust or hardy catalpa, planted, probably, with the purpose of short rotation management for post or tie stuff; but very often locust was planted on ground which in all reason should have been planted to catalpa and catalpa was planted on ground far better suited to locust. The result, of course, has been failure more or less complete, with loss of

money and time and use of land and, worst of all, loss of faith in the possibility of forest improvement. The argument is that this knowledge is strictly technical knowledge, the property of the specialist. It is not within the knowledge of the landowner, nor would he be justified in taking the time required for acquiring it from his other work. This is a very summary and incomplete resume of some of the silvical factors entering into the problem of securing maximum quantity and optimum quality in the shortest time.

The wood-lot, also, if it serve its purpose must yield its owner reasonable returns upon his investment and yield such returns at regular intervals. If it fails to do so its maintenance is bad business. If the wood-lot is regarded as an investment, perpetuity must always be in mind. It is then not merely securing a return at some given period of time, it is insuring by sufficient reproduction the harvesting of similar crops at future periods. How much shall be cut? How often shall cuttings occur? What relation shall the time of cutting bear to the time of regeneration? What species in the stand shall be encouraged and what species eliminated? How shall the amount cut be known to equal the amount grown between cutting cycles? These are a few of the factors entering into the problem from the standpoint of management, which is after all applied economics. Here again the knowledge is expert knowledge, it is not in the possession of the landowner nor has he time to acquire it. Yet because these factors are not considered ultimate failure is bound to result.

It seems that we have an inevitable deduction. Provision should be made as a part of the force under control of the State Board of Forestry for an *expert field agent* whose duty it should be to furnish working plans to the wood-lot owner which will give direction and certainty to his efforts to secure the largest quantity and the best quality in the shortest time possible. Each tract should be inspected carefully before the working plan is outlined in order that local conditions, which are of the highest importance, may be taken into account. Along constructive lines, the lines of securing results, the appointment of a trained field agent is absolutely the first step. Until such an office is created forestry work will be as ineffective and futile in the future as it has been in the past. Advice as to cleanings, thinning, reinforcement, control of noxious insects and injurious fungi would naturally be among the functions of such a field agent.

Before any very great measure of success can be hoped for, provision

must be made of such a character that the landowner may secure the needed supply of seedlings, true to species and at a reasonable price. Under present conditions this is practically impossible. Nurseries as at present organized deal in forest trees mainly to supply the demand for street and ornamental planting. The placing of an order for a given species running up into the thousands or perhaps tens of thousands of seedlings is practically impossible except perhaps in the case of black locust and catalpa. Indeed it is not probable that nurserymen would care to undertake to meet such demands. The cost of collecting the seed, the additional area and labor involved, taken in connection with the fact that such orders could only be expected occasionally and that there would be no possible method of estimating the average annual demand for each of the species, would make such an enterprise one of very doubtful profit under favorable conditions and of very certain and large loss under unfavorable conditions. This means the establishment of a state nursery or nurseries, by the State Board of Forestry under expert direction, from which needed material for future plantings may be secured.

The experimental work at the reserve has gone far enough to indicate what species should be encouraged in reenforcement and new plantings, to demonstrate the best time for planting as well as the best method of planting, to show clearly enough the proper care and treatment after planting and to furnish a fair estimate of the expense involved in a correct practice. It is well within the law under which the board was created, that it should now take the next logical step, namely, the furnishing of suitable material for such plantings at practically the cost of production. Under the very best conditions from 3 to 6 per cent. is the best dividend that can be expected in forestal enterprises, so that any marked increase in the initial cost precludes all possibility of profit. The distribution of this material should be carefully controlled. It should be supplied only for afforestation or the reenforcement of existing wood-lots and never for street or ornamental purposes. The experience of the state nurseries in Connecticut, Massachusetts, and other states shows that this control offers no difficulty and that a demand is met which the nurserymen cannot meet and do not care to meet. Indeed it has been shown that since the establishment of state nurseries the sale of forest tree stock by nursery firms has largely increased, although it may be questioned whether the relation is a causal one. It is certain that the Board of Forestry by establishing such nurseries would accomplish much in the way of improving existing wood-lots and in

the afforestation of denuded and waste lands. It cannot be too strongly emphasized that in such work the state is not entering into competition with nurserymen, but is merely endeavoring to meet exceptional needs which lie beyond the field of ordinary nursery organization and purpose. It would of course be better if a series of nurseries could be established so located as to give not merely the best conditions for the growth of the seedlings, but also to meet the needs of different localities. This refinement of method is perhaps beyond the bounds of reasonable expectation, but certainly the supply of desirable species true to type at the minimum cost is another step in a constructive forest policy. Apparent difficulties cannot be considered in this connection, but in the main they will be found to concern details capable of a fairly easy adjustment; none seem to be fundamental.

A third step in a constructive forest policy would be the organization of a series of cooperative plantings. In this case the landowner and state cooperate. The proper official selects and furnishes the young trees, personally oversees their planting and gives direction for their future care. The landowner pays transportation charges on the seedlings and furnishes the labor involved in the planting; he also agrees to follow the directions for after care and to make report upon the planting at specified times. The advantage is two-fold: the constructive work of the Board of Forestry covers a large part of the state, while the landowner secures expert advice and material in return for his labor and care. This plan has been in successful operation in Ohio for a number of years with extremely satisfactory results in the majority of cases. Of course in this as in all other cooperative enterprises an occasional man fails to keep faith. Practically the same plan prevails in all agricultural colleges. Purdue University has cooperative plats in all parts of the state bearing upon every form of crop from alfalfa to apples. Such cooperation would involve but little expense if the office of field expert in Forestry were created and a state nursery established. Indeed, the expense involved in the salary of a field expert, in the establishment and maintenance of state nurseries for furnishing tree seedlings and in the institution of a series of cooperative plantings taken together would seem absurdly small when compared with the interests involved.

Successful tree planting, which is only another name for successful forestry, is in a certain sense an essentially local proposition. So much de-

pends upon the quality and character of the soil, upon the water level of the soil, upon the climate, exposure, topography and a host of other factors, that what might be good practice upon one tract would be bad practice upon another possibly but slightly removed. All of which means that deductions drawn from the study of a single area cannot be safely applied over the area of a state. Concretely, the deductions drawn from the experimental studies at the Forest Reservation are applicable only to like areas, that is to those with similar ecological conditions. They are not applicable to the conditions prevailing in the central counties and are of little significance so far as the sand-dune regions of the state are concerned. So much depends upon the soil character as regards the health and vigor and rapidity of growth of the tree that it must always be taken into account. In an area such as Indiana, elevation and climate are so nearly uniform as to be negligible, but the soil is in different case. As each species has its optimum soil any constructive forest policy will provide for demonstration areas so located as to represent every type of soil found in the state. This would involve the purchase of land unless arrangements could be made to utilize some of the holdings of properly located state institutions. That the acquisition of land by the state for forestal purpose is regarded as sound economic policy is plainly shown by the large and constantly increasing area of such holdings in New York, Pennsylvania, Michigan, Minnesota, and other states. The tracts need not be large for the accomplishment of the desired purpose, so that the entire amount required would probably not exceed 200 or 300 acres. For the success of such work absolute control of the tracts should be vested in the State Board of Forestry, a fact which makes purchase more desirable than a use by sufferance of the lands of state institutions. An attempt to carry out the suggestion of former Governor Marshall that such demonstration plats should be operated upon county farms showed the extreme difficulties attending the very first steps in such joint control.

If we consider the problem of the recovering of denuded and waste areas the necessity of the expert field agent becomes more apparent. What to plant in any given locality is a problem involving a very wide range of factors running from silvical requirements to economic conditions. Yet a consideration of all of these factors is absolutely essential if the work proves at all profitable. From the merely silvical standpoint it is perhaps natural to infer that the species that have grown upon any given area, having proved their fitness for the particular locality, are the ones

that in afforestation operations would give the greatest promise of success. As a matter of fact such a conclusion is more often incorrect than correct. The region has lost its forest floor with all its far-reaching influence in maintaining soil fertility, moisture and porosity; it has been subjected to the desiccating and compacting effects of sun and wind; by drainage its water level may have been decidedly lowered; it has lost the protection of adjoining forests and is therefore more sensitive to adverse climatic conditions such as changes of temperature, wind, etc.; many of the trees in the original forest may have been of species which can only find their normal development and growth rate when sheltered or partially sheltered. Indeed it is very rarely the case that the original forest can be restored. Its place must be taken by one composed of species adapted to the new conditions. Just what species these new conditions indicate it is difficult for the expert to determine; it is entirely beyond solution by the average landowner save through the expensive school of experiment. In afforestation more definitely and vitally than in reinforcement and improvement do we find that the imperative need in forestry in Indiana is the field expert.

Incidentally much remains to be done in the way of education. Relatively few species are of sufficient economic value to promise profitable returns. Each of these species has its optimum conditions, each has advantages and disadvantages arising from its silvical properties. Careful studies should be made of these available species and of their requirements for the most rapid growth and healthiest development. These studies should be supplemented by others which definitely locate the areas in the state where these optimum conditions for the various species are to be found or if the specific locality is not given, of the type of soil furnishing these conditions. If this were done the landowner in Hancock or Elkhart or Gibson county would have in his possession the data needed for the formulation of a rational management of his wood-lot. The preparation of such a series of studies would take time, but the good accomplished would be immeasurable. The old prophet cried, "The people perish through ignorance," which we may paraphrase to read, "Our forests perish through ignorance."

Back of all this and in a certain sense fundamental is a classification of the soils of the state. Any true conservation demands that every resource be utilized for its highest values. This is as true of soils as of gas or gold. In Indiana certain soils give and always will give their highest values in the form of ordinary field crops, or horticulture. Other soils always have and always must yield their highest return from tree crops.

Some intermediate conditions may indicate that a part of a given area should be devoted to crops, part to trees. It is necessary that the absolutely agricultural, the absolutely forestal and the intermediate soils be accurately delimited. When this is done the soil can be managed in such a way as to yield its highest returns. Until this is done we shall continue to have the economic anomaly of trees upon agricultural land and of crops upon forestal lands. The United States is far behind other countries in this classification of its soils and the devotion of each type to its highest form of utilization. Until such classification is made little constructive work of a permanent character can be done.

Summarizing: There is no lack of interest and enthusiasm; indeed they have far outrun knowledge. Enough data bearing upon the subject are in hand to justify constructive work. To insure success six things are necessary.

1. The Field Expert at the service of landowners.
2. The state nurseries for furnishing material true to species at the minimum price.
3. Cooperative plantings extended until they reach every county in the state.
4. Demonstrations plats so located as to represent fairly every soil type in the state.
5. Definite instructions as to available species for given localities or at least for given types of soils.
6. A classification of soils.

The consideration of a constructive policy which would produce results in the way of improved forest conditions, of a rapid and rational re-clothing of denuded and waste areas would naturally include many topics not discussed in this paper, not because of their lack of pertinence, but for a very apparent lack of time. In the case of the tens of thousands of acres of waste and wasting lands, in the southern hill region, in the northern sand-dunes, in undrainable lowlands, can the individual afford afforestation work, or is the problem one for the state? If it is a problem for the state, how is the land to be acquired and what shall be the nature and control of such tracts after their acquirement? Personally, I have some very decided views upon the points which I hope to present at some other time. At present I merely suggest them as an evident part of any comprehensive constructive forest policy, though not perhaps to be regarded as among the first steps in its initiation.

THE TAXATION OF FOREST LANDS IN INDIANA.

H. W. ANDERSON.

The common argument against the preservation of woodlands by landowners in this and other states similarly situated is that the land in timber is lying idle and that the taxes are "eating it up." Many farmers today would have a forty or sixty-acre woodlot had they not felt that the taxes on this land was wasted money. It is true that woodlands are often assessed at much below their actual value because the income from them is small, but unless there is marketable timber on the land there is no annual return, as in the case of yearly crops such as wheat and corn.

Many business or professional men in our cities would like to own a piece of timber land where they could take their families for a few weeks in the summer or where they could go to hunt or camp. These men can afford to buy cheap land on which there is a growth of young timber which on account of its slow growth would not be of much actual value to the present owner, but would be a valuable piece of land in the future. Here again the problem of meeting the yearly taxes prevents the prospective buyer from purchasing the land. The present owner of this land will probably cut down the young growth, plow up the ground and try to raise a few nubbins on it.

Again there are lands in the southern part of the state which on account of their untillable character might be purchased cheaply and be utilized for growing timber on a commercial scale if the taxes were properly adjusted. These lands for the most part are now supporting a scrub growth of useless trees and underbrush.

In order to encourage the farmer and landowner to hold on to their woodlots or small forest lands and to encourage timber growing on a commercial scale there should be devised a system of taxation for such lands which would be fair to the other taxpayers of the state and yet not burden the woodlot owners with an unreasonable tax on land which is returning nothing to them at the present time. Many states, recognizing the un-

fairness of a general property tax on woodlands have so modified their taxation laws that this object may be accomplished. It is also true that the basis of taxation in one state may not apply in another, so that each state should make a careful study of the conditions within its bounds before modifying its taxation laws. For example, some of the eastern states have townships and counties in which the larger per cent. of the land is covered with forests. To exempt these from taxation for a period of years would work a hardship on the remaining taxpayers of the township or county. In this state, however, we have no such condition to meet.

A brief examination of the taxation laws pertaining to the forest lands in various states may be of interest. These facts were obtained from the "Report of the Special Commission on Taxation of Woodlands in Connecticut." This report was made in 1913, so that it contains the latest available data on the subject. This report shows that the following fourteen states have made special laws in regard to forest taxation: Alabama, Connecticut, Iowa, Maine, Massachusetts, Michigan, Nebraska, New Hampshire, New York, North Dakota, Rhode Island, Vermont, Washington and Wisconsin. Thirty-four states have no special legislation but tax woodland under the general property tax.

Eight of the fourteen states mentioned above have laws which, being similar in nature, may be grouped under one head. These provide for an exemption of all taxes for a period ranging in the different states from ten to thirty years. There are usually conditions attached to these exemptions requiring certain care of the forest or the planting of certain species. Washington exempts all fruit trees and forest trees artificially grown, while North Dakota grants a bounty on forest planting. Iowa has a tax on the basis of a valuation of one dollar per acre for a period of eight years. Here the owner must meet certain conditions as to area of reservation, number of species and care of trees.

The laws of Michigan are especially interesting and will be dealt with in detail. This state has a yield tax law. It provides for the reservation of a limited area. There must be at least 170 trees per acre. Grazing and the removal of not more than one-fifth in any one year are forbidden. Then there is levied a final tax of 5 per cent. of the valuation at the time of cutting. The main criticism of this law is the complicated machinery employed in the valuation and the collection of the taxes. No provision is made for the larger forest areas.

Many states have appointed special committees or commissions to investigate the subject of forest taxation and to recommend measures to the legislature. In Massachusetts, Ohio and New Hampshire constitutional amendments were necessary to permit state legislation along this line. These amendments were made and adopted by the vote of the people. This is of special interest to us since I shall presently show that a constitutional amendment is also necessary in this state.

Wherever commissions have been appointed to investigate this subject they have urged strongly the necessity of special legislation and have stated that the general property tax is not satisfactory in that it is unjust to the holder of woodland and gives uncertainty to forest investment.

The recommendations made by the commission in Connecticut are especially important in that their investigations were made public after a thorough study of the taxation laws of this and European countries. I shall quote them in full:

"The Commission recommends the enactment of a law which will include the following provisions:

"(1) Separate classification of forest lands for the purpose of taxation to be made on application of the owner, provided the value of the land alone does not exceed \$25 per acre. Certificate of classification to be issued by the state forester after due examination as to compliance with requirements of the law.

"(2) At time of classification, present true and actual value of land and standing timber to be determined separately, and valuation then established to be continued for a term of fifty years, with revaluations to be established at the end of that period and continued for a further term of fifty years.

"(3) When classified, natural forest land to be subject to tax at a rate not exceeding ten mills on both land and timber at the separate valuations established as indicated in (2), and a yield tax to be levied on the timber when cut, at a rate prescribed by law and varying with the time during which the land has been classified. Such land when cut clear subsequent to classification, and reforested either naturally or by planting, to be reclassified as young forest under (4) if application for such reclassification is made by the owner; otherwise the land to be taxed at the prescribed rate on the valuation already established for the whole property until end of the fifty-year period.

"(4) When classified, land planted with forest trees under specified conditions, or young forest not more than ten years old to be taxed annually at a rate not to exceed ten mills on a valuation of the land alone established as indicated in (2), and a yield tax of 10 per cent. to be levied on the value of the timber when cut."

The remaining recommendations apply only to conditions in Connecticut and need not be given here.

The system of taxation here recommended is based on sound forestry principles, and on the whole would be applicable to Indiana conditions. However this may be further simplified since the object of levying a small land tax in Connecticut is to prevent impoverishment of those townships where there are large areas of forest, a condition which does not exist in this state. A reasonable yield tax is all that is required in Indiana.

The ideal system of taxation is that used in many European countries, i. e., the income tax. In this connection I wish to quote from a recent article by Professor F. R. Fairchild of Yale University:

"There is a tendency among the progressive states of Europe toward agreement upon the general outline of tax system. As a rule the tax systems of European states are based primarily upon income, rather than upon property as in the United States. The general income tax is normally the basis of the system; the tax is usually progressive, the rate increasing with the size of the income. . . .

"Forests in Europe are ordinarily subject to state taxation and to local or communal taxation. As a rule forests are subject to one or more of three important taxes: (1) the income tax, (2) the ground tax, and (3) the property tax.

"The Ground Tax.—The ground tax is a yield tax. It is based upon the productivity of the soil and is measured by the yield which is normally to be expected in view of the general character of the soil and the use to which it is devoted. It is not based upon the actual income received from any particular piece of land. No account is taken of the peculiarities either in the management of the property or in the personal situation of the owner. Having determined the quality of the soil and the general character of the forest stand, it is assumed that the management is the same as normally prevails in that region. Also when the prevailing kind of wood and management have been decided upon, no account is taken of peculiarities in the condition of a particular forest. The owner who, by

careful management keeps his forest in unusually good condition pays no extra tax on account of the increased yield resulting. . . . In determining the money value of the yield, use is made of the average prices of timber and other forest products which have prevailed during a number of past years.

“On account of the difficulties inherent in the ground tax, this form of taxation has generally declined in importance. In only a few states today is the ground tax the principal method of taxing forests. In most progressive states the ground tax remains only as a supplementary tax in a system based primarily upon other methods of taxation.

“The Income Tax.—Most European states have as a more or less important part of their revenue system a general income tax. This is a tax upon incomes from certain specified sources which include pretty much all important sources of income. The income from forestry is subject to the income tax where such a tax exists. . . .

“The income tax, unlike the ground tax, is a personal tax. Instead of assuming a certain normal income, as is done under the ground tax, the income tax takes account of the actual income received by the individual in question from the particular source specified. . . .

“The rate of the income tax varies with the size of the income and is different in different states. It is seldom that the maximum rate exceeds 5 per cent.”

We cannot hope to have these ideal systems of taxation for some time to come, so it is best to look toward the modification of our present system in order to make it more just and tolerable.

Our woodlands are a valuable asset to the state and it is our duty to see that everything is done to conserve them. An attempt has been made by the speaker to show that our present system of taxation is unjust toward the owners of woodland and should be changed. Unfortunately our constitution provides for a general property tax. Section 1, Article X, states that “The general assembly shall provide by law for a uniform and equal rate of assessment and taxation.” It would, therefore, be necessary to have an amendment to our constitution to cover this matter. Other states have accomplished this and there seems no good reason why it cannot be done in this state.

However it is not the purpose of the speaker to go further in this matter than to urge the appointment of a commission by the Governor of

Indiana for the investigation of the conditions in this state and the recommendation of some plan whereby the woodlands of the state may be more justly taxed. As a scientific body interested in this question we should represent to the proper authorities our desire for the appointment of such a commission in this state.

FORESTS AND FLOODS.

F. M. ANDREWS.

The relation which forests bear in many ways to the flow of rivers is a question of the utmost importance to the whole country. When one observes what has been and still is being done in most parts of the United States toward forest destruction it seems strange that the people, as a whole have been so slow in waking up to the seriousness of the situation. Only within very recent years is the public beginning to realize that the forests are vanishing rapidly and that they are confronted by a serious problem. They have destroyed the vast forests of this country apparently with no thought or regard for the consequences. Now they are beginning to reap the reward of their shortsightedness in a score or more ways. Chief among the results caused by the continued removal of the forests is the frequent recurrence of floods which become more and more destructive. There have been and perhaps still are some people who believe that the forests are inexhaustible. How such belief can exist at the present, in view of such evident disappearance of forests everywhere is very surprising. A less commendable attitude than this apparent ignorance is the position some assume that there will be timber enough in the country during their lifetime and that therefore they need not concern themselves as to the future. A great service, however, for the preservation of our forests and their proper management has been performed by the admirable work of the Forestry Department of the United States Government. Excellent work also has been rendered by the various forestry schools of the different institutions and by farsighted individuals the country over who have seen the impending dangers and have endeavored by means of education and by timely counsel and advice to avert the dire consequences resulting from the wholesale destruction of the forests.

Within recent years special and important studies have been made in order to ascertain to what extent the flow of various streams is dependent

on forests¹ and surface conditions in general.² Hall and Maxwell in their study gathered together the data for a number of rivers from records which had been kept for sixteen to thirty-four years. The following data, taken from their table on page 4 of Hall and Maxwell's papers, will furnish proof that floods are on the increase.

The Potomac River was measured at Harper's Ferry, Va. It drains a basin of 9,363 square miles. In the first period of record (1890-1898) of nine years there were nineteen floods lasting thirty-three days. There were 1,351 days of low water.

In the second period of record (1899-1907) of nine years there were twenty-six floods lasting fifty-seven days. The increase of rainfall in the second period was only .13 of an inch per year. Days of low water 1,693.

The Monongahela River was measured at Lock 4, Pennsylvania. It drains a basin of 5,430 square miles.

In the first period (1886-1896) of eleven years there were thirty floods lasting fifty-five days. There were 912 days of low water.

In the second period (1897-1907) of eleven years there were fifty-two floods lasting one hundred days. There were 979 days of low water. The rainfall decreased only .08 of an inch per year.

The Cumberland River was measured at Burnside, Ky. It drains a basin of 3,739 square miles.

In the first period (1890-1898) of nine years there were thirty-two floods lasting eight-nine days. There were 1,261 days of low water.

In the second period (1899-1907) of nine years there were forty-three floods lasting 102 days. There were 1,576 days of low water. The rainfall decreased .54 of an inch per year.

The Wateree River was measured at Camden, S. C. It drains a basin of 5,135 square miles.

In the first period (1892-1899) of eight years there were forty-six floods lasting 147 days. There were 1,164 days of low water.

In the second period (1900-1907) of eight years there were seventy floods lasting 187 days. There were 508 days of low water. The rainfall increased .25 of an inch per year.

The Savannah River was measured at Augusta, Ga. It drains a basin of 7,300 square miles.

¹ Toumey, James W. The Relation of Forests to Stream Flow. Yearbook of the Departments of Agriculture, 1903, pp. 279-288.

² Hall, Wm. L. and Maxwell, Hu. Forest Service Circular 176, 1910.

In the first period (1890-1898) of nine years there were forty-seven floods lasting 116 days. There were 566 days of low water.

In the second period (1899-1907) of nine years there were fifty-eight floods lasting 170 days. There were 292 days of low water. The rainfall decreased .17 of an inch per year.

The Ohio River was measured at Wheeling, W. Va. It drains a basin of 23,320 square miles.

In the first period (1882-1894) of thirteen years there were forty-six floods lasting 143 days. There were 1,333 days of low water.

In the second period (1895-1907) of thirteen years there were fifty-nine floods lasting 188 days. There were 1,609 days of low water. The rainfall decreased .14 of an inch annually.

The data here cited for the above mentioned rivers is also true for many other streams, but these will serve as good examples of what has been and is taking place wherever deforestation has occurred. In such rivers as the Ohio, Cumberland, and Wateree, changes are most conspicuous, and it is in these that most of the forest has been removed, while least change appear in those streams where most of the forests remain.³

This state of affairs is what we should expect, but the data given for the rivers referred to proves this by direct observation and leaves the matter no longer a question of guesses or opinion.

From what has just been said it is certain that as deforestation progresses floods will, with equal amounts of precipitation, become more frequent and increase in severity. To be sure, there are other factors that enter somewhat into any consideration of the cause of floods. Among these may be mentioned rainfall, season of the year and temperature, character of the soil, presence of lakes which might impound a good part of the "run-off" temporarily and afterwards gradually supply it to the streams, and thus while at first preventing flood afterwards lessen the lengthy periods of low water. Also the question of whether the land is nearly level or very hilly and steep is important. A heavy precipitation might do no damage whatsoever in the former case, whereas in the latter among steep and deforested land the destruction might be appalling.

But after we have considered all these points and many others that might be mentioned, the fact remains that the chief cause of the frequent

³ Hall, Wm. and Maxwell, Hu. Forest Service Circular 176, p. 3.

and destructive floods in this state and elsewhere is the wholesale destruction of the forests.

Another proof of the efficiency in controlling the "run-off" has been furnished by Toumey.⁴ He made a study of a number of small areas with reference to precipitation and run-off in the San Bernardino Mountains, California. He found in every case that the forest had a very decided effect in regulating the run-off of the water and in the regulation of stream flow. In this way the forests of southern Indiana especially have been of great value. Within the last quarter of a century by far the greater part of the Indiana forests have been removed, so that now but few areas of the primeval forests remain. That rain therefore, which falls, has in most cases, nothing on the steep soil to check it and disastrous floods are the result.

In the forest the heavy rain is first checked by the large trees and their foliage. From these the water next falls to the smaller trees and bushes, then to the thick carpet of leaves. The lower part of this bed of leaves is in partial decay and here again much of the water percolating through is temporarily arrested. From here the water is further arrested by the generally deep humus soil. In this way even most long-continued and heavy rains are effectually checked and a disastrous flood cannot well occur in a region possessing such a covering of the land. In addition most of the water which is checked in this way instead of rushing off as on barren land, gradually runs or seeps away, thus regulating the flows of streams and maintaining the nearly even and continued flow of springs.

There have been later floods in the Ohio River than the one of 1907, and the same applies to the streams of Indiana, due to deforestation which has taken place wherever timber was available.

A recent and severe penalty due mostly to reckless deforestation was given the state of Indiana and the whole Ohio valley in the disastrous flood of the Ohio River and its tributaries in the spring of the present year. This equaled or surpassed in some places the record of any previous flood and was especially remarkable for the suddenness of its appearance. The precipitation over much of Indiana and the Ohio valley in general was enormous and much above the average. For example Reynolds⁵ states

⁴Toumey, James W. *The Relation of Forests to Stream Flow*. Yearbook of the Department of Agriculture, 1903.

⁵Reynolds, Robert U. R. *The Ohio Floods: Their Cause and The Remedy*. American Forestry, May, 1913, p. 288.

that from March 23 up to the morning of the 27th, Bangorville, Ohio, had a total of 9.50 inches (the normal rainfall for the whole month of March at that place is 3.93 inches); Marion, Ohio, 10.60 inches (normal for the month 3.51 inches); Bellefontaine, Ohio, 11.16 inches (monthly normal, 3.79 inches).

In the state of Indiana, in places, at least, the precipitation was even greater than in those just mentioned for Ohio. For example at Bloomington, Indiana, on March 25th, 6.56 inches⁶ of rain fell, and for the month of March 13.3 inches. The normal rainfall for Bloomington for March is about 3.91 inches. The 6.56 inches of rainfall on March 25th, which was probably equaled or excelled in other states, occurred to a greater or less extent over at least half of the state of Indiana. This immense volume of water from an area in Indiana of about 18,175 square miles rushed away from the deforested hills unimpeded. As a result almost every stream in the state was immediately flooded far beyond its banks and every movable object washed away. It is probable that with such huge and sudden precipitations as occurred in March of 1913 the floods would not have been entirely prevented if the region affected had been covered by a dense forest. It would have prevented, however, most of this great flood and at the same time have prevented all or nearly all of the destructive results. If the flood during the spring of 1913 had occurred in winter, when the ground was frozen hard and covered with a deep snow, the results would have been appalling beyond description. Under such conditions in the deforested area the snow would soon have been melted and have added to the volume of water. The frozen soil could not have absorbed any of the water; little forest remains to have checked the flow in any way, so that the crest of the flood would have been higher and the extent of its destruction would have been much greater than it was. Yet this is exactly what Indiana and other states may expect sooner or later. Another great flood like that of 1913 might occur says Reynolds⁷ "within the next decade, especially if, as asserted, we are now passing through a cycle of wet years." Under present conditions, however, with the greater part of the forests gone, and their destruction going rapidly on, we can easily see that heavy and sudden precipitations of equal intensity to those just referred to will cause greater floods and bring greater havoc than before. Floods are frequently fol-

⁶ Government Station Report for Bloomington, Ind., March 25, 1913.

⁷ Reynolds, Robert U. R. *The Ohio Floods: Their Cause and The Remedy.* American Forestry, May, 1913, p. 288.

lowed by serious drouths, such as the one of this year, frequently finishing the destruction of much that the flood may have left. In southern and southeastern Indiana Culbertson⁴ states that "less than 10 per cent. of the original forest areas are still left intact," and the original forests that do remain have in most instances "not more than 30 per cent. of their former number of trees." Other parts of the state that were forested are about in the same condition. Culbertson⁵ also draws attention to "the gradual lowering of the ground water level in all portions of the State" and the results of such a disastrous state of affairs. Culbertson⁶ also points out for the southern part of Indiana which he studied that many "streams that thirty years ago furnished abundant power for mills during ten months of the twelve now are even without flowing water for almost half the time." The same state of affairs exists in most of the other deforested parts of Indiana. It is not at all difficult for one to recall springs and streams that ran vigorously the entire year but which now are either inactive or else run only during the wet season.

Erosion is generally one of the most conspicuous and damaging results of a flood in a deforested region. In foreign countries which have been deforested for a long time, as for example China, great damage has been done. The same thing I have seen in Italy, a part of whose once forested surface is badly cut up by the rush of unchecked floods. But in this country, especially in the southern part of Indiana, erosion is very evident and bottom lands that were not eroded have been damaged or rendered useless by debris and stones carried down from deforested hills.

A statement from a United States bureau⁷ shows some of the results of erosion. "According to the latest determinations (beginning with the classic measurements of the Mississippi by Humphreys and Abbott) the rivers of the mainland United States are annually pouring into the seas fully 1,000,000,000 tons of sediment. This sediment is carried partly in solution but chiefly in suspension, in the 35,000,000,000,000 cubic feet or more of river water drained from the United States and is additional to the coarser detritus pushed or rolled along the sides of the swifter streams. The volume of material thus lost to the land is increasing with settlement and cultivation; it is almost wholly washed from the surface and is the

⁴ Culbertson, Glenn. Deforestation and Its Effects Among the Hills of Southern Indiana. Ninth Annual Report of the State Board of Forestry, 1909, p. 63.

⁵ I. C., p. 65.

⁶ I. C., p. 74.

⁷ Yearbook of the Department of Agriculture, 1907, p. 82.

very richest soil material, the cream of the soil. The value of the material is not easily fixed, but at a moderate appraisal the annual loss would exceed all the land taxes of the country. Besides impoverishing the soil, the sediment pollutes the water, reducing their value for domestic and manufacturing purposes and endangering the lives of those compelled to use them, and causing streams to scour their channels and build bars; and through scouring and building it compels the lower rivers to shift and overflow, thereby reducing the value of fertile bottom lands. However estimated the loss is enormous, and the chain of evils resulting from the annual erosion of this billion tons of soil is long and complex and leads directly back to the farm."

How easily and rapidly water may transport objects with the increasing swiftness of the current is seen from the following experiment given by Page¹²: "It has been found by experiment that a current moving at the rate of three inches per second, will take up and carry *fine clay*; moving six inches per second, will carry *fine sand*; eight inches per second, *coarse sand*, the size of linseed; twelve inches, gravel; twenty-four inches, pebbles; three feet, angular stones of the size of a hen's egg."

"It will be readily seen from the above," says Le Conte¹³, "that the *carrying-power increases much more rapidly than the velocity*. For instance, a current of twelve inches per second carries gravel, while a current of three feet per second, only three times greater in velocity, carries stones many hundreds of times as large as grains of gravel." "A current" running three feet per second, or about two miles per hour, will move fragments of stone the size of a hen's egg, or of about three ounces' weight." Then from the law established we say¹⁴ "a current of ten miles an hour will carry fragments of one and a half ton, and a torrent of twenty miles an hour will carry fragments of 100 tons' weight. We can thus easily understand the destructive effects of mountain-torrents when swollen by floods."

Hall and Maxwell¹⁵ state that "when the slope exceeds 10 per cent., cultivation does not long go on before erosion sets in, and erosion if unchecked will remove the soil and gully the surface until all fertility has

¹² Page's Geology, p. 28. Quoted by Joseph Le Conte in his Elements of Geology, Fourth Edition, pp. 18-19.

¹³ Le Conte, l. c., p. 19.

¹⁴ Le Conte, l. c., p. 20.

¹⁵ Hall, Wm. L. and Maxwell, Hu. Surface Conditions and Stream Flow.—Forest Service Circular 176, p. 10.

gone and all productive power is lost." And further Culbertson¹⁶ says that in southeastern Indiana "contrary to what might have been supposed, a larger per cent. of the steep hill slopes has been cleared than the land of the more level regions." In such a case as this just the reverse method of clearing the forests as to location should have been followed for reasons above stated.

One of the ways in which large amounts of forest trees are destroyed is for railroad ties, and enormous numbers of them are required. Brisbie¹⁷ states that "to build 71,000 miles of railway required 184,600,000 ties. Ties have to be replaced every seven years. As every one knows, railroad ties are cut from young timber, the trees being from eight to twenty inches in diameter, and this demand strikes at the very source of our timber supply." "The number of cross-ties in use on the railroads of the United States is estimated to be about 620,000,000; the number used annually for repairs and for extensions of track is estimated to be from 90,000,000 to 110,000,000, requiring, we may say, the entire product of 200,000 acres of woodland annually."¹⁸ So rapid has been the consumption of timber for ties and the exhaustion of the supply so apparent that some years ago the Pennsylvania Railroad Company began to plant trees from which later on to get its ties. For railroads to do this is a rather late plan. Notwithstanding some views to the contrary, iron ties ought to be used and probably will be used in the future. About the year 1888 the fences of the United States were valued at "\$2,000,000,000," "and it" cost then "\$100,000,000 annually to keep them in repair."¹⁹ These and other causes aside from lumbering show the waste of timber which years ago could have been practically prevented by the use of other and better materials. In most instances if the timber removed from the land and wasted were now available it would exceed in value that of the land.

In 1909 there were 48,112²⁰ saw mills being operated in the United States. Of these in 1910 there were 1,044²¹ in Indiana. These mills vary much as to capacity, but the daily output of all is enormous. Timber is today being cut into lumber that a quarter of a century ago in Indiana would in many cases have been rejected as fuel. In addition we have in

¹⁶ Culbertson, Glenn. l. c., p. 63.

¹⁷ Brisbie, James S. *Trees and Trees-Planting*. 1888, p. 9.

¹⁸ Fifth Annual Report of the State Board of Forestry, 1905, p. 209.

¹⁹ Brisbie, James S., l. c., p. 9.

²⁰ Elliott, Simon B. *The Important Timber Trees of the United States*, 1912, p. 10.

²¹ *American Forestry*, 1913.

Indiana as elsewhere the veneer-mills, that are able, however, to cover up a multitude of sins.

Following deforestation comes, sooner or later in this country, the proverbial forest fire which completes the destruction by killing the small trees and destroying the possibility of the future forest. It is not necessary to discuss the results of such fires further than to state that locomotives generally cause most of such conflagrations, and consequently steps are being taken to have the trains in some places, as in parts of Canada, run by electricity. Spark arresters are a failure. In 1909 it was estimated that in Indiana the annual loss from forest fires was \$175,000,²² and this seems to be a very conservative estimate. For the prevention of fires in Indiana some laws have been enacted and in every possible way those in charge have endeavored to lessen the danger. Efforts to pass more favorable laws for forestry have been attempted in Indiana, such as exemption from taxation, but this "failed because it could not be done constitutionally."²³ It would be well if the cutting away of the forests could be controlled by law. For instance it is a serious mistake to allow anyone to buy a stretch of forest, especially in hilly districts, then to move in a sawmill and cut out all the available timber without regard to reforestation or results, and then finally to sell the land for what it will bring or to allow the soil to wash away. In some foreign countries the removal of forests is controlled. In France, for example, even years ago an owner was not allowed to remove forests on his land without "four months" notice in advance. The forest service may forbid this clearing in case the maintenance of the forest is deemed necessary upon any of the following grounds:

- "1. To maintain the soil upon mountains or slopes.
- "2. To defend the soil against erosion and flooding by rivers, streams and torrents.
- "3. To insure the existence of springs and water courses.
- "4. To protect the dunes and seashore against erosion of the sea and the encroachment of moving sands.
- "5. For purposes of military defense.
- "6. For the public health."²⁴

²² Tenth Annual Report of the State Board of Forestry, 1910.

²³ Fifth Annual Report of the State Board of Forestry, 1905.

²⁴ Pinchot, Gifford. Publications of the American Economic Association, 1891, Vol. 6, pp. 214 and 215.

Germany and Switzerland also maintain a wise control over their forests. Similar protection of the forests of this country should be enacted. One very noticeable thing in this state and country is the extreme waste of the forest resources. This is seen from the time the tree is cut in the woods until what remains of it is issued in the finished product.

This is not the case in some foreign countries, and should serve as a useful lesson to the state. Great service has been rendered to the state already by those who have worked to have the present Indiana forestry laws enacted and by those who by instruction or advice have endeavored to further the cause of forestry in Indiana.

Notwithstanding the presence of other factors which may help to produce or prevent floods, the fact remains as has been sufficiently outlined in this paper by various examples, that deforestation is by far the greatest cause of floods. The examples have shown that where forests are present floods are practically absent, and as the forests are removed the floods become more numerous and destructive.

Probably the most thorough study thus far of any single stream in this respect is that made by M. O. Leighton²⁵ for the Tennessee River. The same state of affairs exists in Indiana, and every effort should be put forth to remedy the danger. The one great element of success will lie in the proper education of the public to the disastrous results of reckless deforestation and the benefits of forest preservation. As Elliott well says: "Probably our forests are in no worse condition today than those of Germany and France two hundred years ago, when those nations began reforestation. Success crowned their efforts and should ours, if we put forth the same endeavors."²⁶

²⁵ Leighton, M. O. Floods in the United States. Cited from Hall and Maxwell, l. c., pp. 5-6.

²⁶ Elliott, Simon B., l. c. p. 15.

THE RELATION OF COUNTY TUBERCULOSIS HOSPITALS TO CONSERVATION OF PUBLIC HEALTH

JAMES Y. WELBORN, M. D.

The broad subject of conservation, although in its infancy, is far reaching in its achievements. Like all innovations, appearing at first as current events, gradually enveloping established customs, making history for an epoch, this idea has grown.

The preponderance of forces necessary for any custom, event, political or social decree, upon which a nation reaches a destiny, has, as an essential for success, to be presented at such an opportune time as to arouse this nation's people to a keen interest. The time, the place, the demand and the recognition are all essential forces for any substantial movement.

The phase of our subject I proclaim to be of the greatest importance, because in conserving the health of the people, we thereby promote conditions for a more perfect physical being necessary to reach a goal of ideal perfection. This is true because upon the public health depends the degree of success in arts and sciences and the good spirit of the human race. It may also be added, in the language of Ex-Governor Marshall, "That upon the public health rests the state of the morals of the people."

Now, how do the County Antituberculosis Society movements conserve public health?

First, by an education; teaching sanitary science and preventing loathsome disease. An example of this is demonstrated by the following: A patient of an ordinary family is treated in the hospital. While there, receiving visits from other members, they learn that to eradicate flies and mosquitoes is a means of saving doctors' and druggists' bills, by preventing malaria and other diseases. They are cited to the necessity of destroying all sputa and dejecta from the body as a means of self-protection. They are shown, to some extent, at least, how to select foods, as to variety and purity, and there are innumerable items to be learned relative to sanitary conditions.

Second, presenting to the people a plea that vice, excesses, loathsome

habits and poisons are dangerous to good health. Various examples can be pointed out—for instance, late hours, alcohol and tobacco, which are prime factors in precipitating severe cases in many of our young men patients. When they are set up as examples to the observing public it often astonishes them as something they had not before thought of. I must also emphasize that when the society is urging all these teachings it forces many negligent physicians to realize the necessity of more strict orders to their patients.

Third, by teaching economy in caring for such victims, thereby reserving forces to be utilized in aggression rather than defense. With resultant effect of the facts in the first and second, there is the beginning of economy, which effects are tremendous in the end, for every case of prevention is the means of saving thousands of dollars, which if saved for other pursuits of the proper kind must broaden the field of attainment by a people physically more able to do work than those weakened by personal or family sickness.

Fourth, that life may be sustained over the disease which has long been thought to be fatal. There are now hundreds of strong working people in the State of Indiana who, if they had not had the intelligent advice and treatment of the society workers, would have been sleeping under sod waiting for other victims of their own infection who were serving their days of invalidism.

The growth of the movement by local organizations has brought about the idea that a united effort is necessary to accomplish the foregoing. As a result, in our state we now have statutes giving power to county commissioners to establish county hospitals for tuberculous (indigent) patients, or to contract with county organizations for the care of such patients. This enables charitable organizations to conduct more successfully the institutions they are establishing. In fact, if this law had not come into effect, public charity could not support the crying demands. Such a failure would gradually burden the cheerful donor, and baffle the philanthropic workers. When such cooperation exists, civil and charitable forces are also supported by individuals able to pay small but reasonable sums for attention, instead of great amounts necessary in seeking distant health resorts, I will suggest that cooperation in this state, will enable each group of people to learn the most conservative methods to be employed in this branch of work. A monthly state journal should be published, in which the workers of this state can embody system and cooperation of efforts.

PLAYGROUNDS AND RECREATION CENTERS AS FACTORS IN CONSERVATION OF HUMAN LIFE.

DR. W. A. GEKLER.

The enormous industrial development of this country in the past thirty years has brought with it the serious problem of devising some means whereby the harmful effects of factory labor and the crowding of workmen and their families into tenements and the districts about the factories may be counteracted and corrected. Our own native-born population, as well as the largest proportion of the immigrants that come to our country, have been forced to adapt themselves to a manner of life which is entirely different from that to which they have been accustomed. The child growing up in these surroundings, as well as the adult worker, needs besides proper food and properly constructed dwelling houses the playground and recreation center to preserve not only the physical but the moral health of the class to which he belongs.

The conservation of the life and health of our population cannot be attained through sanatoria and hospitals. From a business standpoint it is very poor policy to build institutions to repair damage that has been done and then not take the necessary steps of prevention. Although we will never be able to eradicate diseases entirely there is a possibility of a great reduction in disease, and with it a lengthening of the average life of the individual. We need more than good housing conditions, a living wage, pure food and proper sanitary conditions in our factories to bring about these things.

Recreation and play are as necessary for the physical well-being as are some of these other things just mentioned. The growing child needs them for the proper development of his body and the adult needs them to keep his body in a healthy condition. Although the prevention of infectious diseases is in the last analysis a question of quarantine, the physical condition of the individual plays a very important part in every infectious disease. As long as the community must suffer through the sick-

ness or death of a worker it is very plainly the duty of the community to take the necessary steps of prevention. The playground is one of the necessary means of prevention of disease and has already proven its worth in those communities where it has been given a trial.

The recreation center should be an important factor in the proper education of our workers in the laws of hygiene and health. The ignorance of the average person concerning the facts of health and the early manifestations of such diseases as tuberculosis, cancer and occupational diseases is in no small way responsible for the large number of incurable invalids which our community has to support. It has been estimated that tuberculosis kills almost one-third of our workers who die between the ages of twenty and thirty-five, and it is the experience of nearly all who have much to do with the treatment of tuberculosis, as well as the other diseases mentioned, that a large proportion of our incurable cases have applied to the physician for help and advice only after the disease has progressed to a point where relief or cure are impossible.

The factory and those conditions which have arisen in the growth of our present industrial system have affected not only our public health, but also the moral tone of the community. The church as it exists today is scarcely able to cope with the moral problems which have presented themselves, and it has been found that the moral and physical problems are very closely bound together. The natural desire of the average worker, and we might as well say his need, for play and recreation has had to be satisfied at the saloon, pool-room, cheap theatre or on the street. The enormous increase of crime and degeneracy in the past few years has shown that the effect of, at least, some of these agencies has been to work great harm to the individual and finally through him to the community at large.

The individual needs not exhortation to refrain from doing those things which are harmful to him morally and physically, but an opportunity to satisfy his needs for recreation and play in a way which cannot have this harmful influence. The tendency of the average person when given a choice between the good and the bad is to instinctively choose the good, when he once understands it. The experience of the settlement houses and Y. M. C. A.'s over the country is abundant proof of this. Conditions have now become so that it is the duty of the community to make the playground and recreation center a part of its regular activities as

well as the public school and library system. This work should no longer be left to public charity and the philanthropy of wealthy individuals, which of its very nature repels the self-respecting worker who cannot accept charity without sacrificing a part of his self-respect. The playground and recreation center should be built and maintained out of the taxes of which he pays his share, so that he will take advantage of these things as his own and not the gift of those to whose wealth his work has contributed.

Let the playground and recreation center be combined with our public school and library for the physical well-being of the community as well as its education. Make the influence of this combined institution broad enough and free enough to reach all of our workers. Then with proper housing, pure food, a living wage and hygienic surroundings in the work shop and the factory our playground and recreation center will complete the steps we must take for the conservation of human health and life.

PUBLIC TOILETS, PUBLIC DRINKING FOUNTAINS AND
PUBLIC SPITTING IN RELATION TO THE CONSER-
VATION OF HUMAN LIFE.

— — — — —
C. M. HILLIARD.
— — — — —

Public supplies and public conveniences are always public dangers, and for two reasons: they may affect large numbers of people, and they are always beyond the control of the individual who is obliged to use them. The municipality and the state has, therefore, a grave duty; viz., to control and to supervise public commodities of all kinds.

We no longer believe that disease is the result of the "malice of Satan," or a "rebuke of God," but rather consider it the result of personal or public ignorance and neglect. Decomposing potatoes and pin-holes in the sewer pipes are no longer believed by intelligent people to be the cause of typhoid fever, but every new case is new evidence of deficient civilization. Infectious diseases are caused by living germs and these parasitic germs live and grow only within the body of man, for the most part. They perish quickly in the harsh external environment. For the continuation of infectious diseases it is necessary that a more or less direct transfer of fresh nasal, oral, urinary or alimentary excretions from one body to another susceptible body take place. The body must be frequently freed of these accumulations of wastes, for just as wastes in a community may "breed" ill health and nuisance, so much more important is it to rid the cell community—the body—of its wastes.

The problem of public sanitation is two-fold. First, it must reduce to a minimum the possibilities of transfer of the germ-laden body excretions from person to person. Secondly, it must provide every public need and commodity that tends to raise the vital resistance of the people. There is no more potent force tending to good health than the condition of the body; its resistance to variable external conditions and parasite invasions depends upon this general health tonus.

Toilet facilities should be furnished by railroads, hotels, bars, amusement places as theatres, fair-grounds, etc., and by municipalities in fre-

quested public places as squares, playgrounds and especially public schools. A sniff of, or a glance at the accommodations offered the public in railroad stations or theatres in many instances is argument enough against conditions as they exist about us.

Public toilets may be exchange places of disease germs. Evidence is not lacking that epidemic disease frequently spreads from these centers. Occasional cases of venereal disease or even of intestinal disease may be traced to toilets. Trachoma and various infections are transmitted from person to person by the common roller towel. The indirect effect of inadequate facilities and revolting toilets, making it impossible or undesirable for people to free the body of its wastes, and hence affecting the resistance of the body, is much more important than the direct transmission of disease germs in this case. A nation's or a town's refinement, education and morality may well be noted by the comfort, privacy and inviting facilities it offers to its inhabitants for the evacuations of the body. It is beyond the scope of my paper to indicate the dire effects resulting from improper functioning and improper attention to this important need. Suffice it to say that many so-called functional diseases as liver and kidney trouble, frequent headaches, intestinal disorders and other disorders are frequent sequelae due to neglect of ridding the body of its wastes. The impairment of the functioning of these vital organs tears down the general normal barriers to infectious diseases and so indirectly, lack of sufficient and inviting toilets is a cause of much sickness, suffering, and even of death.

The public drinking cup has been condemned because it affords an ideal vehicle for the mutual exchange of saliva. People who will laugh heartily at the joke when you suggest "swapping gum" serenely follow you to the public fountain and mouth the cup directly after you and dozens of others. In 1909 Kansas, Michigan and Mississippi first adopted regulations against the use of the common drinking cup in schools and railroad trains, and now several states, including Wisconsin, Massachusetts and California have legislated against this disease distributor.

As with toilets, the problem of public drinking facilities involves a question of direct transfer of disease virus and one of general body conditioning. It is a simple matter to demonstrate mouth epithelial cells and mouth streptococci on the edge of the public drinking cup, and it is obvious enough that disease germs are always potentially present and may pass in a few minutes, or even seconds from the mouth of the incipiently sick or

convalescing, or the healthy "carrier" of diphtheria, scarlet fever, tuberculosis, pneumonia, tonsillitis, mumps, whooping-cough, measles, infantile paralysis, common colds or other infectious diseases into the mouth of the healthy, willing susceptible.

The normal functioning of the body is absolutely dependent upon abundant water being furnished the system, and a deficiency leads to general ill health and lowered resistance. Abundance of water is almost as important as purity of water. Sufficient and attractive facilities as well as clean water offered from sanitary devices should be furnished the public.

The war against public spitting has been vigorously and efficiently waged for some time now and with undoubted good results. Just what the relative importance of large masses of sputum thrown into the environment is when contrasted with saliva exchanges that take place in more obvious and direct ways on things smeared either directly by the lips or by the fingers moistened with saliva, I do not venture to state. Our epidemiological evidence and our laboratory findings seem to be opposed to the theory that disease is very generally spread through the medium of the air. Sputum thrown upon the sidewalk or in the hotel lobby dries slowly as a rule and tends to adhere to the surface upon which it is dried. The dryness, light, time and other factors are germicidal and the disease germs present, especially, tend to quickly perish. Saliva deposited on food by the cook or waiter, on pencils exchanged by children in school, on street-car checks by conductors, on soda glasses, trolley straps, the leaves of books and a multitude of things that we come in contact with in the daily routine seems to find a more direct route and gives ample room for explaining obscure endemic cases of disease of the respiratory tract. For my part, I had rather have the car conductor spit on the floor than deposit a lesser amount on the check he hands me. I believe it is high time our anti-spitting league took on a new, broader work and began an anti-saliva campaign. Spitting may, and undoubtedly does spread disease. It is a vile habit and should be prohibited. The campaign against it will raise the public opinion of cleanliness and civic responsibility and will tend to improve the sanitary tone of a community.

The phenomenon of improved municipal health following the substitution of a pure or purified water supply, for a polluted supply is too common to need illustration. Other sanitary improvements, as installation of a proper sewage or garbage disposal plant or a clean milk campaign, like-

wise affect the public health in a spectacular and demonstrable way. It has frequently been observed that the decrease in death rate following these specific improvements is greater than would be expected. For example, a clean water supply may always be expected to lower the mortality of water-borne diseases, chiefly gastro-intestinal diseases. In many instances it has been found that the general death rate is lowered more than can be explained by the typhoid component and that diseases of the respiratory tract are reduced. This may be explained by supposing that diseases other than intestinal may be water-borne, or it may mean that the general vital resistance of the people of the community is raised by more abundant use of a pure water. When a community reaches that stage of sanitary enlightenment and common-sense cleanliness that it demands proper disposal of its wastes and provides for a pure public water, we may expect that other less spectacular sanitary reforms are being practiced, so that there are a number of contributory causes to improved health. Thus the general resistance tonus and the public's hygiene practice is a significant health factor. Providing sufficient and clean public toilet facilities; convenient, numerous and sanitary drinking fountains, and the abatement of the barbaric, disgusting habit of public spitting are plain civic duties, and are factors in the conservation of human life and happiness.

We would recommend:

1. Regeneration and extension of public toilet facilities, especially emphasizing the need of proper care of public toilets. The most perfectly constructed toilet will be unsanitary in a short time if not efficiently cared for. A score card might be used in inspection to give a picture of the conditions and to indicate improvement from time to time. I have devised and used such a score card effectively.

2. The final condemnation of the public drinking cup, especially in schools. One of the lessons in hygiene in schools might well be devoted to teaching children how to make their own paper drinking cups, the teacher furnishing them with clean paper of convenient size and shape throughout the year. Soda fountains are culpable and there should be legislation or action of some kind against the present soda fountain and glass, a public drinking cup.

3. The extension of our anti-spitting and anti-saliva campaign, including the dissemination of information relative to the more direct and dangerous modes of transfer of nasal and oral secretions.

POWER ECONOMY IN THE SOUTHERN INDIANA QUARRY INDUSTRY.

G. C. MANCE.

The limestone quarry industry of southern Indiana offers a fertile field for research along the lines of conservation. The early operators adopted wasteful methods of production, feeling that the abundance of the deposits would give an unlimited supply of first-grade stone. The tendency has been to continue with the old methods and machinery to the present time. Within the last few years, however, competition has become so keen that many of the operators of the district have begun to realize the wastefulness of the present methods and to look for more efficient ones.

The principal losses accompanying the production of building stone in Monroe County can be grouped under four heads:

- (1) Losses of second-grade stone.
- (2) Losses of human labor.
- (3) Losses of lime, cement and fertilizing materials.
- (4) Losses accompanying power production.

The losses due to inefficient methods of power production are probably the greatest and the most in need of remedial action. The method of power production throughout the district is wasteful in the extreme. Power is generated in a large number of separate units distributed over the quarry and there is a great loss of human labor in supplying the coal where it is to be used as well as a great loss of coal due to careless handling. Several quarrymen have made careful tests upon channeling machines, at my suggestion, to determine the amount of coal consumed by the different types of machines during a given run, and it has been found that while the Sullivan or Ingersoll channelers cut faster they consume practically twice the amount of coal in a given period of time as the Wardwell type of channeler, which is widely used throughout the district.

In many of the mills the boilers and engines have been in operation over twenty years and the amount of coal used per horse-power hour is at

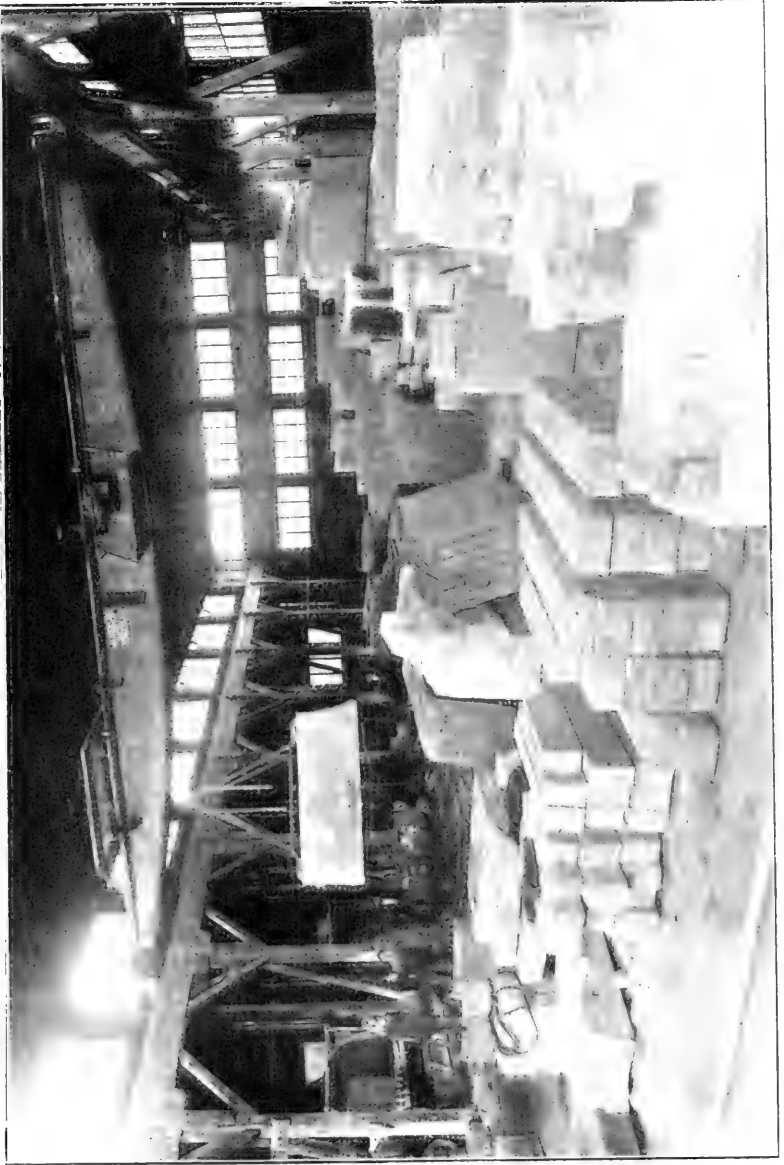

The Interior of a Modern Mill. This Mill is Entirely Equipped With Electrical Machinery. The Power is Purchased of a Local Power Company.

least six times as much as would be necessary with up-to-date machinery and methods in large central plants.

During the last nine months I have visited all the mills and quarries of Monroe County which are at present in operation, and have taken data on the coal consumption and power produced throughout the district with an idea of showing how great these losses are and at least suggesting a remedy for some of them.

From the data taken I have chosen three plants which are representative of the older type and have averaged them so as to avoid giving out the data of any single plant. The data are as follows:

Amount of coal used per month (tons).....	135
Cost of coal at the mine at \$1.15 per ton.....	\$155.25
Freight on coal at \$.55 per ton.....	74.25
Total cost of fuel.....	229.50
Horse-power developed, engine rating.....	75
Hours of running time during the month.....	240
Coal consumed per horse-power hour (lbs.).....	15

I have also taken the data for three of the more modern type of plants and averaged them to show the great improvement already made toward greater economy. The data are as follows:

Amount of coal used per month (tons).....	192
Cost of coal at the mine at \$1.15 per ton.....	\$220.80
Freight on coal at \$.55 per ton.....	105 60
Total cost of fuel per month.....	326.40
Horse-power developed, engine rating.....	200
Hours of running time during the month.....	240
Coal used per horse-power hour (lbs.).....	8

Although these figures show that a great improvement has already been made in power production, they also show that there are still great possibilities for further reduction in power costs.

The saving of human labor engaged in the production of the power in central plants over the present methods would amount to two-thirds of the number of men now engaged.

In my final paper on the subject I hope to carry out the above figures

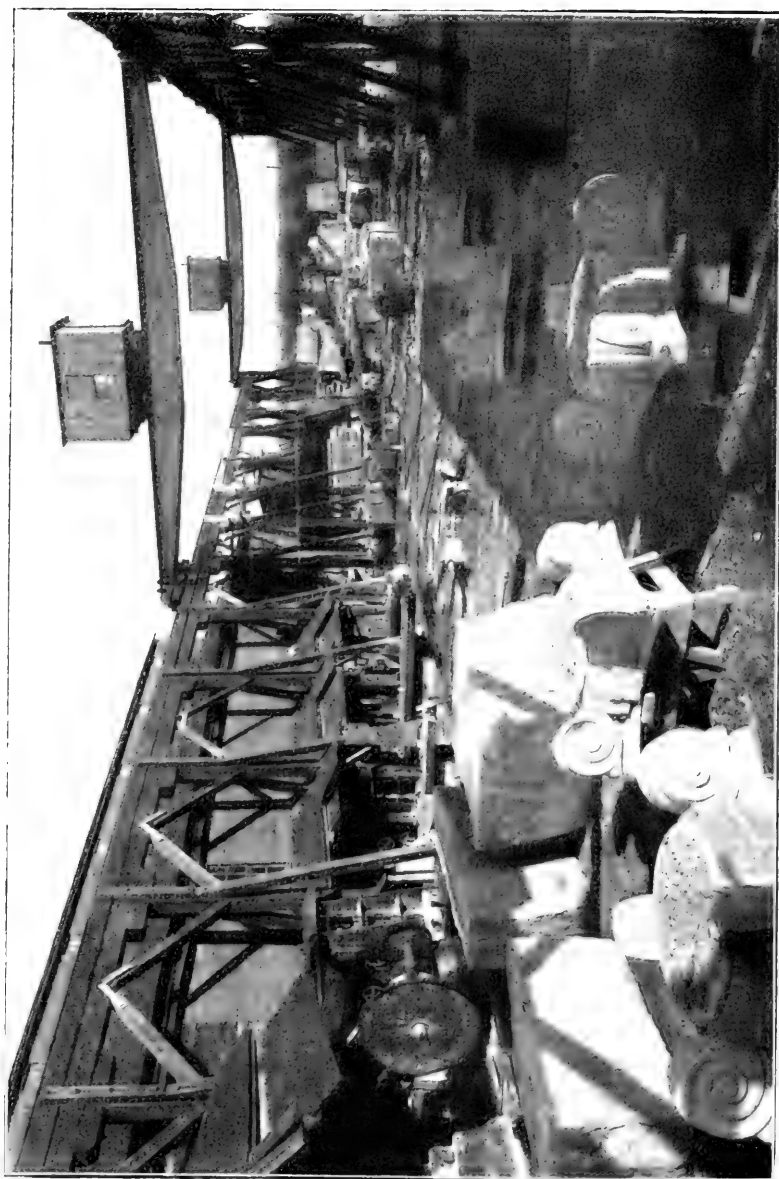

This is a Type of the Outdoor Yard. Winter Work is Out of the Question. These Plants are Slowly Disappearing in Favor of the Inclosed Plant.

fully enough to show the actual cost of power by the present methods in use in the district. At present my data on the value of the machinery and plants and the rates of taxation, insurance, etc., on the same is not complete enough to give any but a very approximate figure.

Engaged in the stone industry of the county there are twenty-nine operating companies controlling twenty-six mills and sixteen quarries. They use approximately 5,000 H. P. and 4,000 tons of coal per month in its production.

For convenience in studying the problem of power production of the county I have divided it into three districts as follows:

District No. 1 includes all the plants in and around Ellettsville and Stinesville. This district is controlled by six companies running six mills and two quarries. They use approximately 1,000 H. P. and 750 tons of coal to generate the power.

District No. 2 includes the quarries and mills of Bloomington and Hunter Valley. This district is controlled by eleven companies running eleven mills and five quarries. They use 2,000 H. P. and 1,700 tons of coal per month in its production. Two of the plants of this district buy electrical power from the Central Indiana Lighting Co. of Bloomington, and in figuring the coal consumption for the district I have added the amount of coal they would use in the production of their power if they worked under the same conditions as the other operators of the district.

District No. 3 includes the rest of the county, that is, all the mills and quarries around Clear Creek and Saunders Station. In this district there are twelve operating companies running nine mills and nine quarries. They use approximately 2,000 H. P. and consume 1,650 tons of coal.

In looking for improved methods of power production the following possibilities present themselves:

First, each operator can make an effort to produce as much of his power in a single unit as possible, and distribute the power to the different machinery of his plant electrically. This method is becoming more and more common in the stone mills of the county, but very little effort has been made toward the use of electrical machinery in the quarries.

At least two of the operators of the district are using compressed air to drive their quarry machinery, but a careful study of the costs of power production in this form shows that the fuel cost is materially raised, although the advantages of such a system are: Small waste in handling

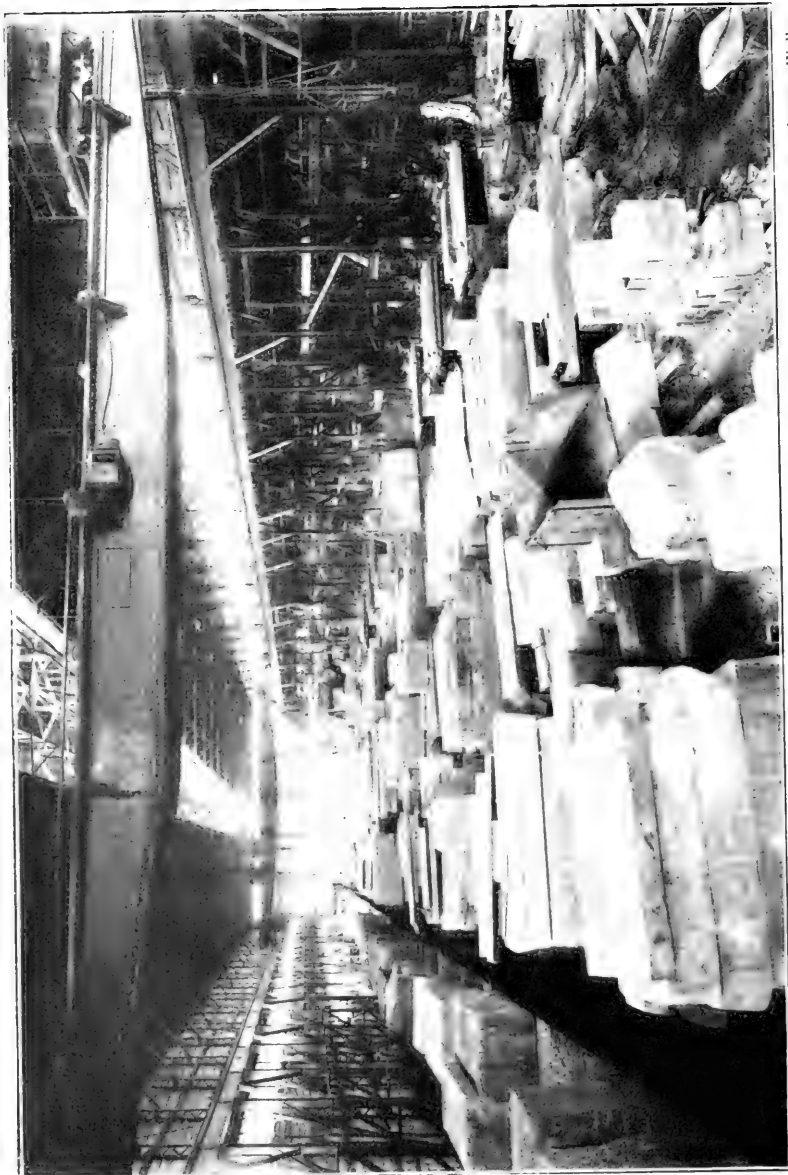

An Interior View of the Plant of One of the More Up-to-Date Companies. This Plant is Equipped for Night and Day Running, as Well as Winter Work.

coal, less human labor, and a cleaner quarry. As a method of conserving power it cannot be called successful, although the failure in one case may be laid to the fact that the channeling machines used with compressed air are of the old steam types with the air hose introduced into their boilers, thus keeping the faults of the steam channeler and adding to them the line losses of compressed air. This method would be far more economical with modern compressed air chambers.

Second, a central plant for each district might be constructed with an idea of handling the coal more easily and having an adequate water supply. These plants could be located so that the cost of distribution of the power by electricity would be a small item, as the districts are reasonably compact and easily reached.

Third, we might consider water power with electrical distribution to the plants. In fact, such a plant is already in existence at Williams, but on account of the uncertainty of their water supply the plant is equipped with a steam auxiliary. Their proximity to the quarries and mills of Lawrence County makes it probable that most of their power will be sold there, as the heavier line losses in distributing to this district would tend to center their interests in the southern part of the stone belt. Other projects have been suggested, but the extremely high first cost of the construction of a water-power plant makes it rather a question of the future than of the present power problem.

Lastly, and probably the most economical solution of the problem is the construction of a large central plant in the coal fields with high tension transmission of the power to the quarry districts and the use of electrical machinery throughout the plants. This plant could be equipped with modern automatically stoked boilers with superheaters and condensing engines; or the plant could be equipped with gas producers and gas engines. An interesting calculation on the subject can be made by taking a single district and showing the possibilities for that district if the operators could unite to solve their power problem.

I have taken District No. 1 and attempted to calculate the cost of such plants from the data available, but, in general, calculations of this kind are only approximately true, as the price of materials is constantly changing and the tendency of contractors is to hide the true costs by unbalanced bidding. This makes it difficult to estimate prices.

The following figures are reasonably correct for a 1,000 H. P. plant:

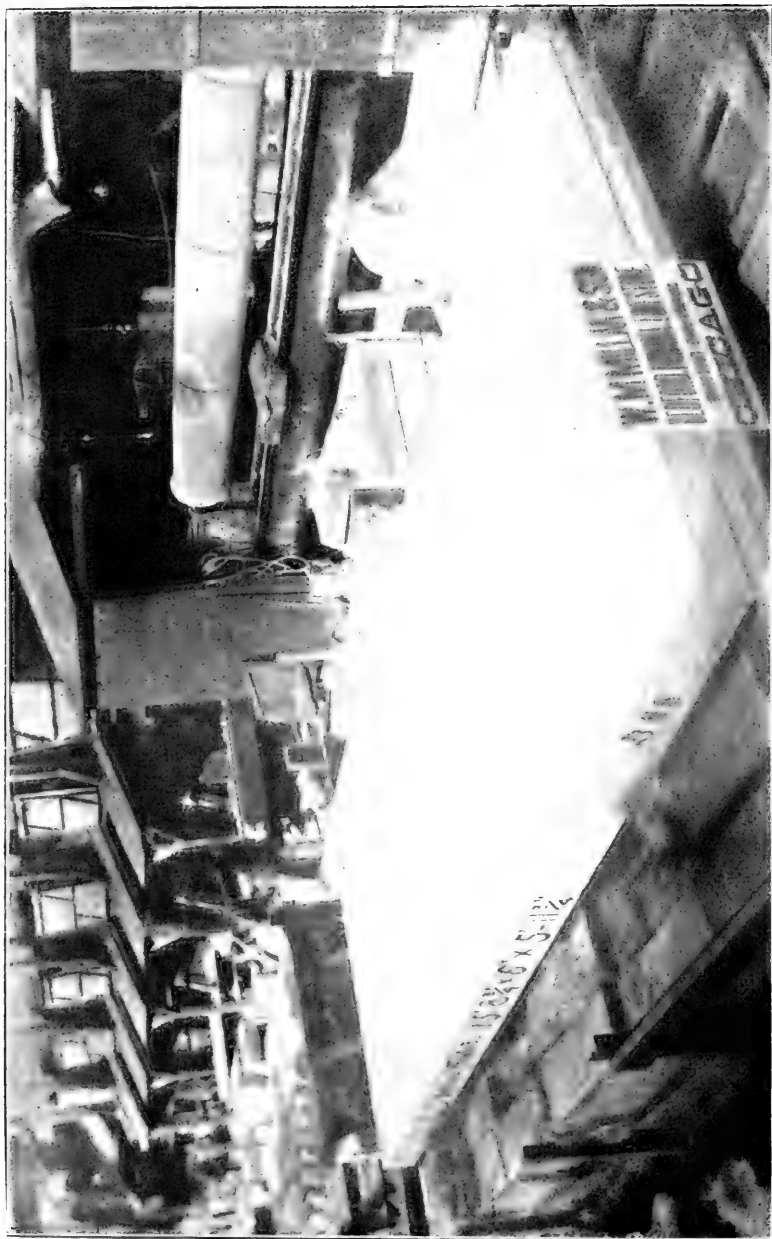

A Yard in One of the Local Mills, Showing One of the Largest Slabs of Dressed Stone Ever Sent Out of the District.

Steam plant:

2 engines totaling 1000 H. P.....	\$25,000
Necessary auxiliaries at \$8.50 per H. P.....	8,500
4 fire-tube boilers, 200 H. P.....	5,700
2 400 K. W. generators, 550 volts.....	9,628
2 16 K. W. exciters, direct current.....	810
Switchboard equipment, \$4.25 per K. W.....	3,400
Cost of stack at \$3.00 per H. P.....	3,000
Foundations for engines and boilers.....	3,000
Piping and installation.....	2,000
	<hr/>
Total cost of plant without buildings.....	\$63,038

If turbines were used with three 250 H. P. water-tube boilers and superheaters instead of the above equipment, the total cost would be \$57,150.

The fixed charges against the steam plant would be as follows:

Interest at 5 per cent. on whole investment.....	\$3,152
Taxes and insurance at 2 per cent.....	1,251
Depreciation at 10 per cent.....	6,304
	<hr/>
Total fixed charges.....	\$10,717

Operating charges for one year:

Labor.....	\$3,900
Coal at \$1.70 per ton, 5,000 tons.....	8,500
Repairs, 1 per cent. of first cost.....	630
Oil, waste, etc.....	1,650
	<hr/>
Total operating cost.....	\$14,680
Total cost of power for the year.....	25,397

Price per K. W. hour, calculating on a 10-hour run, 308 days, 1.1 cts. The same calculations on a producer-gas plant of the same size offer a comparison which is well worth studying.

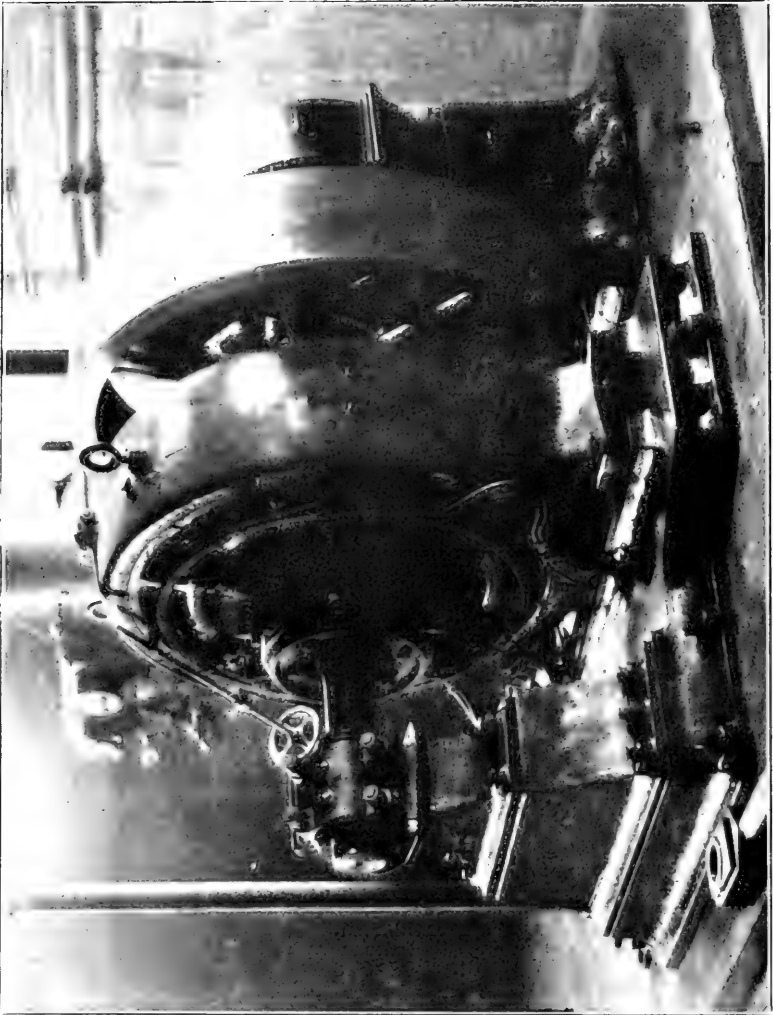

A 105 H. P. Fleming Harrisburg Engine Direct Connected to a 75 K. W. Westinghouse Generator. This Engine is Carrying Three Electric Cranes; a Diamond Saw, and the Lights for the Plant. This Outfit is Economical When Carrying a Fairly Constant Load Near Full.

The cost of such a plant would be as follows:

Gas-producers at \$23 per H. P.	\$23,000
Accessories, including draft equipment, \$9 per H. P.	9,000
2 500 H. P. gas engines.	38,000
2 400 K. W. generators 550 volts.	9,628
2 16 K. W. exciters direct current.	810
Switchboard equipment at \$4.25 per K. W.	3,400
Foundations for engines and producers.	3,000
	<hr/>
Total cost of plant without buildings.	\$84,138

Fixed charges on gas plant:

Interest at 5 per cent.	\$4,207
Insurance and taxes at 2 per cent.	1,683
Depreciation at 10 per cent.	8,414
	<hr/>
Total fixed charges.	\$14,304

Operating charges on gas plant for one year:

Labor	\$3,900
Coal at \$1.70 per ton, 1,500 tons.	2,550
Oil, waste, etc.	1,650
Repairs	630
Total operating cost.	8,730
	<hr/>
Total cost of power for the year.	\$23,034

Cost per K. W. hour, 308 days, 10 hrs. per day, .93 cts.

I have placed in the equipment two engines with the idea of showing another economy. The villages of Ellettsville and Stinesville do not have an electrical plant for lighting. If such a plant as I have outlined were erected there the over-night run on one of the engines would furnish much-needed power for lights at a very small expense. In fact the power could be developed for an additional .4 of a cent a K. W. hour after the fixed charges have been figured against the day run.

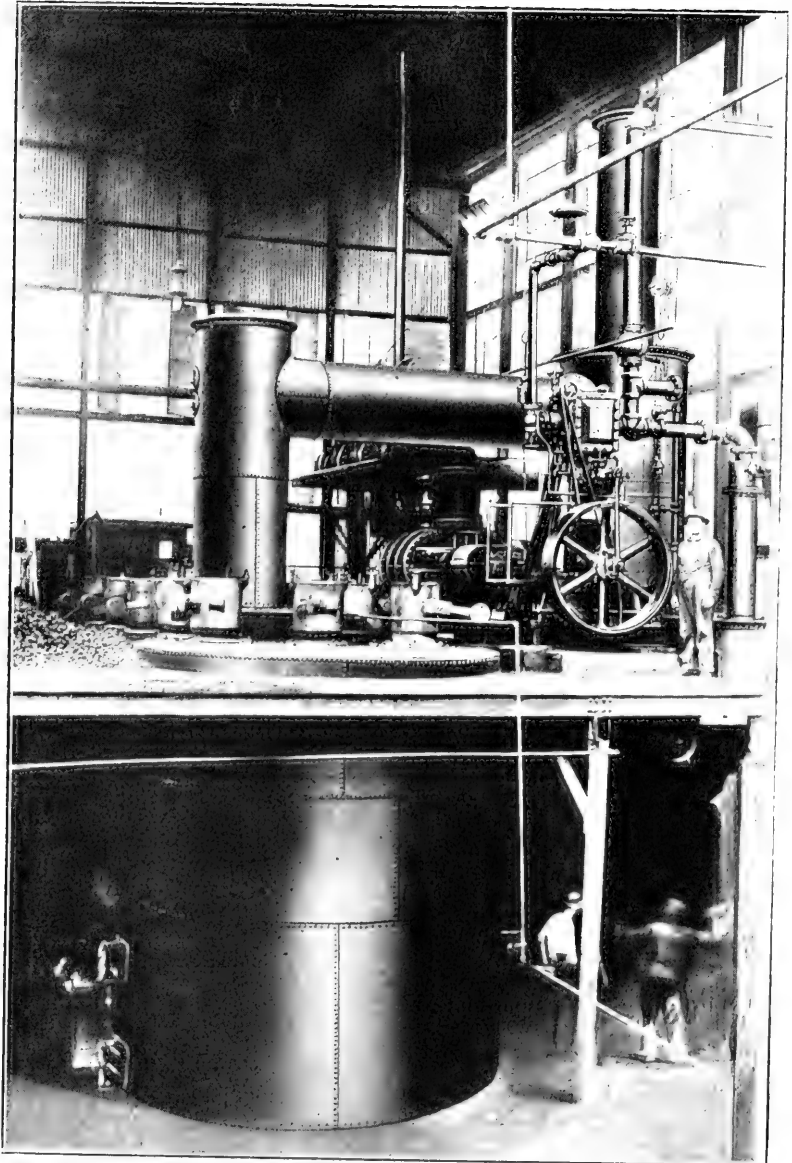

A View of Both Floors of a 1000 H. P. Producer-Gas Plant.

From these figures it will be seen that there is only a slight difference in the cost of power for the two types of machinery, but these figures would diverge in favor of the gas producers as the size of the plant was increased. If the plant were located in the coal fields and the power brought over as high voltage current, the amount of money saved on freight would pay for the transmission line in about eighteen months. In fact, for such a plant the line losses and cost of transformers at both ends of the line would bring the price of power to about the same figure.

Probably the ideal solution for the power question would be to furnish the entire district with power. This plant to be located in the coal fields and be of the by-product recovery type with gas engines and the power transmitted at 33,000 volts. Such a line and voltage would be the cheapest for conditions as they would be in this district.

There are numerous plants in Europe which depend upon the by-products recovered for their profits. A good example is the plant at Dudley Port, South Staffordshire, England, where a Mond by-product plant practically pays for all the fuel used, in the by-products recovered. The two principal by-products are ammonium sulphate and tar. The ammonium sulphate alone returned \$2.25 per ton of coal burned, and the tar sells for \$0.19 per ton of coal burned.

Ordinary bituminous coal will return 80 to 90 pounds of sulphate of ammonia per ton. Such plants now in operation produce a Kilowatt per hour of power on 1.54 lbs. of coal fired. Since the price of coal is so low in this district the cost of power would be but little over the fixed charges on the investment. This problem of power economy for the quarries begins to be of especial interest over the entire district, and if the issue were met squarely a great saving of money would result, as well as great economy in coal consumption.

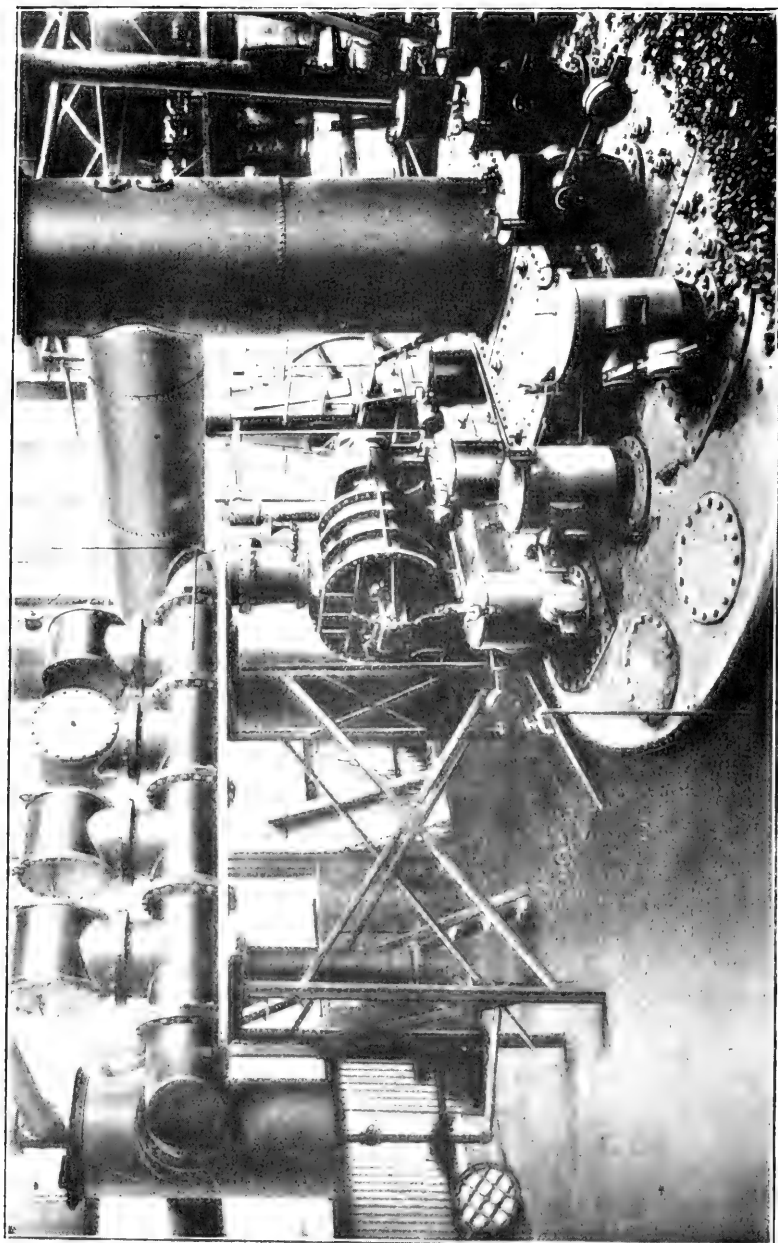

The Feeding Floor of a Large Producer-Gas Plant, Showing the Large Floor Space Occupied.

REPORT OF THE COMMITTEE ON "A LIST OF THE SCIENTIFIC AND TECHNICAL SERIALS IN THE LIBRARIES OF THE STATE OF INDIANA."

In submitting to the Academy the final results of the work of your committee it seems desirable that some explanations should be made. The former catalogue, published in the Proceedings of 1911, owing to the short time allowed for its preparation, was compiled in such haste as to be very defective both typographically and in its completeness. It is doubtful if anyone realized the size of the task or the difficulties to be encountered when the committee was first organized. The extension of the scope of the list as well as the number of libraries to be included in the present revised list has more than doubled the size of the catalogue and has greatly multiplied the difficulties.

Owing to the wide distribution of the libraries it has not been possible for the committee to inspect the serials of every library, and the work has been largely carried on by correspondence and the cooperation of many librarians. Although this has often put a considerable burden of work upon the librarians or their assistants the committee cannot complain of any lack of genuine interest and hearty co-operation in our undertaking. It is, however, impossible to formulate a practicable set of rules for the guidance of librarians in making out their lists that will provide for all contingencies. The task of correlating the numerous items in these many lists has been extremely difficult and in frequent cases impossible with any degree of certainty. For example, what is probably the same serial appears in two different lists under slightly different titles, as for instance one says "reports," another "transactions," and without the serial at hand the committee can not determine whether these are the same or distinct series. We have tried to eliminate duplication by careful comparison with other catalogued lists. But after the utmost care there still remains a large residue of doubtful matter of this sort, while in some instances we may have identified series that should have been kept distinct. A number of titles have not been found in any of the serial catalogues which we have consulted and the doubt remains

in the minds of your committee whether some of these are not incorrectly listed.

It was intended that all volumes should be listed by the volume number when that could be determined and the date of issue given only when the volume number was not known. There has been great lack of uniformity in following this rule, which introduces considerable confusion into the lists. Your committee has no means at hand by which to correlate dates and volumes. Where it has seemed possible we have ventured to substitute volume numbers for dates, but in most cases we have found it necessary to leave the lists unchanged in this particular.

It may be found that some titles are included in the catalogue that have doubtful claim to being recognized as pertaining to serials that are either scientific or technical. As the committee could not be personally acquainted with every serial named we have trusted largely to the judgment of the librarians. A few titles, such as the *Literary Digest*, we have ventured to exclude. The inclusion of such doubtful material, however, does not seem to us a serious fault, on the principle quoted by Bolton from Zuehold that "in a bibliography it is much better that a book should be found which is not sought, than that one should be sought for and not found."

In the prosecution of this work the committee has consulted various catalogues and freely adopted suggestion from many of them. The following may be especially mentioned:

A catalogue of scientific and technical periodicals 1665-1895. Smithsonian miscellaneous collections 40.

List of serials in the University of Illinois library together with those in other libraries in Urbana and Champaign. University of Illinois Bulletin 9².

List of serials in the principal libraries of Philadelphia and its vicinity. Bulletin of the Free Library of Philadelphia. No. 8.

List of periodicals, newspapers, transactions and other serial publications currently received in the principal libraries of Boston and vicinity.

List of biological serials in the libraries of Baltimore 1901.

List of serials in University of Colorado library. University of Colorado bulletin. 13¹.

ABBREVIATIONS AND SIGNS.

- Ac. Indiana academy of science exchanges deposited in the State Library at Indianapolis. In references under this head parts of broken volumes are listed by means of index figures attached to the volume number.
- B. Butler College library, Indianapolis.
- D. DePauw University libraries, Greencastle.
- E. Earlham College library, Richmond.
- Exp. Agricultural Experiment Station, Lafayette.
- F. Franklin College library, Franklin.
- Ft. W. Fort Wayne public library.
- G. Gary public library.
- I. U. Indiana University libraries, Bloomington.
- L. P. Laporte public library.
- M. Muncie public library.
- N. D. Notre Dame University libraries, Notre Dame.
- N. H. New Harmony Workingmen's Library.
- P. Purdue University libraries, Lafayette.
- R. P. Rose Polytechnic libraries, Terre Haute.
- S. State Library, Indianapolis.
- S. N. State Normal School library, Terre Haute.
- T. H. Terre Haute, Fairbanks Memorial Library.
- W. Wabash College library, Crawfordsville.

Bold faced figures are used to indicate volume numbers. The year date (e. g. '93) is used instead of volume number when the latter is not known.

Plain Arabic figures indicate numbers of a serial that is not issued in volumes; chiefly bulletins.

Indices are used in the Academy (Ac.) lists to indicate numbers of an incomplete volume.

An asterisk (*) attached to a volume number signifies incomplete.

The plus sign (+) after the last volume number signifies that all succeeding numbers are on file and current numbers are received.

The parallels sign (||) indicates that the serial ceased publication with the preceding volume.

Roman numerals indicate numbered series.

o. s. old series.

n. s. new series.

HOWARD J. BANKER.

WILL SCOTT.

LIST OF SCIENTIFIC AND TECHNICAL SERIALS IN THE
LIBRARIES OF INDIANA.

Abstracts of physical papers. London, England. P. 3.

Continued as **Science** abstracts *q. v.*

Academia de ciencias medicas fisicas y naturales de la Habana. Havana, Cuba.

Anales. Ac. 36^{1-18-21, 24}; N. D. 39+.

Academia nacional de ciencias. Cordova, Argentine Republic.

Actas. Ac. 5¹⁻³.

Boletin. Ac. 7^{1-3, 4}, 8¹⁻³, 9, 10, 11¹⁻⁴, 12²⁻⁴, 13¹, 14^{1, 2}, 15¹⁻³, 16^{1, 4}.

Académie des sciences. Paris, France.

Comptes rendus. B. 152, 153: I. U. 1+: P. 140+: R. P. 104+.

Académie impériale des sciences. St. Petersburg, Russia.

Annual report. N. D. '12.

Bulletins. Ac. IV. 36^{1, 2}, V. 1-5, 6¹⁻⁵, 7^{1, 2}, 10⁵, 11-14, 15¹⁻⁵, 16¹⁻³, 22-25:
N. D. VI. '12+.

Musée botanique.—Travaux. N. D. '12.

Academy of natural sciences of Philadelphia, Pa.

Annual Reports. S. L. '91-'94.

Proceedings. Ac. '58+: B. '56-'86, '88-'93, '95+: I. U. 1+: N. D. 61+:
S. L. '67-'90, '99-'04.

Acadian scientist. Wolfville, Nova Scotia. Ac. 1⁵.

Accademia dei Lincei. Rome, Italy. See **Accademia** pontificia dei nuovi Lincei; **Reale** accademia dei Lincei.

Accademia pontificia dei nuovi Lincei. Rome, Italy.

Atti. Ac. 51-57, 58²⁻⁷, 59+.

See also **Reale** accademia dei Lincei.

Acetylene journal. Chicago, Ill. N. D. 7*, 8*, 9-11, 12*.

Acta mathematica. Stockholm, Sweden. I. U. 1+.

Aeronautics. New York. Ft. W. 12+.

Agassiz association. See **Wilson** bulletin.

Agassiz companion. Wyandotte, Kan. Ac. 1^{2, 3}, 2², 3⁶.

Agricultural advertising. Chicago, Ill. Exp. 19*, 20, 21, 22*.

Agricultural gazette. London, England. Exp. n. s. 11-14: P. 67+.

Agricultural gazette of New South Wales. Sidney, Australia. Exp. 1-7, 8*, 9*, 10*, 11, 12*, 13-20, 21*, 22+: N. D. 22+: P. 16*, 17+.

Agricultural journal. Tokyo, Japan. Exp. 46-57, 59+.

- Agricultural** journal of India. Calcutta. Exp. 1-5*, 6, 7*, 8+: P. 2, 3.
- Agricultural** journal of the Union of South Africa. Pretoria. Exp. 1*, 2-4: N. D. 1+: P. 1*, 2, 5*, 6*.
- Agricultural** news. Barbadoes, West Indies. N. D. 12+.
- Agricultural** science. State College, Pa. Exp. 1-8||: P. 1-5.
- Continued as
- Agricultural** science journal. State College, Pa. Exp. 2*, 3.
- Aircraft**. New York. Ft. W. 4+.
- Alabama**. Agricultural experiment station. Auburn.
Annual report. Exp. 1+: P. 2, 4, 6, 9, 11+.
Bulletin. D. 80, 90: Exp. 1-154, 156, 158+: P. 1-47, 49+: S. L. 149-151, 153, 154, 156-159.
- Alabama**. Agricultural experiment station. Uniontown.
Annual report. Exp. 1-3, 11+: P. 2, 3, 12.
Bulletin. Exp. 1+: P. 1+.
- Alabama**. Agricultural experiment station. Tuskegee.
Bulletin. Exp. 1, 3-16, 18+: P. 1, 3-12, 15+.
Farmers' leaflets. Exp. 6, 8-16: P. 7, 8, 10-16.
Teachers' leaflets. Exp. 2.
- Alabama**. Agricultural experiment station. Wetumpka.
Annual report. Exp. 4-6.
- Alabama**. Agriculture, Department of. Auburn.
Bulletin. Exp. '06-'08, '11+.
Report of commissioner. Exp. '92.
- Alabama**. Geological survey. D. '81-'82.
- Alabama**. State veterinarian. Auburn.
Report. Exp. 2-4: P. 1-4.
- Alaska**. Agricultural experiment station. Sitka.
Annual report. D. '06+: Exp. '00, '03+: P. '98+: R. P. '06, '07: S. L. '06+.
Bulletin. D. 2, 3: Exp. 1+: P. 1+: R. P. 1-3: S. N. '02.
- Alavoura**. Brazil. Exp. II. 4*, 5*, 6*, 10*-13*.
- Albany** (N. Y.), institute.
Transactions. S. L. 4.
- Alberta**. Agriculture, Department of.
Annual report. S. L. '08-'10.
- Alkaloidal** clinic. Chicago, Ill. N. D. 10*, 11*, 12*+.

Continued as **American** journal of clinical medicine *q. v.*

- Amateur sportsman.** New York. Exp. 45*, 46*.
- American academy of arts and sciences.** Boston.
Memoirs. P. 13*: R. P. n. s. 1-9; S. L. 1-4.
Proceedings. Ac. 34+: P. 40*, 41*: R. P. 1-7, 9-16; S. N. 34-37.
- American academy of medicine.** Easton, Pa.
Bulletin. I. U. 6+.
- American agricultural association.**
Journal. Exp. 1*.
- American agriculturist.** New York. Exp. 38-40; M. 34-49; S. L. 59, 60, 62, 64-94.
- American amateur photographer.** New York. N. D. 19*, 20*.
Combined with **Photo beacon** *q. r.*
- American analyst.** New York. Exp. 5.
- American annual of photography and photographic times almanac.** New York. N. D. 93-96.
- American anthropological association.** New York.
Memoirs. S. L. 1, 2*.
- American anthropologist.** Washington, D. C.; New York. I. U. 1-11||; n. s. 1+; S. L. 1-11||; n. s. 1+.
- American antiquarian and oriental journal.** Cleveland Ohio; Chicago, Ill.
Ac. 3^d, 6^d, 11^d, 14^d; S. L. 16-18; W. 1-6.
- American antiquarian society.** Worcester, Mass.
Proceedings. R. P. n. s. 1, 3*.
Transactions. S. N. 12.
- American apple growers congress.** Columbia, Mo.
Transactions. Exp. 1-5.
- American architect and building news.** Boston, Mass.; New York. Ft. W. 99, 101+; G. 103+; M. 9-12; N. D. 93*, 94*, 95*, 96*, 97+; R. P. 21+.
- American association for the advancement of science.** Washington, D. C.
Proceedings. E. 20-25, 39, 40, 42, 43, 52, 54-62; I. U. 2, 4, 6, 15-39, 44-50, 58+; N. H. 2-6, 20-37, 39-48; P. 29+; R. P. 1-41, 43-45, 59-61; S. L. 1-62; S. N. 1-44; W. 36-57.
- American association of geologists and naturalists.** See **Association of American geologists**, etc.
- American association of nurserymen.**
Annual report. Exp. '05-'11.
- American bee journal.** Philadelphia, Pa.; Washington, D. C.; Chicago, Ill.
Exp. 1-10, 24-29.

- American blacksmith.** Buffalo, N. Y. Ft. W. 12+.
- American botanist.** Binghamton, N. Y.; Joliet, Ill. D. 1-17: N. D. 15+.
- American breeders' association.**
 Proceedings. Exp. 3, 4: P. 1, 2, 4, 6+.
- American builder and journal of art.** Chicago, Ill. M. '72.
- American carpenter and builder.** Chicago, Ill. Ft. W. 7+: G. 7+.
- American ceramic society.** Columbus, Ohio.
 Transactions. P. 1+.
- American chemical journal.** Baltimore, Md. B. 8+: D. 1+: E. 39+: I. U. 8+: N. D. 17-42, 49+: P. 1+: R. P. 17+: W. 1+.
- American chemical society.** New York; Easton, Pa.
 Chemical abstracts. D. 1+: Exp. 2+: G. 7+: I. U. 1+: N. D. 1, 2, 6*, 7+: P. 1+: W. 1+.
 Journal. D. 15+: Exp. 17*, 18*, 20*, 21*, 22*, 23*, 26*, 29+: Ft. W. 35+: G. 32+: I. U. 28+: N. D. 1, 2, 6-16, 18, 21-24, 25*, 26-30, 31*-33*, 34+: P. 1+: R. P. 15+: S. L. 21, 23+: W. 15, 16, 24+.
 Proceedings. I. U. 31, 32, 34, 36+.
 Review of American chemical research. N. D. 11, 12||: P. 9-12||.
 Continued as **Chemical abstracts** *q. v.*
- American chemist.** New York. R. P. 1-7: W. 1-4.
- American city.** New York. Ft. W. 2+: G. 1+: I. U. 6+: M. 2+: N. D. 2+: P. 1+: S. N. 1+: T. H. 1+.
- American conchology.** New Harmony, Ind. N. H. 1*.
- American cranberry association.**
 Proceedings. Exp. '06-'11.
- American druggist and pharmaceutical record.** New York. N. D. 41*-43*, 44, 45, 46, 47-53, 54*-59*+: P. 14+.
 Continues **New remedies** *q. v.*
- American electrician.** New York. Ft. W. 14-17||: M. 9-14, 16, 17||: P. 8-11, 12*, 13-17||: R. P. 11-17||.
 Continued in **Electrical world** *q. v.*
- American electro-chemical society.** Philadelphia, Pa.
 Transactions. P. 1+: R. P. 3.
- American engineer.** Chicago, Ill. R. P. 9-21.
- American engineer and railroad journal.** New York. Ft. W. 81-86: N. D. 68, 69*, 79*, 80*: P. 67+: R. P. 71+.
 Continues **Railroad** and engineering journal *q. v.*; **National car and locomotive builder**; **American railroad journal** *q. v.*; **Van Nostrand's engineering magazine** *q. v.*

- American entomological society.** Philadelphia, Pa.
Transactions. S. L. 8-34, 38*.
- American entomologist.** St. Louis, Mo.; New York. N. H. 1-3||.
Volume 2 is known as **American entomologist and botanist.**
- American ephemeris and nautical almanac.** See **United States.** Nautical almanac office.
- American ethnology.** See **United States.** Ethnology, Bureau of American.
- American farmer.** Baltimore, Md. S. L. 1-15.
- American farmer.** Indianapolis, Ind. Exp. 24*.
- American farmer's magazine.** New York. S. L. 11-12.
- American fern journal.** Auburndale, Boston, Mass. N. D. 1+.
- American fertilizer.** Philadelphia, Pa. Exp. 1*, 2*, 3-4, 5*, 12, 13*, 14-17, 18*, 19*, 20-29, 30*, 31*, 32-38*.
- American florist.** Chicago, Ill. Exp. 39+.
- American florists and ornamental horticulturists.** New York.
Report. Exp. 5-6, 9-11, 13-18, 20-28.
- American forestry.** Washington, D. C.
D. 16-18: Exp. 16, 17*: Ft. W. 17+: N. H. 16+: P. 16+: S. L. 13+.
Formerly **Conservation** *q. v.*
- American forestry association.** Washington, D. C.
Proceedings. P. 1-8: S. L. '82, '91, '92, '93.
- American forestry congress.** Washington, D. C.
Proceedings. Exp. '92: P. 4.
- American fruit and nut journal.** Petersburg, Va. Exp. 4*, 5, 6*.
- American fruits.** Rochester, N. Y. Exp. 1, 2*, 3-5, 6*, 7*, 9-11, 12*.
- American garden.** New York. P. 1-10.
Continued as **American gardening.**
- American gas institute.**
Proceedings. P. 1+: R. P. 2+.
- American geographical society.** New York.
Bulletin. Ac. 34¹⁻⁵, 35¹⁻⁵, 36-40¹⁻¹², 41¹: I. U. 34+: S. N. 34+.
Journal. Ac. 14⁶, 15⁷, 16⁵, 17^{1, 2, 4, 5}, 18²⁻⁵, 19¹⁻³, 20¹⁻⁴, 21¹⁻⁴, 22^{1, 3, 4}, 23¹⁻³, 26², 30³⁻⁵, 31¹⁻⁵, 32¹⁻⁵, 33¹⁻⁵: I. U. 1-33||: S. N. 28-33||.
Continued as the Bulletin *q. v.*
- American geologist.** Minneapolis, Minn. B. 10-23: E. 29-36||: I. U. 1-36||: N. D. 5*, 7¹, 8, 9, 10*, 11*, 12-14, 17-32, 33*, 34-36||: N. H. 1*, 2*, 3*, 4*, 5*: S. N. 12-36||: W. 11-26.
Continued by **Economic geology** *q. v.*

- American** hay, flour and feed journal. New York. Exp. 3*, 7*, 8, 9*, 11-13, 20+.
- American** health. New Haven, Conn. P. 1*, 2*.
- American** Herford journal. Kansas City, Mo. Exp. 1*, 2+.
- American** homes and gardens. New York. G. 7+: L. P. 1+: M. 1+: R. P. 1+: S. N. 1+: T. H. 4+.
- Continues **Scientific American**: Building edition *q. v.*
- American** horticultural society. Greencastle; Indianapolis, Ind.
Transactions. Exp. 1-5: S. L. 3, 4, 6.
- American** horticulturist. I. U. '85-'86.
- American** institute of architects. Washington, D. C.
Proceedings. P. 23-28, 34+.
Quarterly bulletin. P. 10+.
- American** institute of electrical engineers. New York.
Proceedings. Ft. W. 31+: R. P. 24+.
Transactions. P. 1-4, 6+: R. P. 10-21, 28+.
- American** institute of mining engineers. New York.
Transactions. R. P. 1+.
- American** institute of the city of New York.
Transactions. P. 6.
- American** inventor. Washington, D. C. N. D. 15*, 16*.
Absorbed **Popular science news** *q. v.*
- American** journal of anatomy. Baltimore, Md. F. 2: I. U. 3+: P. 5+: S. N. 1+.
- American** journal of archaeology. Princeton, N. J.; New York; and Norwood, Mass. D. 1-11; II. 1+: E. II. 1-12, 16+: I. U. 1-11; II. 1+: N. D. 1, 2: S. N. II. 1+: W. 8-11; II. 1+.
- American** journal of clinical medicine. Chicago, Ill. N. D. 13*-19*.
Continues **Alkaloidal clinic** *q. v.*
- American** journal of conchology. Philadelphia, Pa. P. 1-7||.
- American** journal of diseases of children. Chicago, Ill. I. U. 1+.
- American** journal of forestry. Cincinnati, O. Ac. 1¹.
- American** journal of mathematics. Baltimore, Md. D. 1-16: B. 25+: F. 1, 2: I. U. 1+: P. 1+: W. 15+.
- American** journal of medical sciences. Philadelphia, Pa. M. 1-23, 25-119, 131+: N. D. n. s. 57-64: N. H. 4-6; n s. 28-164: T. H. 2-5, 9, 19, 20, 23, 25, 27, 33, 38, 40, 46, 49, 88, 91, 92-108, 115-120, 122-129, 137+.
- American** journal of microscopy and popular science. New York. Ac. 3⁶⁻¹², 4¹, 6¹: D. 1, 2: R. P. 1-5.

- American journal of pharmacy.** Philadelphia, Pa. P. 54, 55, 58+: R. P. III. 1-18; IV. 1, 2.
- American journal of physiology.** Boston, Mass. D. 15-20: F. 29+: I. U. 1+: P. 13+: S. N. 1+: W. 5-7.
- American journal of psychology.** Baltimore, Md.; Worcester, Mass. E. 2-6, 12, 14, 16, 17: F. 2, 3, 19+: I. U. 1+: P. 19+: S. N. 1+: W. 10-18.
- American journal of public health.** New York. See **American public health association.** Journal.
- American journal of public hygiene.** Boston, Mass.; Columbus, O. Exp. n. s. 1*, 2*, 3-6: P. n. s. 1-6.
Continues as **American public health association.** Journal. *q. c.*
- American journal of religious psychology.** Worcester, Mass. I. U. 1+: S. N. 1+.
Volumes 1-4 called **Journal of religious psychology and education.**
- American journal of science.** New Haven, Conn. B. III. 11-16, 19-50; IV. 1-23, 25-33: D. 10, 11: E. IV. 27+: Exp. 37*, 38*: I. U. 1-10, 12, 14-50; II. 1-50; III. 1-50; IV. 1-5, 7+: N. D. 8*, 9*, 11*, 12*, 49, 50*: N. H. I. 45, 47, 49, 50; II. 1-8, 17-20; III. 1-12: P. 1+: R. P. 1+: S. N. 100+: W. 1-150, n. s. 1-28.
Called **American journal of science and arts** until 1879. Also known as **Silliman's journal.**
- American journal of the medical sciences.** Philadelphia, Pa.; New York. D. o. s. 38-41; n. s. 29-36, 129-133, 135-152: I. U. 133-138, 140+.
- American machinist.** New York. Ft. W. 30+: G. 32+: L. P. 36*+: M. 10+: N. D. 22+: P. 5-8, 10-14, 16+: R. P. 6+.
- American mathematical monthly.** Kidder; Springfield, Mo. I. U. 1+: N. D. 4, 6, 7, 12+: P. 1-8, 12+: S. N. 4+: W. 5+.
- American mathematical society.** New York.
Bulletin. D. II. 1-6: I. U. 1+: P. II. 1+: S. N. 1, 3+: W. 8+.
Transactions. I. U. 1+: P. 1+.
- American medical association.** Chicago, Ill.; Philadelphia, Pa.
Journal. Exp. 54*, 55+: I. U. 41+: M. 1-54, 57+: N. H. 1-4: P. 1-3, 9-22, 36, 38, 40+*: T. H. 1+.
Transactions. N. H. 10, 24, 32.
- American microscopical society.** Washington, D. C.; Decatur, Iowa.
Transactions. D. 30+.
- American midland naturalist.** Notre Dame, Ind. E. 1: Exp. 1+: N. D. 1+: P. 1, 2*+.
- American miller.** Chicago, Ill. Exp. 39+.

- American** monthly magazine and critical review. New York. M. 18, 20+:
N. D. 1-3.
- American** monthly microscopical journal. Washington, D. C. Ac. 1-4¹⁻¹²,
5¹, 9⁴, 10⁶, 19¹. 3-12, 20-21¹⁻¹², 22¹⁻⁵, 7-10, 12, 23¹⁻⁶: D. 1, 10-15, 18-23*,
N. D. 8*-10*, 11-18, 21: P. 2: R. P. 1-2: W. 1-5, 13-15.
- American** museum journal. New York. N. D. 9+.
- American** museum of natural history. New York.
Annual report. Ac. '70-'89: N. D. 40+: S. L. '90-'92.
Bulletin. Ac. 1¹⁻³: P. 8: S. L. 2-11, 13-18.
Memoirs. I. U. 1: S. L. 1*, 2*, 3*, 4*.
- American** national live stock association. See **National** live stock association.
- American** naturalist. Salem, Mass.; Philadelphia, Pa.; Boston, Mass. B.
1-6, 11-24, 26+: D. 1-5, 20+: E. 1-4, 7, 40+: F. 1-4, 11-13: I. U.
10-13, 16+: M. 1: N. D. 2, 6, 23, 24*, 25, 26*, 27, 28: N. H. 1-3: P.
1-8, 10*, 11+: S. L. 1+: S. N. 1-22, 24+: W. 1+.
- American** pharmaceutical association. Chicago, Ill.
Bulletin. N. D. 2-6: P. 5+.
Journal. N. D. 1*.
Proceedings. I. U. '02-'05: N. D. 55: P. 6, 10, 14, 15, 32+: S. L. 1-40,
42+.
- American** philosophical society. Philadelphia, Pa.
Proceedings. Ac. 27-38, 47, 48, 51-156, 157+: Exp. 30+: I. U. 5-36, 38:
R. P. 16-23, 27, 28: S. L. 27-38, 47, 48, 51-156.
Transactions. N. D. n. s. 34: N. H. n. s. 1.
- American** photography. Boston, Mass. Ft. W. 1+.
- American** physical education review. Boston, Mass. G. 17+: I. U. 1+: S. N.
1+.
- American** polytechnic journal. Washington, D. C. N. H. 1, 2, 4.
- American** pomological society. Boston, Mass.
Proceedings. Exp. 15, 16, 18-20, 22-32: P. 15, 16, 18-20, 22+.
Bulletin. Exp. 1, 3.
- American** poultry advocate. Syracuse, N. Y. Exp. 17*, 18*, 19+.
- American** poultry association.
Proceedings. P. 29-33, 37.
- American** public health association. New York.
Journal. Exp. n. s. 1+: F. n. s. 1: P. n. s. 1+: S. L. n. s. 2+.
Formerly **American** journal of public hygiene *q. v.*
Papers and reports. S. L. 1-2, 4-36.

- American** quarterly microscopical journal. New York. R. P. 1-3.
- American** railroad journal. New York. N. H. 1-6: S. L. 1-6.
Continued in **American** engineer and railroad journal *q. v.*
- American** railway bridge and building association.
Proceedings. P. 18+.
- American** railway engineering and maintenance of way association. Chicago, Ill.
Bulletin. P. '02*+.
Proceedings. P. 1+.
- American** railway master mechanics' association. New York.
Annual report. Ft. W. 2-17.
Proceedings. P. 1-5, 8-17, 20+.
- American** road builders' congress.
Reports. P. 1.
- American** sheep-breeder and wool-grower. Chicago, Ill. Exp. 30*, 31+:
P. 25+.
- American** society for psychical research. Boston, Mass.
Journal. S. N. 1, 2, 4+.
Proceedings. I. U. 1*: S. N. 1+.
- American** society for testing materials.
Proceedings. P. 1+: R. P. 2-8.
- American** society of agricultural engineers.
Transactions. P. 1+: R. P. 1+.
- American** society of agronomy.
Proceedings. P. 1+.
- American** society of civil engineers. New York.
Proceedings. Ft. W. 33+: P. 3-6, 12-17, 22.
Transactions. G. 66+: P. 6-67: R. P. 43, 44, 60+: S. L. 2, 29, 30, 49, 52, 54.
- American** society of heating and ventilating engineers. New York.
Transactions. P. 1+.
- American** society of mechanical engineers. New York.
Journal. G. 34+: N. D. 32-34.
Transactions. G. 31+: N. D. 17, 18: P. 1+: R. P. 1+.
- American** society of municipal improvements. Cincinnati, O.
Proceedings. P. 14.
- American** stock journal. New York. S. L. 1, 2.
- American** street railway association. Brooklyn, N. Y.
Report. P. 4-24.

- American** sugar industry and beet sugar gazette. Chicago, Ill. Exp. 6*, 7, 8, 9*, 10-12, 13*, 14+.
- American** swineherd. Chicago, Ill. Exp. 26, 27, 28*, 29+.
- American** telephone journal. New York. P. 5*, 6-18||.
Continued in **Telephony** *q. v.*
- American** veterinary medical association. St. Paul, Minn.
Proceedings. Exp. '90-'93, '96+.
- American** veterinary review. New York. Exp. 12, 14+.
- American** water works association. New York.
Proceedings. P. 18+.
- American** wool and cotton reporter. Boston, Mass. Exp. 25*, 26+.
- Analyst** (Chem.). London, England. Exp. 13*, 14, 15*, 16-21, 22*: I. U. 1-10: P. 8+.
- Analyst** (Math.). Des Moines, Ia. I. U. 1-10||: P. 1-10||.
Continued as **Annals** of mathematics *q. v.*
- Anatomical** record. Philadelphia, Pa. I. U. 1+: P. 1+: S. N. 1+.
- Anatomischer** Anzeiger. Jena, Germany. B. 13-33, 35*, 36*, 37*, 38*, 39*, 40*: I. U. 1-38, 40+.
- Ancona** world. Franklinville, N. Y. Exp. 1*-4*.
- Annalen** der Chemie und Pharmacie (Liebig). Heidelberg; Leipzig, Germany.
D. 1+: Exp. 1-236, 241-300: P. 293, 295, 297, 299, 301-316, 321+: W. 285-350.
Supplement. D.1-8: Exp. 1-8.
- Annalen** der Physik und Chemie. Halle; Leipzig, Germany. I. U. n. s. 48-72;
IV. 1+: N. D. '09+: P. III. 1+: S. L. 37+: W. 16+.
Beiblatter. I. U. 17+: N. D. '09, '10: P. 31+.
- Annales** de chimie et de physique. Paris, France. B. 7-9: I. U. VI. 28, 30;
VII. 2-30; VIII. 1+: N. D. VII. 16-19, 20-30; VIII. 1-4, 5*-7*.
- Annales** de géographie. Paris, France. I. U. 7+: S. N. 8+.
- Annales** de la science agronomique française et étrangère. Paris, France.
Exp. o. s. '89, '90; II. '03-'05.
- Annales** de paléontologie. Paris, France. I. U. 1+.
- Annales** des ponts et chaussées. Paris, France. R. P. VI. 15+.
- Annales** des sciences naturelles: botanique. Paris, France. Exp. VII. 7, 8:
I. U. VII. 7, 9-20; VIII. 1-22; IX. 1+: W. VII. 19, 20; VIII. 2-14.
- Annales** des sciences naturelles: zoologie et paléontologie. Paris, France.
I. U. 7, 8.
- Annales** historico-naturales musei nationalis hungarici. Budapest, Hungary.
Ac. 1+.

- Annales mycologici.** Berlin, Germany. Exp. 1-2, 9+.
- Annales scientifiques de l'école normale supérieure.** Paris, France. I. U. I. 1-7; II. 1-12; III. 1+.
- Annali della regia scuola superiore di agricoltura in Portici.** Naples, Italy. Exp. II. 2-4, 9.
- Annali di botanica.** Rome, Italy. N. D. 10+.
- Annali di mathematica pura et applicata.** Rome; Milan, Italy. I. U. III. 17+.
- Annals and magazine of natural history.** London, England. I. U. VII. 6, 9, 10, 17.
- Annals of botany.** London, England. D. 1-7, 14, 17+; I. U. 1+; P. 1+; S. N. 1+; W. 7.
- Annals of hygiene.** Philadelphia, Pa. M. S.
- Annals of mathematics.** Charlottesville, Va.; Cambridge, Mass. D. 1-6; I. U. o. s. 1-12; n. s. 1+; P. II. 1+; R. P. 1+; W. 1-12, n. s. 1+.
Continues *Analyst* (math.) *q. v.*
- Annals of nature and Annual synopsis of new genera and species of animals, plants, etc.** Lexington, Ky. N. D. I].
- Annals of science.** Cleveland, O. R. P. 1, 2.
- Année biologique.** Paris, France. I. U. 1+.
- Année psychologique.** Paris, France. I. U. 1+.
- Année scientifique.** Paris, France. N. D. 1-9.
- Année sociologique.** Paris, France. I. U. 1+.
- Annual of scientific discovery.** Boston, Mass. D. '50-'62, '65, '68-'71; I. U. 1-6, 10, 16-19, 21; N. H. '50-'54, '56, '57, '60, '64, '66-'69, '71; R. P. '50-'70; W. '51-'70.
- Annual record of science and industry.** New York. D. '71-'73; N. H. '71, '72; W. '71-'76.
- Annual register.** London, England. N. H. 1-153.
- Annual report on the progress of chemistry.** B. 5-7; P. 1+; W. 1-8.
- Anthropological institute of New York.**
Journal. S. L. 1, 2.
- Anthropos.** Vienna, Austria. I. U. 6+.
- Aquila.** Budapest, Hungary. N. D. '12+.
- Arbeiten aus der kaiserlichen Gesundheitsamte.** Berlin, Germany. I. U. 24-37, 39.
- Arboriculture.** Chicago, Ill.; Indianapolis; Connersville, Ind. Exp. 1*, 2, 3, 4*, 5*, 6, 7*, 8]; L. P. 2*; P. 1-8]].

- Architects' and builders' magazine.** New York. Ft. W. o. s. 42: G. o. s. 44+: N. D. 3*, 38*-43*.
Continues as: **Architecture** and building.
- Architectural record.** New York. Ft. W. 13+: G. 25+: M. 1+: N. D. 19*-21*, 25*-32*: P. 23+: R. P. 31+: S. N. 1+.
- Architectural review.** Boston, Mass. G. n. s. 1+: N. D. 11*-17*, 18+.
- Architectural review and American builders journal.** Philadelphia, Pa. N. H. 1.
- Archiv der Mathematik und Physik.** Leipsig, Germany. I. U. 1-70; II. 1-17; III. 1+: P. 9+.
- Archiv der Pharmacie.** Berlin, Germany. I. U. 236, 238+.
- Archiv für Anatomie und Physiologie.** Leipzig, Germany. I. U. 1+.
- Archiv für die gesammte Physiologie des Menschen und der Thiere.** Bonn, Germany. D. 27, 28: I. U. 1+: P. 106+.
- Archiv für die gesammte Psychologie.** Leipzig, Germany. I. U. 1+.
- Archiv für Entwicklungsmechanik der Organismen.** Leipzig, Germany. I. U. 1+.
- Archiv für mikroskopische Anatomie und Entwicklungsgeschichte.** Bonn, Germany. I. U. 1+.
- Archiv für pathologische Anatomie und Physiologie und für klinische Medicin.** Berlin, Germany. I. U. 1+.
- Archiv für Rassen und Gesellschaft-Biologie.** Berlin, Germany. I. U. 1+.
- Archiv für Sozialwissenschaft und Sozialpolitik.** Tübingen, Germany. I. U. 32+.
- Archiv für Zellforschung.** Leipzig, Germany. I. U. 5+.
- Archives de Biologie.** Ghent, Belgium; Paris, France. I. U. 11, 12, 18, 21*.
- Archives de medicine experimentale.** Paris, France. I. U. 18+.
- Archives de parasitologie.** Paris, France. I. U. 10-11, 13+.
- Archives de zoologie experimentale et generale.** Paris, France. I. U. II. 9, 10.
- Archives of comparative medicine and surgery.** New York. Exp. 1.
- Archives of internal medicine.** M. 3-5.
- Archives of neurology and psychiatry.** London, England. I. U. 1+.
- Archives of philosophy, psychology and scientific methods.** New York. I. U. 1.
- Archives of psychology.** New York. I. U. 1+.
- Archives of scientific and practical medicine.** Philadelphia, Pa. D. 1*||.
- Arizona.** Agricultural experiment station. Tucson.
Annual report. Exp. 1, 2, 6+: P. 1, 2, 6+: S. L. '09.
Bulletin. D. 34: Exp. 1+: P. 1-39, 41+: S. L. '10+.

- Arizona.** Horticultural commission.
Annual report. P. 1+.
- Arkansas.** Agricultural experiment station. Fayetteville.
Annual report. Exp. 1+: P. 2, 3, 17, 20+.
Bulletin. Exp. 1+: P. 1+.
- Arkansas.** Geological survey. Little Rock.
Annual report. I. U. '57-'60, '88-'92: N. H. '88: P. 88-92*: R. P. '88-'90:
S. N. '92, '09.
Report of a geological reconnaissance of the northern counties. N. H.
1, 2.
- Arkansas (State) horticultural society.** Little Rock.
Annual report. Exp. 24, 29+.
- Arkiv för botanik.** Stockholm, Sweden. N. D. 8+.
- Arkiv för zoologi.** Stockholm, Sweden. N. D. 5+.
- Art amateur.** New York. M. 7-11, 24, 25: N. D. 15, 16*, 17-21, 24-30, 35-38:
P. 3-30: R. P. 17-45: S. N. 36-48.
- Art interchange.** New York. M. 18-23, 39-51.
- Art journal.** London, England. P. 4-6.
- Asiatic society of Bengal.** Calcutta, India.
Proceedings. Ae. '85^{1-4, 6-10}, '86^{1-4, 6, 8-10}, '87¹⁻¹⁰, '88-'91, '92¹⁻⁹, '93^{2-6, 8-10}, '94¹⁻¹⁰, '95, '96, '97^{1-4, 9-11}, '98¹⁻¹¹, '99, '00¹⁻⁴.
- Asiatic society of Japan.** Tokio.
Transactions. R. P. 7*, 8*.
- Association française pour l'avancement des sciences.** Paris, France. N.
D. '87.
- Association géodésique internationale.**
Comptes rendus des séances de l'association.
R. P. '93+.
- Association of American agricultural colleges and experiment stations.**
Proceedings. Exp. '10+: P. 2+.
- Association of American geologists and naturalists.**
Reports. S. L. 1-3.
- Association of American medical colleges.**
Proceedings. I. U. 8, 18+.
- Association of American Portland cement manufacturers.** Philadelphia, Pa.
Bulletin. Exp. 10, 18-23, 25+.
- Association of engineering societies.** Boston, Mass.
Journal. P. 1+: R. P. 1+.

- Associazione** elettrotecnica italiana. Milan, Italy.
Atti. P. 1-7.
- Astronomical** journal. Boston, Mass.; Albany, N. Y. D. 7+: I. U. 2+: W. 13-21.
- Astronomical** society of the Pacific. San Francisco, Cal.
Publications. I. U. 1+.
- Astronomie.** Paris, France. I. U. 1-4.
- Astronomische** Nachrichten. Kiel, Germany. D. 113-138; I. U. 55-58, 107, 111, 118, 121-122, 124+.
- Astronomy** and astro-physics. Northfield, Minn. D. 11-13||: I. U. 11-13||: W. 11-13||.
Continues **Siderial messenger** *q. v.* Continued as **Astrophysical journal** *q. v.*
- Astrophysical** journal. Chicago, Ill. D. 1+: B. 2-6, 11+: I. U. 1+: N. D. 1*, 2, 3*, 24*, 26*: P. 7, 19-27, 29+: W. 1-6, 17+.
Continues **Astronomy** and astrophysics *q. v.*
- Atlantic** deeper waterways association.
Proceedings. P. 1-3, 5+.
- Atlantic** journal and friend of knowledge. Philadelphia, Pa. N. D. 1.
- Augustana** college. Rock Island, Ill.
Library publications. P. 4-6.
- Auk.** Cambridge, Mass.; New York. Ac. 26+: E. 22, 25, 26, 28, 29.
- Australian** association for the advancement of science. Sidney, Australia.
Report. Ac. 7-12.
- Automobile.** New York. P. 12+.
- Automobile** trade journal. Philadelphia, Pa., P. 9+.
- Ayrshire** breeders' association.
Report. Exp. '11.
Yearbook. Exp. '11, '13.
- Bacteriological** world and modern medicine. Battle Creek, Mich. N. D. 1*.
- Baltimore** (Md.). See **Johns** Hopkins hospital; **Johns** Hopkins university.
- Barrels** and bottles. Indianapolis, Ind. Exp. 10, 11*, 12+.
- Baumaterialienkunde.** Stuttgart, Germany. P. 3*, 4, 5, 10-12||.
- Bayerische** Academie der Wissenschaften. See **Königlich** bayerische, etc.
- Beet** sugar gazette. Chicago, Ill. Exp. 1*, 2-3*, 4*.
- Beiträge** zur Biologie der Pflanzen. Breslau, Germany. Exp. 1-4.
- Beiträge** zur kenntniss der Baumkrankheiten. Berlin, Germany. Exp. '88.
- Beiträge** zur Mykologie. Frankfort, Germany. Exp. '50-'63.

- Beiträge zur Psychologie und Philosophie.** Leipzig, Germany. I. U. 1+.
- Belfast natural history and philosophical society.** Belfast, Ireland.
Report. Ac. '85-'88, '96-'01, '04-'06, '08-'10: N. D. '11.
- Berliner astronomisches Jahrbuch.** Berlin, Germany. I. U. '34-'36, '73, '03, '04.
- Berliner klinische Wochenschrift.** Berlin, Germany. I. U. 43+.
- Better farming.** Chicago, Ill. Exp. 32, 33*, 34+.
- Better fruit.** Hood River, Ore. Exp. 1+: P. 2+.
- Bibliographia physiologica.** Vienna, Austria. I. U. III. 1+: P. 1+.
- Bibliographia zoologica.** Leipzig, Germany. I. U. 1-17, 19+.
- Bibliographic géographique annuelle.** I. U. 7+.
- Biltmore (N. C.) botanical studies.** N. D. 1+.
- Biochemical bulletin.** New York. P. 1+.
- Biochemisches Centralblatt.** Berlin; Leipzig, Germany. I. U. 4+.
- Biological bulletin.** Woods' Hole, Mass. D. 1+: F. 18-20: I. U. 1+: P. 14+: S. N. 1+: W. 4+.
Continues **Zoological bulletin** *q. r.*
- Biological society of Washington, (D. C.).**
Proceedings. Ac. 1-23*: I. U. 1.
- Biologisches Centralblatt.** Leipzig, Germany. D. 1-30; I. U. 1+.
- Biologisches Gesellschaft.** Christiana, Norway.
Mitteilungen. N. D. 18*.
- Biometrika.** Cambridge, England. Exp. 8+: I. U. 1+.
- Bird lore.** Harrisburg, Pa.; New York. E. 1+: Exp. 1, 2: F. 12+: G. 1-3, 4-6, 8, 12+: M. 12+: T. H. 9+: W. 3+.
- Birds and nature.** Chicago, Ill. I. U. 1-14: L. P. 1+: N. H. 1-16: S. N. 1-21.
- Blätter für aquarien und terrarien kunde.** Magdeburg, Germany. N. D. 24.
- Bollettino della arboricoltura italiana.** Exp. 5*, 6, 7: N. D. 5+.
- Boston (Mass.).** See **American academy of arts and sciences.**
- Boston (Mass.) cooking school magazine.** G. 15*, 16+: P. 18+.
- Boston (Mass.) journal of natural history.** R. P. 1-6: S. L. 2-6.
- Boston (Mass.). Metropolitan water and sewerage board.**
Annual report. P. 1-9, 11+.
- Boston mycological club.** Cambridge, Mass.
Bulletin. N. D. 3-21.
- Boston society of natural history.** Boston, Mass.
Memoirs. Ac. 5: I. U. 4*: R. P. '62-'69.
Proceedings. Ac. 31⁶, 34: I. U. 26-33: R. P. '34-'57.

Boston (Mass.). Transit commission.

Annual report. R. P. 5, 8, 10+.

Boston (Mass.). Water board.

Annual report. P. 16, 17, 19.

Botanical gazette. Crawfordsville; Bloomington, Ind.; Chicago, Ill. Ac. 14¹⁻¹⁰; B. 26-50; D. 12+; E. 13-30, 33+; F. 10-13, 27-32, 53+; I. U. 13+; M. 49-52; N. D. 9*-11*, 12-18, 24*-26*, 27, 28*, 30, 31*, 32, 34*, 42*, 46*, 49*, 55+; P. 1+; S. L. 4-13, 15+; S. N. 1, 2, 4, 6, 8+; W. 1+.

Botanical journal. London, England. Ac. 2³⁻⁵, 3+.

Botanical magazine. London, England. See Curtis's botanical magazine.

Botanical magazine. Tokyo, Japan. Exp. 24, 25; N. D. 12, 13, 15, 18, 27.

Botanical society of Edinburgh, Scotland.

Transactions. Ac. 22¹⁻³, 23¹⁻³, 24¹⁻³, 25+.

Botanische veveening. Nijmegen, Holland. N. D. '13+.

Botanische Zeitung. Berlin; Leipzig, Germany. Exp. 34, 35, 44, 46, 48-65, 67, 68; I. U. 1-16, 19+; W. 51-59.

Botanischer Jahresbericht (Just's). Berlin, Germany. D. 1-32; Exp. 1-9, 14-17; W. 1-20.

Botanischer Verein der Provinz Brandenburg. Berlin, Germany.

Verhandlungen. Ac. 36+.

Botanisches Centralblatt. Jena, Germany. D. 1+; Exp. 1-88; I. U. 1+; W. 49-60, 89+.

Beihefte. D. 1+; Exp. 1-9, 21-28; I. U. 6-7, 9+.

Botanisches Institut. Würzburg, Germany.

Arbeiten. Exp. 1, 2.

Botanisches Staats-Institut. Hamburg, Germany.

Mitteilungen. N. D. 23+.

Botaniska notiser. Lund, Sweden. N. D. '09+.

Brain. London, England. I. U. 12-14, 17+; S. N. 13, 15+.

Braithwaite's retrospect of practical medicine and surgery. New York. D. 1, 3-47, 85-87; N. H. '84*, 106.

Brazil. See Museu Goeldi.

Breeder's gazette. Chicago, Ill. D. 55; Exp. 27*, 42*, 43, 44*, 45, 46, 49*, 50*, 51*, 52*, 53, 54, 55*, 56*, 57+; N. H. 58+; P. 1+; S. L. 1-52.

Brickbuilder. Boston, Mass. G. 18+; N. D. 13*, 14*, 17*, 18*, 19+; R. P. 9+.

Bristol (England) naturalists' society.

Proceedings. Ac. 1²⁻³, 2¹⁻³, 3¹.

- British** and foreign medico-chirurgical review. London, England.
Report. N. H. 1-56.
- British** annual and epitome of the progress of science. London, England.
N. H. '38.
- British** association for the advancement of science. London, England.
Report. N. H. 54-56: R. P. '31+: S. L. 1-59.
- British** astronomical association. London, England.
Journal. I. U. 1+.
Memoirs. I. U. 11, 14, 16-17.
- British Columbia**. Agriculture, Department of. Victoria.
Annual report. Exp. '95, '96, '02+: P. '94.
Bulletin. Exp. 11-15, 17, 18, 26, 27, 30, 32, 37-40, 44+: P. 26, 30, 37-40,
42, 44, 45, 47, 49+.
- British Columbia** dairymen's association. Victoria.
Report. Exp. '06: P. '12.
- British Columbia** farmers' institutes. Victoria.
Annual report. Exp. '00-'03, '05, '09, '11: P. '12.
- British Columbia** fruit-grower's association. Victoria.
Report. Exp. '10: P. '10, '12.
- British Columbia**. Mines, Department of.
Annual report. S. L. '96-'98, 1900-'04.
- British Columbia** poultry association. Victoria.
Report. Exp. '10.
- British Columbia** stock breeders' association.
Annual report. P. '09.
- British** journal of psychology. Cambridge, England. P. 2+.
- British** journal of tuberculosis. London, England. S. L. 2+.
- British** medical journal. London, England. I. U. '06+: T. H. '09+.
- British** patents, Abridgements of. R. P. 1558+.
- Brooklyn** (N. Y.) institute of arts and sciences. Museum.
Science bulletin. N. D. 1+.
- Broteria**. Revista de ciencias naturaes do collegio de San Fiel. Lisbon,
Portugal. N. D. 1+.
- Brown** university. Providence, R. I. Biological laboratory. Studies. I. U.
1+.
- Brussels** (Belgium). L'agriculture, Administration de.
Bulletin. Exp. o. s. 18*-23*; n. s. 1*-3*.

- Brussels** (Belgium) jardin botanique de l'état.
 Bulletin. N. D. 3+.
 Conspectus florae africae. N. D. 1, 5.
- Brussels** (Belgium). Observatoire royal de Belgique.
 Annales physique. Ac. 3¹.
 Annales astronomique. Ac. 9¹, 11¹; I. U. 1*, 13*; S. L. 6.
- Bryn Mawr** (Pa.) college.
 Monographs. Ac. 1²⁻⁴, 5-7, 9; N. D. reprint ser. 9+.
- Bryologist**. Brooklyn, N. Y. N. D. 13+.
- Budapest** (Hungary). See **Magyar** botanikai Lapok; **Magyar** Kiralyi termesztudományi társulat; **Magyar** madártani központ folyóirata; **Magyar** nemzeti múzeum.
- Buenos Aires** (Argentine Republic). See **Museo** de la Plata; **Museo** nacional; **Sociedad** científica Argentina.
- Buenos Aires** (Argentine Republic) universidad.
 Anales. P. 1-3, 6-15.
- Buffalo** society of natural sciences. Buffalo, N. Y.
 Bulletin. Ac. 1-4, 5^{1, 2, 5}, 6, 9³; Exp. 5*, 6*; P. 1, 2.
- Builder** and woodworker. New York. N. H. 18.
- Building** age. New York. Ft. W. 32+; G. 32+.
 Continues **Carpentry** and building *q. v.*
- Building** management. Chicago, Ill. G. 10+.
- Building** progress. N. D. 1*-3*, 4+.
- Buitenzorg** (Java). Jardin botanique.
 Annales. (Botanical and zoological parts). I. U. II. 1+.
- Bulletin** astronomique de l'observatoire de Paris (France). I. U. 14-28; W. 15-17.
 Continues astronomical section of **Bulletin** des sciences mathématiques et astronomiques *q. v.*
- Bulletin** des sciences mathématiques et astronomique. Paris, France. I. U. 1-11; II. 1+.
 Since 1884 the astronomical portion has been published as a separate serial. See **Bulletin** astronomique.
- Bulletin** of American paleontology. Ithaca, N. Y. I. U. 1, 4.
- Bulletin** of pharmacy. Detroit, Mich. N. D. 16*-20*, 23, 24*, 25, 26*, 21*;
 P. 14+.
- Butchers'** and packers' gazette. St. Louis, Mo. Exp. 103*, 104*, 105+.
- Butter**, cheese and egg journal. Milwaukee, Wis. Exp. 2*, 3+.

California academy of sciences. San Francisco, Cal.

Bulletin. Ac. 1⁴, 2⁵⁻⁸.

Occasional papers. Ac. 1-9: I. U. 1, 5.

Proceedings. Ac. II. 1^{1, 2}, 2, 3^{1, 2}, 4^{1, 2}, 5^{1, 2}, 6; III. bot. 1¹⁻¹⁰, 2¹⁻¹¹; geol.

1¹⁻¹⁰, 2^{1, 2}; math. and phys. 1¹⁻⁸; zool. 1¹⁻¹², 2¹⁻¹¹, 3¹⁻¹³, 4¹⁻³; IV. 1, 3:

I. U. II. 5, 6; III. bot. 1+, geol. 1+, zool. 1+: N. D. IV. 1+.

California agricultural experiment station. Berkeley.

Annual report. D. '97-'98; Exp. '88-'04; P. '88-'04.

Bulletin. D. 107, 160, 165, 170, 171; Exp. 3-49, 51-61, 63+: P. 83+.

Reports of the viticultural work. D. '87-'93; Exp. '83-'95; P. '83-'95.

California agricultural experiment station. South Pasadena.

Bulletin. Exp. 2-3, 5-10, 13.

California (state) agricultural society.

Transactions. P. '00, '01, '05-'08, '10-'12. S. L. '58+.

California association of nurserymen.

Transactions. P. 1+.

California conservation commission. Sacramento.

Report. N. D. '12+.

California cultivator. Los Angeles. Exp. 34*, 35*, 36*, 37+.

California dairy association. San Francisco.

Proceedings. Exp. '98.

California. Forestry, State board of.

Biennial report. P. 3.

Bulletin. P. 1.

California fruit growers' convention.

Proceedings. P. 18, 19, 28, 29, 35+.

California. Geological survey.

Report. E. 1, 2.

California. Health, State board of.

Biennial report. P. '84-'96, '98-'10.

Monthly bulletin. P. 5-7.

California. Horticulture, State board of. Sacramento.

Annual report. Exp. '89-'92.

Biennial report. Exp. '85-'86, '93-'98, '01-'02; P. '93-'94.

Bulletin. Exp. 57, 58, 63-67.

Transactions. Exp. '93.

California. Horticulture, State commissioner of.

Biennial report. Exp. '03-'06, '11+: P. '05-'08, '11, '12.

Monthly bulletin. Exp. 1+.

- California** (State) medical society.
Transactions. N. H. '72.
- California** railroad commission. Sacramento.
Report. N. D. '12+.
- California** registration board.
Report. Exp. '12.
- California** (state) university chronicle. Berkeley. P. 11+.
- California** (state) university. Geology, Department of, Berkeley.
Bulletin. Ac. 1⁸⁻¹¹, 14; Exp. 14; I. U. 1+.
- California** (state) university. Lick observatory. Mt. Hamilton.
Bulletin. I. U. 1-4.
Publications. I. U. 1-3, 5, 8; N. D. 1-3.
- California** (state) university. Physiology, department of, Berkeley. Ac.
3¹⁴⁻¹⁷, 4^{1-13, 16, 17}; I. U. 1+.
- California** (state) university. Publications. Berkeley.
Agricultural sciences. Exp. 1*.
Botany. N. D. 1, 2*, 3*, 4*, 5+.
- California**. Ventura county horticultural commissioner. Santa Paula.
Bulletin. Exp. 1, 2.
- California** (state) water commission. Sacramento.
Report. N. D. '12+.
- Camera**. Philadelphia, Pa. G. 17+.
- Canada**. See also **Alberta**; **Manitoba**; **Nova Scotia**, **Ontario**; **Prince Edward Island**; **Quebec**; **Saskatchewan**; **Western Canada**.
- Canada**. Agriculture, Department of. Ottawa.
Bulletins of the central experimental farms. Exp. 1-7, 9-22, 24-29, 31-34, 36-66, 68+; II. 5, 7, 9, 10, 12+; P. 3-6, 11, 12, 14, 16-29, 31-34, 36-66, 68+.
Reports. Exp. '89-'07, '09+; P. '86, '88+.
- Canada**. Agriculture, Minister of. Toronto.
Annual report. Exp. 1, 2.
- Canada**. Conservation, Commission of. Ottawa.
Report. Exp. '10, '12+; P. 1+; S. L. '10+.
- Canada**. Dairy and cold storage commissioner's branch. Ottawa.
Annual report. Exp. '06, '07, '09-11; P. '06, '10, '11.
Bulletin. Exp. o. s. 4, n. s. 2, 3, 6, 12, 13, 15, 18, 20, 24, 25, 38; P. n. s. 7, 12, 18, 23, 25, 28, 30.
- Canada**. Entomologist, Dominion. Ottawa.
Reports. Exp. '10+.

- Canada.** Forestry and irrigation, Superintendent of.
Report. P. '09-'10.
- Canada.** Game commissioners. Toronto.
Report. Exp. '06.
- Canada.** Geological survey.
Annual report. I. U. n. s. 2, 5-16; N. D. '04-'11; P. n. s. 1+; R. P. '47-'58;
I. N. 1-7, 9; S. L. '63-'08.
Catalogue of Canadian plants. S. N. 7.
Contributions to paleontology. N. D. 3+; S. L. 1*, 2*, 3*, 4*.
Memoirs. N. D. 1-17, 21, 24, 27, 28, 33, 35+; S. L. 1+.
Report of progress. P. 20-27.
- Canada.** Geological and natural history survey.
Summary reports. P. '85-'87, '89, '91, '05, '06.
- Canada** good roads association. Toronto.
Report. Exp. '94.
- Canada** horticultural societies of Ontario. Toronto.
Report. Exp. '06+; P. '06+.
- Canada.** Horticulturist, Dominion. Ottawa.
Report. Exp. '10.
- Canada.** Inland revenue department, Laboratory of. Ottawa.
Bulletin. Exp. 54-60, 65-71, 82, 83, 85, 95, 97-100, 108, 109, 112, 113, 153,
159, 175, 182, 222.
Report. Exp. '09.
- Canada.** Interior, Department of.
Report of the chief astronomer. I. U. '05, '09.
- Canada.** Interior, Department of. Forestry branch. Ottawa.
Bulletin. Exp. 2-9, 13, 14, 16-31, 33+; P. 1+.
Report. Exp. '96*-'09*, 11*, 12+.
- Canada.** International commission on the control of bovine tuberculosis.
Ottawa.
Annual report. Exp. '10.
- Canada.** Live stock commissioner. Ottawa.
Bulletin. Exp. 7-9, 11+.
- Canada.** Meteorological service.
Annual report. R. P. '88-'90, '95-'05.
- Canada.** Mines, Department of.
Bulletin. S. L. '09+.
Report. S. L. '06-'11.

- Canada.** Patent office.
Record. R. P. 24+.
- Canada** poultry institutes. Guelph.
Report. Exp. 1-4.
- Canada** provincial instructor in road making. Toronto.
Annual report. Exp. '96-'08.
Bulletin. Exp. 1, 2.
- Canada.** Veterinary director-general and live stock commissioner. Ottawa.
Report. Exp. '07, '08, '10, '11.
- Canada** woman's institute. Toronto.
Report. Exp. '06, '07, '08*, '09, '10, '11*, '12+.
- Canada** year books. Exp. '05-'09.
- Canadian** department of mines. Ottawa.
Memoirs of geological survey. N. D. 1-17, 21, 24, 27, 28, 33, 35+.
- Canadian** entomologist. Toronto; London, Ontario. D. 24-30*: Exp. 21*:
P. 39+: S. N. 21-29.
- Canadian** forestry association.
Report. P. 11+.
- Canadian** institute. Toronto.
Annual report. Ac. '86-'91.
Proceedings. Ac. III. 3²⁻⁴, 4^{1, 2}, 5^{1, 2}, 6^{1, 2}, 7¹; n. s. 1¹⁻⁶, 2¹⁻⁶.
Transactions. Ac. 1^{1, 2}, 2^{1, 2}, 4², 5^{1, 2}, 6^{1, 2}, 7¹⁻³, 8¹⁻⁴, 9¹.
- Canadian** record of science. Montreal, Can. Ac. 1^{3, 4}, 2^{1-3, 5, 6}; I. U. 7-8.
- Canadian** science monthly. Kentville, N. S. Ac. 3^{6, 8-11}.
- Canadian** seed growers' association. Ottawa.
Report. Exp. '04+: P. '04+.
- Canal** record. (Isthmian canal.) Ancon, Canal Zone. P. 1+.
- Cape of Good Hope.** Entomologist report, Government. Cape Town.
Annual report. Exp. '95-'98.
- Cape of Good Hope** agricultural journal. P. 27-29, 37+.
- Cape of Good Hope.** Royal observatory.
Report. S. L. '09+.
- Carnegie** institution of Washington (D. C.).
Publications. D. 15: I. U. 1-19, 21-54, 56-62, 64-79, 81-85, 87-149, 152-158, 160-162, 166, 167, 171, 174, 176+: N. D. 1+: P. 4+: S. N. 12, 18, 19, 23, 30, 36, 37, 47, 49, 50, 51, 58, 64, 67, 70, 82, 94, 95, 98, 99, 112, 114, 117.
Year-book. P. 1+.

- Carnegie** institution. Marine biological laboratory. Tortugas, Fla.
Papers. S. N. 1, 2.
- Carnegie** institute. Pittsburg, Pa.
Annals. Ac. '01+: I. U. 1+: N. D. 1*, 3*, 4*, 5*.
Annual report. Ac. '98+: I. U. 1+: P. 1+: W. 1+.
Celebration of founder's day. Ac. '98-'00, '02-'05, '07+: I. U. 1+.
Memoirs. Ac. 1, 2, 3¹, 4¹⁻⁷: I. U. 1+.
Prize essay contest. Ac. '99-'04: I. U. 1+.
- Carpentry** and building. New York. Ft. W. 31||.
Continued by **Building** age *q. v.*
- Carlson's** breeders' review. Norfolk, Neb. Exp. 1*, 2+.
- Cassier's** magazine. New York. F. 39+: Ft. W. 19, 21+: G. 35+: I. U. 28-30: L. P. 18-26: M. 41+: P. 4+: R. P. 5-33, 36+: S. N. 13+: T. H. 7+.
- Cattle** specialist. Waukesha, Wis. Exp. 2*, 3*⁶
- Cellule**. Lierre, Belgium. I. U. 22+: N. D. 1+.
- Cement** age. New York. N. D. 2*, 7*.
Continues as **Concrete-cement** age *q. v.*
- Cement** era. Chicago, Ill. N. D. 5*.
- Cement** world. Chicago, Ill. N. D. 1*, 2*, 3, 4, 5*, 6: R. P. 2+.
- Central Park** menagerie. New York.
Reports. Ac. '88-'90.
- Central** railway club. Buffalo, N. Y.
Proceedings. P. 2+.
- Central** states medical monitor. Indianapolis, Ind. P. 5-11*.
- Centralblatt** für allgemeine und experimentale Biologie. I. U. 1+.
- Centralblatt** für agrikultur Chemie (Biederman). Leipzig, Germany. Exp. 16*, 17-19, 20*.
- Centralblatt** für Bakteriologie. Parasitenkunde und Infektionskrankheiten. Jena, Germany. P. 36+.
Erste Abtheilung. Exp. 1-18: I. U. 1-30||.
After 33 issued in two series, Referate and Originale.
Referate. Exp. 46+: I. U. 31-56, 60, 62, 63, 65+: P. 36+.
Originale. Exp. 53+.
Zweite Abtheilung. Exp. 2+: I. U. 1-20, 22-29, 31+.
- Centralblatt** für Electrotechnik. Munich, Germany. R. P. 7-10.
- Centralblatt** für Mineralogie, Geologie und Palaeontologie. Stuttgart, Germany. I. U. 1-12.
A supplement to **Neues** Jahrbuch für Mineralogie *q. v.*

- Centralblatt** für normale Anatomie und Mikrotechnik. Berlin, Germany.
I. U. 1+.
- Centralblatt** für Physiologie. Berlin; Leipzig, Germany. P. 19+: W. 6.
- Charleston** (S. C.) museum.
Bulletin. N. D. 8+.
- Chemical** abstracts. See **American** chemical society.
- Chemical** engineer. Philadelphia, Pa.; Chicago, Ill. E. 11+: N. D. 1*,
4-6, 10*, 16*, 17+: P. 1+.
- Chemical** engineering and physical chemistry. B. 1+.
- Chemical** news. London, England. D. 1-61: N. D. 1-3, 80-95, 97, 98, 99*,
100*, 101*, 104*, 107+: P. 33+: R. P. 71+: S. N. 39-52, 61-63, 68+:
W. 1-6.
- Chemical** society of London, England.
Annual report. B. '10+: D. 1-6: Exp. 1+: P. 1+.
Journal. B. '06+: D. 24+: Exp. 1+: N. D. 16-96, 101+: R. P. 28+:
W. 59+.
- Chemiker-zeitung**. Cöthen, Germany. Exp. 27+: I. U. 1-19.
Beilage. Chemisch-technisches repertorium. Exp. 33, 34.
- Chemisches** Centralblatt. Hamburg; Berlin, Germany. Exp. 60, 61: I. U.
52+: N. D. 77+: P. 47+: R. P. '04+.
- Chemist** and druggist. London, England. P. 70+:
- Chicago** (Ill.) academy of sciences.
Annual report. Ac. '95-'97.
Special publications. Ac. 3.
Bulletin. Ac. 1¹⁻¹⁰, 2²⁻⁴, 3¹⁻⁵: N. D. 3.
- Chicago** (Ill.). Geological and natural history survey.
Bulletin. Ac. 1-6. 7: N. D. 1.
- Chicago** (Ill.) dairy produce. Exp. 13*, 17*, 18+.
- Chicago** (Ill.) entomological society.
Memoirs. Ac. 1¹.
- Chicago** (Ill.). Health, Department of.
Biennial report. Exp. '94-'96.
- Chicago** (Ill.) medical journal. D. 27, 28*.
- Chicago** (Ill.) university. Hull physiological laboratory. Physiological
archives. I. U. 1.
- Chile**, Universidad de. Santiago.
Anales. I. U. 103, 108-123, 125+: P. '82*+.
- China**. Agriculture and forestry, Department of.
Agricultural journal. Exp. 1*+.

Christiania, Norway. See **Videnskabs selskabet**.

Cincinnati (O.) lancet and observer. N. H. n. s. 1*, 2, 3*.

Continued as **Cincinnati** lancet-clinic *q. r.*

Cincinnati (O.) lancet-clinic. D. n. s. 2-4, 5*, 6-8, 9*, 10-12, 13*, 14-16, 17*, 18*, 24*, 27*: P. n. s. 16-24*.

Continues **Cincinnati** lancet and observer *q. r.*

Cincinnati (O.) medical and surgical news. D. n. s. 1*, 2*.

Cincinnati (O.) museum association.

Report. Exp. 19-28.

Cincinnati (O.) society of natural history.

Journal. Ac. 11, 12¹⁻³, 15^{3, 4}, 16²⁻⁴: I. U. 4+: S. L. 1-10.

Cincinnati (O.) observatory.

Annual report. I. U. '70.

Cincinnati (O.) quarterly journal of science. I. U. 1, 2.

Cincinnati (O.) university.

Record. N. D. I. 8+: II. 7+.

Studies. I. U. II. 3+: P. II. 1+.

Circolo mathematico. Palermo, Italy.

Rendiconti. I. U. 1+.

Civil engineers' and architects journal. London, England. R. P. 1-25.

Clark university. Worcester, Mass.

Nature study leaflet. P. 1, 2.

Clemson college. See **South Carolina**.

Cold. Calcium, N. Y. Exp. 1+.

Coleman's rural world. St. Louis, Mo. Exp. 63*, 64+.

College of physicians of Philadelphia (Pa.).

Proceedings. N. H. 1789.

Colorado. Agriculture, State board of. Denver.

Annual report. Exp. 2, 16, 26, 28, 30, 32+: N. D. 23: P. 2, 4, 12-18, 20, 22, 24, 26, 28.

Colorado. Agricultural experiment station. Fort Collins.

Annual report. Exp. 1+: N. D. 3, 14, 16, 22, 24, 33, 34: P. 1, 2, 4+.

Bulletin. D. 31, 35, 44, 64, 96-99, 101, 103-106: Exp. 1-179, 181+: N. D. 100, 150-152, 157, 158, 160-179, 180+: P. 1+: S. L. 34, 35, 43, 44, 49-53, 100, 117-119.

Colorado college. Colorado Springs.

Publication. I. U. 33-35, 39-53: N. D. science ser. 11+: social ser. 2+: P. sci. ser. 13-20, 23-26, 30-32, 39+: Eng. ser. 1+.

- Colorado** (state) engineer.
Biennial report. P. 14.
- Colorado** (state) entomologist.
Annual report. P. 3.
- Colorado** fruit grower. Grand Junction. Exp. 3-4*.
- Colorado**. Geological survey.
Bulletin. I. U. 1+.
Report. I. U. 1+.
- Colorado**. Horticulture, State board of. Denver
Annual report. Exp. 13, 14, 16: P. 2, 5, 7, 11-15, 18, 19, 21+.
- Colorado** school of mines. Golden.
Bulletin. P. 1-4*.
- Colorado** scientific society. Denver, Col.
Bulletin. Ac. '97^{10, 11}, '98¹, '99^{3, 4}, '00².
Proceedings. Ac. 1, 2¹⁻³, 3¹⁻³, 5-9: I. U. 2-5: P. 9.
- Colorado** university. Boulder, Col.
Studies. I. U. 1+: N. D. 7+: P. 1+.
Journal of engineering. P. 1+.
- Colorado** university. Psychology and education, Department of. Boulder, Col.
Investigations. I. U. 1.
- Columbia** university. New York.
Ernest Kempton Adams fund for physical research publications. P. 4, 6.
- Columbia** university. Botany, Department of. New York.
Contributions. N. D. 14.
Memoirs. N. D. 1, 2.
Bulletin. P. 1-20||.
Continued as
Quarterly. I. U. 1+: P. 1+: W. 1+.
- Columbus** (O.) horticultural society.
Report. Exp. '95, '99-'03: P. '87, '95-'00, '03-'09.
- Columbus** (O.) medical journal. D. 1-8*.
Continues **Ohio** medical journal. Columbus. *q. v.*
- Comité** géologique. St. Petersburg, Russia.
Bulletins. Ac. 17+.
Memoirs. Ac. 2², 7, 8²⁻⁴, 9³⁻⁵, 10³⁻⁴, 12³, 13²⁻⁴, 14, 15¹⁻⁴, 16^{1, 2}, 17^{1, 3}, 18¹⁻³,
19, 20^{1, 2}; n.s. 1-38, 40-61, 63-69, 71, 75, 78, 81+.
Supplement to bulletins. Ac. 14-17.

Comité regional del estado de Durango (Mexico).

Boletino. N. D. 1, 2, 3+.

Commercial fertilizer. Atlanta, Ga. Exp. 1*, 2+

Commercial poultry. Marseilles, Ill. Exp. 19*.

Compressed air. Easton, Pa. R. P. 5, 7, 9-14.

Concrete. Detroit, Mich. Ft. W. 8||: N. D. 4*-12*.

Continued as **Concrete-cement** age *q. v.*

Concrete-cement age. Detroit, Mich. Ft. W. 1+: G. 8+: N. D. 1*, 2*.

Continues **Concrete**, *q. v.*, and **Cement** age, *q. v.*

Concrete review. Philadelphia, Pa. N. D. 3*.

Congrès international des sciences géographiques. See **International** geographic congress.

Congrès scientifique international des catholiques. Fribourg, Switzerland.

Compte rendu. N. D. '89, '91, '98, '95.

Connecticut academy of arts and sciences. New Haven, Conn.

Memoirs. Ac. 2, 3.

Transactions. Ac. 8, 9², 10+: N. D. 14, 16+.

Connecticut. Agricultural experiment station. New Haven.

Annual report. D. 23*: Exp. '76, '79-'11, '12*: P. '79+.

Bulletin. Exp. 1, 17, 21, 23-30, 33-56, 58-67, 69, 71+: P. 60, 71, 73-77, 79-82, 84, 85, 87, 89+: S. L. '11+.

Connecticut. Agricultural experiment station (Storrs). Mansfield.

Annual report. Exp. 1+: P. '88+.

Bulletin. D. 4: Exp. 1+: P. 1+.

Connecticut (state) agricultural society.

Transactions. S. L. '54-'57.

Connecticut. Agriculture, Board of. Hartford.

Report. Exp. 43: P. 13, 14, 16+.

Connecticut. Dairy commissioner. Hartford.

Report. Exp. 7: P. 2, 3, 6-17.

Connecticut. Domestic animals, Commissioners on diseases of.

Report. P. 1, 5-7, 9+.

Connecticut (state) entomologist. Hartford.

Report. Exp. 1-8, 10.

Connecticut farmer and New England farms. New Haven. Exp. 41*, 42+.

Connecticut. Fisheries and game, commissioners.

Report. P. '09, '10.

Connecticut forestry association.

Bulletin. Exp. 4-6.

- Connecticut.** Geological and natural history survey. Hartford. Exp. 11:
I. U. 10-11, 13+: P. 1+.
- Connecticut.** Health, State board of. Hartford.
Report. Exp. '08: P. '83+.
- Connecticut.** Highway commissioner.
Biennial report. P. '97-'00, '05-'08.
- Connecticut** pomological society. Milford.
Report. Exp. '00.
- Connecticut.** Railroad commissioners.
Annual report. P. 55-59.
- Connecticut.** Shell-fish commissioners.
Report. P. '09, '10.
- Connecticut** society of civil engineers. New Haven.
Proceedings. P. 2, 6, 7, 9+.
- Conservation.** Exp. 8*, 9, 10*, 11, 12, 13*, 14*, 15*||: N. H. 14, 15||: P. 14, 15||.
Continues **Forestry** and irrigation *q. v.*; continued as **American** forestry *q. v.*
- Corn.** Waterloo, Ia. Exp. 1+.
- Corn** belt meat producers. Des Moines, Ia.
Annual report. Exp. '09, '10.
- Cornell** civil engineer. Ithaca, N. Y. P. 15.
Continues **Cornell** university—Association of civil engineers. Transactions. *q. v.*
- Cornell** countryman. Ithaca, N. Y. P. 1*, 2*, 3*, 4-6.
- Cornell** university. Association of civil engineers. Ithaca, N. Y.
Transactions. P. 1-14||.
Continues as **Cornel** civil engineer *q. v.*
- Cotton** seed. Atlanta, Ga. Exp. 7+.
- Country** calendar. New York. Exp. 1*||.
Merged in **Country** life in America *q. v.*
- Country** gentleman. Albany, N. Y. Exp. 3-53, 54*, 55*, 57*, 60*, 62*, 63*, 76*,
77*, 78+: G. 78+: S. L. 6-72.
- Country** life in America. Garden City, N. Y. Exp. 3-6, 7*, 9*, 11*, 13*, 14-18,
21+: Ft. W. 7-10, 12-19, 21+: G. 3+: P. 2+.
- Craftsman.** Syracuse, N. Y. Ft. W. 3-10, 12+: P. 1+.
- Creamery** journal. Waterloo, Ia. Exp. 19*, 20+: P. 17+.
- Criador** paulista. Sao Paulo, Brazil. Exp. 1*, 2*, 3*, 4, 5, 6*, 7+.
- Cuba.** Agricultura, industria y comercio, Secretaria de. Santiago de Las
Vegas.
Circulars. Exp. 7, 9, 11, 15, 18.

- Cuba.** Estacion central agronomica.
Annual report. Exp. '04, '05.
- Cuba.** Horticultural society. Camaguey.
Annual report. Exp. 1.
- Cultivator.** Albany, N. Y. N. H. 1-6, 11, 12: S. L. 1-5; n. s. 1-8.
Continued as **Cultivator** and country gentleman. See **Country gentleman**.
- Curtis's botanical magazine.** London, England. N. D. 1-13, 22, 23: n. s. 6.
- Dairy record.** St. Paul, Minn. Exp. 7*, 11*, 12+: P. 5*, 6, 7*, 8+.
- Dairymen's association of the province of Quebec.**
Annual report. Exp. '95, '96, '09, '10.
- Dakota farmer.** Aberdeen, S. D. Exp. 30*, 31*.
- Davenport (Ia.) academy of natural sciences.**
Proceedings. Ac. 3²⁻³, 5¹, 6, 7: N. D. 10.
- Decorator and furnisher.** New York. P. 1-16, 19, 20, 22-23, 24*-31*.
- Delaware.** See also **Peninsula horticultural society**.
- Delaware.** Agricultural experiment station. Newark.
Annual report. Exp. 1-19, 21+: P. 1+.
Bulletin. Exp. 1+: S. L. '10+: P. 1+.
Special bulletin. Exp. A, B.
- Delaware.** Agriculture, State board of. Dover.
Report of the secretary. Exp. 1-4: P. 1.
- Delaware (state) grange.** Dover.
Proceedings. Exp. '07-'10.
- Denison university.** Scientific laboratories. Granville, O.
Bulletin. Ac. 2-5, 6¹, 9², 10, 11¹⁻⁸, 13¹⁻⁶, 14¹⁻¹⁸, 15, 16¹⁻¹⁷, 17¹⁻⁴: I. U. 1, 10+.
- Denver (Colo.) municipal facts.** Exp. 1*, 2*.
- Deutscher amerikanischer Farmer.** Lincoln, Neb. Exp. 21*, 22*, 24+.
- Deutsche botanische Gesellschaft.** Berlin, Germany.
Berichte. Exp. 1-28, 30*+: I. U. 1+: W. 13-15.
- Deutsche chemische Gesellschaft.** Berlin, Germany.
Berichte. D. 7+: I. U. 1+: N. D. 29+: P. 1+: S. L. 46+: W. 1+.
- Deutsche dendrologische Gellschaft.** Poppelsdorf; Bonn, Germany.
Mitteilungen. N. D. '11+.
- Deutsche geologische Gesellschaft.** Berlin, Germany.
Zeitschrift. I. U. 56+.
- Deutsche Gesellschaft für Natur- und Völkerkunde Ostasiens.** Tokio, Japan.
Mitteilungen. Ac. 9³ supp. 2, 10¹⁻³, 11¹⁻⁴, 12¹, 2, 13¹⁻³, 14¹⁻².

- Deutsche Kunst und Dekoration.** Darmstadt, Germany. P. 17+.
- Deutsche Landwirtschaft-Gesellschaft.** Berlin, Germany.
 Jahrbuch. Exp. 25+.
 Mitteilungen. Exp. 27+.
- Deutsche Mechaniker-Zeitung.** Berlin, Germany. P. '08.
- Deutsche micrologische Gesellschaft.** See **Kleinwelt**.
- Deutsche tierärztliche Wochenschrift.** Hanover, Germany. Exp. 18+.
- Deutsche zoologische Gesellschaft.** Leipzig, Germany.
 Verhandlungen. I. U. 5.
- Dietetic gazette.** New York; Philadelphia, Pa. D. o. s. 3-6*.
- Digest of physical tests and laboratory practice.** Philadelphia, Pa. R. P.
 1, 2.
- Dingler's polytechnisches Journal.** Stuttgart; Berlin, Germany. P. 320+;
 R. P. 259-262, 267-319.
- District of Columbia.** Health, Board of.
 Annual report. Exp. '97-'04: P. '84+.
- Dixie miller.** Nashville, Tenn. Exp. 35*, 36+.
- Domestic engineering, plumbing, heating, ventilation, and mill supplies.** Chicago, Ill. P. 11*-13*, 33*, 34*.
- Dorpat, Russia.** See **Turjev, Russia**.
- Draftsman.** Cleveland, O. See **Industrial** magazine.
- Drainage journal.** Indianapolis, Ind. Exp. 10*, 11, 12*, 13*, 14*, 15*, 16*,
 17*, 18*, 19*, 20, 21*, 22, 23*, 24*.
- Druggist.** See **Meyer brothers druggist**.
- Druggist's circular and chemical gazette.** New York. N. D. 47*-56*: P. 19+.
- Dudley observatory.** Albany, N. Y.
 Annals. S. L. 1, 2.
- Dumfriesshire and Galloway natural history and antiquarian society.** Dumfries, Scotland.
 Transactions. N. D. 24+.
- Eastern farmer dairyman.** Oxford, Pa. Exp. 14*, 15, 16, 17*.
- Éclairage électrique.** Paris, France. P. 1-13, 42-53||.
 Continued as **Lumiere** électrique *q. v.*
- Eclectic medical journal.** Cincinnati, O. S. L. 19, 20.
- Eclectic medical journal of Pennsylvania.** Philadelphia, Pa. D. 9*, 12-18*.
- École polytechnique.**
 Journal. I. U. I. 1-64; II. 1+.
- Economic fungi.** Cambridge, Mass. Exp. 1-550.

- Economic geology.** Lancaster, Pa.; Urbana, Ill. E. 1+: I. U. 1+: N. D. 1+: S. N. 1+.
Continues **American** geologist *q. v.*
- Edinburgh** (Scotland). See **Botanical** society.
- Edinburgh** (Scotland) mathematical society.
Proceedings. I. U. 1+.
- Edinburgh** (Scotland). Royal botanical garden.
Notes. Ac. 22-27, 33.
- Edinburgh** (Scotland). Royal observatory.
Annual report. S. L. '09+.
- Edinburgh** (Scotland) veterinary review and annals of comparative pathology.
Exp. 1-3: P. 1-6.
- Egypt** exploration fund. London, England.
Archaeological report. I. U. '02-'09, '11, '12.
Report of meetings. I. U. 18, 19, 26, 27, 30+.
- Electric journal.** Pittsburg, Pa. Ft. W. 3: G. 10+: N. D. 1+: P. 1+: R. P. 2+.
- Electric railway journal.** New York. Ft. W. 32, 33, 35+: G. 33+: P. 32+.
Formed by consolidation of the **Electric** railway review (*q. v.*) and the **Street** railway journal (*q. v.*) continuing the volume numbers of the latter.
- Electric railway review.** Chicago, Ill. P. 17-19||.
Continues **Street** railway review (*q. v.*). Combined in 1908 with **Street** railway journal (*q. v.*) and became **Electric** railway journal (*q. v.*).
- Electric age.** New York. M. 13, 17-20: P. 35-39.
- Electrical engineer.** London, England. R. P. 1-32*.
- Electrical engineer.** New York. N. D. 12, 18, 22, 24: P. 7-26: R. P. 7-27||.
Continues **Electrician** and electrical engineer *q. v.* Combined in 1899 with the **Electrical** world *q. v.*
- Electrical review.** London, England. R. P. 26+.
- Electrical review.** New York; Chicago, Ill. G. 60+: M. 54+: P. 2, 4-13, 15, 16*, 17, 18, 20*, 21*, 35*, 36+: R. P. 31+.
After 52 called **Electrical** review and western electrician.
- Electrical world.** New York. D. 3-4, 19+: E. 16, 17: Ft. W. 39, 42+: G. 53+: I. U. 11+: M. monthly 18; weekly 49-55: N. D. '95+: P. 6+: R. P. 24+: S. N. 23+: T. H. 51-55.
Combined in 1889 with **Electrical** engineer (*q. v.*) and volumes 33-46 were called **Electrical** world and engineer.
- Electrician.** London, England. D. 28-37: I. U. 52+: P. 21*, 22*, 23*: R. P. 47+.

- Electrician** and electrical engineer. New York. P. 1-6||.
Continued as **Electrical** engineer *q. v.*
- Electrician** and mechanic. Boston, Mass. E. 25+: Ft. W. 18+: G. 26+.
- Electrochemical** and metallurgical industry. New York. See **Metallurgical** and chemical engineering.
- Electrochemical** industry. New York. See **Metallurgical** and chemical engineering.
- Elektrotechnische** Zeitschrift. Berlin, Germany. P. 26+: R. P. 6, 7, 12+.
- Elgin** (Ill.) dairy report. Exp. 18*, 19+.
- Elisha Mitchell** scientific society of the university of North Carolina. Chapel Hill, N. C.
Journal. Ac. 1-3, 4¹, 5+: N. D. 24+.
- Eporium** of arts and sciences. Philadelphia, Pa. R. P. n. s. 1.
- Engineer**. Chicago. P. 39*, 40*, 41*, 43-45||: R. P. 1-28, 41, 69, 70, 97+.
Merged with **Power** (*q. v.*) in 1908 and became **Power** and the engineer.
- Engineer** magazine. M. 40-45.
- Engineer**. See under **Pennsylvania** state college.
- Engineering**. London, England. Ft. W. 89+: N. D. 84+: P. 11+: R. P. 3-42, 47+.
- Engineering** and contracting. Chicago, Ill. G. 29*, 30*, 32*, 33*, 35+: P. 27*, 28+.
- Engineering** and mining journal. New York. N. D. 90+: I. U. 53+: P. 19-28, 34*, 41, 48*-54, 55, 58*-64*, 67+: R. P. 20-36, 49+.
- Engineering** association of the South. Nashville, Tenn.
Transactions. P. 10+.
- Engineering** digest. New York. Ft. W. 1, 3-5||: P. 1-5||.
Continued as **Industrial** engineering and engineering digest *q. v.* Vols. 1 and 2 have title **Technical** literature.
- Engineering** index. New York. N. D. 27+: P. 1-4.
- Engineering** index annual. New York. P. '06+.
- Engineering** magazine. New York. F. 27-32: Ft. W. 11, 12, 33+: G. 36+: I. U. 1+: L. P. 25+: M. 7+: N. D. 4, 15-17, 19, 21, 23, 24, 27, 33-43: N. H. 33-37: P. 1, 2*, 3+: R. P. 2+: S. L. 35+: S. N. 1+: T. H. 2+.
- Engineering** mechanics. Philadelphia, Pa. N. D. '94, '96, '97: P. 5*, 6, 8-9, 10*-11*, 12-16, 17*, 19-21: R. P. 1-11.
Volumes 5-13 have the title **Mechanics**.
- Engineering** news. Chicago, Ill.; New York. Ft. W. 62, 64+: G. 51+: N. D. 35+: P. 7-10, 15+: R. P. 13+: S. L. 53-55, 57-60, 67+: T. H. 65+.
Volumes 10-18 have title **Engineering** news and American contract journal. Volumes 19-48 have title **Engineering** news and American railway journal.

- Engineering** record, building record and sanitary engineer. New York. E. 51-60; Ft. W. 55+; G. 54+; N. D. 41+; P. 17+; R. P. 12+.
Continues **Sanitary engineer** *q. v.*
- Engineering** review. London, England. N. D. 21*.
- Engineering** world. Chicago, Ill. P. 1*-5*||.
Merged with **Engineering** and contracting *q. v.*
- Engineers'** society of western Pennsylvania. Pittsburgh.
Proceedings. I. U. 22+.
- England**, national sheep-breeders' association. London.
Annual report. Exp. '04-'06.
- English** mechanic and world of science. London, England. R. P. 45-77.
- Enseignement** mathématique. Paris, France. I. U. 11+; P. 5+.
- Entomologica** Americana. Brooklyn, N. Y. S. L. 1-6; S. N. 1.
- Entomological** news. Philadelphia, Pa. D. 1+; W. 9+.
- Entomological** society of America. Ithaca, N. Y.
Annals. P. 1+; S. L. 1+; W. 1+.
- Entomological** society of Ontario. Guelph; London, Ont.
Reports. S. N. '78, '81-'89, '91-'99, '00-'09.
- Entomologiska** föreningen. Stockholm, Sweden.
Entomologisk Tidskrift. Ac. 13¹⁻³, 18-25, 26¹⁻³, 28+.
- Entomologist**. London, England. Exp. 25-28, 29*, 30, 31*, 32-37, 38*, 39+.
- Entomologist's** monthly magazine. London, England. Exp. II. 2.
- Ephemeris** of materia medica, pharmacy, therapeutics and collateral information. Brooklyn, N. Y. P. 1-3.
- Ergebnisse** der Anatomie und Entwicklungsgeschichte. Wiesbaden, Germany. I. U. 1+.
- Ergebnisse** der Physiologie. Wiesbaden, Germany. I. U. 1+; P. 1-5; S. N. 1+.
- Ernährung** der Pflanze. Berlin, Germany. Exp. 8*, 9+.
- Erythea**. Berkeley, Cal. N. D. 1, 2.
- Españay** americana. Madrid, Spain. N. D. 7*, 8+.
- Essex** institute. Salem, Mass.
Bulletin. Ac. 19¹⁻³, 20⁴⁻¹², 21-23, 24¹⁻³, 7-12, 25, 26⁴⁻¹², 27¹⁻⁶, 28, 29, 30⁷⁻¹².
Report. Ac. '99, '00.
- Experiment** station record. See under **United States**. Experiment station, Office of.
- Experimental** studies in psychology and pedagogy. Boston, Mass. S. N. 2-4.

- Fancy** fruits. North Yakima, Wash. Exp. 1*, 2*.
- Farm** and orchard. Keyser, W. Va. Exp. 1+.
- Farm** and stock. St. Joseph, Mo. Exp. 7, 8, 9*, 10*, 11*.
- Farm** home. Springfield, Ill. Exp. 35*, 36+.
- Farm** journal. Philadelphia, Pa. Exp. 33+.
- Farm** life. Chicago, Ill. Exp. 12*, 13+.
- Farm** poultry. Boston, Mass. P. 4-19.
- Farm** press. See **Better** farming.
- Farm** progress. St. Louis, Mo. Exp. 8, 9*, 10+.
- Farm** sense. Des Moines, Ia. Exp. 1*, 2+.
- Farm** stock and home. Minneapolis, Minn. Exp. 25+.
- Farm** world. Augusta, Me.; Chicago, Ill. Exp. 3, 4*, 5*, 6+.
- Farmer** and breeder. Sioux City, Ia. Exp. 34+.
- Farmer's** advocate and home magazine. London, Ont. Exp. 44*, 45*, 46*, 47*, 48+.
- Farmer's** cabinet. Philadelphia, Pa. S. L. 1-37.
- Farmer's** digest. Columbia, Pa. Exp. 2*, 3, 4*, 5.
- Farmers'** guide. Huntington, Ind. Exp. 14*, 15*, 16*, 17*, 18*, 19*, 20, 21*, 22*, 23+: P. 18+.
- Farmer's** national congress of the United States.
Proceedings. P. 18, 20, 22+: S. L. '04-'10.
- Farmers'** review. Chicago, Ill. Exp. 39, 40*, 41*, 42+.
- Farmers'** tribune. Sioux City, Ia. Exp. 32*, 33.
- Farming**. New York. Exp. 1*, 2, 3*||: P. 1-3||.
Merged with **Garden** magazine *q. v.*
- Feather**. Washington, D. C. Exp. 14+.
- Federation** of Jewish farmers of America. New York.
Report. Exp. '09.
- Field** and farm. Denver, Colo. Exp. 24*, 25*, 26*, 27+.
- Field** and forest. Washington, D. C. Ac. 2²⁻⁸, 3^{1, 6-8}.
- Field** museum of natural history. Chicago, Ill.
Annual exchange catalogue. Ac. '96-'98.
Annual report. Ac. 1, 2³⁻⁵, 3, 4¹⁻²; W. 1+.
Publications; anthropological series. Ac. 2^{1, 3-6}, 3^{1, 4}, 4-6¹, 7¹; N. D. 1+: P. 1+: W. 1+.
Botanical series. Ac. 1^{1-3, 5}, 2^{1, 3-7}, 3²; N. D. 1+: P. 1+: W. 1+.
Geological series. Ac. 1^{1, 3-7}, 2^{2-4, 6-10}, 3¹⁻⁹, 4+: N. D. 1+: P. 1+: W. 1+.

Ornithological series. Ac. 1¹, 2², 6: P. 1+.

Report series. N. D. 1+: P. 1+: W. 1+.

Zoological series. Ac. 1²⁻⁸, 11-17, 2², 3¹²⁻¹⁶, 4¹, 2, 5-7¹⁻¹³, 8-10¹⁻³, 5-8, 11:
N. D. 1+: P. 1+: W. 1+.

Fire and water engineering. New York. N. D. 29*, 30-33, 35-38, 39*, 40*.

Fireproof magazine. New York. P. 1*, 2*, 3*, 4*, 7*, 8-11||.

Flora. Dresden, Germany. N. D. '11, '12.

Flora oder allgemeine botanische Zeitung. Regensburg; Marburg, Germany.
D. 74-80: I. U. 86+.

Flora of California. Exp. 1+.

Flora of Wyoming.

Report. Exp. '96.

Florida. Agricultural experiment station. Gainesville, Lake City.

Annual report. Exp. '88+: P. '88-'91, '93, '95, '96, '98, '00-'03, '05+.

Bulletin. D. 17, 33, 70-74, 77, 78, 80: Exp. 1+: P. 1+: S. L. 1-6, 9, 10,
12-19, 21-26, 29, 31, 33.

Farmers' institute bulletin. D. 2.

Florida. Agriculture, State board of. Tallahassee.

Biennial report. Exp. '91-'96, '99-'02, '05-'08: P. '95, '96, '11, '12.

Quarterly bulletin. Exp. 11*, 12*, 13*, 14*, 15, 16, 17*, 18, 19*, 20, 23+:
P. 21, 22*, 23+.

Florida (state) horticultural society. Jacksonville.

Annual report. Exp. 5, 7.

Flour and feed. Milwaukee, Wis. Exp. 2, 3*, 4*, 5*, 6-9, 10*, 11*, 12+.

Flour trade news, hay, grain and feed. New York. Exp. 4*, 5, 6*, 7-10.

Flying and aero club of America.

Bulletin. G. 1+.

Folia haematologica. Berlin, Germany. I. U. 3+.

Folia neuro-biologica. Leipzig, Germany. I. U. 1+.

Folia serologica. Leipzig, Germany. I. U. 1+.

Forest, fish and game. See **Georgia forest association.**

Forest and stream. New York. N. H. 1-17.

Forester. Washington, D. C. P. 4-7|.

Continued as **Forestry and irrigation** *q. v.*

Forestry and irrigation. Washington, D. C. Exp. 8*, 9, 10*, 11, 12, 13*,
14*||: P. 8-13.

Continued as **Conservation** *q. v.*

Forest quarterly. Ithaca, N. Y. P. 9+: W. 3+.

Forschungen auf dem Gebiete der Agrikulturphysik. Heidelberg, Germany.
Exp. 13.

Fortschrift der Physik. Berlin, Germany. P. 4+.

Fort Wayne (Ind.) medical journal. P. 2, 22, 27, 28*.

Foundry. Cleveland, O. Ft. W. 41+: G. 34+: P. 26+.

France. Agriculture et du commerce, Ministère de l'.
Bulletin. S. L. '40-'45.

France. Agriculture, Ministère de l'. Paris.

Bulletin. Exp. '88*, '89, '90, '91*, '92*, '93*, '94*, '95*, '96, '97*, '98*,
'99*, '00.

Franklin institute of Pennsylvania. Philadelphia.

Journal. N. H. 18*, 27-32: P. 1+: R. P. 5-47, 49-51, 86-97, 115+: S. L.
1-82, 119-128, 130+.

Fruit belt. Grand Rapids, Mich. Exp. 7*.

Fruit grower. St. Joseph, Mo. Exp. 15*, 16*, 17-19, 20*, 21+.

Fruitman and gardener. Mt. Vernon, Ia. Exp. 10*, 11*, 12*, 13+.

Fühlings landwirtschaftliche Zeitung. Stuttgart, Germany. Exp. 60+.

Furrow. Moline, Ill. Exp. 14*, 16+.

Garden and forest. New York. P. 1-10||.

Garden magazine. Garden City, N. Y.; New York. Exp. 1*, 2, 5*, 6*, 7*,
8-12, 13*, 14*, 15+: P. 1+.

Gardeners' chronicle. London, England. Exp. '41-'73; n. s. 1-26; III. 1+.
First series has no volume numbers.

Gardener's monthly. Philadelphia, Pa. Exp. 17-20, 22, 23.

Garten flora; Zeitschrift für Garten- und Blumenkunde. Berlin, Germany.
Exp. 37.

Gas engine. Cincinnati, O. P. 1+: R. P. 4*+.

Gas power. St. Joseph, Mich. G. 8+: P. 1-6.

General electric review. Schenectady, N. Y. G. 15+: P. 10+: R. P. 14+.

Génie civil. Paris, France. P. 46+.

Geographical teacher. London, England. S. N. 1+.

Geographical journal. See **Royal** geographical society.

Geographical society of America. See **American** geographical society.

Geographical society of Philadelphia, Pa.

Bulletin. S. N. 2+.

Geographische Zeitschrift. Leipzig, Germany. I. U. 5+.

Geological magazine. London, England. I. U. n. s. dec. 3, 4; dec. 4, 1-3,
5-11; dec. 5, 1+.

- Geological** society of America. Rochester, N. Y.; New York.
 Bulletin. E. 13+: I. U. 1+: N. H. 20: S. N. 1+.
- Geological** society of London (England). I. U. 29, 30, 37, 39, 60+.
- Geologisches** Centralblatt. Leipzig, Germany. I. U. 1+.
- Georgia.** Agricultural experiment station. Experiment.
 Annual report. Exp. 1+: P. 1+.
 Bulletin. D. 68-72: Exp. 1+: P. 1+: S. L. 45, 50, 61, 63-65, 67, 69, 70-73.
- Georgia.** Agriculture, State board of. Atlanta.
 Annual report of the commissioner. Exp. '76, '81, '82, '84: P. '83, '84.
 Publications. Exp. 6-9, 12-14: P. 9, 11, 12, 18, 22, 24.
 Quarterly bulletin. Exp. 42-46: P. 42-44, 52, 53.
- Georgia** dairy and live stock association.
 Annual report. Exp. '02, '03, '05, '08, '09.
- Georgia.** Entomology, State board of. Atlanta.
 Bulletin. D. 1: Exp. 1, 3, 5-19, 31-33, 38+: P. 1, 13, 17, 20, 21, 23, 24,
 26, 27, 29-36. S. L. 12-32*.
- Georgia** forest association.
 Forest, fish and game. P. 2, 3.
 Formerly **Southern** woodlands.
- Georgia** geological survey.
 Bulletin. I. U. 1-19, 23, 26+: P. 24, 25: R. P. 1.
 Report. P. '93.
- Georgia** (state) horticultural society. Cairo.
 Proceedings. Exp. '98, '02, '08-'10.
- Georgia** (state) veterinarian.
 Annual report. P. 1.
- Giornale** di matematiche di Battaglini. Naples, Italy. I. U. 47.
- Glasgow** (Scotland) mechanics' magazine and annals of philosophy. N. H.
 1-4.
- Glasgow** (Scotland) naturalist. Ac. 1+: N. D. III. 1+.
- Glasgow** (Scotland) philosophical society.
 Proceedings. R. P. 19, 20.
- Gleanings** in bee culture. Medina, O. Exp. 39*, 40*; P. 36+.
- Goldthwaite's** geographical magazine. New York. S. N. 1-6.
- Good** health. London, England. I. U. 30-46.
- Good** housekeeping. Springfield, Mass. P. 27, 34, 35, 38-42, 44-48, 52, 53,
 55+.

- Good roads magazine.** New York. Exp. o. s. 2*, 3*, 4; n. s. 4*: P. n. s. 8+.
Called **Good road**; 1832-1895, then merged in **League** of American wheelmen bulletin constituting the old series. In 1902 began a new series under the name **Good roads magazine** which became simply **Good roads** again in 1909.
- Gordon memorial college.** Khartoum, Africa. See **Wellcome** research laboratories.
- Grain dealers' journal.** Chicago, Ill. Exp. 16*, 17*, 18*, 19*.
- Graphic arts.** Boston, Mass. Ft. W. 3+.
- Great American architectural record.** M. 1-6.
- Great Britain.** Agriculture and fisheries, Board of. Intelligence division
Annual report. S. L. '08+.
- Great Britain.** Government laboratory.
Report of principal chemist. S. L. '09, '11, '12.
- Great Britain.** Meteorological office.
Report. S. L. '09-'12.
- Greenough's American polytechnic journal** is volume 4 of **American polytechnic journal** *q. v.*
- Green's fruit grower and home companion.** Rochester, N. Y. Exp. 25*, 27*, 28, 29*, 30+.
- Greenwich (England).** Royal observatory.
Report. S. L. '09-'12.
- Grevillea.** London, England. Exp. 1-14.
- Guam agricultural experiment station.** Island of Guam.
Annual report. Exp. '10+.
- Guide to nature.** B. 1+: F. 3+: G. 4*, 5+: N. D. 1, 2, 3*, 4*, 6.
- Gulf biological station.** Cameron, La.
Bulletin. P. 3, 4, 6, 7, 9-11, 13+.
- Half-yearly abstract of medical sciences.** Philadelphia, Pa. D. 56-58: N. D. 48-55: N. H. 1-7, 9, 10-17, 54-58.
- Hamburg (Germany) mathematische Gesellschaft.**
Mittheilungen. I. U. 5+.
- Hamilton (Ontario) scientific association.**
Journal and proceedings. Ac. 1¹, 14-19, 21+.
- Hampton (Va.) normal and industrial institute.**
Hampton leaflets. N. D. n. s. 1*-4*, 5-7.
Report. Exp. '91.
- Handbuch der Biochemie des Menschen und der Thiere.** Jena, Germany.
Exp. 1-4.
- Handbuch der organischer Chemie.** Hamburg, Germany. Exp. 3*.

- Hardwicke's science gossip.** London, England. I. U. 14, 15; N. H. 16.
- Harvard engineering journal.** Cambridge, Mass. P. 2-3, 4*, 5+.
- Harvard university.** Astronomical observatory. Cambridge, Mass.
Annals. I. U. 6-34.
Circulars. I. U. 1, 2,
- Harvard university.** Arnold arboretum. Ac. 21, 23-25, 27+.
- Harvard university.** Jefferson physical laboratory.
Contributions. E. 1+: I. U. 1-5, 7; P. 1-4, 6+: R. P. 1+: W. 3+.
- Harvard university.** Museum of comparative zoology.
Memoirs. S. N. 28*.
- Harvard university.** Peabody museum of American archaeology and ethnology.
Annual report. Ac. '89, '90.
Memoirs. Ac. 1¹⁻⁵: I. U. 1-2, 4+.
Papers. Ac. 1¹⁻⁶: I. U. 1-2, 4-5.
- Harvester world.** Chicago, Ill. Exp. 2*, 3*, 4+.
- Harvey society.** New York.
Lectures. P. '05+.
- Hausfreund und deutscher amerikanischer Farmer.** Lincoln, Neb. Exp. 14*, 16+.
- Havana (Cuba).** See **Academia** de ciencias medicas fisicas y naturales.
- Havana (Cuba) university.**
Revista de la facultad de letras y ciencias. P. 3+: S. N. 3+.
- Hawaii.** Agricultural experiment station. Honolulu.
Annual report. Exp. '01+: L. P. '06+: N. D. '08+: P. '01+: R. P. '06, '07; S. L. '06, '07, '09-'11.
Bulletin. Exp. 1+: L. P. 1, 8, 11-13, 15-18, 21-24, 26+: N. D. 16+; bot. ser. 1+: P. 1+: R. P. 1-17; S. L. 1-17, 21, 23-26, 28; S. N. '02+.
- Hawaii.** Commissioners of agriculture and forestry.
Report. P. 3+.
- Hawaiian forester and agriculturist.** Honolulu. Exp. 5.
- Hawaii experiment station of the sugar planters' association.** Honolulu.
Annual report. Exp. '99-'05; N. D. '08+.
- Hawaii sugar planters' station.** Honolulu.
Annual report. Exp. '05+.
Bulletin, agriculture and chemistry series. Exp. 1-11, 13+.
Agriculture and forestry series. Exp. 1+.
Entomological series. Exp. 1*, 6-12.
Pathology and physiology series. Exp. 1+.

- Health.** New York. S. N. 54+.
- Heating** and ventilating magazine. New York. P. 5+.
- Hedwigia**, ein Notizblatt für kryptogamische Studien. Dresden, Germany.
Exp. 1-23.
Continued as.
- Hedwigia.** Organ für Kryptogamenkunde. Dresden, Germany. Exp. 24-44,
51+.
- Hirnanatomische** Institute in Zürich (Switzerland). I. U. 1+.
Annales. I. U. 1+.
Arbeiten. I. U. 1+.
- Historical** and scientific society of Manitoba. Winnipeg.
Reports. Ac. '97-'06.
Transactions. Ac. 51-72.
- Hoard's** dairyman. Ft. Atkinson, Wis. Exp. 29*, 30*, 33*, 34*, 35*, 36,
37, 38*, 39-41, 42*, 43+.
- Holstein-friesian** association of America.
Annual report. Exp. '85-'87, '89, '90.
- Holstein-friesian** world. Ithaca, N. Y.
Annual report. Exp. 1-4, 5*.
- Home** and farm. Louisville, Ky. Exp. 35*, 36*, 37*, 38+.
- Horse** review. Chicago, Ill. Exp. 43+.
- Horticultural** society of London.
Transactions. N. D. 1-4.
- Horticulturist** and journal of rural art and rural taste. Rochester, N. Y.;
Philadelphia, Pa.; New York. Exp. 15, 16; N. H. 8-10, 12-15, 19-23.
- Hospodarske** listy. Chicago, Ill. Exp. 13*, 14+.
- House** and garden. Philadelphia, Pa. G. 17+.
- House** beautiful. Chicago, Ill. G. 26+; P. 11+.
- Housekeeping** experiment station. Darien, Conn.
Bulletin. P. 1, 3, 5-11.
- Hygienisches** Centralblatt. Leipzig, Germany. I. U. 1+.
- Ice** and refrigeration. Chicago, Ill. P. 40+.
- Idaho.** Agricultural experiment station. Moscow.
Annual report. D. '04; Exp. '94, '95, '98+; P. '94, '01+.
Bulletin. D. 46, 47; Exp. 1+; P. 1-4, 6, 7, 9+.
- Idaho** (state) engineer. Boise.
Biennial report. Exp. '99, '00.
- Idaho** (state) farmers' institutes. Moscow.
Biennial report. Exp. '01, '02.

- Idaho.** Mines, State inspector of. Boise.
Annual report. N. D. 8+.
- Ideal power.** Chicago, Ill. P. 2, 3, 4*, 5.
- Illinois.** Agricultural experiment station. Urbana.
Annual report. Exp. 1+.
Bulletin. D. 98, 100, 101, 119, 120, 123-147, 149-162: Exp. 1+: P. 1+:
S. L. 88+*.
Soil report. D. 1+: Exp. 1+: P. 1+.
- Illinois** (state) agricultural society.
Transactions. D. 6, 7: S. L. '53, '54, '59, '60, '65-'83.
- Illinois.** Agriculture, Department of. Springfield.
Transactions. D. o. s. 10, 12-19: Exp. 4, 6-20, 22, 23: P. 4, 6-14, 24, 25,
27, 30, 37+.
- Illinois** (state) bee keeper's association.
Report. Exp. 1+.
- Illinois** (state) dairymen's association.
Annual report. Exp. 14-16.
- Illinois,** Economical geology of. Springfield. D. 1-3.
Reprints from the reports of the **Illinois** (state) geological survey (*q. v.*) with additions and emendations.
- Illinois** (state) entomologist. Urbana.
Report on noxious and beneficial insects. S. N. '05, '08, '09.
Report. Exp. 23-27.
- Illinois** farmer and farmer's call. Quincy. Exp. 55*, 56, 57*, 58*, 59, 60*,
61+.
- Illinois.** Farmers' institute. Springfield.
Annual report. Exp. 3, 11, 13: P. 1+.
Bulletin. P. 5, 9, 15+.
Yearbook. Department of household science. P. '09-'11.
- Illinois** (state) food commission. Springfield.
Annual report. Exp. 1, 9: P. '00, '01.
- Illinois** (state) geological survey. Urbana.
Bulletin. I. U. 1+: P. 3+.
Report. E. 1-8.
See also **Illinois,** Economical geology of.
- Illinois.** Health, State board of.
Annual report. P. '80-'94.

- Illinois.** Highway commission.
 Annual report. P. 1.
 Bulletin. P. 2.
- Illinois** (state) horticultural society. Kinrundy.
 Transactions. D. n. s. 2-28, 30, 31; Exp. n. s. 3-21, 24, 25, 29-32, 34, 45+;
 P. n. s. 10, 12-38, 40+.
- Illinois.** Horticultural society, Northern. Chicago.
 Transactions. D. 1.
- Illinois.** Live stock commissioners, Board of.
 Annual report. Exp. '90, '92-'97, '09: P. 25, 26.
 Bulletin. Exp. 1-3: P. 1.
- Illinois** live stock breeders' association.
 Report. Exp. '98.
- Illinois** (state) mining board.
 Annual coal report. N. D. 31+.
- Illinois.** Natural history, State laboratory of. Urbana.
 Bulletin. Ac. 1¹, 2, 6, 2¹, 3, 4, 7, 8, 5³⁻¹², 6¹, 7¹⁻¹⁰, 8¹⁻⁵, 9¹⁻⁵: D. 1, 3, 6; Exp.
 2*, 5*: I. U. 6-8; N. D. 7+: P. 3, 7; S. N. 1-7.
- Illinois.** Natural history, State museum of. Springfield.
 Bulletin. I. U. 3-12||: S. N. 3-12||.
- Illinois.** Railroad and warehouse commission.
 Report. N. D. 42+.
- Illinois** society of engineers and surveyors.
 Annual report. P. 1-7, 9+: R. P. 11-17.
- Illinois** (state) survey.
 Bulletin. N. D. 13, 16.
- Illinois** university. Biological experiment station. Urbana.
 Biennial report. Exp. '95, '96.
- Illinois** university. Ceramics, School of.
 Bulletin. P. 1-2, 6+.
- Illinois** university. Engineering experiment station.
 Bulletin. G. 6+: P. 1+: R. P. 1+.
- Illinois** university. Household science, Department of.
 Publications. P. 1+.
- Illinois** university. Urbana.
 Studies. P. 1+*.
- Illinois** university. Urbana.
 Technograph. P. 6-8, 10+.

- Illinois** (state) water survey. Urbana.
 Bulletin. I. U. 3-4, 6, 8: P. 1+.
 Nos. 1 and 2 issued by Illinois university.
- Illuminating** engineer. New York. P. 1+.
- Illuminating** engineering society. Easton, Pa.
 Transactions. P. 1*, 2*, 3*, 4+.
- Illustrierte** flora. Vienna, Austria. N. D. 37+.
- Imperatorskaya** akademiya nauk. St. Petersburg. See **Académie impériale**
 des sciences.
- Imperial** journal of art, science, etc. Manchester, England. F. 1-4.
- Index** medicus. New York; Washington, D. C. I. U. 3+: M. 2-6.
- Ind a.** Agricultural experiment station. Aligarh.
 Report. Exp. '02-'12.
- India.** Agricultural experiment station. Atarra.
 Report. Exp. '12.
- Ind a.** Agricultural experiment station. Partabgarh.
 Report. Exp. '10-'12.
- India.** Agricultural experiment station. Caunpore.
 Report. Exp. '10-12.
- India.** Agricultural experiment station. Orai.
 Report. Exp. '10, '11.
- India.** Agricultural research institute. Pusa.
 Bulletin. Exp. 18, 28-31: P. 4, 13, 15, 16, 19, 20, 23, 25-26.
 Report. P. '09-'11.
- India.** Agriculture, Department of.
 Annual report. P. '04-'10.
 Memoirs. Bacteriological series. Exp. 1.
 Botanical series. Exp. 2*, 3*, 4*, 5+: P. 1, 2.
 Chemical series. Exp. 1*, 2*+: P. 1*, 2*, 3*.
 Entomological series. Exp. 2*, 3+: P. 1, 2*.
- India.** Inspector-general of forests.
 Review of forest administration. P. '07-'10.
- Indian** school journal. Chilocco, Okla. Exp. 10, 12*, 13+.
- Indian** engineering. Calcutta, India. N. D. 1-14, 16-30, 31*.
- Indiana** academy of science. Indianapolis.
 Proceedings. D. '91-'93, '95-'01, '03+: Exp. '91-'11: F. '98-'04, '08+:
 G. '04, '05, '08+: I. U. 7+: L. P. '98+: N. D. '10+: N. H. 15+: P.
 7+: R. P. '91+: S. N. 7-9, 14+: T. H. '97, '98, '00-'03, '05+: W. 7+.

Indiana. Agricultural experiment station. Lafayette.

Annual report. D. 3, 4, 9, 11-20: Exp. 1+: P. 1+.

Bulletin. D. 13-15, 18, 20, 21, 41, 46, 56, 66, 68, 69, 72-74, 77, 78, 80-95, 97-109, 111-122, 126, 143-145: Exp. 1+: N. D. 59, 60, 159, 160, 162+: P. 1+.

Indiana (state) agricultural society.

Transactions. N. D. 7, 8, 10.

Indiana. Agriculture, Department of.

Annual report*. D. 1-14, 18, 21-23, 25-29, 31, 35, 37-48: Exp. 1-45, 47, 48: N. D. 40, 41, 47: P. 1-3, 6, 9, 11-15, 17+: R. P. 4, 5, 7, 8, 14, 21-24, 37-40, 42-48: S. N. 10, 13, 15-19, 21-26, 28+.

*The numbers given are volume numbers and not report numbers.

Indiana (state) breeders' live stock association.

Report. Exp. 4-8: P. 4+.

Indiana. Charities, Board of state. Indianapolis.

Annual report. D. 1-8, 10, 12+: Exp. 18-22.

Bulletin. D. 32-34, 36-45, 47-59, 61+: Exp. 72-74, 76, 77, 79, 82.

Indiana corn growers' association. Lafayette.

Annual report. Exp. '08+.

Indiana (state) dairy association.

Annual report. D. 20+: Exp. 1-13, 15+: N. D. 22: P. 7-12, 14+.

Indiana engineering society. Indianapolis.

Proceedings. I. U. 8-10, 12: P. 7+: R. P. '93-'96, '08, '09.

Indiana (state) entomologist.

Annual report. D. 1+: Exp. 1+: N. D. 1+: N. H. 1+: P. 1+: S. N. 2+.

Report. Exp. '03, '04: P. '00, '02, '03.

Indiana farmer. Indianapolis. Exp. 18*, 19*, 20*, 21*, 22*, 23*, 24*, 25*,

26*, 27, 28, 29*, 30*, 31, 32*, 33*, 54*, 55*, 56*, 57*, 58*, 59*, 60, 61*, 62*, 63*, 64*, 65*, 66+: P. 59+.

Indiana farmer and gardener. Indianapolis. Exp. 1.

Indiana. Farmers' institutes. Lafayette.

Report. Exp. '93, '94, '96, '98, '00-'10: P. '93, '96, '98, '00, '02, '04-'10: S. N. '82+.

Indiana. Fisheries and game, Commissioner of. Indianapolis.

Biennial report. D. '99+: Exp. '97, '98, '01-'08: N. D. '08: N. H. '92, '99, '00, '09-'10: R. P. '99-'04: S. N. '00+.

Indiana forestry association.

Report. Exp. 3, 5, 7.

Indiana. Forestry, State Board of.

Annual report. D. 3, 5+: E. 3, 5-9, 11: F. 3, 6+: G. 1-3, 5+: I. U. 3+:
L. P. 2+: N. D. 6, 8, 11: N. H. 1+: P. 3+: R. P. 3, 5: S. N. 3, 5+:
T. H. 4+.

Indiana. Geological survey.

Report. D. 2-4, 7-10||: Exp. 1-10||: N. D. 7-10||: N. H. 1-10||: P. 1-7, 8-10||:
R. P. 1-10||:

Report of geological reconnoissance. D. '62: N. H. '39, '62: P. '62.

Indiana. Geology and natural history, Department of.

Bulletin. N. H. 1.

Report. D. 11-16||: Exp. 11-16||: N. D. 11-16||: N. H. 11-16||: P. 11, 12,
14-16||: R. P. 11-16||.

Continued as

Indiana. Geology and natural resources, Department of.

Annual report. D. 17+: Exp. 17+: E. 1-33, 36+: N. D. 1, 2, 11, 13-18,
21-23, 25-27, 29+: N. H. 17+: P. 17+: R. P. 17+.

Indiana geographical congress.

Reports. S. N. 3, 6.

Indiana. Health, State Board of.

Annual report. D. 17-20, 22+: Exp. '83-'85, 18, 20, 23, 25-29: I. U. 5+:
N. D. 5+: N. H. 10-12, 17+: P. 1, 2, 4-13, 15-20, 22+: R. P. 17-20,
22, 23: S. N. 17-20, 22+.

Monthly bulletin. Exp. 1, 2*, 3*, 4+: N. D. 7*-15*, 29+: P. 1+: S. N.
1+.

Quarterly bulletin. Exp. 2*, 3.

Indiana (state) horticultural society.

Bulletin. P. 1+.

Transactions. D. 5, 9, 11, 14-16, 18-24, 26, 27, 29-38, 40+: E. 5, 6, 8, 9:
Exp. 5-26, 28-45, 47, 49, 50: F. 10, 11, 16, 19-23, 25-27, 29-32, 40+:
G. 47, 49+: I. U. 10, 11, 13, 19, 21-23, 29, 40+: L. P. 7, 9, 10, 40+:
N. D. 46, 51: N. H. 5, 9, 11, 13, 40-49: P. 6, 9, 11, 15, 16, 20, 22+: R.
P. '00-'05: S. N. 30, 40-49: T. H. 19-21, 50+: W. 6+.

Indiana medical association.

Journal. Exp. 3*, 4*: I. U. 1+: L. P. '76-'82, '98-'07: P. 1+: T. H. 3, 8,
10-15, 17, 18+.

Transactions. E. '78, '80, '81, '85, '86: Exp. 24-27, 31, 33-36, 38-41, 48,
51-53, 55-58: M. 1-2, 4+: N. H. 28-36, 38-50.

Indiana medical journal. Indianapolis. D. 11-13: I. U. 17-27: M. 1+: P.
11-13, 23-25*, 27: W. 12-27.

- Indiana.** Medical registration and examination, State Board of.
Annual report. Exp. 2, 7, 9-14: F. 2-14: N. D. 14: N. H. 1+: S. N. 1+.
- Indiana** medical society.
Transactions. P. 29, 30, 42, 44-46.
- Indiana** pharmaceutical association. Indianapolis.
Proceedings. N. D. 27: P. '96, '99.
- Indiana.** Pharmacy, Board of.
Annual report. F. 9, 11: N. H. 1, 9, 11: S. N. '07, '09.
- Indiana.** Railroad commission.
Annual report. P. 1+.
- Indiana** state grange. Patrons of husbandry.
Proceedings. P. 28-30.
- Indiana.** Statistics and geology, Bureau of.
Annual report. D. 1, 2||: Exp. 1, 2||: N. H. 1, 2||.
Continued by **Geology** and natural history, Department of *q. v.*; and by **Statistics**, Bureau of. *q. v.*
- Indiana.** Statistics, Bureau of. Indianapolis.
Annual report. D. 3, 4: Exp. 3-6||.
Continued from **Indiana.** Statistics and geology, Bureau of, *q. v.*; Continued as
Biennial report. D. 2-5, 7+: Exp. 1+.
- Indiana** Tippecanoe farmer. Lafayette. Exp. 1.
- Indiana** university. Bloomington.
Studies. I. U. 1+: L. P. 8*, 10*: N. D. 10*+: P. 1+.
- Indiana** university. Zoological laboratory.
Contributions. D. 1-58, 60-75, 77-97, 99-114: N. D. 60-114.
- Indiana** (state) veterinarian. Indianapolis.
Annual report. Exp. '02, '06, '08, '09: P. '02, '06, '08, '09.
- Indiana** wool growers' association.
Annual report. Exp. '01.
- Indianapolis** (Ind.) medical journal. I. U. 7+: M. 12, 14+: P. 12+: W. 12+.
- Industrial** arts index. Minneapolis, Minn.; White Plains, N. Y. G. 1+.
- Industrial** engineering and engineering digest. New York. E. 3, 4: Ft. W. 6+: G. 5+: P. 6+: R. P. 3+.
Continues **Engineering** digest *q. v.*
- Industrial** magazine. Cleveland, O. P. 1+.
Vols. 1-4 have title **Draftsman**; and vol. 5 has title **Browning's** industrial magazine.
- Industries.** Manchester, England. R. P. 1-15.
- Inland** architect and news record. Chicago, Ill. N. D. 44*, 45*, 48*, 49, 50*: R. P. 30-52.
Continued as **American** architect *q. v.*

- Inland printer.** Chicago, Ill. Ft. W. 49+.
- Insect life.** Washington, D. C. See under **United States.** Entomology, Bureau of.
- Institut catholique.** Paris, France.
Ensignement superiur libre. N. D. '81.
- Institut de France.** See **Académie des sciences.**
- Institut international de bibliographie.** Brussels.
Bibliographia physiologica. Ae. 1¹⁻⁵, 2^{1, 2}.
- Institut Pasteur.** Paris, France.
Annales. I. U. 20+: S. L. 24+.
Bulletin. I. U. 3+.
- Institution of civil engineers.** London, England.
Proceedings. P. 1+: R. P. 87+.
- Institution of electrical engineers.** London, England.
Journal. P. 18+.
Continued from Journal 17, of the Society of Telegraph engineers & v.
- Institution of mechanical engineers.** Birmingham; London, England.
Proceedings. P. 1+.
- Intermédiaire des mathématiciens.** Paris, France. I. U. 18+: P. 15+.
- International apple shippers' association.**
Yearbook. Exp. '08-'10.
- International association for testing materials.**
Report. P. 5.
American section. See **American society for testing materials.**
- International catalogue of scientific literature.** London, England.
R. P. secs. A, B, C, D, F. 1+.
- International commission on zoological nomenclature.**
Opinions. S. L. 1+.
- International congress of applied chemistry.** New York.
Report. Exp. '12.
- International geographic congress.**
Report. P. 8: S. N. 6.
- International independent telephone association.**
Proceedings. P. 10, 11.
- International institute of agriculture, economic and social intelligence.** Rome, Italy.
Bulletin. Exp. '11*, '12+:

- International** institute of agriculture, agricultural intelligence in plant diseases.
Rome, Italy.
Monthly bulletin. Exp. 2*, 3+.
- International** journal of microscopy and natural science. London, England.
D. 2.
- International** journal of surgery and antiseptics. New York. D. 1*.
Continued as
- International** journal of surgery. New York. D. 2*, 3, 4*.
- International** railway congress. Brussels, Belgium.
Bulletin. P. 19+.
- International** studio. New York. P. 12*, 13, 14*, 15+.
- Internationale** Monatschrift für Anatomie und Physiologie. Leipzig, Germany. I. U. 1+.
- Internationale** Wochenschrift für Wissenschaft, Kunst, und Technik. Berlin, Germany. I. U. 1+.
- Internationaler** Kongres katholischen Gelehrten zu München, Germany.
Akten. N. D. '01.
- Internationales** Archiv für Schulhygiene. Leipzig, Germany. I. U. 1+.
- Interstate** association of live stock sanitary boards.
Proceedings. Exp. 4, 5.
- Ion.** London, England. W. 1.
- Iowa** academy of sciences. Des Moines.
Proceedings. Ae. 11, 12, 14-18: I. U. 1, 2, 18+: N. D. 2, 5, 7, 9, 10, 12-15, 17+: S. L. 1⁴, 3-5, 7, 9, 10.
- Iowa.** Agricultural experiment station. Ames.
Annual report. Exp. 1, 3: P. 1*, 2*, 3*, 4+.
Bulletins. Exp. 1+: N. D. 107-112, 114-122, 124-127, 129-141, 143+:
P. 1+.
Research bulletins. Exp. 1+: N. D. 1-8, 11+: P. 1+.
- Iowa** (state) agricultural society.
Report. S. L. '61, '62, '65, '67, '72-'74, '76-'82, '84-'89, '95, '96, '98, '99.
- Iowa.** Agriculture, Department of. Des Moines.
Yearbook. Exp. '04-'11: P. '05+.
- Iowa** (state) college of agriculture and mechanic arts. Ames.
Bulletin. Exp. 4, 8.
Extension department bulletin. P. 1-5, 7-12, 14+.
- Iowa** (state) dairy association.
Report. Exp. '91-'96.

- Iowa** (state) drainage association.
Proceedings. Exp. 1-2, 4-7.
- Iowa** (state). Drainage, waterways and conservation commission.
Report. P. 1+.
- Iowa** engineer. Ames. P. 1+.
- Iowa**. Engineering experiment station.
Bulletin. Exp. 3*, 4*: P. 4+.
- Iowa** engineering society.
Proceedings. P. 1.
- Iowa**. Geological survey.
Annual report. E. 6, 7, 9-20: I. U. '55-'57, '66-'69, '92+: N. H. '55-'57, '66-'69.
Bulletin. Exp. 1: P. 1.
Report survey of '55-'59. E. 1*.
- Iowa** (state) geologist. Des Moines.
Report. N. H. 1, 2.
- Iowa**. Health. State board of. Des Moines.
Biennial report. P. '80-'97, '99-'03, '08-'10.
- Iowa** (state) highway commission. Ames.
Report. Exp. 2, 3.
- Iowa** homestead. Des Moines. Exp. 54*, 55*.
- Iowa** (state) horticultural society. Des Moines.
Transactions. D. 16: Exp. 14-19, 25, 27-46: P. 44: S. L. '72-'07*.
- Iowa** naturalist. Iowa City. Ac. 1: N. D. 1+.
- Iowa** park and forestry association. Des Moines.
Proceedings. Exp. '03, '05.
- Iowa** (state) university. Iowa City. Engineering society.
Transit. P. 1-3, 5-13, 15.
- Iowa** (state) university. Iowa City. Natural history, Laboratories of.
Bulletin. N. D. 5+: N. H. 4, 5: P. 2-4.
- Iowa** (state) university. Iowa City. Physical laboratory.
Contributions. P. 1*.
- Iowa** (state) university. Iowa City. Psychology. Department of.
Studies. I. U. 1-3: P. 1, 2.
- Ireland**. Agricultural technical instruction, Department of. Dublin.
Bulletin. Exp. 1, 4.
Leaflets. Exp. 1, 4-7, 9-11, 13-37.
- Iron** age. New York. Ft. W. 69, 70, 72*, 73*, 75, 76, 78-85, 87+: G. 83+:
M. 61, 62, 71+: N. D. 52-56: P. 67*-71*, 81+.

- Iron and steel institute.** London, England.
Carnegie scholarship memoirs. P. 1+.
Journal. G. '76+: P. 75+.
- Iron and steel magazine.** Boston, Mass. P. 1-11||.
Vols. 1-6 have title **Metallographist**. Combined in 1906 with **Electro-chemical** and metallurgical industry *q. v.*
- Iron trade review.** Cleveland, O. G. 45+: P. 39-46.
- Irrigation age.** Chicago, Ill. Exp. 24, 25, 26*, 27+.
- Jahresbericht** über das Gebiet der Pflanzenkrankheiten. Berlin, Germany.
Exp. 11.
- Jahrbuch** der Chemie (Meyer). Brunswick. P. 1+: R. P. 3+.
- Jahrbuch** über die Fortschritte der Mathematik. Berlin, Germany. I. U. 1+: P. 1+.
- Jahrbücher** für wissenschaftliche Botanik. Berlin; Leipzig, Germany. I. U. 7-46, 48+.
- Jahresbericht** über die Fortschritte der Chemie und Mineralogie. Tübingen, Germany. P. '22-'74.
- Jahresbericht** über die Fortschritte der reinen pharmaceutischen und technischen Chemie, Physik, Mineralogie, und Geologie. Giessen, Germany. I. U. 1+.
- Jahresbericht** über die Fortschritte in der Lehre von den pathogenen Mikroorganismen. Leipzig; Brunswick, Germany. I. U. 1+.
- Jahresbericht** über die Leistungen und Fortschritte auf dem Gebiete der Neurologie und Psychiatrie. Berlin, Germany. I. U. 1+.
- Jahresberichte** der deutschen Mathematiker Vereinigung. Leipzig, Germany. I. U. 1-9, 11-14, 15+.
- Jahresberichte** über die Fortschritt der Anatomie und Physiologie. Leipzig, Germany. I. U. 1-8.
- Jamaica** (W. I.). Agriculture, Department of. Kingston.
Bulletin. Exp. 1-5, 6*.
Report. Exp. '00, '02-'07.
- Jamaica** (W. I.). Botanical department.
Bulletin. Exp. 2*, 3, 9*.
- Japan.** Agricultural experiment station. Hokkaido.
Bulletin. Exp. 1-11.
Report. Exp. 2-4.
- Japan** college of agriculture. Tokyo.
Bulletin. Exp. 5, 7, 8*. P. 7.

- Japan.** See **Seismological** society of Japan.
- Jardin** impériale botanique. St. Petersburg, Russia.
Bulletin. N. D. 12+.
- Jersey** bulletin and dairy world. Indianapolis, Ind. Exp. 25*, 26*, 27*, 28*, 29*, 30*, 31+: P. 24+.
- Jewish** agricultural and industrial aid society. New York.
Annual report. Exp. 9, 11: P. '09+.
- Johns Hopkins** hospital. Baltimore, Md.
Bulletin. Exp. 22+: I. U. 1+: M. 18-20, 22: P. 17+.
Report. I. U. 1+.
- Johns Hopkins** university. Baltimore, Md.
Circulars. Ac. 4-21*: D. 1-11: I. U. 25+: P. 16+.
- Josselyn** botanical society of Maine. Portland.
Bulletin. N. D. 2.
- Journal** de l'anatomie et de la physiologie normales et pathologiques. Paris, France. I. U. 40+.
- Journal** de l'école polytechnique. See **École** polytechnique.
- Journal** de mathématique. Paris, France. I. U. 1-20; II. 1-19; III. 1-10; IV. 1-10; V. 1-10; VI. 1+.
- Journal** de micrographie. Paris, France. R. P. 1.
- Journal** de physiologie et de pathologie générale. Paris, France. I. U. 1+.
- Journal** de physique. Paris, France. I. U. III. 6-10; IV. 1-8; V. 1+: P. IV. 4+: W. IV. 2, 4, 5.
- Journal** für die reine und angewandte Mathematik. Berlin, Germany. I. U. 1-119, 121+.
- Journal** für Landwirtschaft. Göttingen; Berlin, Germany. Exp. 21-24, 28, 31, 37+.
- Journal** für praktische Chemie. Leipzig, Germany. N. D. 51*, 52*; W. 1-80.
- Journal** für Psychologie und Neurologie. Leipzig, Germany. I. U. 1+.
- Journal** of abnormal psychology. Boston, Mass. I. U. 3, 5+.
- Journal** of advanced therapeutics. Rahway, N. J. P. 23*, 24*.
- Journal** of agricultural science. Cambridge, England. Exp. 3+: P. 2+.
- Journal** of agriculture. London, England. S. L. 1-20.
- Journal** of agriculture. St. Louis, Mo. Exp. 51*, 52*, 53*.
- Journal** of analytical and applied chemistry. Easton, Pa. Exp. 2*, 3*: P. 4-7||: R. P. 4-7||: W. 1-7||.
- Continued from Vol. 7 as **American** chemical society. Journal. *q. v.*
- Journal** of anatomy and physiology. London, England. I. U. 38+.

- Journal** of animal behavior. Cambridge, Mass. B1+: D. 1+: I. U. 1+: P. 5+: S. N. 1+.
 Behavior monographs. B. 1+: I. U. 1+.
- Journal** of applied microscopy. Rochester, N. Y. B. 2-6||: N. D. 1*, 2*, 3-6||: S. N. 4-6||.
- Journal** of biological chemistry. New York. I. U. 1+: N. D. 1+: P. 1+: S. L. 2+.
- Journal** of botany, British and foreign. London, England. Exp. 40-49.
- Journal** of botany (Hooker). London, England. I. U. 1+: N. H. 1-4.
- Journal** of comparative medicine and surgery. Philadelphia, Pa. Exp. 1-10||.
 Continued by **Journal** of comparative medicine and veterinary archives *q. v.*
- Journal** of comparative medicine and veterinary archives. Philadelphia, Pa. Exp. 11-24.
- Journal** of comparative neurology. Philadelphia, Pa. D. 1-21: I. U. 1+: S. N. 16+.
 Volumes 14-20 were entitled **Journal** of comparative neurology and psychology.
- Journal** of comparative pathology and therapeutics. London, England. Exp. 23+.
- Journal** of cutaneous and venereal disease. New York. D. 1*, 2*, 3*.
- Journal** of economic entomology. Concord, N. H. Exp. 1+: P. 1+: S. L. 1-4: W. 2+.
- Journal** of educational psychology. Baltimore, Md. I. U. 1+: P. 1+: S. N. 1+.
- Journal** of engineering. Boulder, Colo. See under **Colorado** university.
- Journal** of electricity, power, and gas. San Francisco, Calif.; New York. P. 27+.
- Journal** of experimental medicine. New York; Lancaster, Pa. Exp. 13+: I. U. 1-6, 8-12, 14+.
- Journal** of experimental zoology. Philadelphia, Pa. E. 6: I. U. 1-12: P. 1+: S. L. 6+: S. N. 1+: W. 2+.
- Journal** of genetics. Cambridge, Mass. I. U. 1+.
- Journal** of geography. Lancaster, Pa.; Chicago, Ill.; New York. I. U. 7+: S. N. 1+.
- Journal** of geology. Chicago, Ill. B. 7-18: E. 1+: F. 20+: I. U. 1+: M. 18, 19: P. 1*, 2*, 3*-5*, 6-14, 15*, 16+: S. L. 1+: S. N. 1+: W. 1+.
- Journal** of home economics. Geneva, N. Y. P. 2+.
- Journal** of hygieo-therapy. Kokomo, Ind. D. 4*, 5*, 6*, 7*: P. 1*.
- Journal** of hygiene. Cambridge, England. I. U. 1+: P. 6+.

- Journal** of industrial and engineering chemistry. Easton, Pa. D. 1+: Exp. 1+: Ft. W. 4+: G. 5+: I. U. 1+: N. D. 1+: P. 1+.
- Journal** of infectious disease. Chicago, Ill. Exp. 1+: P. 1+: S. L. 5+: T. H. 6+.
- Supplement. Exp. 1-4.
- Journal** of materia medica. New Lebanon, N. Y. D. 1*, 13*, 14*, 15*, 20*, 23*, 24*.
- Journal** of medical research. Boston, Mass. Exp. o. s. 24+: I. U. n. s. 1-17, 21+: T. H. 20-22, 24-26.
- Journal** of medical science. Dublin, Ireland. D. 62, 66, 72.
- Journal** of medical science. Edinburgh, Scotland. D. 1-3.
- Journal** of mental science. London, England. I. U. 40-56, 58+.
- Journal** of microscopical science. See **Quarterly journal** of microscopical science.
- Journal** of morphology. Boston, Mass.; Philadelphia, Pa. B. 10-20: D. 1-23: I. U. 1-17, 19+: P. 1+: W. 17.
- Journal** of mycology. Manhattan, Kan.; Washington, D. C.; Columbus, O. D. 1-14||: N. D. 1-3, 7*, 8*: S. L. 1-7: S. N. 1-4: W. 9-12.
- Continued as *Mycologia* *q. v.*
- Journal** of nervous and mental diseases. New York. I. U. 27+: T. H. 36+.
- Journal** of pathology and bacteriology. Cambridge, Mass. Exp. 15+.
- Journal** of pathology and bacteriology. Edinburgh, Scotland; London, England. I. U. 1+.
- Journal** of pharmacology and experimental therapeutics. Baltimore, Md. P. 1+.
- Journal** of philosophy, psychology and scientific methods. New York. E. 1-6: I. U. 1+: P. 5+: S. N. 1+.
- Journal** of physical chemistry. Ithaca, N. Y. B. 18+: I. U. 1-15: P. 6+.
- Journal** of physiology. Cambridge, London, England. D. 1-6, 12, 16: I. U. 1+: P. 32+.
- Journal** of race development. Worcester, Mass. I. U. 1+.
- Journal** of religious psychology. See **American journal** of religious psychology and education.
- Journal** of school geography. Lancaster, Pa. S. N. 1+.
- Journal** of the board of agriculture. London, England. Exp. 17*, 18+.
- Journal** of the veterinary science in India. Madras. Exp. 1-7.
- Journal** of tropical medicine. London, England. I. U. 9+.
- Journal** russe de botanique. St. Petersburg, Russia. N. D. '12+.

- Jurjev** (Russia) Imperial university.
Acta horti botanici. N. D. 14+.
- Kaiserlich** Gesundheitsamte. Berlin, Germany.
Arbeiten. Exp. 1, 3.
- Kaiserlich-königliche** zoologische-botanische Gesellschaft. Vienna, Austria.
Verhandlungen. Ac. 38, 39¹⁻⁴, 40^{3, 4}, 41-43, 44¹⁻⁴, 45¹⁻¹⁰, 46^{1-3, 5, 7, 9, 10},
47¹⁻¹⁰, 49-60, 61¹⁻¹⁰.
- Kaiserlich-leopoldinische-carolinische** deutsche Akademie der Naturforscher.
Halle, Prussia.
Abhandlungen. Ac. 68, 69^{1, 2}, 70¹, 73³, 77¹, 79², 81^{1, 3, 6}, 82^{3, 4}, 86^{1, 2}, 88³,
90^{1, 3, 4}, 92¹, 93².
- Kansas** academy of science. Topeka.
Transactions. Ac. 9, 19-22, 24; E. 13, 15-18; Exp. 8, 12; I. U. 20-21, 24,
25, 28, 29, 32-35; N. D. 20+; N. H. 21*; R. P. '87-'90, '99-'02; S. L.
5, 8-17.
- Kansas** (state) agricultural college. Manhattan.
Agricultural education. P. '10+.
- Kansas.** Agricultural experiment station. Lawrence.
Annual report. Exp. 1-5.
- Kansas.** Agricultural experiment station. Manhattan.
Annual report. Exp. 1+; P. 1+; S. L. '83-'00.
Bulletin. D. 75, 127, 129; Exp. 1+; N. D. 180; P. 1+; S. L. '89-'98.
- Kansas.** Agriculture, State board of.
Annual report. D. 5||.
Continued as
Biennial report. D. 1, 3-5; Exp. 9+; N. D. 4; P. 1, 3, 10+.
Quarterly report. Exp. 20*, 21*, 22*, 23*, 24*, 27*, 28+; P. 26, 27*, 28*,
29, 30*, 31+.
- Kansas** (state) entomological commission.
Report. P. 1+.
- Kansas** farmer. Topeka. Exp. 47*, 48*, 49*, 50*, 51+.
- Kansas** (state). Fish and game, Department of.
Bulletin. P. 1+.
- Kansas** (state). Geological survey.
Bulletin on mineral resources. I. U. 1+; P. '99, '03; R. P. '97-'99.
Report. E. 1-7, 9; P. 3, 5, 6; R. P. 2-5.
Report of progress. P. n. s. 1.

Kansas (state) horticultural society. Topeka.

Biennial report. D. 1-3.

Pamphlets. S. L. 1-4.

Report. D. 9-16||: P. 15.

Continued as Biennial report *q. v.*

Transactions. Exp. 13-16, 18-22, 24, 27, 28, 30, 31: S. L. '78-'10.

Kansas industrialist. Manhattan, Kan. N. D. 38*, 39*+.

Kansas live stock sanitary commission. Topeka.

Biennial report. Exp. '09, '10.

Kansas university. Lawrence.

Engineering record. P. 1-2.

Quarterly. Ac. ser. A. 6-10; ser. B. 6-7: P. 1-10*.

Science bulletin. Ac. 1-5, 6: D. 4*, 7*, 13*: I. U. 1+: N. D. 1+: P. 1+:
R. P. 1+.

Keith's magazine. Minneapolis, Minn. Ft. W. 15+: G. 23+.

Kentucky. Agricultural experiment station. Lexington.

Annual report. D. 2-18: Exp. 1+: P. 1+.

Bulletin. D. 93, 124-133, 135, 140, 142-148, 151-158, 161-164, 167, 169+:
Exp. 1+: P. 1+: S. L. '09+.

Kentucky (state) agricultural society.

Report. S. L. '56, '57.

Kentucky. Agriculture, labor and statistics, Bureau of. Frankfort.

Biennial report. Exp. '04, '05: P. '06-'09.

Kentucky (state) farmers' institute. Louisville.

Annual report. Exp. '07, '11.

Kentucky. Forestry and emigration, State board of.

Annual report. Exp. '78.

Kentucky (state). Geological survey.

Report of progress. I. U. '54-'59: N. D. '56, '57: N. H. 1-4: P. n. s. 1.

Keramic studio. New York. G. 12+.

Kew, England. See **Royal** botanic gardens.

Kimball's dairy farmer. Waterloo, Ia. Exp. 7, 8*, 9+.

Kleinwelt. Zeitschrift der deutschen micrologischen Gesellschaft. Munich,
Germany. N. D. '09+.

Königlich-bayerische Akademie der Wissenschaften. Munich, Germany.

Sitzungsberichte. Ac. 1-15, '11¹⁻³, '12¹⁻².

Königlich deutsches archæologisches Institut.

Mittheilungen athenische. I. U. 1+.

Mittheilungen roemische. I. U. 1+.

- Königlich-preussische Akademie der Wissenschaften.** Berlin, Germany.
Abhandlungen. I. U. 1+.
- Königlich-sächsische Gesellschaft der Wissenschaften: mathematisch-physische Klasse.**
Berichte über die Verhandlungen. I. U. 63+.
- Königliche Gesellschaft der Wissenschaften zu Göttingen.** Mathematisch-physikalische Klasse.
Nachrichten. I. U. 61+.
- Königliche katholische Gymnasium.** Culm, Germany.
Jahresberichte. N. D. 10.
- Kongelige norske videnskabers selskab.** Trondhjem, Norway.
Skrifter. Ac. '97-'11.
- Kongliga svenska Vetenskaps-akademie.** Stockholm, Sweden.
Arkiv för botanik. Ac. 1¹⁻⁴, 2¹⁻³, 7+.
Arkiv för kemie, mineralogi och geologie. Ac. 1¹, 3¹⁻⁶, 4¹⁻⁷.
Arkiv för zoologi. Ac. 1¹, 4⁺.
Behang till handlingar. Ac. 12-28.
- Koninklijke natuurkundige Vereeniging in Nederlandsch-Indie.** Weltevreden, Dutch East Indies.
Naturkundige Tijdschrift. Ac. 52, 53, 55+.
- Koninklijke akademie von wetenschappen.** Amsterdam, Holland. I. U. 13+.
- Kosmos.** Stuttgart, Germany. N. D. '13+.
- Lake Michigan water commission.**
Report. P. 1+.
- Lancet.** London, England. I. U. 82-87.
The American reprint was issued in New York under the title **London lancet** *q. c.*
- Landscape architecture.** Harrisburg, Pa. G. 2+.
- Landwirtschaftliche Jahrbücher.** Berlin, Germany. Exp. 12-26, 40+.
- Landwirtschaftlichen Versuchsstationen.** Berlin, Germany. Exp. 17, 36, 37,*
38, 39*, 40+: I. U. 35-47, 49+.
- La Plata** (Argentine Republic). See **Museo de la Plata**.
- Leaflets of botanical observations and criticism** (Greene). Washington, D. C. N. D. 1+.
- Leeds** (N. Dak.) herbarium.
Bulletin. N. D. 1, 2||.
- Leland Stanford, jr.** university. Hopkins laboratory.
Contributions to biology. Exp. 19, 25, 27, 30: I. U. 1-32: P. 1-8, 10-12,
14, 16, 18-30.
Publications. Ac. 1-6, 9: Exp. 1-6, 9, 11+: P. 1+.

- Lens.** Chicago, Ill. R. P. 1, 2||.
- Lick** observatory. See **California** university.
- Liebig.** Annual report of progress of chemistry and allied sciences. London, England. R. P. 1-4.
- Lilly** scientific bulletin. Indianapolis, Ind. Exp. I*: N. D. I. 1+.
- Lincoln** (Neb.) freie press. Exp. 28*, 29+.
- Linnean** society of London (England).
Transactions. I. U. II. zoology 4+.
- Linnean** society of New South Wales. Sidney, Australia.
Proceedings. Ac. 25, 26¹⁻⁴, 27²⁻⁴, 28¹⁻⁴, 29¹⁻⁴.
- Linnean** society of New York.
Abstract of proceedings. Ac. 1-4, 6-11.
Transactions. Ac. 1.
- Lister** institute of preventive medicine. London, England.
Collected papers. Ac. 2-8¹⁻².
- Live** stock journal. Chicago, Ill. Exp. 48*, 55*, 56*; P. 33-42.
- Live** stock journal. London, England. Exp. 33-48, 56-62, 65*, 66+.
- Lloyd** library. Cincinnati, O.
Bibliographical contributions. Ac. 1+: Exp. 2-10: N. D. 1+.
Bulletins. Botanical series. Ac. 2: Exp. 2: N. D. 1+: P. 1+.
Materia medica series. N. D. 1+: P. 1+.
Mycological series. Ac. 1-4, 6: Exp. 3-4: P. 1+.
Pharmacy series. Ac. 1+: Exp. 1-5: N. D. 1+: P. 1+.
Polyporoid series. Exp. 1.
Reproduction series. Ac. 1-6: Exp. 1-7.
Mycological notes. Ac. 1-26, 30-35: Exp. 32-37: N. D. 1*-3*: P. 1-11, 14+.
- Locomotive** engineering. New York. P. 8*, 9*, 10-13||: R. P. 10-13||.
Continued as **Railway** and locomotive engineering *q. v.*
- Locomotive** firemen's and enginemmen's magazine. Terre Haute, Ind.; Peoria, Ill. P. 46+: R. P. 10, 12+.
- London** (England). See **Lister** institute.
- London** (England). Agriculture and fisheries. Board of.
Annual report. Exp. '04, '05, '08.
Leaflets. Exp. 18, 29, 66, 78, 97, 100, 144, 146, 160-190, 192-194, 196-206, 208-226, 228, 233, 241, 242, 245, 246, 248-255, 257+.
- London** (England) horticultural society.
Transactions. N. D. 1-4.
- London** (England) journal of arts and sciences. N. D. 1-4, 8, 9, 12, 13.

London lancet. New York. N. H. 1-14; n. s. '52-'58.

American reprint of the **Lancet**, London. *q. v.*

London mathematical society.

Proceedings. I. U. I. 1-35; II. 1+.

London (England) medical and surgical journal. D. 1-8.

London (England) microscopical society.

Transactions. R. P. 1-3.

London physical society.

Proceedings. I. U. 1+: P. 19+.

Long Island agronomist. Medford, N. Y. Exp. 1+: P. 5+.

Louisiana. Agricultural experiment station. Baton Rouge.

Annual report. Exp. 1+: P. 1-6, 10, 12+.

Bulletin. Exp. o. s. 1-8, 10-28; n. s. 1+: P. 1+: S. L. 106-112, 115-116, 124.

Louisiana. Agriculture, Commissioner of.

Biennial report. P. 2, 9, 12, 13.

Louisiana conservation commission.

Report. P. '10.

Louisiana. Crop pest commission. Baton Rouge.

Biennial report. Exp. '06-'09: P. '04-'07.

Louisiana geological survey. Baton Rouge.

Bulletin. Exp. 1, 3-8: P. 1-5, 7-8.

Report. P. '99, '02.

Louisiana. Gulf biologic station. Cameron.

Bulletin. P. 3, 4, 6, 7, 9-11, 13-15.

Louisiana (state) horticultural society. Baton Rouge.

Annual report. Exp. '04-'08.

Louisiana (state) museum. New Orleans.

Bulletin. Ac. 1: Exp. 1: N. D. 1, 2, 4+.

Report. Ac. '10, '12: N. D. '08, '10+.

Louisiana planter and sugar manufacturer. New Orleans. Exp. 3*, 4-8,

9*, 10-12, 13*, 14*, 15*, 16, 17*, 18*, 19*, 20*, 21*, 22, 23, 24*, 25*, 26, 27, 28*, 29*, 30, 31*, 32, 33*, 34, 35*, 36*, 37-40, 41*, 42*, 43-45, 46*, 47*, 48*, 49*, 50+.

Louisiana society of naturalists.

Proceedings. N. D. '00.

Louisiana state university. Baton Rouge.

Farmer's library circulars. P. 1.

- Louisville** (Ky.) medical monthly. P. 2*, 3*.
- Lowell** observatory. Flagstaff, Ariz.
Annals. I. U. '98, '00, '05.
- Lumière électrique.** Paris, France. P. n. s. 1+.
Continues **Eclairage électrique** *q. v.*
- Lyon** (France), Université catholique de. N. D. n. s. 6-9.
- Machinery.** New York. Engineering edition. Ft. W. 13+: G. 7*, 8+: L.
P. 15*, 16*, 18*, 19+: P. 10+: R. P. 3+.
- Magazine of art.** London, England. P. 3-13, 14*.
- Magyar** botanikai Lapok. Budapest, Hungary. N. D. 10+.
- Magyar királyi természettudományi társulat.** Budapest, Hungary.
Megbizásából. Ac. 1-3.
- Magyar** madártani központ folyóirata. Budapest, Hungary.
Aquila. Ac. 5+: N. D. '12+.
- Magyar** memzeti múzeum. Budapest, Hungary. Ac. 1-3.
- Maine.** Agricultural experiment station. Orono.
Annual report. Exp. '85+: P. '88+.
Bulletin. D. 28, 32, 35, 36, 42, 46, 113, 115-118, 136, 138: Exp. o. s. 1-26:
n. s. 1+: P. 1+.
Official inspection bulletin. Exp. 1+: P. 1+.
- Maine.** Agriculture, Commissioner of.
Annual report. P. 1+: S. N. 1+.
Bulletin. P. 8*, 9*, 10*, 11+.
- Maine.** Agriculture, state board of.
Annual report. P. 1-45.
- Maine.** Cattle commissioners.
Report on contagious diseases of animals. P. '02-'08.
- Maine** dairymen's association.
Annual report. Exp. 9-11: P. 13.
- Maine** (state) entomologist.
Annual report. P. 1-6.
- Maine** forest commissioner.
Report. P. 4, 5, 7, 8: S. N. 4, 5, 7.
- Maine.** Health, State board of. Augusta.
Annual report. Exp. 8-10, 12-15: P. 1-15
Bulletin. Exp. *1, 2+.
Report of sanitary inspector. Exp. 8*, 9, 10, 11-15*.
- Maine.** Highway, Commissioner of.
Annual report. S. N. '05-'09.

- Maine** (state) horticulturist.
Annual report. P. 1+.
- Maine.** Inland fisheries and game, Commissioner of.
Report. P. '02, '06+: S. N. '02, '06, '08.
- Maine** (state) pomological society. Turner.
Transactions. Exp. '95, '99, '01.
- Maine.** Sea and shore fisheries, Commissioners of.
Report. P. '02+: S. N. '03-'08.
- Maine.** Water storage commission. Augusta.
Report. N. D. 1+: P. 1+.
- Malvern** (England) college natural history society.
Report. N. D. 9+.
- Man.** London, England. I. U. 8+.
- Manchester** (England) microscopical society.
Annual report and transactions. N. D. '11+.
- Manchester** (N. H.). Water commissioners, Board of.
Annual report. N. D. 4+.
- Manitoba.** See **Historical** and scientific society of Manitoba; **Winnipeg.**
- Manitoba** agricultural college. Winnipeg.
Bulletin. Exp. 1-5.
- Manitoba** horticultural and forestry association. Winnipeg.
Annual report. Exp. '98, '02-'06, '08, '09.
- Manual** training magazine. Chicago; Peoria, Ill. Ft. W. 10+: G. 10+:
I. U. 6+: L. P. 10+: N. H. '11+: P. 9+: S. N. 1+: T. H. 9+.
- Marconigraph.** New York. Ft. W. 1+.
- Marine** biological laboratory. Woods Hole, Mass.
Lectures. I. U. 1-7: S. N. '93-'99||.
See **Biological** bulletin.
- Market** growers' journal. Louisville, Ky. Exp. 1, 2, 3*, 4-7, 8*, 9+.
- Maryland** agricultural college. College Park, Md.
Quarterly. Exp. 1-3, 5-21, 23-37, 46-48, 50+.
- Maryland.** Agricultural experiment station. College Park.
Annual report. Exp. 1+: P. 1+.
Bulletin. D. 58, 60: Exp. 1+: P. 1+: S. L. '98-'09.
Special bulletin. Exp. '89-'90.
- Maryland.** Geological survey.
Report. E. 1-6, 9: I. U. 1: P. 1+.
- Maryland** (state) horticultural society. College Park.
Annual report. Exp. 2-4, 6-13.

- Maryland.** Statistics and information, Bureau of. Baltimore.
Annual report. Exp. '10-'11.
- Maryland** weather service. Baltimore, Md.
Report. E. 2; Exp. 2; P. n. s. 1+; S. N. n. s. 1+.
Special publications. N. D. 3.
- Massachusetts** agricultural college. Boston, Mass.
Annual report. Exp. '92-'94, '97-'01, '04.
- Massachusetts.** Agricultural experiment station. Amherst; Hatch station.
Annual report. Exp. 1+; N. D. 19-22, 24+; P. 2, 3, 8+.
Bulletin. Exp. 1+; N. D. 100-106, 108, 110-121, 123-135, 138+; P. 1+.
- Massachusetts.** Agricultural experiment station. State station.
Annual report. Exp. 1-25; P. 1-12.
Bulletin. Exp. 5, 7-56; P. 1-45, 47-49, 51, 52, 54-56.
Meteorological observations. Exp. 1+; P. 234+.
Special bulletin. Exp. 1-6.
The Hatch station and the State station were combined in 1896.
- Massachusetts** agricultural society.
Reports. N. D. 1+.
- Massachusetts.** Agriculture, State board of.
Annual report. Exp. '53+; N. D. 10, 11+; P. '55, '86-'09; R. P. 4, 29.
Bulletin. Exp. 1+; P. 1+.
Crop report bulletin. Exp. 23+.
Nature leaflets. Exp. 1+.
- Massachusetts.** Cattle commissioners, Board of. Boston
Annual report. Exp. '99-'01.
- Massachusetts** (state) forester.
Bulletin. P. 1, 3-5.
Report. P. 5+.
- Massachusetts** fruit growers' association.
Annual report. Exp. 12-17.
- Massachusetts.** Health, State Board of.
Annual reports. R. P. 1-11, 23; P. 1-7, 11, 18, 20-29, 32+.
- Massachusetts.** Highway commission.
Report. P. 1, 4, 7-14, 17+.
- Massachusetts** horticultural society. Boston.
Transactions. Ac. '92², '93^{1, 2}, '94^{1, 2}, '95¹⁻³, '96¹⁻³, '97^{1, 2}, '98^{1, 2}, '99^{1, 2},
'00², '03², '04^{1, 2}, '05^{1, 2}, '06-'09, '10^{1, 2}, '11¹, '12¹⁺; Exp. '88, '89, '90,
'91+; P. '83, '95.

- Massachusetts.** Zoological and botanical survey, Commissioner of.
Report. N. D. '41: N. H. '41.
- Master** car builders' association. New York.
Proceedings. P. 1-6, 9, 11, 13-24, 26-37, 39+.
- Materia** medica or Pharmacology and therapeutics. Springfield. D. 1*.
- Mathematical** gazette. London, England. I. U. 1+: S. N. 4+.
- Mathematical** magazine. Washington, D. C. I. U. 1: W. 2.
- Mathematical** messenger. Ada, La.; Tyler, Tex. I. U. 4-7.
- Mathematical** monthly. Cambridge, Mass. I. U. 1-3: P. 1-3: R. P. 1-3.
- Mathematical** questions and their solutions. London, England. I. U. 1-75;
n. s. 1+.
- Mathematical** review. Worcester, Mass. I. U. 1*, 2*.
- Mathematical** visitor. Erie, Pa. I. U. 1, 2.
- Mathematico-physical** society of Tokyo, Japan.
Journal. I. U. '11.
- Mathematische** Annalen. Leipzig, Germany. R. P. 1+: P. 1+: I. U. 1+.
- Mathematische** und naturwissenschaftliche Berichte aus Ungarn. Budapest,
Hungary. Ac. 1-12, 14-26¹⁻³: I. U. 1+.
- Mathésis**, recueil mathématique. Ghent, Belgium. I. U. 1-17, 19+.
- Mechanics.** See **Engineering** mechanics.
- Mechanics.** N. D. 13, 14, 16, 18, 19.
- Mechanics'** magazine. London, England. N. H. 1-15, 19, 20.
- Mechanics'** magazine and register of invention and improvement. New York.
N. H. 1-4.
- Medical** adviser. London, England. N. H. 1-5.
- Medical** age. Detroit, Mich. D. 1*, 2*, 3*, 4-6, 7*, 8, 9*.
Continues from **Michigan** medical news *q. v.*
- Medical** and surgical journal. Edinburgh, Scotland. D. 33-36, 38-52.
Continued as **Medical** journal *q. v.*
- Medical** and surgical journal. London, England. D. 1-8.
- Medical** and surgical monitor. Indianapolis, Ind. I. U. 7+: S. N. 8-10.
- Medical** and surgical reporter. Burlington, N. J.; Philadelphia, Pa. D.
24*, 27*, 39*, 45*, 46*, 47, 57*, 58*, 62*: P. 50-53*.
- Medical** brief. St. Louis, Mo. D. 4*, 5-12, 13*, 14-19, 20*, 21*: P. 14-24*.
- Medical** gazette. New York. D. 8*, 9*, 10*.
- Medical** gleaner. St. Louis, Mo. D. 1.
- Medical** investigator. Bloomington, Ind. I. U. 1.
- Medical** journal. Edinburgh, Scotland. D. 1, 2*, 3, 5, 7, 8*, 9, 10, 11*, 12*.

- Medical** monitor. See **Central** states.
- Medical** news. Philadelphia, Pa. D. 31-35, 36*: I. U. 52-55: N. D. 27-30: N. H. 30*, 31*, 32*, 37*-39.
Vols. 1-37 were called **Medical** news and library; vols. 38-39 **Medical** news and abstract.
- Medical** news and library supplement. Philadelphia, Pa. D. 379-383.
- Medical** record. New York. Exp. 77+: I. U. 24, 25, 29-36, 43-56: M. 13-41.
- Medical** review of reviews. New York. Exp. 15, 16: P. 7-12*.
- Medical** science. See **Journal** of Medical science; also **Monthly** journal of medical science; also **Quarterly** journal of medical science.
- Medical** standard. Chicago, Ill. P. 17, 18*.
- Medical** world. New York; Philadelphia, Pa. D. 1*, 3*-6*, 7, 8, 9*: P. 8, 11, 13, 14*.
- Mennonitische** Rundschau. Scottsdale, Pa. Exp. 33*, 34*, 35*, 36*+.
- Merck's** bulletin. New York; London, England. P. 2-4*.
- Merck's** annual report on medical preparations. New York. N. D. 10+: P. 4, 6+.
- Meriden** (Conn.) scientific association.
Transactions. Ac. 1-6.
- Messenger** of mathematics. London; Cambridge, England. D. 1-22: I. U. n. s. 1-23: R. P. 1+: S. N. 26-36.
Continues **Oxford**, Cambridge and Dublin messenger of mathematics *q. v.*
- Metal** industry. New York. Ft. W. 2+.
- Metallographist**. Boston, Mass. See **Iron** and steel magazine.
- Metallurgical** and chemical engineering. New York. D. 2+: E. 7+: G. 7+: I. U. 1+: N. D. 3+: P. 1+: R. P. 1+*.
Vols. 1 and 2 have title **Electrochemical** industry and vols. 3-7 have title **Electrochemical** and metallurgical industry.
- Mexico**. Secretaria de fomento, colonizacion e industria de la Republica Mexicana. Mexico City.
Boletin del instituto geologico. Ac. 10-15.
- Mexico** City (Mexico). See **Museo** nacional.
- Mexico** (City) instituto medico nacional.
Anales. Ac. 11¹⁻³, 12^{1, 2}.
- Mexico**. Estacion agricola experimental de Ciudad Juarez.
Bulletin. Exp. 1+.
- Mexico** rubber planters' association.
Yearbook. Exp. '07, '08.
- Meyer** brothers' druggist. St. Louis, Mo. N. D. 23*-33*: P. 12, 15, 17, 18, 22, 28+.

Michigan academy of science. Lansing.

Bulletin. P. 1-3*.

Report. I. U. 7+: N. D. 1+: P. 1+: S. L. '94-'00, '02+.

Michigan agricultural college. Zoology and physiology, Department of.
Special bulletin. N. D. '12+.

Michigan. Agricultural experiment station. East Lansing.

Annual report. Exp. 1-5, 8+.

Bulletin. D. 45, 76, 125, 146-147, 218, 222-224, 232, 259-252, 258, +: Exp. 1+: N. D. 260, 267+: P. 1-144, 146+.

Elementary science bulletins. Exp. 1+: P. 1, 2, 4+.

Special bulletins. D. 7, 29, 32, 44, 54, 59+: Exp. 2, 4-5, 7+: P. 1+.

Technical bulletins. D. 5-7, 11+: Exp. 1+: P. 1+.

Michigan. Agriculture, State board of. Lansing.

Annual report. D. 15-17, 25, 26, 28-30, 35-37, 39, 49+: Exp. 3-7, 9-11, 14-20, 23-31, 33+: P. 6, 7, 10-14, 17-19, 23, 25-37, 39+: R. P. 25, 26, 28-30.

Biennial report. Exp. 1.

Continues **Michigan** (state) agricultural society *q. r.*

Michigan (state) agricultural society. Lansing.

Transactions. Exp. 1, 3-8, 11: P. '50, '52, '58, '59: S. L. '52, '57.

Continued by **Michigan.** Agriculture, State board of. *q. r.*

Michigan (state) association of farmers' clubs. Metamora.

Annual report. Exp. '05-'12.

Michigan. Dairy and food commissioner.

Report. P. '03, '05+.

Michigan dairy farmer. Detroit. Exp. 2*, 3, 4*, 5+.

Michigan dairymen's association.

Annual report. Exp. 7-9, 12: P. 15.

Michigan fish commission. Lansing.

Bulletin. Exp. 2.

Michigan engineering society.

Michigan engineer. P. 1-2, 4-5, 11-29: R. P. '94-'96.

Michigan. Forestry commission.

Report. Exp. '88: P. 1+*.

Michigan. Geological survey. Lansing.

Report. E. '01, '03-'06: N. D. '06: N. H. 1: S. N. '07.

Michigan. Health, State board of. Lansing.

Annual report. Exp. 4, 13-18, 20-22, 24-28: P. 1-33, 35+: R. P. '85.

Michigan (state) horticultural society. Lansing.

Annual report. D. 10-21: Exp. 10-16, 18-21, 36-41: P. 10-18, 40+: S. L. 10+.

Prior to 1880 known as the **Michigan** (state) pomological society *q. v.* The volume numbers of the reports are continuous.

Michigan. Live stock sanitary commission. Stanton.

Biennial report. Exp. 2-13.

Michigan (state) pomological society. Lansing.

Annual report. D. 3, 5-9||: Exp. 3-9||: P. 2, 6, 8, 9||: S. L. 1-9||.

In 1880 the society took the name of the **Michigan** (state) horticultural society *q. v.*

Michigan medical news. Detroit. D. 1*, 2*, 3*, 4, 5*.

Continued in **Medical age** *q. v.*

Michigan university. Clinical society.

Transactions. I. U. 1+.

Michigan university. Engineering society.

Technic. P. 2, 3, 5, 7-22.

Michigan university. Museum of natural history. Ann Arbor.

Report. S. L. '12.

Michigan university. Botany, Department of.

Bulletin. N. D. n. s. 7*.

Michigan (state) veterinarian. Lansing.

Biennial report. Exp. 6.

Microscope, The. Washington, D. C. N. D. 6*, 7, 8*-10*, 11, 12*; n. s. 1*, 2*, 3, 4*.

Microscopical bulletin and science news. Philadelphia, Pa. Ac. 6²⁻⁶, 7¹, 14², 15², 17¹, 18¹⁻²: N. D. 2*-8*, 9, 10, 11*, 1*, 24*.

Milchwirtschaftliches Zentralblatt. Leipzig, Germany. Exp. 6, 7, 41+.

Milch Zeitung. Leipzig, Germany. Exp. 18, 39, 40.

Milwaukee (Wis.). Public museum.

Reports. Ac. '98+.

Mind. London, England. B. n. s. 10+: I. U. o. s. 1-16; n. s. 1+: P. n. s. 17+: S. N. 1+: W. 5-18.

Mind and body. Milwaukee, Wis. G. 17+: I. U. 1-16, 18+: S. N. 1-13, 15+.

Mineral industry. New York. I. U. 1-6: P. 9-15: W. 12.

Mining and engineering world. New York. Ft. W. 38+.

Minnesota academy of natural sciences. Minneapolis.

Bulletins. Ac. 2¹⁻⁵, 3³: P. 3*.

- Minnesota.** Agricultural experiment station. St. Paul.
 Annual report. D. 12: Exp. '93+: P. '88, '94-'96, '98+.
 Biennial report. Exp. '88-'92.
 Bulletin. D. 39, 46, 51, 89-91: Exp. 1+: P. 1+.
- Minnesota** (state) agricultural society. Hamlin.
 Annual report. Exp. '00-'07, '09, '10.
- Minnesota** and Dakota farmer. Brooking, S. D. Exp. 3*, 4, 5*.
- Minnesota** dairymen's association.
 Annual report. Exp. '93, '01: P. 03, '04.
- Minnesota** (state) entomologist.
 Minnesota insect life. P. 1+.
- Minnesota.** Fire warden, Chief.
 Annual report. S. N. '99, '00, '02.
- Minnesota** (state) food and dairy commission. St. Anthony Park.
 Biennial report. Exp. 5, 7.
- Minnesota.** Forestry commissioner.
 Report. P. 1-2, 4-8, 11, 12, 14, 16.
- Minnesota.** Geological and natural history survey.
 Minnesota botanical studies. Exp. 1+: N. D. 1+: P. 1+.
 Minnesota plant studies. Exp. 1-4: N. D. 1+: P. 1+.
 Report. E. 1-5: N. D. 1, 3, 5, 8+: N. H. 4, 5, 8, 11: P. 1-4.
- Minnesota.** Health, State board of.
 Annual report. P. '74, '75, '78-'86.
- Minnesota** (state) horticultural society. St. Paul.
 Report or Transactions. D. '66-'73, '82-'85, '87-'89, '92-'94: Exp. '84
 '86-'89, '92, '95-'01: S. L. '92, '94, '95.
- Minnesota** northeast experiment farm.
 Report. Exp. '06.
- Minnesota.** Stallion registration board. St. Anthony Park.
 Bulletin. Exp. 1-3: P. 1+.
- Minnesota** university. Minneapolis.
 Minnesota botanical studies. Exp. 1+: N. D. 4+: S. N. 1, 2.
- Minnesota** university. Society of engineers.
 Yearbook. P. 1, 4, 5, 8-17.
- Minnesota** university. Sea side station.
 Postelsia. D. 1: I. U. 1, 2: P. 1, 2.

- Minnesota.** Waterways commission.
Reports. P. 1+.
- Miramichi** (New Brunswick) natural history society.
Proceedings. N. D. 4, 6+.
- Mississippi.** Agricultural experiment station. Agricultural college.
Annual report. D. 12, 13; Exp. 1+: P. 1-8, 10, 13, 15+.
Bulletin. D. 50, 66, 73, 76, 79-80, 83; Exp. 1-37, 39-45, 47, 49-84, 86-96
98-152. 15 +; P. 1+: S. L. '09-'10*.
Technical bulletins. Exp. 1, 2; P. 1+.
- Mississippi.** Geological survey.
Bulletin. P. 8.
- Mississippi** river power company.
Bulletin. N. D. 1-7.
- Mississippi** valley horticultural society.
Transactions. D. 1, 2; P. 1, 2.
See **American** horticultural society.
See **American** horticultural society.
- Missouri.** Agricultural experiment station. Columbia.
Annual report. Exp. '88, '96-'04, '10+; P. '96-'99, '01-'03.
Bulletin. D. o. s. 6; Exp. o. s. 1-8, 10-12, 14, 19, 21-24, 29-35; n. s. 1+
P. o. s. 4, 5, 24-35; n. s. 1+: S. L. '99-'11.
Research bulletin. Exp. 1+: P. 1+.
- Missouri** agricultural farmer. Columbia. Exp. 5*, 6, 7*, 8, 9*, 10+.
- Missouri.** Agriculture, State board of. Crescent.
Annual report. Exp. 16-20; R. P. '89-'90; P. 13, 15, 20, 35-41, 43+.
- Missouri** botanical garden. St. Louis.
Reports D. 5-8, 10+; E. 1-12, 14; Exp. 2+; G. 1-11; I. U. 1-21, 23+;
N. D. 1+; S. L. 1+.
- Missouri** (state) corn growers' association.
Annual report. Exp. '11.
- Missouri** farmer and breeder. Columbia. Exp. 2*, 3*.
- Missouri.** Food and drug inspection, Department of.
Bulletin. P. 3.
Report. P. '09-'10.
- Missouri** (state) fruit experiment station. Mountain Grove.
Biennial report. P. '03+.
Bulletin. Exp. 1-5, 7-8, 10+; P. 1, 5-21.
- Missouri.** Geological survey (organized 1853). Jefferson City.
Annual report. N. D. 1+; N. H. 1, 2; S. N. 10.

- Missouri.** Geology and mines, Bureau of.
Biennial reports to the general assembly. P. '01-'08.
Report. E II. 1-10; P. I. 3; II. 1+.
- Missouri.** Horticulture, State board of.
Annual report. Exp. 1-5; N. D. 1+; P. 1-3; S. L. '07, '09, '10.
- Missouri** (state) horticultural society.
Proceedings. Exp. 68-72.
Report. D. '83, '87, '90, '91, '95-'97; Exp. '80, '81 '83-'88, '89, '91, '93, '95, '97-'01, '06-'11; P. '80, '81, '83-'87, '92, '95, '99, '01-'06; S. L. '86, '94, '03, '04.
- Missouri** pharmaceutical association. St. Louis.
Proceedings. N. D. 10-'11.
- Missouri** university. Columbia.
Bulletin. Medical series. S. L. 1+.
Science series. N. D. 1+; P. 2+; S. L. 1*, 2*.
Studies. P. 1, 2; R. P. 1, 2.
Social science series. R. P. 1.
Science series. I. U. 1+; P. 1+.
- Mittheilungen** über düngungsversuche. Berlin, Germany. Exp. 1, 2.
- Modern** electric. Detroit, Mich. G. 5+.
- Modern** medicine. N. D. 2*.
- Modern** miller. St. Louis, Mo. Exp. 34*, 35*, 36+.
- Molkerei** Zeitung. Berlin, Germany. Exp. 20, 21*, 22+.
- Molkerei** Zeitung. Hildesheim. Exp. 25*, 27+.
- Monatshefte** für Mathematik und Physik. Vienna, Austria. I. U. 20+.
- Monde** des plantes. Le Mans, France. N. D. II. 14+.
- Monist.** Chicago, Ill. I. U. 1+.
- Moniteur** du jardin botanique de Tiflis (Russia). N. D. 25+.
- Montana.** Agricultural experiment station. Bozeman.
Annual report. D. 10, 11; Exp. 1+; N. D. 19; P. 1+; S. L. '02-'04, '06-'09, '11.
Bulletin. D. 52, 54, 55; Exp. 1+; P. 1+; S. L. '07+*.
- Montana** college of agriculture and mechanic arts. Bozeman.
Bulletin. N. D. 89+.
Science studies. N. D. 1; P. 1*.
- Montana** (state) entomologist. Bozeman.
Annual report. Exp. 1-9.

- Montana.** Health, State board of.
Biennial report. P. '11, '12.
Bulletin. P. '12+.
- Montana.** Horticulture, State board of. Missoula.
Biennial report. Exp. 1, 2, 4, 6: S. L. '00, '04, '06, '08.
- Montana** (state) horticultural society. Missoula.
Proceedings. Exp. 10, 12, 13.
- Montana.** Sheep commissioners, Board of.
Annual report. P. '09+.
- Montana** university. Missoula.
Bulletin biological series. P. 15.
- Montevideo** (Uruguay). See **Museo** nacional.
- Monthly** abstract of medical science. Philadelphia. D. 1*, 2, 3*, 4*, 5*: N. H. 1, 3*, 4, 6*.
Continued in **Medical news** *q. v.*
- Monthly** evening sky map. New York. M. 4+.
- Monthly** journal of medical science. Edinburgh, Scotland. D. 8-12, 14, 15.
- Monthly** microscopical journal. London. R. P. 1-18||; W. 1-18||.
Continued as **Royal** microscopical society, *Journal, q. v.*
- Montreal** (Can.) horticultural society.
Annual report. Exp. '77-'83, '85-'87.
- Morphologisches** Jahrbuch. Leipzig, Germany. I. U. 1+.
- Motor.** New York. Ft. W. 16, 18+: G. 19+.
- Muhlenbergia.** Reno, Nev. N. D. 5+.
- Münchener** medicinische Wochenschrift. Munich, Germany. I. U. 53+.
- Munich** (Germany). See **Königlich** bayerische etc.; **Ornithologische** Gesellschaft.
- Municipal** engineering. Indianapolis, Ind. G. 36+: N. D. 12, 14: P. 2+: R. P. 22-29, 33+.
Continues **Paving** and municipal engineering *q. v.*
- Municipal** journal and engineer. New York. Ft. W. 30, 32+: G. 34+: M. 10+: R. P. 28+.
- Museo** de la Plata. Buenos Aires, Argentine Republic.
Anales. Ac. II. 1^o, 2^o.
Revista. Ac. 11-17: N. D. 18+.
- Museo** de la Plata. La Plata, Argentine Republic.
Anales. Seccion paleontologica. Ac. 5.
Seccion botanica. Ac. 1.

- Museo nacional.** Buenos Aires, Argentine Republic.
 Anales. Ac. III. 4+.
 Comunicaciones. Ac. 1³⁻⁵.
- Museo nacional de historia natural.** Mexico City, Mexico.
 La naturaleza. Ac. 7³⁻⁵; II. 1³⁻⁵; 3, 6, 3, 3, 2³⁻⁵; 3³⁻⁵; III. 1³⁻⁵; N. D.
 III. 1³⁻⁵.
- Museo nacional.** Mexico City, Mexico.
 Anales. Ac. 4³⁻⁵.
- Museo nacional.** Montevideo, Uruguay.
 Anales. Ac. 2, 3; II. 1³, 4³; N. D. 7-.
- Museu Goeldi de historia natural et ethnographia.** Para, Brazil.
 Boletin. Exp. 4-6; N. D. 6-; P. 4*, 5*.
- Museu nacional.** Rio Janeiro, Brazil.
 Archives. Ac. 11-15.
- Museu paulista.** Sao Paulo, Brazil.
 Revista. Ac. 4-8.
- Museum news.** Brooklyn, N. Y. S. L. 3-.
- Muséum national d'histoire naturelle.** Paris, France.
 Annals. N. H. 1.
 Archives. I. U. 5.
 Bulletin. Ac. 11+.
- Museum of foreign literature, art and science.** Philadelphia, Pa. N. H.
 19-20, 22-23, 39, 47-48, 56-57, 65; W. 2, 4-7, 12, 23-24.
- Museum of natural history.** Springfield, Mass.
 Reports. Ac. '95, '96, '08, '10-'12.
- Mycologia.** Lancaster, Pa. D. 1-; Exp. 1-; I. U. 1-; S. N. 1-; W. 1-2.
- Mycologisches Centralblatt.** Jena, Germany. Exp. 1+.
- Mysore.** Agriculture, State department of. Bangalore.
 Bulletin. Exp. 1, 2.
 Entomological series. Exp. 1, 2.
 General series. Exp. 1, 2.
 Mycological series. Exp. 1.
 Report of the agricultural chemist. Exp. 2-7, 9.
- Naples (Italy).** See **Zoologische Station.**
- Napoli (Italy) Università.** Orto botanico.
 Bullettino. N. D. 1+.
- Nashville (Tenn.) journal of medicine and surgery.** N. H. 9-11, 12*.
- Nassauischer Verein für Naturkunde.** Wiesbaden, Germany.
 Jahrbucher. Ac. '99+.

- Natal** (South Africa) agricultural journal. Maritzburg. Exp. 7-9, 11-13, 14*, 15*.
- Natal** (South Africa). Agriculture, Department of. Maritzburg.
Annual report. Exp. '02, '04-'06.
- Natal** (South Africa). Entomologist.
Report. Exp. 1, 2, 5.
- National** academy of sciences. Washington, D. C.
Annual. P. '63-'66.
Biographical memoirs. I. U. 2, 3, 5+: P. 6: T. H. 2-5.
Memoirs. I. U. 2+: N. D. 8*, 10*: N. H. 6, 8: P. 1+: R. P. 10+: S. L. 2-10: S. N. 3, 10+: W. 1+.
Report. P. '63, '82+: S. N. '83-'89, '91, '94, '03, '07.
- National** association of boards of pharmacy.
Proceedings. N. D. '11: P. 5+.
- National** builder. Chicago, Ill. N. H. 44+.
- National** conservation association.
Bulletin. P. 3.
- National** conservation commission.
Bulletin. P. 4.
- National** conservation congress.
Addresses and proceedings. S. L. '09-'11.
- National** creamery buttermaker's association. Elgin, Ill.
Annual report. Exp. '00, '02.
- National** dairy union. Chicago, Ill.
Annual report. Exp. '94.
- National** druggist. St. Louis, Mo. P. 18-22, 24, 26-31, 36+.
- National** eclectic medical association. Rochester, N. Y.
Transactions. S. L. '70, '71.
- National** electric-light association. New York.
Proceedings. P. '85-'90, '91, '93+.
- National** engineer. Chicago, Ill. S. L. 14*, 15+.
- National** farmer and stockgrower. St. Louis, Mo. Exp. 21-26.
- National** fertilizer associations. Middle west soil improvement committee.
Chicago, Ill.
Bulletin. Exp. 1-5.
- National** fruit grower. St. Joseph, Mich. Exp. 10*, 14*.
- National** geographic magazine. Washington, D. C. E. 15+: Ft. W. 18*, 19+: G. 17+: I. U. 8, 10-14, 16+: M. 20+: N. D. 18+: P. 18+: S. N. 1+: T. H. 7+.

- National** hay and grain reporter. Chicago, Ill. Exp. 14*, 15+.
- National** hay association.
Annual report. Exp. 9-11.
- National** grange of the patrons of husbandry. Tippecanoe City, O.
Circulars. Exp. 1, 3-7.
Journal of proceedings. Exp. '07, '09, '10.
- National** irrigation congress.
Proceedings. S. L. '91+: S. N. 12.
- National** live stock association.
Annual report. Exp. '98+: P. 2, 5-6, 8+.
- National** live stock journal. Chicago, Ill. Exp. 3*, 5, 6*, 7, 8*, 10-12: S. L. '71-'88.
- National** museum. Melbourne, Australia.
Memoirs. Ac. 1-3.
- National** nurseryman. Rochester, N. Y. Exp. 15*, 16, 17*, 18, 19*, 20+.
- National** nut growers' association. St. Louis, Mo.
Proceedings. Exp. 2, 3, 5, 6, 8.
- National** poultry organization society. London, England.
Quarterly journal. Exp. 4*, 5*, 6*, 7+.
- National** stockman and farmer. Pittsburg, Pa. Exp. 18-20, 32*, 33+.
- Naturae** novitates. Berlin, Germany. N. D. 27*, 29*, 32*, 34+.
- Natural** history society of Glasgow (Scotland).
Transactions. Ac. 5², 3, 6¹, 2, 7³, 8².
- Natural** history society of New Brunswick. St. Johns, New Brunswick.
Bulletin. Ac. 4⁵, 5¹, 5, 6¹⁻³: N. D. 6+.
- Natural** science. London and New York. D. 1: I. U. 1-15||: S. N. 1-15||.
- Naturalist**. London, England. N. D. '96-'98, '00.
- Naturaliste** canadien. Quebec, Canada. Ac. 24⁶⁻⁹, 12, 25-28, 29¹⁻³, 5-12, 30, 31, 32¹⁻³, 8-10, 12, 33-35, 36¹, 2, 4-11, 37, 38¹⁻⁴, 6, 5-12, 39¹⁻⁹: N. D. 7, 9, 10-13, 15-17, 20, 21, 23, 24, 26, 36+.
- Nature**. London and New York. B. 13-46, 48+: D. 37+: Exp. 39, 40*, 41, 86+: F. 50-58: I. U. 1+: N. D. 53-71: N. H. 1-50: P. 1+: R. P. 1+: S. N. 1+: T. H. 1+: W. 1+.
- Nature**. Paris, France. R. P. 1+.
- Nature** notes. London, England. N. D. 8.
- Nature** study review. New York. F. 6+: G. 1+: N. D. 5+: P. 4+: S. N. 1+: W. 1+.
- Naturen**. Bergen, Norway. N. D. 37+.

Naturforschende Gesellschaft. Basel, Switzerland.

Verhandlungen. Ac. 8³, 9^{1, 2}, 10^{1, 2}, 11-19, 20¹⁻³, 21, 22.

Naturforschende Gesellschaft. Bern, Switzerland.

Mittheilungen. Ac. 1073, 1769.

Naturforschende Gesellschaft. Luzern, Switzerland.

Mittheilungen. I. U. 1, 2.

Naturforschende Gesellschaft in Zurich (Switzerland).

Vierteljahrschrift. Ac. 43¹⁻⁴, 44^{1, 2}, 45+: N. D. 57+.

Naturforschender Verein in Brunn (Austria).

Verhandlungen. N. D. 4†.

Naturfreund. St. Petersburg, Russia. N. D. '12+.

Naturhistorische Gesellschaft zu Hannover (Germany).

Jahresbericht. Ac. 44-59.

Naturwissenschaftlich medizinischer Verein in Innsbruck (Austria).

Berichte. Ac. 14, 15, 17, 18, 27-33.

Naturwissenschaftlicher Verein zu Bremen (Germany).

Abhandlungen. Ac. 14³, 15^{2, 3}, 16¹⁻³, 17^{1, 2}, 18^{1, 2}, 19³, 20^{1, 2}, 21+: N. D. 21+.

Naturwissenschaftlicher Verein. Frankfort-on-the-Oder, Germany.

Helios. N. D. '13+.

Naturwissenschaftlicher Verein in Hamburg (Germany).

Abhandlungen. Ac. 19²⁻⁵.

Verhandlungen. Ac. III. 10-18.

Naturwissenschaftlicher Verein für Schwaben und Neuburg. Augsburg, Germany.

Berichte. Ac. 33-40.

Natürkundig Tijdschrift. See **Koninklyke** natuurkundige Vereeniging in Nederlandsch-Indie.

Nautilus. Boston, Mass. N. D. 15+.

Nebraska. Agricultural experiment station. Lincoln.

Annual report. Exp. 1+: N. D. 26+: R. P. 16, 19, 21, 23: S. L. '91+*.

Bulletin. D. 19, Exp. 1, 2, 4-45, 46*, 47-132, 134+: N. D. 123-130, 135+:

R. P. 38+: S. L. '91+*.

Research bulletin. D. 1: Exp. 1: N. D. 1+: P. 3.

Nebraska. Agriculture, State board of. Lincoln.

Annual report. Exp. '83-'91, '93-'03, '05-'10.

Nebraska dairymen's association.

Annual report. Exp. 11, 15, 17-25.

† Contains Gregor Mendel's original paper on plant hybrids.

Nebraska farmer. Lincoln. Exp. 42*, 43*, 44*, 45+.

Nebraska. Farmers' institute convention. Lincoln.

Annual report. Exp. '06, '09.

Nebraska (state) horticultural society. Lincoln.

Annual report. Exp. '85, '86, '89-'93, '95, '97, '00+: F. '72: P. '11+: S. L. '89, '90, '92-'98.

Nebraska horticulture. Lincoln. Exp. 1*, 2*, 3+.

Nebraska university. Lincoln.

Studies. I. U. 3, 4: N. D. 8, 10, 11+: P. 1-4*: R. P. 2+.

Neues Jahrbuch für Mineralogie, Geologie, und Palaeontologie. Stuttgart, Germany. I. U. 9+.

Beilage. I. U. 6-32.

Neurologisches Centralblatt. Leipzig, Germany. I. U. 1+.

Nevada. Agricultural experiment station. Reno.

Annual report. Exp. 1+: P. 4, 5, 14, 16+.

Bulletin. D. 28, 35: Exp. 1+: P. 1-11, 13+: S. L. '08*, '09*.

Nevada. Health, State board of.

Biennial report. P. '03+.

Nevada public service commission. Carson City.

Report. N. D. 2+.

Nevada railroad commission. Carson City.

Report. N. D. 5+.

Nevada university. Reno.

Studies. I. U. 1+: P. 1+.

New Albany (Ind). medical herald. P. 15, 16*.

New England association of chemistry teachers.

Annual report. Exp. 28.

New England farmer. Boston. S. L. 1-14.

New England zoological club. Cambridge, Mass.

Proceedings. Ac. 1¹⁻³⁷. 59-64.

New Hampshire. Agricultural experiment station. Durham.

Annual report. Exp. 1-4, 6+: P. 2+.

Bulletin. D. 23: Exp. 1+: N. D. '13+: P. 1+: S. L. '10+.

Nature leaf study. Exp. 1-4.

Scientific contributions. Exp. 1+: N. D. 5+: P. 1+.

Technical bulletin. Exp. 1+: P. 2-6.

New Hampshire (state) agricultural society.

Transactions. Exp. '50-'52, '55-'58: S. L. '50-'52, '57-'59.

- New Hampshire.** Agriculture, State board of. Concord.
Annual report. Exp. 5, 7, 9-16: P. 2, 5-18, 21+.
- New Hampshire.** Forestry commission.
Report. P. '85, '99, '01-'04, '09+.
- New Hampshire** forests, Society for the protection of.
Report. P. 7, 8.
- New Hampshire.** Health, State board of. Concord.
Annual report. P. '84, '85, '87-'06.
Sanitary bulletins. Exp. 5*.
- New Hampshire** horticultural society. Durham.
Annual report. Exp. '07, '08: P. '07+.
- New Jersey.** Agricultural experiment station. New Brunswick.
Annual report. Exp. 1-29, 31+: P. 1+.
Bulletin. Exp. 2-244, 246+: P. 11, 14, 19 20, 22-24, 26, 27, 29-36, 38+:
S. L. '98-'02*.
Reports of the soil chemist and bacteriologist. Exp. '92, '06-'09.
Special bulletin. Exp. A-R, T: P. A, C, E, G, I-T.
- New Jersey.** Agriculture, State board of. Trenton.
Annual report. Exp. 6, 15.
- New Jersey.** Forest Park reservation commission.
Report. P. 1+.
- New Jersey.** Geological survey.
Annual report. E. '84-'90, '92-'09, '11+: N. D. '84-'90, '93+: N. H.
1, 2: R. P. '69-'71, '75, '77-'82, '85-'90: S. N. '88-'95.
Bulletin. N. D. 3+: R. P. 2+.
Final report of the state geologist. E. 2-4: N. D. 5, 7+.
Water supply report. N. D. '94.
- New Jersey.** Health, State board of. Trenton.
Annual report. Exp. 22-35: P. 11, 20+.
- New Jersey** (state) horticultural society. Riverton.
Report. Exp. 12-14, 19, 32-36: P. 27-29.
- New Jersey** (state) live stock commission. New Brunswick.
Annual report. Exp. 1, 2.
- New London** Mechanics' register and magazine of science and the useful arts.
London, England. N. H. 1, 2.
- New Mexico.** Agricultural experiment station. Mesilla Park.
Annual report. Exp. 1+: P. 1+.
Bulletin. Exp. 1+: N. D. 3, 13, 29, 30, 44, 56, 59+: P. 1+.

New Mexico university. Albuquerque.

Bulletin. Biological series. Ac. 3^{12, 13}, 4¹.

Catalogue series. Ac. 16-18, 20.

Educational series. Ac. 1^{3, 4}.

Geological series. Ac. 3¹.

Language series. Ac. 1^{1, 2}.

Physics series. P. 1*.

New Orleans (La.). Sewerage and water board.

Report. P. 15+.

New phytologist. London, England. Exp. 10+: I. U. 4-8, 10+.

New preparations. Detroit, Mich. D. 1*, 3.

Continued as **Therapeutic gazette** *q. v.*

New remedies. New York. D. 5, 6*: P. 7-12||: R. P. 1, 2.

Continued as **American druggist and pharmaceutical record** *q. v.*

New South Wales agricultural gazette. N. D. 24+: P. 16+.

New South Wales. Agriculture, Department of. Sydney.

Bulletin. Exp. 1-4.

Farmers bulletin. Exp. 4-6, 11-13, 15-17, 19, 20, 27-31, 33, 35, 36, 38-40, 43, 45-47, 59, 62+.

Science bulletin. Exp. 1-6, 8: N. D. 7.

New South Wales. Agriculture and forests, Department of. Sydney.

Annual report. Exp. '94, '95, '98, '00, '07.

New South Wales. Botanic gardens and government domains. Sydney.

Annual report. Exp. '07-'11.

New South Wales. Geological survey.

Mineral resources. S. L. 6+.

New South Wales. Mines and agriculture, Department of. Sydney.

Annual report. Exp. '95.

New York City. See **American institute**; **Central Park managerie**.

New York (city) academy of medicine.

Transactions. P. II. 3-10.

New York (city) academy of sciences. New York.

Annals. Ac. 3^{9, 10}, 4^{1-8, 10-12}, 5-9, 10¹⁻¹², 11, 13¹⁻³, 14¹⁻⁴, 15¹⁻³, 17+.

Transactions. Ac. 2¹⁻⁸, 3, 4, 5¹⁻⁸, 6-8, 9¹⁻⁸, 10¹⁻⁶, 11³⁻⁵.

New York (state). Agricultural experiment station. Geneva.

Annual report. Exp. 1+: N. D. 1, 2, 3: P. 1+.

Bulletin. D. n. s. 86, 94, 100, 101, 119, 120, 122-125, 130, 131, 133, 136, 138-140, 143, 144, 159, 161-164, 167, 170, 172: Exp. 1+: P. 1+.

- Meteorological observatory. Exp. '71-'80, '89, '90, '92*, '93*, '95*, '97*, '04*, '05, '06, '07*, '08*, '09, '10, '11, '12*+.
- Technical bulletin. Exp. 1+: P. 1+.
- New York** (state). Agricultural experiment station (Cornell). Ithaca.
Annual report. Exp. 1-10, 12+: P. 1-5, 7-15, 16+.
Continued in *Medical news* *q. v.*
- Bulletin. D. 142, 148, 155, 157, 163, 164, 168, 170, 172, 176, 180, 185-187, 190, 192, 193, 207, 208, 219, 227, 233, 234, 239, 240, 249-251, 254, 255: Exp. 1-318, 321, 323, 326+: N. D. 94, 227: P. 1+.
- Cornell rural school. Exp. 1*, 2+.
- Memoirs. P. 1+.
- New York** (state) agricultural society. Albany.
Transactions. D. 9, 27: Exp. 8-13, 15-34, 43-46, 51-52: P. 10, 14, 25-27, 29, 30, 32-34, 57-59.
- New York** (state). Agriculture, Department of. Albany.
Annual report of the commissioner. Exp. 2*, 3-10, 15-19: N. D. '11: P. 5-7, 9, 11, 12, 15+.
- Bulletin. Exp. 1, 2, 6, 9, 12, 14, 18, 21-29: P. 8, 9, 12-14, 16-18, 20-27, 29-35, 37-39, 41, 45+.
- New York** (state). Barge canal. See **New York** (state). Consulting engineers, Advisory board of.
- New York** (city) botanical garden. New York.
Bulletin. Ac. 7+: Exp. 1+: N. D. 21.
Contributions. P. 90, 95.
Journal. Exp. 1, 2, 3: P. 3.
Memoirs. I. U. 4.
- New York** (state) college of agriculture. Ithaca.
Bulletin. N. D. 2, 12, 29, 37, 41, 42, 226, 229, 307.
- New York** (state). Consulting engineers, Advisory board of.
Bulletin. R. P. 1+.
Report on barge canal. P. 1, 3+: R. P. '07.
- New York** (state). Dairy commission. Albany.
Annual report. Exp. 4, 6-8: P. 7, 9.
- New York** (state) dairymen's association.
Annual report. Exp. 6, 9, 11, 13, 30-34.
- New York** eclectic medical and surgical journal. New York. D. 5*, 6, 7, 8*.
- New York** (state) engineer and surveyor.
Annual report. P. '00-'04: R. P. '03, '05+.

- New York** (city) entomological society. New York.
Journal. Ac. 8¹, 3, 4, 9¹⁻⁴, 10¹⁻².
- New York** (state) entomologist.
Report. Exp. 1, 2, 4-26: P. 1-2, 4-13, 15-26.
- New York** (state) farmers. New York.
Proceedings. Exp. '82-'13: S. L. '93+.
- New York** (state) farmers' institute. Albany.
Annual report. Exp. '00, '01, '07-'10: P. '01, '03-'05, '07+.
- New York** (state). Forest commission. Albany.
Annual report. Exp. '94.
- New York**. Forest, fish, and game commission. Albany.
Annual report. Exp. '98, '07-'10: N. H. 1-6: P. '02-'06.
Bulletin. P. 2, 3, 5.
- New York**. Forest preserve board.
Annual report. N. H. 4.
- New York** (state) fruit growers' association.
Annual report. Exp. 4-6, 8-10, 12+.
- New York** (state). Geological survey.
Annual report. P. 4-6, 9: R. P. '83.
- New York** (city). Health department. Research laboratory.
Annual. P. '02+.
Collected studies. I. U. 1+.
- New York** (state). Health, Board of.
Annual report. P. '80-'05, '07+: R. P. '90.
Monthly bulletin. P. '07+.
- New York** (city) mathematical society. New York.
Bulletin. D. 1-3||: I. U. 1-3||: P. 1-3||.
Continued as **American** mathematical society *q. v.*
- New York** medical journal. New York. D. 12, 13, 14*, 15*, 16*, 17, 18*,
19-25: I. U. 78: P. 51-63, 74, 79-86*: T. H. 41-54, 67-70, 90+.
- New York** (city) microscopical society. New York.
Journal. Ac. 1¹, 4-9, 2¹, 4-7, 9, 9a, 3, 4¹⁻⁴, 5¹⁻⁵, 6²⁻⁴, 7¹, 2, 4.
- New York** state museum. Albany, N. Y.
Annual report. Exp. '94, '95*, '96, '97*, '98: I. U. 22, 23, 39, 41, 45-62:
P. 20, 27-28, 41-43, 49*+: R. P. 13, 15-31.

Bulletin. D. 38, 47, 54, 67, 68, 70, 75, 86, 94, 105, 116, 429, 450: Exp. 5, 13, 20, 23, 26, 27, 31, 36, 37, 46, 47, 53, 59, 64, 72, 74, 76, 79, 86, 97, 103, 104, 109, 110, 124, 129, 134, 136, 141, 147, 155, 156: I. U. 44, 69, 80, 85: N. D. 158, 450, 470, 492, 493, 495, 496, 514+: P. 40, 49-62, 64+.

Memoirs. N. D. 14*.

New York produce review and American creamery. New York. Exp. 23*, 29*, 30*, 31*, 34+.

New York (state). Public service commission—First district. New York City.

Report. P. '07+: R. P. '08+.

New York (state). Public service commission—Second district. Albany.

Report. N. D. 6+: P. '07+.

New York railroad club.

Proceedings. P. '88+*: R. P. 11, 12.

New York (state) science teachers' association.

Proceedings. S. N. '07+.

New York state reservation commission of Niagara. Albany, N. Y.

Report. N. D. 1-14, 17, 20+.

New York tribune farmer. New York. Exp. 9*, 10*, 11*, 12+.

New York (state) veterinary college. Ithaca.

Abstracts of work done in laboratory. P. 1+.

Report. Exp. '08-'11.

New York (state). Weather bureau.

Annual report. R. P. '93-'96.

New York (state). Water supply commission.

Annual report. P. 4+.

Contract drawings and specifications. R. P. 1+.

New Zealand. Agriculture, Department of. Wellington.

Annual report. Exp. 2-4, 7+: P. 13+.

Bulletin. Exp. n. s. 1-6, 8, 9, 11-15, 17, 20, 21, 23+.

Journal. Exp. 1+.

New Zealand. Biology, Division of. Wellington.

Bulletin. Exp. 13, 14, 20, 22, 23.

New Zealand. Biology and horticulture, Division of.

Annual report. Exp. 12-17: P. '02-'09.

Bulletin. Exp. 3-19.

Technical papers. Exp. 1.

New Zealand. Biology and pomology, Division of.

Annual report. Exp. 4, 5, 8, 10.

- New Zealand.** Chemistry, Division of.
 Annual report. Exp. '03, '05, '07, '09.
 Bulletin. Exp. 1, 2.
- New Zealand.** Dairying, Division of.
 Annual report. Exp. '94, '95, '04, '05.
 Bulletin. Exp. 7-14.
- New Zealand.** Live stock and meat, Division of.
 Annual report. Exp. '10.
- New Zealand.** Poultry, Division of.
 Annual report. Exp. '06.
- New Zealand.** Veterinary science, Division of.
 Bulletin. Exp. 8, 12, 13, 15.
- New Zealand** dairyman farmers' union. Wellington.
 Journal. Exp. 13*.
- New Zealand** experimental station. Wellington.
 Annual report. Exp. '05, '08, '09.
- Niles** national register. Washington, D. C. N. H. V. 4-11.
- Norske** videnskabers selskab. See **Kongelige** norske, etc.
- North American** notes and queries. Quebec, Canada. Ac. 1¹-2.
- North Carolina.** Agricultural experiment station. West Raleigh.
 Annual report. Exp. 2+: P. 2-6, 7, 9+: R. P. 16-19, 23, 26-29.
 Bulletin. D. 93, 94, 99, 100, 103, 105, 108, 138, 141, 144, 145, 174: Exp.
 57+: P. 57+: R. P. 23-31, 93-194.
 Meteorological reports. Exp. 5-9: P. 4, 7-8.
 Special bulletins. Exp. 2, 6, 7, 9, 11, 12-15, 17, 19-22, 25-27, 29, 32, 35, 37,
 38, 42-46, 51+.
 Technical bulletins. Exp. 1-7: P. 2-7.
- North Carolina.** Agriculture, State board of. Raleigh.
 Bulletin. Exp. 21*, 22, 23*, 24*, 25*, 26*, 27*, 28*, 29*, 30-32, 33*, 34+:
 P. 23+.
- North Carolina.** Crop pest commission. Raleigh.
 Circular. Exp. 10, 11, 18, 19, 22, 23, 25, 26.
- North Carolina** farmers' institute. Raleigh.
 Annual report. Exp. '05-'07, '09, '11, '12.
- North Carolina.** Geological and natural history survey.
 Report. N. D. '67.
- North Carolina.** Health, State board of. Raleigh.
 Bulletin. Exp. 2*, 3*, 4*, 16*.

- North Carolina** student farmer. West Raleigh. Exp. 1*, 2*.
- North Dakota.** Agricultural experiment station. Fargo.
 Annual report. Exp. 1+: P. 1-9, 11+.
 Biennial report. Exp. 7+.
 Bulletin. D. 52: Exp. 1+: N. D. 87-89, 91, 94+: P. 1+.
 Reports Dickinson sub-experiment station. Exp. 1+.
 Reports Williston sub-experiment station. Exp. 1+.
- North Dakota.** Agriculture and labor, Commissioner of. Bismarek.
 Biennial report. Exp. 5, 7: P. 10+.
 North Dakota magazine. P. 2*, 4*.
- North Dakota** better farming association.
 Bulletin. Exp. 10, 12.
- North Dakota** (state) dairymen's association.
 Annual report. Exp. 1, 16.
- North Dakota.** Geological survey.
 Biennial report. I. U. 4+: P. 2+.
- North Dakota** (state) live stock association.
 Annual report. Exp. 1-3.
- North Dakota** school of forestry.
 Bulletin. P. 1.
- North Dakota.** Stallion registration board.
 Bulletin. P. 1+.
- North Dakota** university. Fargo.
 Quarterly journal. N. D. 1, 2*, 3+: P. 1.
- North Jersey** society for the promotion of agriculture.
 Proceedings. Exp. '11, '12.
- Northwest** fruit growers' association.
 Proceedings. Exp. 7, 8.
- Northwest** horticulturist. Seattle, Wash. Exp. 20*, 21*, 22, 23, 24*, 25+.
- Northwestern** agriculturist. Minneapolis, Minn. Exp. 23*, 24*.
- Northwestern** dairyman. St. Paul, Minn. Exp. 1*, 2, 3*.
- Nouvelles annales de mathématiques.** Paris, France. I. U. 9+.
- Nova Scotia** farmers' association.
 Proceedings. Exp. 14, 15.
- Nova Scotian** institute of natural science. Halifax.
 Proceedings and transactions. Ac. 7-11, 12¹⁻², 13¹⁻²
- Nuova notarisia.** Modena, Italy. N. D. 24+.
- Nuovo giornale botanico italiano.** Florence, Italy. N. D. '12+.

- Nut grower.** Waycross, Ga. Exp. 1*, 2*, 3*, 4*, 5*, 7-11, 12*+.
- Nyt** magazin for natur videnskaberne. Christiania, Norway. N. D. 49+.
- Nyt Tidsskrift für Mathematik.** Copenhagen, Denmark. 1. U. 21+.
- Oberlin** (O.) college.
 Laboratory bulletin. Exp. 1-6, 8-10: P. 3, 11-15.
 Wilson bulletin. Ac. 14+: Exp. 4-12, 14-29: P. 14+.
- Observatory.** London, England. D. 8+: I. U. 7, 11-14, 23+: W. 16, 19, 21, 22.
- Observer.** Portland, Conn. N. D. 2*, 3, 4*-8*.
 Continued as **Popular science news** *q. v.*
- Obstetric gazette.** Cincinnati, O. D. 1*, 2*, 3, 4*, 5, 6, 7*, 8, 9: P. 10-12*.
- Obstetrical journal of Great Britain and Ireland with an American supplement.**
 Philadelphia, Pa. D. 5*, 6*: N. H. 1-7.
- Ohio** (state) academy of science. Columbus.
 Annual report. Ac. '00-'06: I. U. 5.
 Proceedings. N. D. 5*.
 Special papers. Ac. 3-13.
- Ohio** (state) agricultural college. Columbus.
 Agricultural extension bulletins. Exp. 1*, 2*: N. D. 1*, 2*+.
 University bulletin. Exp. 6*, 8*, 15*, 17*: N. D. 8*+.
- Ohio** agricultural station. Columbus
 Bulletin. S. L. '97*+.
- Ohio.** Agricultural experiment station. Wooster.
 Annual report. Exp. 1+: P. 1+.
 Bulletin. D. II. 3, 5-7, 12, 19-22, 25, 28-47, 49, 51-60, 62-70, 72-74, 76-88,
 90, 91, 93-109, 111-122, 124-148, 150-155, 157-215, 218-224, 226-237,
 240-248, 250+: Exp. 1-40, 42-238, 240-248, 250-252, 256+: P. 1+.
 Technical series. Exp. 1*: P. 1.
- Ohio.** Agriculture, State board of.
 Annual report. D. 33: Exp. II. 6, 9, 12-52, 54, 57, 59-61: P. 5, 6, 18, 21-29,
 31, 33-36, 55, 56, 58-63.
 Official bulletin. P. 1-3.
- Ohio** cultivator. Columbus. S. L. 1, 2, 6, 10, 11.
- Ohio.** Dairy and food commissioner. Springfield.
 Annual report. Exp. 10, 18.
- Ohio** (state) dairymen's association.
 Annual report. Exp. 7, 13.
- Ohio** engineering society.
 Proceedings. P. 4-10, 12-13, 15-22, 25-28.
 21—1019

- Ohio farmer.** Cleveland. Exp. 123, 124*, 125, 126*, 127+: S. L. 37-112.
- Ohio.** Farmers' institutes. Columbus.
Annual report. Exp. 6, 17: P. 7-17.
- Ohio** (state) forestry bureau.
Report. 2, 3, 5: I. U. 3, 4: P. 4.
- Ohio.** Geological survey.
Bulletin. P. IV. 1+: R. P. 1+.
Report. D. 1-4, 6, 7: E. 1-3, 7: N. D. 2: R. P. '69, '70, '73-'75: T. H. 1-4, 6.
Report. (Third organization.) E. 1: I. U. 1-6, 9-13, 16+.
- Ohio.** Health, State board of. Columbus.
Annual report. Exp. 22: P. '86-'88, '91-'94, '96, '99+.
- Ohio.** Highway department.
Annual report. P. '00-'10.
- Ohio** (state) horticultural society. Columbus.
Report. Exp. 23, 24, 29, 32-34: S. L. '90, '91, '94-'96.
- Ohio mechanics' institute.** Cincinnati.
Quarterly journal. P. 1-5.
- Ohio medical journal.** Columbus, O. D. 1*.
Continued as **Columbus** medical journal *q. r.*
- Ohio medical recorder.** Columbus, O. D. 1*, 2*, 3*, 4*, 5.
- Ohio naturalist.** Columbus, O. Exp. 1+: N. D. 1+.
- Ohio** (state) railroad and public utilities commission. Columbus.
Report. N. D. '12+
- Ohio society of surveyors and civil engineers.**
Annual report. R. P. '94.
- Ohio** (state) topographic survey.
Report. P. '03.
- Oil, paint and drug reporter.** New York. Exp. 64+.
- Oklahoma academy of science.** Norman.
Proceedings. Ac. '09, '10.
- Oklahoma.** Agricultural experiment station. Stillwater.
Annual report. Exp. 1+: P. 3, 6, 8+: S. L. '00-'06*.
Bulletin. Exp. 1-98, 100+: P. 1+: S. L. '99-'09*.
- Oklahoma.** Agriculture, State board of. Guthrie.
Biennial report. Exp. 1: P. 1, 2.
- Oklahoma.** Agriculture, Territorial board of. Guthrie.
Biennial report. Exp. 1, 2: P. 2.

Oklahoma (state) dairymen's association.

Annual report. Exp. 1, 3, 4.

Oklahoma farm journal. Oklahoma City. Exp. 18, 19*, 20+.

Oklahoma (state). Geological survey.

Bulletin. I. U. 7, 8: P. 1-2, 5+.

Circular. P. 1+.

Oklahoma university.

Research bulletins. N. D. 1+: P. 1+.

Ontario. See also **Canada** horticultural societies; **Poultry** association of Ontario; **Vegetable** growers' association.

Ontario agricultural and experimental union. Toronto.

Annual report. Exp. 19+: P. 8-10, 19+: S. L. '04+.

Ontario agricultural college and experimental farm. Toronto.

Annual report. Exp. 5-13, 16-22, 24+: P. 7, 8, 10, 12, 14, 18-26, 28+: S. L. '04+.

Bulletin. Exp. 6, 9, 11-13, 15-17, 19-21, 23-32, 36-41, 43, 48-75, 77, 80-88, 90-95, 97-105, 107-140, 142-169, 171, 172, 174-184, 186-209, 211+.

Ontario agricultural societies and associations of fairs and exhibitions. Toronto.

Annual report. Exp. '02, '06, '08+: P. '08+.

Ontario. Agriculture, Department of. Toronto.

Annual report. Exp. '88-'93, '94*, '95-'04, '08, '09.

Bulletin. S. L. '96+*.

Report of fruit branch. P. '08+.

Ontario bee keepers' association. Toronto.

Annual report. Exp. '00, '02-'08, '11+: P. '08-'10.

Ontario butter and cheese association. Toronto.

Annual report. Exp. '97-'99.

Ontario corn growers' association. Toronto.

Annual report. Exp. 1+: P. 1+.

Ontario dairymen's association. Toronto.

Annual report. Exp. '92, '94, '96, '01+: P. '92+.

Ontario entomological society. Toronto.

Annual report. Exp. 17, 27, 28, 30+: P. 9, 12, 20, 22-24, 27-32, 37+.

Ontario. Farmers' institutes, Superintendent of.

Report. Exp. '91+: P. '94+.

Ontario. Fruit experiment station.

Annual report. Exp. 6+: P. 1+.

Report of fruit branch. Exp. 1+: P. 1+.

- Ontario** fruit growers' association. Toronto
Annual report. Exp. 32-40, 42+: P. 14+.
- Ontario.** Horticultural societies.
Annual report. P. 1+.
- Ontario** hydro-electric power commission. Toronto.
Report. N. D. 1+.
- Ontario.** Industries, Bureau of. Toronto.
Annual report. Exp. '91+.
Bulletin. Exp. 24, 30, 31, 36-41, 43-45, 47-51, 53-69, 71-87, 89-93, 95,
96, 98, 100+: P. 43, 47, 48, 50-52, 54-79, 87+.
- Ontario** land surveyor's association.
Proceedings. P. 6-26.
- Ontario** live stock association. Toronto.
Report. Exp. '95, '96, '98+: P. '95, '00+.
- Ontario** municipal and railway board. Toronto.
Report. N. D. 4+.
- Ontario** natural science bulletin. N. D. 4.
- Ontario** registrar of live stock. Toronto.
Report. Exp. '01-'04.
- Ontario** sheep-breeders' and swine-breeders' association. Toronto.
Report. Exp. '91-'94: P. '90-'94.
- Ontario.** Special investigation on horse-breeding. Toronto.
Report. Exp. '06.
- Ontario** vegetable growers' association.
Annual report. P. 1+.
- Ontario** veterinary college. Toronto.
Report. Exp. '09-'11.
- Operative** miller. Chicago, Ill. Exp. 16*, 17*: P. 9-16.
- Orange Judd** farmer. Chicago, Ill. Exp. 47-49, 50*, 51, 52*, 53+: S. L. 2-43.
- Orange Judd** northwest farmstead. Minneapolis, Minn. Exp. 36*.
- Orange River Colony.** Agriculture, Department of. Bloemfontein.
Annual report. Exp. 1, 3, 4.
Bulletin. Exp. 8, 17, 19, 20, 23.
- Oregon** (state) agricultural college. Salem; Corvallis.
Bulletin. Exp. 67.
Extension bulletin. Exp. 1, 2, 7.
Report. Exp. '06-'08: S. L. '76-'95.

- Oregon.** Agricultural experiment station. Corvallis.
 Annual report. Exp. '89-'92, '96.
 Bulletin. Exp. 1+: P. 2+: S. L. '09-'10.
- Oregon** agriculturist. Portland. Exp. 18*, 19*.
- Oregon** (state) conservation commission. Salem.
 Report. N. D. '12+: P. '09+.
- Oregon.** Dairy and food commission.
 Biennial report. P. '08-'10.
- Oregon.** Desert land board.
 Report. P. 5.
- Oregon.** (State) engineer.
 Report. N. D. 2+: P. 2+.
- Oregon** (state) horticultural society. Portland.
 Annual report. Exp. 24, 25.
- Oregon.** Horticulture, State board of. Salem; Portland.
 Biennial report. Exp. 2, 3, 5-11: S. L. '98, '02, '04, '06.
- Oregon** (state) medical society.
 Proceedings. S. L. '77-'79, '81, '83-'85, '91.
- Oregon.** Stallion registration board.
 Annual report. P. 1+.
- Oregon** (state) university. Eugene.
 Bulletin. P. n. s. 3*: N. D. 3*, 4*, 10*.
- Ornithologische** Gesellschaft in Bayern. Munich, Germany. Ac. 5+.
- Ornithologischer** Verein. Munich, Germany.
 Jahresbericht. S. L. '01, '02.
- Ornithologisches** Jahrbuch. Halle, Austria. Ac. 9, 12, 13, 15, 17, 19, 21+.
- Osterreichische** botanische Zeitschrift. Vienna, Austria. N. D. 63+.
- Ottawa** (Canada) naturalist. Ac. 1-15*: N. D. 25+.
- Oxford**, Cambridge and Dublin messenger of mathematics. Cambridge, England. D. 1-5||: I. U. 1-5||.
 Continued as **Messenger** of mathematics *q. v.*
- Pacific** dairy review. San Francisco, Cal. Exp. 12*, 13, 14*, 15*, 16*, 17+
- Pacific** pharmacist. San Francisco, Cal. N. D. 2*-6*.
- Pacific** rural press. San Francisco, Cal. Exp. 74*, 75*, 76*, 77-80, 81*, 82+
- Page's** weekly. London, England. P. 1+.
- Paginas** ilustradas. San Jose, Costa Rica. Ac. 2, 3, 11, 12, 14, 15, 18, 30, 34-37, 47, 50-53.
- Palermo** (Italy). See **Circolo** matematico.

- Para** (Brazil). See **Museu Goeldi**.
- Paris**. See **Académie des sciences**; **École polytechnique**; **Muséum national &c.**
- Park** and cemetery and landscape gardening. Chicago, Ill. Exp. 15*, 16, 17*, 19*, 20*, 21*, 22+.
- Pavia** (Italy) università. Instituto botanico. N. D. '09+.
- Peabody** academy of science. Salem, Mass.
Annual report. S. L. '72.
- Peabody** museum of American archaeology and ethnology. See **Harvard** university.
- Peninsula** horticultural society. Dover, Del.
Transactions. Exp. '88-'94, '96, '97, '99-'06: P. '88, '91-'94, '96, '97, '02, '03, '07+.
- Pennsylvania**. Agricultural experiment station. State College.
Annual report. Exp. '86+: P. '86-'90, '92+.
Bulletin. D. 17, 20; Exp. o. s. 1-16; n. s. 1+: P. n. s. 2+.
- Pennsylvania** (state) agricultural society.
Report of transactions. Exp. 1: S. L. 7, 9.
- Pennsylvania**. Agriculture, Department of.
Annual report. Exp. 1, 2, 4*, 5, 6, 7*, 8-17: P. 2, 3*, 4*, 5+.
Bimonthly bulletin. Exp. 1*, 2.
Bulletin. Exp. 3, 6, 8, 10, 11, 17, 19, 21-24, 27-32, 34-38, 40, 41, 43-49, 51, 52, 54-69, 71-77, 79-81, 83, 84, 86-100, 102-107, 109-162, 164-167, 169, 171, 172, 174-210, 212+: P. 14, 16, 20, 21, 26, 36, 39, 52-69, 71-101, 103, 106, 107, 109+.
Monthly bulletin. Exp. 1*, 2*, 3*, 4*, 5-7, 8*, 9+.
Zoological bulletin. P. 5.
Zoological quarterly. Exp. 1*, 2*, 3*.
- Pennsylvania**. Agriculture, State board of.
Annual report. Exp. 2-11, 15-18, 32, 34+: P. 7, 11-16.
- Pennsylvania**. Dairy and food division.
Bulletin. P. 1*, 2*, 3+.
Annual report. Exp. '05.
- Pennsylvania** dairy union. State College.
Annual report. Exp. 8, 11.
- Pennsylvania**. Factory inspector.
Annual report. Exp. '10, '11.
- Pennsylvania** farmer. Philadelphia. Exp. 31*, 32+.

- Pennsylvania.** Fisheries, Department of.
Annual report. Exp. '08-'11.
Bulletin. Exp. 8.
- Pennsylvania** forestry association.
Annual report. Exp. '01, '02, '05-'11.
- Pennsylvania** (state) forestry department.
Report. P. '01, '02, '05-'09.
- Pennsylvania.** Game commissioner.
Annual report. Exp. '09, '11.
Bulletin. Exp. 1, 2.
- Pennsylvania.** Geological survey.
Report. P. 1-3: R. P. '74-'86.
- Pennsylvania.** Health, State board of. Harrisburg.
Annual report. Exp. 4: P. '86-'01.
Bulletin. Exp. 14-31, 34, 36-39.
- Pennsylvania.** Health, Commissioner of.
Annual report. P. '05-'09.
- Pennsylvania** (state) hospital for the insane. Pathological laboratory. Norristown.
Annual report. Exp. 10.
- Pennsylvania** (state) live stock breeders' association.
Proceedings. Exp. 6, 7, 12.
- Pennsylvania.** Live stock sanitary board.
Circular. Exp. 12: P. 12, 16, 18.
- Pennsylvania.** Mines, Department of.
Annual report. Exp. '09-'11.
- Pennsylvania.** Pharmaceutical examination board.
Annual report. Exp. 23, 24: N. D. 23.
- Pennsylvania.** Public charities, Board of.
Annual report. Exp. '09-'11.
- Pennsylvania** state college. School of engineering.
Engineer. P. 2*, 3*.
- Pennsylvania.** Topographic and geologic survey commission.
Preliminary report. Exp. 5.
Report. Exp. '08-'10.
- Pennsylvania** university. Botanical laboratory. Philadelphia.
Contributions. I. U. 4+: N. D. 2+.

- Pennsylvania university.** Zoological laboratory. Philadelphia.
Contributions. I. U. 10, 11*, 13, 17; P. 1*.
- Pennsylvania.** Water supply commission.
Report. P. '08, '09.
- Periodico** científico del museo nacional de historia natural y de la sociedad Mexicana de historia natural. See **Sociedad Mexicana de historia natural.**
- Peru.** Cuerpo de ingenieros de minas. Lima.
Boletín. S. L. 1-21, 25-54, 56-59, 62-74, 76+.
- Pharmaceutical era.** Detroit, Mich. N. D. 28*-43*, 45*; P. 1-8, 13-21, 23, 25+*.
- Pharmaceutical journal and transactions.** London, England. P. 41-45.
- Pharmaceutical record.** New York. P. 5-10, 12-15||.
Merged with **American druggist** *q. v.*
- Philadelphia** (Pa.). See **Academy of natural sciences; Geographical society.**
- Philadelphia** (Pa.). Health, Bureau of.
Annual report. P. '96-'08.
- Philadelphia** (Pa.) medical journal. P. 8.
- Philadelphia** (Pa.) museums.
Annual report. N. D. '04, '05, '07, '08, '10; P. '04, '05, '07, '08, '10, '11.
- Philippine agricultural review.** Manila. Exp. 1*, 2*, 4*, 5*, 6+; N. D. 1+; P. 1+.
- Philippine Islands.** Agriculture, Bureau of.
Bulletin. Exp. 22, 23.
- Philippine Islands.** Ethnological survey.
Publications. P. 1*, 4*.
- Philippine Islands.** Forestry, Bureau of. Manila.
Annual report. Exp. '02, '04.
Bulletin. Exp. 1.
- Philippine Islands.** Laboratories, Bureau of government. Manila.
Bulletin. S. N. 1-3, 8, 15, 17-28, 30-36.
- Philippine Islands.** Science, Bureau of. Manila.
Annual report. Exp. 4, 5; N. D. 1+.
Bulletin. Exp. 1, 2, 4-6, 8, 13-20.
Mineral resources. Exp. '07-'11.
- Philippine journal of science.** Manila. Exp. 1, 2, 3*, 4+; N. D., 00; P. (all ser.) 3+.
Supplements. Exp. 1-5.

- Phillips academy.** Archaeology, Department of. Andover, Mass.
Bulletin. N. D. 1+.
- Philosophical magazine and journal of science.** London, England. I. U. IV.
1-50; V. 1-50; VI. 1-8, 10+: N. D. '09: N. H. I. 34, 39, 41-43*: P.
V. 25+: R. P. V. 1-4, 14+: W. VI. 5+.
- Photo-beacon.** New York. Ft. W. 19: N. D. 7, 8, 9*, 10*, 12*, 13-19.
Continues in **American** amateur photographer *q. r.*
- Photo era.** Boston, Mass. Ft. W. 28+: G. 29+. R. P. 6-8, 24+: T. H. 17+.
- Photographic bulletin, Anthony's.** New York. R. P. '00*.
- Photographic times.** New York. L. P. 39*, 40*: R. P. 17-42*.
- Photo-miniature.** New York. G. 81+: I. U. 1+: R. P. 1-3, 10+: T. H. 1+.
- Phrenological journal and science of health.** New York. N. D. 50, 51, 54-57:
N. H. 50-68.
- Physical review.** New York. D. 1+: E. 24+: I. U. 1+: N. D. '09+: P.
1+: R. P. 1+: S. N. 8-13: W. 19+.
- Physical society of London.**
Proceedings. I. U. 1+: P. 19+.
- Physikalische Zeitschrift.** Leipzig, Germany. N. D. '09+: R. P. 6+.
- Physiologie vegetale.** Geneva, Switzerland. Exp. 1-5.
- Physio-medical journal.** Indianapolis, Ind. M. 1.
- Phytopathology.** Ithaca, N. Y. D. 1+: I. U. 1+: W. 1+.
- Plant world.** New York, Tucson, Ariz. Ae. 6¹⁻⁸, 7², 8⁴, 13¹: Exp. 13, 14, 15*,
16+: I. U. 8+: P. 11+: W. 8-12.
- Plön** (Germany) biologische Station. Forschungsberichte. Stuttgart. I.
U. 1+.
- Plough-boy.** Albany, N. Y. S. L. 1-4.
- Plumbers' trade journal.** New York. Ft. W. 62+.
- Polytechnic engineer.** Brooklyn, N. Y. P. 10, 12.
- Pomological and fruit growing society of the province of Quebec.**
Annual report. Exp. '09.
- Pomona college journal of entomology.** Claremont, Cal. Exp. 1*, 2*, 3*,
4*: N. D. 1+.
Continues as **Journal** of entomology and zoology.
- Pontificia accademia roma dei nuovi Lincei.** Rome, Italy. See **Accademia**
pontificia dei nuovi Lincei.
- Popular astronomy.** Northfield, Minn. B. 11-14, 16, 17*+: D. 11, 12*, 20+:
E. 1+: F. 10+: I. U. 1+: N. D. 1+.
- Popular electricity.** Chicago, Ill. E. 4: Ft. W. 2+: G. 3*, 4*, 5+.

- Popular mechanics.** Chicago, Ill. F. 15+: Ft. W. 14+: G. 12+: L. P. 9+: M. 11+: N. H. 15+: S. L. 15+: T. H. 11+.
- Popular science index.** M. 1-8.
- Popular science monthly.** New York. B. 1+: D. 1+: E. 1-12, 15-19, 24-29, 31, 32, 34, 36, 37, 40, 41, 43-65, 67+: F. 1-55, 63+: Ft. W. 1, 2, 46+: G. 74+: I. U. 1+: L. P. 1+: M. 1+: N. D. 1-62, 65+: N. H. 1+: P. 1+: R. P. 1+: S. L. 1+: S. N. 1+: T. H. 1+: W. 1+.
- Supplement. N. D. 1-18.
- Popular science news.** New York. W. 21-24.
- Popular science review.** London, England. R. P. 1-13: S. L. 1-20||.
- Portefeuille économique des machines de l'outillage et du matériel.** Paris, France. R. P. 12.
- Portland society of natural history.** Portland, Me.
Proceedings. Ac. 2⁴, 5, 8-9.
- Porto Rico.** Agricultural experiment station. Mayaguez.
Annual report. D. '06-'08, '10+: Exp. '01, '04+: R. P. '06, '07: S. L. '06-'08, '10-'11.
Bulletin. D. 1, 2, 5-8, 10+: Exp. 1, 2, 4+: P. 1+: R. P. 1-8: S. L. 1-8, 10: S. N. '02+.
- Porto Rico sugar planters and producers' association.** Rio Piedras.
Annual report. Exp. 2.
Bulletin. Exp. 3.
- Portugal.** Comissão dos trabalhos geologicos. Lisbon.
Communicacoes. Ac. 1-5, 6¹.
- Post graduate.** New York. P. 19-21*.
- Postelsia.** See under **Minnesota** university.
- Poultry association of Ontario.** Toronto
Report. Exp. '94, '01.
- Poultry digest.** New York. Exp. 3*, 4, 5*, 6*.
- Poultry fancier.** Chicago, Ill. Exp. 14*, 15*, 16*.
- Poultry world.** Hartford, Conn. Exp. 1-10.
- Power.** New York. Ft. W. 27+: G. 30+: N. D. 20+: P. 13, 20+: R. P. 14+: T. H. 24.
- Power boating.** Cleveland, O. Ft. W. 10+.
- Practical dairyman.** Rutherford, N. J. Exp. 2*, 3.
- Practical druggist and pharmaceutical review of reviews.** New York. P. 29.
- Practical engineer.** Chicago, Ill. Ft. W. 13+: N. H. 13+: R. P. 13-16.
- Practical farmer.** Philadelphia, Pa. Exp. 96*, 97*, 98, 99, 100*, 101-104, 105*, 106+.

- Prairie farmer.** Chicago, Ill. Exp. 79*, 80*, 83*, 84+.
- Praktische Chemie.** Leipzig, Germany. Exp. 37-40.
- Prince Edward Island.** Agriculture, Department of.
Annual report. Exp. '05, '10: P. '04.
- Prince Edward Island dairy association.**
Annual report. Exp. '11.
- Prince Edward Island.** Forestry commissioners.
Report. P. '04.
- Prince Edward Island fruit growers' association.**
Annual report. Exp. '02-'04, '06+.
- Princeton (N. J.) university.**
Contributions to philosophy. P. 1*.
Contributions to psychology. P. 1*, 2*.
- Producer and consumer.** See **Farm** sense.
- Progressive farmer and home builder.** Phoenix, Ariz. Exp. 1*, 2*, 3+.
- Progressive farmer and southern farm gazette.** Memphis, Tenn. Exp. 24*,
25*, 26*, 27+.
- Progressive medicine.** Philadelphia, Pa. I. U. 9+.
- Psyche.** Cambridge, Mass. Ac. 4*, 5*, 6*, 7*: S. N. 2-4.
- Psychological bulletin.** New York; Lancaster, Pa. E. 1+: I. U. 1+: N. D.
2+: P. 5+: S. N. 1+: W. 1+.
- Psychological clinic.** Philadelphia, Pa. G. 1+: I. U. 1+: P. 1+: S. N. 1+:
W. 1-3.
- Psychological index.** New York. N. D. 5-7, 9+.
- Psychological monographs.** New York. I. U. 1+: S. N. 1+.
- Psychological review.** New York; Baltimore, Md. D. 1+: N. D. 6, 8, 12+:
P. 15+: S. N. 1+: W. 5+.
- Psychologische Arbeiten.** Leipzig, Germany. I. U. 1+.
- Psychologische Studien.** Leipzig, Germany. I. U. 1+.
- Psychotherapy.** New York. I. U. 1+.
- Public service journal.** See **Stone** and Webster public service journal.
- Purdue agriculturist.** Lafayette, Ind. Exp. 4+: P. 1+.
- Purdue engineering review.** Lafayette, Ind. P. 1+.
- Purdue university.** Lafayette, Ind.
Leaflets on nature study. Exp. '98: P. 1-24||.
- Purdue university.** Agricultural extension, Department of.
Annual report. P. 1+.
Bulletins. P. 2-13, 17+.

- Pure products.** New York. Exp. 1*, 2+: P. 4+.
- Quarterly journal and review.** Cincinnati, O. N. H. 1.
- Quarterly journal of medical science.** Dublin, Ireland. D. 6-8, 16-26.
- Quarterly journal of microscopical science.** London, England. B. 22-25: D. n. s. 34-36, 38; I. U. n. s. 32-45: R. P. o. s. 1-8; n. s. 1-14.
The old series was called **Journal** of microscopical science.
- Quarterly journal of pure and applied mathematics.** London, England. D. 1-25: I. U. 1-41, 43+: R. P. 1+: W. 28.
- Quebec.** See **Dairymen's association** of the province of Quebec; **Pomological and fruit growing society** of the province of Quebec.
- Quebec.** Agricultural experiment station, Department of.
Annual report. Exp. '91.
- Quebec.** Agriculture, Minister of.
Annual report. Exp. '09.
- Quebec.** Lands and forests, Department of.
Report. P. '08, '09.
- Queensland (Australia).** Agriculture, Department of. Brisbane.
Agricultural journal. Exp. 1*, 2*, 3, 6*, 7*.
Annual report. Exp. '89-'94.
Botany bulletin. Exp. 8, 9, 11, 12.
Bulletin. Exp. I. 1-17, 20-25; II. 1-4.
- Queensland museum.** Brisbane, Australia.
Annals. Ac. 6-9: N. D. 10+.
Memoirs. N. D. 1+.
- Quekett microscopical club.** London, England.
Journal. R. P. 1-5.
- Radium.** Paris, France. I. U. 1+.
- Railroad and engineering journal.** New York. R. P. 61-68.
Continued as **American engineer and railroad journal** *q. v.*
- Railroad car journal.** New York. P. 7*, 8-11.
Vol. 11 has title **Railroad digest**.
- Railroad digest.** See **Railroad car journal**.
- Railroad gazette.** New York. Ft. W. 34*, 35, 36, 37*, 38, 40, 44||: P. 5-44||.
Combined with **Railway age** (*q. v.*) and continued as **Railway age gazette** *q. v.*
- Railway age.** Chicago, Ill. Ft. W. 40-45||: P. 22-45||.
Combined with **Railroad gazette** and continued as **Railway age gazette** *q. v.*
- Railway age gazette.** New York; Chicago, Ill. Ft. W. 48, 50+: G. 46+: P. 45+: R. P. 17+: T. H. 50+.
Continues **Railroad gazette** *q. v.*

- Railway** and engineering review. Chicago, Ill. N. D. 38-46: P. 33+.
- Railway** and locomotive engineering. New York. Ft. W. 22+: G. 25+: P. 14+: R. P. 14-16*.
- Continues **Locomotive** engineering *q. r.*
- Railway** machinery. New York. P. n. s. 1*, 4-5, 6*, 7+.
- Railway** master mechanic. Chicago, Ill. P. 17*-22*, 23+.
- Railway** signal association. Bethlehem, Pa.
- Journal. P. 11+.
- Proceedings. P. 1+.
- Real** academia de ciencias naturales y artes. Barcelona, Spain.
- Boletín. Ac. 1¹⁶⁻³⁰, 2^{1, 3-11}, 3¹⁻³.
- Memorias. Ac. 3, 4^{1, 2, 6-40}, 5¹⁻²⁷, 6¹⁻³³, 7¹⁻¹⁷, 8¹⁻²¹, 9¹, 10^{1, 3-12}+
- Real** academia de ciencias exactas, físicas y naturales. Madrid, Spain.
- Annario. Ac. '89, '08, '11-'13.
- Memorias. Ac. 12, 13¹⁻³, 14, 15¹⁻³, 18¹, 20, 21², 22-25, 26^{1, 2}.
- Revista. Ac. 1¹⁻⁸, 2^{2, 3}, 3, 4¹⁻⁶, 5^{1-1, 7, 12}, 6+.
- Reale** accademia dei Lincei. Rome, Italy.
- Atti. Rendiconti delle sedute solenni. Ac. '01+.
- Reale** accademia dei Lincei. Rome, Italy. Classe di scienze fisiche, matematiche e naturali.
- Atti. Rendiconti. Ac. 9-22: I. U. V. 20+.
- See also **Accademia** pontificia dei nuovi Lincei.
- Note.—“The Accademia dei Lincei, celebrated in the 17th century, was revived in 1801, but again expired in 1840. It was renewed, under the auspices of Pope Pius IX. in 1847 as Accademia pontificia dei nuovi Lincei, and up to 1870 had issued 23 vols. of Atti. Then the academy changed its name to Reale Accademia dei Lincei, but a portion continued to act under the former title. Each body continued the series of Atti. In 1875 the Reale Accademia enlarged its scope, and formed two classes, one for physical and mathematical sciences, the other for moral and historical sciences. It has published five series of Atti.” Bulletin No. 8 of the Free Library of Philadelphia.
- Reale** orto botanico e Giardino. Palermo, Italy.
- Bolletino. N. D. 11+.
- Records** of the past. Washington, D. C. N. H. 5-7, 8*.
- Registered** pharmacist and drug clerk's journal. Chicago, Ill. P. 10, 11*.
- Reliable** poultry journal. Quincy, Ill. Exp. 3*. 4, 9-11, 12*, 13, 14*, 15-17, 19+: Ft. W. 14, 16+.
- Rennes** (France) université.
- Travaux scientifiques. I. U. 1+.
- Repertorium** novarum specierum. Berlin, Germany. N. D. 1+.
- Beihefte. N. D. 1+.

- Retrospect** of practical medicine and surgery. New York. See **Braithwaite's** retrospect.
- Review** of medicine and pharmacy. Detroit, Mich. D. 10, 11*.
- Revista** de agricultura tropical. Mexico City. Exp. 1*, 2*.
- Revista** industrial y agricola de Tucuman. Argentine Republic. Exp. 1*, 2*, 3*.
- Revista** montserratina. Barcelona, Spain. N. D. 4*, 5+.
- Revue** bretonne de botanique pure and appliquee. Rennes, France. N. D. 7+.
- Revue** de horticulture Belge et etrangere. Ghent, Belgium. N. D. '13+.
- Revue** de l'ingénieur et index technique. Brussels, Belgium. G. 1-19.
- Revue** de mathématiques spéciales. Paris, France. I. U. 20+.
- Revue** de mécanique. Paris, France. P. 16+.
- Revue** des questions scientifiques. Louvain; Paris, France. N. D. I. 1-10, 15-28; II. 1, 2, 3*, 4*, 5-11, 12*, 13, 14*, 15*, 16, 17*, 18-20; III. 1-11, 12*, 13+.
- Revue** générale dulait. Lierre, France. Exp. 8+.
- Revue** internationale der gesammte hydrobiologie und hydrographie. I. U. 1+.
- Revue** philosophique de la France et de l'étranger. Paris, France. I. U. 1-42, 49+.
- Revue** semestrielle des publications mathématiques. Amsterdam, Holland. I. U. 1-18.
- Rhode Island.** Agricultural experiment station. Kingston.
Annual report. D. 12, 13; Exp. 1+; S. L. '03, '04, '07, '09.
Bulletin. Exp. 1+; S. L. '02-'09*.
- Rhode Island.** Agriculture, State board of.
Annual report. Exp. 14-17, 21.
Bulletin. Exp. 1, 2, 7, 9-13.
Farmers' institute report. Exp. '11.
- Rhode Island.** Birds, Commissioner of.
Annual report. P. '11.
- Rhode Island.** Conservation commission.
Bulletin. P. 1+.
- Rhode Island.** Inland fisheries, Commissioners of.
Report. P. 41.
- Rhode Island.** Metropolitan park commissioners.
Report. P. 5, 6.

- Rhode Island.** Public roads, State board of.
Annual report. P. 3+.
- Rhode Island.** Public utilities commission. Providence.
Report. N. D. '12+.
- Rhode Island.** Shell fisheries, Commissioners of.
Annual report. P. '91, '92, '94, '95, '99, '00, '05+.
- Rhodora.** Boston, Mass. N. D. 11+.
- Rider and driver.** New York. Exp. 41*, 42, 43*, 44, 45*, 46+.
- Rio de Janeiro (Brazil).** See **Museu nacional.**
- Rochester (N. Y.) academy of science.**
Proceedings: Ac. 1¹, 2¹⁻⁴, 3¹⁻³, 4+; I. U. 1+.
- Rochester (England) naturalist.** N. D. 101+.
- Rose technic.** Terre Haute, Ind. R. P. 1+.
- Rothamsted experiment station.** Herts, England.
Annual report. Exp. '08-'12.
Memoirs on agricultural chemistry and physiology. Exp. 1-6.
Memoranda of origin and results of field and other experiments. Exp. '88-'90, '93, '95-'01.
Memoranda of Rothamsted experiments. Exp. '96-'05.
- Royal agricultural society of England.** London.
Journal. Exp. II. 12-15, 25; III. 2-11.
- Royal Asiatic society of Great Britain and Ireland.** London.
Journal. Ac. 21³⁻⁶, 22, 23¹⁻², 24¹, 25, 26, 30, 31; I. U. '11+.
- Royal astronomical society.** London, England.
Memoirs. I. U. 41, 47-49, 53-57, 59+.
Monthly notices. I. U. 1-69.
- Royal botanic gardens.** Edinburgh, Scotland.
Notes. Exp. '08-'12.
- Royal botanic gardens.** Kew, England.
Bulletin of miscellaneous information. Exp. '00*-'10*: N. D. '09+.
- Royal botanic society of London (England).**
Quarterly record. Ac. 3-10*.
- Royal geographical society of London.**
Geographical journal. D. 42; S. N. 1+; T. H. 1+.
Proceedings and monthly record of geography. S. N. 12-14.
- Royal geological society of Cornwall.** Penzance, England.
Transactions. Ac. 13²⁻⁸.
- Royal horticultural society of London (England).**
Journal. Exp. 26+.

- Royal institute of Great Britain.**
Proceedings. N. H. 9*, 12*.
- Royal Irish academy.** Dublin, Ireland.
Proceedings. N. D. 31.
- Royal Irish society.**
Proceedings. I. U. II. sci. 1.
- Royal Jersey agricultural and horticultural society.** St. Helier, Island of Jersey.
Annual report. Exp. '96.
- Royal microscopical society.** London, England.
Journal. D. '89, '91-'95; I. U. '88-'93; P. '82+; R. P. I. 1-II. 1; W. '92-'03.
- Royal philosophical society of Glasgow (Scotland).**
Proceedings. Ac. 29+.
- Royal physical society of Edinburgh (Scotland).**
Proceedings. Ac. sessions 115-120, 122-124, 128.
- Royal sanitary institute.** London, England.
Journal. P. 29+.
- Royal society of Canada.** Montreal.
Transactions. I. U. I. '82-'94; II. '95-'06; III. 1+; P. II. 8*, 9*; III. 1.
- Royal society of Edinburgh (Scotland).**
Proceedings. Ac. 21+; R. P. 11-27.
Transactions. I. U. 35*; R. P. 1+.
- Royal society of London (England).**
Philosophical transactions. I. U. 1-18; II. 90+; P. 158+; R. P. 1+; S. L. 1-131, 133-180.
Proceedings. I. U. ser. A. 1+; ser B. 1+; R. P. 7+; S. L. ser A. 53, 79-83; ser B. 79-82; W. 72-75; ser A. 76-84; ser B. 76-81.
- Royal society of New South Wales.** Sidney, Australia.
Journal. Ac. 19-45; I. U. 20-21.
- Royal society of Queensland.** Brisbane, Australia.
Proceedings. Ac. 13-22.
- Rudder.** New York. Ft. W. 17, 18*, 19+.
- Rugby school natural history society.** Rugby, England.
Report. N. D. '12+.
- Rural affairs.** Albany, N. Y. Exp. 1-9; P. 1-5.
- Rural life.** Rochester, N. Y. Exp. 28, 29, 30*.
- Rural New Yorker.** New York. Exp. '75*, '80*, '81*, '84, '86*, '87-'90, '91*, '92*, '93*, '96*, '97*, '98*, '07*, '08*, '09*, '10+; P. 63+; S. L. '64-'07.

St. Louis (Mo.) academy of science.

Transactions. Ac. 4³, 4, 5¹⁻⁴, 6¹⁻¹⁸, 7¹⁻²⁰, 8¹⁻¹⁰, 9¹⁻⁹, 10¹⁻¹¹, 11¹⁻¹¹, 12¹⁻¹⁰,
13¹⁻⁹, 14¹⁻⁸, 15¹⁻⁶, 16¹⁻⁸, 17¹, 2, 18¹⁻⁶, 19¹⁻¹¹, 20¹⁻⁷, 21¹⁻³+; I. U. 1*, 2,
4, 13+; N. D. 8*, 9*, 10*; N. H. 2*: P. 6*, 14*.

St. Louis (Mo.) railway club.

Proceedings. P. 1+.

St. Petersburg (Russia). See **Academie imperiale des sciences**; **Comité géologique**; **Jardin imperiale botanique.****Sanitary engineer.** New York. P. 2*, 3-16||.

Continued as **Engineering record**, building record and sanitary engineer *q. r.*

São Paulo (Brazil). Agricultura, commercio e obras publicas, Secretaria da.

Boletin. Exp. o. s. 27*, 28*, 29*; n. s. 1*-3*, 4, 5, 6*, 7-9, 10*, 11+.

São Paulo (Brazil). See **Museu paulista**; **Sociedad scientifica.****São Paulo (Brazil).** Instituto agronomico em Campinas.

Anuario. Exp. '90, '92-'95.

Boletin. Exp. 9*, 10.

Sarawak museum. Sarawak, Borneo.

Journal. Ac. 1¹, 2; N. D. 1+.

Report. Ac. '10, '11; N. D. 9+.

Saskatchewan. Agriculture, Department of. Regina.

Annual report. Exp. '10.

School arts book. Worcester, Mass. P. 11+; S. N. 4-8, 10+.**School of mines quarterly.** New York. I. U. 12+.**School of science and mathematics.** Chicago, Ill. E. 9+; F. 13+; I. U. 3+;
N. D. 1, 8, 13+; P. 1+; S. N. 1+.**Schweizerische botanische Gesellschaft.** Bern, Switzerland.

Berichte. Ac. 14+.

Schweizerische naturforschende Gesellschaft. Basel, Switzerland.

Verhandlungen. Ac. 75, 77, 79-81, 83, 84, 87-89, 91, 93, 94¹, 2.

Also called **Société helvétique des sciences naturelles** *q. r.*

Science. New York. D. o. s. 1-22; n. s. 1+; E. o. s. 8, 9; n. s. 8, 9, 13+;

Exp. 15+; F. 31+; Ft. W. 25+; I. U. o. s. 225; n. s. 1-34; N. D. 19+;

N. H. n. s. 30*, 34*; P. o. s. 1-23; n. s. 1+; R. P. o. s. 1-23; n. s. 1+;

S. N. 1-19; n. s. 1+; S. L. 13+; W. 5-24; n. s. 7-13, 19-22.

Science abstracts. London, England.

Physical and electrical engineering. P. 1-5||; R. P. 4-5||; I. U. 1-5||.

Section A, physics. N. D. '10+; P. 6+; R. P. 6+; I. U. 6+; W. 10+.

Section B, electrical engineering. P. 6+; R. P. 6+; I. U. 6+.

Science magazine. M. 31-34.

Science news. Salem, Mass. P. 1.

Science record (Beach). New York. R. P. '74.

Scientific American. New York. D. 1-25, 50+: E. 6-8, 11-14, 16-21, 23-26, 30, 31, 36-74, 98-100, 105+: F. 70-93, 96+: Ft. W. 86, 90-98, 100+: G. 82+: I. U. 35, 44, 45, 49-67, 69, 72-75, 77, 86, 87, 89, 90+: L. P. o. s. 11; n. s. 1-8, 11, 15, 17-19, 23, 26-35, 77+: M. 30+: N. D. o. s. 14; n. s. 4-9, 26, 28, 29, 39, 40*, 41-54, 55*-61, 62, 63*-70*, 80*, 81*, 83*, 88*, 90*, 91*, 94*-98*, 99, 100*, 101+: N. H. n. s. 1-41, 50-51, 100+: P. 34-43, 76+: R. P. o. s. 1-14; n. s. 1+: S. L. 14-15, 18, 30-37, 57-66, 68-83, 86-106: S. N. 86+: T. H. 82+: W. 1-31, 41-45, 48+.

Scientific American. Building edition. New York. Ft. W. 37-39||: L. P. 27*, 28*, 29*: M. 17-39||: R. P. 25-39||.

Continued as **American homes and gardens** *q. v.*

Scientific American. Supplement. New York. D. 1+: E. 65, 66, 68-70, 72+: F. 59-62, 71+: Ft. W. 57, 59-62, 64+: G. 67+: I. U. 1-32, 34, 54, 57+: L. P. 1, 2, 44+: M. 1, 2, 56+: N. D. I. 3; II. 2*, 4*-7*, 9*, 12*-14*, 23*-25*, 28*, 29*, 34*, 42*, 45, 49*-52*, 53, 54*-58*, 59, 60*, 61, 62*-65*, 66+: N. H. 8-10, 13-24: P. 1-4, 9-24, 29+: R. P. 13-20, 49+: S. L. 16, 19-21, 23, 25, 35, 36, 41+: S. N. 31+: T. H. 1+: W. 15-23, 35-54, 56, 58+.

Scientific tracts. Boston, Mass. N. H. n. s. 1, 2, 4.

Scotland agricultural college. Glasgow.

Annual report. Exp. 1, 2, 4-6.

Scotland. Fishery board.

Annual report. S. L. '07+.

Scotland. Highland agricultural society. Edinburgh.

Transactions. Exp. IV. 8-11.

Scottish geographical magazine. Edinburgh, Scotland. I. U. 25+: S. N. 1+.

Seismological society of Japan. Tokyo.

Transactions. R. P. 1-20.

Selbourne magazine and nature notes. London, England. N. D. 23+.

Semillas recolectados durante el ano. jardin botanico. Valencia, Spain.
N. D. '11+.

Seminarium. Leipzig, Germany. N. D. 1+.

Sibley journal of engineering. Ithaca, N. Y. P. 11, 19+.

Siderial messenger. Northfield, Minn. D. 5-10||: W. 1-10||: I. U. 10||: S. L. 1, 2*.

Continued as **Astronomy** and astro-physics.

Signal engineer. Chicago, Ill. P. 1+.

Silliman's journal. See **American journal of science.**

Skandinavisches Archiv für Physiologie. Leipzig, Germany. I. U. 1+.

Sketch book of nature and outdoor life. Manchester, N. H. N. D. 1, 2*||.

Smithsonian institution. Washington, D. C.

Annual report. D. '53-'96, '98-'00, '02-'04, '07-'09; E. '71-'03, '07+; Exp. '82-'84, '87-'95, '97*, '99, '00; F. 54, 56-60, 62-77, 79+; G. '96, '01, '08+; I. U. 4-6, 8-54, 56+; L. P. '47, '53+; N. D. '84+; P. '53, '54' '56+; R. P. 1+; S. L. '46+; S. N. '55, '59, '61, '63, '65, '77, '78, '81+.

Contributions to knowledge. D. 1+; I. U. 13-26, 28, 30+; L. P. 23-26, 28, 30-32; N. D. 2, 3, 5, 6-18, 20-24, 26, 30+; P. 6, 10, 20-32, 34+; R. P. 1+; S. L. 1-35; S. N. 2-13, 15-25, 28+.

Miscellaneous collections. D. 1-30, 32-38, 40-42, 43, 46-57*; I. U. 1, 13+; L. P. 1-6, 9-21, 23-28, 30-33, 35, 36, 37*, 38*, 39*; N. D. 1, 2*, 6-11, 14-33, 36+; P. 1-2, 4, 5, 8, 9, 11-27, 29, 32-41, 44+; R. P. 1+; S. N. 32+; T. H. 16, 18, 20, 22, 23, 25, 27, 40, 42-54, 56+.

Smithsonian institution. United States national museum. Washington, D. C.

Annual report. B. '04; F. '00-'04; I. U. '84+; L. P. '81+; N. H. '54+; P. 84+; R. P. '85+; S. L. '85+; S. N. '84-'98, '07+; T. H. '86+.

Bulletin. D. 29, 33-38, 39*, 40-46, 47*, 48-49, 50*, 51, 52, 53*, 54, 55, 56*, 57, 58, 60-69, 71-77, 79, 81; Exp. 3, 6, 11, 13, 21, 23, 26, 39*, 40-46, 47*, 50, 51, 53-60, 62-71, 73+; I. U. 1-38, 40-54, 56-58, 60, 70+; L. P. 39*+; N. H. 9, 10, 12, 40-43, 45, 48; P. 1-16, 20, 21, 24, 26, 33-38, 40-48, 50+; R. P. 1-16, 39-48; S. L. 1+; S. N. 1-48, 50+.

Proceedings. D. 10-22, 24-28, 32, 34-40; Exp. 2, 3, 8, 9, 14-33, 36, 37, 39, 42+; F. 14-16, 18-29; I. U. 1+; L. P. 14+; N. D. 14+; N. H. 14-19; P. 1+; R. P. 13+; S. L. 1+; S. N. 1+; T. H. 2, 4, 6, 9, 13-33, 35+.

Smithsonian institution. See also **United States.** Astrophysical observatory; **United States.** Ethnology, Bureau of American; **United States.** National herbarium.

Sociedad broteriana. Coimbra, Portugal.

Boletino. N. D. 25+.

Sociedad científica "Antonio Alzate." Mexico City, Mexico.

Memorias y revista. Ac. 9^o, 10, 10⁵⁻¹², 11, 12, 13¹⁻¹⁰, 14⁵⁻¹², 15, 16-18, 19⁶⁻¹², 20⁵⁻¹², 21-28, 29, 30¹⁻⁶+; N. D. 32+.

Sociedad científica Argentina. Buenos Aires, Argentine Republic.

Anales. Ac. 45^o, 46+; N. D. 75+.

Sociedad de geografía y estadística de la República Mexicana. Mexico City.

Boletín. Ac. 1¹⁻¹², 2¹⁻⁵; N. D. 6+.

Sociedad Mexicana de historia natural. Mexico.

Naturaleza. Ac. 7¹⁶⁻¹⁸; II. 1¹⁻³, 5, 6, 9, 10, 2¹⁰⁻¹¹, 3¹⁻¹⁰; III. 1¹⁻⁴+; N. D. III. 1+.

Sociedad química Argentina. Buenos Aires, Argentine Republic.

Anales. Ac. 1¹.

Sociedad científica de São Paulo (Brazil).

Revista. Ac. 1¹⁻⁴, 2¹⁻⁸, 5¹⁻⁸, 6+.

Società africana d'Italia. Naples, Italy.

Bulletin. Ac. 13-31*.

Società botanica italiana. Florence, Italy.

Bollettino. N. D. '09+.

Società di naturalisti in Napoli (Italy).

Bollettino. N. D. 24+.

Società entomologica italiana. Florence, Italy.

Bollettino. Ac. 34-43.

Società italiana di scienze naturali e del museo civico di storia naturale. Milan, Italy.

Atti. Ac. 40-46, 47^{3, 4}, 48^{1, 2, 4}, 49¹⁻⁴, 50¹⁻⁴, 51¹⁻²+.

Societas royale de botanique de Belgique.

Bulletino. N. D. '09+.

Société belge de géologie de paléontologie et d'hydrologie. Brussels, Belgium.

Procès verbaux. Ac. 10-26*.

Société botanique de France. Paris.

Bulletin. Exp. 35-37.

Société botanique de Geneva (Switzerland).

Bulletin. Ac. 8-9.

Société chimique de France. Paris.

Bulletin. Exp. III. 1*, 2*, 3*, 4, 5, 6*, 7-36; IV. 1, 2*, 3+; S. L. '12+.

Société des Americanistes de Paris (France).

Journal. N. H. 5.

Société des sciences naturelles de l'Ouest de la France. Nantes.

Bulletin. Ac. 7-10; II. 1-3, 4^{3, 4}, 5-9, 10¹⁻³; III. 1, 2¹⁻²+.

Société entomologique de Belgique. Brussels, Belgium.

Compte rendu. Ac. 54-67.

Société entomologique de France. Paris.

Bulletin des séances. Ac. '97+*.

Société française de physique. Paris, France.

Bulletin des séances. N. D. '79-'81, '86-'89*, '92, '93, '95.

- Société géologique de Belgique.** Liège, Belgium.
 Anales. Ac. 25¹⁻³, 26²⁻⁴, 27¹⁻⁴, 28¹⁻³, 29+.
 Memoires. Ac. '04-'12.
- Société géologique de France.** Paris.
 Bulletin. I. U. III. 23-28; IV. 1+: S. L. II. 1.
- Société helvétique des sciences naturelles.** Geneva, Switzerland.
 Actes. Ac. '93, '95, '99, '02, '07, '09.
 Compte rendu. Ac. '99-'07.
 Also called *Schweizerische naturforschende Gesellschaft* *q. r.*
- Société hollandaise des sciences.** La Hague, Holland.
 Archives. Ac. 30^{4, 5}; II. 1^{1, 4, 5}, 2-4, 6, 7¹⁻³, 8^{1, 2, 5}, 9-15; III. A. 1-2; III. B. 1+.
- Société impériale des naturalistes de Moscou (Russia).**
 Bulletin. Ac. 61-62; n. s. 1-10, 11^{1, 2}, 13^{2, 3}, 14, 15, 16^{3, 4}, 17, 18²⁻⁴, 19+.
 Memoires. Ac. 15⁵, 16^{3, 4}, 17^{1, 2}.
 Beilage. Ac. '87.
- Société internationale des électriciens.** Paris, France.
 Bulletin. P. 5+.
- Société mathématique de France.** Paris.
 Bulletin. D. 1-20; I. U. 1+.
- Société rambertia.**
 Rapport annuel et présidentiel. N. D. 10-13.
- Société royale de botanique de Belgique.** Brussels, Belgium.
 Bulletin. Ac. 36-45, 45¹⁻³, 46^{1, 2, 4, 5}, 47¹⁻⁴; N. D. 46+.
- Société royale linnéenne de Bruxelles (Belgium).**
 Bulletin. Ac. 14-16*, 19-31*.
- Société royal malacologique de Belgique.** Brussels, Belgium.
 Annales. Ac. 41-46.
 Bulletin des seances. Ac. '00-'01.
 Proces-verbaux des seances. Ac. 11-24*, 26-28*.
- Société scientifique de Bruxelles (Belgium).**
 Annales. N. D. 7-15, 22*, 24-26, 28*, 30+.
- Society for experimental biology and medicine.** New York City. N. D. 1+.
- Society for horticultural science.** Washington, D. C.
 Proceedings. Exp. '03-'10.
- Society for psychical research.** London, England.
 Proceedings. I. U. 1+: S. N. 1+: W. 1-6.
- Society for the promotion of agricultural science.**
 Proceedings. Exp. 4, 5, 9, 11, 14, 17-19; P. 1-28; S. L. '96, '98, '99.

- Society for the promotion of engineering education.** London, England.
 Bulletin. P. 1+.
 Proceedings. P. 1+: R. P. 1+.
- Society of American foresters.**
 Proceedings. P. 1+*.
- Society of chemical industry.** London, England.
 Journal. Exp. 27+: I. U. 22+: N. D. 24*, 25: P. 1+: R. P. 23+: W. 13.
- Society of naval architects and marine engineers.** New York.
 Transactions. P. 1-11: R. P. 1-15.
- Society of telegraph engineers.** London, England.
 Journal. P. 1-17||: R. P. 1-14.
 Continued after Journal 17 as **Institution** of electrical engineers *q. r.*
- Sound waves.** P. 7-12, 13*, 14-15.
 Merged with **American** telephone.
- South Africa.** Central locust bureau. Cape Town.
 Report. Exp. 1-4.
- South Africa.** Entomologist, Government. Cape Town.
 Report. Exp. '95, '98, '00.
- South Africa union.** Agricultural journal. Pretoria, Transvaal. N. D. '12, '13+.
- South African philosophical society.** Cape Town.
 Transactions. Ac. 9², 10², 3, 11¹⁻³, 12, 15¹⁻⁴, 16¹⁻⁴.
- South Australia.** Agriculture, Department of. Adelaide.
 Bulletin. Exp. 1-7, 9-21, 23-29, 31-63, 69, 71*-74*.
 Journal. Exp. 10*, 11*, 15*, 16+.
 Report. Exp. '05-'07, '09-'11.
- South Carolina agricultural college.** Clemson College.
 Extension work. Exp. 1*.
- South Carolina.** Agricultural experiment station. Clemson College.
 Annual report. Exp. 1, 2, 4, 5, 7+: P. 2, 5, 7, 10+.
 Bulletin. Exp. 1-153, 155+: P. o. s. 1-8; n. s. 1-49, 52+.
- South Carolina college.** Columbia. Experimental farm.
 Report. Exp. '83-'86.
- South Carolina.** Live stock association.
 Annual report. Exp. 4-10.
- South Dakota.** Agricultural experiment station. Brookings.
 Annual report. Exp. 1-11, 13, 14, 16+: P. 1-5, 7-9, 15+.
 Bulletin. D. 87, 92, 93, 114, 115, 125, 126; Exp. 1+: P. 1+: R. P. 22-131:
 S. L. '04-'10.

- South Dakota.** Agriculture, State board of.
Annual report. Exp. '09, '10.
- South Dakota** dairy association.
Annual report. Exp. 7.
- South Dakota.** Engineer.
Report. P. 1+.
- South Dakota.** Food and drug commissioner.
Annual report. P. 10-12.
- South Dakota.** Geological survey.
Biennial report. S. N. 1, 2.
Bulletin. P. 4.
- South Dakota.** Improved live stock and poultry breeders' association.
Annual report. Exp. '06-'08, '10.
- South Dakota** (state) school of music. Geology, Department of.
Bulletin. P. 6, 9.
- Southern** and southwestern railway club. Atlanta, Ga.
Proceedings. P. 5*, 6, 7*, 8.
- Southern** California academy of science. Los Angeles.
Bulletin. Ae. 1¹·2.
- Southern** orchard and farm. Houston, Tex. Exp. 6*, 7*, 8+.
- Southern** planter. Richmond, Va. Exp. 70+.
- Southern** ruralist. Atlanta, Ga. Exp. 16*, 18*, 19*, 20+.
- Southern** states association of commissioners of agriculture.
Proceedings. P. 11, 12.
- Southern** woodlands. See **Georgia** forest association.
- Southwest** trail. Chicago, Ill. Exp. 29*, 30*, 31, 32*, 33*.
- Spokesman** review. Spokane, Wash. Exp. 30*, 31+.
- Springfield** (Mass). See **Museum** of natural history.
- Stahl und Eisen.** Dusseldorf, Germany. P. 25+.
- Standard** guide. Chicago, Ill. Exp. 4.
- Statesman's** yearbook. London, England. R. P. '73, '76.
- Stockholm** (Sweden). See **Kongliga** svenska vetenskaps-akademien.
- Stone** and Webster public service journal. Boston, Mass. P. 1-6.
- Strawberry.** Three Rivers, Mich. Exp. 2*.
- Street** railway journal. New York. Ft. W. 29-31||: P. 7-31||.
Continued as **Electric** railway journal *q. v.*
- Street** railway review. Chicago, Ill. P. 4-16||.
Continued as **Electric** railway review *q. v.*
- Student** farmer. Madison, Wis. Exp. 3*, 4*.

- Successful farming.** Des Moines, Ia. Exp. 8*.
- Successful poultry journal.** Chicago, Ill. Exp. 3*, 4, 5*, 6, 7*, 8, 9*, 10*, 11-15, 16*, 17*, 18+.
- Sugar beet.** Philadelphia, Pa. Exp. 12*, 15, 16, 17*, 18-21, 22*, 23*, 24*, 25*, 26*, 27.
- Quarterly. Exp. 27-32.
- Svenska vetenskaps-akademien.** See **Kongliga svenska**, etc.
- Sveriges geologiska Undersökning.** Stockholm, Sweden.
- Afhandlingar och uppsatser. Ac. ser. C. 92-111, 113-134, 195, 196, 201-203; ser. Ca. 4, 5, 7.
- Arsbok. Ac. '07-'09.
- Ofversiktskartor. Ac. ser. Ba. 6, 7.
- Tacoma academy of sciences.** Tacoma, Wash.
- Proceedings. Ac. '93.
- Technic.** See under **Michigan university**.
- Technical literature.** New York. See **Engineering digest**.
- Technical world magazine.** New York. Ft. W. 11+; G. 13+; S. N. 1+.
- Technische Auskunst: Monatsheft des internationalen Institutes für Technobibliographie.** Berlin, Germany. R. P. '09+.
- Technograph.** See under **Illinois university**.
- Technology architectural record.** Boston, Mass. Ft. W. 6+.
- Technology quarterly and proceedings of the Society of arts.** Boston, Mass. P. 18-21.
- Technology review.** Boston, Mass. I. U. 1+; P. 1+; R. P. 1+.
- Telegraph and telephone age.** New York. S. L. '11.
- Telephony, the American telephone journal.** Chicago, Ill. P. 1-4, 17, 18, 59+.
- Tennessee.** Agricultural experiment station. Knoxville.
- Annual report. Exp. 1+; S. L. '00, '01, '03; P. 1+.
- Bulletin. Exp. 1+; S. L. '96-'08*; P. 1+.
- Special bulletin. Exp. B-E.
- Tennessee.** Agricultural statistics and mines, Commissioner of.
- Annual report. Exp. '84.
- Tennessee.** Entomology, State board of. Knoxville.
- Annual report. Exp. 1, 3-6; N. D. 7+.
- Bulletin. Exp. 1, 3-5; N. D. 7+.
- Tennessee.** Geological survey.
- Biennial report. N. H. 1; P. '69.
- Resources of Tennessee. P. 1+.

- Tennessee.** Health, State board of. Nashville. Exp. 3*, 4*, 5*, 6*, 7*, 9*.
Tennessee university. Knoxville.
 Record. Exp. 7*; P. 4*-10*.
- Tennessee university.** Agriculture, School of.
 Report on experimental work. Exp. '79-'86||.
 Continued by Tennessee. **Agricultural** experiment station, *q. v.*
- Terrestrial magnetism and atmospheric electricity.** Chicago, Ill.; Cincinnati, O.; Baltimore, Md. I. U. 4, 5.
- Texas academy of science.** Austin, Tex.
 Transactions. Ac. 1¹⁻⁵, 2^{1, 2}, 3, 4 pt. 2¹⁻⁹, 7, 9-11: N. D. 1+.
- Texas.** Agricultural experiment station. College Station.
 Annual report. Exp. 1-14: P. 1+.
 Bulletin. D. 7: Exp. 1-77, 79-86, 88+: P. 1+: S. L. '05+*.
- Texas.** Agriculture, Department of. Austin.
 Annual report. Exp. 1.
 Bulletin. Exp. 1, 3-7, 10-12, 14, 15, 19, 20-22, 24-28.
- Texas farm cooperator.** Ft. Worth. Exp. 34*, 35+.
- Texas farmer.** Ft. Worth. Exp. 33*, 34+.
- Texas farmers' congress.** Beaumont.
 Annual report. Exp. 14: P. 3-5, 9, 15.
- Texas geological and mineralogical survey.**
 Bulletin. P. 3-4, 7-9.
- Texas university.** Austin.
 Bulletin. Medical series. Ac. 2, 3.
 Official series. Ac. 39.
 Reprint series. Ac. 2.
 Scientific series. Ac. 4, 6, 8, 10-17: I. U. 12, 13: N. D. 14, 20+: P. 46, 51, 135, 165, 178, 189: R. P. 23+.
 Record. P. 2-4*.
 Mineral survey. Bulletin. P. 3, 4, 7, 9||: R. P. 7-9||.
- Therapeutic gazette.** Detroit, Mich. D. o. s. 4-11.
- Therapeutic notes.** Detroit, Mich. I. U. 10+.
- Things chemical.** N. D. '06*, '07*.
- Tidsskrift for skovaesen.** Copenhagen, Denmark. N. D. '13+.
- Timehri.** Journal of the royal agricultural and commercial society of British Guiana. Damerara. N. D. III. 1*, 2*, 3+.
- Tokyo (Japan) botanical society.**
 Botanical magazine and proceedings. N. D. 24+.

- Tokyo** (Japan) university.
Journal. N. D. 1+.
- Toronto** (Can.). City engineer.
Report. P. '93, '95-'97, '99, '01, '02.
- Toronto** (Can.) school of practical science.
Papers. P. 7-20.
- Toronto** (Can.) university. Chemical laboratory.
Papers. Ac. 40-52, 54-72, 74-94.
- Toronto** (Can.) university. Physical laboratory.
Papers. Ac. 18-40.
- Toronto** (Can.) university. Engineering society.
Applied science. P. 1, 2; R. P. '92-'98, '00-'06.
Called Papers before 1903.
- Toronto** (Can.) university.
Studies. Anatomical series. P. 1.
Biological series. Ac. 4-11; N. D. 3+; P. 1-3.
Chemical series. Ac. 40-52, 54-72, 74-93.
Geological series. Ac. 3-7; N. D. 1+; P. 1, 2.
Pathological series. Ac. 1.
Physical science series. Ac. 1-4.
Physics series. Ac. 18-36.
Physiological series. Ac. 4-7; P. 1-3.
Psychological series. Ac. 2², 3⁴, 1; P. 1, 2.
- Torrey** botanical club. New York.
Bulletin. Ac. 12-21, 25; D. 19+; F. 15, 17, 18; I. U. 18-19, 21+; N. D. 14, 15*, 16-24, 25*, 26, 27, 36*, 37+; W. 19+.
Memoirs. D. 1, 2, 4-11; I. U. 1*, 6*, 9, 11*.
Torreya. D. 1+; N. D. 11+.
- Town** planning review. Manchester, England. G. 3+.
- Trade**; a journal of the canning industry. Baltimore, Md. Exp. 34*, 35+.
- Transit**. See under **Iowa** (state) university.
- Transvaal** agricultural journal. Pretoria. Exp. 1*, 2*, 3*, 4-8, 9*.
- Transvaal**. Agriculture, Department of. Pretoria.
Annual report. Exp. '03-'08.
- Traveling** engineers association.
Proceedings. P. 1-7, 9.
- Trenton** (N. J.) natural history society.
Journal. Ac. 1¹⁻³, 2¹.

Trondhjem (Norway). See **Kongelige** norske videnskabers selskab.

Trucker and farmer. New Orleans, La. Exp. 4*, 5+.

Tufts college. Tufts college, Mass.

Studies, Ac. 1²-4, 5, 8, 2²-3, 3: P. 1+*.

United States. Agriculture, Department of. Washington, D. C.

Annual report. D. '63, '65, '67, '68, '73, '75-'80, '85-'93: Exp. '47, '48, '50, '51, '53-'59, '61+: P. '48-'60, '62-'83, '98+: R. P. '62+: S. L. '43*+: S. N. '51-'05, '07+.

Called **Report** of the commissioner of agriculture until 1888. After that called **Report** of the secretary of agriculture. Since 1894 the scientific and general informational matter has been published separately from the administrative report in the **Year** book *q. r.*

Department report series. Exp. 12, 14, 16, 18, 20, 22, 24, 26, 27, 30, 36, 39, 43, 47, 48-50, 52, 55-85, 88-90, 92+: P. 59-63, 65-72, 74, 75, 77, 78, 80, 83, 84, 86+: S. N. 5, 58, 60, 63, 65, 68-72, 74, 75, 77, 80, 86+.

Farmers' bulletins. Exp. 1-375, 377+: N. D. 1+: P. 1+: R. P. 9-356: S. L. 1+: S. N. 1+.

Library bulletin. Exp. 1+: P. 1+: S. N. 40+.

Library monthly bulletin. Exp. 1, 2+: P. 1+.

Miscellaneous reports. Exp. 1-10||: S. L. 1-10||.

Special reports. D. 18-37: S. L. o. s. 1-65||.

Yearbook. D. '94-'97, '07, '08, '10+: Exp. '94+: N. D. 1+: P. '94+: R. P. '94+: S. L. '94+: S. N. '94+.

Continues the scientific and informational matter of the **Annual** report *q. r.*

United States. Agrostology, Division of.

Bulletin. D. 11-20: Exp. 1, 2, 4-7, 9-25||: P. 1-7, 9-25||: R. P. 2-25||: S. N. 1, 2, 4, 6, 8, 9, 12-16, 18, 19, 21-25||.

Continued as **United States** Plant industry, Bureau of, *q. r.*

United States. Animal industry, Bureau of.

Annual report of the bureau. D. 24+: Exp. 1+: P. 1-16, 21+: R. P. 1-24: S. N. '84, '87-'92, '97-'03, '07+.

Annual report of the chief. Exp. '89-'91, '95-'03, '05, '06, '08-'10, '12+.

Bulletin. D. 2-4, 6, 7, 10-15, 17, 20-22, 24, 25, 31, 32, 34, 38, 39, 42, 44-53, 56-58, 60, 63, 66-101, 103-139, 141-159, 161-164, 166+: Exp. 1-78, 80-106, 108-124, 125, 126-159, 161-164, 166+: P. 3-5, 7-9, 11, 13+: R. P. 10-11, S. N. 9, 15-18, 28, 30-34, 36, 39.

United States astrophysical observatory.

Annals. D. 2+: N. D. 1+: R. P. 1+.

United States. Biological survey, Division of.

Annual report. Exp. '87-'89, '98, '01-'09, '11+: N. D. 1+.

Bulletin. D. 1, 6, 8, 10, 15-17, 20, 22+: Exp. 1, 3+: N. D. 1+: N. H. 1: P. 1-37, 39+: S. L. 9+: S. N. 7-9, 12, 15+.

Circular. Exp. 14-17, 20, 23-35, 38-40, 42-44, 46-47, 51+: N. D. 1+: P. 1-61, 63-85, 87-90, 92+: S. L. 17+: S. N. 28+.

North American fauna. D. 1-5, 7, 11, 12, 17, 20, 23: Exp. 1-5, 7, 8, 10+: P. 1-4, 7, 8, 10+: S. L. 1+: S. N. 2-5, 8-10, 11-13, 15, 17, 18, 20-26, 27+.

Formerly **United States.** Ornithology and Mammalogy, Division of, *q. v.*

United States. Botany, Division of.

Annual report. Exp. '85, '86, '88-'91, '93, '94, '96-'98: P. '86, '88-'95.

Bulletin. D. 1, 3, 6, 8, 15-25, 27: Exp. 1-29||: P. 1-3, 5-8, 12-29||: R. P. 16-29||.

Circulars. Exp. 1-30||: P. 2-30||: S. L. 9, 12, 15, 18, 23-30||.

Continued as **United States** Plant industry, Bureau of, *q. v.*

United States brewers' association.

Proceedings. P. '08-'11.

Yearbook. P. '09+.

United States census bureau, forest products. P. '07+.**United States.** Chemistry, Bureau of.

Annual report. Exp. '90, '93, '97, '98, '00-'03, '05, '07+: N. D. 1+: P. '90, '98-'01, '03-'05, '08.

Bulletin. Exp. 3, 8, 9, 11-96, 99-113, 115-160, 163+: N. D. 1+: P. 1-6, 8-10, 13-15, 17, 18, 20+: R. P. 13-124: S. L. 1+: S. N. 13, 15, 20, 21, 34, 39, 40, 42, 46-58, 62+.

Circulars. Exp. 1, 2, 3-6, 7-18, 20+: N. D. 1+: P. 1-77, 79-85, 87+: S. L. 1+: S. N. 5, 16, 41+.

United States. Coast and geodetic survey.

Annual report. D. '52, '54, '55, '60, '62-'68, '71-'73, '77-'89, '91+: N. D. 1+: P. '51+: R. P. '51-'57, '59-'62, '64-'65, '67+: S. N. '51-'57, '60, '61, '78-'95, '97+.

Bulletin. N. D. 1+: R. P. 4-17, 19-21, 25, 26, 28, 29, 32, 33, 35-38, 40+.

Charts. N. D. 1+.

Special publications. P. 1, 5+: R. P. 4, 7, 10+: S. L. 3-5, 7-12.

Surveys. N. D. 1+.

Tide tables. D. '03-'05, '07, '13: N. D. 1+: P. '08+: S. N. '02+.

U. S. coast pilot. Atlantic coast. D. 1-8: S. N. 1-6, 8.

Pacific coast. D. 1: S. N. 1.

U. S. magnetic tables and magnetic charts. D. '05: S. N. '05.

United States. Engineer department.

Professional papers. N. D. 1+: R. P. 22, 23, 25, 26, 28.

Report of chief. R. P. '68+: S. L. '67+: S. N. '83, '07+.

Report of examination and surveys. N. D. 1+.

United States. Engineer school. Washington, D. C.

Occasional papers. N. D. 1+.

United States. Entomological commission.

Annual reports. Exp. 3-5||: P. 1-4.

Bulletins. D. 1-7||: Exp. 1-3, 5-7||.

United States. Entomology, Bureau of.

Annual report. Exp. '08, '10+: N. D. 1+.

Bulletin. D. o. s. 6, 7, 10, 13-17, 19, 21, 23, 25, 27-30, 32, 33; n. s. 4, 6, 7, 11-20, 23, 26-30, 32, 37-39, 41-44, 46-50, 52-54, 56-80, 82, 84, 86-93, 95, 97-98, 100-110, 112+: Exp. o. s. 4-25, 27-33; n. s. 1-82, 84-93, 95*, 96*, 97, 98, 100-113, 115*, 116*, 117-121, 127+: N. D. 1+: P. o. s. 6, 10, 11, 13, 14, 17, 19, 20, 22-25, 27-29, 31, 32; n. s. 1+: S. L. o. s. 1-33; n. s. 1+: S. N. o. s. 4, 6, 9-19, 22, 29, 31, 45-50; n. s. 1, 3, 4, 6-9, 25, 27-30, 52+.

Bulletin. Technical series. D. 2, 3, 10+: Exp. 1-3, 5-13, 15, 16*, 17*, 19*, 20*, 21-23*, 24, 25*, 26+: N. D. 1+: P. 1+.

Insect life. D. 1-7||: Exp. 1-7||: L. P. 2, 3*, 4, 5*, 7*||: P. 1-4, 5*, 7||: W. 1-7||.

Special report. Exp. 1-3, 5-8.

United States. Ethnology, Bureau of American.

Annual report. E. 1-26: Exp. 26: F. 2-23: L. P. 1-22: N. D. 1+: N. H. 1-28: P. 1-3, 5-19, 21+: R. P. 1+: S. L. 1-26: T. H. '79-'89, '93, '94, '96+.

Bulletin. F. 25-27: I. U. 25, 30-36, 39, 42-45, 47+: P. 33+: R. P. 1-48: S. L. 1-52: S. N. 6-23, 25-45, 47+: T. H. 25-29, 32-35, 37+: W. 1+.

Ethnological survey publications. P. 1, 2*, 4*: S. N. 1.

United States. Experiment stations, Office of.

Annual report. D. '08+: Exp. '01-'09, '11+: N. D. 1+: P. '01+: R. P. '01, '04-'07: S. N. '07-'10.

Annual report of director. Exp. '89+: P. '89, '91+.

Bulletin. Exp. 1-253, 255+: N. D. 1+: P. 1+: R. P. 1-210: S. N. 1, 3-7, 10-20, 22-25, 65-68, 80, 83-85, 88-106, 108-118, 120-130, 132+: S. L. 1+.

Experiment station record. D. 1*, 2*, 3-5, 6*, 7, 9*, 10*, 11*, 13*, 14*, 15*, 16*, 17-20, 21*, 22*, 23+: Exp. 1+: N. D. 1+: P. 1+: R. P. 3-20: S. L. 1+: S. N. 8+.

Experiment station work. Exp. 1+: P. 1+: S. N. 2.

Farmers' institute lecture. Exp. 1-14: P. 1+: S. L. 1+: S. N. 1+.

Miscellaneous bulletins. Exp. 1, 3||: P. 1-3||.

United States. Fiber investigations, Office of.

Report. D. 2-9: Exp. 1-11||: P. 1, 3-11||: R. P. 8-11||.

Continued in **United States.** Botany, Division of. *q. v.*

United States. Fisheries, Bureau of.

Bulletin. D. 1-8, 11-17, 27+: L. P. 1+: N. D. 1+: N. H. 8, 12, 15: P. 1+: R. P. 10: S. N. 1+: T. H. 1+.

Documents. P. 603*+: S. N. 602-604, 609, 610, 612, 613, 618+.

Economic circular. N. D. 1+: S. L. '12+.

Report. D. '71-'72, '78, '82, '87-'99: Exp. '91-'92: I. U. '71, '72, '73-'04: L. P. '71-'74, '77-'81, '83+: N. D. 1+: N. H. '71, '87, '04: P. '71-'77, '79-'88, '94-'06: R. P. '71-'87: S. L. '71+: T. H. '73-'04: W.

Before 1903 known as **Commission** of Fish and Fisheries.

United States. Food and drug inspection, Board of.

Food inspection decisions. P. 1+*.

United States. Forestry service.

Annual reports. Exp. '93, '97, '08, '09, '11+: P. '91-'93, '99-'06, '09.

Bulletin. D. 6, 10-12, 33, 35, 37-41, 43, 45-48, 50-52, 54-61, 63-76, 78-81, 83-97, 99-112, 115, 119, 121-123, 125+: Exp. 2, 4-22, 24-119, 121-123, 125+: F. 7, 15, 16, 20, 21, 24-26, 31-34, 41-43, 45-52, 54, 55: L. P. 15-17, 19, 20, 25-32, 34, 35, 37-58, 60, 63-66, 68-73, 75-81, 83-90, 94, 97-102, 104+: N. D. 1+: P. 2, 4-10, 12-21, 24+*: R. P. 9-74, 77, 104+: S. L. 1+: S. N. 7, 9, 30-35, 37+: T. H. 15+.

Silvical leaflets. L. P. 12, 15-24, 26-33, 35-37, 39, 41, 42: N. D. 1+: P. 1+: S. L. 3+*.

Report on forestry. S. N. 2-4.

United States. Geographical and geological survey of the Rocky mountain region.

Contributions to North American ethnology. D. 1, 3-5: P. 4-7, 9||: S. N. 6, 7, 9||.

Vol. 8 never published.

United States. Geographical and geological survey west of the 100th meridian.

Report. D. 2-7: N. D. 1-7: P. 1, 3, 7.

United States. Geological and geographical survey of the territories.

Bulletin. D. 3*, 4-6: P. 4-6*.

Report. D. 1-3, 6-11, 13||: N. D. '52: P. 1-3, 5, 6, 8-10, 12, 13||: S. N. 3, 8, 9, 11, 12.

United States. Geological exploration of the 40th parallel.

Report. D. 1-7; N. D. 1-7; P. 4, 5, 6.

United States. Geological survey.

Annual report. D. 3-5, 8, 11; E. 1-13*, 14-22*, 23+; F. 3-25; I. U. 1+;
L. P. 1+; N. D. 1+; N. H. 2+; P. 2+; R. P. '80-'91; S. L. '67-'78;
T. H. 1, 4-9, 14+.

Bulletin. E. 80-87, 90-97, 173, 177, 215, 217-222, 243; G. 400+; I. U. 1+;
L. P. 1*+; N. D. 1+; N. H. 1+; P. 1+; R. P. 1+; S. L. 1+; S. N.
1-273, 322-470, 472+.

Geologic folios. N. D. 1+; R. P. 1+.

Mineral resources of the United States. D. '67, '68, '83-'88, '91, '92; E.
'82-'99, '08; I. U. '82; L. P. '66*+; N. H. '67, '68, '83-'93, P. '67, '68,
'70, '73, '74, '76, '82-'93, '96, '97, '00+; R. P. '67, '68, '83-'93; S. N.
'83-'93, '98+; T. H. '83-'88, '91-'93, '00+.

Monographs. E. 1-52+; F. 25-48; I. U. 1-8, 10-49, 52+; L. P. 1*+;
N. D. 1+; N. H. 1-50, 52; P. 1+; R. P. 1+; S. N. 1-48, 51, 52+;
T. H. 2, 3, 6, 8, 15-18, 20, 21, 23-31, 33-46, 49+.

Professional papers. F. 1-39; I. U. 1-68, 70, 72, 73, 75+; N. D. 1+; P.
1+; R. P. 1-43, 48; S. N. 1+.

Topographic atlas. R. P. 1-3.

Water supply and irrigation papers. I. U. 1+; L. P. 1*+; N. D. 1+; P.
1+; R. P. 1+; S. L. 1+; S. N. 40-256, 261-280, 284+; T. H. 42+.

United States. Health, National board of.

Report. F. '80, '82, '83; P. '79, '80, '83.

United States. Hydrographic office.

Bulletin. N. D. 1+.

Charts. N. D. 1+.

Notices to mariners. N. D. 1+.

United States. Hygienic laboratory. See under **United States.** Public health
and marine hospital service, Bureau of.

United States. Isthmian canal commission.

Annual report. S; N. '07+; P. '05+.

United States. Life-saving service.

Annual report. R. P. '84, '07+; S. N. '01+.

United States. Lighthouse board.

Annual report. R. P. '76, '77, '79, '81, '84+.

United States. Microscopy, Division of.

Annual reports. Exp. '92: P. '91-'93.

Food products. Exp. 1, 2: P. 1-3||.

Special reports. Exp. '84, '85.

United States. Mines, Bureau of.Bulletin. P. 1-30, 34-37, 39-41, 43-53, 55, 56, 59, 61-66, 69, 71: R. P. 1+:
S. L. 1+*.

Miners' circular. P. 2-6, 8-12, 15: R. P. 3+: S. L. 2-6, 9-11.

Report. P. '11+: S. L. '11, '12.

Technical papers. P. 1-33, 36-44, 46-49, 51-55, 60: R. P. 1+: S. L. 1+*.

United States national herbarium. Washington, D. C.Contributions. D. 1*, 2, 3*, 4, 5*, 10*, 11+: Exp. 1*, 2-9, 10*, 11+: L. P.
5*, 6*, 7*, 8*, 9*, 10*, 11*, 12*, 13, 14*, 15*, 16+: N. D. 1*, 2-4, 9, 10*,
11+: P. 1+: R. P. 1+: S. N. 2+: T. H. 5+.**United States** national museum. See **Smithsonian** institution.**United States** naval medical bulletin. I. U. 1+: N. D. 1+: P. 1*, 2+:**United States.** Nautical almanac office.American ephemeris and nautical almanac. N. D. 1+: P. '83-'91, '93+:
R. P. '82, '86-'90, '94-'96, '98+: S. L. '86+: S. N. '55, '65, '69, '70',
'76, '77, '79, '80-'84, '96, '00+.**United States** naval observatory.

Annual report. R. P. '89, '90, '92, '98, '99, '01, '03.

Magnetic observations. R. P. '88-'94.

Meteorological observations. R. P. '83-'90.

Observations. S. N. '83.

Publications. P. II. 1-3, 5: R. P. II. 1+: S. L. II. 1-7: S. N. II. 6, 7.

Washington observations. D. '81-'92: P. '62, '81-'92: R. P. '86-'92.

United States. Navigation, Bureau of.

Annual report. R. P. '00-'01.

United States. Ordnance bureau.

Test of metals. R. P. '79+: S. L. '83+: S. N. '84-'00+.

United States. Ornithology and mammalogy, Division of.

Bulletin. S. L. 3-8.

Continued as **United States.** Biological survey *q. v.***United States.** Patent office.

Annual report. N. D. 1+: S. N. '47, '55, '61, '64, '99+.

Decisions of the commissioners. S. N. '99+.

Official gazette. G. 157+: L. P. 47+: N. D. 1+: N. H. '07+: P. 1+: R. P. 1+: S. L. 1+: T. H. '53-'63, '88+.

Specifications and drawings of patents. R. P. '71+: S. L. '71+.

United States. Plant industry, Bureau of.

Bulletin. D. 1, 20-23, 25, 26, 28-37, 39-43, 45-51, 53-63, 66, 68, 69, 71, 73-75, 77-135, 137-162, 165, 168, 171-173, 175-197, 199-235, 237-258, 260-272, 274, 277+: Exp. 1-91, 93-96, 98-108, 110+: F. 14, 44, 46, 90*: N. D. 1+: P. 1-45 47+: R. P. 1-148: S. L. '01+: S. N. 1-63, 65+.

Report. N. D. 1+: P. 1-4.

United States. Pomology, Division of.

Annual report. Exp. '92-'97: P. '91, '93-'95.

Bulletin. D. 1, 2, 6, 10||: Exp. 1-10||: P. 1-10||: S. N. 2, 4, 5, 7, 9, 10||.

Miscellaneous reports. Exp. '83, '96.

Continued in **United States.** Plant industry, Bureau of.

United States. Public health and marine hospital service, Bureau of.

Annual report. N. D. 1+: P. '94: S. L. '03+: S. N. '03+: T. H. '94-'97, '99+.

Hygienic laboratory. Bulletin. I. U. 70-74, 76-78: N. D. 1+: P. 1+: S. L. 8+*: S. N. -8, 10, 11, 13, 14, 16-32, 36-62, 64-78, 84+.

Public health bulletin. D. 7, 19, 22, 23, 26-28, 30, 32-35, 38-47, 49-55, 59+: S. L. 4+*.

Public health reports. N. D. 1+: P. 14+: S. L. 19+: S. N. 15-17, 20+: T. H. 11+.

Transactions of annual conference with health officers. N. D. 1+: P. 1+: S. N. '03+.

Yellow fever institute. Bulletin. N. D. 1+: P. 1+: S. N. 1, 3.

United States. Public road inquiries, Office of.

Annual report. Exp. '02, '08+: P. '03, '11+.

Bulletin. Exp. 1, 3+: N. D. 1+: P. 1-26, 28+: R. P. 16, 19-34, 38, 40+: S. N. 4+.

Circulars. Exp. 14-30, 32+: N. D. 1+: P. 14-64, 66-67, 83-85, 87, 89+: R. P. 19+.

United States. Reclamation service.

Annual report. S. N. 6+: P. 2, 4+.

Maps. N. D. 1+.

Publications. N. D. 1+.

United States. Seed and plant introduction, Section of.

Inventories. Exp. 1-8.

United States. Signal service.

Annual report of chief signal officer of the army. R. P. '79, '84, '86; S. N. '88.

Professional papers. S. N. 4, 15.

United States. Soils. Bureau of.

Annual report. Exp. '96-'01, '04, '06+: N. D. 1+: P. '97-'00, '03.

Bulletin. Exp. 1-19, 21-77, 80-93, 95+: N. D. 1+: P. 1-39, 41+: R. P. 5-56; S. L. 1+: S. N. 1-4, 17-19, 21+.

Circular. Exp. 2-6, 8-76, 79+: P. 3+: S. L. 5+*.

Field operations. N. D. 1+: P. '89+: R. P. '99-'06; S. N. '99+.

Publications. N. D. 1+.

Surveys. N. D. 1+.

United States. Standards, Bureau of.

Bulletin. D. 1+: G. 6+: N. D. 1+: P. 1+: R. P. 1+: S. L. 2-7; S. N. 2+.

Circulars. N. D. 1+: P. 1+: R. P. 2, 4+: S. L. 3+.

Conferences. D. 1+: N. D. 1+: P. 1+.

Reprints. N. D. 1+.

Technologic papers. D. 1-5, 7+: R. P. 1+: W.

United States. Statistics, Bureau of.

Bulletin. P. 22, 24, 25, 27, 77, 81-85, 88, 90, 94, 93-96, 99+: S. N. 24, 25, 27+.

Circulars. Exp. 1-13, 15+: P. 1+: S. N. 1-13, 16+.

Crop reporter. Exp. 1*, 2*, 3-7, 8*, 9-14, 15+: P. 2+.

Continues Monthly reports *q. v.*

Miscellaneous bulletin. Exp. 1-79, 81-85, 88-91, 93-96, 99+: S. N. '90-'03.

Monthly reports. Exp. o. s. 3, 5-10, 11*, 12, 13; n. s. 1, 2*, 3*, 4-6, 7*, 8:14; S. N. n. s. 112+.

Continued by **Crop reporter**, *q. v.*

Special report. Exp. o. s. 1, 2, 4, 6, 10-42, 44-63, 65.

United States. Steam engineering bureau.

Annual report. N. D. 1+.

Publications. N. D. 1+.

Specifications. N. D. 1+.

United States. Surgeon-general's office.

Index catalogue of the library. P. I. 1-3, 5-16; II. 1-10, 12+: T. H. II. 1+.

Report. N. D. 1+.

United States. Vegetable pathology, Division of.

Bulletin. D. 1-7.

Continues in **United States.** Vegetable physiology and pathology, Division of. *q. r.*

United States. Vegetable pathology, Section of.

Bulletin. D. 5, 7, 9, 10.

Continues in **United States.** Vegetable pathology, Division of. *q. r.*

United States. Vegetable physiology and pathology, Division of.

Annual report of the chief. Exp' '87, '89' '92, '96+.

Bulletin. D. 8-10, 21 23, 25; Exp. 1-10, 12-29||; P. o. s. 7, 11; n. s. 1-3
5-29||; R. P. 8-29||; S. L. 1-14, 16-19, 21-29||; S. N. 5, 8, 10, 11, 15, 16,
17, 19-21, 23, 28, 29||.

See also **Journal** of mycology.

Continued in **United States.** Plant industry, Bureau of. *q. r.*

United States veterinary association. See **American** veterinary association.

United States. War department. Report of explorations and surveys to ascertain the most practicable and economic route for a railroad from the Mississippi river to the Pacific ocean. S. N. 2, 8, 9, 12*.

Botanical report. N. D. '57.

United States. Weather bureau.

Bulletin. D. 36; Exp. 1-10, 11*, 12-16, 19, 21, 22, 24-32, 35-37; Exp. C-H,
J-Q; S. N. C, E, F, G, H, I, L, M, N, P, Q, R, S, T, K.

Monthly weather review. D. 37*, 38+; Exp. 12*, 17*, 23*, 31*, 32*,
33-36, 37*-40*; N. D. 1+; S. N. 20-23, 30+.

Proceedings of the convention of weather bureau officials. S. N. 1-3.

Report of the chief. D. '91, '06+; Exp. '00+; N. D. 1+; R. P. '91+;
S. N. '99+.

Weather bulletins. S. N. 1, 5-10, 14, 16-22, 24, 26, 28, 30-33, 35, 36+.

Weather maps. N. D. 1+.

United States. Yellow fever institute. See under **United States.**

Public health and marine hospital service. Bureau of.

Unterrichtsblätter für Mathematik und Naturwissenschaften. I. U. 1+.

Upper Iowa university.

Bulletin. Biological series. N. D. 11.

Upper Iowa university. Biology laboratory.

Contributions. P. 1-3.

Upsala (Sweden) university.

Bulletin. Ac. 1-11*.

Upsatser praktisk entomologi. Upsala, Sweden. Exp. 20-22.

- Up-to-date farming.** Indianapolis, Ind. Exp. 13*.
- Utah.** Agricultural experiment station. Logan.
Annual report. Exp. 1+: P. 1+: S. L. '98-'03*.
Bulletin. D. 69: Exp. 1+: P. 1+: S. L. '98+.
- Utah.** Farmers' institutes. Salt Lake City.
Annual report. Exp. 4, 10-13: P. 1-6, 8-13.
- Utah.** Horticultural commission. Logan.
Biennial report. Exp. '09-'12.
Bulletin. Exp. 1.
- Utah (state) horticultural society.** Salt Lake City.
Proceedings. Exp. '12.
- Utah.** Horticulture, State board of. Salt Lake City.
Biennial report. Exp. '03-'04.
- Vanderbilt university.** Nashville, Tenn.
Quarterly. I. U. 2-3, 5+: P. 1*, 2, 3*, 5*, 5-8.
- Van Nostrand's chemical annual.** New York. P. 1+.
- Van Nostrand's engineering magazine.** New York. P. 1-35||: R. P. 1-35||.
Continued in **American engineer and railroad journal.** *q. v.*
- Vegetable growers.** Chicago, Ill. Exp. n. s. 1*, 2*, 3+.
- Vegetable growers' association of Ontario.** Toronto.
Report. Exp. 1+.
- Verein deutscher Ingenieure.** Berlin, Germany.
Zeitschrift. Ft. W. 57+: R. P. 43+.
- Verein für Erdkunde.** Leipzig, Germany.
Mittheilungen. Ac. '84, '85, '94-'11.
Wissenschaftliche Veröffentlichungen. Ac. 3-7.
- Verein für Naturwissenschaft zu Braunschweig (Germany).**
Jahresbericht. Ac. '87-'09.
- Verein zum Schutze der Alpenpflanzen.** Bamberg, Bavaria.
Berichte. N. D. 12.
- Vermont.** Agricultural experiment station. Burlington.
Annual report. D. 13: Exp. 1+: P. 1, 3-8, 10+: S. L. '87, '88, '90, '91.
Bulletin. D. 83, 168: Exp. 1-159, 161+: P. 8+: S. L. 142, 143.
- Vermont.** Agriculture, State board of. North Pomfret.
Annual report. Exp. 7, 9-12: P. 5, 11-28.
- Vermont.** Agriculture, Department of. Plainfield.
Annual report. Exp. 1: P. 1+.
Bulletin. Exp. 2, 3, 5, 8-15.

- Vermont botanical club.** Burlington.
Annual bulletin. N. D. 1+.
- Vermont dairymen's association.**
Annual report. Exp. 19: P. 40-41.
- Vermont (state) geological survey.** Montpelier.
Report. N. D. n. s. 3+.
- Vermont (state) highway commission.** Montpelier.
Biennial report. N. D. 7+.
- Vermont (state) horticultural society.** Burlington.
Annual report. Exp. 2, 4, 5, 8.
- Vermont.** Library commission. St. Johnsbury, Vt.
Biennial report. Exp. 8.
- Veterinarian.** London, England. Exp. 1-62, 66-75.
After 1902 continued in **Journal** of comparative pathology and therapeutics, *q. v.*
- Veterinary journal.** London, England. Exp. n. s. 1+.
- Veterinary journal and annals of comparative pathology.** London, England.
Exp. 1-49.
- Veterinary magazine.** Philadelphia, Pa. Exp. 1, 2.
- Veterinary medical association.** London, England.
Proceedings. Exp. 1-5.
Transactions. Exp. 1-3.
- Veterinary record.** London, England.
Transactions. Exp. 1-6.
- Vick's illustrated monthly magazine.** Rochester, N. Y. N. H. 1-13.
- Victoria (Australia).** Agriculture, Department of. Melbourne
Annual report. Exp. '05-'10.
Bulletin. Exp. 1-16, 22-24.
Guides to growers. Exp. 49, 50.
Journal. Exp. 1*, 2*, 3*, 4-6, 9+.
Leaflets. Exp. 1.
Yearbook. Exp. '05.
- Victorian institute of engineers.** Victoria, Australia.
Proceedings. P. 10, 11.
- Victoria institute of Trinidad (British West Indies).**
Proceedings. Ac. 1, 2, 4.
- Videnskabs-selskabet.** Christiania, Norway.
Forhandlinger. N. D. '12+.
- Vienna.** See **Wiener**.

- Virginia.** Agricultural experiment station. Blacksburg.
 Annual report. Exp. '89-'93' '95-'06, '08+: P. '91-'94, '97-'06, '08+.
 Bulletins. Exp. 1+: P. 2+: S. L. '05+*.
- Virginia.** Agriculture, State board of. Richmond.
 Annual report. Exp. '78, '88, '92-'94, '96, '01, '03.
 Bulletin. Exp. 7, 9, 11, 13, 18, 19, 33.
- Virginia.** State crop pest commission. Richmond.
 Circular. Exp. o. s. 45; n. s. 4, 5.
- Virginia.** State entomologist and plant pathologist. Richmond.
 Annual report. Exp. 5, 8.
- Virginia** truck experiment station. Norfolk.
 Bulletin. Exp. 1+.
- Virginia** university. Charlottesville.
 Biennial report. Exp. '93, '94.
- Virginia** university. Philosophical society. Charlottesville.
 Bulletin. Science series. Ac. 1⁺-12; P. 1.
- Virginia.** State veterinarian. Blacksburg.
 Annual report. Exp. 1-3, 5.
- Wagner** free institute of science of Philadelphia (Pa.).
 Transactions. Exp. 7.
- Wallace's** American trotting register. S. L. 1-13.
- Wallace's** farmer. Des Moines, Ia. Exp. 28*, 29, 30*, 31*, 32*, 33*, 34*,
 35*, 36+: P. 30+.
- Wallace's** monthly. New York. S. L. 1-14.
- Warren** (Pa.) academy of science.
 Reports and papers. Ac. '07-'08.
 Transactions. Ac. 1⁺-2; N. D. 1+.
- Washburn** college. Topeka, Kan. Laboratory of natural history.
 Bulletin. Ac. 1⁺-7, 2⁺-3, 11.
- Washburn** observatory. See **Wisconsin** university.
- Washington** (D. C.). See **Biological** society.
- Washington** (D. C.) academy of science.
 Journal. P. 1+.
 Proceedings. Ac. 1+: I. U. 1+: N. D. 1+: P. 1+: R. P. 1-13; S. N. 1+.
- Washington** (state). Agricultural experiment station. Pullman.
 Annual report. Exp. 1-8, 10+: P. 1, 6, 8, 16+.
 Bulletin. Exp. 1-106, 109+: P. 1-8, 13, 20-26, 28-47, 49-61, 63+.
 Popular bulletins. Exp. 1, 4, 6-7, 9-12, 14-15, 18-24, 26, 28-32, 34+.
 Special bulletin. Exp. 1-6, 8+.

- Washington** (state) fruit grower. North Yakima. Exp. 3*.
- Washington** (state). Highway commission.
Biennial report. Exp. 3: P. 3.
- Washington** (state) horticultural society. Walla Walla.
Annual report. Exp. 7.
- Washington** university. St. Louis, Mo.
Record. P. '09+.
Theses. P. 7, 14.
- Washington** university association.
Bulletin. P. 1+.
- Wellcome** research laboratories. Khartoum, Africa.
Annual report. Exp. 2-4.
- West** American scientist. San Diego, Cal. Ac. 1, 3-8, 10-15*: Exp. 12*, 13*, 14*, 15*.
- West Virginia**. Agricultural experiment station. Morgantown.
Annual reports. D. 3: Exp. 1-15: P. 1+.
Bulletin. D. 3-6, 12, 14-47, 19, 22, 25-27, 30, 44, 53, 54, 64, 65, 67, 68, 69, 96, 112-116, 134: Exp. 1+: P. 1+: S. L. '10+.
Inspection bulletin of department of chemistry. P. 1+.
Report of the work of the experiment station for the destruction of the San Jose scale. Exp. '01+.
Special bulletin. Exp. 1+.
- West Virginia**. Agriculture, State board of. Charleston.
Biennial report. Exp. 3, 5-7.
Quarterly report. Exp. 1+.
- West Virginia**. Conservation commission.
Report. P. 1+.
- West Virginia** dairy association.
Annual report. Exp. 8.
- West Virginia** (state) horticultural society. Morgantown.
Annual report. Exp. 1, 13, 15, 17, 18.
- Western** architect. Minneapolis, Minn. G. 18+: N. D. 4*, 9, 10*, 11, 13*, 14*, 15, 16*, 17, 18+.
- Western** camera notes. N. D. 6*.
- Western** Canada irrigation association.
Annual report. Exp. '10.
- Western** druggist. Chicago, Ill. P. 8+.
- Western** electrician. Chicago, Ill. I. U. 34+: M. 31-43||: R. P. 4-43||.
Combined in 1908 with **Electrical** review, q. v.

- Western farmer and gardner and horticultural magazine.** Cincinnati. N. H.
5: S. L. 1-5.
- Western horticultural review.** Cincinnati, Ohio. P. 2, 3^{ll}.
Continued as **Horticultural review** and botanical magazine.
- Western lancet and hospital reporter.** Cincinnati, O. D. 12-14.
- Western New York apple.** Barker. Exp. 1*.
- Western New York horticultural society.** Rochester.
Report. Exp. 41-44, 46-56.
- Western Pennsylvania society of engineers.**
Proceedings. P. 22+.
- Western poultry journal.** Cedar Rapids, Ia. Exp. 23+.
- Western railway club.** Chicago, Ill.
Proceedings. P. 5, 6*, 7*, 8-16, 17*, 18*, 19+.
- Western society of engineers.** Chicago, Ill.
Journal. Ft. W. 18+: P. 1+: R. P. 1+.
- Western stock journal.** Oregon City, Ore. Exp. 1*, 2+.
- Westinghouse electric company.**
Bulletin. N. D. '03+.
- Wiener universität.** Institut für Anatomie und Physiologie des Centralnervensystems.
Arbeiten. I. U. 1+.
- Wilson bulletin.** Oberlin, O. N. D. 22, 23, 24+: P. 14+.
- Winnipeg (Manitoba).** City engineer of.
Report. N. D. '98, '02+.
- Wisconsin academy of sciences, arts and letters.** Madison.
Transactions. Ac. 10-16: E. 3+: P. 3+: S. L. 1-9.
- Wisconsin agricultural experiment association.** Madison.
Annual report. Exp. 3, 4, 6, 7.
- Wisconsin.** Agricultural experiment station. Madison.
Annual report. Exp. 1+: P. 1-5, 7+: R. P. '03-'07, '10+: S. L. '89-'93.
Bulletin. Exp. 1+: P. 1+: R. P. 8+.
Research bulletin. Exp. 1+: R. P. 1-14.
- Wisconsin (state) agricultural society.** Madison.
Report. S. L. '59-'68, '71-'94.
Transactions. Exp. 2, 5, 8-12, 18, 20-25: P. 1-3, 5-8, 10-34.
- Wisconsin.** Agriculture, State board of. Madison.
Annual report. Exp. '12: P. '00+.
Biennial report. P. '97-'00.
Bulletin. Exp. 1.

- Wisconsin** agriculturist. Racine. Exp. 33*, 34*, 35*, 36*, 37+.
- Wisconsin** archeologist. Milwaukee. I. U. 2+.
- Wisconsin** butter-makers' association. Madison.
Annual report. Exp. 6-9.
- Wisconsin** cane growers' association.
Annual report. Exp. 3.
- Wisconsin.** (State) conservation commission.
Report. P. '10.
- Wisconsin** country magazine. Madison. Exp. 5*.
- Wisconsin** (state) cranberry association.
Annual report. Exp. '99-'11.
- Wisconsin.** Dairy and food commission. Madison.
Annual report. Exp. '91-'94: P. '94.
Biennial report. Exp. '97, '98, '01, '02: P. '95-'10: S. N. '92, '94, '96.
- Wisconsin** dairymen's association.
Annual report. Exp. 17-20, 25, 26, 28, 35-38: P. 6-9, 17+.
- Wisconsin.** Dunn county school of agriculture. Menomonie. Exp. 3*, 4*, 5*, 6*.
- Wisconsin** farmers' institute. Madison.
Bulletin. Exp. 2, 6-8, 10: P. 1-10, 12, 14, 16-23.
- Wisconsin.** (State) forester.
Annual report. Exp. '06: P. '06+.
- Wisconsin.** Forestry commission.
Report. P. '06-'08.
- Wisconsin.** Geological and natural history survey.
Biennial reports. P. 1-5.
Bulletin. I. U. 1-7*, 8-22, 25+: P. 2-17, 20+: T. H. 1-4.
- Wisconsin.** Health, State board of.
Annual report. P. '77-'82, '84, '85, '87-'06.
- Wisconsin** (state) horticultural society. Madison.
Bulletin. D. 12: Exp. 1-5, 9-10, 12-13.
Transactions. D. 13, 19: Exp. '76, '78-'86, '91, '94-'96, '98-'01, '03, '04, '06-'08, '10+: N. D. 10: P. '74-'80, '85, '89+: S. L. '87, '88, '90-'94.
- Wisconsin** horticulture. Madison. Exp. 1*, 2+.
- Wisconsin.** Marathon county school of agriculture and domestic economy.
Wausau.
Bulletin. Exp. 2*, 3*, 4*, 5*, 6*, 9*.

- Wisconsin natural history society.** Milwaukee, Wis.
Bulletin. Ac. 1¹, 2, 2+: Exp. 7*, 8-10: N. D. 3+.
- Wisconsin public museum.** Milwaukee.
Bulletin. Exp. 1, 2.
- Wisconsin university.** Madison.
Bulletin. Exp. 141, 459, 480, 507, 508, 537, 547+.
Engineering series. E. 2: I. U. 1-4, 6+: P. 1+: R. P. 1-5, 6*.
Science series. E. 2: I. U. 1+: P. 1+.
- Wisconsin university.** Pharmacy, Department of.
Contributions. P. 1.
- Wisconsin university.** Washburn observatory.
Publications. I. U. 2-11.
- Wisconsin; Winnebago county school of agriculture.** Winneconne.
Quarterly bulletin. Exp. 3, 8, 15.
- Wissenschaftliche Beilage zum Program des Falk real Gymnasiums.** Berlin, Germany. N. D. '90.
- Woodcraft.** Cleveland, O. Ft. W. 19+: P. 8, 9, 10*, 11+.
- Wood's crop special.** Richmond, Va. Exp. 3*, 4*, 5*, 6*.
- Woodworker.** Indianapolis, Ind. Ft. W. 28+.
- Wyoming.** Agricultural experiment station. Laramie.
Annual report. Exp. '91+: P. 1+: S. L. '11, '12.
Bulletin. D. 19, 42-45: Exp. 1+: P. 1+: S. L. 83-96*.
- Wyoming.** Dairy, food and oil commissioner. Cheyenne.
Annual report. Exp. 3-5.
Bulletin. Exp. 3-10.
- Wyoming.** (State) engineer.
Report. P. 1-4.
- Wyoming historical and geological society.** Wilkes-Barre, Pa.
Proceedings and collections. Ac. 2¹, 2, 3.
- Wyoming.** Horticulture, State board of. Laramie.
Biennial report. Exp. 1-3.
Special report. P. 1*.
- Yale university.** New Haven, Conn. Astronomical observatory.
Transactions. S. L. 1*, 2*.
- Yale university.** Psychological laboratory.
Studies. I. U. 1-10; n. s. 1+: S. N. 1-10.
- Yearbook of agriculture.** Philadelphia. N. H. '56.
- Yearbook of facts (Vincent).** London, England. R. P. '75.

Yearbook of facts in science and art (Timbs). London, England. N. H. '53: R. P. '56-'68.

Yearbook of nature and popular science. New York. N. H. '73.

Zeitschrift der deutschen geologischen Gesellschaft. See **Deutsche** geologische Gesellschaft.

Zeitschrift der naturwissenschaftlichen Ableitung. Posen, Germany. N. D. 19+.

Zeitschrift für ärztliche Fortbildung. Jena, Germany. I. U. 1-6.

Zeitschrift für allgemeine Physiologie. Jena, Germany. I. U. 1+.

Zeitschrift für analytische Chemie. Wiesbaden, Germany. D. 32: Exp. 1+: I. U. 1+: N. D. 40: R. P. 34+: W. 32-40.

Zeitschrift für angewandte Chemie. Berlin, Germany. I. U. 1+.

Zeitschrift für angewandte Psychologie. Leipzig, Germany. I. U. 1-3, 5+. Beihefte. I. U. 1+.

Zeitschrift für anorganische Chemie. Hamburg, Germany. P. 1+: W. 1-68.

Zeitschrift für Biologie. Munich; Leipzig, Germany. D. 18.

Zeitschrift für Botanik. Jena, Germany. Exp. 1-3: I. U. 1+.

Zeitschrift für experimentelle Pathologie und Therapie. Berlin, Germany. I. U. 3+.

Zeitschrift für induktive Abstammung und Vererbungslehre. Berlin, Germany. Exp. 5+.

Zeitschrift für Instrumentenkunde. Berlin, Germany. P. 28+: R. P. 5.

Zeitschrift für mathematischen und naturwissenschaftlichen Unterricht. Leipzig; Berlin, Germany. I. U. 41+.

Zeitschrift für Mathematik und Physik. Leipzig, Germany. I. U. 40-51, 58+.

Zeitschrift für Morphologie und Anthropologie. Stuttgart, Germany. I. U. 1+.

Zeitschrift für pädagogische Psychologie, Pathologie, und Hygiene. Berlin, Germany. I. U. 1-12.

Zeitschrift für Pflanzenkrankheiten. Stuttgart, Germany. Exp. 1-4, 6+.

Zeitschrift für physikalische Chemie, Stochiometrie und Verwandtschaftslehre. Leipzig, Germany. I. U. 1+: P. 1: R. P. 47-56: W. 1+.

Zeitschrift für physikalische und chemische Unterricht. R. P. 3-5.

Zeitschrift für physiologische Chemie. Strassburg, Germany. I. U. 1+.

Zeitschrift für Psychologie und Physiologie der Sinnesorgane. Hamburg, Germany. I. U. 1+.

Zeitschrift für Schulgesundheitspflege. Hamburg, Germany. I. U. 1+.

Zeitschrift für Socialwissenschaft. Berlin, Germany. I. U. 7-12.

- Zeitschrift für Untersuchung der Nahrungs- und Genussmittel.** Berlin, Germany. Exp. 19+.
- Zeitschrift für wissenschaftliche Insektenbiologie.** Berlin, Germany. Ac. 7²⁻¹¹.
- Zeitschrift für wissenschaftliche Mikroskopie und für mikroskopische Technik.** Leipzig; Brunswick, Germany. D. 1-10; Exp. 1-5; I. U. 21+.
- Zeitschrift für wissenschaftliche Zoologie.** Leipzig, Germany. I. U. 46-69, 76-95, 97+; W. 63-68.
- Zentralblatt.** See **Centralblatt**.
- Zoological bulletin.** Boston, Mass. I. U. 1, 2||.
Continued as **Biological Bulletin**, *q. v.*
- Zoological record.** London, England. D. 1-24; I. U. 1-46, 48+.
- Zoological society of London, England.**
Transactions. I. U. 15*, 16*.
- Zoologisch-zootomisches Institut.** Würzburg, Germany.
Arbeiten. I. U. 9*, 10*.
- Zoologische Station zu Neapel, Italy.**
Mittheilungen. I. U. 1+.
- Zoologischer Anzeiger.** Leipzig, Germany. D. 13-17; I. U. 1+.
- Zoologisches Centralblatt.** Leipzig, Germany. I. U. 4-7, 9+.
- Zurich** (Switzerland) universität. Botanischer Garten und botanisches Museum.
Mittheilungen. N. D. '13+.

INDEX

A.		PAGE
Active Members		22
Alcohol Water Mixtures. Boiling and Condensing Points of. P. N. Evans		151
Algae. Ecological Notes on Certain White River. Paul Weatherwax.		107
An Act for the Protection of Birds, Their Nests and Eggs.....		9
An Act to provide for the Publication of the Reports and Papers of the Indiana Academy of Science.....		7
Andrews, F. M. Forests and Floods.....		203
Anderson, H. W. The Taxation of Forest Lands in Indiana.....		197
Aphanomyces Phycophilus De Bary. Paul Weatherwax.....		109
Appropriation for 1913-1914.....		9
Arisaema. The Germination of Seeds of. F. L. Pickett.....		125
B.		
Birds, Hunting Wild. Penalty.....		10
Birds, Their Nests and Eggs, An Act for the Protection of.....		9
By-laws		7
C.		
Camptosorus Rhizophyllus, Studies of. F. L. Pickett.....		129
Center of Area and Center of Population of Indiana. W. A. Cogshall..		141
Cogshall, W. A. Center of Area and Center of Population of Indiana.		141
Committees		11
Conner, S. D. Irish Potato Scab (Oospora Scabies), as Affected by Fertilizers Containing Sulphates and Chlorides.....		131
Conservation of Human Life. Playgrounds and Recreation Centers as Factors in. Dr. W. A. Gekler.....		215
Conservation of Human Life. Public Toilets, Public Drinking Fountains and Public Spitting in Relation to the. C. M. Hilliard....		219
Conservation. Joint Conference on.....		11
Conservation of Public Health. The Relation of County Tuberculosis Hospitals to. James Y. Welbourn, M. D.....		213
Constitution		5
Coulter, Stanley. First Steps in Indiana Forestry.....		189
Craven, Jay A., C. E. Sanitary Survey of Indiana Rivers.....		167
Culbertson, Glenn. The Flood of March, 1913, Along the Ohio River and Its Tributaries in Southeastern Indiana.....		57
Curators		11

D.		PAGE
Diarrhoea. An Epidemic of, Presumably Milk-borne. P. A. Tetrault..		75
Differential Equations. On the General Solution and So-Called Special Solutions of Linear Non-homogeneous Partial. L. L. Steimley....		157
Drosophila Ampelophila. Inheritance of the Length of Life in. Roscoe R. Hyde.....		113
Dryer, Charles R. Wabash Studies, IV: The Flood of March, 1913, at Terre Haute.....		55
Dryer, Charles R. Wabash Studies, V: A Topographic Map of the Terre Haute Area.....		139

E.

Evans, P. N. Boiling and Condensing Points of Alcohol Water Mixtures	151
--	-----

F.

Fellows	14
Flood, The, of March, 1913, Along the Ohio River and Its Tributaries in Southeastern Indiana. Glenn Culbertson.....	57
Flood, The Wabash River, of 1913, at Lafayette, Indiana. R. L. Sackett	63
Flood, Wabash Studies IV: The, of March 1913, at Terre Haute. Chas. F. Dryer.....	55
Forest Lands. The Taxation of, in Indiana. H. W. Anderson.....	197
Forestry. First Steps in Indiana. Stanley Coulter.....	189
Forests and Floods. F. M. Andrews.....	203
Fungous Infection. A Test of Indiana Varieties of Wheat Seed for. George N. Hoffer.....	97

G.

Gekler, Dr. W. A. Playgrounds and Recreation Centers as Factors in Conservation of Human Life.....	215
Gentian Violet. The Selective Action of, in Bacteriological Analysis. C. M. Hilliard.....	69

H.

Henry, Glenwood. On the Vertical Distribution of the Plankton in Winona Lake	77
Hilliard, C. M. Public Toilets, Public Drinking Fountains and Public Spitting in Relation to the Conservation of Human Life.....	219
Hilliard, C. M. The Selective Action of Gentian Violet in Bacteriological Analysis	69
Hoffer, George N. A simple Apparatus for the Study of Phototropic Responses in Seedlings.....	93

	PAGE
Hoffer, George N. A Test of Indiana Varieties of Wheat Seed for Fungous Infection	97
Hoffer, George N. Pyropolyporus Everhartii (Ellis and Gall) Murrill as a Wound Parasite.....	99
Hyde, Roscoe R. Inheritance of the Length of Life in Drosophila Ampelophila	113

I.

Irish Potato Scab (Oospora Scabies) as Affected by Fertilizers Containing Sulphates and Chlorides. S. D. Conner.....	131
--	-----

M.

Mance, G. C. Power Economy in Southern Indiana Quarry Industry. 223	
Members. Active	14
Members. Non-resident	14
Minutes of Spring Meeting.....	35
Minutes of Twenty-ninth Annual Meeting of the Indiana Academy of Science	37
Morrison, Edwin, and B. D. Morris. A Modified Permeameter.....	159
Mosses, The, of Monroe County, Indiana, II. Mildred Nothnagel and F. L. Pickett.....	103

N.

Nelson, R. E., J. H. Ransom and. Acyl Derivatives of O-Aminophenol	145
Nothnagel, Mildred, and F. L. Pickett. The Mosses of Monroe County, Indiana, II.....	103

O.

O-Aminophenol, Acyl Derivatives of. J. H. Ransom and R. E. Nelson.	145
Officers	11
Officers, Table of.....	13
Ohio River. The Flood of March, 1913, Along the, and Its Tributaries in Southeastern Indiana.....	57

P.

Permeameter, A Modified. Edwin Morrison and B. D. Morris.....	159
Photographic Paper. The Shrinkage of. R. R. Ramsey.....	143
Phototropic Responses. A Simple Apparatus for the Study of, in Seedlings. George N. Hoffer.....	93
Pickett, F. L. Studies of Camptosorus Rhizophyllus, etc.....	129
Pickett, F. L. The Germination of Seeds of Arisaema.....	125
Pickett, F. L., Mildred Nothnagel and. The Mosses of Monroe County, Indiana, II.....	103

	PAGE
Plankton. On the Vertical Distribution of the, in Winona Lake. Glen-wood Henry.....	77
Power Economy in the Southeastern Quarry Industry. G. C. Mance..	223
President's Address. The Work of the Indiana Academy of Science. Donaldson Bodine	43
Public Offenses—Hunting Wild Birds—Penalty.....	10
Pyropolyporus Everhartii (Ellis and Gall) Murrill as a Wound Para-site. George N. Hoffer.....	99

R.

Ramsey, R. R. The Shrinkage of Photographic Paper.....	143
Ransom, J. H., and R. E. Nelson. Acyl Derivatives of O-Aminophenol. 145	145
Relation of Lakes to Floods. The, with Special Reference to certain Lakes and Streams of Indiana. Will Scott.....	173
Report of Committee on "A List of the Scientific and Technical Ser-ials in the Libraries of the State of Indiana".....	237
Reports and Papers. An Act to Provide for the Publication of the, of the Indiana Academy of Science.....	7
Resolution of Sympathy to Hon. Charles W. Fairbanks.....	34

S.

Sackett, R. L. The Wabash River Flood of 1913, at Lafayette, In-diana	63
Sanitary Survey of Indiana Rivers. J. A. Craven, C. E.....	167
Scientific and Technical Serials. List of, in the Libraries of Indiana..	240
Scott, Will. The Relation of Lakes to Floods with Special Reference to Certain Lakes and Streams of Indiana.....	173
Steinley, L. L. On the General Solution and So-called Special Solu-tions of Linear Non-homogeneous Partial Differential Equations..	157

T.

Tetrault, P. A. An Epidemic of Diarrhoea, Presumably Milk-borne...	75
--	----

W.

Wabash River. The Flood of 1913, at Lafayette, Indiana. R. L. Sackett	63
Wabash Studies IV: The Flood of March 1913, at Terre Haute. Charles R. Dryer.....	55
Wabash Studies V: A Topographic Map of the Terre Haute Area. Charles R. Dryer.....	139
Weatherwax, Paul. Aphanomyces Phycophilus De Bary.....	109
Weatherwax, Paul. Ecological Notes on Certain White River Algae..	107
Welbourn, James Y., M. D. The Relation of County Tuberculosis Hos-pitals to Conservation of Public Health.....	203

