

1911

UNIV. OF
TORONTO
LIBRARY



PROCEEDINGS

OF THE

ACADEMY OF NATURAL SCIENCES

OF

PHILADELPHIA.

v 46

1894.

COMMITTEE ON PUBLICATION.

JOHN H. REDFIELD,

EDWARD J. NOLAN, M.D.,

THOMAS MEEHAN,

CHARLES E. SMITH,

GEORGE H. HORN, M.D.

EDITOR: EDWARD J. NOLAN, M.D.

36880
17/10/95

PHILADELPHIA:
ACADEMY OF NATURAL SCIENCES,
LOGAN SQUARE.
1895.

ACADEMY OF NATURAL SCIENCES OF PHILADELPHIA,
January 30, 1895.

I hereby certify that printed copies of the Proceedings of the Academy for 1894 have been presented at the meetings of the Academy as follows :—

Pages	9 to 24	April	24, 1894.
"	25 to 56	May	1, 1894.
"	57 to 88	May	29, 1894.
"	89 to 120	June	5, 1894.
"	121 to 144	June	12, 1894.
"	145 to 160	June	19, 1894.
"	161 to 176	July	10, 1894.
"	177 to 192	July	17, 1894.
"	193 to 208	August	21, 1894.
"	209 to 224	September	18, 1894.
"	225 to 256	September	25, 1894.
"	257 to 288	October	23, 1894.
"	289 to 320	November	20, 1894.
"	321 to 384	December	11, 1894.
"	385 to 416	January	8, 1895.
"	417 to 432	January	15, 1895.
"	433 to 448	January	22, 1895.
"	449 to 464	January	29, 1895.

EDWARD J. NOLAN,
Recording Secretary.

QH
1
A2
v. 46

LIST OF CONTRIBUTORS.

With reference to the several articles contributed by each.

For Verbal Communications see General Index.

Baker, Frank C. Further notes on the embryonic whorls of the Muricidæ	223
Brown, Arthur Erwin. On the true character and relationships of <i>Ursus cinnamomeus</i> Aud. and Bach.	119
Chapman, Henry C., M.D. Homologies of the alisphenoid and petromastoid bones in vertebrates	32
Cockerill, T. D. A. A supplementary note to Mr. Johnson's List of Jamaican Diptera	419
Cope, Edw. D. Observations on the geology of adjacent parts of Oklahoma and northwest Texas	63
Third addition to a knowledge of the Batrachia and Reptilia of Costa Rica	194
On a collection of Batrachia and Reptilia from the Island of Hainan	423
The Batrachia and Reptilia of the University of Pennsylvania West Indian Expedition of 1890 and 1891 (Plates X, XI, XII)	429
Davis, G. C. Some notes from a study of the Provancher collection of Ichneumonidæ	184
Eakins, Thomas. The differential action of certain muscles passing more than one joint	172
Ellis, J. B., and B. M. Everhart. New species of Fungi from various localities	322
Fowke, Gerard and W. K. Moorehead. Recent mound explorations in Ohio	308
Fox, William J. A proposed classification of the Fossorial Hymenoptera of North America	292
Goldsmith, E. Volcanic products from the Hawaiian Islands (Plate VI)	105
Johnson, Charles W. List of the Diptera of Jamaica with descriptions of new species	271
Jordan, David Starr. Description of a new subspecies of trout from McCloud River, California	60
Meehan, Thomas. Contributions to the life histories of plants	

No. X: The origin of coreless apples; The relations between insects and the flowers of <i>Impatiens fulva</i> ; Apetalism and seed propulsion in <i>Lamium purpureum</i> ; Fruiting of <i>Robinia hispida</i> ; The vitality of seeds; Apetalism in <i>Sisymbrium Thaliana</i>	53
Contributions to the life histories of plants, No. XI: On the morphology of bractless inflorescence; On purple-leaved plants; On the origin of the apical cell; The fall of the leaf in the holly; On bees and honeysuckles	162
Mercer, H. C. Re-exploration of Hartman's Cave, near Stroudsburg, Pennsylvania, in 1893	96
Merriam, Dr. C. Hart. A new subfamily of Murine Rodents—the Neotomiinae—with descriptions of a new genus and species, and a synopsis of the known forms (Plate IX) . . .	225
Descriptions of eight new species of Pocket Mice (genus <i>Perognathus</i>)	262
Moore, H. F. <i>Tanais robustus</i> , a new species of Anisopoda (Plate V)	90
Moore, J. Percy. <i>Pterodrillus</i> , a remarkable Discodrilid (Plate XIII)	449
Ortmann, Dr. A. A new species of the Isopod-genus <i>Bathynomus</i>	191
A study of the systematic and geographical distribution of the Decapod family <i>Atyidae</i> Kingsley	397
Pilsbry, H. A. Critical list of mollusks collected in the Potomac Valley (Plate I)	11
List of Port Jackson Chitons collected by Dr. J. C. Cox, with a revision of Australian <i>Acanthochitidae</i> (Plates II, III, IV)	69
<i>Patella Kermadecensis</i> (Plates VII, VIII)	208
Rand, Theodore D. The Sadsbury Steatite	455
Rhoads, Samuel N. Description of a new Armadillo, with remarks on the genus <i>Muletia</i> Gray	111
Contributions to the mammalogy of Florida	152
A contribution to the life history of the Allegheny Cave Rat, <i>Neotoma magister</i> Baird	213
Descriptions of four new species and two subspecies of White-footed Mice from the United States and British Columbia	253
Descriptions of a new subgenus and new species of Arvicoline Rodents from British Columbia and Washington	282
Notes on the Mammals of Monroe and Pike Counties, Pennsylvania	387
A new Jumping Mouse from the Pacific Slope	421
Scott, W. B. A new Insectivore from the White River Beds . .	446
Stone, Witmer. A revision of the genus <i>Anous</i>	115
A review of the Old World <i>Rallinae</i>	130

PROCEEDINGS

OF THE

ACADEMY OF NATURAL SCIENCES

OF

PHILADELPHIA.

1894.

JANUARY 2.

The President, GENERAL ISAAC J. WISTAR, in the chair.

Forty persons present.

The deaths of Richard R. Robb, September 12, 1893, and of Joseph D. Potts, December 3, 1893, members, were announced.

A paper entitled "Description of a new subspecies of trout from McCloud River, California," by David Starr Jordan, was presented for publication.

The Council reported that the following Standing Committees had been appointed to serve during the ensuing year:—

ON LIBRARY.—W. S. W. Ruschenberger, M. D., Henry C. Chapman, M. D., Gavin W. Hart, Charles P. Perot and J. Bernard Brinton, M. D.

ON PUBLICATIONS.—John H. Redfield, Charles E. Smith, Thomas Meehan, George H. Horn, M. D. and Edward J. Nolan, M. D.

ON INSTRUCTION AND LECTURES.—Charles Morris, Benjamin Sharp, M. D., Samuel G. Dixon, M. D., George A. Rex, M. D. and Uselma C. Smith.

STANDING COMMITTEE OF COUNCIL ON BY-LAWS.—W. S. W.

Ruschenberger, M. D., Theodore D. Rand, William Sellers and Isaac J. Wistar.

JANUARY 9.

The President, GENERAL ISAAC J. WISTAR, in the chair.

Thirty-three persons present.

The deaths of Henry Pratt McKean, a member, January 5, 1894, and of P. J. Van Beneden, a correspondent, January 8, 1894, were announced.

A paper entitled "Contributions to the Life-Histories of Plants, No. X," by Thomas Meehan, was presented for publication.

JANUARY 16.

The President, GENERAL ISAAC J. WISTAR, in the chair.

Forty-four persons present.

JANUARY 23.

Mr. CHARLES MORRIS in the chair.

Forty-one persons present.

JANUARY 30.

The President, GENERAL ISAAC J. WISTAR, in the chair.

Thirty-five persons present.

The death of Paul Fischer, a correspondent, November 29, 1893, was announced.

The following were elected members :—J. Lewis Crew, Milton J. Greenman, M. D., Frank J. Keely, Edward K. Tryon, Jr. and William S. Vaux, Jr.

The following were ordered to be printed :—

CRITICAL LIST OF MOLLUSKS COLLECTED IN THE POTOMAC VALLEY.

BY H. A. PILSBRY.

The mollusks enumerated in this paper were collected by Mr. J. E. Ives and the writer during the course of a pedestrian tour through parts of Pennsylvania, Maryland and West Virginia, in September, 1892. The route walked over was as follows: From Gettysburg, Pa., westward to the summit of South Mountain, thence southwest to Maryland, across the Cumberland Valley to Hagerstown, Md. From this point the Cumberland Pike (State road) was followed, with occasional slight deviations, westward to Cumberland, Md. From Cumberland, Mr. Ives proceeded to Luray, Va., across the multitude of ranges which traverse West Virginia. The writer returning to Philadelphia, stopping to collect at Cherry Run, on the Potomac River, in West Virginia.

On such a trip one is constantly tempted to stop by the wayside to examine or collect; and if he be possessed of that passion for collecting "specimens" which is the fatal birthright of most naturalists, these interruptions of the journey are likely to be many and long. The eye soon learns to recognize good collecting-ground; and the mere consideration that supper and a resting-place are miles farther on, is lightly esteemed when the charms and hidden possibilities of a wooded ravine weight the balance. The number of localities represented in this collection is therefore great, as would be expected from the above considerations. Probably almost all of the species of mollusks inhabiting Maryland, from the South Mountain to Cumberland, were found by us; and as the southern tier of counties in Pennsylvania is identical with Maryland in geologic and topographic features, the list practically tells what that portion of Pennsylvania contains of land and fresh-water shells. The list of a collection made by Mr. Witmer Stone at York Furnace, York Co., Pa., has been kindly furnished by him, and the species occurring there are noted herein.

The general topography and geology of these portions of Pennsylvania and Maryland are well known. South Mountain, the Blue Ridge, Martin's Mountain, Sideling Mountain, Town Ridge, Wills Mountain, and numerous smaller intermediate ridges, cut this district into a series of wide and narrow valleys, trending N. E. by S. W.;

each valley supplying a creek tributary to the Potomac. The valleys are mostly eroded anticlines, so that a great variety of strata are exposed; but sandy shales and shaly sandstones predominate.

The Potomac crosses this series of parallel ridges nearly at a right angle. It is everywhere shallow and rapids are frequent. At Cumberland it is dammed, and all the water which is not used by the city water-works feeds the Chesapeake and Ohio Canal, which has its western terminus here. Above the backwater from this dam it is a shallow rapid stream from forty to sixty feet wide, with a rocky, or in places, gravelly bed; and the low banks are fringed with graceful maple, willow and sycamore trees, often festooned with grape vines, and in places mingled with oak and locust. The water here is of a dark sepia tint, being stained by the spruce sawdust from saw-mills upon its upper course, and probably also by decaying laurel and bay leaves, for the region above is densely wooded. No mollusk life whatever could be found in this brown water, but minnows and tadpoles were seen. Below the dam at Cumberland the wide river-bed is dry, except for occasional pools, in which a few *Planorbis bicarinatus* and *Amnicola limosa* live.

Except in times of high water therefore, the lower course of the river is an entirely distinct stream from this upper reach. About ten miles below Cumberland the river has about the same volume as the stream above the influence of the Cumberland dam, and the water is clear.

Wills Creek, which flows through the city of Cumberland, is a swift stream with a rocky bed. The water is of crystal transparence, but no snails except *Planorbis bicarinatus* were found in it. Ewitt's Creek, which drains the valley next eastward, contains *Anculosa* in abundance.

Family SELENITIDÆ.

This family differs from *Zonitidæ* in having the teeth of the radula all "aculeate," and in lacking pedal grooves above the foot-edges.

Genus SELENITES Fischer.

Selenites concavus Say.

Cumberland, Allegheny County, Md., 64,679. Morgan County, W. Va., opposite Hancock, 64,678. It has been taken by Mr. W. Stone at York Furnace, York County, Pa., and by Mr. C. W.

Johnson in Fulton County, Pa. It occurs over nearly the whole of eastern North America.

Family ZONITIDÆ.

A complete rearrangement of the American genera of this family is necessary, and although a local faunal list may be considered hardly the place for radical changes in nomenclature, still it may be preferable to the perpetuation of an untenable system. The species which were formerly referred to the genus *Zonites* will now be distributed into several genera, distinguished by important structural peculiarities.

The genus *Zonites* of Montfort has no representative in America, being confined to the circum-Mediterranean and adjacent faunas. In this genus the shell is large, solid, opaque and discoidal, and is always strongly carinated, at least when young. The jaw has a strong median projection; the genitalia lack all accessory organs, being of the haplogonous type. The synonymy of the genus is as follows:

1810.—*Zonites* Montfort, Conchyliologie Systématique, II, p. 282.

Type *H. algira* L.

1833.—*Ægopsis* Fitzinger, Syst. Vers, p. 99. *H. verticillus*.

1837.—*Tragomma* Held., Isis, p. 916. *H. acies* Partsh.

1847.—*Helicodes* Dumas, Comp. Rend., XXV, p. 113. *H. algira*.

1849.—*Helicella*, in part, of Férussac, Prodrom. and of Risso, Hist. Nat. Eur. Mérid., IV, p. 68 (1826), and of Beck, Index (1837).

1855.—*Verticillus* Moq.-Tand. Hist. Nat. Moll. Fr., p. 91. *Z. algirus*.

Not *Zonites* of American authors!

Genus OMPHALINA Rafinesque.

Omphalina Raf., Enumeration and Account of some remarkable Natural Objects in the cabinet of Prof. Rafinesque, in Philadelphia, p. 3. November, 1831. (Type *O. cuprea* Raf., = *H. fuliginosa* Griff.). Binney & Bland, Land and Fresh-water Shells of N. A., p. 283. 1869. Tryon, Amer. Journ. Conch., II, p. 247. 1866. V. Martens, Biol. Centr. Amer., Mollusca, p. 104. 1892.

Mesomphix (in part), Beck, Index Moll. p. 7. 1838.

Neozonitina Pfeffer, in Strebel's Beitr. Mex. Land u. Süss-W. Conch., IV, p. 1. 1880.

Edusa Alb., Die Heliceen (2), p. 72. 1866. (Type *H. zonites* Pfr.).

Moreletia Gray, Pulm. Brit. Mus., p. 148. 1855. (Type *H. euryomphala* Pfr.).

Zonulina Martens, Mal. Bl., 1865, p. 16. (Type *H. bilineata* Pfr.).

Patulopsis Strebel & Pfeffer, l. c. (Type *P. carinatus* Str.)

Zonites, s. g. *Mesomphix* Binney, Terr. Moll., V, p. 98. 1878.

The generic characters of this group are as follows:

Shell rather large and solid but thin, umbilicated, smooth below, lacking teeth or folds within; the lip simple and sharp.

Foot double grooved above its margin, the grooves meeting above the tail in a mucus pore; sole tripartite; dorsal surface from head to mantle entirely lacking longitudinal grooves.

Genital system lacking dart sac and other accessory glands. See under *O. fuliginosa*, below.

This genus contains the large Zonitoids of North America. It has not been recognized as yet in Palearctic regions.

O. fuliginosa Griff. Pl. 1, fig. 5.

York Furnace, York County, Pa., 63,857. Collected by Witmer Stone. No specimens were found by us in Maryland.

The genital organs of this species and its allies seem to have been misinterpreted by writers on United States forms, who have mistaken the swollen base of the vas deferens for the penis, and have considered the penis itself to be a dart sack or prostate gland of some sort.

In *O. fuliginosa*, the penis (*P.*), is a rather short stout sac, with the retractor muscle (*r. p.*) inserted at its apex, and attached distally to the floor of the lung. Internally the distal half of the cavity of the penis is densely, finely and rather sharply granulated; the opening of the vas deferens is near the apex of the cavity, and is not provided with a papilla. The lower portion of the vas deferens (*v. d.*) is enormously swollen; and for a short distance from its insertion it is firmly bound to the penis itself.

The vagina (*vag.*) is curiously swollen near the base. The spermatheca (*sp.*) is large, subglobular, and together with its rather long duct, is bound firmly to the oviduct. The albumen gland (*a. gl.*) is uncommonly large.

The figure is drawn from a specimen collected by Mr. Witmer Stone at York Furnace, York County, Pa. (No. 63,857). Several

individuals from different localities were examined and found to agree in the characters described.

Genus **VITREA** Fitzinger.

- (1817.—Not *Hyalina* Schumacher, Syst. Vers. Test., p. 234, belongs to *Marginellide*).
- 1819.—S. g. *Helicella*, *Les Aplostomes*, ** *Les Hyalines*, *Hyalinae*, Férussac (includes the European translucent zonitoids and many exotic species of various genera).
- (1820.—Not *Hyalina* Studer, Syst. Verzeich. Schweiz Conch., p. 11, = *Vitrina* Drap. 1805).
- 1833.—*Vitrea* Fitzinger, Syst. Verzeich., p. 99.
- 1833.—*Oxychilus* Fitz., l. c., p. 100, in part, not *Oxycheila* Dejean, 1825.
- 1837.—*Hyalinia* Agassiz, in Charpentier, Nouv. Mém. Soc. Helv., i., p. 13.
- 1837.—*Polita* Held., Isis, p. 916 (proposed for *cellaria* Müll., *glabra* Stud., *nitens* Mich., *nitidula* Fir., *lucida* Dr., *nitidosa* Fér., *clara* Held., *lenticularis* Held., *crystallina* Müll., *hyalina* Fér., *contorta* Held., *fulva* Müll.).
- 1854.—*Lucilla* Lowe, Proc. Zool. Soc. Lond., p. 177, type *H. cellaria*, Müll.
- 1854.—*Crystallus* Lowe, Proc. Zool. Soc. Lond., p. 178, type *H. crystallina* Müll.
- 1855.—*Aplostoma* Moq.-Tand. Hist., Nat. Moll. France, II, p. 72. (Includes *nitidus*, *olivetorum*, *lucidus*, *cellarius*, *glaber*, *allivrius*, *nitidulus*, *nitens*, *striatulus*, *purus*, *crystallinus*).
- 1857.—*Euhyalina* Albers, Malak. Blätter, IV, p. 91, type *H. cellaria*.
- 1879.—*Aegopina* Kobelt, Iconogr. Eur. Landund Süßwasser Moll., VI, p. 15 (proposed as a substitute for *Mesomphix* of European authors, not of Rafinesque. Type *H. olivetorum* Gm.).
- 1880.—*Diaphanella* Clessin, Mal. Bl. (n. F.), II, p. 206, type *H. diaphana* Stud.
- 1880.—*Mediterranea* Clessin, l. c. type *H. hydatina* Rossm.
- 1886.—*Hydatina* Westerlund, Fauna, etc., p. 37, type *H. hydatina* Rossm.
- 1886.—*Anomphala* West., l. c., p. 29, types *parthenica* and *diaphana*.
- 1891.—*Vitrea* Fitz., E. A. Smith, Journ. of Conch., VI, p. 337, 339.
- 1892.—*Glyphyalinia* Martens, Biol. Cent. Amer., Mollusca, p. 117. (*H. indentata* Say, etc.). *Zonites* of many authors, not of Montfort.

This genus consists of small glassy zonitoid snails having no ac-

cessory organs developed upon the genital system, differing in this respect from the *Zonitoides* section of *Gastrodonta*. The type of *Vitrea* is *H. crystallina* Müller of Europe. There are a great many generic synonyms, but part of the names quoted above are available for sectional divisions. The American species must all be examined to ascertain whether or not they possess a dart sac, as those having this structure must be removed to the genus *Gastrodonta*. I have not had time to examine the soft parts of any of them.

V. arborea Say.

Monterey, Franklin Co., Pa., 64,696, S. E. cor. Franklin Co., Pa., near Maryland line, 64,693. Foothills of Martin's Mt., Md., 64,694. Morgan Co., W. Va., opposite Hancock, 64,695. Also collected at York Furnace, York Co., Pa., by Witmer Stone.

V. electrina Gld.

Summit of North Mountain, west of Clear Spring, Washington Co., Md., 64,836. Monterey, Franklin Co., Pa., 64,859.

V. (Glyphyalinia) indentata Say.

Monterey, Franklin Co., Pa., 64,838. Summit of North Mountain, west of Clear Spring, Md., 64,837. Morgan Co., W. Va., opposite Hancock, 64,692. Also York Furnace, York Co., Pa. (Stone).

Genus **GASTRODONTA** Albers.

1850.—*Gastrodonta* Alb., Die Heliceen, p. 88.

1857.—*Gastrodonta* Alb., Mal. Bl. IV, p. 91, type *H. interna* Say.

1862.—*Zonitoides* Lehmann, Mal. Bl. IX, p. 111, type *Z. nitidus* Müll.

1864.—*Pseudohyalina* Morse, Terr. Pulm. Me., p. 15, (for *H. exigua*, *minuscula*, *limatula*, etc.).

1869.—*Ventridens* Binney and Bland, Land and Fresh-water Shells of N. A., I, p. 292 (proposed for *H. gularis* and *H. suppressa* Say).

The shell is provided with internal teeth or lamellæ in the typical forms of this genus. In another group, consisting of *G. ligera* and its allies there are no teeth, but a strong white callus upon the floor of the last whorl. In the section *Zonitoides* this callus is wanting, and the whorls are rounded below.

The prominent feature of the genitalia is the presence of a dart sac containing a long curved calcareous dart, situated upon the va-

gina; and this is the most important generic character. In Pl. I, fig. 4, is shown the dart of *G. ligera*, magnified twelve diameters.

There are strong reasons for believing that the presence of a dart, the coronal glands being correlated with it, is a very old character in *Zonitidæ*, and that it was present in the undifferentiated stock from which nearly all the existing genera have diverged.¹ If this be true, then *Vitrea*, *Omphalina*, etc., must be regarded as secondarily haplogonous, having lost the dart apparatus which was present in their ancestors.

G. suppressa Say.

Gettysburg, Adams County, Pa., 64,083. Monterey, Franklin County, Pa., 64,087. Also at York Furnace, York County, Pa. (Witmer Stone). In Maryland at Cave Town, 64,084, and Summit of North Mountain, 64,080; Martin's Mountain, 64,680, between Green and Polish Mts., 64,682. Cumberland, Allegheny Co., 64,685, and Morgan Co., W. Va., opposite Hancock, 64,681.

G. ligera Say.

All of the specimens were small, shining and smoother than usual, measuring about 11 mm. in diameter, the umbilical perforation minute, about .3 mm. wide. Gettysburg, Pa., 64,697. Chewsville, Washington Co., Md., 64,690. Ten miles west of Hancock, Md., 64,689; Cumberland, Allegheny Co., Md., 64,688.

Family ENDODONTIDÆ.

Genus PYRAMIDULA Fitzinger.

The generic names used in this paper for *Helices* are fully explained in the writer's guide to the *Helices*, now being published.

P. alternata Say.

Chewsville, Washington Co., Md., 64,698. Martin's Mountain, Md., 64,699, 64,700. West Virginia, opposite Hancock, Md. Cumberland, Md., 64,697. Collected by Stone at York Furnace, York Co., Pa.

P. striatella Anth.

Hanover, York Co., Pa., 64,703. A delicate, fine-ribbed form.

¹ Perhaps excepting *Conulus*, *Microcystis*, etc.

The southeastern limit of distribution of this species is still to be mapped.

P. perspectiva Say.

Cumberland, Md., 64,702. Morgan Co., W. Va., opposite Hancock, 64,701. The specimens from Cumberland are uncommonly coarse-ribbed. Morgan County is probably the eastern limit of distribution for this species.

P. lineata Say.

Gettysburg, Adams Co., Pa., 64,705. Monterey, Franklin Co., Pa., 64,704.

Family HELICIDÆ.

Genus POLYGYRA (Say 1818) Pils. 1889.

Polygyra Say, 1818 + *Mesodon* Raf., 1831, + *Stenotrema* and *Triodopsis* Rafinesque, 1819.
Neohelix v. Ihering, 1892.

P. hirsuta Say.

The specimens from this region are all small, measuring from 6 to 6.5 mm. diameter, and 4 to 4.5 mm. height. Monterey, Franklin Co., Pa., 64,731. Cave Town, Wash. Co., Md., 64,732. Summit of North Mountain, west of Clear Spring, Washington Co., Md., 64,729. Martin's Mountain, 64,730. Between Green and Polish Mts., 64,726. Cumberland, Allegheny Co., Md., 64,724. Morgan Co., W. Va., opposite Hancock, 64,728. Found by Stone at York Furnace, York Co., Pa.

P. monodon Rackett.

Gettysburg, Adams Co., Pa., 64,739. Monterey, Franklin Co., Pa., 64,740. Cave Town, Washington Co., Md., 64,738. Between Green and Polish Mts., Md., 64,726. Martin's Mountain, 64,736. Cumberland, Md., 64,735. Morgan Co., W. Va., opposite Hancock, 64,737. The specimens from Pennsylvania would fall under the "variety" *fraterna*, having the umbilicus wholly closed. This species was collected by Stone at York Furnace, York Co., Pa.

P. thyroides Say.

Ten miles west of Hancock, Md., 64,712. West Va., opposite Hancock. Cumberland, Md., 64,711, abundant. Like Philadel-

phia specimens, these have a wide range of variation in size and degree of closure of the umbilicus. Seven out of the nine adults preserved from Cumberland, have developed a strong parietal tooth. Collected by Stone at York Furnace, York Co., Pa.

P. albolabris Say.

Monterey, Franklin Co., Pa., 64,707, large (31 mm. diam.), solid and dark colored. Cave Town, Washington Co., Md., 64,708, small, (26 to 28 mm. diam.) and solid. Fairview, top of North Mountain, Md. Foothills, 64,706, and summit, 64,709, of Martin's Mt., Allegheny Co., Md., small specimens. Cumberland, Md., 64,710, large and solid, measuring 32 mm. diameter. West Virginia, opposite Hancock, Md.

It is curious to note that the specimens from Franklin Co., Pa., collected in a porphyritic region, should markedly exceed in size those from Cave Town and Martin's Mountain, Md., tracts rich in limestone, the soil being mainly formed by its disintegration. The smallest specimens (22 mm. diam.) were collected at the foot of Martin's Mountain. Stone collected this species at York Furnace, York Co., Pa.

P. palliata Say.

Cumberland, Md., 68,713, typical. Collected also by Stone at York Furnace, York Co., Pa., where he found it only in hemlock woods. In the Catskill Mountains I have found it under the loose bark of fallen hemlock boles.

P. tridentata Say. Pl. 1, Fig. 7.

Cumberland, Md., 64,714. Typical specimens in every respect, measuring 13 mm. in diameter. Also found in Morgan Co., W. Va., opposite Hancock, 64,715. In both localities associated with *P. fraudulentus*.

It must be distinctly understood that Say's types of this species were the small forms found in the "Middle States." Say describes it as "half an inch wide." He afterward collected the large form in the Ohio basin, referring it to the same species. This large form should be regarded as a geographic race. In Terr. Moll., III, the typical form is figured on Pl. XXVII, side figures, and the large race is shown in the upper, lower and central figures of the same

plate. Binney's wood-cuts (Man. Amer. L. Sh. etc.) represent the large form from Ohio.

P. tridentata juxtidentis n. var. Pl. 1, Fig. 8.

Cave Town, Md., 64,720; very numerous in stony places. This is a limestone region, and the red soil is largely the result of limestone decomposition. The same form of *Triodopsis* was found at Gettysburg, Pa., 64,719, and in Allegheny Co., Md., between Green and Polish Mountains, 64,716, Chewsville, Md., 64,717, at Fairview, summit of North Mountain, Md., and in Morgan Co., W. Va., opposite Hancock, 64,718. It is common around Philadelphia, where typical *tridentata* also occurs.

This form is distinguished from typical *tridentata* by the lower position of the upper lip-tooth, the latter part of the parietal lamella being directed toward this tooth or to a point above it, whilst in the type the lip-teeth are more separated and the latter portion of the parietal lamella is directed toward a point on the peristome between them. The variety is more coarsely striated also. The number of whorls (5) is the same in variety and type. The measurements of three individuals are as follows:

Alt.	7	diam.	14	mm.	(Philadelphia).
"	6 $\frac{1}{2}$	"	13 $\frac{1}{2}$	"	(Cave Town, Md., largest).
"	6	"	11	"	(" " " smallest).

The upper lip-tooth is sometimes broader than the lower, and occasionally a trifle "inflected." The parietal blade is slightly arcuate.

P. tridentata fraudulentata n. var. Pl. 1, Fig. 6.

Morgan Co., W. Va., opposite Hancock, Md., 64,724 and 64,725; Cumberland, Md., 64,723. At both of these localities it is found living with typical *P. tridentata*.

In its typical development this variety is a compact shell of a reddish-brown color (varying to white in some localities); the spire is low-convex, composed of six closely coiled whorls, the last being notably deflexed in front and strongly constricted behind the lip. The aperture is strongly "dished" or basin-shaped; the outer lip bears a broad tongue-shaped inflected tooth, situated at the position of the periphery of the shell. The middle of the basal lip bears a small squarish tubercle, which is often laterally compressed. The parietal

wall bears an elevated oblique blade which is typically almost straight and never much curved.

Alt. $8\frac{1}{2}$ diam. $16\frac{1}{2}$ mm. (No. 64,725).

“ $6\frac{1}{2}$ “ 13 “ (No. 64,723).

The tooth upon the outer lip is generally bifid. Binney's figures of *Triodopsis fallax* (Man. Amer. L. Sh., p. 292, fig. 314) represent a form of this subspecies, but not its typical development. That this is not the true *H. fallax* of Say will be evident to anyone comparing it with the original description. The characters of the two are best shown in the following table :

P. fraudulentæ.	H. fallax, Say's description.
Spire moderately convex.	Spire convex, higher than in <i>tridentata</i> .
Whorls six.	Whorls five.
Parietal tooth straight or nearly so.	Parietal tooth "curving downwards."
Diameter 13 to 17 mm.	Diameter $11\frac{1}{2}$ mm.
Habitat: Cumberland Mountain system, extending northward along the mountains to Maryland and westward throughout the Ohio Valley.	Locality, "vicinity of Philadelphia."

No shells exhibiting the characters of *fraudulentæ* have been found in the cis-Alleghenian region of eastern Pennsylvania or New Jersey, so far as I can judge by the collections of Philadelphia conchologists, which cover a great many localities and a long series of years. This region is inhabited by typical *tridentata*, its variety *justidens*, and by the "*H. introferens*" of Bland and authors generally.

P. fallax Say.

Gettysburg, Pa., 64,722. The variations of the *tridentata* group of *Triodopsis* are an extremely intricate study, and strange as it may seem, the names hitherto attached to some of the forms require revision. *Helix fallax* was described by Say from the vicinity of Philadelphia; but the form heretofore so called is not found near Philadelphia, nor has it been within the present century, if ever. The *Triodopses* found in this vicinity are (1) *P. tridentata* Say, typical; (2) *P. tridentata justidens*; and (3) *P. introferens* Bland. These three forms are represented in the collection of the Academy by speci-

mens collected many years ago as well as by others taken during the past year; and no other forms or species have to my knowledge been found anywhere near Philadelphia.

The conclusion that one of these three is the *jallax* of Say is therefore an extremely probable one. Upon turning to Say's original description (*Journ. Acad. Nat. Sci.*, V, p. 119) we find that it applies exactly to the shell known as *Helix introferens* Bld. Say mentions the parietal tooth "curving downwards so as to nearly reach the termination of the labrum" and says: "This resembles the *tridentatus* nob., but the upper tooth of the labrum is much inflected, the spire is more elevated, and the size is less considerable." He gives the diameter as "nine-twentieths of an inch," which is exactly the size of the Philadelphia "*introferens*." It should be added that Say's types of *tridentatus* and *jallax* are no longer in existence. In view of the facts of the case, it seems to me necessary to use Say's name *jallax* for the species hitherto called *introferens*, the latter becoming a synonym.

The prominent features of this shell, besides its elevated spire and inflected upper tooth, are the angular curvature of the parietal tooth, and the continuation inward of the basal tooth and the callus around the "profound sinus" between the two lip-teeth.

Genus STROBILOPS Pilsbry.

S. virgo Pilsbry.

Near Monterey, Adams Co., Pa., 68,835.

Family PHILOMYCIDÆ.

Genus PHILOMYCUS (Raf.) Fér.

P. carolinensis (Bosc.) Fér.

Southeastern slope of North Mountain and Cumberland, Md.; Monterey, Pa. Stone collected it at York Furnace, York Co., Pa. Also seen at Fairview, summit of North Mountain, Md.

P. pennsylvanicus Pilsbry, n. sp.

A maculated species having the jaw strongly ribbed. It is smaller and less distinctly marked than *P. carolinensis*. Full description with anatomical details will be given later.

York Furnace, York Co., Pa. (Witmer Stone!). South Mountain, near Pa. and Md. State boundary.

Family PUPIDÆ.

Genus LEUCOCHILA Martens.

L. fallax Say.

Cave Town, Washington Co., Md., 64,786; Martin's Mountain,
Allegheny Co., Md., 64,785.

Genus PUPA Drap.

Subgenus Bifidaria Sterki.

P. armifera Say.

Gettysburg, Pa., 64,783. Cave Town, Md., 64,784.

Section Vertigopsis Sterki.

P. pentodon Say.

Green and Polish Mts., Allegheny Co., Md., 64,787.

Genus VERTIGO Müller.

V. ovata Say.

Green and Polish Mts., Allegheny Co., Md., 64,840.

V. edentula simplex Gld.

Was collected by Witmer Stone at York Furnace, York Co., Pa.

Family SUCCINEIDÆ.

Genus SUCCINEA Draparnaud.

S. obliqua Say.

Morgan Co., West Virginia, opposite Hancock, 64,734.

S. avara Say.

Monterey, Franklin Co., Pa., 64,733.

S. ovalis Gld.

Was collected by Witmer Stone at York Furnace, York Co., Pa.
We did not find it in Maryland.

Family LIMNÆINÆ.

Subfamily Limnæinæ.

Genus LIMNÆA Lam.

L. desidiosa Say.

Concocheague River, Md., 64,802. Patterson's Creek, Mineral

Co., West Virginia, 64,803. Found by Mr. Stone at York Furnace, York Co., Pa., where *L. humilis* Say, *L. columella* Say and *L. caperata* Say also occur.

Subfamily Planorbinae.

Genus **PLANORBIS** Guet.

P. trivolvis Say.

Canal at Hancock, Md., 64,800, also York Furnace, York Co., Pa. (Stone).

P. bicarinatus Say.

Gettysburg, Pa., 64,795. Conococheague River, Md., 64,798. Potomac R., at Hancock, Md., 64,794. Flintstone Creek, Flintstone, Md., 64,788. Evitts' Creek, near Cumberland, Md., 64,793. Cumberland, Md., 64,792. Patterson Creek, Mineral Co., W. Va., 64,791. S. Branch Potomac R., 4 miles from Romney, W. Va., 64,797. Warm Spring Creek, Morgan Co., W. Va., opposite Hancock, 64,796. North River, Sedan, Hampshire Co., W. Va., 64,790. Potomac River at Cherry Run, W. Va., 64,789. South Fork Shenandoah River, near Luray, Va., 64,799. Also York Furnace Pa. (Stone).

Throughout this region *P. bicarinatus* and *Physa heterostropha* are ubiquitous aquatic species.

P. parvus Say.

Canal at Hancock, Md., 64,801. Also York Furnace, Pa. (Stone), with *Segmentina armigera*, Say.

Subfamily Ancylinae.

Genus **ANCYLUS** Geoff.

A. rivularis Say.

Piny Creek, Gettysburg; Pa., 64,804. Between Green and Polish Mts., Allegheny Co., Md., 64,805. Warm Spring Creek, Morgan Co., W. Va., 64,806.

Family **PHYSIDÆ**.

Genus **PHYSA** Drap.

P. heterostropha Say.

Gettysburg, Pa., 64,814. Conococheague River, Washington

Co., Md., 64,808. Potomac River at Hancock, Md., 64,810. Town Creek, Allegheny Co., Md., 64,807. Flintstone Creek at Flintstone, Md., 64,815. Evitt's Creek, near Cumberland, Md., 64,816. Potomac River, 3 miles below Cumberland, 64,811. Patterson's Creek, Mineral Co., W. Va., 64,812. Potomac River, at Cherry Run, W. Va., 64,813. A small creek flowing into Little Cacapon River, Hampshire Co., W. Va., 64,817. South Fork Shenandoah River, near Luray, Va., 64,819. Also York Furnace, Pa. (Stone).

One lot, 64,807, shows a strong tendency toward the obeseness so characteristic of the transition forms between *heterostropha* and *ancillaria* found at Philadelphia and Washington. All of the others are very near the type of *heterostropha*.

Family VIVIPARIDÆ.

Genus CAMPELOMA Rafinesque.

C. decisum Say.

Potomac River at Hancock, Md., 64,751. Potomac River at Cherry Run, W. Va., 64,752. Typical at both localities. Stone collected it at York Furnace, York Co., Pa., with *Lioplax subcurinata*.

Family AMNICOLIDÆ.

Genus AMNICOLA G. & H.

A. limosa Say.

Very numerous in the canal at Hancock, Md., 64,755. Conococheague River, west of Hagerstown, Md., 64,756 (small form). Also found at York Furnace, York Co., Pa., by Witmer Stone.

Genus GILLIA Stimp.

G. altilis Lea.

Canal at Hancock, Md., 64,782. Potomac River, at Cherry Run, W. Va., 64,781.

An abundant species throughout the drainage of the Chesapeake and Delaware Bays. Stone found it at York Furnace, York Co., Pa.

Genus **BYTHINELLA**, Auct.

B. nickliniana Lea.

Conecocheague River, west of Hagerstown, Md., 64, 757.

Family **PLEUROCERIDÆ**.Genus **ANCULOSA** Say.

A. carinata Brug.

This species is the characteristic mollusk of perennial streams in the Chesapeake Bay river-system. It has been found only in waters of this drainage, being unknown in the adjacent Delaware system on the north-east, in the Ohio system on the west, and in streams emptying into the Atlantic to the south of Chesapeake Bay.

Anculosa being essentially a trans-Alleghenian genus, we may with considerable confidence surmise that the ancestors of *A. carinata* were introduced into the head waters of the Potomac from some creek of the Ohio system, and from this colony spread throughout the Chesapeake drainage. The fact that it inhabits the James River and other Virginian streams which are now isolated from the Potomac and Susquehanna by a long stretch of salt water, indicates that since the introduction of *Anculosa*, and the differentiation of the species *carinata*, the Chesapeake region has been much more elevated than it is at present. *Anculosa* can endure neither salt nor slow-flowing water; and it must have spread to these various streams at a time when the united waters of the Susquehanna, Potomac, Rappahannock and James Rivers flowed in one mighty stream to the Atlantic. It may be suggested that the distribution has been accomplished overland; but this is highly improbable; for if so, why is the species so strictly limited to the Chesapeake system? Why has it not invaded the Delaware-Schuylkill drainage, which offers equally favorable stations, and is separated by but a few miles from the eastern tributaries of the Susquehanna? We must conclude that *Strepomatidae* require as a rule actual water communication for their spread from stream to stream. The exceptions are probably rare and unimportant.

The presence of this species in the headwaters of the Roanoke River at the hamlet of Lafayette, Montgomery Co., Va., is readily accounted for by the close proximity of the creeks forming the head of the James and those flowing into the Roanoke. Some time a

rivulet inhabited by *Anculosa* was "stolen" from the James by the Roanoke drainage, thus transferring the species.²

Goniobasis virginica is apparently a much older resident of the eastern country. It ranges from the Connecticut River (at Deep River, Conn.) to middle Virginia. The genus *Goniobasis* is known to be a much more ancient group geologically.

The distribution of *Anculosa carinata* is pretty thoroughly known by the localities given in Tryon's monograph, and the specimens in the collection of the Philadelphia Academy and the U. S. National Museum.³ It extends northward to the headwaters of the Susquehanna in New York State. Both of the collections named possess specimens said to be from regions outside of the Chesapeake drainage, such as "Ohio," "Lake Erie," etc., and DeKay reports it from "Lake Champlain;" but these localities are, there is not much doubt, false. The older collectors were not so punctilious about correct habitats for their shells as we have now learned to be; and in the absence of confirmation by later collections the evidence of these old labels must be held insufficient. Lakes Champlain and Erie, and the State of Ohio, are now well known to many ardent and reliable students of conchology, and such a conspicuous shell as *A. carinata* would not be overlooked by them.

The following localities are represented in the collections made by Mr. Ives and myself:

Susquehanna River, York Co., 62,820, collected by Witmer Stone. Specimens small, 8-10 mm. long. Apices much eroded.

Conecocheague River, west of Hagerstown, Md., 64,757, under slabs and flakes of shale in rapid current; specimens rather small and black-brown or by transmitted light dark-green; the last whorl mostly rounded. Another lot, 64,768, collected from the upper surfaces of stones along the shore at the same place, averages much larger. The specimens are light olive-colored. Apices perfect or nearly so.

Licking Creek, Md., on black limestone, 64,841.

Flintstone Creek, Flintstone, Allegheny Co., Md., 64,769. Specimens nearly black and acutely keeled. Apices entire, living on the under surface of stones.

² See instances cited in *Science*, July 1893, p. 36.

³ Mr C. T. Simpson has kindly furnished me with a list of localities represented in the National Museum.

Evitt's Creek, near Cumberland, Md., 64,766. Color light-brown or black-brown. Apices entire. On the under surface of stones.

Potomac River, Hancock, Md., 64,771. Shell compact, the last whorl rounded; dark and usually banded with black; columella black; spires much eroded. Size generally large. Another lot, taken a few miles above Hancock 64,776, is the same in character but smaller.

Potomac River at Cherry Run, Morgan Co., W. Va., 64,770. Shells large, very dark and having a black-brown basal band and sometimes a sutural band. Last whorl rounded. Apex somewhat eroded, but much less so than in the Hancock shells.

South Branch of Potomac River, near Romney, W. Va., 64,760 and 64,759. Shells small, short, and acutely keeled.

South Branch Potomac, near Springfield, Hampshire Co., W. Va., 64,763. Specimens small, many not keeled upon the last whorl.

Cacapon River, Wardensville, Hardy Co., W. Va., 64,773. Specimens mostly small, dark colored, often three-banded. Very numerous on stones.

Creek affluent to Cacapon River, near Wardensville, 64,765. Specimens very small, globose, not keeled; color dark, mostly 3-banded.

Lost River, 4 miles from Wardensville, 64,774.

Warm Spring Creek, about one-half mile from its mouth, Morgan Co., W. Va., 64,764. Specimens very large (length 16 mm.), acutely keeled, light-brown, but covered with a black coating; apices mostly perfect. The specimens from the Potomac at the mouth of this creek differ from these in being generally unkeeled and much eroded.

Patterson's Creek, Mineral Co., W. Va., 64,754. Specimens small, mostly keeled. Another set, 64,753, from a "Run" affluent to the same creek, consists of larger shells.

Big Pass Creek, west of Massanutten Mt., Shenandoah Co., Va., 64,775. Specimens large and globular, the adults without trace of the keel, and light-brown.

North Fork of Shenandoah River, about 3 miles S.-E. of Woodstock, Va., 64,777. Shells small.

South Fork of Shenandoah River, 3 miles west of Luray, Page Co., Va., 64,762. Rather small shells.

A. dilatata Conrad, var.

North River, at Sedan P. O., Hampshire Co., W. Va., 64,758. A curious elongated form, ecarinate even in the young, and with the basal "spout" almost obsolete. The specimens may perhaps be referable to *A. corpulenta*, described from Dan River, N. C. A large series was collected.

Genus **GONIOBASIS** Lea.**G. virginica** Gmel.

Potomac River at Hancock, Md., 64,778. Canal at Hancock, 64,779. Potomac River at Cherry Run, W. Va., 64,780. Also York Furnace, York Co., Pa. (Stone).

Both smooth and striated specimens occur, indiscriminately mingled, as is the case elsewhere wherever I have collected this species. Nearly all of the smooth examples are conspicuously two-banded, as are many of the striated ones also.

This species is found throughout the larger streams of the Potomac drainage and north to New York and Connecticut, but the southern limit of its range has not been accurately determined.

Family **VALVATIDÆ**.

No specimens were found by us in Maryland. Mr. Stone collected *Valvata tricarinata* Say and *V. bicarinata* Lea at York Furnace, York Co., Pa.

Family **CYRENIDÆ**.Genus **SPHÆRIUM** Scop.**S. striatinum** Lam.

The most abundant and commonly distributed species throughout the Middle States. Specimens were taken at Gettysburg, Pa., in Piny Creek, 64,831. Conococheague River west of Hagerstown, Md., 64,833. Potomac River at Cherry Run, W. Va., 64,829. Warm Spring Creek, Morgan Co., W. Va., 64,832. South Fork of the Shenandoah, west of Luray, Va., 64,830.

S. sulcatum Lam.

Piny Creek, Gettysburg, Pa., 64,842.

S. fabale Prime.

Town Creek, Allegheny Co., Md., 64,834. Warm Spring Creek, Morgan Co., W. Va., 64,843.

Family UNIONIDÆ.

Genus UNIO Retz.

U. complanatus Sol.

Conococheague River, west of Hagerstown, Md., 64,824. Sideling Creek, between Allegheny and Washington Counties, Md., 64,825. Potomac River at Hancock, Md., 64,822. Potomac River at Cherry Run, W. Va., 64,823.

U. productus Con.

Sideling Creek, between Allegheny and Washington Counties, Md., 64,827.

U. tappanianus Lea.

Sideling Creek, Md., 64,820.

Sideling Creek, at the time of our visit (Sept. 1892) was merely a chain of pools connected by a slender stream of water running among, rather than over, the rocks of dry intervals. The pools had rocky and muddy bottoms, and in them no less than five species of Unionidæ were found, represented by many individuals. No *Aneulosa* were found here.

Stone found *U. curiosus* and *U. radiatus* at York Furnace, York Co., Pa.

Genus MARGARITANA Schum.

M. marginata Say.

Conococheague River, west of Hagerstown, Md., 64,820. Potomac River at Hancock, Md., 64,819. Sideling Creek, Md., 64,821. Potomac River at Cherry Run, Morgan Co., W. Va., 64,818.

M. undulata Say.

Sideling Creek, Md., 64,828.

Genus ANODONTA.

Mr. Witmer Stone found *A. fluvialilis* Dillw. and *A. subcylindrica* Lea at York Furnace, York Co., Pa.

EXPLANATION OF PLATE I.

- FIGS. 1, 2, 3. *Paryphanta lignaria* Hutton. Three views of the type specimen, drawn by Mr. H. Suter.
- FIG. 4. Dart of *Gastrodonta ligera* Say. Extracted by Mr. Robert Walton from a Philadelphia specimen.
- FIG. 5. Genitalia of *Omphalina fuliginosa* Griff. Specimen from York Furnace, Pa., collected by Mr. Witmer Stone.
- FIG. 6. *Polygyra tridentata fraudulenta* Pils. Type. Specimen from Morgan Co., W. Va., opposite Hancock.
- FIG. 7. *Polygyra tridentata* Say. Typical. Specimen from Philadelphia.
- FIG. 8. *Polygyra tridentata juxtidentis* Pils. Specimen from Cave Town, Md.
- FIGS. 9, 10. *Velutina grandis* E. A. Smith. Two views of a specimen collected by Prof. Angelo Heilprin at McCormick Bay, western Greenland. Natural size.
- FIG. 11. *Pupa polvonensis* Pilsbry. Nicaragua. Front view of type specimen, magnified 30 diameters.

HOMOLOGIES OF THE ALISPHENOID AND PETROMASTOID BONES IN VERTEBRATES.

BY HENRY C. CHAPMAN, M. D.

To those unfamiliar with modern views upon the morphology of the skull it may not be known that any difference of opinion still prevails among anatomists as to what bones in the skull of the lower vertebrates should be regarded as homologues or representatives of the great wing of the sphenoid and petromastoid in the skull of Man and other mammalia. Considering the numerous and important palaeontological and embryological researches made in recent years, and in view of the fact that the remains of extinct animals and the development and structure of existing ones have been described so elaborately, it might naturally be supposed that the question of the special homologies of the bones of the skull would have long since been definitely settled.

So far, however, from this being the case, as a matter of fact anatomists, in certain instances at least, on the one hand designate the same bone by different names and on the other, different bones by the same name. The confusion of ideas thus engendered by obscure nomenclature makes it often very difficult to understand what particular bone is referred to, especially when the description relates to the cranial bones of some extinct animal. Apart from this consideration it is obvious that unless the special homologies of the bones of the skull of different vertebrates are determined, and identical bones be designated by the same name, it will be impossible to assign to an animal its proper position in the order of Nature or determine its phylogeny in the light of evolution, especially if the animal be an extinct one and its natural affinities obscure. The hope of dissipating some of the confusion prevailing as to the nomenclature of certain of the bones in the skull of Man and other vertebrates prompts the author to submit a resumé of some well-known osteological facts with, however, an interpretation of the same not hitherto presented, at least as far as known to him. Even if the latter be not accepted, the determination of the synonyms of the bones in question may, at least, not prove superfluous hereafter to co-workers in this field of research.

The prevailing view among anatomists at the present day appears to be that the petromastoid portion of the temporal bone is developed in Man from three distinct centres of ossification, named respectively prootic, opisthotic and epiotic; that the prootic and opisthotic coalesce to form the pars petrosa, the epiotic giving rise to the specially mastoid part of the pars mastoidea, and later joining the other two.

According to this view the homologues of these three centres of ossification of the petromastoid of Man exist in the skull of the lower vertebrata either as distinct bones or more or less coalesced with each other or with adjacent bones. The bone formerly considered as the homologue of the great wing of the sphenoid or the alisphenoid,

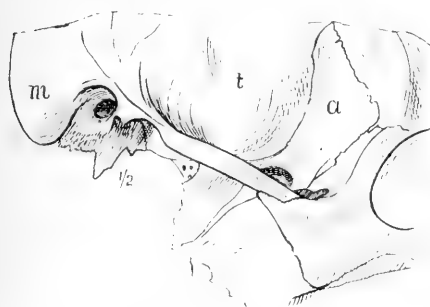

FIG. 1. Side view of human skull.

the homologue of the opisthotic or epiotic, while the latter is often represented by a small ossification coalesced with the supra-occipital.

So far as known to the author Kerekringius is usually regarded as having been the first anatomist to describe the petromastoid portion of the temporal bone as developed from three centres of ossification. Unless the author has misunderstood the meaning of the text, however, that which Kerekringius refers to as being developed from three centres of ossification is not the whole petromastoid but only that part of the pars petrosa which constitutes the mammillary process or pars mastoidea, the pars petrosa proper having been more or less developed before and independent of the three centres.



FIG. 2. Interior view of human skull.

In the fifth chapter of his *Osteogenia Foetorum*,¹ published in 1690, Kerckringius observes: "Ossis petrosi pars illa, quae processum mammillarem constituit, terna de novo acquisivit ossicula; unum pyriforma, acutiore, sui parte squamoso annectitur; alterum scutum ovale referens, magnitudine, priori vix cedens, media cartilagine ab eo separatur; uti &c., tertium ab utroque, quam vis hoc magnitudine neutri sit equiparandum, vix aciculae majoris caput adaequans sunt autem eo situ ordine collocata, quem tabula foetus v, mensium, usurpata oculis facilius ad mentem quam verba transmittet. . . . Constat ergo os temporum hoc quinto mense sex distinctis ossiculis; osse videlicet, squamoso, anulo, osse internam civitatem efformante &c., tribus notabilibus quae hoc mense ex orta esse diximus. Sexto mense pyriforme, &c. ovale scutiforme coaluerunt in unum; tertium non nihil auctum est magnitudine. . . . Septimo mense jam tertium illud ossiculum duobus mense superiore inter se coalitis accessit."

That these three centres of ossification, viz., the "pyriforma," "scutum ovale" and "tertium" do not correspond exactly to the prootic, epiotic and opisthotic centres in the sense in which these terms are used by modern anatomists, appears from the text of the latter part of the passage quoted, beginning "constat ergo," the temporal bone being said to consist at the fifth month of six distinct ossicles, which would be impossible if two of the "tribus notabilibus" coalesced to form the "osse internam civitatem efformante," which, however, as we shall see hereafter, they do a little later. That by the "osse internam civitatem efformante" is meant that part of the pars petrosa developed before and independent of the appearance of the three distinct ossicles becomes evident from the description of the state of the development of the temporal bone at the previous or fourth month, Kerckringius stating that the bone at the end of that month consists of three ossicles: "annulo," "osse squamoso" and "illo jam commemorato," the latter being the "osse internam" or that part of the pars petrosa developed at that period. "Quarto mense mirum visu, quam cito & quanto perfectione os squamosum magnam partem factum sit osseum. Os petrosum jam rubicunda cartilagine signavit cavitatis suae formam organorum auditus capacem, nihil tamen adhuc praesertit osseum, praeterquam unam in longitudi-

¹Theodori Kerckringii, *Osteogenia Foetuum*. Bibliotheca Anatomica, T. II, Genevae, 1685.

nem protensam crassiusculam & inaequalem lineam, annulo seu circulo, antea nominato, subjectam &c. paulo longius protensam. Os itaque temporum hoc mense tribus constat ossiculis, annulo scilicet,² osse squamoso et illo jam commemorato.

Further, according to Kerckringius the "pyriforma" (prootic) coalesces at the sixth month with the "scutum ovale" (epiotic) to form one bone, the latter being joined at the seventh month by the "tertium illud ossiculum" (opisthotic), whereas, as we shall show, it is the opisthotic and not the epiotic that combines with the prootic to form the pars petrosa. As to what Kerckringius meant by his "tria petrosi ossis distincta ossicula," we will try to make clear in our description of the manner in which the petromastoid develops in Man.

The work "De Aure Humana" by Cassebohm appeared in 1734-1735. The description of the development of the ear given by this author, while agreeing in the main with that of Kerckringius, differs from it in some respects. Cassebohm recognized, however, with Kerckringius, the fact of the pars petrosa being more or less ossified before the appearance of the "tria ossicula," as shown by numerous passages in his text as well as by his excellent figures.³

In the judgment of the author, Meckel, rather than Kerckringius or Cassebohm, was the first anatomist to describe the petromastoid of the temporal bone as arising from three distinct centres of ossification. According to this author⁴ the first part of the labyrinth to ossify is that immediately surrounding the fenestra rotunda, whence

² Kerckringius, loc. cit.

³ Tractatus Quatuor Anatomiei de Aure Humana. Halae Magdeburgicae, 1734 p. 19:—"Kerckringii relatio de osse temporum in foetu trium mensium, cum mea observatione de foetu totidem convenit excepto. . . . Idem ille porro in foetu quinque mensium, partem petrosam, circa processum mastoideum tria ossicula habere refert, quorum due mense sexto coalescere; verum in his mensibus, in loco indicato nulla ossa peculiaria sed cartilagineam vidi Tab. 3. Fig. 22, lit. K."

Tractatus Quatuor &c., p. 45:—"Antequam tympani membranam removebam, cochleae tuber membranae hujus partem superiorem & mediam tangebatur & quam vis cartilagineam esset, foraminis tamen rotundi (quod ad cochleam & ducit & pertinet) margo erat osseus partem que annuli posteriorem attingebat." . . . Cochleae que tuber ex fusco quem habebat, colorem nigrum acquisivisset, tunc foraminis rotundi margo albus osseus que apparebat."

Tractatus Quintus Anatomicus. Halae Magdeburgicae, 1735, p. 15:—"In foetu trium mensium cochleam, circa foramen rotundum osseam, reliquam vero cochleae partem cartilagineam. In foetu quatuor mensium cochleam vidi osseam, excepta lamina spirali, quae cartilaginea erat; hanc in foetu quinque mensium osseam demum conspexi."

⁴ Handbuch der Menschlichen Anatomie, Band 4. Halle & Berlin, 1820, p. 49.

the spreading ossification produces the floor of the labyrinth. The second centre of ossification arising at the extreme end of the superior vertical canal, gives rise to the internal auditory meatus and the floor of the cochlea. The third centre of ossification begins as a scale upon the middle of the internal vertical semi-circular canal.

It is to be inferred that Meckel supposed the mastoid is developed from the latter centre, for though he does not say so in the passage just referred to, as he had some years previously⁵ expressed the view that the mastoid is developed from a special centre distinct from that forming the pars petrosa, and as the latter is formed according to Meckel from the first two centres, the only centre remaining to form the mastoid is the third centre, that beginning as a scale upon the internal vertical semi-circular canal.

In his well known work on the temporal bone Hallmann also expresses the view that the mastoid portion is developed from a special centre of ossification, offering as a proof thereof the fact of his being able to scrape off, in certain specimens of the dried skull, the third oval centre of ossification without injuring the semi-circular canal.⁶

In 1848 Rathké, in describing the development of the turtle, regarded the two bones, the rocher⁷ and occipital externe⁸ of Cuvier, which, according to this author, form the labyrinth, as corresponding when taken together to the pars petrosa of the temporal bone of higher vertebrates:—“Die Knorpel Kapsel, welche sich auch bei den Schildkroten um den häutigen Theil des Ohr labyrinthes bildet und anfangs eine sehr einfache Form und nur sehr dünne Wandung hat, bleibt in ihrer gegen das Gehirn gekehrten Hälfte bei mehreren Schildkroten (namentlich in den Gattungen Emys und Chelonia), wenn nicht gar bei allen, zeitlebens knorplig. Ihre äussere und grössere Hälfte hingegen verknöchert allmählig, so jedoch, dass in ihr zwei Knochenstücke eintreten, von denen ein jedes einen Theil des häutigen Ohrlabyrinthes, namentlich Theile der halbzirkelförmigen Kanäle einschliesst und von denen nur das eine mit dem Namen des Felsenbeins belegt, das andere von Cuvier nicht recht

⁵ Archiv, Band 1, 1815, p. 636.

⁶ Die vergleichende Osteologie des Schläfenbeins, Hannover, 1837, p. 3:—“Dieser Knochen kern zeigt sich am trocknen skelet als ein ovales Knöpfchen, das ich leicht abkratzen konnte, ohne die kanäle zu verletzen, zum zeichen dass dieser Theil als ein besonderes stück entsteht.”

⁷ Alisphenoid, Prootic.

⁸ Paroccipital, Opisthotic.

passend Os occipitale externum genannt worden ist. Beide Knochenstücke nun, die zusammengenommen eigentlich nichts anderes als das Felsenbein der höhern Thiere vorstellen.⁹

About the same time the late Professor Owen¹⁰, in referring to the views of Kerckringius as to there being "tria petrosa ossis distincta ossicula," called attention to the primary independence of the base of the processus mastoideus as "a fact of much more significance than its brief and transitory manifestation would lead the author to divine." He further observed that "in the cold blooded vertebrates the mastoid retains with a few exceptions its primary embryonic distinctness as an independent element of the skull." It should be mentioned in this connection, however, that as Professor Owen regarded the bone now considered in the lower vertebrata as the squamosal to be the homologue of the special centre of ossification of the human pars mastoidea, he called it accordingly the mastoid.

In 1861 the view of Meckel as to the original distinctness in the embryo of the three parts of the petromastoid portion of the temporal bone was confirmed by Kölliker¹¹ in his description of the development of that bone in Man.

Finally, Professor Huxley in his lectures as Hunterian Professor at the Royal College of Surgeons of England, in 1863, and embodied substantially in his "Lectures on the Elements of Comparative Anatomy,"¹² developed at length and in detail the view that the petromastoid portion of the temporal bone in man is developed from three centres as described by Meckel and Kölliker, and further that these three centres are represented in the lower vertebrata as more or less distinct bones as held by Rathke and Owen.

The two bones described by Rathke as forming in the turtle the "felsenbein" were named by Prof. Huxley the prootic¹³ and opisthotic¹⁴; that regarded by Owen as the mastoid was considered by Prof. Huxley to be the squamosal¹⁵, and the "specially mastoid" part of the "pars mastoidea" the "scutum ovale referens" of Kerckringius was named by Prof. Huxley the epiotic¹⁶.

⁹ Ueber die Entwicklung der Schildkröten. Braunschweig, 1848, p. 52.

¹⁰ On the Archetype and Homologies of the Vertebrate Skeleton. London, 1848, p. 29.

¹¹ Entwicklungsgeschichte des Menschen und der Höheren Thiere. Leipzig, p. 320.

¹² London, 1864.

¹³ Op. cit. p. 222.

¹⁴ Op. cit. p. 222.

¹⁵ Op. cit. p. 230.

¹⁶ Op. cit. p. 155.

The view of the morphology and terminology of the petiotic capsule and adjacent bones as sustained by Prof. Huxley and most other anatomists of the present day is based upon two assumptions:

1st. That the petro-mastoid portion of the temporal bone in Man develops from three distinct centers of ossification named respectively prootic, opisthotic and epiotic and represented in the skull of the lower vertebrata by three bones bearing respectively the same three names and more or less coalesced with each other or adjacent bones.

2d. That the bone lying in front of the exit of the inferior maxillary division of the fifth nerve should be regarded in the lower vertebrata as the homologue of the great wing of the sphenoid in Man and named the alisphenoid, and the bone lying behind such exit as homologous with the upper part of the pars petrosa of Man and named the prootic.

The conclusion that follows if these two assumptions be admitted, will be that the alisphenoid or homologue of the great wing of the sphenoid is often but little developed or may be even absent in the skull of the lower vertebrata, its place being supplied by the prootic bone or the homologue of the upper part of the pars petrosa of man.

Notwithstanding the high authority of Meckel, Kölliker, Huxley and others, among whom may be mentioned the late W. Kitchen Parker, universally conceded while living to be the highest authority on all questions pertaining to the development and morphology of the skull, the three-fold development of the petro-mastoid portion of the temporal bone has been denied by anatomists and notably by the late Dr. Joseph Leidy.¹⁷

The author having had occasion recently to study the development of the temporal bone in Man has satisfied himself, at least, that the mastoid portion of the petrosal is not developed from a special centre of ossification but from the petrosal and squamosal portions of the temporal as described by Leidy,¹⁸ and that there is no homologue, therefore, in the skull of Man, of the bone described as the epiotic in that of the lower vertebrata. Further, while there is no doubt that the petrosal part of the temporal in Man is developed, as we shall

¹⁷ Science, Vol. 1, No. 18, June 8, 1883, p. 507.

¹⁸ Op. cit. p. 507, Human Anatomy, 1889, p. 116.

see presently, from two distinct centres of ossification, these two centres, in the judgment of the author are not so exactly represented in the skull of the lower vertebrata that the names prototic and opisthotic can be given them.

At a period about the middle of the fifth month of intra-uterine life the temporal bone exhibits, according to the dissections of the author, three distinct ossifications: the squamosal, the tympanic and a ring surrounding the foramen rotundum of the otherwise cartilaginous labyrinth. A little later a second centre of ossification makes its appearance at the extreme end of the superior vertical canal. From these two centres of ossification, which we will name the upper and lower otic, as indicating their situation in Man, there arise, due to progressive ossification extending through the labyrinth, the pars petrosa and two-thirds of the pars mastoidea of the temporal, the remaining third of the latter being developed from the squamosal. From the lower otic ring-like ossific centre surrounding the foramen rotundum arise all that part of the pars petrosa seen beneath the cranium, viz.: the lower part of the cochlea, the promontory, and lower part of the fenestra ovalis, the fenestra rotunda, the lower arm of the posterior semicircular canal, the lower part of the facial canal, jugular fossa, the carotid canal and the floor of the tympanum. From the upper otic ossific centre, (that appearing on the superior vertical canal) arise all that part of the pars petrosa seen within the cranium except that entering into the formation of the jugular fossa, viz.: the upper part of the cochlea including the cupola and the base, the internal auditory meatus, the upper part of the fenestra ovalis, the upper arm of the posterior and the superior and vertical semicircular canals, the upper part of the facial canal, the tegmen tympani.

The various structures just described as respectively produced from the two ossific centres having coalesced about the eighth month¹⁹ or even earlier, to form the osseous labyrinth, there is developed as a continuous outgrowth of the latter the pyramidal and mastoid portions of the petrosal, the mastoid being formed more especially by outgrowths from the posterior and external semicircular canals. The outgrowth from the posterior semicircular canal appears as an "elliptical islet"²⁰

¹⁹ It should be mentioned in this connection that it is often impossible to determine exactly the age of a foetus, since foetuses of the same age vary as regards length, weight and development.

²⁰ "Epiotic," Huxley, Op. cit. p. 155.

(Fig. 3, 4, *e*), in the cartilage situated between the squamosal, parietal and occipital bones and constituting, therefore, part of the wall of the cranium.

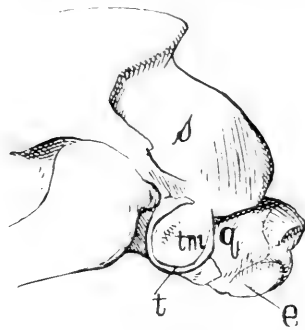

Fig. 3. Temporal bone of human foetus.

The elliptical islet having been developed, a second "quadrate" islet (Fig. 3, 4, *q*) now appears in the cartilage and more particularly in the part of it lying between the elliptical islet and the squamosal. The two islets, the elliptical and quadrate, subsequently uniting together form the mastoid portion of the petrosal.

If the latter be developed in the manner just described then the "pyriforma" and "scutum ovale" of Kerekringius would be the parts described by Leidy as the "elliptical" and "quadrate" islets, since the former, like the latter, "coalescent in unum" but not to the prootic and opisthotic centres, since the latter are developed and coalesce before the islets even appear, and for the reason already given that it is the pyriforma or prootic and the scutum ovale or epiotic that unite according to Kerekringius, not the prootic and opisthotic.

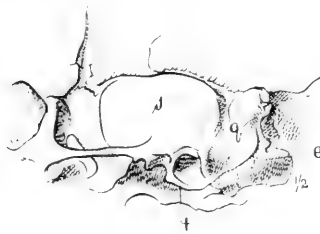

Fig. 4. Temporal bone of human foetus.

The third ossicle of Kerekringius, however, the "vix aciculae majoris caput adaequans" corresponds to that part of the lower otic or opisthotic that, growing outward and backward, makes its appearance at the edge of the tympanic ring at an early period of intra-uterine life and which soon combines, as we have seen, with the upper otic or prootic to form the pars petrosa, the latter subsequently uniting with the squamosal to form the mastoid portion of the temporal.



Fig. 5. Upper anterior portion of skull of cod-fish.

If, however, there is no distinct mastoideus or epiotic centre of ossification in the temporal bone of Man what interpretation is there to be offered as to the homologies of the bones present in the fish and

turtle and described by Cuvier²¹ as mastoideus and occipital externe, by Owen²² as mastoid and paroccipital, and by Huxley²³ as squamosal and epiotic in the fish and squamosal and opisthotic in the turtle? In reply to such query, in the judgment of the author the bone, No. 8, (Figs. 5, 6, 7, 8) described by Cuvier as mastoïdien and by Owen as mastoid in the skull of the lower vertebrates, should be regarded as it is by Huxley and most modern

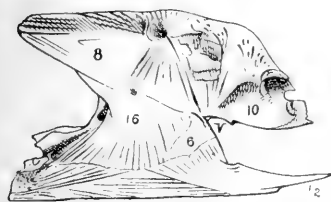

Fig. 6. Side view of skull of cod-fish.

Man but as the "eminentia aspera"²⁴ of the occipital bone or the "scabrous ridge extended from the middle of the condyle towards the roots of the mastoid process."²⁵

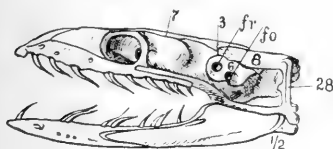

Fig. 7. Skull of python.

anatomists, as the homologue of the squamosal (Fig. 3, s) of the temporal of Man. The bone No. 4, (Figs. 5, 8, the occipital externe (perch) Cuvier, the paroccipital of Owen, the epiotic of Huxley in fish, opisthotic in turtle, is not, however, represented as a distinct bone in the skull of Man but as the "eminentia aspera"²⁴ of the occipital bone or the "scabrous ridge extended from the middle of the condyle towards the roots of the mastoid process."²⁵

The name occipital externe, or its English equivalent external occipital, may as well then be retained for the bone No. 4 as simply expressing the fact that there exists in the skull of the lower vertebrates a bone lying external to the supra and ex-occipital irrespective of any preconceived hypotheses. The names paroccipital and epiotic should be discarded, as the former implies that the bone No. 4 is the parapophysis of the first cranial vertebra, the latter that it is the homologue of the special centre of ossification of the mastoid in Man.

It has been urged in favor of the bone No. 4 being called the epiotic in the fish that it enters into the formation of the ear-chamber, its inner surface being excavated for the reception of part of the posterior and external semicircular canal. Such argument, however, loses all force when it is remembered that the exoccipital is similarly

²¹ Histoire Naturelle des Poissons, Tome 1, p. 236.

²² Anatomy of Vertebrates, Vol. 1, p. 97.

²³ Op. cit. p. 174.

²⁴ S. T. H. Soemmering "De Corporis Humani Fabrica," T. 1, 1794, p. 105.

²⁵ Alexander Monro. "The Anatomy of the Humane Bones," Edinburgh, 1732, p. 110.

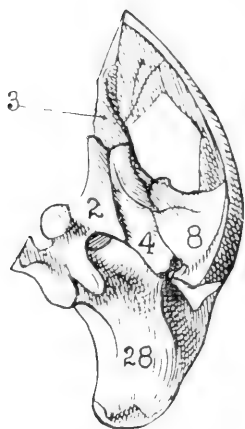

Fig. 8. Posterior view of skull of turtle.

excavated, and that the latter bone, together with the alisphenoid (prootic) petrosal (opisthotic) squamosal and post-frontal bones enter into the formation of the otocrane. It should be mentioned in this connection that the external occipital bone, No. 4, (Figs. 5 and 8), though presenting in the turtle the same characters and similar relations as in the fish, is usually described in that animal and in the alligator, etc., as the opisthotic bone, the epiotic being supposed then to be represented by an independent centre of ossification which, while distinct at an early period of life, later coalesces with the supra-occipital, No. 3+ (Fig. 9).

Even if such be universally the case it would only prove that either the supra-occipital develops in reptilia from two centres in the embryo, or that there exists a bone (epiotic) in the skull of reptiles that has no homologue in that of fish or Man, not that the bone No. 4 is the opisthotic. Indeed, as we shall see presently, there is no reason to believe that an opisthotic bone that is the supposed homologue of the rocher or petrosal in the fish (cod) of the lower part of the pars petrosa of Man exists in the skull of the reptile (turtle) at all.

Admitting that the petromastoid portion of the temporal bone in Man develops from two centres of ossification, it remains now to determine whether there exists in the skull of a cod-fish, snake, turtle or alligator the homologue of these two centres, two bones to which the names prootic and opisthotic can be appropriately given and which, taken together, represent therefore the pars petrosa of the of the temporal bone in Man.

In considering this question let us begin by first pointing out in what respect the bone No. 6, (Fig. 6) in the cod resembles and differs from the prootic or upper portion of the human pars petrosa, (Fig. 2, *p*). It resembles it in its inner concavity usually supporting the anterior part of the vestibule and the anterior vertical semicircular canal. It differs from it in not presenting a fenestra ovalis, a cochlear roof, osseous semicircular canals, internal auditory meatus or tegmen tympani, no such parts

being present in the cod, and in not transmitting the portio dura of the seventh nerve, the latter also not existing in the cod-fish.²⁶ If the bone No. 6 in the cod-fish be compared, however, with the great wing of the sphenoid in Man (Figs. 1, 2, *a*) it will be observed that it agrees with the latter (alisphenoid) in articulating with that part of the basi-cranial axis corresponding to the basi-sphenoid, and with the parietals in entering into the formation of the lateral wall of the cranium, supporting the mesencephalon, and in being notched anteriorly (perforated in the carp) for the transmission of the superior and inferior maxillary branches of the fifth nerve. The bone No. 6 in the cod differs from the alisphenoid in Man, as already mentioned, in supporting part of the membranous labyrinth and in the notch transmitting the inferior maxillary branch of the fifth nerve being situated in the anterior part of the bone rather than in the posterior part as is the case in Man.

In the consideration of the relative position of the notch *v* in the bone No. 6 in the fish and that of the foramen ovale in the alisphenoid of Man, (Fig. 2, *fo*), the fact appears to have been entirely lost sight of that the notch or foramen in the fish corresponds to two distinct foramina in Man: the foramen rotundum, (Fig. 2, *r*) and the foramen ovale, (Fig. 2, *fo*) transmitting respectively the superior and inferior maxillary branches of the fifth nerve, and that the part of the notch in the fish, (Fig. 6, *V*) corresponding to the foramen rotundum in Man, is situated anteriorly just as is the case in Man. The situation of the exit of the superior maxillary nerve is therefore substantially the same in the bone No. 6 in the cod (and absolutely so in the carp) as in the alisphenoid of Man. The objection that might still be urged that that part of the notch corresponding to the foramen ovale is situated anteriorly in the fish but posteriorly in

²⁶The author is familiar with the view entertained by some anatomists that hyomandibular branches of the fifth nerve represent in the fish the branches of the portio dura of the seventh nerve or facial in Man. Such an interpretation is, however, untenable, being based upon the assumption that the quadrate bone (jugal caisse hypotympanic) in the fish is the homologue of the incus in Man, the articulare corresponding then to the malleus. As the quadrate and malleus are, however, developed as ossifications of the proximal ends of Meckel's cartilage (mandibular arch) the quadrate must be the homologue of the malleus, not the incus, if it be homologous with either of the ear bones. The hyomandibular bone (temporal fustoidien epitympanic) in the fish is homologous with the incus, these bones being developed through the ossification of the proximal ends of the hyoid arch. It must be admitted, however, that this last view leaves still unexplained why the articulare in the mandibular arch of the fish and the same bone together with the others entering into the formation of the lower jaw of the alligator are not represented in Man.

Man has no significance, since in Man and mammals generally there is always a small portion of the alisphenoid behind the foramen ovale, amounting, indeed, in the sheep to about one-half the bone.

The statement often made that the bone lying behind the exit of the fifth nerve is the homologue of the upper part of the human pars petrosa is simply not correct so far as concerns Man and mammals.

In view of the facts just mentioned some anatomists have considered the bone No. 6 in the fish as the homologue of the alisphenoid in Man and have so named it. Other anatomists, on the other hand, impressed with the fact that the bone supports a part of the membranous labyrinth, have regarded it as the homologue of the upper part of the human pars petrosa and called it accordingly prootic. In the judgment of the author an insuperable objection to accepting the latter view is that it involves the inevitable but absurd conclusion that its homologue, or the prootic portion of the pars petrosa, must transmit the superior and inferior maxillary branches of the fifth nerve. On the other hand, it might be urged that the bone No. 6 can not be the homologue of the alisphenoid in Man since the latter never supports any part of the membranous labyrinth.

In reply to the latter objection, though at the risk of committing a *petitio principii*, the author must say that it is just in this respect



Fig. 9. Interior view of auditory region of alligator.

If this view be correct then the bone No. 6 in the fish must be regarded as the homologue of the alisphenoid in Man

that the skull of the cod-fish differs from that of Man: The bone No. 6, in the fish, the homologue of the alisphenoid in Man, protects the anterior part of the labyrinth as is done by the upper part of the human pars petrosa, the difference being conditioned by the part of the membranous labyrinth being relatively enormously developed in the fish, the osseous covering but little so, whereas in Man the labyrinth is but little developed while the pars petrosa is much so.

and the name given to it by Cuvier of grand aile or its English equivalent alisphenoid (Owen) retained.²⁷ If the bone No. 6 in the skull of the python (Fig. 7), turtle (Fig. 10), alligator (Figs. 9, 11), be compared with that so numbered in the cod-fish (Fig. 6), it will be found that while it resembles the latter in articulating with the basisphenoid and parietal bones, entering into the formation of the lateral wall of the cranium, presenting a notch or foramen for the transmission of the superior and inferior maxillary branches of the fifth nerve and protecting the anterior part of the organ of hearing, it differs from it in transmitting the filaments of the portio dura and mollis of the seventh nerve and in forming the anterior half of the fenestra ovalis of the vestibule.

In the latter respects, and in protecting the anterior part of the labyrinth, the bone No. 6 in the reptile certainly resembles

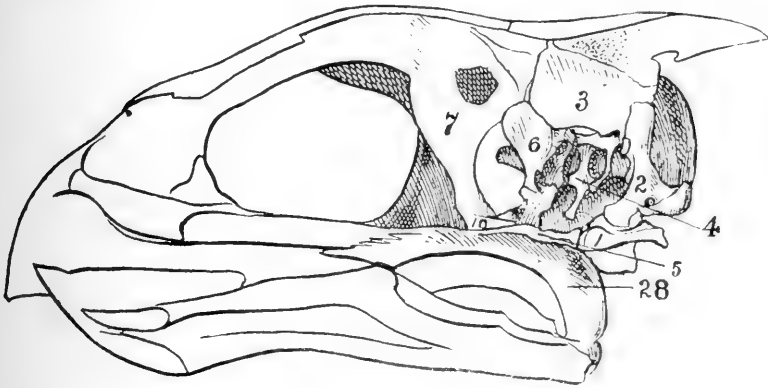

Fig. 10. Interior view of auditory region of turtle.

the upper or prootic part of the human pars petrosa and would be more appropriately named, therefore, the prootic than the bone No. 6 in the fish. The fact, however, of this bone in the reptile transmitting by notch or foramen²⁸ the maxillary branches of the

²⁷ It should be mentioned in this connection that there are present in the skulls of certain fishes (salmon and carp) three bones which have been regarded as the prootic, alisphenoid and orbito-sphenoid. As the latter bone, the most anterior of the three, is, however, inconstant and as we regard it when present as an interorbital bone, not the orbito-sphenoid, its presence or absence will not affect the argument as stated above, the so-called prootic in the carp, for example, being the alisphenoid, and the alisphenoid being the orbito-sphenoid.

²⁸ It will be observed in the case of the python (Fig. 7) that the two foramina in the bone No. 6 are as well marked as the foramen rotundum and foramen ovale are in the alisphenoid of Man.

fifth nerve is irreconcilable, as in the case of the fish, with the idea that it is the homologue of the upper prootic portion of the human pars petrosa. On the other hand, if the bone No. 6 in the reptile be regarded as the homologue of the alisphenoid in Man the difficulty presents itself that the former enters into the formation of the fenestra ovalis and transmits in the reptile the filaments of the facial and acoustic nerves, which the alisphenoid of Man never does, the fenestra rotunda and the nerves being confined to the pars petrosa. With the view of reconciling these difficulties the bone No. 6 in the reptile has been regarded by some anatomists as consisting really of two bones fused into one, the anterior and posterior parts being viewed respectively as alisphenoid and prootic bones.

The study of the development of the reptilian skull offers some confirmation of this view, since as a matter of fact, according to Parker,²⁹ the bone No. 6 in the snake develops from two centres, the anterior of which is regarded as the alisphenoid, the posterior as the prootic. If the latter view be accepted the result of development in the skull of the snake is very different from that in Man, since the prootic ossification, instead of combining with the opisthotic to form the pars petrosa, unites with the alisphenoid to form one bone. Further, it does not follow because the bone No. 6 develops from two centers of ossification that it must necessarily be regarded as consisting of two distinct bones, any more than the basi sphenoid must be regarded as consisting of three bones because it develops from three centres.³⁰ It seems to the author that the view most reconcilable with the facts of development as well as those relating to the adult condition of the skull is to regard the bone No. 6 in the reptile as the homologue of the bone so numbered in the fish and of the alisphenoid in Man.

In the absence of a pars petrosa in the skull of the reptile and bird some other bone or bones must fulfil the functions of that bone in supporting and protecting the labyrinth and in transmitting the facial and acoustic nerves. These functions are filled in the reptile more or less by the bones Nos. 6, 4, 2, 3, which we regard as the alisphenoid, external occipital, ex-occipital and supra-occipital, or,

²⁹The Morphology of the Skull, London, 1877, p. 204.

³⁰One for the median basisphenoid, two for the symmetrical basitemporals, the homologues of the lingual sphenoidales of Man.

in regard to the latter more particularly, its inferior and internal part (epiotic),³¹ No. 3 + (Fig. 9).

There remains now for consideration the question as to how much of the lower portion of the human pars petrosa is represented in the skull of the lower vertebrata. In other words, is there any distinct bone in the skull of the lower vertebrata to which the name opisthotic can be appropriately given? In the skull of the cod-fish, as in that of the Gadidae generally, there exists, though often but little developed or even absent in many fishes, a large and conspicuous bone, No. 16, (Fig. 6) which articulates with the basi-occipital, basi-sphenoid, ex-occipital, par-occipital, squamosal and alisphenoid bones and forms the posterior lateral wall of the cranium. This bone, No. 16, on account of supporting that part of the membranous labyrinth containing the otoliths has been usually regarded by anatomists (Cuvier, Owen, Huxley) as corresponding to the whole of the human pars petrosa or at least to some part of it, and has been accordingly named rocher, petrosal, opisthotic, etc. In the fish the labyrinth, however, is not exclusively and entirely enclosed by a special osseous covering as in Man. The cavity enclosing the organ of hearing is formed not only by the bone No. 16, but by the alisphenoid, ex-occipital, par-occipital, squamosal and post-frontal bones as well. It opens widely into the cranial cavity. It presents nothing comparable to the fenestra ovalis and fenestra rotunda of the pars petrosa. Such being the case it is impossible to determine whether the bone No. 16 in the fish represents the whole, or only a portion and more particularly the lower or opisthotic portion of the human pars petrosa. The author would therefore prefer to call the bone No. 16 in the fish simply the rocher or its equivalent, the petrosal, as indicating the probability of it corresponding to some part of the human pars petrosa.

The term opisthotic is objectionable as not only implying that the bone No. 16 in the fish corresponds to the lower or opisthotic part of the human pars petrosa, for which view there is no evidence, but further, for the reason already given that it is the bone No. 4 in the fish, not the bone No. 16, that is the homologue of the external occipital, the so-called opisthotic in the turtle. Indeed, the bone No. 16 of the fish does not appear to be represented as such either in

³¹ Even Parker admits that "in some forms the epiotic bones do not arise separately, but the supra-occipital and ex-occipitals extend into the epiotic and opisthotic regions respectively." Op. cit. p. 349

the reptile or in the higher vertebrata. In some respects it is a peculiarly ichthyic bone though not invariably present even within the limits of the class, as already mentioned.

The ear-chamber in reptiles is more or less closed, internally at least, in the adult condition by three bones separated by a Y-shaped suture distinctly visible in the longitudinally divided skull (Fig. 9). The two lower, No. 2, 6, (Fig. 9,) of the three bones are situated on either side of the vertical stem of the Y-shaped suture, the third remaining bone No. 3 within the diverging branches of the latter. Externally the osseous vestibule presents a fenestra rotunda *fur* (Fig. 11), situated entirely within the bone No. 2 and a fenestra ovalis, *fuo*, the posterior half of which is formed by the margin of the bone just mentioned, the anterior half by that of the bone No. 6. The membranous labyrinth consists of a vestibule, semicircular canal and, in the turtle and alligator, of a rudimentary cochlea. The fenestræ are closed by membranes in the living animal and to that of the fenestra

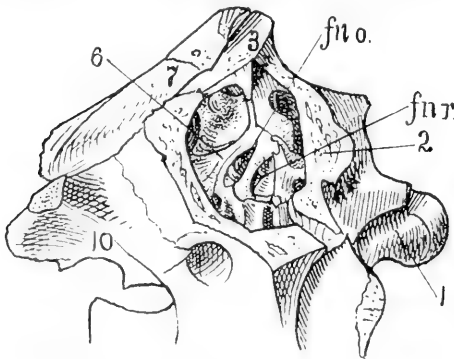

Fig. 11. External view of auditory region of alligator.

ovalis is attached a columellar-like bone which, on account of being connected with the membrana tympani, is regarded as the homologue of the stapes of the human ear. The membrana tympani is attached in turn to bone No. 28, (Figs. 7, 10) usually called the quadrate and regarded as

representing either the tympanic bone or the malleus in Man.³²

The tympanic membrane being so superficially situated, neither external auditory meatus nor external ear can be said to exist in reptiles. The nearest approach to an external ear is seen in the crocodilia which are provided with two cutaneous folds situated just

³² Some of the reasons that may be regarded in favor of accepting the latter hypothesis as the correct one have already been stated.

outside the membrana tympani which, when approximated, close the

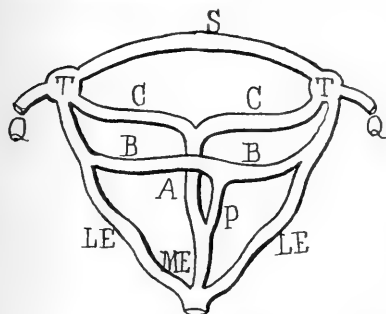

Fig. 12. Diagram of tympanic canals of alligator.

entrance thereto. In the crocodilia each tympanum (Fig. 12, T) is not only provided with its own lateral Eustachian tube proper, LE, but the two tympana communicate directly with each other superiorly by means of a passage traversing the supra occipital bone, S, and inferiorly by anterior lateral passages, C, descending from the floor of the tympanum into the anterior branch, A, of median Eustachian tube, ME, situated just behind the posterior nares and indirectly by posterior lateral passages, B, given off on either side from the lateral Eustachian tubes proper, LE, and terminating in the posterior branch, P, of the median Eustachian tube, ME. Further passages extend from each tympanum, Q, through the quadrate, thence by a membranous tube into the articulare of the lower jaw.³³

In the turtle the most posterior of the two lower bones entering into the formation of the ear-chamber is a distinct bone, No. 4, (Fig. 10), and, for reasons already given, is regarded by the author as homologous with the external occipital of the fish and is therefore similarly numbered and named. In the lizard, python and alligator the functions of the external occipital bone of the turtle, No. 4, (Fig. 10), are, however, filled by what appears, in the adult skull at least, to be a part of the ex-occipital bone, No. 2*, (Fig. 9). At an early period of development in the snake and possibly in all reptilia, this part of the ex-occipital exists as a distinct bone, notwithstanding that in later life it may have coalesced to such an extent with the ex-occipital that its original distinctness is entirely lost. If such be the case, which is not at all improbable, then that part of the ex-occipital in the alligator, No. 2*, (Fig. 9), entering into the formation of the internal ear-chamber, should be regarded as the homologue of the external occipital No. 4, (Fig. 10), in the turtle. The only essential

³³Windischmann. De Penitiori auris in Amphibiis structura, 1831.

Owen, Phil. Trans., 1850.

Stannius. Handbuch der Zoologie. Zweite Aufl., Zweites Buch, 1856, pp. 58, 164.

difference in the two would then be that in the alligator the external occipital coalesces with the ex-occipital, whereas in the turtle it remains a distinct bone throughout life. It will be observed, however, whether the osseous part in question be regarded as an outgrowth of the ex-occipital or as a distinct bone coalescing with the latter, that in neither case would the name opisthotic be appropriate, since this bone or part, being homologous with the external occipital, should be so named.

It has already been mentioned that that part of the supra-occipital entering into the formation of the ear-chamber is said to be developed from a special centre of ossification, No. 3 + (Fig. 9), and in accordance with the idea of it being the homologue of the epiotic centre of the human mastoid, named the epiotic. As there is no reason, however, for supposing that such a third centre of ossification exists, even if the part in question be characteristic of reptiles, the name epiotic should be discarded because it is misleading. Finally, as the author regards the bone No. 6, (Figs. 6, 7, 9, 10), not as the prootic but as the homologue of the alisphenoid in Man, (Figs. 1, 2, *a*), there is no reason for retaining the names prootic, opisthotic and epiotic.³⁴

Indeed, the periotic bones, or bone so named, should not be regarded as constituting any part of the proper cranial wall but as special ossifications of the ear-chamber depending upon the extent of the development of the organ of hearing.

In a general way it may be said that the transitory conditions through which the human ear passes in the course of its development are more or less permanently retained as such in the organ of hearing in the lower vertebrata. Such being the case we cannot expect to find the protective osseous covering of the ear in the higher vertebrata equally well developed in the lower ones. On the contrary, in proportion as the ear is undeveloped, we may expect to find any of the adjacent bones forming the wall of the cranium protecting and entering into the formation of the ear-chamber, just as the tympanum is formed in birds by the basisphenoid, squamosal and ex-occipital rather than by the pars petrosa as in Man. There is no more reason for supposing that there is an archetypal temporal bone,

³⁴The author does not refer to the skulls of birds, since the latter being specialized reptiles the disposition of the parts in question, as might be expected, is essentially the same.

It should be mentioned, however, that the membrana tympani is not attached in birds to the quadrate bone as in reptiles but to the outer margin of the tympanum.

the different parts of which must exist in all vertebrata, than for believing that there is an archetypal vertebra and that the skull must consist of several of the same, at least in a Goethe-Oken sense.

It does not follow, however, because a difference of opinion may prevail among morphologists as to the special homologies of certain of the bones of the head that there should be any question as to the truth of the general doctrine of the unity of organization of the skull, so firmly established by Cuvier and others.

On the supposition that the higher vertebrata have descended from the lower, it is to be expected that the general structure of the skull should be the same in both, the fundamental characters of the skull of the former having been acquired by inheritance from that of the latter. On the other hand, the skull should present greater or less modifications according to the special nature of the different vertebrata, such modifications being induced by the causes of variation incidental to different kinds of life.

The skull, like the organism in general, is not made according to a Platonic idea or pattern, but grows, its characters being acquired by inheritance as modified by variation.

SYNONYMS OF CERTAIN OF THE BONES OF THE HEAD ACCORDING
TO FRENCH, GERMAN AND ENGLISH ANATOMISTS.

CUVIER (1).	MECKEL (2).	OWEN (3).	HUXLEY (4).	
Occipital latéral.	Seitliches unteres Hinterhauptbein.	Ex-occipital.	Ex-occipital.	2
Occipital supérieur (perch, reptiles and birds).	Hinterhauptschuppe.	Superoccipital.	Supraoccipital.	3
Occipital externe (perch, reptiles), apophyse mastoïde (mammals).	Seitliches oberes, Hinterhauptbein.	Paroccipital.	Epitotic in fish, Opisthotic in reptile.	4
Grand aile (fishes, birds, mammals), rocher (reptiles).	Felsenbein (fishes and reptiles), Grosserkeilbeinflügel (birds and mammals).	Alisphenoid.	Prootic.	6
Mastoidien (fishes and reptiles), temporal (birds and monotremes).	Zitzenbein.	Mastoid.	Squamosal.	8
Aile orbitaire.	Grosserkeilbeinflügel.	Orbitosphenoid.	Alisphenoid.	10
Rocher (fishes, birds and mammals).	Felsenbein (fishes).	Petrosal.	Opisthotic.	16
Jugal.	Jochbein.	Malar.	Jugal.	26
Temporal (lizards, crocodiles and mammals), Jugal (birds, monotremes).	Schläfenbeinschuppe.	Squamosal.	Quadrato-jugal.	27
Caisse (ophidia, crocodiles, mammals), Os tympanique (lizards), Os carcé (birds).	Pauke.	Tympanic.	Quadrate.	28
Temporal (fishes), Tympanique (batrachia).	Oberesgelenkbein.	Epitympanic (fishes).	Hyomandibular (fishes).	29
Symplectique (fishes).	Griffelförmiges, Stück des Schläfenbeins.	Mesotympanic (fishes).	Symplectic (fishes).	30
Tympanal (fishes).	Scheibenförmiges, Stück des Schläfenbeins.	Pretympanic (fishes).	Metapterygoid (fishes).	31
Jugal (fishes and batrachia).	Unteresgelenkbein.	Hypotympanic (fishes).	Quadrate (fishes).	32
(1) Leçons d'Anatomie Comparée. Règne Animal. Histoire Naturelle des Poissons. Ossements Fossiles.	(2) Systeme der vergleichenden Anatomie.	(3) Archetype of Vertebrate Skeleton. Anatomy of Vertebrates.	(4) Elements of Comparative Anatomy. Manual of the Anatomy of Vertebrated Animals.	

CONTRIBUTIONS TO THE LIFE-HISTORIES OF PLANTS, No. X.

BY THOMAS MEEHAN.

THE ORIGIN OF CORELESS APPLES.

There are apple trees which have occasionally apetalous flowers and bear fruit which is, as popularly stated, coreless. The precise morphology of this condition has never been explained. Recently some specimens were presented to the Academy by Mr. Anchutz of Arch Street, Philadelphia, from a tree growing on the grounds of Captain F. J. Williams, in Pleasants Co., West Virginia. Though bearing fruit abundantly every year it never had been known to have a "blossom," that is to say, petals. The corrugated appearance of the apex of the apple suggested the course of growth which results in the "navel" varieties of orange, explained in Proceedings of the Academy, July 25, 1893, p. 292, and an examination showed that a similar explanation applies to the apple as well as the orange. The ordinary apple is simply an arrested branch in which the leaves, with the axis, have been transformed into the succulent or carpellary structures

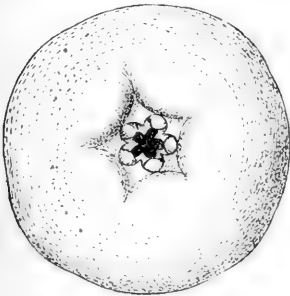

Fig. 1.

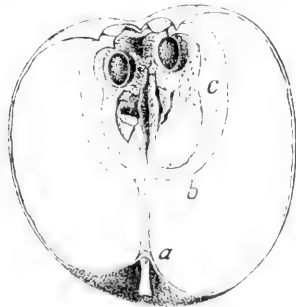

Fig. 2.

which go to make up the fruit. But in these coreless apples, the growth-wave resulting in the production of fruit did not become so fully arrested, but made a renewed though weaker rhythm. This was sufficient to draw nutrition from the original fruiting wave, and perhaps interfere with its proper pollination, thus permitting the formation of an upper carpellary system,—weak, certainly, but sufficiently well situated to secure pollen and produce a few

very small seeds in the upper section. The illustrations explain the process by which this coreless condition is brought about. Fig. 1 gives an external view of the apex of the apple. In the ordinary apple we have the dry remains of five small sepals; in this we have three series of five, alternating with each other in a perfectly normal manner. The interior series of five are quite fleshy and, as they are evidently the apical portions of the five sectional protuberances in the apple, we may safely conclude that it is this series which has chiefly aided in the development of the fleshy portion of the fruit. It should have been the matrix of the petals in the normal apple, and we may infer that in this fruit, as we generally have it, with the calycine and petaliferous verticils combined, it is the inner or petal bearing series that gives the apple its chief succulency. In the normal apple, the carpellary structure commences at *a*, Fig. 2, but in this case, by the imperfectly arrested growth of the axis, it has been carried up to *b*,—and even then not wholly brought to rest, as it has made another step, *c* resulting finally in a small system capable at least of seed-bearing, though having lost most of its power to give succulence to its calycine series. We may say that a coreless apple is, morphologically speaking, but a restless attempt on the part of the tree, to develop several carpellary systems, instead of confining itself to the perfection of one, as in ordinary cases.

This phenomenon is not unusual in plants. The rose, a near relative of the apple, is not infrequently seen with another small rose growing from its centre, the explanation being of the same character as here given for the apple.

It may be tersely stated that navel oranges and coreless apples are feeble attempts at proliferation.

THE RELATIONS BETWEEN INSECTS AND THE FLOWERS OF *IMPATIENS FULVA*.

Along a small stream on my grounds, masses of *Impatiens fulva* abound, growing in great luxuriance. The humming bird visits the flowers as freely as various insects. I frequently amuse myself by standing perfectly still in the midst of a mass of flowers, and have these little creatures rest on my shoulder or even on my hand when I kept it still above the flowers. While thus enjoying myself, I have been led to note many items of interest worth recording.

Variations in species are often referred to the visits of insects.

They bring pollen from other flowers, and intermediate forms necessarily result. Quite early in the modern discussions of this subject¹ I showed that variation must first occur, and that the insect visitor was rather a conservative agent than a factor in variation,—bringing back towards the original that which had departed. I have published many papers showing that variation is at least as great in monotypic species as where there are numerous closely related species or varieties to cross with. *Impatiens fulva* is another illustration. It is not necessary to recount the character of the variations. One may fairly say that no one character can be named that does not show variation in some individuals. Even the glaucous leaves are sometimes bright green, at others almost silvery. The flowers not only vary in color and markings, but the several parts of the flowers are changeable. The spur particularly is sometimes of remarkable length, at others well warranting the remark of Dr. Gray “spur rarely wanting.” Aside from the fact that there is no other species near to get any aid to variation in that way, many of the colonies on my grounds are from last year’s seeds. The observations on this plant confirm records I have made during the past quarter of a century that there is an innate power to vary co-existent with the species itself, independent of any conditions of environment. This may be granted without prejudice to the proposition that changes can and do occur at times by the influence of environment, for which there is abundant evidence. It seems proper to present the strong facts on the former side, because of the modern tendency to exalt the latter as the prime motor in evolution.

The amount of nectar secreted at the base of the spur is considerable. By cutting off the apex and stripping down the tube as in milking, a globule as large as a pin’s head will form at the cut. A large proportion of flowers, especially in the latter part of the season, are cleistogene. But even in these cleistogamous flowers spurs are formed. An interesting fact was that the nectar formed as freely in the spurs of the cleistogene flowers as in those which we should call normal and fully “adapted” to insect visitors!

Is there any necessary relation between the nectariferous structures of flowers and the visits of insects? The cases in which the relationship appears close are numerous, but equally numerous

¹On the Agency of Insects in Obstructing Evolution. Proc. Ac. Nat. Sciences, 1872, pp. 235-237.

are the cases on the other side, and this cleistogamous case is one. But in the normal flowers only a few insects could work to advantage. The spur of the nectary is incurved, and only creatures with a long and flexible tongue could reach the sweet deposits stored, mostly, at the base of the tube. In my "Flowers and Ferns of the United States" (Series II, p. 44, 1880) Prof. W. W. Bailey is quoted on the authority of a friend of his that "the sacs were all perforated by bumble bees." Numerous species have their sacs perforated in this way, and all have been charged, even by myself, to bumble bees. Dr. J. H. Schneck of Mount Carmel, Illinois, suggested to me that this is probably a mistake, and that species of *Xylocopa* (carpenter-bees) and not *Bombus*, are responsible for this act. Watching these flowers I found the slits were made by a wasp, *Vespa maculata*, that some species of *Xylocopa*, and also the honey bee, took advantage of the work of the wasp; but the only species of bumble bee I noticed working on the flowers, *Bombus Pennsylvanicus*, entered the flower every time by the flower's mouth, and got the nectar from the curved spurs as best it could. Properly speaking, the openings made by the hornet are not slits, but rough openings, chewed out. The slits proper appeared to have been made by the small carpenter bees. It is evident that in view of the many insects these flowers support, no advantage is received by the flowers in return.

The relation of *Bombus* to fertilization was next examined. The longitudinal streak of white pollen on the back of the visiting bee gave it a picturesque appearance. That he could carry pollen from one flower to the other was very apparent. It seems impossible for the visiting bee to reach the stigma, as these are protected by connivent scales under the anthers, which form a close cap covering the stigma. Usually the earlier petaliferous flowers are infertile. In these plants, early in August, numerous flowers had perfected fruit, though the great majority were infertile. In what manner did the bee or the humming bird aid in the pollination? Examining a number of flowers after these creatures had retired I was satisfied that they did not aid in any way. I have had evidence in other cases that where sufficient moisture exists, pollen tubes can reach the stigma without actual contact with it. There is abundant moisture around the stigma, and it is not improbable that the pollen tubes, by the aid of this moisture, pass over the membranous border, in

many cases, to reach the stigma and effect fertilization. The positive fact gained by these observations is that neither humming birds nor bumble bees in any way aid in pollenizing the petal-bearing flowers. They are as absolutely self-fertile as the apetalous cleistogene ones.

An especially interesting observation was the existence of many plants bearing wholly cleistogene flowers among the normal petal-bearing ones. These plants were not as tall or vigorous as the petal-bearers, and could be readily distinguished from a distance by a yellowish-green tint, indicative of imperfect nutrition. It had been before suggested to me by an incidental remark of Mr. Willis in the Proceedings of the Cambridge (England) Philosophical Society, that in some unexplained way there is a relation between imperfect nutrition and cleistogamy,—a point which this observation confirms.

The sum of these observations is, that in *Impatiens fulva* variation is innate and not dependent on environment; that bright color and sweet secretions have no relation to the visits of insects; that the petal-bearing flowers are self-fertile, and that cleistogamy is the result of impaired nutrition rather than of any mere labor-saving influence.

APETALISM AND SEED PROPULSION IN *LAMIUM PURPUREUM*.

Lamium purpureum, a well-known European species, is somewhat common as a weed on my grounds at Germantown, near Philadelphia. It exists in two forms: one with small pale lilac flowers, the other with flowers more rosy and larger. While examining the flowers with a lens to trace any difference that might exist, I was surprised to have my face peppered by the seeds which had been expelled from the calyx with considerable force. Examining plants with an abundance of seed vessels, it was seen that most of the calices were empty though still comparatively erect. The seeds, or properly nutlets, could not easily have fallen out, and doubtless propulsion is the usual method by which they are distributed.

Examining plants in the early part of July I found large numbers of the upper flowers apetalous. The calyx was perfect, the stamens were of the usual length, and the anthers profusely laden with pollen; the pistil seemed in every respect perfect, but not the slightest trace of corolla existed. The stamens, normally borne on the

corolla, were now wholly independent of each other, and hypogynous. This is probably the first case of apetalism recorded in Labiatae.

FRUITING OF *ROBINIA HISPIDA*.

In descriptions of *Robinia hispida*, no reference is made to the legumes. In cultivation they are not known ever to be formed. The writer has searched for them in his botanical collections in Tennessee without finding any, and it is a general belief that they are rarely produced when the plant is growing either in a wild or cultivated state. Mr. David F. Day of Buffalo, New York, notices² that the anthers are destitute of pollen in the flowers he examined from cultivated plants in that region, a condition often found, in most plants of *Lathyrus grandiflorus* and some other Leguminose plants. In an excursion around Linville, North Carolina, in July 1893, Mr. C. F. Saunders of Philadelphia found a number fruiting, some specimens of which have been deposited in the Herbarium of the Academy, and in the Royal Herbarium at Kew.

THE VITALITY OF SEEDS.

Antirrhinum glandulosum. Exact facts in regard to the power of seeds short-lived under ordinary circumstances to retain vitality when deeply imbedded in the earth, or under some other specific conditions, are not numerous. Hence many controversies occur between the "practical man" who *knows* they will live an indefinite time, and the man of "science," who as firmly believes they will not. The writer of this has frequently been among the doubting ones, simply because the facts adduced for long vital power, could bear other interpretations. Ten years ago his friend, the late Dr. C. C. Parry, gave him some California seeds. *Antirrhinum glandulosum* was raised from them. The following year the plot was required for buildings and covered with earth from the cellar several feet deep. No plant of it has, to a certainty, been there since until this season, when, the earth in one spot being turned up a few feet in depth, one plant came up and flowered.

DIMORPHIC FLOWERS IN LABIATÆ.

Dracocephalum nutans.—I have shown in various papers that a tendency to dioecism is not uncommon in *Labiatae*. Another addition

²Mechan's Monthly, III, p. 118.

to the list is *Dracocephalum nutans*, a European plant which has many individuals with all the anthers sterile. The plants which bear the highly polliniferous anthers are much larger and more showy than what may be called the female flowering plants, a fact I have noted in other dimorphic species.

Some European works have noted a mixture of species, or marked varieties, of this plant in a wild state. The dimorphic character is the probable explanation.

APETALISM IN SISYMERIUM THALIANA.

Apetalism is not common in *Cruciferae*. I have noted tendency in this direction in *Cakile* and in *Raphanus*. Early in the present season 1893 the plant being a common weed in my garden, I found apetalous flowers very common. Numerous instances of flowers with only one, two or three petals, were also observed. Later in the season there was seldom found any variation from the normal condition. No difference in strength, position, or any other condition could be observed that would satisfactorily account for the abortion.

DESCRIPTION OF A NEW SUBSPECIES OF TROUT FROM McCLOUD RIVER, CALIFORNIA.

BY DAVID STARR JORDAN.

Salmo gairdneri stonei, subsp. nov.

Allied to the form called *Salmo irideus*, but distinguished by its small scales, the number of scales in a longitudinal series being about 155, 82 before dorsal, where they are small and imbedded, 25 above lateral line. Teeth fewer and smaller than in var. *irideus*, those on the vomer in a single zigzag series. Axillary scale of ventral small. Pectoral $1\frac{1}{2}$ in head. Eye large, $4\frac{1}{2}$ in head. Maxillary 2 1-10. Upper parts plain greenish. Spots small and sparse on dorsal, adipose fin and caudal; a few spots only on posterior part of the body. A faint red lateral band; cheeks and opercles with red; no red between branches of lower jaw. Depth 4 in length. Anal rays 11. Described from a specimen (No. 900 Mus. Stanford Univ.) 14 inches in length collected by Livingston Stone in McCloud River at Baird, California.

This form is well known to the Indians and to fishermen on the Upper Sacramento. According to Mr. Stone the Indian fishermen say that it is abundant in the McCloud River about eight miles above Baird. They are larger in size than ordinary *irideus*, one having been taken weighing 12 pounds. It is known to the Indians as *No-shoo* or *Nissucc*.

The subspecies is named for Livingston Stone, Director of the U. S. Fish Hatchery at Baird.

FEBRUARY 6.

The President, GENERAL ISAAC J. WISTAR, in the chair.

Thirty-seven persons present.

A paper entitled "Observations on the Geology of adjacent parts of Oklahoma and northwest Texas," by Edw. D. Cope, was presented for publication.

A New Central American Pupa.—MR. H. A. PILSBRY exhibited specimens of a small land shell from Polvon, Nicaragua, and offered the following description:

PUPA POLVONENSIS n. sp. (Pl. I, fig. 11).

Shell cylindrical, somewhat tapering above, opaque grayish-white with oblique brown streaks. Whorls $5\frac{1}{2}$, somewhat convex; aperture small, without internal plicae or denticles; lip thin, simple, the columellar margin dilated, partly concealing the round and rather large umbilicus. Alt. 2, diam. 1.3 mm.

This species resembles *P. simplex* Gld. in the toothless aperture and thin lips, but differs in coloration, the larger umbilicus, etc.

FEBRUARY 13.

The President, GENERAL ISAAC J. WISTAR, in the chair.

Thirty persons present.

FEBRUARY 20.

The President, GENERAL ISAAC J. WISTAR, in the chair.

Thirty-nine persons present.

The death of Edward S. Whelen, a member, was announced.

Papers under the following titles were presented for publication:—

"*Tanais robustus*, a new species of Anisopoda." By H. F. Moore.

"List of Port Jackson Chitons collected by Dr. Cox, with a revision of Australian Acanthochitidae." By Henry A. Pilsbry

FEBRUARY 27.

MR. CHARLES MORRIS in the chair.

Thirty-nine persons present.

A paper entitled "Re-exploration of Hartman's Cave in 1893," by H. C. Mercer, was presented for publication.

W. Graham Tyler and Ruth Clement, M. D., were elected members.

The following were ordered to be printed :—

OBSERVATIONS ON THE GEOLOGY OF ADJACENT PARTS OF OKLAHOMA AND NORTH WEST TEXAS.

BY E. D. COPE.

Through the coöperation of certain members of the Academy I was enabled to make an expedition in the interest of vertebrate paleontology during the summer of 1893. The gentlemen who contributed the means for this exploration were Mr. Charles Cramp, Gen. Isaac J. Wistar, Dr. Samuel Dixon, Mr. Thos. H. Savery and Mr. William Sellers. I had the privilege of the society and assistance of Prof. Amos P. Brown, in charge of the Department of Geology and Mineralogy in the University of Pennsylvania. The expedition left Bismark, Dakota, July 10th, and completed its labor at Galena in southwestern Missouri on September 4th.

The month of July and thirteen days of August were occupied in explorations in the Standing Rock and Cheyenne River Sioux Reservations in North and South Dakota. Near Fort Yates, N. D., we examined the hills which are directly to the north of the fort and extend northward. We obtained from them several fossils which indicate their marine origin, and that they belong to the Fox Hills epoch of Meek and Hayden. These include sharks' teeth of the genera *Galeocerdo* and *Otodus*, and a fragment of a probable Chimerid fish. The bluffs of the eastern escarpment of the Laramie formation extend across the plain at a distance of twelve miles west of Fort Yates, and these were explored without result, except the discovery of a few fragments of Dinosaurian bones.

We made an expedition to the Laramie bluffs which border Hump Creek in the northern part of South Dakota. This stream rises in North Dakota, and after a course of perhaps thirty miles it flows into the Ree (or Grand) River. Its valley is bounded by bad land bluffs, but in only one portion of these did we find vertebrate fossils. I owe my knowledge of this locality, as well as that which I had previously visited in 1892, to Miss Mary Collins, who has spent much of her life as a missionary among the Sioux, and who has the confidence of these people in a marked degree. One of Miss Collins' assistants, a Sioux named Maza (Iron), had observed the fossils, and served as my guide during both the expeditions which I

have made to obtain them. As a trustworthy, amiable, and helpful man Maza proved himself to be an invaluable adjunct to the party. We returned from Hump Creek on August 2d, and on the way to the fort examined the escarpment of the Laramie at a point further south than previously, and had greater success in obtaining fossils. Altogether we obtained in the Laramie, bones of three species of fishes and twelve species of reptiles; but no mammals or birds rewarded our search.

Our next points of investigation were the Upper Permian bad lands of the Cimarron in Oklahoma, and such other outcrops of the formation south of that river as should promise favorable results of exploration. On our way thither we found ourselves, on August 10th, at Sioux City, Iowa. Here we were courteously entertained by Mr. John H. Charles, President of the Missouri River Transportation Company. He presented to the Academy portions of the vertebral columns of two species of Plesiosauridae, from the Pierre formation of the Upper Cretaceous, which were new to science, and which I have described in the Proceedings of the American Philosophical Society as *Embaphias circulosus* and *Elasmosaurus intermedius*. On an excursion along the bluffs bounding the valley of the Sioux river we observed the eastern extension of the Niobrara Cretaceous limestone and chalk, and the superimposed loess.

In the absence of a good point for fitting out an expedition for the explorations on the Cimarron River, we went to Fort Supply, a considerable distance to the southward of it. We were there entertained by the officers of the post, especially by Captain William Ahman and by Lieut. Fox. The officer in command, Col. Daingerfield Parker, very kindly gave us the use of the post ambulance, and by this means we were enabled to make a pretty complete examination of the neighborhood during the days of our sojourn. Our first object was to examine the red bluffs of Permian or Trias, which bound the canyons N. and N. W. of the post, which form part of the drainage system of the Cimarron. These bluffs we examined at various points and for considerable distances, but without obtaining any traces of fossil remains, excepting some fragments of wood. We found that the formation which constitutes the higher levels at the heads of the canyons tributary to the Cimarron, is an impure friable calcareous limestone of evidently lower cretaceous age. We obtained from it *Erogyra texana* and *Gryphaea pitcherii* with other species, which have

been determined by Prof. Brown as follows:—*Erygyra texana*, *Gryphæa piteherii*, *Ostrea suborata*, *Ostrea crenulimargo*, *Ostrea* sp., *Cucullæa terminalis*, *Neitheu occidentalis*, *Plicatula incongrua*, *Trigonia* sp., *Trigonia emoryi*, *Turritella seriatimgranulata*, *Schlenbachia peruviana*.

We found also the following vertebrata: *Lamna* No. 1, *Lamna* No. 2, Lepidotid scale, *Uranoplosus arctatus*, *U. flectidens*, *Coccolodus brownii*, *Plesiosaurus* vertebrae, crocodile fragments, and fragments of a tortoise.

The three species of Pycnodont fishes were new to science, and they have a Lower Cretaceous facies. *Plesiosaurus* is represented by dorsal vertebrae only, but these are not of the Upper Cretaceous type. I have never found Lepidotid fish remains in the Upper Cretaceous of North America, while they are characteristically Lower Cretaceous and Jurassic in Europe. The only occurrence of Lepidotid fishes so far recognized in N. America, is based on some teeth sent by Mr. Charles H. Sternberg in the Dakota sandstone of Kansas, and on the new species, *Macrepistius arenatus*, from the Trinity bed of Texas discovered by Prof. R. T. Hill. (See Journal of the Academy Vol. IX, Part 4). The crocodilian remains are undeterminable.

Below this formation, which is of a strong yellow color and about twenty-four feet thick, is a stratum of marls, black above, whitish in the middle, and buff below, of about equal thickness with the limestone. The black color is due to carbon, which in some places forms thin layers of impure coal. This formation contained no fossils by which its age could be determined, and thus stood in strong contrast with the cretaceous above it, and agreed with the red beds of the Permian below it. Between the black marl and the cretaceous there intervened at some points a shallow bed of sand, usually coarse, and reaching in places a thickness of six feet. Its color is yellow, varied with horizontal red streaks. The age of the marine Cretaceous beds corresponds, according to Prof. Brown's determination, with the Comanche Peak terrane of the Texas geologists. The tract first observed lies about five miles northwest of Fort Supply, and is of limited extent, being cut off to the north by the drainage of the Cimarron River, and to the south by the drainage of the North Fork of the Canadian. Its horizontal extent cannot exceed fifty square miles. We examined another and more limited area of the

same bed which contained the same invertebrate fossils, at a point about twelve miles south of the fort.

The Permian red beds are traversed conformably by layers of gypsum at different horizons. The sand bed below the cretaceous limestone is sometimes consolidated into a sandstone, which forms a ledge near the summit of the bluffs. From fifty to seventy-five feet below this and in the red beds, is a bed of saccharoidal limestone. This limestone is luminous when struck or scratched with a metallic object, like a similar limestone which occurs in some of the silver mines in Utah in the Wasatch Mountains.

At the locality already referred to, twelve miles south of Fort Supply on a low ridge of the Cretaceous terrane, we observed a white discoloration, as though two or three cartloads of a chalky material had been deposited there. Prof. Brown was so fortunate as to find in it the fragments of a solitary superior molar tooth of *Protohippus perditus*, which determined the age of the material as the Loup Fork, or Upper Miocene. Careful search failed to reveal another fossil, and it is evident that we have here the last remnants of a formation which has been almost entirely removed by erosion.

With the view of further determining the extent of the Comanche and Loup Fork formations, we left Fort Supply and went by rail to Miami, which is a village in Roberts County of the Panhandle of Texas, south of the Canadian river. For several miles before reaching Miami, the railroad runs between steep bluffs, which form the southern border of the flood plains of the Canadian river, and are the escarpments of the outlying tracts and fingers of the Staked Plains. They are about two hundred feet in elevation, and include two hard strata, while the great mass is sandy clay, or sand in a few localities. One of the indurated beds is at the summit of the bluffs, forming the surface of the plain, and is about six feet in thickness. The softer argillaceous bed below it varies from fifteen to fifty feet, when the second impure sandstone is reached, which has a thickness of about eight feet. The one hundred and fifty feet below this is friable, so that the construction of the escarpment is such as to keep it more or less perpendicular. The general appearance of the bluffs is closely similar to that of the Blanco beds at the typical locality one hundred and fifty miles south, at the point where the Brazos River issues from the Staked Plains in the Blanco Canyon. In order to ascertain whether this formation is the Blanco or the Loup Fork,

which it resembles, we examined the bluffs for a day and a half for fossils. They are rare in that region, but I obtained on the second day, teeth of both series of a horse, *Equus cummingsii* Cope, which demonstrated at once that the age is the Blanco. Mr. Brown found camel bones which approach in dimensions those of the Blanco species, rather than those of the Loup Fork; but the species could not be identified.

On the succeeding day, we drove, thanks to Mr. R. T. Cole, of Mobeetie, to the town of Mobeetie in Wheeler County, eighteen miles S. E. of Miami. The route takes the traveler across a part of the Staked Plains, and a considerable distance before Mobeetie is reached, ravines belonging to the drainage system of the tributaries of the Red River are passed. We examined a number of these for considerable distances without obtaining fossils. As we passed the deserted Fort Elliott, near to Mobeetie, I examined some sandy beds like those of the Upper Blanco beds, and obtained additional tooth fragments of *Equus cummingsii* and a second species of *Equus* probably *E. eurystylus*, and fragments of teeth and other bones of undeterminable camels. We thus determined the extension of the Blanco bed as far east as Mobeetie.

The result of my observations on this, the northeastern border of the Staked Plains, is to the effect that this plateau to the north of the Red River like that part to the south of it, belongs to the Blanco deposit, giving the latter a north and south extent of two hundred and fifty miles. It had been hitherto positively determined at the typical locality only, that distance south of Miami, on the upper waters of the Brazos. From this point to the Red River the formation appears to be continuous; and the portion north of the Red River now described, not only has a close physical resemblance to the portion south of it, but contains as now appears, fossils of the same age. (See Report of the Geological Survey of Texas for 1892, for reports by Cummins and Cope on the Blanco terrane).

On our return from Texas, we stopped at Tucker, Oklahoma, near to the Cimarron River, and examined for a day the exposures and bad lands of the Upper Permian of that region. Although the exposures are most favorable for the exhibition of any fossils which the strata may contain, nothing of organic origin was found. Crystallized gypsum is very abundant.

On reaching Kansas on our return, we stopped at Wellington and

examined the Pliocene sands of that locality. At the west side of the town is an abandoned sand quarry, and on the east side is a similar quarry, from which the town derives its supply of building sand. We obtained from a saloon a number of fossils which were said to have been found several years previously in the west-side quarry. These consist of an almost entire mandibular arch of an adult *Elephas primigenius* with both molars in place, with several bones of probably the same animal; together with the muzzle and parts of both horns of a large bison, which differs considerably from *B. latifrons*, and to which I have given the name of *Bos crampianus*. It is figured and described in the Journal of the Academy, Vol. IX, Part 4. I also obtained from Mr. Wheeler, owner of the east-side quarry, an entire posterior molar of *Elephas primigenius* of the coarse plated variety, which was taken from his pit.

Hearing of remains of the Mammoth in possession of some one near to Hemessy in Central Oklahoma, we took rail for that place. On arriving, we found that the fragments were in possession of a rancher eight miles west of that town. We visited the ranch, and found that the fragments were much broken, and included the four molar teeth of an adult *Elephas primigenius* of the coarse plated variety. The rancher, Mr. Painter, had in his possession a number of teeth and some bones of the limbs of a saber-tooth tiger, which he had found with those of the mammoth. Both its bones and those of the mammoth were stained red by the coloring iron of the Permian clay, and were covered by a thin layer of it. The animals had been in some way buried in this material during the Pliocene epoch. I have described the cat under the name of *Dinobastis serus* in the Journal of the Academy, Vol. IX, Part 4, as it represented both a species and genus new to science.

On our return northward we stopped a few days at Galena, Missouri, and visited the Marble cave eighteen miles east of that place, under the guidance of the proprietor, Mr. Truman Powell. I wish here to express the obligation under which Mr. Powell placed me through his hospitality and general assistance.

LIST OF PORT JACKSON CHITONS COLLECTED BY DR. J. C. COX, WITH A
REVISION OF AUSTRALIAN ACANTHOCHITIDÆ.

BY HENRY A. PILSBRY.

The following pages contain a part of the results of the study of a collection of the Chitons of Port Jackson, New South Wales, Australia, recently made by Dr. J. C. Cox, the well-known Australian conchologist. Dr. Cox, with great liberality, transmitted to the Academy a large number of specimens both dry and preserved in spirits, with the request that they be studied and reported on. I am therefore enabled to make a contribution toward an exact knowledge of the distribution of the Polyplacophora inhabiting the New South Wales coast, as well as to elucidate several important points relating to particular species and genera.

With the exception of a few records by Mr. E. A. Smith, of Port Jackson species collected by Coppinger,¹ and by Professor Haddon of those collected by the "Challenger,"² our knowledge of the Chiton fauna of the New South Wales coast is limited to the lists published by Mr. G. F. Angas³ many years ago. At that time, the morphology of Polyplacophora was very imperfectly understood; and consequently these admirable lists, which have been so helpful to subsequent conchologists in dealing with most families of mollusks, are almost useless in the study of Chitons, so many errors do they contain.

Angas, however, found some forms in Port Jackson which subsequent observers have not yet found, and among them several, such as *Microplax Grayi*, of exceptional interest to the general student on account of their peculiar and ill-understood features.

To direct the attention of local malacologists to these forms, if for no other reason, it is thought expedient to quote Angas' list of species, the modern equivalents of his names, so far as known to me, being given in another column.

¹ Zool. Coll. H. M. S. "Alert."

² Challenger Reports, Vol. XVII.

³ Proc. Zool. Soc. London, 1867, p. 221, and 1871, p. 97

ANGAS' PORT JACKSON LIST.	MODERN EQUIVALENTS.
Lophyrus australis	= Ischnochiton australis Sowb.
" concentricus	= Chiton jugosus Gld.
" glaucus	? = Ischnochiton lentiginosus Sowb.
" muricatus	= Chiton muricatus A. Ad.
" jugosus	= " Coxi Pils.
" smaragdinus	= Ischnochiton smaragdinus Ang.
Lepidopleurus proteus	= (Ischnochiton divergens Reeve) and fruticosus Gld.
" longicymba	= Ischnochiton Haddoni Pils.
" ustulatus	?
" antiquus	= Callistochiton antiquus Rve.
Tonicia Carpenteri Ang.	= Tonicia Carpenteri Ang.
Leptochiton versicolor	= Callochiton platessa Gld.
Onithochiton Incei	= Onithochiton
" rugulosus	= " "
Chiton piceus	= Liolophura Gaimardi Blv.
Chatopleura rugosa	
Lorica cimolia	= Lorica volvox Rve.
" Angasi	= Loricella Angasi H. Ad.
Plaxiphora petholata	= Plaxiphora petholata Sowb.
Acanthochites costatus	= A. (Loboplax) costatus H. Ad. and Ang.
" scutiger	? = (A. (Meturoplax) retrojectus) Pils. or A. granostriatus Pils.
" carinatus	? = A. Coxii Pils.
Microplax Grayi	= Chorioplax Grayi H. Ad. & Ang.
Cryptoplax striatus	= Cryptoplax striatus Lam.

Of the twenty-four species listed by Angas, I have not seen *Lepidopleurus ustulatus*,⁴ *Tonicia Carpenteri*, *Chatopleura rugosa* or *Microplax Grayi*. The type of *T. Carpenteri* was examined by Dr. Carpenter who considered it a good species. It probably belongs to the section *Lucilina*. Angas' *Chatopleura rugosa* may possibly be a young *Plaxiphora*, but it is with hesitation I hazard any conjecture upon it. A note upon *Microplax Grayi* will be found in *The Nautilus* for April, 1894, p. 139. The other species of Angas' list I have identified with a considerable degree of certainty, having numerous specimens of all of them before me, as well as some additional forms lately discovered. The species collected by Dr. Cox are as follows:—

⁴ *Ischnochiton ustulatus* Rve. occurs abundantly in South Australia, but nothing I have seen from Port Jackson corresponds to this species.

Family ISCHNOCHITONIDÆ.

Genus CALLOCHITON Gray.

Callochiton platessa Gould.

Port Jackson. This is the *Leptochiton versicolor* Ad., of Angas' list. It is a lovely shell of the most brilliant orange-red color. A larger, dark-brown species allied to this, occurs on the Tasmanian coast, *Callochiton (Trachyradsia) inornatus* Ten.-Woods.

Genus ISCHNOCHITON Gray.

The general arrangement of the species of this genus is far from satisfactory. Former classifications have been founded too exclusively upon the girdle scales. The Australian species fall into five natural groups, or sections, which may be defined as follows:—

1. *Ischnochiton* s. str.: type *longicymba* Q. & G.
Intermediate valves having 1-1 slits; lateral areas radially sculptured, central areas finely granulated in quincunx, or longitudinally lirulate at the sides, with "V" sculpture along the ridge. Girdle scales subequal, striated.
2. *Stenochiton*: type *juloides* A. & A.
Animal much elongated: intermediate valves having several slits on each side.
3. *Heterozona*: type *cariosa* Cpr.
Like *Ischnochiton* (sensu stricto), but girdle scales minute and large, intermingled.
4. *Haploplax* nov.: type *smaragdinus* Ang.
Intermediate valves having 1-1 slits; entire surface smooth except for minute granulation; girdle scales convex, smooth.
5. *Ischnoradsia*: type *australis* Sowb.
Shell not unusually elongated; intermediate valves with several side-slits, sculpture coarse; girdle scales very convex, not striated.

Ischnochiton Haddoni Pilsbry.

Very abundant at Port Jackson and Port Hacking. This should be compared with the type of *Chiton crispus* Reeve, Conch. Icon. pl. 19, fig. 120, a species I have not seen. Also with *C. pallidus* Reeve, l. c. pl. 16, fig. 92.

It is certain that this is not *Chiton longicymba* Blainville,

nor is the New Zealand species described by Quoy & Gaimard the same as that of de Blainville.

Ischnochiton fruticosus Gld.

Abundant at Port Jackson, with the next species. This form is distinguished from *I. divergens* by its very much smaller girdle scales. In *fruticosus* the individual scales measure in width .25 mm., or four to a millimeter. In *divergens* they measure .40, or only two and a half to the millimeter. The difference is perfectly obvious to the naked eye.

This species and the next seem to have been included by Angas under the name *Lepidopleurus proteus*. I believe *Callistochiton Coppingeri* Smith to be the young of this species.

Ischnochiton divergens Reeve.

Port Jackson and Port Hacking (Cox). 'Reeve's *Ch. proteus*, described from Newcastle, is a synonym.

Ischnochiton (Ischnoradsia) australis Sowb.

Port Jackson (Cox).

Ischnochiton (Haploplax) smaragdinus Angas.

Port Jackson (Cox). This species varies wonderfully in coloration. The following patterns being represented in the lot before me: (a) white or pale olive, the front and hind valves black; sometimes the fourth, fifth and seventh valves marked boldly with black. (b) Pale olive, flecked closely with olive, head and tail valves black. (c) Sky-blue, closely reticulated with olive, and in places marked with white. (d) Rich brown, speckled with olivaceous, and marked with white on valves i, iv, viii. The details are thus endlessly varied. Mr. E. A. Smith has kindly verified my determination by a comparison with Angas type of *smaragdinus*.

I. smaragdinus picturatus var. nov.

Color-scheme consisting of a wide dorsal stripe of lilac, dark blue, ochre or some combination of these or other hues; the stripe bordered with brownish, this border spreading forward on valve i, and spreading over most of valves ii and vi. Remainder of the side-slopes light and variegated. Girdle irregularly tessellated.

This seems so well defined a pattern of coloring that I venture to give it a name. Many specimens are before me from Port Jackson.

Ischnochiton (Haploplax) lentiginosus Sowb.

Shell rather thin, oval, moderately elevated, carinated, the sides slopes straight. Surface smooth except for slight radial riblets on the lateral areas. *Ground-color orange, orange-brown*, or even with an olive suffusion, *coarsely spotted throughout with bright blue*; the girdle olive-green, unicolorous or with dusky bars.

The intermediate valves are slightly concave behind, the beaks slightly projecting and interrupting the curve. Lateral areas slightly raised, marked by 4 to 6 weak, low radial riblets, obsolete in some specimens. Central areas having slight growth lines, but otherwise unsculptured except for the usual microscopic granulation of the whole surface. End valves showing traces of radial riblets toward the periphery. Posterior valve having the rather blunt mucro at the summit of the straight posterior slope, and in front of the middle.

Interior roseate in the cavity, olivaceous behind the valve-callus, the sutural and insertion-plates blue-white. Sutural-laminae short, projecting less than half the length of a valve, separated by a rather narrow, hardly squared, sinus. Anterior valve having 11, intermediate valves 1-1, posterior 13 slits; teeth sharp, normal.

Girdle clothed with densely imbricating convex, *polished* scales, which generally show a very minute striation under the compound microscope. The scales measure: width .28, alt. about .22 mm.; the width of a scale is therefore contained about $3\frac{1}{2}$ times in a millimeter.

Length 19, breadth 10 mm.; divergence about 115° .

This species was described from Newcastle, N. S. Wales. It has since been confused with *I. cyaneopunctatus* Krauss, a very similar species from the Cape; and its Australian habitat has been doubted. The rediscovery of the species in Australia (Port Hacking, N. S. Wales) by Dr. Cox is therefore of unusual interest.

In some specimens there is a narrow whitish stripe on the ridge of valves iii, iv, v, vii and viii; and in some the blue spots become enlarged and diluted on valve iv, forming a pale blue or whitish variegation.

This cannot be *Chiton clypeus* Blainv. (Diet. Sci. Nat., xxxvi, p. 540), which is also described as blue-spotted.

Genus CALLISTOCHITON Cpr.**Callistochiton antiquus** Reeve.

Port Jackson (Cox). Readily recognized by the very strong

sculpture of the valves, which is not paralleled by any other small Chiton of Australian waters.

Another species referred to this genus, *Callistochiton Coppingeri* E. A. Smith, has been described from Port Jackson. I have not seen the type, but I believe it to be a young, roughly sculptured *Ischnochiton fruticosus* Gld.

Family MOPALIIDÆ.

Genus PLAXIPHORA Gray.

Plaxiphora petholata Sowb.

Abundant and typical at Port Jackson and Port Hacking. At the latter locality some specimens occurred having the exterior colored like *P. glauca* Quoy (Man. Conch., XIV, pl. 68, fig. 72), and the inside pink and white, slightly clouded with blue. I have not seen specimens of the true *P. glauca*, which is described as smooth outside. The valves of *P. petholata* are always finely corrugated.

Family ACANTHOCHITIDÆ.

But one genus of this family, *Acanthochites*, has been found to have representatives in Australian waters. This genus is nearly world-wide in distribution in tropical and temperate seas. The other genera of the family are local in distribution, and contain very few species.

Genus ACANTHOCHITES Risso.

The genus *Acanthochites* is one of the most difficult groups of Chitons, partly on account of the insufficiency of the published descriptions of species, partly because the specific characters are not easy to see in the creatures themselves, especially if the external features only of the animal are studied.

When the valves are removed from the girdle, a number of excellent distinguishing characters are seen, enabling us to reach more satisfactory conclusions in most cases.

The characters to be especially observed are:—

1. General form, etc., features of girdle, its tufts, and presence or absence of a marginal fringe of longer spicules.

2. General features and coloring of valves; *shape of their posterior (sutured) margins*, which may be either concave, or convex and strongly imbricating.

3. Degree of *differentiation of dorsal areas*, which may be either raised at the edges, or continuous with the side areas, and *either transversely or longitudinally striated*. Sculpture of side-areas, and *shape of the pustules, which may be either convex or concave*.

The preceding features may be observed without disarticulating the specimen; the following require its dissection, which is easy enough after soaking it in warm water.

4. Shape of *tegumentum of tail valve*, proportion of its breadth to length, and position of mucro.

5. Shape of *posterior insertion-plate of tail valve*, which may be either regularly rounded or angular. Number of slits.

6. Length of front slope of tegumentum of head valve as compared with length from apex to edge of front teeth of same.

The last mentioned character is a good index to the degree of immersion of the valves in the girdle. Of course, any of these characters is subject to individual variation, but if a description is prepared noticing them all, it is extremely likely to contain something which will lead to the identification of a given specimen. In my account of this genus in the Manual of Conchology, insufficient attention was given to the features of the tail valve.

The following species referable to the family *Acanthochitidae* have been described from Australia:

1825.—*Chiton polychetus* Blainville, Dict. Sci. Nat., XXXVI, p. 552, New Holland.

1825.—*Chiton roseus* Blainville, *t. c.*, p. 553, New Holland.

1825.— “ *Sueurii* “ “ “ King George Sound.

1825.— “ *scaber* “ “ “ Seas of New Holland.

1861.—*Cryptoplax (Notoplax) speciosa* H. Adams, Proc. Zool. Soc. Lond., p. 385, Tasmania (Cuming); Flinder's I. (Milligan).

1864.—*Hantleya variabilis* H. Adams & G. F. Angas, P. Z. S. p. 194. Yorke Peninsula (Angas).

1864.—*Acanthochites carinatus* H. Adams & G. F. Angas, P. Z. S. p. 194. Port Jackson (Angas).

1864.—*Acanthochites costatus* H. Adams & G. F. Angas, P. Z. S. p. 194. Port Jackson (Angas).

1865.—*Acanthochites scutigera* A. Ad. & Ree., Angas, P. Z. S. p. 188. Port Lincoln (Angas).

1882.—*Acanthochites tristis* Rochebrune, Bull. Soc. Philomath. Paris, 1881-1882, p. 194. New Holland (Dussumier).

1882.—*Acanthochites turgidus* Rochebrune *t. c.*, p. 194. New Holland (Peron & Lesueur).

- 1882.—*Acanthochites jucundus* Rochebrune, *t. c.*, p. 194. New Holland (Belligny).
 1884.—*Chiton* (*Acanthochiton*) *asbestoides* Cpr. MS., E. A. Smith, Zool. "Alert" p. 83. Port Molle (Coppinger).
 1894.—*Acanthochites* (*Meturoplax*) *retrojectus* Pilsbry, *Nautilus*, p. 107. Port Jackson (Cox).
 1894.—*Acanthochites granostriatus* Pilsbry, *Nautilus*, p. 119. Port Jackson and Port Hacking (Cox).
 1894.—*Acanthochites* *Coxi* Pilsbry, *Nautilus*, p. 119. Port Jackson (Cox).
 1894.—*Acanthochites Matthewsii* Bednall & Pilsbry, *Nautilus*, p. 119, S. Australia (Matthews).

Of these seventeen species, the four described by de Blainville have not been recognized, and without an examination of the types they cannot, in my opinion, be really known. The three species described by Dr. Rochebrune will also prove difficult to identify, although *A. jucundus* will probably be recognized by its peculiar coloration. Most of these species of Blainville and Rochebrune were founded upon specimens collected in the early part of the century and no locality more exact than "New Holland" is stated. It must be remembered that even this vague geographical information is not to be considered conclusive. Some early voyagers have been known to get the localities of their shells mixed.

The remaining species are known to be Australian; but two of them, *H. carinatus* and *A. scutigera*, must be rejected; the first because the name is preoccupied by Risso (*Acanthochites carinatus* Risso, *Hist. Nat. Eur. Mérid.*, IV, p. 169. 1826), the other because it is founded upon an incorrect identification.

We have, therefore, eight recognizable species of *Acanthochites* from this region, if we include "*Hanleya*" *variabilis* which is unknown to me autoptically. To this number, one more is herein added.

The Australian *Acanthochites* fall into four subgenera or sections, distinguished by the following characters:

- a.* Anterior valve having five strong radiating ribs, lobing the periphery of the tegmentum; tail valve with several slits.
Loboplax
- aa.* Anterior valve without radial ribs, the lower margin of the tegmentum not obviously lobed
- b.* Valve viii having the mucro posterior, its insertion-plate

2-slit, the posterior portion strongly directed forward .

Meturoplax

bb. Posterior insertion-plate of valve viii spreading backward or vertical; mucro not at the posterior extremity.

c. Valve viii with two slits, and a wide, shallow posterior sinus *Acanthochites*

cc. Valve viii with several slits *Notoplar*

KEY TO AUSTRALIAN SPECIES OF ACANTHOCHITES.

a. Anterior valve having five strong radiating ribs; insertion-plate of tail valve with more than two slits *costatus*

aa. Anterior valve not strongly ribbed.

b. Posterior insertion-plate of tail valve directed forward, two-slit.

c. Posterior margins of median valves convex (or straight by erosion); side areas of valves coarsely granulose, the dorsal areas smooth, not defined, not longitudinally striated. Size small *retrojectus*

bb. Posterior insertion-plate directed backward or vertical; mucro not at the posterior extremity.

c. Valve viii with two slits, a wide, shallow sinus between them.

d. Tegmentum of valve viii less than half as wide as those of the intermediate valves; dorsal areas smoother than sides, but not defined, not longitudinally striated; posterior margins of valves very convex, broadly reflexed within; tufts dense, silvery, asbestos-like . .

asbestosoides

dd. Tegmentum of valve viii more than half as wide as those of intermediate valves; dorsal areas longitudinally striated; posterior margins of valves i to vii not convex, generally concave.

e. Posterior margin of the insertion-plate of valve viii regularly convex, not bilobed; sides of valves with radially elongated convex pustules; interior and sutural-laminae roseate; tufts inconspicuous, hardly

- longer than the harsh, stiff pile of the girdle generally *Coxi*
- ee.* Posterior margin of insertion-plate of valve viii biangular; sides of valves with flat or concave pustules; tufts noticeably longer than the pile of the girdle.
- f.* Dorsal areas smooth, with delicate longitudinal striæ . . . *granostriatus*
- ff.* Dorsal areas strongly, deeply striated longitudinally *Bednalli*
- ee.* Valve viii with more than two slits.
- d.* Tegmentum of valve viii pear-shaped, longer than wide; sides of valves pustulose, dorsal area defined, smooth; tufts subobsolete, *speciosus*
- ddl.*—Tegmentum of valve viii irregularly rounded; pleural tracts of valves longitudinally costate, lateral areas granulated; dorsal areas delicately striate longitudinally . . . *Matthewsi*

Acanthochites (Loboplax) costatus Adams and Angas. Man. of Conch., XV, p. 40, Pl. 3, fig. 74.

This species is distinguished by its strongly lobed head valve from all other known Australian *Acanthochites*. It is allied to *A. violaceus* of New Zealand and *A. tridacna* of New Caledonia. *A. costatus* has been collected by Angas at Watson's Bay, during an unusually low tide; also by Coppinger in Port Jackson. It has not been found there by Dr. Cox.

Acanthochites (Meturoplax) retrojectus⁵ Pilsbry. Pl. II, figs. 12, 13, 14, 15. Nautilus, vii, p. 107, January, 1894 (Preliminary description).

Shell small, narrow and elongated, convex, not carinated, black or black-brown, with a whitish "V" or three white stripes on each valve, sometimes broadly maculated with whitish at the sides, sometimes unicolored dark chestnut brown. Intermediate valves moderately beaked, convex behind (except valve ii, the posterior margin of which is straight), sculptured with comparatively coarse, rounded, scattered pustules, which become smaller and more crowded toward the middle, and are lower and less distinct on the ridge; no areas being distinctly differentiated on the valves. End valves similarly sculptured.

⁵In allusion to the backward thrown mucro.

Posterior valve small, having the mucro obtuse and posterior, the posterior slope short, vertical.

Interior green, marked with black in the cavity. Head valve having the insertion-plate about one-third as long as the front slope of the tegmentum, with 5 small slits. Intermediate valves having very oblique plates with 1-1 minute posterior slits; posterior valve having the insertion plate short, and strongly directed forward, with a small slit on each side. Sutural laminae rather long and narrow, projecting far forward. Sinus wide, deep and square.

Girdle microscopically chaffy, with a series of hyaline spicules at the edge and 18 small and compact silvery tufts.

Length $9\frac{1}{2}$, width $3\frac{1}{2}$ mm. (dry specimen).

“ 12, “ 6 “ (average specimen preserved in alcohol).

Abundant in Port Jackson, near Sydney (Dr. J. C. Cox!).

This is a very distinct and easily recognized little species, of which Dr. Cox has collected great numbers. It varies interminably in the color and pattern of the valves, but not much in sculpture. The subgenus which I have constituted for the reception of this one species may be defined as follows:

Meturoplax, n. subg. of *Acanthochites*. Subg. Char.: Valves i to vii as in *Acanthochites*, but dorsal areas indistinctly differentiated; valve viii having the mucro posterior, the insertion-plate strongly directed forward, with one slit on each side, and no sinus behind. Girdle as in *Acanthochites*. Type *A. retrojectus*.

This group holds the same relation to *Acanthochites* that *Pollochiton* holds to *Chatopleura*. It is a variation distinctly in the direction of the *Cryptoplacidae*, recalling *Choneplax*, and clearly showing the *Acanthochitoid* genesis of that family.

Acanthochites (*s. str.*) *asbestoides* Cpr. Pl. III, figs. 16, 17, 18, 19, 20.
Man. of Conch. XV, p. 17.

The prominent features of this species are (1), that the dorsal areas are hardly differentiated, being only somewhat smoother than the densely granulated latero-pleural areas, and totally lack longitudinal striation. (2) The posterior margins of the median valves are produced far backward in the middle, each strongly imbricating over the following valve, and inside the beak-margin is very broadly reflexed (fig. 16). (3) The tail valve is disproportionately small (compare fig. 20 with fig. 17) and its sutural-laminae are very long.

These features, in combination with the compact, asbest us-like sutural tufts, readily distinguish the species from other known forms.

A. asbestoides was collected by Coppinger at Port Molle, Queensland. It is also in the British Museum from Flinder's Island, Bass Strait. This last locality should be confirmed.

*Acanthochites Coxi*⁶ Pilsbry. Pl. III, figs. 21, 22, 23, 24, 25, 26; Pl. IV, fig. 34. Nautilus VII, p. 119, Feb. 1894 (preliminary description).

Shell elongated, the visible portion of the valves occupying less than one-third of the entire breadth of the animal (when preserved in alcohol). Valves grayish, somewhat mottled with olive and fleshy, the dorsal areas dark red or marked with olivaceous. Girdle olivaceous.

Exposed portions of the intermediate valves subtriangular, slightly elevated, hardly carinated, nearly separated at the sutures by spiculate bridges of the girdle. Dorsal areas wedge-shaped, convex, distinctly differentiated from the pleura but not elevated at the sides, sculptured with fine longitudinal striæ. Latero-pleural areas having the diagonal rib indicated by a low rounded convexity, and sculptured throughout with convex pustules elongated in a radial direction (fig. 21). Anterior valve having five low riblets indicated, each produced at the lower edge in a slight lobe. Posterior valve (Pl. III, figs. 22-25) having the tegmentum subcircular, a trifle wider than long, the mucro rather elevated and acute, behind the middle.

Interior rose colored. Anterior valve with the insertion-plate more than half as long as the front slope of tegmentum, pink, with five deep slits; intermediate valves having 1-1 slits, and a ridge running upward from the slits, as though the anterior edge of the posterior tooth projected over the posterior edge of the anterior tooth. Posterior valve having the insertion-plate subvertical behind, and slightly waved up between the two slits; its posterior contour convex. Sutural laminae large, rounded; sinus angular.

Girdle fleshy, densely clothed with short hyaline spinelets, the tufts being represented by inconspicuous clumps of somewhat longer spines.

Gills three-fourths the length of the foot.

Length 23, breadth 13 mm. (alcoholic specimen).

⁶Named in honor of Dr. J. C. Cox, of Sydney, N. S. W.

Port Hacking, N. S. Wales (Dr. J. C. Cox).

This species differs from *A. granostriatus* in the inconspicuous tufts, obvious though low diagonal ribs, convex pustules, rounded contour of the insertion-plate of the tail valve, etc.

Acanthochites granostriatus Pilsbry. Pl. II, figs. 1, 2, 3, 4, 5, 6; Pl. IV, fig. 37.
Nautilus VII, p. 119. Feb. 1894.

Shell rather elongated. Exposed portion of valves occupying about one-third to one-half the total width (in dried specimens). Valves moderately elevated and obtusely keeled, the ridge indistinctly clouded with whitish, *orange* and blackish; sides mottled in indistinct and varying pattern with olive and white. Girdle olivaceous, tufts silvery stained with blue or dirty olive.

Intermediate valves having the exposed portions broadly wedge-shaped, truncated in front, decidedly imbricating. Dorsal area of each valve wedge-shaped, rather wide, convex, distinctly differentiated from the pleural areas, but not raised at the sides, sculptured with numerous rather weak longitudinal striæ and crossed by slight growth-lines. Latero-pleural areas having no trace of a diagonal rib, sculptured with elongated, concave or flat pustules, arranged radially, and connected by opaque lines giving the appearance of radial striæ. Anterior valve with very slight indications of three or five low rounded radial ribs. Posterior valve having the tegmen-tum subcircular, the mucro rather acute and elevated, situated at the posterior third (Pl. II, figs. 2-5).

Interior of valves pink, becoming salmon colored posteriorly, stained with dark in the middle of the cavity, where there is a distinctly porous longitudinal band. Sinus moderately deep, squared and minutely crenulated. Posterior valve triangular, having an upward wave in the straight posterior margin, the postero-lateral margins concave.

Girdle clothed with short, greenish spicules and having eighteen conspicuous bluish or silvery tufts.

Length 9, breadth $3\frac{1}{2}$ mm. (dried specimen).

Length 10, breadth 7 mm. (alcoholic specimen).

Port Jackson and Port Hacking, N. S. Wales (Dr. J. C. Cox!).

Acanthochites Bednalli Pilsbry. Pl. II, figs. 7, 8, 9, 10, 11.

Shell oblong, moderately elevated, carinated, the side-slopes

straight. Color of valves light creamy-gray, sparsely maculated with dingy brown and white, usually showing some indistinct olive stains on some valves. Girdle gray, with conspicuous silky, silvery tufts.

The posterior (sutural) margins of the valves are nearly straight, the small beaks slightly projecting along the middle line. The tegmentum of each intermediate valve is divided into a distinct but not sharply defined triangular dorsal area, which is longitudinally marked by 15-20 *deeply cut striae*, and two subequilateral triangular side areas, which bear *concave* or flat topped ovate pustules, rather irregularly arranged. The anterior valve is similarly sculptured; and has several indistinct radial elevations; the front slope of its tegmentum is nearly double the length of the anterior teeth. The posterior valve has a rounded-hexagonal tegmentum which is somewhat broader than long, with the mucro between the posterior third and fourth of its length; behind the mucro sloping outward.

Interior tinged with rose in the middle and somewhat porous there, the teeth and sutural plates bluish or greenish; valve-callus strong; reflexed border of tegmentum very narrow. Anterior valve with five, intermediate valves 1-1 slits; posterior valve (Pl. II, figs. 8-10) having a distinctly biangular, bilobed contour behind; the posterior median portion straight, latero-posterior sides concave behind the two narrow slits. Sinus wide and angular in all the valves.

Girdle wide, densely clothed with short, gray-brown spicules, and having nine large tufts of long, silvery spicules on each side.

Length about 13, breadth $6\frac{1}{2}$ mm. (dried specimen).

Habitat: Western Shore of St. Vincent Gulf, S. Australia (W. T. Bednall).

This species is closely allied to *A. granostriatus*, but the valves are more solid; *the dorsal areas are much more deeply striated longitudinally*; that of valve viii is largely broken into granules. The sutural laminae in *A. bednalli* are greenish; the pustules of the side-areas are somewhat larger and rather less regularly arranged in longitudinal series. The profile of valve viii is not notably different in the two species, but the mucro of *A. granostriatus* is rather more posterior. *A. Bednalli* differs from *A. Coxii* in having much more conspicuous and silky sutural tufts, in the color of the interior and sutural laminae, in the flat pustules, and in lacking the curved dia-

gonal rib which in *Coxi* extends from the apex of each median valve to its lateral slits.

Acanthochites (Notoplax) speciosus H. Ad. Pl. IV, figs. 31, 32, 33.
 Man. of Conch., XV, p. 32, Pl. 1, figs. 23-26 (drawn from type).

This peculiar species may instantly be known by the wide, Cryptoplax-like girdle, densely clothed with minute spines which are thick and blunt for an *Acanthochites*, and having inconspicuous sutural tufts, not longer than the surrounding pile, but composed of finer, whiter spicules. The tegmentum of each intermediate valve is triangular, the girdle tissue forming spiculose bridges at the sutures. The dorsal areas are sharply defined, convex, and arcuately striated by growth-lines, but show no longitudinal striae. The latero-pleural areas have round concave-topped pustules. Other notable features are found in the tail-valve, which is very high, with vertical posterior insertion-plate, and pear-shaped tegmentum. The sutural laminae and insertion-plates are radially striated, and the posterior valve has several slits, besides the usual pair. The tegmentum of the head-valve is small, extending hardly half the length of the front slope of the valve. The figures are drawn from a specimen from St. Vincent Gulf, furnished by Mr. W. T. Bednall. It has been known hitherto from Tasmania (Cuming coll.) and Flinder's Island (Jos. Milligan).

Acanthochites (Notoplax?) Matthewsi Bednall and Pilsbry. Pl. IV, figs. 27, 28, 29, 30.
 Nautilus VII, p. 120, Feb. 1894.

Shell elongated, narrow, moderately elevated and carinated, the side-slopes straight. Valves of a delicate flesh tint, each having several concentric, forward-converging, zigzag bands of olive-brown. Girdle hoary, with white sutural pores.

Valves i to vii have the posterior (sutural) margins concave, the small beaks slightly projecting. Dorsal areas narrow, very convex, but not raised at the edges, delicately striated longitudinally. Side areas divided into pleural and lateral tracts by a small curved diagonal riblet; *the pleural tracts sculptured with longitudinal riblets* (about fifteen on each side), flattened and faintly crenulated; as they cross the diagonal rib these riblets bend abruptly upward, passing obliquely across the lateral areas, upon which they are more distinctly crenulated or broken into pustules, especially near the beak of each valve. Anterior valve having five low radial elevations,

pinnately corrugated, the lower margin of the tegmentum feebly angulated by them. Posterior valve having a large, irregularly rounded tegmentum, ribbed in front, granulated behind; *muero* at the posterior fourth of tegmentum, decurved and hooked, the slope behind it concave.

Interior white, with bluish macule at sinus and bases of the sutural laminae. Anterior valve with five, intermediate valves 1-1 slits; posterior valve having the posterior insertion-plate flaring backward and outward, with one strong slit on each side and several (two or three) between them. Sinus rather wide.

Girdle narrow, densely clothed with minute spicules, and having rather large bunches of very short white spicules at the sutures.

Length 26, breadth 8 mm. (dried specimen).

Habitat: South Australia (E. H. Matthews!).

The sculpture of this species is extremely peculiar, and totally different from that of any previously known member of the family *Acanthochitidae*. The coloring is also markedly distinct. The type was sent me by Mr. W. T. Bednall of Adelaide, South Australia, who suggested the specific name employed above. Although technically a *Notoplax* in its multifissate tail valve, this species is very unlike *A. speciosus*, the type of that group.

Acanthochites (Notoplax?) variabilis.

Hanleya variabilis H. Ad. and C. F. Ang., P. Z. S., 1864, p. 194; Angas, P. Z. S., 1865, p. 188.

Shell oblong, whitish, variegated with blackish-brown. Valves broad, carinated; dorsal areas longitudinally densely costate, the ribs closely pustulose; lateral areas but slightly elevated, transversely undulately costate, the costae closely pustulose. Girdle having short white corneous spicules at the margin, and bunches of pale spicules. Length 16, breadth 10 mm.

Habitat: Yorke Peninsula, under stones at low water (Angas).

The above translation of the original description is given for comparison with that of *A. Matthewsii*. This species is otherwise unknown to me, and may prove to belong to some other group. It is evidently distinct from *A. Matthewsii*, the proportions of breadth to length in the two being so different as to preclude the suspicion of identity which I at first entertained.

Family CRYPTOPLACIDÆ.**Genus CRYPTOPLAX** Blainville.**Cryptoplax striatus** Lamarek.

Abundant in Port Jackson.

The large series of admirably preserved specimens submitted by Dr. Cox shows conclusively the uncertainty and variability of the pore bunches. In some individuals they are all developed; in others most of them are certainly absent, the minutest scrutiny of the surface showing no trace of pores or their spicules.

Family CHITONIDÆ.**Genus CHITON** Linné.**Chiton pelliserpentis** Q. & G.

Port Jackson (Cox). I am quite unable to detect any difference between the excellent, fresh specimens sent by Dr. Cox and the New Zealand specimens from Auckland. This is the only species of the order known to me to be common to New Zealand and Australia.

Chiton muricatus A. Ad

The central areas have a ribless triangle in the middle; the pleura have about 10 narrow riblets on each side in front of the diagonal rib, but not extending forward to the anterior margin of the valve. The most prominent feature of this species is the peculiar sharp-pointed girdle scales, a character unique in this genus. This species was described from Sydney. Dr. Cox obtained specimens in Port Jackson showing great variation in color. Angas found it at Port Lincoln.

Chiton jugosus Gld.

A beautiful species abundant in Port Jackson.

Chiton Coxi n. sp.

Shell oblong, strongly elevated, carinated, the side slopes straight, *Pleura longitudinally grooved in front of the diagonal, the surface elsewhere smooth.* Color delicate bluish, mottled or blotched with olive-brown, yellow and white. Girdle a delicate blue-green, with narrow white bars.

Intermediate valves moderately beaked; *lateral areas smooth and well raised*; central areas having a large smooth triangle in the

middle; the *pleura sculptured with deep narrow grooves*, separated by intervals about double their width, and *extending but a short distance forward from the diagonal line*, except that the outer three or four grooves extend to the anterior edge of the tegmentum. About 9 or 10 grooves may be counted on each side of a valve. Anterior valve much larger than the posterior, unsculptured. Posterior valve having the *micro acute*, about central, distinctly projecting; the posterior slope concave.

Interior bluish or creamy white; sinus notched at the sides, delicately denticulate. Anterior valve having 8, intermediate valves 1-1, posterior valve 12 slits; teeth pectinated outside and on the edge.

Girdle rather wide, densely clothed with imbricating, convex, shining scales which are densely and most minutely striated, have the usual low rounded outlines, and measure in breadth .30 mm.

Length 13, breadth $7\frac{1}{2}$ mm.; divergence 90° to 110° .

Port Jackson (Dr. J. C. Cox).

This is probably the *Lophyrus jugosus* of Angas, P. Z. S., 1867, p. 222.

It is allied to *C. jugosus* Gld. but differs totally in color-pattern. The girdle scales are smaller than in a specimen of *jugosus* of the same size; the grooves in front of the diagonal line are narrower, with wider interspaces, etc.

Genus LORICELLA Pilsbry.

This name was proposed originally as a section of *Loricella*. At that time I had seen no specimens of *L. Angasi*, its type. Several alcoholic examples are now before me, showing features not before noticed, which are undoubtedly of generic importance. The group may be characterized as follows:

Gen. char.: Valves entirely exposed, the front one very large, having numerous unequal, conspicuously pectinated teeth; median valves squared, having a narrow bi-lobed sinus, slits 1-1; posterior valve small, with posterior *micro*, the insertion-plate reduced to a low ridge, nearly smooth and interrupted by a slight sinus behind. Girdle widest in front, having a small slit behind; densely covered with minute elongated granules and bearing long, branching bristles arranged in radial series.

In short, *Loricella* has the general features of *Loricella*, plus girdle

hairs, and with the girdle and tail-valve shaped like those of *Placiophorella*.

The hairs of the girdle branch, somewhat as in *Mopalia ciliata*. There is no trace of eyes or eye-pits upon the valves; but the genus has doubtless descended from a form having eyes, and its position in the general system will not differ from that assigned in my monograph of the Polyplacophora.

Loricella Angasi Ad.

Port Jackson, several specimens collected by Dr. Cox. It occurs also in South Australia. The largest specimen I have seen is one sent by Mr. Bednall of Adelaide.

The presence of hairs upon a girdle with a dense covering of scales is an extremely rare if not unparalleled combination of characters.

Genus LILOPHURA Pilsbry.

Liolophura Gaimardi Blainv.

1825.—*Chiton Gaimardi* Bly., Dict. Sc. Nat., xxxvi, p. 546.

1846.—*Chiton ineanus* Gld., Proc. Bost. Soc. N. H., ii, p. 145.

1867.—*Chiton piceus* Angas, P. Z. S., 1867, p. 223. Not of Gmel.

1874.—*Chiton piceus* Tap. Can., Viag. 'Magenta,' p. 77.

1893.—*Liolophura Gaimardi* Pils., Man. of Conch., xiv, p. 240.

Collected abundantly at Port Jackson and Port Hacking by Dr. Cox. This species has been confused by writers with *Acanthopleura*. The latter genus is found in Australia only along the coast of tropical Queensland.

Three species of the genus *Liolophura* are now known from Australia: *L. Gaimardi*, inhabiting the coast of New South Wales, with a variety in Queensland; *L. georgiana* Q. and G., described from King George Sound, S. W. Australia, and *L. curtisiana* Smith, from Port Curtis, Queensland. I have not seen the last-named species.

L. Gaimardi queenslandica n. var.

Valves similar in form and coloring to those of *L. Gaimardi*; girdle covered with black spines, which are somewhat more slender than in *Gaimardi*. Length 50, breadth 31 mm. (dry specimen).

Larger than any of the typical form seen, and distinguished by the uniform black color of the girdle. Type is No. 64,853 of the

Academy collection, taken by Dr. Cox at Bundaburg, Queensland.

Genus **ONITHOCHITON** Gray.

Two species or at least forms of this genus are represented in the collections made by Dr. Cox at Port Jackson and Port Hacking. The relations of *O. Lyellii* Sowb., *quercinus* Gld. and *rugulosus* Ang. are peculiarly perplexing, and more material than is before me is required for a satisfactory revision of the group.

O. rugulosus Angas.

Port Jackson and Port Hacking, (Cox!). In this form the lateral areas are transversely rugose, and the pleura have fine, close irregular riblets, converging toward the ridge.

O. quercinus Gould.

Port Jackson (Cox!).

I take this to be the form having the central areas nearly smooth, with some riblets toward the outer edges of the pleura. Probably intergrades with the preceding.

EXPLANATION OF PLATES.

PLATE II.

FIGS. 1 to 6. *Acanthochites granostratus* Pilsbry.

FIG. 1. Dorsal view of valve vii.

FIG. 2. Dorsal view of valve viii, sutural laminae broken.

FIG. 3. Ventral view of valve viii, sutural laminae broken.

FIG. 4. Posterior view of valve viii.

FIG. 5. Lateral view (profile) of valve viii.

FIG. 6. Sculpture of the middle of side area of an intermediate valve, x 22.

FIGS. 7 to 11. *Acanthochites Bednalli* Pilsbry.

FIG. 7. Dorsal view of valve vii.

FIG. 8. Dorsal view of valve viii.

FIG. 9. Posterior view of valve viii.

FIG. 10. Lateral view of valve viii.

FIG. 11. Sculpture of side area, x 22.

FIGS. 12 to 15. *Acanthochites retrojectus* Pilsbry.

FIG. 12. Dorsal view of an intermediate valve.

- FIG. 13. Dorsal view of valve viii.
 FIG. 14. Lateral view of valve viii.
 FIG. 15. Ventral view of valve viii.

PLATE III.

- FIGS. 16 to 20. *Acanthochites asbestoides* Carpenter.
 FIG. 16. Ventral view of valve vi.
 FIG. 17. Dorsal view (outline) of valve vi.
 FIG. 18. Lateral view of valve viii.
 FIG. 19. Ventral view of valve viii.
 FIG. 20. Dorsal view of valve viii.
 FIGS. 21 to 26. *Acanthochites Coxi* Pilsbry.
 FIG. 21. Sculpture from middle of a side-area, x 22.
 FIG. 22. Posterior view of valve viii.
 FIG. 23. Lateral view of valve viii.
 FIG. 24. Dorsal view of valve viii.
 FIG. 25. Ventral view of valve viii.
 FIG. 26. Dorsal view of valve vii.

PLATE IV.

- FIGS. 27 to 30. *Acanthochites Matthewsii* Bednall and Pilsbry.
 FIG. 27. Dorsal view of valve vii.
 FIG. 28. Dorsal view of valve viii.
 FIG. 29. Lateral view of valve viii.
 FIG. 30. Dorsal view of entire animal, natural size.
 FIGS. 31 to 33. *Acanthochites speciosus* H. Adams.
 FIG. 31. Dorsal view of valve viii.
 FIG. 32. Lateral view of valve viii.
 FIG. 33. Posterior view of valve viii.
 FIG. 34. *Acanthochites Coxi* Pilsbry: dorsal view of an alcoholic specimen, natural size.
 FIG. 36. *Acanthochites retrojectus* Pilsbry: dorsal view of an alcoholic specimen, natural size.
 FIG. 37. *Acanthochites granostriatus* Pilsbry: dorsal view of an alcoholic specimen, natural size.

TANAIS ROBUSTUS, A NEW SPECIES OF ANISOPODA.

BY H. F. MOORE.

In August, 1892, the collectors of the Marine Biological Laboratory of the University of Pennsylvania, at Sea Isle City, N. J., brought in a large logger-head turtle, *Thalasseochelys caretta*.

Examination showed its carapace to be burdened with a miscellaneous collection of invertebrata, including Polyzoa, Anellida, Cirripedia, Pycnogonidia, Caprellidae and a single species of Anisopoda.

The latter, which has apparently heretofore escaped notice, was found in numbers inhabiting minute tubes in the crevices between the scales of the turtle's carapace. When unmolested, these little crustaceans could be seen crawling carefully about among their fellow voyagers or lying at the mouths of their domiciles with only the head and chelæ projecting; when disturbed they promptly retreated out of sight. I am unaware of any other species of the family Tanaidae occupying a similar position.

Though differing in some slight particulars from the genus *Tanaïs* as re-constituted by Sars, the sum of its characters evidently places it in that genus and I propose for it the name *Tanaïs robustus*.

It is quite robust for the family, being less than $3\frac{1}{2}$ times as long as broad. The carapace, which is the broadest portion of the body, is terminated anteriorly by a minute rostrum, whilst its posterior border is somewhat concave in the middle line. In front of the origin of the great gnathopods the lateral outline is strongly concave, but opposite the bases of these limbs it becomes swollen. When viewed dorsally, the carapace appears, in general figure, top-shaped. Two grooves, one on each side, indicate upon the dorsal surface the inner boundary of the branchial chamber. Behind the carapace the breadth of the body becomes gradually less with each successive segment. The fourth free segment of the peræon is the longest, slightly exceeding the third, which is in turn longer than the fifth.

The pleon is composed of six distinct segments, of which the fourth and fifth are much shorter than the others and the sixth is terminated, posteriorly, by a blunt median projection. The body is constricted at the joints and the segmentation is distinctly marked. The dorsal surface is furnished, laterally, with a few setæ, which on the first and

second segments of the pleon form a short row on each side, but never form a transverse band crossing the segment.

The eyes and eye-lobes are large, the latter being let into deep recesses in the anterior lateral portion of the carapace.

The antennulæ consist of three joints, of which the basal one is somewhat longer than the other two combined. A small knob (rudimentary flagellum) terminates each. In the male the antennulæ usually about equal in length the carapace with the first free segment, but are sometimes considerably longer. In the female they are about equal to the carapace alone.

The antennæ lie close beneath the antennulæ, by which they are slightly exceeded in length in both male and female. They are five-jointed, the fourth joint being the longest, slightly exceeding the second; the fifth, third and first following in the order named, the last mentioned being very short. Each antenna is terminated by a densely setiferous rudimentary flagellum considerably longer than that of the antennules and sometimes imperfectly articulated,

The mandibles are of the usual form, curved inwards at the tip where each bears a pair of horny teeth, shaped like the limbs of the letter U. Proximad of the middle, a stout transverse column passes mediad bearing at its end an oval molar plate traversed by a series of parallel ridges with deep grooves between. Under a high power each ridge appears to be broken up by shallow indentations into a series of rounded teeth.

The first maxillæ consist of a stout forwardly directed column and a posteriorly directed palpus, bearing at its end a brush of seven or eight long setæ. The anterior ramus is stout and curved towards the median line, bearing at its tip a group of about eight stout, curved spines, each with two series of fine, apically directed, denticuli. A brush of stiff setæ lies near the base, and laterad of, the spines. A smaller group of spines lie on one face near the tip; these are not denticulate and lack the brown color of those in the apical group.

The maxillipeds are adherent basally by means of short, stout hooks. The basal joints are prolonged on their anterior or oral aspects into plate-like processes, which are coupled together in the median line. Each basal joint bears a flattened palpus, consisting of four joints, the terminal three being furnished with long setæ. The distal joint is strongly flexed on the penultimate. A somewhat falciform

branchial epipod is attached to the maxilliped at its base, by means of a slender stalk.

The first gnathopods are strongly chelate in both sexes, but especially so in the males. The "thumb" of the propodite is terminated by a horny tooth and external to and just within this is a sharp-edged tubercle; the tooth of the dactylopodite bites between these two. Figs. 6 and 6a, Plate V, show the gnathopods of male and female side by side and give a better idea of their appearance than can be gained from a description.

The limbs of the first free segment of the pereon are long and slender, their terminal claws being but slightly curved. The two succeeding pairs are stouter, with the dactylopodite and claw shorter than in the first pair. The last three pairs are still stouter, the dactylopodite bears a strongly hooked claw with a comb-like series of minute curved teeth on each side and the distal end of the propodite bears a row of stout setae. All the limbs except those of the first free segment have the distal end of the carpopodite crowned with a few stout spines, some bifid, others serrulate.

Only the anterior three segments of the pleon bear limbs (pleopods). Each of these consists of a flat basal piece (protopodite) to which are attached two one-jointed blades furnished, on their outer edges, with long pinnate setae, the exopodite bearing about 35, the endopodite about 15. Both protopodite and endopodite bear a single stout seta on their inner edge.

The last segment bears a pair of four-jointed setose limbs (uropods), the segments of which are cylindrical and increase in length from base to tip.

The marsupia of the female are thin walled pouches attached to the ventral wall of the sixth thoracic segment (fourth free segment). They increase in size with the development of the eggs and in some specimens extend over segments five and seven, to which, however, they are not attached.

The largest specimens collected measure from rostrum to tip of pleon 4.7 mm, and in width 1.4 mm. The ground color in alcoholic specimens is pale yellow. Upon the carapace this is heavily mottled with brownish pigment, excepting over about thirty elliptical and sub-elliptical areolae symmetrically arranged towards the middle line. The dorsal surfaces of the chelae are similarly marked. The portion of

the body and the limbs behind the carapace are much paler, being usually concealed in the tubular dwelling.

Nine species of *Tanaidæ* have been previously recorded from the western shores of the North Atlantic, namely :

Tanaïs vittatus Rathke.

T. hirsutus Beddard.

Leptochelia Savignyi Kröyer = (*L. algicola* Harger ♀).

L. dubia = (*L. algicola* Harger ♂).

L. rapax Harger.

L. (?) filum (Stimpson) Harger.

Heterotanaïs limicola (Harger) Sars.

Leptognathia cæca (Harger) Sars.

Neotanaïs americana Beddard.

Tanaïs vittatus, *L. Savignyi* (?) and *L. dubia* (?) have been taken at Great Egg Harbor Bay, New Jersey.

T. hirsutus was dredged by the "Challenger" in 50 to 150 fathoms off Prince Edward Island.

Neotanaïs americana was dredged by the "Challenger" in 1,250 fathoms about 200 miles southeast of New York.

H. limicola, *L. cæca* and all the species of *Leptochelia* enumerated have been taken on the New England coast.

The genus *Tanaïs* may be distinguished from all others by the possession of one-branched uropods, pleopods on the first three segments only of the pleon and incubatory sacs at bases of the fifth pair of limbs. Sars in his re-definition of the genus says, "uropoda brevia, simplicia, ramo singulo bi-vel tri-articulato." His figure of *T. carolinii* possesses four joints, though Milne Edward's figure has but three. *Tanaïs (Zeuxo) Westwoodiana* has six joints, *T. hirsutus* has twelve and *T. novæ zealandæ* has five, one more than the species just described.

T. robustus differs from *T. vittatus*, the only other New Jersey member of the genus, by its greater robustness and tapering body, by the possession of one more joint in the pleon and in the absence of setiferous bands crossing the first two segments of the pleon.

In the foregoing reference is made to the following papers :

Beddard, F. E. "Challenger" Reports. Isopoda—1886.

Harger, O. Report on the Marine Isopoda of New England and Adjacent Waters. Report of U. S. Fish Commission, 1878.

Norman, A. M. and Stebbing, T. R. R. On the Crustacea Isopoda of the "Lightning," "Poreupine" and "Valorous" Expeditions. Transactions Zoölogical Society of London, 1886.

Sars, G. O. Revision der Gruppen; Isopoda Chelifera. Arch. f. Mathematik, Vol. VII.

Stebbing, T. R. R. A History of Crustacea. New York, 1893.

DESCRIPTION OF PLATE V.

Fig. 1. Dorsal view of male.

Fig. 2. Antenna of male.

Fig. 3. Mandible. 3a a portion of molar surface in section,

Fig. 4. First maxilla with its backwardly directed palp terminated by long setae. 4a, apical portion of maxilla, showing the apical and sub-apical groups of spines and the auxiliary brush of stiff bristles.

Fig. 5. Maxilliped.

Fig. 6. First gnathopod of male; 6a of female. The basal joint is not shown.

Fig. 7. Limb of first free thoracic segment.

Fig. 8. Last thoracic limb.

Fig. 9. Pleopod.

Fig. 10. Uropod.

MARCH 6.

The President, GENERAL ISAAC J. WISTAR, in the chair.

Thirty-four persons present.

A paper entitled "Some volcanic products from the Hawaiian Islands," by E. Goldsmith, was presented for publication.

MARCH 13.

The President, GENERAL ISAAC J. WISTAR, in the chair.

MARCH 20.

The President, GENERAL ISAAC J. WISTAR, in the chair.

Forty-three persons present.

MARCH 27.

The President, GENERAL ISAAC J. WISTAR, in the chair.

Thirty-three persons present.

A paper entitled "Description of a new Armadillo with remarks on the Genus Muletia," by Samuel N. Rhoads, was presented for publication.

Theodore N. Ely and Dr. Gustavo Niederlein were elected members.

The following were ordered to be printed :—

RE-EXPLORATION OF HARTMAN'S CAVE, NEAR STROUDSBURG, PENNSYLVANIA, IN 1893.

BY H. C. MERCER.

Rumor had reported the existence of a cave in Monroe County, Pennsylvania, which Mr. T. Dunkin Paret after some searching discovered in 1880 on the top of a hill overhanging Cherry Creek,

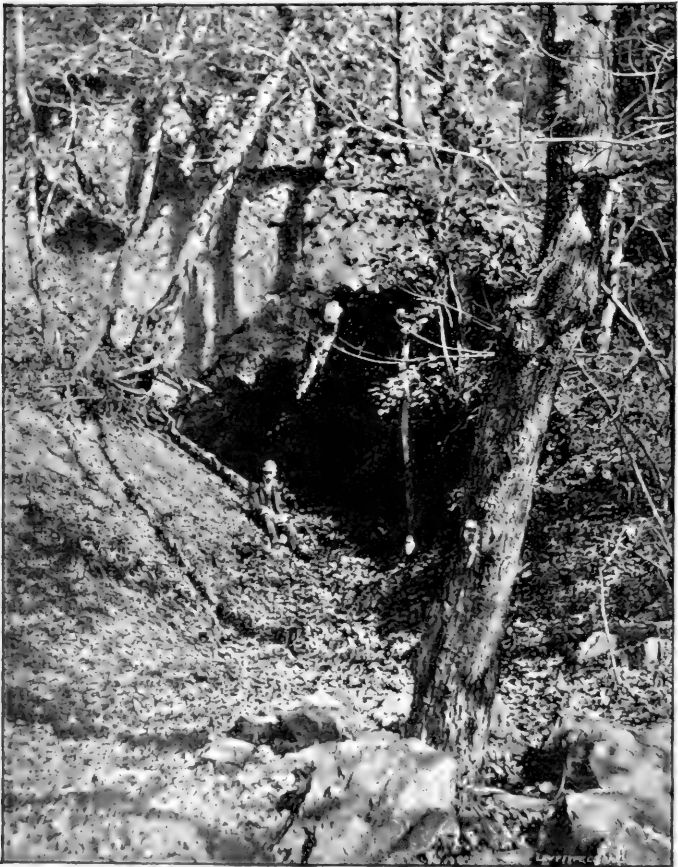

FIG. 1. Entrance to Hartman's Cave.

about four miles from Stroudsburg. Eight hundred feet above and five miles west of the Delaware River, with its nearest drinking water, the creek, one-fourth of a mile down the steep, and eight or nine miles north of the glacial moraine, the damp, chilly hole seemed hardly a good lair for beasts, much less a shelter for men.

Original discoveries of Mr. Paret.—When Mr. Paret had removed the debris which choked its broad arch, Fig. 1, so that a man could scarcely wriggle like a snake 150 feet in, he encountered traces of men and animals in a top layer of limestone roof-splinters and down-slidden outer talus thinning inward into less stony cave earth. All this relic-bearing material lay upon a bed of clay of unprobed depth which appeared to over-spread the whole cave bottom, and it was always above this clay and never in it, that Mr. Paret's workmen found (often in his absence, for business prevented his continued supervision) the specimens collected: the thin chipped blade of argillite (fifty feet in to the extreme right; depth not stated, the four bone awls; the potsherd, (outside the entrance on a ledge); the bone fish-hook, needle and harpoon;¹ along with remains of the lynx, gray fox, wolf, skunk,

¹ I have just received the following interesting letter from Mr. Paret:
Stroudsburg, Pa., March 25, 1894.

DEAR SIR:

Yours of 10th at hand and I am obliged for your letter and for your slip as to the cave discussion at the Academy of Nat. Sciences. Have you had the clay examined microscopically? If not, it might be advisable. Something might be learned as to its origin.

The potsherd was not dug out. It was not found by my men, but a visitor who picked it up *from the surface*, from that shelf of rock, away up on the right, (as you face the cave) where I and a man worked a little while you were there. It was *outside* of the cave entirely, on a rock shelf, at foot of cliff, away above the cave level. The shell has a curious history: One of my men brought it to me. His two boys got into a quarrel at home, he interfered and found they were disputing for the shell. He asked where it came from and they said, from the cave; so he took it away from them. He told me it was full of clay and that he washed it out. He is a man in whom I have implicit trust. The argillite blade and peccary jaws were found about same time and place—about 50 feet inside of cave, on extreme right. The fish-hook was found on same side, but not so far in. I do not think there is anything to prove how old the horse tooth is. The one striking fact to me is that no stone tool has been found at any depth or dug out. The potsherd was on bare rock. The arrowhead I found was in earth on a flat rock—only a few inches covered and a few inches of earth below. But the bone tools were all dug from below the surface. Boys talk is that many stone tools used to be picked up on the rock shelves inside of the cave. Why were none found in the soil as those of bone were?

I feel sure that if stone was in free use when the bone was, some would have been found with the bone. . . . I am firm in my belief that your trench is of small value till a *much longer one* is extended at right angles outwards. I also believe that if all the debris in front of cave was removed much more might be found. Your trench simply proved that no human or animal remains were contained in a cross cut of that length and narrow width. There is room outside it for many hearths at various levels.

Yours truly,

T. DUNKIN PARET.

weasel, raccoon, mole, dusky rat, little brown bat, woodchuck, porcupine, beaver, muskrat, gray squirrel, ground squirrel, meadow mouse, white field mouse, wood rat, gray rabbit, deer, elk, wild turkey, turtle, box turtle, snapper, snake, three species of *Helix*, a *Unio* and a *Margaritina*, besides (to make the discovery particularly noteworthy) the following remarkable objects:

(1) A perforated marine shell² bead made from the *Conus tornatus*, alleged by a farmer to have been brought from the cave trench by his little sons, which, on the authority of Mr. Geo. W. Tryon in 1880, and Mr. Pilsbry in 1894, belongs to the Pacific Coast mollusca of Central America and which therefore suggests the whole question of aboriginal trade and the query whether the cave occupants had really obtained a shell from somewhere nearly two thousand miles away.

(2) Several teeth of the reindeer (*Rangifer caribou*) which seem to infer a colder climate.

(3) A tooth of *Bison americanus* asks us to account for the presence of this browsing animal of the Mississippi Plains in the easternmost mountain steeps of the great forest.

(4) The jaws and teeth of the extinct peccary, *Dicotyles Pennsylvanicus*, which with (5) the teeth of the extinct giant chinchilla, *Castoroides ohioensis*, suggest antiquity, though we cannot yet prove that these animals became extinct in Pennsylvania more than 300 years ago.

(6) Two teeth of a horse, discovered at a point and depth not noted, which Dr. Leidy (who visited the cave in 1880 and identified all the bones then found by Mr. Paret, see Ann. Report of Geolog. Surv. of Pennsylvania, 1887, p.1-20) says belong to an indigenous species. If this be so it may well set us to wondering what aborigines on the hilly upper Delaware were doing with horses before the time of Columbus.

² Mr. Paret has not understood that my cross trench in the outer talus (see Fig. 2) contained both human and animal remains, in fact revealed a layer of Indian occupancy, 1 foot thick and 1 1-2 to 2 feet below the surface. This layer must once have continued into the cave and the only question is was it the only layer in the cave or were there other layers under it which I did not find outside? Why, asks Mr. Paret, were no stone tools found underground (if the knife is an exception) by Mr. Paret's men? There is nothing un-Indian about the bone tools found.

I should answer; because the men had missed seeing the few small, dull looking objects that would have told the tale. The single barbed bone arrow or spear is common to Eskimo and Indian, and there is, I believe, nothing un-Indian about any of the bone tools discovered.

Neither Dr. Leidy nor Mr. Paret has asserted that the human remains of this second known cave of importance in the Delaware Valley were those of Indians or any other people definitely named, or that the bones, often rodent-gnawed, and the scanty human refuse belong to one and the same period of occupancy, so it seemed worth while for the sake of the buried human story of the Delaware Valley to go back to the cave in October 1893, and study what might be left of the original layers to determine if possible:

(a) Whether the animal and human remains were contemporaneous.

(b) Whether the human remains were Indian remains.

(c) Whether the human remains were of geologically ancient or modern date.

Present Condition of the Cave.—Mr. Paret showed me the cave on the hill top October 17, 1893. Nearly all the upper stratification had been shovelled out until one could walk in under the broad, chilly arch for 117 feet, 6 inches. But as the unfathomed clay remained underfoot from end to end and fringes of the original debris lay along the right and left walls just inside the entrance, and as the talus heap outside had only been trenched through the middle to clear an ingress and so showed

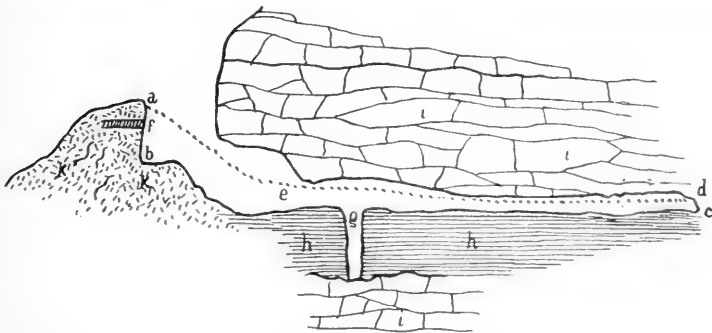

FIG. 2.

its original stratification when its edges were pared down (Fig. 2, c. a. e.), there seemed some chance of recovering the lost threads of the story.

The Contemporaneity of Human and Animal Remains.—Two men shovelling five days in the inner clay and slicing the

outer talus, our examination of the remaining small fringes of debris brought us to the first question:

Were the animal and human remains contemporaneous?

If they were not, no matter what the bison, horse, chinchilla and reindeer meant in the cave, their bones told us little of the date of Man's visit, and their discovery formed no interesting link between archaeology and paleontology. Our trench 40 feet in from the entrance, 3 feet, 8 inches wide, and 22 feet, 3 inches long, dug for possible hidden layers and bottom, at right angles across the cave floor showed a continuous homogeneous bed of exquisitely fine clay, deposited in thin laminae rarely sprinkled with sand pockets and underlaid with a film of sand resting on an uneven limestone floor at 5 feet, 11 inches; 10 feet, 7 inches; 11 feet, 6 inches and 14 feet, 1 inch.

As no sign of life, no interrupting layer from top to bottom was apparent, it seemed that it could be relieved of all connection with Mr. Paret's discoveries. The animal remains and human refuse must have all belonged to the debris and cave earth above it, and it only remained to be asked before we were done with this all important test of stratification whether Mr. Paret's relic-bearing upper deposit of roof slivers, rotten leaves, human relics, bones, charcoal and ashes, gathered dust and inrolled talus consisted of one layer homogeneous throughout, telling of one uninterrupted time of occupation, or of several layers differing in character, separated by interplaced bands proving time intervals between the visits of Man and beast. The trouble was that nearly all this cave floor material had been dug away and all we had to guide us was what was left of it, its outer end so to speak, in the talus. But when we cut into this talus just outside the entrance we did what we would have done had we explored the cave at the start, and when we found a thin layer of human occupancy in it 1 foot thick and $1\frac{1}{2}$ to 2 feet below its surface we inferred that this human layer was but a continuation of the lost human layer inside the cave. Yet as the conditions for soil formation outside probably differed from those inside the cave, and as we only penetrated 10 to 12 feet into the outer talus without reaching the clay or its equivalent that should have been below it, there was a chance that our talus was not a fair end slice of the cave, and that there might have been several human layers inside against the single one in the talus outside.

Too much critical ground had been lost and we had to be satisfied

with the rediscovery of one human layer at least, which we had a right to call either the single layer or the uppermost of a series of layers originally found in the cave. To its date or to a later time evidently belonged the bones which Professor Cope, who has assisted me in this work, has kindly identified of the turkey, chipmunk, cat squirrel, marmot, smaller vole, larger vole, short tailed shrew, raccoon, skunk, gathered by Mr. Paret and myself in the aforesaid side fringes of debris just inside the entrance.

But as to the original bones found in 1880, careful side cutting into the cave floor in the first place might have shown which of the discovered fragments were really part of the cave feast too well bedded between the fire sites to have been scratched out of older under layers and into newer and later layers and which were not, but these clues have been lost.

In some caves every bone found has seemed fairly and clearly part of the Midden heap. But it was against all the evidence produced at Hartman's that the place had been a lurking hole for small animals. Some had come into the crevices to die, leaving their skulls. Others, whose bones rodents had gnawed, had been brought in by carnivora in the first place or carried by pilfering rodents from the human feast.

There is, therefore, only a probability that Man killed and ate the bison, castoroides and peccary in Hartman's Cave, since, minus the lost layers, we may say that there is no proof that these animals did not come there to die, or that they were not carried in whole or piecemeal by large carnivora when their bones, though lying on the cave floor long before Man's advent, would have come in close contact with his subsequently built hearths.

The nature of the human remains. No proof that they were not of Indian make.—As to the second question: Were the remains Indian remains? The Trenton gravel Man if we grant his existence must be ruled out of Hartman's Cave, for there was not one of his described rude, leaf-shaped, turtle backs found among the chipped blades and arrowheads that in themselves denied his existence there. Whether the human remains found by Mr. Paret came from the same layer in which I found mine or from other layers now untraceable, there is no need of searching for a new and as yet undescribed cave occupant to account for the bone awls common at the Trenton Delaware Valley site found by me in the Indian layers at the Forge Cave in

Virginia, at the Hummelstown Cave in Dauphin County, Pennsylvania and at the Nickajack and Lookout Caves in Tennessee. The hammerstone, argillite cache blade, pottery and chert arrowheads are duplicated at the Lenape villages at Point Pleasant, Ridges Island and Gallows Run on the Delaware River, while the single barbed bone spear from a shell heap explored by me in September 1891 on York River, Maine, can be again referred to the Red Man.

We may safely say that the notion of a precedent people vanished at Hartman's Cave, and that the only Man that I found there or that I have reason to suppose that Mr. Paret found there as the possible contemporary of the reindeer, and bison, extinct peccary and giant chinchilla was the chert-using, pottery-making Indian of the Delaware Valley, already the possessor of the bow and arrow and the quarry denoting cache blade.

Antiquity of the human remains.—When we ask the third question: Were the human remains of geological antiquity or of modern date and, granting the association of the extinct mammal bones, use their presence to prove great age. We must remember that the absence of historical mention which largely gives the word "extinct" its meaning, and which in Europe reaches back 2000 years at once, has here as yet but a proved retrospect of hardly more than three centuries. The fact that John Smith or the Jesuits did not observe the peccary in the northern United States does not disprove its scanty or straggling existence in their time, and we cannot be certain that, as Jefferson supposed, a few superannuated mammoths were not hiding in forest corners as late as the 18th century. Only the correlation of the fauna of many more caves with human remains can give us a just notion of the time-span of many of these animals and make definite the still vague border line between archaeology and paleontology.

The problem of the clay.—It is for geology to explain the exquisitely fine laminated clay containing no sign of life that so deeply covers this cave floor.

It must have been quiet water holding mud in solution that laid it there, film upon film, nor could the process have been arrested by dry intervals or the visits of men and beasts, since no dissimilar, dry laid or life betokening stratum interrupts it. How this beautiful clay, widely unlike the coarse, red deposits in the Lookout and Nickajack Caves in Tennessee or the Durham Cave, 10 miles below Easton on

the Delaware, got into its place with nowhere save the gritty hill crest just above to come from, is the question. Could it have been the residuum of the rock decomposition which originally formed the cave cavity or in other words the rubbish of cave erosion choking up three-fourths of the eroded hole?³ We would know how and why successive pools of yellow mud-bearing water could cover the floor once upon a time and not now, where the water came from, since any down running rivulet would have rolled in the hillside grit with it, and why the flooding process was not interrupted by intervals, when animals came in and debris was formed?

A possible answer to these questions seems to be suggested in the important and interesting fact that Hartman's Cave lies eight miles north of the glacial moraine, differing therein by position from all other caves in the United States lying to the southward of the now well-known silhouette of pebbles that profiles the southern limit of ice advance. It is therefore one of those glaciated caves distinct and individual by position, full, perhaps, of new secrets for us, which, if the glacial theory be true, must have been sealed up with superincumbent ice like a tightly corked bottle throughout most of the frozen period.

If this clay is due to the banking up of ice and the draining of muddy glacial waters into the caves' mouth then we can account for it, but if ice damming and ice water had nothing to do with it, and on the other hand it is due to a subsequent submergence of the hill top below water level in the Champlain period, then similar clay beds ought to be found in caves, like Durham, south of the moraine and their absence remains to be accounted for.

Moreover if this clay is glacial then other caves north of the moraine should show the same ice-sealed barrier, beyond which no preserved relic of post glacial age penetrates.

The Indian and his relics, the fossil castoroides and peccary, were left behind as we got down into the clay with nothing before us it seemed but the beginning of the cavern itself. Was the cave then no older than the melting ice? If so, why and how had the

³ If this were the case the composition of the clay should, I am told, show its limestone parentage. But no carbonates have been found in it to suggest that it was a near relative of limestone, while on the other hand it showed the same reactions as clay dredged up from the bottom of the Delaware River, near Chester.

disintegrating streamlets which made it at the same time nearly filled it with the residuum of their own erosion? If it was older than the ice sheet, why were no tertiary fossils associated with the quaternary? None of the bones that protrude from the bleak gorges in the bad lands of Texas to frighten Indians have ever been found in subterranean rock hollows. We found none of these in or below this clay in Hartman's Cave. Had they never lain there, or, coming in like their quaternary successors, had they been washed out, or, as Prof. Cope suggests, had the whole tertiary fossil-bearing end of the cave been eroded away in the lapse of time? However this may be, if we are right, the clay in Hartman's Cave marks with the precision of a pointing clock hand, the hour of the glacier in the world's history. What is under the clay comes before what is over it, after the ice.

If the ice made the clay we must go back, not to any event since the clay (post glacial) or any event during the clay-making (glacial) but to some event before (preglacial) to find a force, whether of cave washing or cave erosion, that could have swept this cave clean of the fossil remains of creatures that lived before the quaternary.

VOLCANIC PRODUCTS FROM THE HAWAIIAN ISLANDS.

BY E. GOLDSMITH.

Kauaiite.—As the Hawaiian Islands are known to be of volcanic origin, the appearance in a crater of a substance resembling chalk may occasion surprise.

Professors Benj. Sharp and W. Libbey, Jr. who visited a number of the Pacific Islands during the past year, secured, on the Island of Kauai, a specimen which, in external appearance, very much resembles chalk. Although definite information as to its relation to adjacent solfataras and cracks is desirable it has not been obtained, nor is it known whether the material is rare or abundant.

The specimen weighed but a few ounces. To the eye it appears to be amorphous and made up of an extremely fine powder which soils the fingers when touched. Despite its softness the particles adhere firmly, its hardness being about 0.5. It can be easily cut with a knife into any shape, precisely like chalk. It is perfectly dull to the reflected ray of light; the color is nearly white or, to be exact, of a faint cream tint. One side of the specimen is covered with a thin coating of brown oxide of iron. The streak is white and its lines on a black-board cannot be distinguished from lines made with white chalk. Only formless granules are revealed under the microscope and, strange to say, increasing power serves but to show more of the granules in the field without any increase in size. In all of the granules the diameters seem to be about the same.

If the material be imbedded in balsam and interposed between the crossed Nicol prisms, light is transmitted. The ray of light transmitted under these conditions is pale blue and no other color of polarization is produced. By this means the particles can be observed to the best advantage, as, when projected on a dark background, singly and in groups, the contrast favors observation. In the manner that the modern chemist describes the molecule do these fine particles form groups and the picture presented in the field of view so strikingly resembles the molecular conception of the present day as to almost tempt one to believe that the atom had at last become visible, provided we assumed that the fine particles

of the material, as revealed under the microscope, are atoms. It possesses no dichroism. Specific gravity 2.566.

When heated in a Bunsen flame it slightly decrepitates and emits the yellow light due to sodium. When heated in a test tube it gradually becomes dark gray, indicating some carbonaceous matter and, when heated strongly, an oily matter and water having an acid reaction are emitted. Heated with the blowpipe on charcoal with carbonate of soda it effervesces and finally produces a white enamel. Heated by itself, on the charcoal, it produces an intense white incandescence and, reheated with cobalt solution, a fine blue is obtained.

It is not soluble in water, sulphuric, hydrochloric or nitric acids, but if boiled with a caustic alkali it dissolves. If, however, the substance is brought to a red heat and there maintained for some time, it is then dissolved by any of the above named acids.

The chemical analysis, made in duplicate, resulted as follows:

Alumina	(Al_2O_3)	33.40	per	cent.
Sulphate alumina	($Al_2O_3SO_3$)	7.18	“	“
Sulphate potassium	(K_2SO_4)	17.00	“	“
Sulphate sodium	(Na_2SO_4)	4.91	“	“
Water.	(H_2O)	31.57	“	“
Carbonaceous matter, difference		5.94.		

The carbonaceous matter was not especially determined in the belief that in all probability it is an accidental admixture foreign to the composition of the original substance.

From the analysis above given it is evident that the compound is a highly basic sulphate, and, eliminating the percentage of carbonaceous matter and finding the oxygen ratios between the sulphur trioxide, the alumina and all the monoxides, the composition[†] determined is as follows:

Alumina	(Al_2O_3)	39.79	per cent.	18.68	per cent.	Oxygen.
Potassium oxide	(K_2O)	7.37	“	“	1.25	“
Sodium oxide	(Na_2O)	1.72	“	“	0.44	“
Water	(H_2O)	33.56	“	“	29.82	“
Sulphur trioxide	(SO_3)	17.55	“	“	10.52	“

The ratios of the SO_3 , Al_2O_3 , R_2O are nearly as:

$$1, \quad 2, \quad 3$$

which may be represented by the formula:

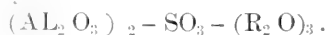

Here R_2 represents K_2 , Na_2 , H_2 .

There are a number of basic sulphates recorded, all of which seem

to be soluble in acids, although the one under discussion is not. I would, therefore, propose *Kauaiite* as a name for the new variety. The extremely fine division and the approach to crystallization without forming true geometrical solids may suggest the mode of its formation. It may, with the exception of the carbonaceous matter, be ejected as volcanic. An objection might be based on the large percentage of water, but we must remember that in some volcanoes water is an almost constant ingredient of their ejections, and we may, therefore expect to occasionally meet with so-called hydrous compounds in the material thrown out. The aluminium may have been distilled by the intense volcanic heat together with the other elementary metals and metalloids sulphur. Coming in contact with the atmosphere, the material was oxidized and quickly precipitated on the cooler surface of the earth, giving no time for the formation of crystals. If corundum is reduced and volatilized by the heat produced in the electrical furnace, we may expect similar results from the enormous heat energy of a volcano.

Volcanic Stalactites.—That the highly heated and very fluid lava in the crater of Kilauui, as well as in other craters, is occasionally shot up into the air some thirty feet or more, has been reported at various times and has also been observed by the gentlemen before referred to. Such lava in its descent through the air becomes very porous. If such a highly porous rock have a space underneath, a fresh deposit of liquid lava will trickle through the porous cooled lava, forming as it solidifies the pendent stalactites shown in Plate VI. These stalactites are about one-fourth of an inch thick and about eight inches long. They show no disposition to form cones like those usually seen in limestone caves. These slender, gnarled, rod-shaped formations are mostly hollow and porous and so brittle that it is difficult to prepare a thin section for microscopical study. The color is usually a deep black, sometimes a part is of a brownish tint, due, probably, to a higher oxidation of the magnetite present. Occasionally a gray color is noticed but this is caused by the incrustation of some other substance. To ascertain its probable mineralogical composition, it was necessary to use the fine powder, imbedding it as usual in balsam. The fragments examined beneath the microscope indicate a glassy feldspar having apparently the characteristic of sanidine. They contain magnetite in great profusion and also gases, probably air. A dichroic mineral is also recognizable in the mixture,

but whether it is augite or not is at present uncertain. A fragment weighing 2.459 grams in air, and 1.297 grams in distilled water had a specific gravity of 2.11, evidently far too low for lava as generally known, undoubtedly due to the extremely porous nature of the material. By producing a coarse powder and taking the specific gravity in a picnometer, the result is 2.85.

Considered from a chemical standpoint, this lava is decidedly basic, as the quantity of silica determined analytically was 48.55 per cent.

The specific character of this rock, now shown in the form of stalactites is that of the so-called vesicular basalt.

On some of these volcanic stalactites, there had formed a thin layer of colorless crystals so small that their form could be recognized only under power.

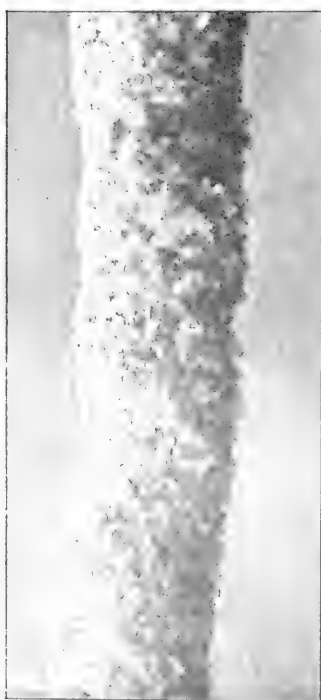

Fig. 1. Volcanic stalactite covered with selenite, x 4.

These thin prismatic crystals are attached to one end and terminated by short pyramids; on certain faces they are longitudinally striated. In the groups are frequently seen twin crystals whose dual faces are mostly the longer axis. Figure 1, magnified about 4 diameters, shows how the crystals are attached to the volcanic stalactites. A slide, prepared and observed under a power of about 45 diameters shows the twin-formations of the crystals, Fig. 2. That these crystals belong to the monoclinic system is evident from the fact of their inclined extinction which, upon measurement, was found to be 37° , the longer axis of the crystals being zero to extinction over the pyramid. The colors of polarization were brilliant. Dichroism was unnoticed in these forms.

With the aid of Toulet solution the specific gravity of the material

at my command (about 8 milligrams) was found to be 2.285. It is soluble in water and gives the reactions indicating sulphur trioxide and calcium oxide. The incrusting small crystals are, therefore, selenite.

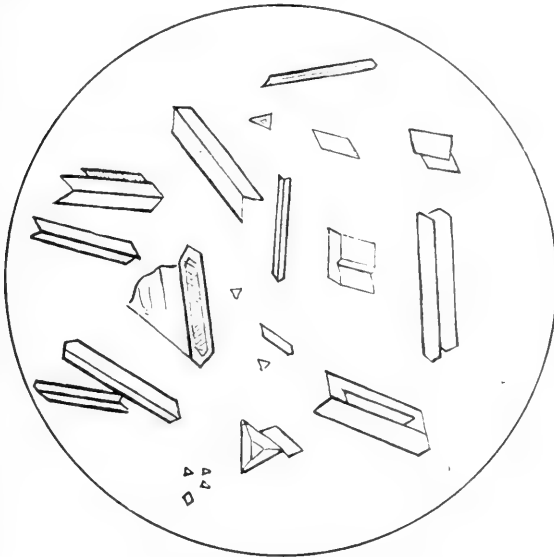

Fig. 2. Crystal and twin forms of selenite, $\times 45$.

I am indebted to Professors Sharp and Libbey for the material studied and also for the photographs of the volcanic cave.

Plate VI shows the entrance to the cave with its overhanging roof of porous basalt from which are suspended the irregularly gnarled rods of volcanic stalactite; on the floor are scattered fantastic-shaped volcanic stalagnites which seem to be much thicker than the pendant rods above.

APRIL 3.

The President, GENERAL ISAAC J. WISTAR, in the chair.

Thirty-eight persons present.

Papers under the following titles were presented for publication:—

“A Revision of the Genus *Anous*.” By Witmer Stone.

“On the true character and relationship of *Ursus cinnamomeus* Aud. and Bach.” By Arthur Erwin Brown.

DR. C. NEWLIN PEIRCE was elected a member of the Council to serve for the unexpired term of Mr. Gavin W. Hart, resigned.

APRIL 10.

The President, GENERAL ISAAC J. WISTAR, in the chair.

Eighteen persons present.

APRIL 17.

The President, GENERAL ISAAC J. WISTAR, in the chair.

Thirty persons present.

APRIL 24.

The President, GENERAL ISAAC J. WISTAR, in the chair.

Twenty-seven persons present.

A paper entitled “A Review of the Old World *Rallinae*” by Witmer Stone, was presented for publication.

The deaths of Wm. V. Keating, M. D. and J. Howard Gibson, members, were announced.

The following were elected members:—A. B. van der Wielen, Rev. Leander Trowbridge Chamberlain, D. D., Charles G. Macey and J. W. Parker.

The following papers were ordered to be printed:—

DESCRIPTION OF A NEW ARMADILLO, WITH REMARKS ON THE GENUS
MULETIA GRAY.

BY SAMUEL N. RHOADS.

Tatusia (Muletia) propalatum Rhoads, sp. nov., Type No. 3349. Col. Acad. Nat. Sci. Phila., juv. ad. ♀. "Bahia, Brazil, E. D. Cope."

Size smaller than *T. hybrida* Desm., with relatively longer and more slender tail, equalling length of body. Free rings of tail, excluding basal superior half-ring and subterminal attached ring, 10. The last, with remaining distal portion of tail, measuring one-third total length of tail. Posterior edges of caudal rings flaring, giving the tail a roughly serrate outline. Distal end of tail very slender, pointed, the tesseræ diamond shaped. Basal tail rings with double row of tesseræ, the basal row becoming relatively shorter nearest body while on the last (distal) rings the tesseræ of both rows are of equal length in each ring. Rows of tesseræ on pelvic shield, counted near border and including the wide anterior semi-free ring, 22. Free dorsal rings, 7, preceded anteriorly by wide posterior ring of shoulder-shield of tesseræ similar in formation to dorsal rings. Larger tesseræ of free dorsal rings slender, wedge shaped, their posterior corners scarcely divided by the points of slender awl-shaped intervening tesseræ, the bases of latter, half the width of ends of former. Rows of tesseræ on shoulder-shield counted near border, 17, similar in arrangement of tesseræ to those of pelvic shield. Ears five-eighths length of head, finely scaled and set close together at base. Crescentine coronal shield separated by a freely moving nexus of skin from frontal cephalic shield. Three distinct rows of tesseræ before and beneath the eye. Frontal tesseræ relatively smaller than in other species of *Tatusida*. Manus 4-toed, pes 5-toed. From each papilla of protected lower parts springs a short, slender bristling hair of same color as skin, averaging one-fourth inch in length. Skin yellowish white. Upper parts and tail amber yellowish, nose and ears near tips brownish, the toes of same color.

Skull slenderly and regularly pyriform. Zygomatic width not exceeding the mastoid, tapering regularly to the rostrum. Greatest depth of cranium over two-thirds its greatest width. Interorbital width over two-thirds zygomatic width, the frontals nearly obscuring

the orbital fossa as viewed from above. Lachrymals triangular, lateral, not visible from above, their anterior apices overlying second posterior upper grinder. Roof of mouth deeply grooved. Palatal bones slightly hollowed centrally but without posterior raised edges. Pterygoids rounded, divided by a slit 1 mm. wide their entire length, reaching a slight postpalatal notch. Palatal bones anteriorly reaching beyond anterior base of last upper molar. Upper molar series 6 on a side: no indication of a seventh, on dissection. Lower molar series 8 on a side, including a minute thread-like anterior premolar, evidently deciduous and widely separated from the next. Coronoid process of mandible long and very slender.

Measurements.—Body, along back, from fore end of shoulder shield to root of tail, 115*; head and neck, from tip of nose to shoulder shield (above) 58; hind foot, 40; ear, from crown 29, its greatest width (flattened) 19. Skull; occipito-nasal length, 48; zygomatic breadth, 21; interorbital constriction, 15; length of nasals, 15; basal length of upper molar series, 11; length of mandible, 34.

The type specimen is about two-thirds of the maximum development, judging by a series of skins and skulls of *T. novemcincta*. *Tatusia (Muletia) hybrida* is the only described species with which it must be compared. From *hybrida* in the Academy's collection it is distinguished by: 1 seven free dorsal bands; 2 longer slender-pointed tail; 3 comparative number of shoulder and pelvic girdle rows; 4 absolute number of free caudal rings; 5 greater relative length of ears; 6 much greater relative depth to width of cranium; 7 much greater relative interorbital width; 8 separation (lateral) of the pterygoids; 9 palatine bones reaching beyond anterior base of last upper molar (in *hybrida* they fall short of the molar series 1 mm.); 10 coronoid process slender from base to tip, (not triangular).

Dr. J. E. Gray in the Proceedings of the London Zoological Society, 1874, page 244, redescribes the Short-tailed Armadillo, *Tatusia hybrida* (Desm.), and places it in a new genus, which he calls *Muletia*, separating it from *Tatusia* in the following diagnosis:

“1 *Tatusia*. Tail cylindrical, elongate, as long or longer than

* Millimeters.

the body, of many rings and numerous caudal vertebrae. Ears large. Dorsal disk with 9-7 free bands. *Tatusia peba* &c."

"2. *Muletia*.—Tail short, depressed at base, not so long as the body, with thirteen rings and thirteen caudal vertebrae. Ears small, dorsal disk with six free bands. *Muletia septemcincta* &c."

As above characterized, Dr. Gray's new genus is a fair sample of more than half the new genera proposed by him! No very careful examination will show that the two species which he makes typical of these genera share equally some of the characters assigned as distinctive, while those given which are distinct are of doubtful generic or subgeneric value. The number of free dorsal bands above is doubtfully of more than specific value between the numbers 10 and 6. *Tatusia novemcincta* has from 8 to 10. Desmarest says that "*Dasyppus hybridus*" has "six ou sept bandes mobiles á la cuirasse."

However, in making an examination of the specimen above described as new, I was struck to find in it not only a superficial resemblance to *T. hybrida* as compared with *T. peba*, but that it agreed with Dr. Gray's figure of *hybrida* (l. c. Pl. XLI) in having only twelve upper teeth as against the fourteen or sixteen always present in *T. novemcincta*. To convince myself of the constancy of this character I have examined several skulls of both species and found no exception. In all the other plates of the various newly described *Tatusinæ* I have seen, in no case are they represented with less than fourteen upper teeth.

Should a more exhaustive examination show no exceptions, it would be proper to at least accord subgeneric rank to *Muletia*, with the following diagnosis :

Genus TATUSIA.

Tail longer than body, its first basal ring complete, the distal two-thirds with a well-defined inferior median canal, increasing in depth with age, and in number to three and five near the extremity. Caudal rings convex, each closely compressed posteriorly upon the next. Dorsal disk with eight to ten free bands; upper molars, fourteen to sixteen; lower molars, ditto. Type *Tatusia novemcincta* (Linn.) Cuv.

Subgenus MULETIA.

Tail not exceeding length of body, not channeled distally. Caudal rings with free, elevated posterior margins, the first basal seg-

ment a crescentine half-ring, clasping the superior anterior portion of second ring, the latter being produced forward beneath it. Dorsal disk with six to seven free bands; upper molars, twelve; lower molars, fourteen to sixteen. Type *Tatusia (Muletia) hybrida* (Desm.) Gray.

The nine-banded Armadillo, *Dasypus novemcinctus* Linnæus, Syst. Nat., 1758, 51, has quite generally gone under the specific name *peba* of Desmarest, (Mamm. 1820, 368), who puts the *septemcinctus*, *octorcinctus* and *novemcinctus* of Linnæus, Erxleben and Boddaert among his synonyms, implying that these are composite species and indistinguishable. The use of Desmarest's name *peba* is unwarranted, the original Linnæan description and references relating, in the main, unmistakably to the same animal. The first reference to *peba* (Seba Mus. I, p. 45, tab. 29, Fig. 1), is unmistakably the nine-banded species; see also his reference to Maregrave.

Dr. Gray (sup. cit. pp. 245, 246), discusses the identity and synonymy of *Tatusia hybrida* (Desm.), and names it *T. septemcincta* after Schreber (Säuget., 1775, II, 220), who there describes a species which he considers the same as Linnæus' *Dasypus* of the same name, quoting the Systema Naturæ, 12th edition, in which it is the same as in the 10th. In these Linnæus describes a "*Dasypus*"—"D. cingulis septenis, palmis tetradactylis, * * * Habitat in Indiis." Schreber's description and figure fairly represent what Dr. Gray chooses to call "*Muletia septemcincta*," but as this specific name was first applied by Linnæus to an unrecognizable Armadillo from India it is inapplicable to a six-banded Armadillo from South America.

Desmarest's *Dasypus hybridus* is the first indisputable name for a short-tailed, six or seven-banded *Tatusia* from tropical America. Dr. Gray's disgust at the barbarous name of *hybridus*, by which Desmarest probably referred less to the animal's pedigree than to its asinine ears, seems utterly inconsistent with the naming of his new genus. As such, however, it may nominally be allowed to stand, not only as a warning to the future namer of names, but in the interests of an overburdened synonymy.

A REVISION OF THE GENUS *ANOUS*.

BY WITMER STONE.

Having recently had occasion to identify some specimens of *Anous* and make comparison with Gould's types of *A. leucocapillus* and *A. melanops*, I was surprised to find what confusion existed in regard to the proper disposition of the names which have been proposed for several members of the genus.

With the object of straightening out the synonymy of the group I have made a careful study of the literature bearing upon the subject and have examined the large series of specimens in the museum of the Academy of Natural Sciences of Philadelphia, and a number of specimens loaned to me by the U. S. National Museum through the kindness of Mr. Robert Ridgway.

The species of the genus *Anous* are separable into two groups, the larger dark colored birds (*Anous*) and the smaller light colored ones (*Procelsterna*).

Of the latter there seem to be two well marked species, *A. caeruleus* and *A. cinereus*, though Mr. Saunders, strange to say, unites them in his monograph of the Sterninae (Proc. Zool. Soc. 1876, p. 671) without comment.

In regard to the dark colored species there has been no confusion in connection with the two large species, *A. stolidus* and *A. galapagensis*, but when we study the smaller species we immediately find difficulties.

Four names have been employed for the three recognizable species:

Sterna tenuirostris Temm. Pl. Col. 202 (1838).

Anous melanops Gould. P. Z. S., XIII, p. 103 (1845).

Anous leucocapillus Gould. P. Z. S., XIII, p. 103 (1845).

Anous melanogenys Gray. Gen. Birds, III, p. 661, Pl. 182 (1849).

Gould's *A. melanops* is regarded by Mr. Saunders as a synonym of *A. tenuirostris* (Temm.) and a comparison of the types with Temminck's plate amply confirms his decision.

The *A. leucocapillus* of Gould, however, is the bird which Mr. Saunders figures and identifies as *A. melanogenys* Gray. What Gray's bird really is I am unable to say; if it is the species with

which Mr. Saunders identifies it, the figure is certainly very poor, but the name will have to be considered a synonym of *A. leucocapillus* Gould.

The sooty *brown*-black species so well figured and described by Mr. Saunders (P. Z. S, 1876, Pl. LXI, Fig. 3) as "*A. leucocapillus* Gould" seems to be the most distinct of the three, but is, so far as I can ascertain, unnamed. I therefore propose for it the name of *A. atrofuscus*.

The following table will serve to distinguish the species:

- a. General color of plumage sooty-brownish, or blackish slate.
 - b. Size larger, wing 10 ins. or more.
 - c. Plumage sooty-brown *A. stolidus*
 - c'. Plumage darker, more slaty *A. galapagensis*
 - b'. Size smaller, wing 9 ins. or less.
 - c. Plumage sooty-brown, white of head sharply defined posteriorly *A. atrofuscus*
 - c'. Plumage blackish slate, white of head shading gradually into the color of the back.
 - d. Lores light slate colored *A. tenuirostris*
 - d'. Lores jet black. *A. leucocapillus*
- a'. General color of plumage very light gray.
 - b. Nearly pure white beneath. *A. cinereus*
 - b'. Light gray beneath, nearly uniform with the back.
 - *A. caeruleus*

Anous stolidus Linn.

Sterna stolidus Linn., Syst. Nat., 1, p. 227 (1766).

Sterna fuscata Linn., Syst. Nat., 1, p. 228 (1766).

Sterna pileata Scop., Del. Faun. et Flor. Insubr., I, p. 92, No. 73 (1786).

Sterna senex Leach in Truckey's Exped. to the Congo, App. p. 408 (1818).

Anous niger Steph., Shaw's Gen. Zool., XIII, 1, p. 140, Pl. 17 (1825).

Anous spadiuea Steph., Shaw's Gen. Zool., XIII, 1, p. 143 (1825).

Sterna unicolor Nordm., Erm. Verz. v. Thier and Pfl., p. 17 (1835).

Anous rousseauxi Hartl., Beitr. Orn. Madagasc., p. 86 (1860).

Hab. Intertropical seas north to Gulf coast of United States.

Anous galapagensis Sharpe.

Anous galapagensis Sharpe, Trans. Philos. Soc., CLXVIII, 1879, p. 469.

Hab. Galapagoes Islands.

Anous tenuirostris (Temm.).

Sterna tenuirostris Temm., Pl. Col. 202 (1838).

Sterna melanops Gould., P. Z. S., XIII, p. 103 (1845).

Hab. Senegal (Temminck), W. coast of Australia (Gould).
Mauritius (Saunders).

The only specimens of this species that I have seen are the two types of Gould's, *A. melanops*, a male and female from Hartman's Abrolhos, Australia. These differ slightly from the figure given by Mr. Saunders, for although the lores are light gray, they are uniform with the side of the neck rather than with the cap and there is a distinct line of demarkation passing from the base of the upper mandible opposite the nostril to the upper edge of the eye, instead of from the gape as drawn in Mr. Saunders' figure.

This species is lighter colored than the next two and the cap is not so white, being nearly uniform pearl gray from the base of the bill to the nape.

Anous leucocapillus Gould.

Anous leucocapillus Gould, P. Z. S., XIII, p. 103 (1845).

? *Anous melanogenys* G. R. Gray, Gen. Birds III, p. 661, Pl. 182 (1849).

Anous melanogenys Saunders, P. Z. S., 1876, p. 670.

Hab. Raines Isl., Australia (Gould); Nihan Hawaiian Isls. (U. S. N. M. coll.) British Honduras (U. S. N. M. coll.) Dangerous Archipelago (U. S. N. M. coll.)

The jet black lores and the darker slate black plumage readily distinguish this from the preceding species while the very different tint of the plumage and the difference in extent of the white on the head separate it from the following.

Two specimens in the U. S. National Museum collection, one labelled "Dangerous Archipelago" and the other "Pacific Ocean" belong to this species, and it is probable that all the remarks in the Reports of Peale and Cassin refer to this bird. This seems to be the most abundant species of the genus after *A. stolidus*.

Anous atrofuscus sp. nov.

Anous leucocapillus Saunders, P. Z. S., 1876, p. 670, not *A. leucocapillus* Gould.

Hab. Bristow Isl., New Guinea (Saunders). Montevideo (Coll. A. N. S. Phila.)

The *brown*-black color of the plumage and the uniform white of the crown, sharply contrasted with the brown of the neck easily distinguish this species. Mr. Saunders' figure (P. Z. S., 1876, Pl. LXI, Fig. 3) is an excellent representation of this bird, although in the specimens before me the white of the head does not extend quite so far back.

Description.—General color above and below uniform sooty *brown*-black, primaries black, lores, immediately in front of the eyes rather blacker than the sides of the head.

Crown from base of bill to occiput nearly pure white with the line of demarkation between the white and general color of the hind neck *very sharply* defined. Wing 8.75 inch, culmen 1.80.

Type.—No. 5,027 collection Acad. Nat. Sci. Philada. (from the collection of the Duke of Rivoli) "Mer de Montevideo."

One other specimen is in the collection of the Philadelphia Academy (No. 5,028) which was collected in the Southern Pacific by J. K. Townsend.

Anous cinereus Gould.

Anous cinereus Gould, P. Z. S. 1845, p. 104.

Hab. E. Coast of Australia (Gould).

Anous caeruleus (Bennett).

Sterna caerulea Bennett, Narr. Whaling Voy. round the Globe, II, Appendix, p. 248 (1840).

Anous parvulus Gould, P. Z. S., XIII, p. 104 (1845).

Hab. South Pacific; Christmas Isl. (Bennett), Dog Isl. (Peale, U. S. Expl. Exped. spec. in U. S. Nat. Mus.).

ON THE TRUE CHARACTER AND RELATIONSHIPS
OF *URSUS CINNAMOMEUS* Aud. and Bach.

BY ARTHUR ERWIN BROWN.

The original description of *Ursus americanus* var. *cinnamomum*¹ was based by Audubon and Bachman mainly upon fur-traders' skins, and in the accompanying plate the animals were figured from living specimens seen by Audubon in the Garden of the Zoological Society of London.

They characterize the species, briefly, thus: "Form and size of the common American black bear, of which it is a permanent variety. Color above, a dark cinnamon brown; nose and a fringe of hairs covering the claws yellow;" and regarding its range, they say "sparingly found in the fur countries west and north of the Missouri, extending to the barren grounds of the northwest."

In the absence of all cranial and dental characters in their description, it has usually been supposed that their animals were nothing more than examples of the well-known brown phase of *Ursus americanus*, notwithstanding the fact that in their description of the latter species (*l. c.* p. 188) the authors show that they were familiar with its brown form and correctly estimated its position.

Specimens have recently come under my observation which appear to show what Audubon and Bachman's bear really was and that it is well distinguished from the form with which it has for so long been confounded.

The history of the material on which these conclusions are based is as follows:—In December, 1873, a male bear was received at the Garden of the Zoological Society of Philadelphia, from Ogden, Utah, which presented striking features of color and physiognomy when compared with the already known species of American bear. This specimen has always been associated in my mind with Audubon and Bachman's description, above quoted, but he is still living and the impossibility of making a detailed examination of his skull has hitherto prevented any definite conclusions from being reached. In 1884 a captive bear came to my notice at Green River, Wyoming,

¹ Quad. of North America, 1854, Vol. III, p. 125, Pl. CXXVII.

which offered the same striking external features as the first. This animal I tried to purchase, but without success. Several years later I had the good fortune to kill a third specimen, also an old male, in the elevated and rugged region north of the White River, Colorado. The skin and skull were roughly prepared in camp, but were afterward irrecoverably lost. In November, 1891, the late James E. Cooper, a well-known showman of Philadelphia, procured, at some point on the Union Pacific Railway in Wyoming, and presented to the Zoological Society, another individual, identical in appearance with the three others. This specimen has since died and the skin and skeleton are now in the collection of the Academy. Finally, in the summer of 1893, Prof. E. D. Cope procured in a cave in the Ozark mountains, Missouri, a somewhat broken cranium of the same type, which he has kindly placed at my disposal for investigation. There are, therefore, presented for detailed examination two skulls, a skin and one living specimen now in the Zoological Garden, and while I am not able to give measurements from the skull collected by me in Colorado, the features of the species are so extreme that I am able to state without hesitation its substantial agreement with those now presented.

Cranial characters.—The first impression made by these skulls is of great breadth and massive development. The Academy's skull (No. 3,308) is short and broad, offering the following measurements in millimeters:—Basal length 274; basilar length 270; extreme length 288; greatest zygomatic width 203; post palatal length 123; length of palate 147; breadth between orbits 74; across postorbital processes 105. The Ozark skull has lost a considerable portion of the facial region, but the difference in size between it and 3,308 was small; the distance from the inferior lip of the foramen magnum to the plane of the front of the fourth premolar, being in the latter 212, while in the Ozark specimen it is 216; in this one the zygomatic width is about 198; interorbital breadth 80; across postorbital process 114.

The sagittal crest is high and massive, measuring in each 130 to the point of division into the temporal ridges, which are strong, especially in 3,308. The forehead is very concave, more so than in any bear skull I have seen. In 3,308 it is also transversely concave differing from the Ozark specimen, in which the same region is transversely convex. This specimen was perhaps a female. The

nasals in both are short and rather broad. A most striking feature is the great breadth of the zygomatic arch, anteriorly, which character, more than any other, gives to the living animal its peculiar physiognomy. In 3,308 the width at the glenoid fossae is 203; at the hinder end of the palate it is but 5 mm. less and at the plane of the hinder edge of the second molar it is still 180. The broken condition of the Ozark skull prevents the corresponding measurements from being given, but enough remains to show their essential agreement. In keeping with this character is the increased width of the palate posteriorly, which measures 45 at plane of anterior edge of fourth premolar and 52 at rear end of hinder molar.

The base of skull is somewhat concave; a line from the inferior edge of foramen magnum to the proximal border of the alveolus in 3,308 falls 16 mm. below the hinder end of the palate.

The lower jaw is massive and heavy; the angular process strong and curved upward; the fossa for attachment of the masseter is extraordinarily deep and rough.

Dental characters:—The teeth in both skulls are much worn. The hinder molar in the upper jaw is relatively of great size; in the Academy's skull being .118 of the basilar length. The complete series measures: $m^3 \frac{19 \times 14}{19 \times 14}$, $m^2 \frac{32 \times 16}{22.5 \times 15}$, $m^1 \frac{19 \times 14.5}{20 \times 10}$, $pm^4 \frac{14 \times 11}{11.5 \times 6}$. In the Ozark skull the lower jaw is missing and the only teeth remaining are the upper right molars; these measure: $m^2 \frac{31 \times 17}{13 \times 9}$, $m^1 \frac{19 \times 15}{13 \times 9}$. The crowns of the teeth have been worn almost away and it is clear that the hinder molar, especially, measures less than at an earlier period. The second upper molar is broad and rounded behind, the width being carried pretty well back to the posterior end; in the Ozark specimen the outer side is somewhat sloped off behind as in *horribilis*, although it may be doubtful if this condition was marked in the unworn tooth; there are three inner and two outer cusps. The first molar is short and broad, with four cusps. The fourth premolar is rather short and narrowed in front, the shelf-like projection of the cingulum on the forward inner corner being less than in the grizzly.

The lower teeth are much worn; the fourth premolar had one cusp, from which there are remains of two longitudinal ridges to the hinder end; it is not easy to say whether the small tubercle on the inner base of the cusp was also present, but there is some indication that it was.

Color and form.—The living specimens of this bear which have been under observation were of similar color, in winter pelage a rich cinnamon brown. The two which have lived in the Zoological Garden for more than one season, became in summer of a pale bleached brown, or isabella color. The skin in the Academy's collection, belonging to skull 3,308 is almost flaxen.

The size of the four living specimens was nearly the same, about 5 ft., 6 in. from nose to tail.

The claw is short and curved as in *americanus*.

The great anterior width of the zygomatic arch and the hollow forehead are faithfully reflected on the outer surface in these bears, the sharp drop between the eyes and the laterally pinched-in muzzle giving them a peculiar and unmistakable, fox-like look.

Identity and relationship.—In studying out the correct assignment to be made of these bears, a considerable mass of material has been examined, including, through the kindness of Mr. Oldfield Thomas, the series of *arctos* and other bears in the British Museum; and also the collection of the Royal College of Surgeons, London.

The great range of individual variation in most species of *Ursus*, is well known: in my own observations amounting, in the leading proportions of the skull, to over twenty per cent. in *arctos*; sixteen per cent. in *americanus*, with a somewhat smaller range in *horribilis*.

The table following shows the main standard measurements of the skull in *cinnamomeus*, *arctos*, *horribilis* and *americanus*, arranged for convenience of comparison in the descending order of proportional breadth; the skulls selected for measurement pretty well covering the extreme range in both directions. The proportions of zygomatic breadth and length of hinder upper molar are expressed in thousandths of the basilar length:—

	Length.		Breadth		Proportion	
	Extreme	Basilar	of 2d molar	Zygomatic	of breadth	of 2d molar
<i>cinnamomeus</i>	288	270	32	203	.751	.118
“			31	198	.712 ²	.112 ²
<i>aretos</i>	345	318	30	250	.786	.094
“	368	338	36	250	.739	.106
“	330	306	30	218	.712	.098
“	383	353	38	250	.708	.107
“	330	299	34	210	.702	.113
“	354	329	35	230	.699	.106
“	295	272	33	177	.650	.121
“	344	315	35	190	.603	.111
<i>horribilis</i>	352	335	38.5	221	.659	.114
“	330	306	37	200	.653	.121
“	302	291	32	189	.649	.109
“	350	323	36	200	.619	.111
“	371	343	36	210	.612	.105
<i>americanus</i>	282	262	26	188	.717	.099
“	280	262	28	179	.683	.106
“	279	259	25.5	170	.656	.098
“	289	268	25	175	.652	.092
“	302	282	27	172	.609	.095
“	304	290	25	170	.586	.086

Taking the mean measurements of these skulls, *horribilis* presents the narrowest, with a relative average breadth of .638 and a molar of .112,—its maximum breadth falling far below that of *americanus*, from which it differs also in color, size and claw.

The great frontal concavity, breadth of skull and more than all, great size of the molar, would appear to remove *cinnamomeus* very far from *americanus*, but this comparison will be recurred to after considering the variations of *aretos*.

In both of the proportions given, *cinnamomeus* greatly exceeds the average of *aretos*, which is breadth .700; molar .107,—in each, however, it falls within the extremes of this unstable species, the greatest

² Estimated; the skull being broken.

proportional breadth in *arctos* being .786 and the longest molar .121³. This very wide *arctos* skull, however, presents the striking feature of having the smallest molar of any examined by me .094—and, in fact, these measurements show that in this species an inverse proportion pretty constantly exists between these characters; the widest skulls have small molars, while the narrower ones have them of large size and grade by a regular series into the proportions of *horribilis*. Thus, in the eight *arctos* skulls given above, the four widest give an average length of .101½ to the molar, while the four narrowest give .112¾ for the corresponding ratio. In contradistinction to this inverse relation, the exact opposite exists in *cinnamomeus*,—great breadth being here conjoined with great size of molar.

In some old skulls of *arctos* a considerable hollowness of the forehead is found, but in no case equal to that of 3,308 and the Ozark skull. These features of great breadth, frontal concavity and great massiveness are, of course, among those which increase with age, but it is a significant fact that we find them associated here in skulls of very moderate size. The individuals of *cinnamomeus* which have come under my notice were very old, three being males and the fourth perhaps female; they are so nearly equal in size that they may be justly assumed to represent a fair extreme of growth for the species. In 3,308 the skull is 288 mm. in greatest length, while to find anything like an approximation to the same characters in *arctos* or even to get correspondingly old skulls, it is necessary to go to those from 50 to 80 mm. greater in length.

Comparing the above proportions, *cinnamomeus*, while greatly exceeding in both, the average of *arctos*, is yet surpassed in breadth by one example and in length of molar by one;—*arctos* has two specimens narrower than the broadest *horribilis*, one of them being the narrowest of either species and six have larger molars than the shortest of the American form. The difference in average breadth between *arctos* and *americanus* is comparatively small and they overlap greatly, while the largest molar of the latter species is equal to, or larger than four of *arctos*.

It is impossible to avoid the conclusion that these proportions are too irregular to be of importance except in groups of averages, and

³This skull is not fully adult and is the shortest examined. With maturity the proportions of this tooth would somewhat decrease.

their lack of value as specific characters may be readily estimated from the following table, in which they are presented for each form, in parallel descending series, showing at a glance the extent to which each overlaps the others:—

Proportion of breadth				Proportion of 2d molar			
cinn.	arctos	horr.	amer.	cinn.	arctos	horr.	amer.
.751	.786			.118	.121 ⁵	.121	
	.739					.114	
			.717		.113		
.712 ⁴	.712			.112 ⁴	.111	.111	
	.708					.109	
	.702				.107		
	.699		.683		.106		.106
		.659			.106	.105	
			.656				.099
		.653	.653		.098		.098
	.650						.095
		.649			.094		
		.619					.092
		.612					.086
	.603		.609				
			.586				

Nor is there more constancy in the details of tooth structure. On the whole, *arctos* presents an upper hinder molar perhaps straighter on the outer line and wider at its hinder extremity than is usual in most of *horribilis*, but the variations are great in both. Two adult skulls of *horribilis*, collected by me in Colorado, within fifty miles of each other, exhibit almost the extreme of each form.

The fourth upper premolar is apt to be longer in *arctos* and in *horribilis* there is more of a shelf-like projection of the cingulum at its front inner corner, but hardly any two are alike and in each, ex-

⁴ Estimated ⁵ Young.

amples are to be found approximating to the narrow front usual in *americanus*. In *arctos* and *horribilis* the fourth lower premolar has but one cusp, on the posterior, inner base of which a small projection or accessory cusp is usually found in the latter, with two longitudinal ridges running back to end of the tooth. According to Busk⁶ the tubercle and its ridge are commonly wanting in *arctos* and when present are very small. In two specimens in the British Museum, both tubercle and ridge are absent, in all the others it is present, though variable and small—but in one specimen of *Ursus arctos isabellinus* from Cashmir, it is quite as well developed as in ordinary cases of *horribilis*. Dr. C. Hart Merriam⁷ appears to have found this tubercle in two skulls of *americanus* from Prairie Mer Rouge, Louisiana, in the National Museum. In the skull of *cinnamomeus* (3,308) the ridge is unquestionably present and in all probability the tubercle as well.

A tricuspid crown on this tooth appears to be diagnostic of *americanus* when it is present, but a large majority of this species examined by me, show but one cusp.

A critical survey of the whole field of cranial and dental characters among the species here treated, reveals little that is constant but variation, and absolutely forces the conviction that among them there is not one, sufficiently stable and uniform to be of specific value. The European bear and the American grizzly run into each other so regularly that except in extreme cases there is little possibility of distinguishing them certainly, or in many cases doubtfully, apart from geographical considerations, and this even is not a safe guide, one skull in the British Museum, marked "Barren Ground Bear," 321 mm. in extreme length, 229 zygomatic breadth and 32 length of molar, being in all respects an ordinary skull of *arctos*, which might just as well have been collected in Scandinavia or Kamtchatka. Mr. J. A. Allen⁸ does, in fact, regard this bear as indistinguishable from *arctos*⁹. There is less difficulty in separating *americanus* from *arctos*, but even here it has been shown how much their proportions overlap and one specimen from Transylvania,

⁶Trans. Zool. Society of London, Vol. X, pp. 60-69.

⁷Proc. Biol. Soc. of Washington, Vol. VIII, p. 150.

⁸Bull. U. S. Geo. & Geo. Survey, Vol. II, p. 336.

⁹Since the above was written Dr. Merriam has kindly shown me several skulls from the barren grounds which have distinct characters of their own.

in the British Museum, 295 mm. long, presents the flat frontal outline and the relative width of the American black species, coupled with the extreme dentition of *arctos*.

Skulls of *americanus* reach nowhere the extreme proportions of *cinnamomeus*, nor in ordinary specimens is there much suggestion of its outlines. Two remarkable skulls, however, in the collection of the Academy (Nos. 2,756 and 2,757) from Sonoma Co., California, marked "brown bear" reach an extreme of breadth and length of tooth, in this species, with a frontal depression almost equal to that of *cinnamomeus*, although in the Sonoma specimens the plane of the forehead is continuous nearly to the end of the nasals and is but slightly concave. These two skulls are the most extreme of *americanus* which I have ever seen, but while I would have been glad to examine more specimens of these brown bears than have been within reach, I am yet prepared to hazard the belief that fully matured specimens will show, as compared with black ones, a sometimes slight but fairly constant excess both in breadth and size of molar.

There can be here no question of specific difference, both colors being found in the same litter of cubs and the fact can be explained only by regarding it as an evidence of reversionary tendency to a brown-colored, large-toothed ancestor,—such as *arctos*; the physiological correlation between hair and teeth being well known. If, as I believe, the foregoing suggestion should be found to hold good in a large series, there is certainly a tendency in brown specimens of *americanus* toward the characteristics of *cinnamomeus*, and here also, perhaps, room may be found for the special features of the Louisiana skulls in the National Museum which Dr. Merriam¹⁰ recently ascribed to *Ursus luteolus* Griffith.

From these observations the conclusion is drawn that if *horribilis* and *americanus* are to stand as good species, as distinct from *arctos* as they undoubtedly are from each other, *cinnamomeus* must be considered as even a better one. But whatever the differences may be among the American forms, taken by themselves, a comparison with a large series of *arctos*, brings to light such a degree of instability and intergradation, that the only philosophical view which can be taken of their relationship is that expressed some years ago by Mr. J. A. Allen¹¹ but subsequently abandoned by him,¹² at least so far as

¹⁰ l. c. pp. 147-152.

¹¹ Bull. Mus. Comp. Zool., II, pp. 334-342.

¹² Bull. U. S. G. & G. Survey, II, No. 4, p. 340.

americanus is concerned, viz.: that leaving out *maritimus*, none of our North American bears can be accorded higher rank than that of subspecies of *arctos*. Indeed were it not for the combination of certain skull and tooth averages, with some tolerably constant differences in color and the increased size of the claw in American specimens, it is doubtful if even this distinction could be maintained between *arctos* and *horribilis*; both the large, broad-headed grizzlies of California and the smaller, northern examples, pretty well closing up the gap.

In extreme cases *americanus* has become more differentiated and is constantly smaller, but even here we have seen that the assumed specific characters intergrade; it is, however, better separated from *arctos* than is *horribilis*, and through its extreme forms the path to *cinnamomeus* is perhaps indicated—as a large series of the latter may show. Among Asiatic bears, *isabellinus* and probably *syriacus* are also closely related. The general direction of these relationships appears to point to some such scheme as this:

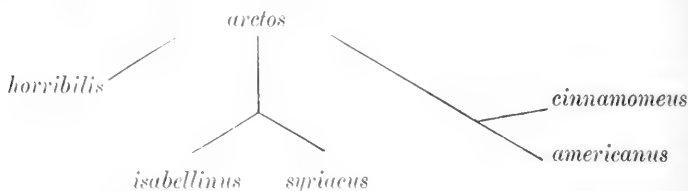

Audubon and Bachman's name appears to be correctly applicable to the bears whose cranial and dental characters are here given for the first time. They agree sufficiently well in external features and in geographical range as far as we have present knowledge, and the assignment which I here make of them, I must regard as much preferable to the alternative course of imposing upon them a new name. In the paper on *Ursus luteolus*, already referred to, Dr. Merriam denies the applicability of *cinnamomeus* to *luteolus*, and inferentially to the present species, "because *cinnamomum* was based on an animal from the northern Rocky Mountains, which has small molars, like the common black bear of the northeastern United States." This assumption, however, has no basis but in the fact that up to the present time we have known no brown bear from the Rocky Mountain region other than the small-toothed *americanus*, which has erroneously been supposed to be the animal on which Audubon and

Bachman founded their species, and falls to the ground with the appearance of the animal brought forward in this paper, leaving their name free to be properly rehabilitated and established. Any other course would be to hold these authors responsible for our own past ignorance and would lack in justice to them.

A REVIEW OF THE OLD WORLD RALLINÆ.

BY WITMER STONE.

While engaged in identifying the Rallidæ in the collection of the Academy of Natural Sciences of Philadelphia, I was impressed with the confusion which exists in regard to the synonymy of the Old World members of the family, more especially with reference to the generic position of many of the species and the limitation of the several genera.

G. R. Gray, in his Hand List, has increased the confusion to an extraordinary degree, and it is difficult to imagine how he conceived such an arrangement as is there proposed.

Having had occasion to make a thorough investigation of the literature bearing upon the Old World Rails, I think it desirable to prepare the following list of the described species and genera which brings together in one paper all the references to published descriptions. Lack of sufficient material has prevented me from making a monographic study of the group, but where specimens were at hand I have been able to judge of the specific relations of various described forms and to arrange the synonymy accordingly.

In other cases where the validity of species was in doubt I have had to depend upon the statements of those authors who have had actual specimens for comparison.

This paper was nearly completed before I had an opportunity of examining Dr. Sharpe's scheme of classification of the *Rallidæ* (*Ibis*, 1893, p. 258). This is a mere list of genera arranged according to the author's views with diagnoses of a number of new genera.

While it is impossible without better material for me to criticise Dr. Sharpe's general arrangement it certainly seems that some closely allied forms have been unduly separated. For instance, while the old genus *Rougetius* is easily separable into two groups of probable generic rank it does not seem to me that the differences warrant the interposition of the entire series of Crakes between them.

It moreover seems hardly advisable to make so many genera out of the old genus *Porzana* as is done in this scheme.

Two of the generic names adopted by Dr. Sharpe (*Corethrura* and *Rallina*) are clearly untenable as is shown below.

Although the Rails of the New World have been excellently monographed by Messrs. Sclater and Salvin, P. Z. S. 1868, p. 442, no recent attempt has been made at a systematic arrangement of the Old World members of the family except in the paper by Dr. Sharpe just referred to.

The satisfactory arrangement in a lineal sequence of the genera of any family, especially such a one as the *Rallide*, is well nigh impossible, and there must necessarily be breaks in the series.

From the typical Rails (*Rallus* and *Hypotaenidia*) we can run in one direction through *Eulabeornis* and the *Gymnocrex* group to the Woodhens (*Ocydromus*) and again through *Dryolimnas*, *Rougetius* and *Euryzona* towards the Crakes. In any case the genera *Ocydromus* and *Himantornis* are extreme forms and had better stand separately at the end of the series than be interpolated in the middle.

Cabalus is evidently allied to *Hypotaenidia* and *Cunirallus* to *Euryzona* though they are both aberrant forms.

With these ideas in mind I have begun my list with the genera most nearly approaching the Woodhens and followed with the true Rails passing from them to the Crakes. As Dr. Sharpe says the Crakes merge on the one hand into the Rails and on the other into the Gallinules, *Amaurornis* being the connecting link with the latter.

Of the Crakes I have recognized eight genera as follows: *Crex*, *Porzana*, *Limnobaenus*, *Limnocorax*, *Sarothrura*, *Rallacula*, *Porzana* and *Pennula*.

The Gallinules and Coots have not been included as I have limited my paper to what are generally known as the *Rallina* though it is an exceedingly difficult matter to draw a sharp line between the several so-called subfamilies of the *Rallide*. The genera *Amaurornis* and *Oenolimnas*¹ have also been omitted as they seem to belong with the Gallinules, and also the genera *Ocydromus*² and *Himantor-*

¹Dr. Sharpe arranges this genus (type *Rallina isabellina* Schl.) with the Crakes but it seems to me closely allied to *Amaurornis*.

²Monographed in Buller's Birds of N. Zealand. See also Ibis, 1893, p. 261.

nis which are, as has already been stated, hardly to be included with the *Ralline*.³

Besides the *Ralline* in the collection of the Academy of Natural Sciences of Philadelphia, I had the opportunity of studying the series of Old World Rails in the collection of the U. S. National Museum which were kindly loaned to me by Mr. Robert Ridgway, Curator of the Department of Birds.

The generic names which have been proposed for the Old World Rails with the type species of each are as follows:

- 1758.—*Rallus* Linn., S. N. ed. 10, I, p. 153. *R. aquaticus* Linn.
 1802.—*Crex* Bechst., Orn. Taschenb. Deutschl., p. 336. *R. crex* Linn.
 1816.—*Ortygometra* Leach, Syst. Cat. M. & B. Brit. Mus., p. 34.
R. crex Linn.
 1816.—*Porzana* Vieill., Analyse, p. 61. *R. porzana* Linn.
 1816.—*Zapornia* Leach, Syst. Cat. M. & B. Brit. Mus., p. 34.
Z. minuta Leach.
 1829.—*Phalaridion* Kaup., Entw. Eur. Thierw., p. 173. *Gallinula*
pusilla & *pygmaea*.
 1837.—*Alethelia* Swains., (nec Less., 1826).
 1844.—*Eulabeornis* Gould, P. Z. S., 1844, p. 56. *E. castaneo-*
ventris Gould.
 1845.—*Rallites* Puch., Rev. Zool., 1845, p. 277. *R. pusillus*.
 1845.—*Biensis* Puch., Rev. Zool., 1845, p. 278, *B. typus* Puch.
 1846.—*Corethrura* Gray, Gen. Bds., Vol. III (nec Hope 1844).
 1848.—*Rallina* Reich., Syn. Av., Vol. III, Rasores. *R. maximus*
 Vieill.
 1852.—*Hypotaenidia* Reich., Syst. Av., p. xxiii. *R. pectoralis* Cuv.
 1854.—*Limnocorax* Peters, Monatsber. K. P. Ak. Wissensch. Berlin,
 p. 134. *L. capensis* Peters.
 1856.—*Lewinia* Bonap., Compt. Rend., XLIII, p. 599. *R. brachi-*
pus Sw.
 1856.—*Rougetius* Bonap., Compt. Rend., XLIII, p. 599. *R. abys-*
siniensis Rupp.
 1856.—*Euryzona* Bonap., Compt. Rend., XLIII, p. 599. *R.*
fasciata Raffl.
 1856.—*Coturnicops* Bonap., Compt. Rend., XLIII, p. 599. *Fulica*
noveboracensis Gm.
 1856.—*Cairallus* Bonap., Compt. Rend., XLIII, p. 600. *Core-*
thrura griseofrons Gray.

³ Of the following genera (most of which contain but a single species) I have no specimens for examination and have followed the statements of other authors as to their affinities: *Aramidopsis*, *Habroptila*, *Megacrex*, *Gymnocrex*, *Tricholimnas*, *Cabalus*, *Castanolimnas*, *Pennula*, *Porzanula*, *Rallacula* and *Aphanolimnas*.

- 1860.—*Habroptila* Gray, P. Z. S., 1860, p. 365. *H. willarii* Gray.
 1871.—*Rallieula* Schl., Ned. Tijdsch. Dierkunde, IV, p. 55. *R. rubra* Schl.
 1872.—*Limnobaenus* Sund., Meth. Nat. Av., p. 130. *Gallinula rubiginosa* Temm.
 1874.—*Cabalus* Hutton, Trans. N. Z. Inst., VI, p. 108. *R. modestus* Hutton.
 1875.—*Gymnocrex* Salvad., Ann. Mus. Genov., VII, p. 678. *Rallina rosenbergii* Schl.
 1875.—*Corethruopsis* Salvad., Ann. Mus. Genov., VII, p. 975. *C. leucospila* Salvad.
 1876.—*Schizoptila* Brüggm., Abhl. Nat. Ver. Bremen, 5 Bd. p. 94, *Rallina rosenbergii* Schl.
 1879.—*Megacrex* D'Alb. & Salvad., Ann. Mus. Genov., XIV, p. 130. *M. inepta* D'Alb. & Salvad.
 1879.—*Pennula* Dole, Haw. Annual, 1879, p. 54. *P. millei* Dole.
 1884.—*Psammocrex* Oustalet, La Nature, 1884, p. 508. *P. petiti*, Oustalet.
 1890.—*Savothrura* Heine, Nomencl. Mus. Heine, p. 319.
 1892.—*Kittlizia* Hartl., (nec Hartert 1891) Abhl. Nat. Ver. Bremen, XII, heft 3, p. 391. *R. monasa* Kittl.
 1892.—*Aphanolimnas* Sharpe, Bull. B. O. C., No. 4, p. xx. *R. monasa* Kittl.
 1892.—*Porzana* Frohawk, Ann. N. H., 6 (ix), p. 247. *P. palmeri* Froh.
 1893.—*Aramidopsis* Sharpe, Ibis, 1893, p. 568. *R. plateni* Blasius.
 1893.—*Tricholimnas* Sharpe, Ibis, 1893, p. 260. *Gallirullus lafresnayanus* Verr.
 1893.—*Dryolimnas* Sharpe, Ibis, 1893, p. 260. *R. cuvieri* Pucher.
 1893.—*Castanolimnas* Sharpe, Ibis, 1893, p. 260. *R. canningi* Blyth.
 1893.—*Crecopsis* Sharpe, Ibis, 1893, p. 260. *P. egregia* Peters.⁴

The relegation of some of these names which have been in more or less common use, to synonymy requires some little explanation.

Ortygometra Leach, is simply a synonym of *Crex* though it has been used wrongly for species belonging elsewhere.

Zapornia, *Coturnicops*, *Phalaridion* and *Rallites*, are all synonyms of *Porzana*, the first two being well marked sub-genera.

⁴The above list does not include a number of generic names proposed by Heine in 1890 (Nomencl. Mus. Hein.) for well known genera of Bonaparte and other authors which had been in use for many years. These names would, of course, only find a place in the synonymy and it seems scarcely worth while to take any notice of them, such a wholesale introduction of new names being a most unwarrantable proceeding. One of Heine's names, however, *Savothrura*, will have to stand as the name *Corethrura*, for which it was proposed as a substitute, is preoccupied.

Alcthelis and *Corethrura* were both proposed for the small Rails here called *Sarothrura*, but both names were already in use in other connections.

Biensis and *Lewinia* are synonyms of *Rallus*.

Rallina has been employed by various authors for a variety of species. Reichenbach first proposed the name in his *Synopsis Avium*, Vol. III, Rasores, Fam. Rallinæ, including under it a large number of species, and it has been generally used since for the Rails allied to *R. euryzona*. It seems, however, that no type was cited for the genus until the appearance of Reichenbach's *Systema* in which he restricts the name to the South American species allied to *R. maximus*, this species being the type. Unfortunately this species had already been made the type of the genus *Aramides*, so that *Rallina* becomes a synonym of this latter genus and we must adopt the name *Euryzona* Bonap. for the Rails allied to *R. euryzona* as already proposed by Dr. Stejneger (*Proc. U. S. Nat. Mus.*, 1887, p. 396).

Schizoptila is a pure synonym of *Gymnocrex* while *Kittlizia* is pre-occupied and the name *Aphanolimnas* was proposed in its stead by Dr. Sharpe.

ARAMIDOPSIS Sharpe.

1893.—*Aramidopsis* Sharpe, *Ibis*, p. 568 (*Bull. B. O. C.*).

Aramidopsis plateni (Blasius).

Rallus plateni Blasius, *Braunschweiger Anzeiger*, Mar. 3, 1886.

Hab. Celebes.

HABROPTILA Gray.

1860.—*Habroptila* Gray, *P. Z. S.*, p. 365.

Habroptila wallacii Gray.

Habroptila wallacii Gray, *P. Z. S.*, 1860, p. 365.

Hab. East Gilolo.

MEGACREX D'Alb. & Salvad.

1879.—*Megacrex* D'Alb. & Salvad., *Ann. Mus. Civ. Genov.*, XIV, p. 130 (type *M. inepta* D'Alb. & Salvad.).

Megacrex inepta D'Alb. & Salv.

Megacrex inepta D'Alb. & Salvad., *Ann. Mus. Civ. Genov.*, XIV, (1879) p. 130.

Hab. New Guinea.

GYMNOCREX Salvad.

1875.—*Gymnocrex*, Salvad., *Ann. Mus. Civ. Genov.*, VII, p. 678 (type *Rallina rosenbergii* Schl.).

1876.—*Schizoptila* Brügg., Abhl. Nat. Ver. Bremen, 5 Bd., p. 94 (type *Rallina rosenbergii* Schl.).

Gymnocrex rosenbergii (Schl.).

Rallina rosenbergii Schl., Ned. Tijdschr. Dierk., III, p. 212 (1866).

Gymnocrex rosenbergii Salvad., Ann. Mus. Civ. Genov., VII, p. 678 (1875).

Schizoptila rosenbergii Brüggeman, Abhl. Nat. Ver. Bremen, 5 Bd. p. 94 (1876).

Hab. Celebes.

Gymnocrex plumbeoventris (Gray).

Rallus plumbeoventris Gray, P. Z. S., 1861, p. 432 (Mysol).

Rallus hoeveni Rosenb., Nat. Tijdschr. Ned. Ind., 1867, p. 144.

Rallus intactus ScL., P. Z. S., 1869, p. 120 (Solomon Isl.).

Hab. Solomon Isl. &c.

TRICHOLIMNAS Sharpe.

1893.—*Tricholimnas* Sharpe, Ibis, p. 260 (type *Gallirallus lafresnayanus* Verr.).

Tricholimnas lafresnayanus (Verr. & Desm.).

Gallirallus lafresnayanus Verr. & Desm., Rev. Zool., 1860, p. 437.

Hab. New Caledonia.

EULABEORNIS Gould.

1844.—*Eulabeornis* Gould, P. Z. S., 1844, p. 56 (type *E. castaneoventris* Gould).

This genus of which the type is before me seems to contain but a single species. The *Gallirallus lafresnayanus* Verr. & Desm., which has been referred by some authors to *Eulabeornis* and by others to *Ocydromus*, has been placed in a distinct genus by Dr. Sharpe.

Eulabeornis castaneoventris Gould.

Eulabeornis castaneoventris Gould, P. Z. S., 1844, p. 56.

Hab. Cape York Peninsula, Australia.

RALLUS Linn.

1758.—*Rallus* Linn., Syst. Nat. I, p. 153 (type *R. aquaticus* L.).

1845.—*Biensis* Pucher., Rev. Zool., 1845, p. 278 (type *B. typus* Puch.).

1856.—*Lewinia* Bonap., Compt. Rend., 1856, p. 599 (type *R. lewinia* Sw.).

The two species which have been separated from true *Rallus*

under the generic names *Biensis* and *Lewinia* do not seem to me sufficiently distinct to warrant their separation. *Rallus brachipus* (type of *Lewinia*) is the connecting link to *Hypotaenidia* as regards plumage, being very near to the *H. striata* group.

Rallus aquaticus Linn.

Rallus aquaticus Linn., S. N. ed. 10, I (1758), p. 153.

Hab. Europe.

Rallus indicus Blyth.

Rallus indicus Blyth, Jour. Asiatic Soc. Bengal, XVIII, p. 820 (1849).

? *Rallus japonicus* Dresser, Bds. of Europe, VII (1878), p. 261.

Hab. Bengal, Nepal, Japan, etc.

This species is the eastern representative of the former.

Rallus coerulescens Gm.

Rallus coerulescens Gm., S. N. I, p. 716, 1788.

Hab. S. Africa.

Rallus madagascariensis Desj.

Rallus madagascariensis Desj., P. Z. S., 1831, p. 45.

Biensis typus Pucheran, Rev. Zool., 1845, p. 278.

Hab. Madagascar.

Rallus brachipus Sw.

Rallus brachipus Sw., Anim. in Menag., (1838) p. 336.

Rallus Lewinii Sw., Anim. in Menag., p. 336.

"*Rallus pectoralis* Cuv.," fide Pucheran, Rev. Zool., 1845, p. 278.

Hab. Australia.

Rallus muelleri Rothsch.

Rallus muelleri Rothsch., Ibis., 1893, p. 442.

Hab. Auckland Isl., New Zealand.

A close ally of the preceding.

HYPOTAENIDIA Reichb.

1850.—*Hypotaenidia* Reichb., Syst. Avium. p. XXIII (type "*R. pectoralis* Gould" = *R. philippensis* L.).

Reichenbach gives as the type of his genus "*Rallus pectoralis* Cuv." which Pucheran states is *Rallus brachipus* Sw.; the bird figured on the plate to which we are referred, however, is the "*Rallus pectoralis* Gould" which is *R. philippensis* Linn.

This genus comprises three groups of species:

- a. Those allied to *H. striatus* which have the bars on the wing feathers all white and which make an easy transition to *Rallus* through *R. brachipus*.
- b. Those allied to *R. philippensis* which have the bars on the wing feathers reddish brown, except the two outermost primaries.
- c. Those allied to *H. celebensis*, with the upper surface not striped and the throat black.

Hypotaenidia striata (Linn.).

Rallus striata Linn., S. N. ed. 12 (1766) I, p. 262.

Hab. Philippine Islands.

Hypotaenidia gularis (Horsf.).

Rallus gularis Horsf., Tr. Linn. Soc., XIII, 1822, p. 196.

Hab. Java.

Hypotaenidia superciliaris (Eyton).

Rallus superciliaris Eyton, Ann. & Mag. N. H., XVI, 1845, p. 230.

Rallina telmatophila Hume, Stray Feathers, VII, p. 142.

Hab. Malacca.

This will probably prove synonymous with the preceding.

Hypotaenidia jouyi (Stejn.).

Rallus jouyi Stejn., Proc. U. S. N. M., Vol. 9, 1886, p. 263.

Hab. China (probably India, also).

Hypotaenidia obscuriora Hume.

Hypotaenidia obscuriora Hume, Stray Feathers, II, p. 302 (Jan. 1874).

Hypotaenidia ferrea Walden, Ibis, 1874, p. 147 (April 1874).

Hab. Andaman Isl.

Hypotaenidia abnormis Hume.

Hypotaenidia abnormis Hume, Stray Feathers, 1875, p. 389.

Hab. Southern Andamans.

Hypotaenidia philippensis (Linn.).

Rallus philippensis Linn, S. N. ed. 12, I, p. 263.

Rallus pectoralis Gould, Birds of Austral., Vol. VI, Pl. 76 (nec Cuvier).

Rallus etorques Temm., fide Schlegel Mus. Pays Bas, V., p. 23.

Rallus hypotaenidia "Bonap.," fide Verr. & DesMur., Rev. & Mag. Zool., 1860, p. 537.

Rallus fosteri Hartl., Wieg. Arch. f. Naturg., 1852, p. 136.

Rallus hypoleucus Finsch & Hartl., Orn. Centralpol., p. 163.

Rallus pictus Potts, Trans. N. Z. Inst., IV, p. 202 (1871).

Rallus biensis von Pelz., Ibis, 1873, p. 42.

Rallus assimilis Gray, App. Dieff. Travels, Vol. II, p. 197.

Hab. Java to Australia and New Zealand.

While it may be possible to separate this species into several races, my material is insufficient to decide the question. As far as I can see, however, such separation does not seem practicable. The presence or absence of a buff breast band is not a constant character, birds from the same locality showing great diversity in this respect. The New Zealand bird has been separated by both Gray and Potts but from such specimens as I have seen I fail to find any constant differential characters.

Hypotaenidia torquata (Linn.).

Rallus torquatus Linn., S. N. ed. 12, I, p. 262.

“*Rallus lineatus* “Cuv.” Less. Tr. Ornith., 1831, p. 536.

Hab. Philippines.

Hypotaenidia celebensis (Q. & G.).

Rallus celebensis Q. & G., l’Astrol., t. 24, p. 2.

Hab. Celebes.

Hypotaenidia sulcirostris (Wall.).

Rallus sulcirostris Wall., P. Z. S., 1862, p. 345.

Hab. Sula Isl.

See an important paper on this and allied species, Selater, Ibis, 1880, p. 312.

Hypotaenidia saturata Salvad.

Hypotaenidia saturata Salvad., Mss., Selater, Ibis, 1880, p. 310

Hab. Salawatti and Papua.

Hypotaenidia insignis (Scl.).

Rallus insignis Scl., P. Z. S., 1880, p. 66.

Hab. New Britain, Duke of York Isl.

Hypotaenidia poeciloptera (Hartl.).

Rallina poeciloptera Hartl., Ibis, 1866, p. 171.

Hab. Fiji Isl.

Hypotaenidia woodfordi (Grant).

Rallina woodfordi Ogilvie Grant, Ann. & Mag. N. H., (6) IV. 1889, p. 320.

Hab. Solomon Isl.

The last two species I have never seen and am not sure whether they should be referred to this genus or not. *Rallus featherstonii* is described by Buller, Essay on Ornithology of New Zealand, published

in Report of N. Z. Expos. 1865, but is entirely ignored by him in his subsequent work on Birds of New Zealand. I have not access to the first work, but judge the name to be a synonym perhaps of *Hypotaenidia philippensis* L.

H. sulcirostris and the two following species I arrange here in accordance with Dr. Selater's views as they are evidently members of this group, though I have no specimens for examination.

CABALUS Hutton.

Cabalus Hutton, Trans. N. Z. Inst., VI, p. 108 (type *R. modestus* Hutton).

Cabalus dieffenbachi (Gray).

Rallus dieffenbachi Gray, App. Dieff. Travels, Vol. II, p. 197.

Rallus modestus Hutton, Ibis, 1872, p. 247.

Hab. Chatham Isl.

C. modestus may be a distinct species as has been held by a number of ornithologists; the majority of those who have examined specimens, however, seem to consider it merely the young of *C. dieffenbachi*.

Cabalus macquariensis (Hutton).

Rallus macquariensis Hutton, Ibis, 1879, p. 454.

Hab. Macquarie Isl.

Cabalus sylvestris (Selater).

Ocydromus sylvestris Sel., P. Z. S., 1869, p. 472.

Hab. Lord Howe Isl.

Dr. Sharpe states that this species is really a *Cabalus* and has been wrongly referred to *Ocydromus* (Ibis, 1893, p. 262).

ROUGETIUS Bonap.

1856.—*Rougetius* Bonap., Compt. Rend., t. 43, p. 599 (type *R. abyssinicus* Rüpp. = *R. rougetii* Guer.)

The species generally referred to this genus fall into two groups, one containing the type and the other comprising *R. bernieri* of Madagascar and its close allies from the adjacent islands. In the former the bill is much smaller and weaker, though its shape and proportions are about the same. For the latter group Dr. Sharpe has proposed the generic name *Dryolimnas* and it seems better to recognize the two genera.

Rougetius rougetii (Guer).

Rallus rougetii Guer., Rev. Zool., 1843, p. 322.

Rallus abyssinicus Rupp., Syst. Uebers., 1845, No. 478, t. 46.

Hab. Abyssinia.

DRYOLIMNAS Sharpe.

1893.—*Dryolimnas* Sharpe, Ibis, 1893, p. 260 (type *R. cuvieri* Puch.).

Dryolimnas bernieri (Bonap.).

Rougetius bernieri Bonap., Compt. Rend., XLIII, 1856, p. 599
(nomen nudum).

"*Rougetius bernieri* Bonap.," Hartl., J. f. O., 1860, p. 171.

Hab. Madagascar.

Dryolimnas cuvieri (Pucheran).

Rallus gularis Cuv.," Less. Tr. Ornith., p. 536 (nec Cuv.).

Rallus cuvieri Puch., Rev. Zool., 1845, p. 279.

Hab. Mauritius.

Dryolimnas aldebranus (Gunther).

Rallus gularis var *aldebrana* Gunther, Ann. & Mag. N. H., ser. 5,
Vol. III, 1879, p. 164.

Rougetius aldebranus Ridgw., Proc. U. S. N. M., Vol. XVI, p.
598, 1893.

Hab. Aldebra.

Dryolimnas abbotti (Ridgw.).

Rougetius abbotti Ridgw., Auk, 1894, p. 74.

Hab. Assumption Island.

CANIRALLUS Bonap.

1856.—*Canirallus* "Hartl.," Bonap., Compt. Rend., XLIII, p. 600
(type *Gallinula kilioides* Puch.).

To this genus have been referred two species which are certainly not congeneric, *i. e.*, *C. kilioides* Puch., and *C. oculus* Temm. Bonaparte gives them both in his list (Compt. Rend., 1856, p. 600) and places *oculus* Temm. first; from the fact, however, that he placed the genus in *Gallinulinae* I think he must have had the former species in view, as its bill is strikingly like that of a Gallinule. I therefore, would select *kilioides* Puch. as the type.

Although the shape of the bill of this bird recalls the Gallinules (especially *Amauroptera*) it has no trace of a frontal shield, and the toes are very short, as in *Euryzona*, so that I think its place is with the *Ralline*, though certainly an aberrant form.

Canirallus kilioides (Puch.).

Gallinula kilioides Puch., Rev. Zool., 1845, p. 279.

Corethrura griseofrons Gray, Gen. Bds., III, 1846, p. 595.

Hab. Madagascar.

EURYZONA Bonap.

- 1846.—*Rallina* Gray, Gen. Birds, III, p. 595 (type *R. zeylanicus* Gm. (nec *Rallina* Reich.).
 1856.—*Euryzona* Bonap., Compt. Rend., XLIII, p. 599 (type *R. fasciata* Raffl.)

The question of the proper name for this genus has already been thoroughly discussed. Besides the typical species allied to *E. fasciata*, there is another which seems more nearly allied to this genus than any other. This is the *Canirallus oculus* of Temminck, which is certainly not congeneric with *Canirallus kilioides* (type of genus). This species has the short toes of *Euryzona*, but has the bill somewhat longer and higher at the base. The coloration is almost exactly the same style as that of a typical *Euryzona*. Although it may be necessary to propose a new genus for this species, I would prefer for the present to place it here.

Euryzona fasciata (Raffl.).

Rallina fasciata Raffl., Trans. Linn. Soc., (1822) XIII, p. 328, (Sumatra).

Gallinula euryzona Temm., Pl. Col. 417, 1838 (Java).

Hab. India.

Euryzona euryzonoides (Lafr.).

Gallinula euryzonoides Lafr., Rev. Zool., 1845, p. 368.

Rallus zeylanicus "Gm." Auct., nec Gmelin (see Tweedale P. Z. S. 1877, p. 767).

Hab. Ceylon, Burmah, etc.

Euryzona amauroptera (Blyth).

Rallus capensis Gm., S. N., (1788) I, p. 716, pt. (nec Linn.)

Porzana ceylonicus Blyth (1849), Cat. Bds. Mus. Asiat. Soc., p. 285 (nec *R. zeylanica* Gen.)

Porzana amauroptera Blyth, fide Jerdon, Bds. India, III, p. 725 (1864).

Hab. Northern India.

The date and place of Blyth's description I am unable to find; probably it was merely a manuscript name that Jerdon quotes.

Euryzona sepiaria Stejn.

Euryzona sepiaria Stejn., Proc. U. S. Nat. Mus., 1887, p. 395.

Hab. Liu Kiu Islands.

Euryzona tricolor (Gray).

Rallus tricolor Gray, P. Z. S., 1858, p. 188.

Hab. New Guinea.

- Euryzona minahasa** (Wall.).
Rallina minahasa Wall., P. Z. S., 1862, p. 346.
 Hab. Sula and N. Celebes.
- Euryzona rufigenis** (Wall.).
Porzana rufigenis Wall., P. Z. S., 1865, p. 480.
 Hab. Borneo.
- Euryzona zonaventris** Cab.
Rallina (E.) zonaventris Cab., J. f. O., 1881, p. 425.
 Hab. Malacca.
- Euryzona oculea** (Temm.).
Gallinula oculea Temm.
Canirallus oculus Bonap., Compt. Rend., XLIII, p. 599.
Rallina oculea Schleg., Mus. Pays Bas, V, p. 20.
 Hab. W. Africa, (Liberia, &c.).

CASTANOLIMNAS Sharpe.

- 1893.—*Castanolimnas* Sharpe, Ibis, 1893, p. 260 (type *Rallina canningi* Tytler).

As I have never seen the species upon which this genus is founded I follow Dr. Sharpe in recognizing it as distinct from *Euryzona*.

- Castanolimnas canningi** (Tytler).
Rallina canningi Tytler, Ibis, 1863, p. 119.
 Hab. Andaman Isl.

CREX Bechst.

- 1802.—*Crex* Bechst., Orn. Taschb. Deutschl., p. 336 (type *R. crex* L.).
- 1816.—*Ortygometra* Leach, Syst. Cat. M. & B. Brit. Mus., p. 34 (type *R. crex* L.).
- Crex crex** (Linn.).
Rallus crex Linn., S. N. ed. 12, I (1758), p. 153.
Crex pratensis Bechst., Ornithol. Taschenb., II, p. 337 (1803).
Fulica naevia Gm., S. N. I (1788), p. 709.
 Hab. Europe and Northern Asia.

PORZANA Vieill.

- 1816.—*Porzana* Vieill., Analyse, p. 61 (type *R. porzana* Linn.).
- 1816.—*Zapornia* Leach, Syst. Cat. M. & B. Brit. Mus., p. 34 (type *Z. minuta* Leach).
- 1829.—*Phalaridion* Kaup, Entw. Eur. Thierw, p. 173 (type *Gallinula pusilla* and *pygmaea*).
- 1845.—*Rallites* Puch. Rev. Zool., 1845, p. 277 (type *R. pusillus*).
- 1856.—*Coturnicops* Bonap. Compt. Rend., XLIII, p. 599 (type *Fulica noveboracensis* Gm.).

In this genus I have placed the majority of the smaller Rails, which may be arranged in several subgenera: (1) *Porzana* with one species (*P. porzana*). (2) *Zapornia* with five distinct species (*P. novæ-hollandiæ*, *quadririgata*, *tabuensis*, *pusilla* and *palustris*) and several others which are perhaps only to be regarded as subspecies. Additional species or subspecies may have to be recognized in this group when a large amount of material is examined, but in that case some of the names here included in the synonymy will have to be revived. (3) *Crexopsis*, a group of African species, including *P. marginalis* Peters and some allied forms. (4) *Coturnicops*, including two species *P. exquisita* and *P. ayresi*. The type of this subgenus is *P. noveboracensis* Gm., an American species.

The other species of *Porzana* I have not been able to examine and am uncertain as to their arrangement. *P. akool*, *modesta* and *bicolor* seem from the descriptions to be very different birds from the other *Porzanae* and may have to be placed in a distinct genus. *P. moluccana* of Wallace may not be a *Porzana* at all, as the description is too meagre to show what its relationship really is. *P. rufigenis* described at the same time seems to be a *Euryzona*.

a. PORZANA.

Porzana porzana (Linn.).

Rallus porzana Linn., S. N. ed 12, I, p. 262; 1766.

Ortygometra maruetta Leach, Gould, Bds. of Europe.

Hab. Europe.

Porzana novæ-hollandiæ Cuv.

Porzana novæ-hollandiæ Cuv.

Porzana fluminea Gould, P. Z. S., 1842, p. 139.

Hab. Australia and Tasmania.

b. ZAPORNIA.

Porzana quadririgata (Horsf.)

Rallus quadririgata Horsf., Linn. Trans., XIII, p. 196 (Java).

Rallus tanensis Forst. Descr. Anim., 1844, p. 275 (Tanna).

Rallus leucophrys Gould, P. Z. S., 1847, p. 33 (Australia).

Gallinula leucosoma Sw., Anim. in Menag., p. 348 (India).

Zaporina sandwichensis Reich., Icon. Col., t. 204, f. 1184-85 (nec *Rallus sandwichensis* Gm.).

"*Gallinula mystacina* Mus. Paris," Inedit. fide Schlegel.

"*Gallinula superciliosa* Temm.," Inedit. fide Schlegel.

Hab. Java to Australia, etc.

Rallus cinereus Vieill. which is often quoted for this bird, applies to a South American species.

Porzana tabuensis Gm.

Rallus tabuensis Gm., S. N. I (1788), p. 717, (Tongo Taboo, Otaheite).

Zaporina umbrina Cass., Proc. A. N. S. Phila., VIII, p. 254 (Fiji).

“*Zaporina umbrata*” Hartl., Wiegmann Arch. für Naturg., 1858, II, p. 29 = misprint of Cassin’s name.

Crex plumbea Gray, Griff. Anim. King, III, p. 410, (1829) (no habitat).

Porzana tahitiensis (Gm.)

Rallus tahitiensis Gm., S. N., I (1788), p. 717.

Gallinula immaculata Sw., Anim. in Menag., 1838, p. 337 (Tasmania).

Hab. Australia and Polynesia.

Whether there is more than one species of these little unicolorated Rails of the South Pacific I am unable to say ; whether the name *tabuensis* of Gmelin will stand is also doubtful. If the two prove synonymous, *tabuensis* has priority.

Porzana spilonota (Gould).

Zaporina spilonota Gould, Voy. Beagle, pt. III, pt. 132.

Hab. Galapagos.

Porzana vitiensis Hartl.

Porzana vitiensis Hartl., J. f. O. (1854), p. 169.

Hab. Fiji Isl.

A name based upon Peale’s brief description of a Fiji Rail which he identifies as “*P. spilonota* Gould” (U. S. Expl. Exped., Wilkes, p. 224).

Porzana pusillus (Pallas).

Rallus pusillus Pallas, Reise. Russ. Reise. (1776), III, app. p. 700.

Rallus pusillus Gm., I, p. 719 (1788).

Hab. India, China and Japan.

Porzana intermedia (Hermann).

Rallus intermedius Hermann, Observ. on Zool., I, p. 198 (1804).

Crex pygmaea Naum., Voy., t. 239 (18—).

Rallus bailloni Vieill., Nov. Dict. d’Hist. Nat., XXVIII, p. 548 (1819).

Gallinula stellaris Temm., Man. d’Orn., 2 ed., II, p. 693 (1820).

Hab. Europe and Africa.

As to the separation of this species from the preceding, see Ogilvie Grant, Ann. & Mag. N. H., 1890, Vol. V, p. 80. Dr. Stejneger pro-

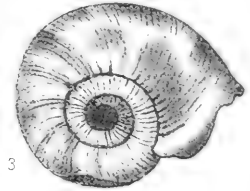
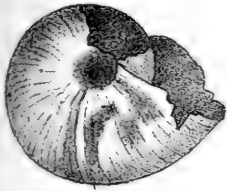

x 12

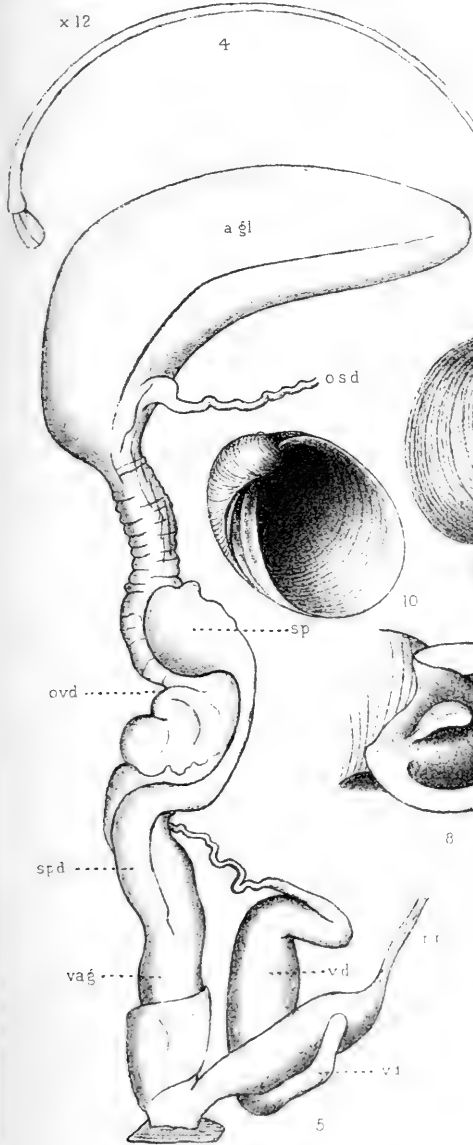

6

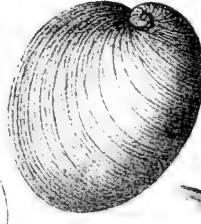

9

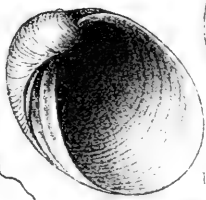

10

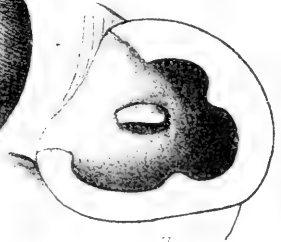

7

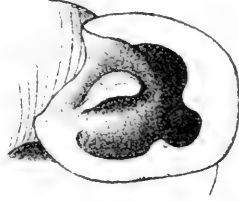

8

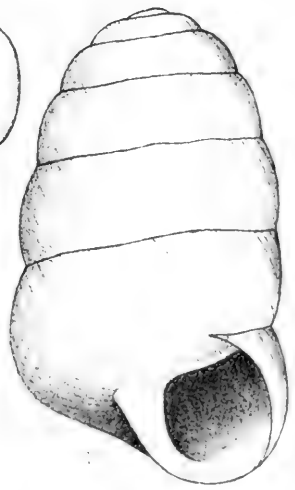

5

Pilsbry del.

Proc. Acad. Nat. Sci. Phila. 1894.



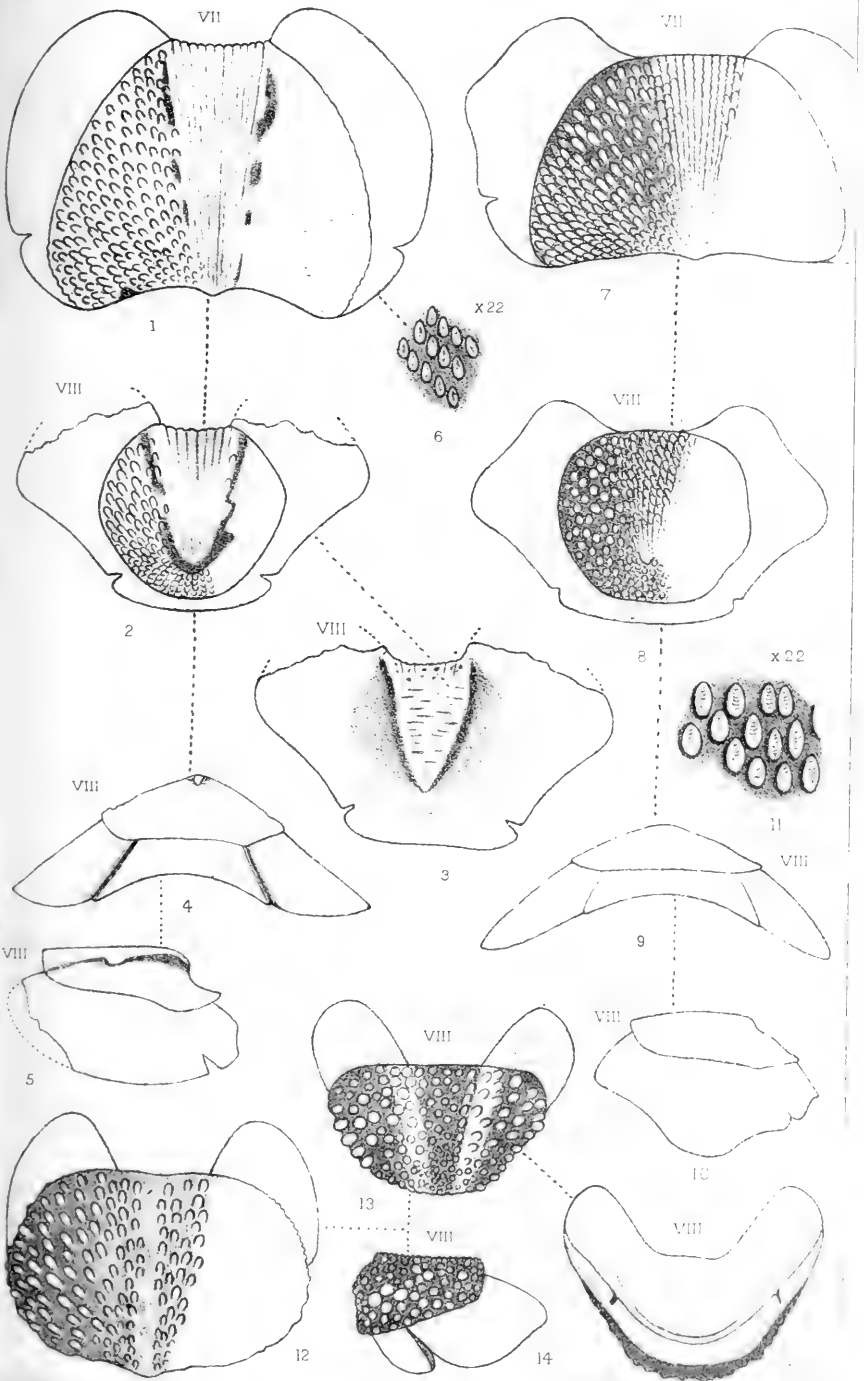

PILSBRY, AUSTRALIAN CHITONS.



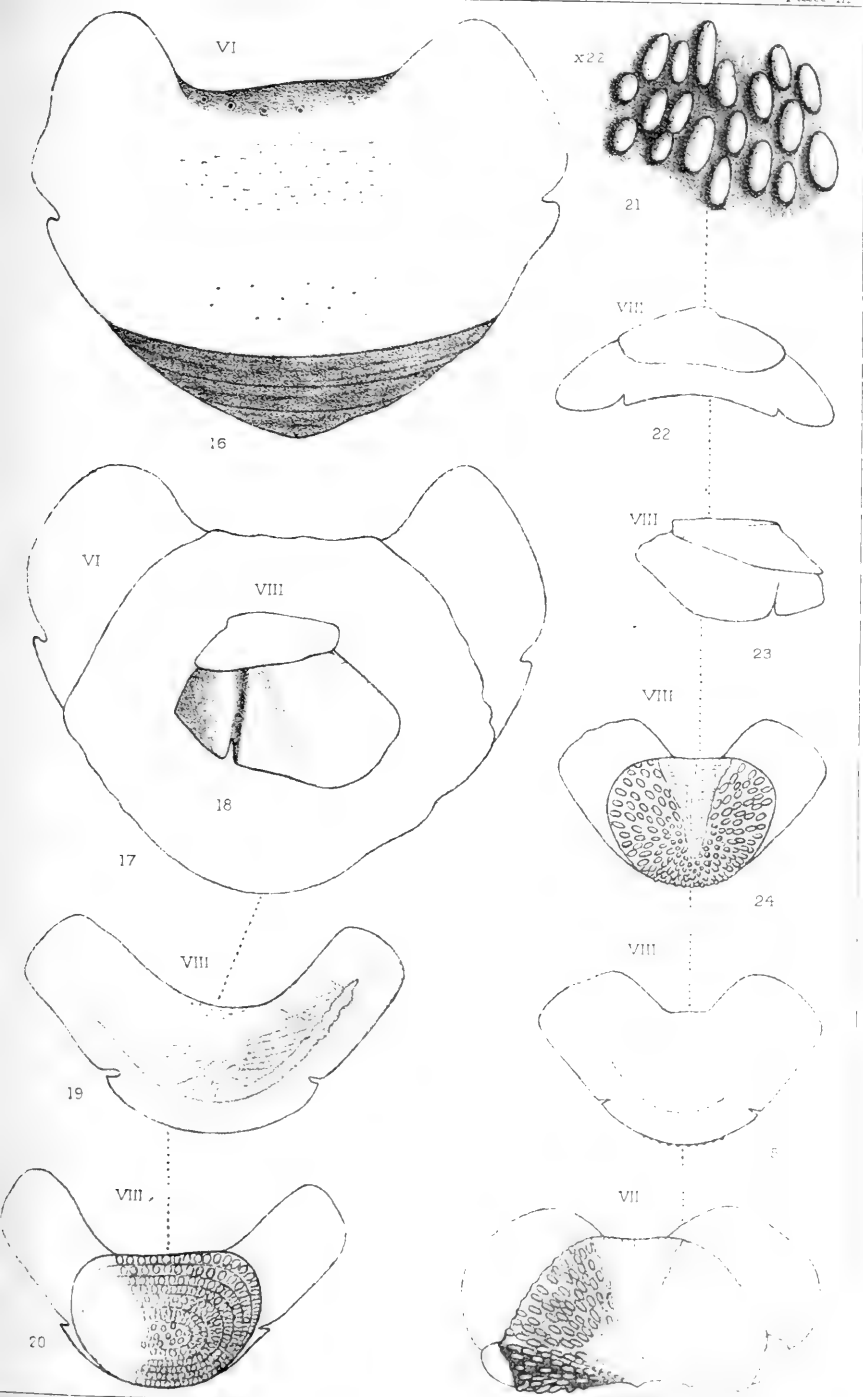

PILSBRY, AUSTRALIAN CHITONS.



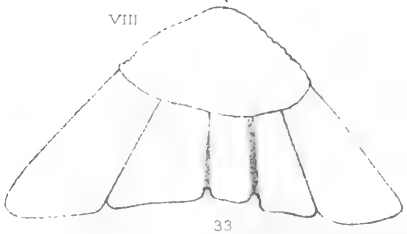
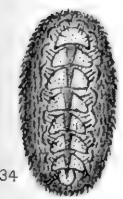
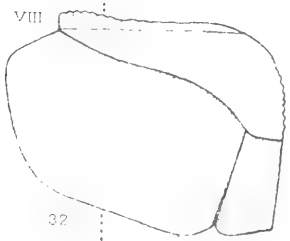
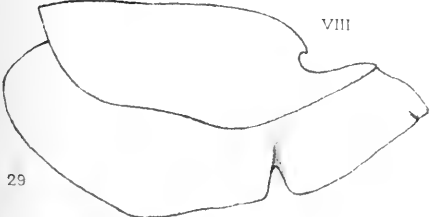
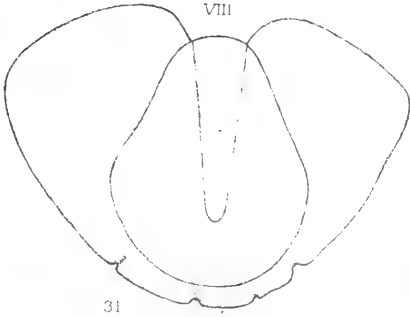
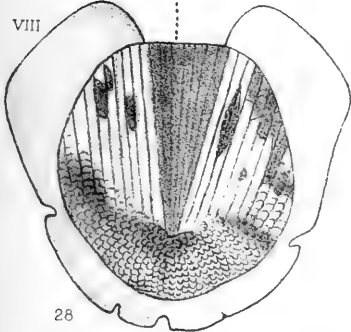
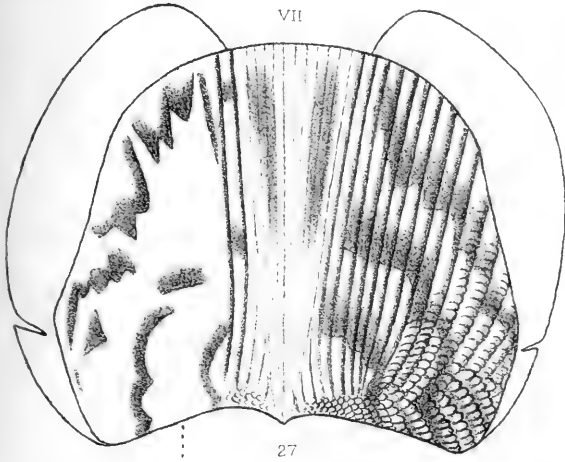

Pilsbry, del.



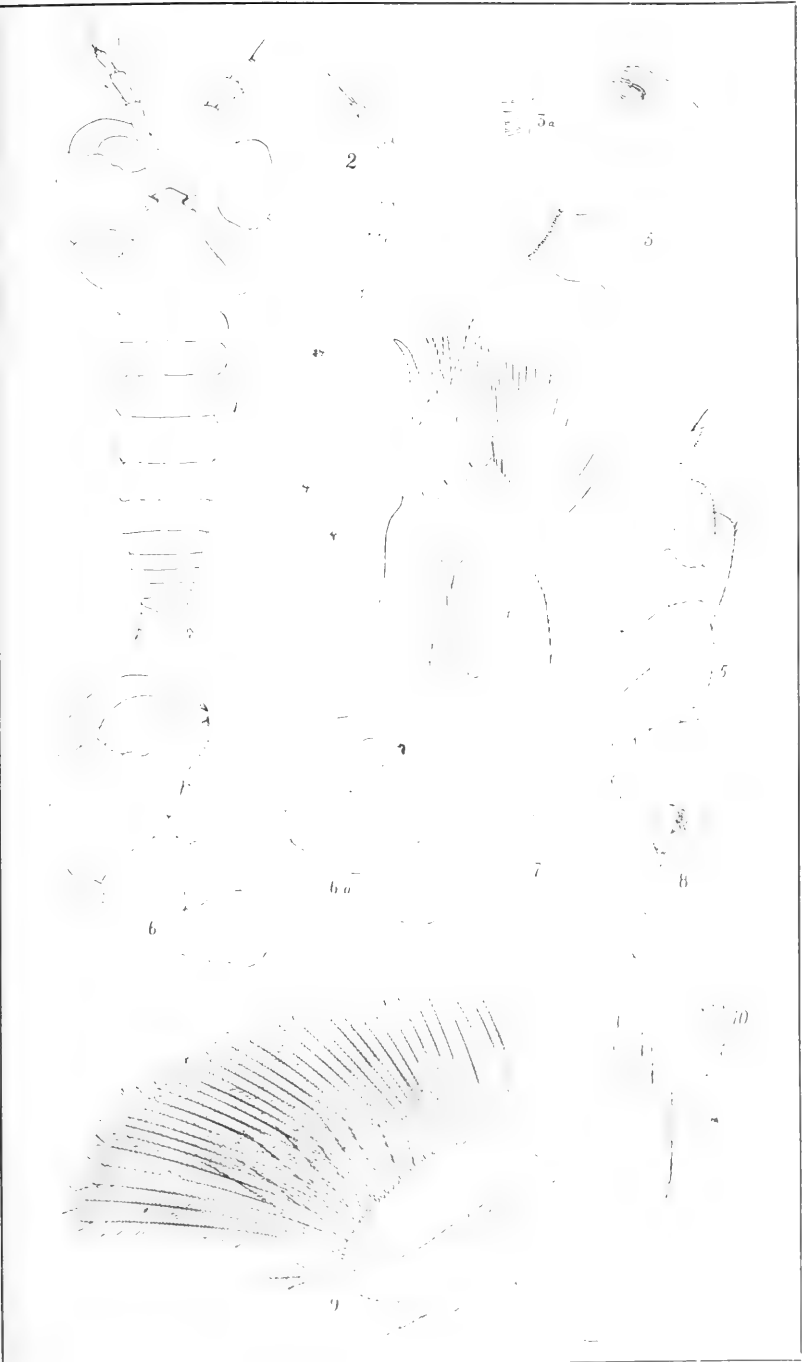

MOORE: TANAIUS ROBUSTUS.

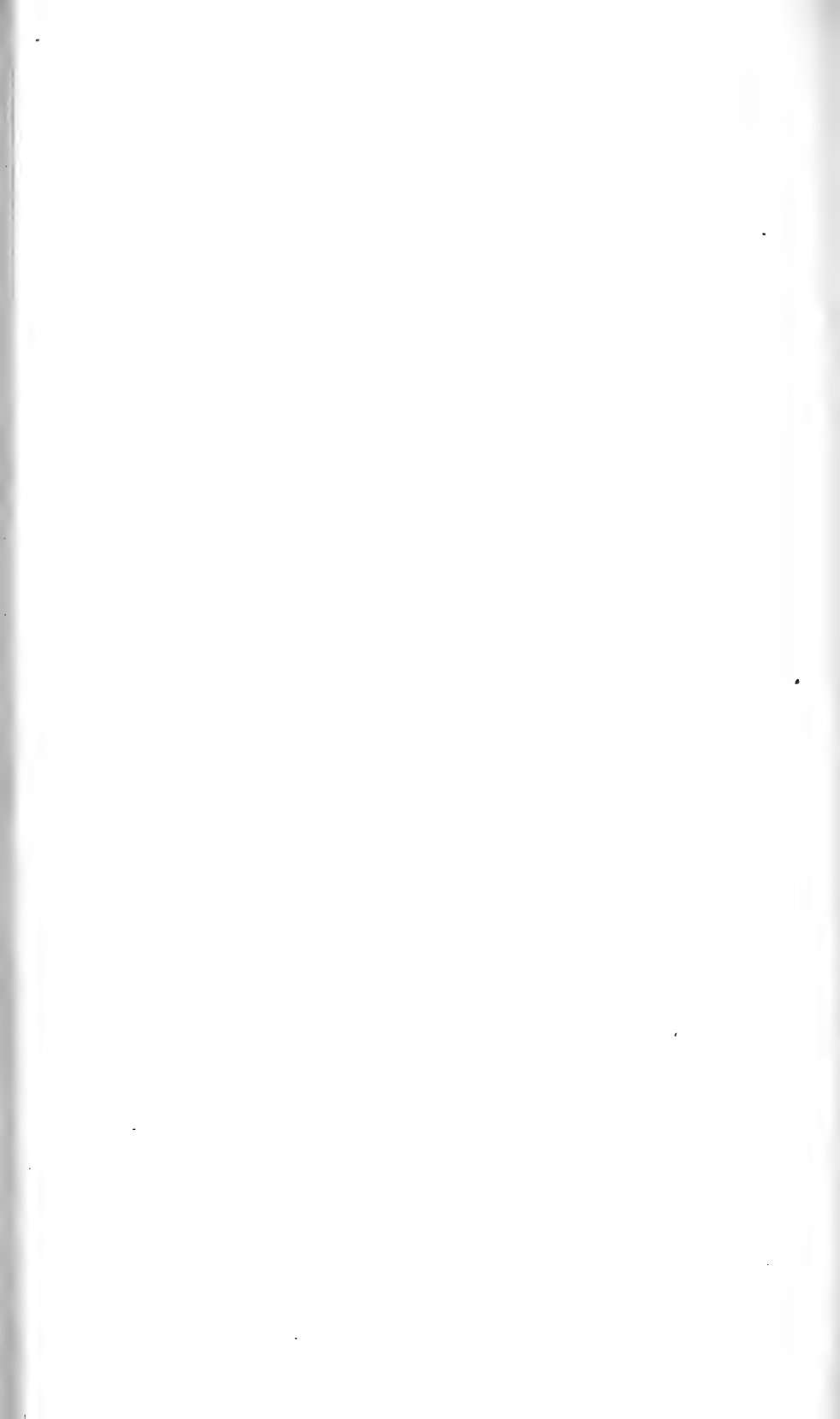

poses the adoption of the name *intermedia* for this bird (Proc. U. S. N. M., 1886, p. 397) as the status of *Crex pygmaea* seems somewhat doubtful, and this name antedates *R. bailloni* Vieill. by fifteen years.

Porzana parva (Scop.).

Rallus parvus Scop., Ann. Hist. Nat., p. 108 (1769).

Rallus minuta Pall., Zoogr. Ross. Asiat., II, p. 155, 1826 (nec *R. minuta* Gmelin 1788, which is a South American species).

Rallus Foljabamei Mont.

Rallus Peyrousi Vieill.

Hab. Europe and Western Asia.

Porzana palustris Gould.

Porzana palustris Gould, P. Z. S., 1842, p. 139.

Hab. Tasmania.

Porzana affinis Gray.

Ortygometra affinis Gray, Voy. Ereb. & Terr., p. 14 (1844).

Rallus punctatus Ellm., Zool., 1861, p. 7470.

Hab. New Zealand.

c. CRECOPSIS Sharpe.

Porzana egregia Peters.

Ortygometra egregia Peters, Monatsber. K. P. Ak. Wissensch. Berlin, 1854, p. 134.

Hab. Tette.

Porzana angolensis Hartl.

Ortygometra angolensis Hartl., Ibis, 1862, p. 340 (Angola).

Ortygometra fasciata Hough, J. f. O., 1863, p. 27 (White Nile).

This species is said to be identical with the preceding by Heuglin, Ornith. N. Afr. II, p. 1240.

Porzana marginalis Hartl.

Porzana marginalis Hartl., Syst. Orn. West Afr., p. 241.

Hab. Gaboon.

Porzana watersi Bartl.

Zaporina watersi Bartl., P. Z. S., 1879, p. 772, pl. LXI.

Hab. Madagascar.

d. COTURNICOPS.

Porzana exquisita Swinh.

Porzana exquisita Swinh., Ann. & Mag. N. H., (4) XII, p. 376, 1873.

Porzana undulata Tacz., J. f. O., 1874, p. 333.

Hab. N. China (Cheefoo).

Dr. Stejneger seems to have overlooked the description of this species in Ann. and Mag. N. H., 1873 (see Proc. U. S. N. M., 1886, p. 401) and Mr. Swinhoe himself says that he forgot that he had published it and republished the species in Ibis, 1875, p. 135, fortunately using the same name.

Porzana ayresi (Gurney).

Coturnicops ayresi Gurney, Ibis, 1877, p. 352, Pl. VII.

Hab. Transvaal Republic.

OTHER SPECIES.

Porzana akool (Sykes).

Rallus akool Sykes, P. Z. S., 1832, p. 164.

Hab. India.

Porzana modesta (Sw.)

Gallinula modesta Sw., Anim. in Menag., p. 348.

Hab. India.

Porzana bicolor Walden.

Porzana bicolor Walden, Ann. & Mag. N. H., (4) IX, p. 47 (1871).

Porzana chvesi Hume, Stray Feathers, 1875, p. 283.

Hab. Himalayas.

Porzana moluccana Wall.

Porzana moluccana Wall., P. Z. S., 1865, p. 480.

Hab. Amboyna.

LIMNOBAENUS Sund.

1872.—*Limnobaenus* Sund., Meth. Nat. Av., p. 130 (type *Gallinula rubiginosa* Temm.)

Limnobaenus fuscus (Linn.).

Rallus fuscus Linn., S. N., ed. 12, I, p. 262 (1766).

“*Rallus flammiceps* Hodgs” (?)

Hab. Philippines.

Limnobaenus erythrothorax (J. & S.)

Gallinula erythrothorax J. & S., Faun. Jap., Aves, p. 121, pl. LXXVIII.

Hab. China and Japan.

Limnobaenus paykulli (Ljungh).

Rallus paykulli Ljungh, Sv. Vet. Akad. Handl., 1813, p. 258.

Porzana mandarina Swinh., Ann. & Mag. N. H., 4 series, V, p. 173.

Hab. China, Malacca, Batavia.

Limnobaenus phaeopygus (Stejn.)*Porzana phaeopyga* Stejn., Proc. U. S. N. M., 1887, p. 394.

Hab. Japan.

Limnobaenus rubiginosus (Temm.)*Gallinula rubiginosa* Temm., Pl. Col. LV (1825), p. 357.

Hab. Java and Southern India.

PENNULA Dole.1879.—*Pennula* Dole, Hawaiian Annual, p. 54 (type *P. millei* Dole).**Pennula ecaudata** (King).*Rallus ecaudatus* King, Cook's Third Voyage, Vol. III, p. 119.*Rallus obscurus* Gm., S. N. I (1788), p. 718.*Pennula millei* Dole, Haw. Ann., 1879, p. 54.

Hab. Hawaiian Isl.

Pennula sandwichensis (Gm.).*Rallus sandwichensis* Gm., S. N. I (1788), p. 717

Hab. Hawaiian Isl.

PORZANULA Frohawk.1891.—*Porzanula* Frohawk, Ann. & Mag. N. H., p. 247 (type *P. palmeri*).**Porzanula palmeri** (Froh.).*Porzanula palmeri* (Froh.), Ann. & Mag. N. H., 1891, p. 247.

Hab. Laysan Isl.

LIMNOCORAX Peters.1854.—*Limnocolax* Peters, Monatsber. K. P. Ak. Wissensch., Berlin, p. 134 (type *L. capensis*).

Although Peters recognizes three species of this genus it does not seem possible from such material as I have examined to admit more than one. A larger series of specimens may, however, justify his conclusions.

Limnocolax niger (Gm.).*Rallus niger* Gm., S. N. I (1788), p. 717.*Gallinula flavirostris* Sw., Bds. of W. Afr., I, p.

1854, p. 188.

L. senegalensis Peters, Monatsber. K. P. Ak. Wiss. Berlin, 1854, p. 188.*L. mossambicus* Peters, Monatsber. K. P. Ak. Wiss. Berlin, 1854, p. 188.*Rallus aethiops* Forster, (fide Peters).

Hab. S. and W. Africa.

SAROTHRURA Heine.

1890.—*Sarothrura* Heine, Nomencl. Mus. Hein., p. 319.

1853.—*Corethrura* Reichb., (nec Hope, 1844).

1837.—*Alethelia* Sw., (nec Less. 1826).

As has already been stated, p. 133, foot note, the name *Sarothrura* of Heine seems to be the only one applicable to this genus.

Sarothrura dimidiata (Temm.).

Gallinula dimidiata "Temm.," Less., Traite. d'Ornith., I, p. 537 (1831).

Crex ruficollis Gray, Zool. Misc., p. 13 (1831).

Hab. S. Africa.

Sarothrura jardinii (Smith).

Crex jardinii Smith, Proc. S. Afr. Inst., Nov., 1828.

? *Alethelia lineata* Sw., Anim. in Menag., p. 338.

Hab. S. Africa.

Sarothrura pulchra (Gray).

Crex pulchra Gray, Griff. An. Kingd., III, p. 410.

Gallinula elegans Smith, Zool. S. Afr., Aves, Pl. 22.

Hab. S. Africa.

Sarothrura insularis (Sharpe).

Corethrura insularis Sharpe, P. Z. S., 1870, p. 400.

Hab. Madagascar.

Sarothrura cinnamomea (Less.).

Rallus cinnamomeus Less., Rev. Zool., 1840, p. 99.

Hab. S. Africa.

Sarothrura bonapartei Hartl.

Corethrura Bonapartei Hartl., Orn. West Afr., p. 242.

Hab. Gaboon, W. Africa.

Of the last two species I have never seen any specimens and they may prove to be synonyms. The names "*cercoleps* Tem." and "*eaudatus* Cuv." given in Gray's Hand List under this section, I have been unable to find, but as their habitat is given as Philippines they probably do not belong in the genus *Sarothrura*.

RALLICULA.

1871.—*Rallacula* Schl., Ned. Tijdsch. Dierk., IV, p. 55 (type *R. rubra* Schl.).

Rallacula rubra Schl.

Rallacula rubra Schl., Ned. Tijdsch. Dierk., IV, p. 55 (1871).

Hab. New Guinea.

Rallicula forbesi Sharpe.

Rallicula forbesi Sharpe, Birds of New Guinea, Pl. XXIII.

Hab. New Guinea.

Rallicula leucospila (Salvad.).

Corethruopsis leucospila Salvad., Ann. Mus. Genov., VII, p. 975 (1875).

Hab. New Guinea.

Dr. Sharpe regards the genus *Corethruopsis* as synonymous with *Rallicula* and I have followed his views. I have never had an opportunity of examining a specimen.

APHANOLIMNAS Sharpe.

1892.—*Kittlizia* Hartl., Abh. Nat. Ver. Bremen, XII, Heft 3, p. 391 (type *R. monasa* Kittl.) nec Hartert 1891.

1892.—*Aphanolimnas* Sharpe, Bull. B. O. C., No. 4, p. XX, same type.

Aphanolimnas monasa (Kittl.).

Rallus monasa Kittl., Denkwürdigkeiten Reise russ. Amerika, Micronesien u. Kamtschatka, p. 30 (1858).

Hab. Ualan Isl.

MAY 1.

The President, GENERAL ISAAC J. WISTAR, in the chair.

Thirty-eight persons present.

A paper entitled "The Differential Action in Animal Locomotion of Certain Muscles passing more than one Joint," by Thomas Eakins, was presented for publication.

MAY 8.

The President, GENERAL ISAAC J. WISTAR, in the chair.

Thirty persons present.

MAY 15.

The President, GENERAL ISAAC J. WISTAR, in the chair.

Thirty-eight persons present.

The death of Jos. Szabo of Buda-Pest, a correspondent, was announced.

Papers under the following titles were presented for publication:—

Contributions to the Mammalogy of Florida. By Samuel N. Rhoads.

Contributions to the Life-Histories of Plants, No. XI. By Thomas Meehan.

MAY 22.

The President, GENERAL ISAAC J. WISTAR, in the chair.

Eighteen persons present.

MAY 29.

The President, GENERAL ISAAC J. WISTAR, in the chair.

Thirty persons present.

The following were elected members:—

William J. Fox, Andrew J. Downs, M. D., George E. Kirkpatrick, Henry P. Dixon and Theodore Presser.

The following papers were ordered to be printed:—

CONTRIBUTIONS TO THE MAMMALOLOGY OF FLORIDA.

BY SAMUEL N. RHOADS.

During the past two years the writer has received from Mr. W. S. Dickinson, of Tarpon Springs, Hillsborough Co., Florida, a considerable series of the mammals inhabiting that vicinity. A recent study of these has developed facts of sufficient interest to warrant publication.

Tarpon Springs lies within a few miles of the Gulf of Mexico, near the Anclote River, in a region typical of a large part of the southern half of the State. The country is level, very sandy, well shaded with lakes and "hammocks" and, owing to its proximity to the Gulf, combines inland and maritime zoological features within a comparatively small compass. The region in question lies just to the north of Tampa Bay, which may be said to define the northern extension of the typically Floridian fauna along the Gulf Coast. The following notes would seem to confirm the intermediate faunal position of Tarpon Springs between a Louisianian and Floridian environment. There is, however, an indication of geographic variation from forms typical of northern and eastern parts of the State, which shows a closer alliance among the mammals of Tarpon Springs with those of the more southern districts.

The only important faunal paper specially relating to the mammalogy of Florida is that of Dr. J. A. Allen in the Bulletin of the Museum of Comparative Zoology, Vol. II, p. 168-185.

I follow Dr. Allen's sequence of orders, genera and species.

1. *Putorius peninsulæ* Rhoads, sp. nov. Type, No. 1515, ad. ♀, col. of S. N. Rhoads; "Hudson's," Pasco Co., Florida; col. by W. S. Dickinson, Feb. 1894.

Description.—Size greater than average *P. erminea* from the Middle States; relative breadth of coloration of lower and upper parts as in *P. frenatus*; color pattern of feet, legs and face nearest *P. xanthogenys*; pilosity of foot-pads and ears nearest to *P. frenatus*; colors and length of tail and whiskers as in *P. erminea*; pelage scant, coarse and shorter than in any weasel examined; skull nearest *P. erminea*, but differing more markedly from either than *P. erminea* from *P. xanthogenys*.

Above, including tail, top of head, upper arm and hind thighs to middle of feet, light liver-brown of nearly the same shade as seen in fall specimens of *erminea* from Pennsylvania. Below, including inside of hind legs, distal half of hind feet, posterior two-thirds of forelegs, and all of forefeet, pale yellowish white. Muzzle, below margins of upper lips, an irregular patch above, but not reaching nose, an irregular streak half-way between nose and eyes and reaching behind anterior corner of eye, an ascending streak broadly rising on cheek and narrowing forward to just over eyes and not connecting with nose patch, also a short median streak between ears, pure white. A sparse patch of long bristling white hairs guards the opening of the ear. Two-thirds of the tail colored like the back, distal third, black. Tail two-fifths of length of body, very slender, sparsely haired, the terminal pencil short.

Skull.—(Post-palatal and post-frontal regions missing) intermediate in general configuration between *frenatus* and *xanthogenys*; in size very near the latter. Mandibles very massive and short; dentition also massive and crowded. The sudden post-orbital expansion of anterior portion of brain-case indicates that part to be relatively larger and more inflated than in any other of our weasels, resembling most in this character, *erminea*. Inner lobe of last upper molar slightly narrower transversely than outer lobe, the tooth standing at an oblique angle to the longitudinal diameter of the skull; in all the allied forms these proportions are reversed and the last molar is at right angles to this diameter. In *xanthogenys* the inner lobe is often twice the diameter of the outer lobe. In *peninsula* the longest diameter of the first upper molar is at an angle of 45° with that of the second molar and at *right angles* with that of the premolar; in the other species the first and second molar diameters are generally in the same line, never departing from it more than 15° and this diameter of the premolar is never deflected from that of first molar more than 20° in *frenatus* and *erminea*, nor more than 45° in *xanthogenys*.

While the skull of *peninsula* is one-third smaller than that of *frenatus* of same age, the upper first and second molars are as large as those of largest *frenatus* and absolutely stouter. Upper and lower canines short and stout, the lower so massive basally as to crowd the incisors into a double row, the second incisor of each mandible being forced back of the other four, which form a solid anterior row unbroken by the usual crowding forward of the second incisor be-

tween the first and third, seen in all other species of the *Muselidæ*. There is no symphysis between lower canines and first premolars, the latter over-lying the former in *peninsulae* and the second lower molar is relatively as large as in the upper series. Viewed laterally, the mandibles of *peninsulae* describe a nearly perfect half ring due to the great outer convexity of the ramus, its rounded, compressed angle and abrupt upward anterior curve. The ramus is also very thick (laterally) for its width (perpendicularly), the former dimension at the base of second molar is greater than that of largest *frenatus* while the latter dimension is one-third less. In *peninsulae* the width (horizontal) of the articular process of mandible is relatively much less than we find it in *frenatus* and *xanthogenys*, in this approaching *erminea*, but it is, as in other parts, relatively stouter than in any of them.

*Measurements*¹ (from stuffed skin):—Total length, 375; tail vertebræ (vertebræ remaining in skin), 100; hind foot, 40; pencil, 16.

Skull—Posterior base of incisors to post-palatal notch, 18.7; length of nasals, 9; interorbital constriction, 10.7; articular process of mandible to anterior base of incisor, 26; height of coronoid process from angle, 12.

My examination of the skulls of the above mentioned species makes it apparent, not only that the Florida animal is distinct from its allies in the United States, but that *xanthogenys* should be classed as a good species, separable from *frenatus* not only in external but in cranial characters. The relationships between *frenatus* and *brasiliensis*, of which some authors make it a sub-species, I am unable to discuss, from lack of material. *Xanthogenys*, in addition to its constant and well known color differences, may be cranially separated from *frenatus* of same age by the decidedly and constantly smaller size, the relative shallowness and flatness, the greater relative width to length and the sudden constriction of the skull behind the supra-orbital processes. The pterygoid fossa is also relatively shorter and both absolutely and relatively wider than in *frenatus*. The length of largest *frenatus* skulls is 54, while that of the largest *xanthogenys* is 46.

A stuffed specimen of this new weasel was sent by Mr. Dickinson in February, 1894. So far as can be determined, this is the first instance

¹ All measurements in millimeters.

on record of such an animal from Florida. Fortunately, the anterior half of the skull, including the perfect jaws, were within and attached to the skin. These were extracted and confirmed my suspicions, excited by the peculiar external characters, that the animal was a nondescript. As will be seen in the diagnosis, it combines the characteristic color-pattern of the *P. brasiliensis* group with the colors and relative measurements of the *erminea* group. This weasel was captured in the woods by a cat, in Pasco County, Florida, at "Hudson's," 14 miles north of Tarpon Springs.

2. *Lutra hudsonica* (Lacepede). American Otter.

The otter is abundant. Quite a number of their skins and furs have been sent. The latter, large and prime, bring little over five dollars in the Philadelphia market, owing to the scant pelage. The average color is even darker and more glossy than in the highly prized pelts from the northwestern States.

3. *Procyon lotor* (Linn.). Raccoon.

A large series of furs, skins and skulls of this abundant animal have passed through my hands. They show the Florida coon to be when young, almost exactly the same color as average adults from the Middle States. As they increase in age a strong suffusion of orange brown becomes pronounced on the back, rump and tail.

In Dr. Allen's paper (*sup. cit.*, p. 170) *P. hernandezii* is made a synonym of *lotor*. An exceptionally large series of skulls from Florida, the Middle States and the Northwest shows the following specific differences, based on six typical adult specimens of each series.

	<i>P. lotor.</i>	<i>P. hernandezii.</i>
1. Zygomatic width,	63 to 72	74 to 79
2. Basilar length,	98 " 104	96 " 104
3. Inter-orbital constriction,	26 " 30	20 " 24
4. Ratio of first meas. to second,	68	77.4
5. Ratio of third meas. to second,	22	28

In *hernandezii* there is no ridged occipital crest, generally present in older examples of *lotor*; the mandibles are heavier and stouter, more widely separated to accommodate the great width of brain case, and broader between the canines; in length they are the same as in *lotor*. The angle is more produced, narrow and angular in *hernandezii*, the upper molar series very wide for their length and decidedly

triangular, in *lotor* the molars are quite symmetrically rounded. The premolars in the former are large, strongly rooted and always present, in *lotor* they are relatively smaller and the first premolar often crowded out. Auditory meatus of *hernandezii* produced like the neck of a flask, making transverse diameter of bullæ much greater than the longitudinal, in *lotor* these diameters are equal. In *lotor* the median attenuation of the zygomatic arch is decided, narrow and semi-cylindrical; in *hernandezii* it is slight, the malar being broad and strap-like. A strong and constant difference between Pacific and Atlantic Coast specimens is the much greater relative size of the brain and brain-case in the former, especially in the anterior breadth and greater depth. This feature causes a specific difference in the upper cranial profile; in *hernandezii* there is a gentle continuous rise from nasals to the fronto-parietal suture or even farther back, in *lotor* this ascent is more abrupt to the interorbital region, which is tumid, followed by a depression and rising again, giving the skull an undulating profile.

The characters given by Prof. Cope (*Amer. Nat.*, Feb., 1889, pp. 141-142), as distinguishing *lotor* from *hernandezii* I do not find of as constant value as those above given, except those relating to the latter species near the bottom of page 142, notably the greater prominence of the post-orbital processes of the malar and frontal bones.

4. ?*Atalapha borealis* ² *pfeifferi* (Gundlach). Florida Red Bat.

All the specimens of this bat sent from Tarpon Springs, as well as those which I have examined from other parts of the State, are uniformly of the "deep cherry red" spoken of by Dr. J. A. Allen (*sup. cit.*, p. 173). Dr. Harrison Allen (*Mon. Bats. N. Amer.*, 1893, p. 146) notices the same peculiarity and refers them questionably to *A. pfeifferi* Gundlach, (*Monatsb. K. B. Akad.*, Berlin., 1861, p. 152).

Dr. Gundlach's description, which is full, seems to answer for this form very well, except that he states the roots of the hairs are gray, whereas in Florida specimens the roots are black. The color of *pfeifferi* is said to be cinnamon red in the male and cinnamon brown in the female. I have been unable to secure specimens of the Cuban form for comparison, so refer the Floridian variety to it for the pres-

² *Vespertilio borealis* Müller, *Natursyst.*, Suppl., 1776, p. 20, antedatés *V. noveboracensis* Erxl., *Syst. Reg. Anim.*, 1777, p. 155.

ent. The range of color variability of the Red Bat of the Carolinian fauna never approaches the character of that seen in all my specimens from Tarpon Springs. They fully deserve sub-specific recognition, not only on account of their decided differences, but because of their constancy.

5. *Adelonycteris fuscus** (Beauv.) H. Allen. Brown Bat.

Numerous specimens received.

6. *Vesperugo carolinensis** (Geoff.). Georgia (Carolina) Bat.

Two specimens.

7. *Nycticejus humeralis** Raf. Rafinesque's Bat.

Three (?) specimens.

8. *Vespertilio gryphus** F. Cuv. Little Brown Bat.

Several specimens.

9. *Nyctinomus brasiliensis* Is. Geoff. Brazilian Bat.

Very abundant.

10. *Scalops parvus* Rhoads, sp. nov. Type No. 1468, ad. ♀; col. S. N. Rhoads, Tarpon Springs, Fla., Dec. 24, 1893, col. by W. S. Dickinson.

Description.—Size two-thirds that of *Scalops aquaticus*; pelage much coarser, having the appearance of spun glass; the terminal fourth of hairs silvery brown, basal three-fourths plumbeous; chest, wrists, muzzle and upper head orange brown, darkening posteriorly, golden anteriorly. Feet and tail coarsely haired, not downy as in *aquaticus*. Palms wider than long, the contour of nails evenly rounded both individually and collectively, not triangular as in *aquaticus*. Naked snout unusually long and slender, not divided at its inferior base by the "hare-lip" incision seen in *aquaticus*.

Skull.—On superficial examination, similar to *aquaticus*. Relative depth greater. Orbits relatively larger. Foramen magnum, viewed posteriorly, ovate, regular, lacking tricrenate anterior outline always present in adult *aquaticus*. In *parvus* there is a post-palatal spur not present in any specimens of *aquaticus* I have seen. The cranium viewed laterally shows an evenly ascending and more highly arched profile descending behind much more abruptly than in *aquaticus*, in

* For synonymy of these bats, see Dr. H. Allen's Bats N. Amer., 1893.

which the profile is interrupted by interorbital and parietal swellings. In *aquaticus* the last three molars average as wide as long, in *parvus* much wider than long, owing to the greater relative intrusion of their inner anterior cusps. In *aquaticus* the first premolar, owing to sudden constriction of the rostrum at that point, is thrown within the line connecting the canine and second premolar; in *parvus* these three teeth are in regular file. Mandibular dentition in *parvus* relatively wider for length throughout, and the outline of teeth more angular than in *aquaticus*; the hinder section of last molar in *parvus* is less than half the width of anterior section; in *aquaticus* the sections of this tooth are of equal width and its greatest length exceeds considerably its greatest width, while in *parvus* the transverse diameter equals the longitudinal. In the latter the mandibular ramus, as in the case of *Putorius peninsulae*, while much shorter, is absolutely heavier and wider.

There is a strong projecting shoulder at the anterior base of coronoid process in *parvus* not seen in *aquaticus*, and the accessory posterior spur just below tip of coronoid process in the latter is not present in the former. The measurements are as follows:—

BODY.		Total length.	Tail.	Hind foot.	Snout (tip to angle of lip).	
<i>Scalops aquaticus</i> ,		155	24	20	7.5	
“ “ <i>australis</i> ,		142	21.5	16.5	?	
“ <i>parvus</i> ,		117	151	6.5	7.5	
SKULL.		Total length.	Basil length.	Mast. breadth.	Int. con.	Mand. length.
<i>Scalops aquaticus</i> ,		34.5	27.1	18	8	22
“ “ <i>australis</i> ,		?	28.5	15.7	7	?
“ <i>parvus</i> ,		29.5	23.4	15	6.3	19

One specimen of this genus has been received from Mr. Dickinson. It is an adult, with teeth well worn, showing well marked specific characters to distinguish it from *S. aquaticus* and its closely allied forms, *argentatus* and *australis*.³

11. *Sciurus niger* Linn. Southern Fox Squirrel.

All of the thirteen specimens received are remarkably uniform in color for so variable a species, being of the light gray type, with black crown, white ears and nose patch and tawny underparts. One short tailed specimen is blacker on feet and legs, the belly rusty.

³*Scalops aquaticus australis* Chapman, Bull. Amer. Mus. N. H., 1893 Art. XXI.

12. *Sciurus carolinensis* Gmel. Gray Squirrel.

Abundant and presenting but slight variability. No melanistic examples reported.

13. *Sciuropterus volucella* (Pallas). Flying Squirrel.

Five specimens of this species are of special interest as they appear to be the first to go on record from Florida. They present no characters in either old or young which are not nearly duplicated by specimens from the Middle States.

14. *Geomys tuza* Ord. Florida Gopher.

Thirty specimens of all ages do not present the plumbeous color variations so strongly marked in *G. bursarius* (Shaw). They are not as variable as a like series of *Sitomys americanus*, such differences as appear being due to ordinary results of age and season. One very large, old male is uniform bright rusty above and hoary fulvous beneath. The rest are darker, the rusty mainly confined to sides, with a duskier dorsal stripe and hoary plumbeous belly. The naked yellowish tail invariably has a mahogany-colored tip and averages half the length of head and body. Some females, apparently only half grown, were nursing young.

15. *Mus decumanus* Pallas. Norway Rat.**16. *Mus alexandrinus*** Geoff. Roof Rat.**17. *Mus musculus*** Linn. House Mouse.

With exception of the Norway Rat these old-world species are very abundant.

18. *Sitomys americanus gossypinus* (Le Conte). Pine-woods Deer Mouse.

A series of thirty Tarpon Springs specimens show no mentionable differences from those of northern Florida. Two skins have a prevailing dark sooty suffusion of the under parts which at first sight would indicate a specific difference, but it is probably due to their residence in a recently burnt clearing. In young specimens the gray is more hoary above than in typical *americanus* and the underparts are more plumbeous, lacking almost entirely the pure white of lower head and neck seen in young *americanus*.

19. *Sitomys niveiventris subgriseus* (?) Chapman. Pigmy Deer Mouse.

⁴Bull. Am. Mus. N. Hist., II, 1889, 117; *ibid*, 1893, Art. XX

Specimens of a small white-footed mouse, which are at present referred provisionally to this race, were received from Tarpon Springs a few days before the issue of Mr. Chapman's paper on *subgriseus*. These were sent to Mr. Chapman for comparison and he pronounced them intermediate between *niveiventris* and *subgriseus*. Additional specimens, making in all seventeen, have since been received. A comparison of these with Mr. Chapman's rather brief diagnosis shows them to differ from *niveiventris* in their smaller size; from *subgriseus* in the uniform whiteness of the belly hairs to their roots, and from both forms in their uni-colored and nearly naked tails, which strikingly resemble those of *Geomys tuza*. Owing to my inability to secure a loan of the type series in the possession of the American Museum, a critical comparison of these differences cannot now be made. They appear, however, to represent at least a sub-specific variation, and a study of the cranial measurements strongly supports this view.

Mr. Dickinson writes me that these mice "were taken in a cultivated field near the head of Anclote River, in Pasco County. They make a burrow from two to three feet long and ten to eighteen inches deep, at the bottom of which is found the nest. They also have a second passage through which to escape from their enemies in case of pursuit; the outlet of this is hidden, apparently lacking three-quarters of an inch of penetrating the surface of the ground. When a switch is inserted they push through this secret outlet and often escape. In captivity they are cannibals."

20. *Oryzomys palustris natator* Chapman. Florida Rice-field Mouse.

One specimen sent. A series of this form from the Gulf Coast would be of interest to compare with those of northern Florida and Texas, but I have been unable to secure them.

21. *Sigmodon hispidus littoralis*³ (?) Chapman. Florida Cotton Rat.

Of the five specimens of Cotton Rat (three adults, two young) sent from Tarpon Springs, two very old individuals are strikingly different from typical *hispidus* and are evidently similar to the "No. 1,460" from Pine Island, mentioned by Mr. Chapman in his description of *littoralis* as being much grayer than the Gainesville

³Bull. Amer. Mus. N. Hist., II. June, 1889, Art. X.

specimens. They are also grayer than specimens from Indian River loaned me by Mr. G. S. Miller, Jr. They are likewise much larger, as the following table of measurements will show :

BODY.			Total length.	Tail.	Hind foot.	
<i>Sigmodon hispidus</i> ,			262	100	30	
“	“	<i>littoralis</i> ,	275	104	31	
“	“	<i>subsp?</i>	288	111	31	
SKULL.			Total length.	Zyg. width.	Int. const.	Length nasal.
<i>Sigmodon hispidus</i> ,			35.9	20.3	5.3	14.3
“	“	<i>littoralis</i> ,	35.5	20.3	5.4	13.2
“	“	<i>subsp?</i>	38.5	20.8	5.2	15

In *hispidus* the ratio of total length to zygomatic width is 56.5 in *littoralis* 57.2, in the Tarpon Springs specimens 51.4.

A later specimen from Mr. Dickinson is very similar in every feature to typical *hispidus* from North Carolina, being browner than typical *littoralis* and quite as small, though nearly adult. The receipt of this specimen has induced me to defer separating the southwestern form until a large series is at my disposal from this region. These two gray Cotton Rats from Tarpon Springs are either abnormally large and the small one abnormally brown, or else there are two species, the smaller, true *hispidus*, the larger, unnamed. Such a condition of affairs is not impossible, the former being an inhabitant of the inland fresh water marshes, the latter frequenting the maritime shores.

22. *Reithrodontomys humilis* (subsp?) Aud. & Bach. Harvest Mouse.

One specimen received. I do not find any record of this mouse from Florida. The specimen, if characteristic of the form inhabiting southern Florida, represents a race as different from the northern type as other of the Florida Muridae.

The specimen, while apparently full grown, is not fully adult and, in the hope of securing more specimens, further description is now deferred.

CONTRIBUTIONS TO LIFE HISTORIES OF PLANTS, NO XI.

BY THOMAS MEEHAN.

ON THE MORPHOLOGY OF BRACKETLESS INFLORESCENCE.

In various papers I have given illustrations to demonstrate that the variety of inflorescence known as extra-axillary results from the sudden arrestation of a growing shoot, and the immediate growth of the axillary bud, which pushes aside to a lateral position the former leader and effectually takes its place, only to be itself pushed aside by another developing axillary bud, when the proper time for that development has arrived.

Although this explanation is fully satisfactory so far as bracteated inflorescence is concerned, it does not explain the morphology of the naked flowered class, the exact nature of which has never been determined, and which, hitherto, I have never been able to understand.

One has only to read the chapter on "Inflorescence" in "Sach's Text Book" (English edition, p. 519 and following) to learn how confused and unphilosophical are prevailing notions concerning the nature of the various forms of inflorescence. That "Boraginaceæ and Solanaceæ" present an inflorescence determined by "the repeated dichotomy of an axillary bud," is better expressed by my proposition that it is determined by "the assumption of leadership by the axillary growth;" but though it is clear to Sachs that "the ultimate floral axes or pedicels of the flowers" are "not axillary in Aroideæ, Cruciferae, &c.," he still insists "that every inflorescence originates from the normal terminal branching of a growing axis." "If bracts are conspicuously developed, the lateral axes arise in their axils; if they are inconspicuous or abortive, the lateral axes of the inflorescence are not axillary, but their mode of branching and growth remain the same as if the bracts were present." Though long satisfied that this diagnosis of naked inflorescence was wrong, and that there never had been theoretical bracts to abort, I have not, until now, been able to perceive that inflorescence is not all constructed on one plan; and that naked inflorescence, in particular, does not need the theoretical conception of bracts and axillary buds to account for its character.

In Saxifragaceæ most species are characterized by bracteated inflorescence, but there is a small section, of which *Saxifraga crassifolia* is the type, which has naked cymes. With one species of this section before me, *S. cordata*, it was evident that so wide a departure from the rest of its family could not be explained by any conception of axillary branching, such as a bracteated character involves. Abortion of the bracts could not by any possibility, have occurred. Neither could my own proposition of the pushing aside of a terminal axis by the growth of an axillary bud have any place in this arrangement. After many days of observation, thought, and comparison, the manner in which the inflorescence was formed became so clear, that the only surprise was that it had taken so many years to discover it.

The inflorescence of these Saxifrages is formed simply by *the elongation of the petioles and coalition of the stipules; the branchlets and the flowers, with their pedicels, are modifications of the leaf-blade; the veins forming the pedicels, and the flowers proceeding from buds formed at the apex of these veins.*

It is not necessary to go into close details, as the suggestion once given, any one with one or several plants before him can see that this is the fact. The bud scale, enclosing the embryonic flower scape is the enlarged and dilated base of a leaf, which, at the end of the past growing season, developed so far only as to form this scale. When the growing season arrives, this scale is rejuvenated, and increases a little in size, but the next one to elongate is perhaps double the length, with no increase in width. The next is still longer and narrower, with an imperfect leaf blade just beneath the apex. The perfect leaf blade at length ensues, with a still greater elongation of the dilated base, which we might now almost call the stipular portion. The next following has an inch, or sometimes more, of a petiole between the apex of this stipular portion and the leaf blade, still, however, with the apex of what would have been a bud-scale, apparent. It is important to note this projection as furnishing the key to what follows. The flower stem now pushes up, wholly leafless, but as the lower branchlet of the cymose inflorescence develops, we see the *apex before noted* in the axis, and by further observation may trace on one side of the main stalk, a ridge evidently formed by the overlapping outer edge of the coiled stipule. Succeeding branchlets

show, but in a less degree, the same arrangement. The numerical order of the secondary branchlets of the inflorescence, and their general divergence and arrangement, correspond well with the main branchlets of the veins in the leaves, leaving no doubt in the mind of the thoughtful observer of their morphological identity.

Taking a glance at what occurs in other plants there is analogy for the view here taken. Some Begonias form leaf-buds at the end of their leading veinlets, as do many ferns; and a well known plant in cultivation, *Bryophyllum calycinum*, is increased mainly by such buds. Morphologically there is no difference between a leaf-bud and a flower-bud, so that we may reasonably expect flowers to appear where leaf-buds may exist. And in other respects *Bryophyllum* fortifies the position assumed for the Saxifrage. The leaves appearing at an early stage of growth are entire, and formed much as we find them in *Saxifraga cordata* but as the flowering stem progresses towards the flowering stage, the newer leaves become divided, and trifoliolate—that is to say, the veins are comparatively destitute of their normal cellular covering, and are on their way to become the pedicels we find in the inflorescence of the Saxifrage.

I may conclude by reaffirming the proposition already presented, that nature does not depend on one method only as a plan for the formation of inflorescence; that in *Saxifraga cordata*, and probably in bractless inflorescence generally, the elongation and coiling of stipules or the dilated bases of leaf-stalks form the main axis or stem; and the leaf-blade the branches, branchlets and flowers.

ON PURPLE-LEAVED PLANTS.

A large number of plants occasionally produce individuals with reddish or purple leaves. These are propagated by nurserymen, and are known in gardens as "blood-leaved" trees and shrubs. Thus we have blood-leaved oak, sycamore, beech, barberry and many others. Perpetuated by grafting, these retain the blood-leaved character through life, no variation from this characteristic having been placed on record.

No attempt to explain this eccentricity seems to have been made. It is well to place together facts that may ultimately lead to an explanation.

In flower paintings the leaves and vegetative parts of plants are

usually represented of a uniform tint of green, but the real artist will tell us that there is seldom lacking a shade of brown or purple in some portions of leaves and branches that are in the highest conditions of vigor. The stronger growing shoots of the well-known *Pyrus japonica* are always of a bright rosy brown, only in those shoots growing in the interior of the plant, in partial shade, is the brown tint wanting. In the blood-leaved beech, the interior half-starved leaves have little of the brown, and the more vigorous the exposed branches are, the deeper is the shade. Blood-leaved trees themselves are, on the whole, more vigorous than the normal green-leaved forms from which, in the language of the nurseryman, they originally "sported." There is little doubt that in some unknown way, a vigorous vital power is accountable for the blood-leaved character in these cases.

A remarkable variation in the blood-leaved form of the common white birch has recently occurred. Some twelve years ago, a small plant was received from France. Some half a dozen were raised from it by grafting on a closely allied species, *Betula populifolia*. From the ends of some of the lowermost branches in two of these trees branchlets with the ordinary foliage of *Betula alba* have appeared. The dark "red" or purplish brown color of the leaves pervades the bark as well. In the reversion instanced not only the leaves but the branches have assumed the normal green. It is interesting to note that the reversion is not completed at once. The dark color first seems wanting in limited portions of the bark as the growth proceeds. At times the green part widens, then again lessens in length and width. In one case the dark portion extends as a hair line for four inches upwardly before it finally disappears. In one case half the leaf is purple, the other half green. There is no gradual shading off of the green and the brown,



but the lines are distinctly drawn where one tint ends and the other begins.

When these plants were grafted originally, one of the grafts one year old was broken completely off. The stock pushed out a branch of the blood-leaved form at a considerable distance down from the point at which the graft had been inserted, a note of which was made at the time in the "Botanical Gazette." This branch was of the same species as the parent, *Betula alba*, and not *Betula populifolia*, the stock.

We may conclude from these observations, that whatever the law may be which induces this change of color from the normal green to the blood-leaved condition, the change is effected in an original single cell or nucleus of the seed, and that the subsequent cells carry along the peculiarity of the mother cell through the whole life of the tree. It is further evident that it is an additional character, and not a change, as when the cell parts with it, as in the case of the birch cited, growth goes on just as before. In the case of the branch coming out below the point of union with the stock, we learn that the reproduction of daughter cells from a mother cell can take place downwardly as well as in other directions, and that *buds and branches can be produced from an original cell*. There is no distinction in nature between an axis and a leaf. They can both originate when the conditions favor, from a single cell, in any part of the plant.

ON THE ORIGIN OF THE APICAL CELL.

When treating of plant-tissues much has been said of the *punctum vegetationis*, and the necessity of a pre-existing *apical cell* before a branch can be formed. It does not seem to be conceded that any cell may, in an early stage of existence, produce a separate apical cell, capable of becoming the parent of a branch, whenever the exigencies of the plant require it. But I have had abundant evidence that the primary meristem or cambium tissue can, in emergencies, easily produce apical cells from which buds and branches can proceed. I have seen numerous cases of horse chestnuts, *Æsculus Hippocastanum*, Osage orange, *Maclura aurantiaca*, and Cottonwood, *Populus monilifera*, cut down in the winter time, that made buds and branches from the cambium tissue formed the preceding year, along the whole circumference of the tree stump. Hundreds of cells from

this tissue would attempt to form shoots, many naturally being crowded out, but enough finally making a growth to present a miniature forest. The most remarkable case of this nature came under my observation in 1893, and relates to two large Carolina Cottonwoods, *Populus monilifera*, standing on the sidewalk at the corner of Greene and Harvey Streets, Germantown. About the time of the unfolding of the leaf, a horse had gnawed away the bark, exposing the wood for a space of nearly a foot in diameter. About midsummer, when the new cambium layer was being formed,¹ hundreds of buds developing to leaves and branches, appeared from the edge of the whole exposed surface of the new layer. It was a remarkable sight that a layer of tissue, usually content to cover a wound with new wood, should at the same time seem to be covered with scores of what one would call seedling trees if they had been at the surface of the earth.

It must be well known to observers of trees which have had large branches sawn off, that numerous buds producing branches will push through the bark of the stump near where the upper portion was cut away, proceeding, of course, from the primary meristem tissue which must have had the power to produce the necessary apical cells for this bud formation. But it is not often that the same power can be evidenced by similar growths from the exposed portions of wounds, as the observations here recorded afford.

THE FALL OF THE LEAF IN THE HOLLY.

Near Philadelphia the spring growth of the American Holly, *Ilex opaca*, occurs in May. Simultaneously with the appearance of the new growth the ground is strewn with fallen leaves. I have thought, in common with most, if not all observers, that the swelling of the new growth dislodged the old leaves, just as it seems to do in the case of oak or beech leaves, where leaves that happen to remain dry on the branches all winter, drop when the new growth occurs in spring. To my surprise I find that this is not the case in the holly. After the copious fall already referred to, it is found that most of the fallen leaves were those of last year. Two-year-old leaves on

¹I have shown in the Proceedings of the Academy, 1866, pp. 292-293, that it is only about that time, in this tree, the tissue known as the cambium layer is formed.

the tree are abundant. Some of these are among the fallen ones, but few, apparently, in proportion to those from among the last season's growth. There is no fixed order in the dropping of the leaves. On a branch with say ten last year's leaves, it may be the first, fourth or fifth in the order of growth, or it may be a few of the later ones. In some cases all of the last year's growth will fall from the branch, leaving a few healthy leaves below of the year previous to the last. These will probably fall in a natural manner later in the season.

Just here arises the question: What is the "natural manner" of the fall of the leaf? If a branch of any tree be broken off before maturity, the leaves dry, but remain attached to the parent branch. There is no "fall of the leaf" in this case. On the same branch, if it had been left on the parent stem, the leaf would have formed cork cells at the junction of petiole and stem, and have fallen by mere disarticulation at that point, in due season. Histology has taught us that cork cells are differentiated from other tissue, but the manner in which this has been brought about has not been demonstrated so far as the writer is aware. It has been thought that the following observations in connection with this subject may at least direct thought, if they throw little direct light on the subject.

On the leaves of the holly which are to fall, one or more small, black blotches underneath the epiderm appear here and there, being apparent both on the upper and under surface of these leaves. At this season the parenchyma takes on a yellow cast, the black blotches, however, retaining their character. Disarticulation then follows. The leaves which are perfectly green, and with no dark blotches on them, continue on the stem. The connection between these blotches and the fall of the leaf is undoubted, and we may almost as logically say they are connected with the formation of the cork cells which act directly in disarticulation.

Those of us who have had a wide experience with living vegetation have no difficulty in surmising that these dark blotches are of a fungous character. My good friend, the eminent mycologist, Mr. J. B. Ellis, of Newfield, New Jersey, after a microscopic examination of these fallen leaves, finds evidence that the marks are caused by a minute fungus, though in this and similar instances he has never been able to get nearer the fact than that they are manifestations of

some zymotic organism that permeates the whole structure of the individual during its progressive growth.

I have, in other papers, shown that the bark of trees is not decorticated in any mechanical way, but by the growth of cork cells, each species having its own time and manner of development. In some trees these cells become active on bark but one or two years old, while in the chestnut, *Castanea*, and some others it may be twenty or more years before any sign of a "rough" bark appears, through the quiescence of the cork cells. No one, as I have already hinted, seems to have been able to demonstrate the causes which lead to these varying and remarkable results.

In the case of these holly leaves it is evident that they do not fall in response to the requirements of any definite period of maturity, but that the cork cells which provide for disarticulation are simultaneous with the destruction of the parenchyma. This is apparently the work of an adventitious agency, not essential to, but in some way co-ordinate with the regular economy of the plant.

ON BEES AND HONEY-SUCKLES.

I was interested to-day, June 18th, in noting that while a few honey bees persistently collected nectar from the mouths of honey-suckles, by far the larger number collected from the fallen flowers only.

The plant was *Lonicera japonica*, in the two forms known in gardens as *L. brachypoda*, and *L. flexuosa*, both intertwining and flowering together. I have, in the past, satisfied myself that a bee which starts from the hive for pollen pays no attention to gathering nectar, while the one looking for nectar collects that only. Whether this is the course of labor for that trip from the hive only, or whether these particular tasks occupy the whole day or more, may be an interesting question. I had never noted bees collecting nectar from fallen flowers; indeed had not noted that fallen flowers had nectar, so that the attention of the bees to them gave the subject a double interest.

The flowers are white when freshly opened, the next day yellowish, the following they wither slightly and fall. Large numbers are collected by the bees on which they mostly lie till they turn brown and shrivel completely. Those which were badly shrivelled seemed preferable to the bees.

On cutting across the tube of a white corolla near the base, and then gently stripping the flower downwardly a large globule of nectar protrudes. The same process executed on the older or yellow flower, gives about the same quantity as also does the faded flower of the third day. In the dried flower, taken before much shrivelling had occurred, nearly as much nectar was found. The completely shrivelled and twisted flower could not be "stripped" of its secretion in this way, but it was certainly present and as abundant. The bees carefully sought what would have been the mouth of the corolla, and then extracted the sweets from that point. It soon became evident that the shrivelling and contracting of the tube of the corolla acted in the same manner as the thumb-nail and finger in "stripping," lessening the diameter of the tube, and forcing the nectar towards the mouth, and within the reach of the visiting insect.

As noted, the bees collecting nectar from these dead flowers, never visited the fresh opening ones; while the few visiting the fresh flowers never visited the dead or dying ones; a very careful watch of half an hour satisfied me on this point. It was noted that the latter took considerable time and much labored effort with each flower. There was an average of fifteen seconds to each flower, a very long time for the average honey-making bee. Those working on the drying flowers made no more than the ordinary effort of bees with fresh flowers. It was difficult to understand why in the same variety of insect should each have its own line of procedure. If it should be suggested that bees could profit by experience, and that those which confined themselves to the freshly opened flowers were young bees that had yet much to learn, there still remains the fact that they did not profit by the experience of the older bees. Sometimes almost side by side, it might be supposed that any creature that could profit by experience, would want to know what the one picking at a dried flower had found.

The relation between insects and flowers obtrudes itself here. Many plants, as I have placed on record, shed their pollen and cover the stigma before the opening of the corolla. Whether the stigma is in receptive condition or not, the pollen remains there till it is, and we may regard all such as "arranged for self-fertilization," if, indeed, there is any such special arrangement in the vegetable world wholly with this view, or with the special view of cross-fertilization. But in this honey-suckle the anther sacs burst immediately on expansion and

the anthers are in such close position to the stigma that it can scarcely do aught but receive its own-pollen. All the flowers examined seemed to have the stigmas completely covered with pollen, and I feel pretty sure, with own-pollen. My plants are, however, infertile, rarely a few berries mature. I should refer this to propagation from an infertile plant, as we frequently find to occur in all classes of ligneous plants, which fruit neither with own-pollen nor foreign pollen, rather than to any want of ability in own-pollen to produce fertilization as an abstract principle, as would be assumed by some.

There still remains to be discussed why all this large amount of nectar should be secreted by the flower with no apparent benefit to itself in any conceivable way. But it is not safe to say, that, because we can not see that any benefit results in relation to the visits of insects, it is of no value in some, as yet, undiscovered operation in the economy of nature. For aught we know it may be an excretion rather than a secretion, which it may be as much an advantage to get rid of when of no further use to the plant, as it is an advantage to get rid of the corolla itself.

A very curious circumstance in connection with these observations was the discovery that each of these two forms of the *Lonicera japonica*, have different times of the day for the opening of its blossoms. The expansion, as in so many points of growth, is rhythmic and not a continuous effort. In the form known as *Lonicera flexuosa*, the lobes of the corolla parted so as to admit of the protrusion of the stamens at 2 P. M. Further efforts at expansion rested till 4 P. M., when the act was resumed and completed. *L. brachypoda* commenced opening at 5 P. M., and completed the opening by 7 P. M.

There is no reason why variation may not occur in the behaviour of plants as well as in the parts of their structure, but it is difficult to conceive of any physiological value in these variations from any point of view in the economy of plant life.

THE DIFFERENTIAL ACTION OF CERTAIN MUSCLES PASSING
MORE THAN ONE JOINT.

BY THOMAS EAKINS.

It is not without diffidence, that I, a painter, venture to communicate with a scientific body upon a scientific subject; yet I am encouraged by thinking that Nature is so many sided that the humblest observer may, from his point of view, offer suggestions worthy of attention. I am greatly indebted to Dr. Harrison Allen, who has kindly added some explanatory notes.

I have long been dissatisfied with the account in standard works of the muscular action in animal locomotion. The muscles are classified principally as flexors and extensors, working and resting alternately. Wishing to apply this system during my early dissections to the leg of the living horse, I was surprised to observe in the strain of starting a horse car, that the so-called flexors and extensors were in strong action at the same time.

The classification was still farther from satisfactory when applied to muscles passing over two or more joints, flexing perhaps one joint, while extending another. In trying to understand the significance of these last named muscles, I came to believe it to be very important to discover if the one joint was extended more rapidly than the other was flexed. This investigation demanded a consideration of the amount and kind of leverage, and was extended from the muscles to tendons¹ which pass over the two or more joints. I next constructed a model of the entire limb with flat pieces of half-inch pine board, cut to the outline of the bones, the pieces pivoted together, having catgut for tendons and ligaments, and rubber bands for muscles, all attached to their places and properly restrained.

I had then the satisfaction of seeing this mechanism imitate in many ways the action of the real leg, and was enabled to establish two important principles, thus: First, the hoof-pieces properly set upon the ground, the leg stood firm, all tendency to collapse being prevented by the leverage of tendons passing joints. Secondly, the

¹The use of the word "tendons" in the sense here employed, does not refer to the tendons in connection with muscular bellies, but to ligament-like structures which are homologous with the muscles as these bodies are uniformly assigned by authors to the musculature of the limbs. H. Allen.

tightening of the rubber bands representing all the principal muscles, both the so-called flexors and the so-called extensors, *at the same time*, caused the upper part of the limb to spring forward when released, and proved to me that I was not mistaken in my observation on the living horse.

Returning to the dead horse, I denuded both a front and back leg of every shred of muscular fibre, yet they sustained weight.

There was no tendency to collapse, and an increase in the weight only measured an increase of resistance.² (If one wishes to repeat

my experiment with the dead horse and should choose the front leg, he must respect the large tendon concealed in the biceps brachialis which might escape a careless dissection, especially by one accustomed rather to dissections of the human body.) Observation of the living horse will teach us, that, if he wishes to lie down, he must first flex the pastern, and the stumbling horse must strike the hoof with force enough to flex the phalanges before he can go down.

To illustrate in the *simplest* way the scheme of the muscles and tendons passing more than

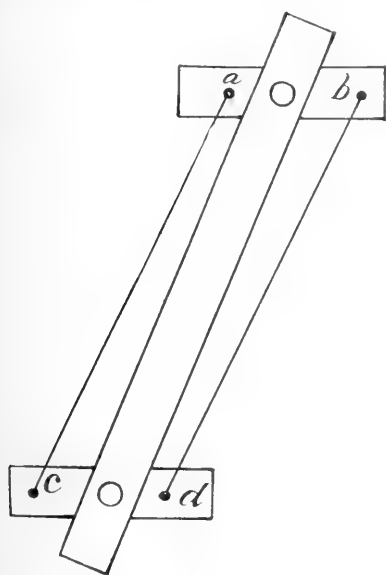

FIG. 1.

one joint I pivoted one little flat stick upon two others (fig. 1), and on the horizontal sticks I drove in four pins leaving the heads project slightly, the pin *a* close to the upper joint, the pin *b* farther from it; the pin *d* close to the lower joint, the pin *c* farther. If two inextensible strings be looped, one from *a* to *c*, the other from *b* to *d*, the upper horizontal piece is held up and will sustain weight. The

²Mr. Eakins exhibited to the members of the Academy photographs made by him at the University of Pennsylvania in 1883, showing the front and back leg of a dissected horse, all the muscles having been removed. Nevertheless the limbs sustained weight. H. Allen.

a end cannot go down on account of the string *b d* and the *b* end cannot go down for the string *a c*. If rubber bands be stretched on the same pins, then the upper horizontal piece will, if released, spring forward very far and very fast compared with the actual shortening of the rubbers (fig. 2).

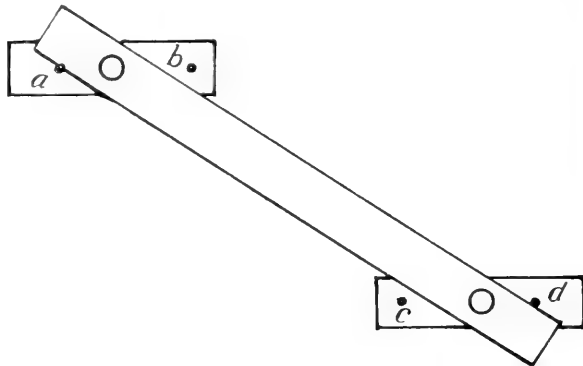

FIG. 2.

The model of the entire limb had all the merit of a first approximation. It imitated pretty closely the movement of the leg itself. A second and closer approximation can now be had by considering in terms of my first elements, the variations from Nature made in them to gain simplicity of construction. In the first place, articular surfaces are not circular, so that a pivot does not accurately represent their motion. Neither do bones moving in constraint, one against the other, keep in the same plane, but their axes describe warped surfaces from the helical character of the articulations.

There is a constant change in the relative rates of motion of the joints, involving likewise a constant change in the relative leverage.

The problem becomes instantly one of extreme difficulty, yet a fair appreciation may be obtained.

The leg should be studied in several positions not consecutive, but so far apart as to cause decided changes in the relative rates of the different levers, and so small a part of the path or trajectory should be considered, that a simple curve or straight line may, without error, be substituted as in the manner of studying evolutes.

I now draw the bones of the front leg of the horse (fig. 3), and of the hind leg (fig. 4), and with heavy black lines represent those

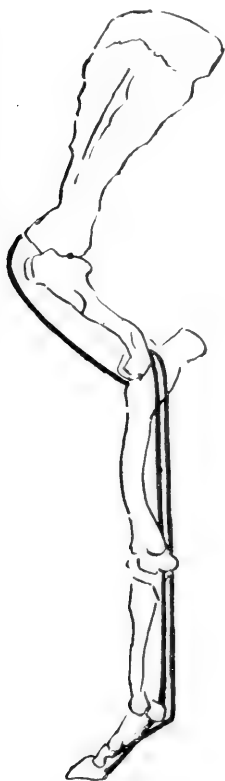

FIG. 3.

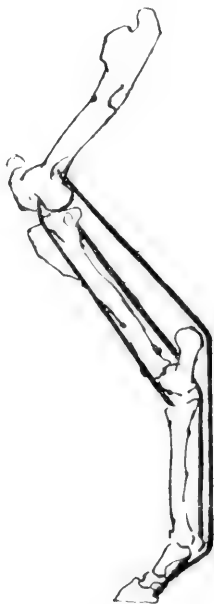

FIG. 4.

tendons which suffice to hold up the entire weight of the horse, and which, by their leverage in conjunction with the shapes of the articular surfaces of the joints, determine the trajectory of the horse's movement. (It seems likely that in the long run it was the trajectory which determined the length and position of the tendons and the shapes of the surfaces.)

In the diagram of the front leg I would like to call attention to the humerus having its upper joint, the one with the scapula, well back; while its lower joint, with the radius, lies well forward. The

great tendon running through the front part of the biceps brachialis has a very short leverage below and a long one above.³

In the hind leg you will notice that the femora-tibial joint is well back, while the astragalo-tibial joint is well forward, and the tendon in front of the tibia takes a longer leverage above than below, with this condition reversed in the two tendons behind the tibia.

When a horse stands in his usual position, the tendons which I have drawn sustain his weight in stable equilibrium, because his centre of gravity is at the lowest point of its trajectory.

The upper end of the dissected leg weighted heavily and moved backward and forward in the vicinity of the standing position, will there describe as a trajectory a flattish curve with its concavity upwards. At the lowest point of this concavity the leg settles when the horse ceases his muscular effort and simply stands. Any muscular effort that the horse may make from the standing position begins by raising himself. (A horse may, and often does, especially in haunching himself, maintain his weight at a still higher point behind by raising himself and slipping his patella over the inner trochlear surface of the femur, where it locks itself, and the weight of the trunk is again sustained without muscular effort. To unlock the patella traction is made by the tensor vaginæ femoris).

To investigate the action of a muscle I believe it necessary to consider it, not only with reference to the levers to which it is attached, but with relation to the whole movement of the animal. Then it will be seen that many muscles rated in the books as antagonistic, are no more so than are two parts of the same muscle. As an example, let us take the gastrocnemius. It is a short muscle, and takes its origin above the knee, and is inserted by means of a long tendon (the tendo Achillis) into the calcaneum. It is said in standard anatomies of the horse to be a flexor of the knee joint, of the leg on the thigh, and also to be an extensor of the ankle joint. As a flexor of the knee joint the muscle would be antagonistic to the great triceps

³ The anatomist would express these facts as follows:

The distal end of the scapula and the proximal end of the humerus are not all engaged in the formation of the shoulder-joint. The joint, indeed, lies well back and constitutes less than one-third of the relatively enormous area. I wish particularly to have noted, that the contact between the surfaces in the joint takes place as shown in figure 3, near the re-entering posteriorly placed angle, which is formed between the scapula and the humerus, while, as opposed to this, the contact at the elbow joint between the distal end of the humerus and the proximal end of the radius takes place well forward, so as to be near the re-entering anteriorly placed angle between these two bones. H. Allen.

extensor of the thigh. The great extensor cruris, however, pulling on the knee-cap and straightening the knee joint, continually moves forward the origin of the gastrocnemius muscle, and the latter pulling on the calcaneum and contracting itself at the same time, draws forward the calcaneum faster than the origin moves forward and acts during the whole step. The muscular fibres of the gastrocnemius are so short in the horse, that if the origin were not moved forward, this muscle would reach its limit of contraction long before the end of the step. Thus then, the gastrocnemius is auxiliary to the triceps, not antagonistic.

To prove this completely, let us cut away in the dissected horse the triceps and every other muscle except the gastrocnemius, which we will contract. Its action is precisely as before. It draws forward the calcaneum, but it *extends*, not *flexes* the knee.

The paradox disappears when we study a tendon running up the other side of the tibia, the tendinous portion of the flexor metatarsi.



FIG. 5.

This tendon takes a greater leverage (fig. 5) on the upper or knee joint that it passes, than on the lower or ankle joint, that it also passes; but the muscle has the reverse leverage. It takes a shorter leverage at the knee than at the ankle. In contracting, therefore, it raises the calcaneum, drawing down the flexor metatarsi tendon as shown by the direction of the arrow in the drawing, and the flexor metatarsi extends the knee-joint. Understanding then the differential action of the gastrocnemius muscle, we might look upon the triceps as the auxiliary of the gastrocnemius in extending the knee-joint.

The great muscles of the posterior aspect of the thigh, the long vast of the veterinarians (part of glut. max.), the biceps, the semi-tendinosus, the semi-membranosus, the gracilis, are inserted not above the knee but below it; not to flex the knee in progression, but to draw on an insertion that in a differential manner is moving away from the origin of the muscles, in order that the whole of the contractions may be utilized in the whole stride. In progression, then, the croup muscles are auxili-

aries to the great triceps on the other side of the femur and to the gastrocnemius.

The arrangement and action of the thigh muscles are imitated by the rubber bands of the small model (fig. 1). The up and down stick represents the femur, the upper horizontal stick the pelvis, the lower stick the upper end of the tibia. The rubber band from *a* to *c* is the rectus femoris muscle, with a short leverage above and a long one below. The rubber band from *b* to *d* is one of the croup muscles with a greater leverage above than below. The simultaneous shortening of the muscles on both sides of the femur throws, then, the pelvis forward *far* and *fast* compared with the actual contraction in the lines of the muscles themselves.

To show how little this differential co-ordinate action of the muscles and tendons has been understood, I shall quote a passage from Chauveau.⁴

Speaking of the tendinous portion of the flexor metatarsi he says:

"Some have attributed to it still another use, that of passively opposing itself to the flexion of the femur on the leg while standing, and serving thus as an auxiliary to the muscular forces which hold in equilibrium the weight of the body. This is wrong according to us. For it to fulfil this function, the foot would have to be held in a fixed situation by the contraction of its extensor muscles. Now these muscles are indeed the gastrocnemii of the leg, which take their origin behind the femur, and which tend to flex this bone on the tibia, that is to say, to cause the movement which they are supposed to be charged to hinder."

"Besides, experiment shows pretty well that we are right; the cutting of this tendinous cord, practised on the living animal, does not change its appearance while resting on one or both hind legs."

⁴"Ce tendon jouit de la curieuse propriété de plier le jarret par une action toute mécanique, lors de la flexion des rayons supérieurs du membre. On lui a encore attribué un autre usage, celui de s'opposer passivement à la flexion du fémur sur la jambe pendant la station et de servir ainsi d'adjuvant aux forces musculaires qui font équilibre au poids du corps. C'est à tort, suivant nous. Pour qu'elle (corde conductrice) pût remplir ce rôle, il faudrait que le pied fût maintenu en situation fixe par la contraction de ses muscles extenseurs. Or, ces muscles sont justement les jumeaux de la jambe, qui prennent leur origine en arrière du fémur et qui tendent à opérer la flexion de cet os sur le tibia, c'est-à-dire à déterminer le mouvement qu'on les suppose chargés d'empêcher. L'expérimentation, du reste, montre assez que nous sommes dans le vrai: la section de cette corde tendineuse, pratiquée sur l'animal vivant, ne trouble nullement l'habitude extérieure de celui-ci, ni pendant la station libre, ni pendant la station forcée." Chauveau. *Traité d'Anatomie Comparée des Animaux domestiques*. Page 357.

Now these people are right in attributing to the flexor metatarsi tendon the function of opposing itself to the flexion of the femur, and wrong only in making this function auxiliary to muscular forces, which are not called upon to sustain weight, and which if called upon in the usual way would start progression.

“To fulfil the function of sustentation,” says Chauveau, “the foot would have to be held by the gastrocnemii muscles which,” he says, “tend to flex the femur on the tibia.”

My experiment with the dead horse, the muscular fibres having been cut away, shows that the perforatus and perforans tendons maintain the foot, without the assistance of the gastrocnemius muscle, which does not flex the former upon the tibia, but *extends* it, as I have shown before. I mistrust entirely the accuracy of Chauveau's observation as to the effect of cutting the tendon in the living horse. The severance of this mighty cord in the dead horse causes instant collapse. I suspect that in Chauveau's experiment the cord was

but imperfectly cut; or, it may be, that by an extraordinary co-ordination of muscular effort the poor beast still stood for a short time previous to its final destruction, but it is inconceivable to me that a trained and unprejudiced observer should detect no change in the appearance of the animal upon the destruction of such a great part of the mechanism.

I shall close this communication with another beautiful example of muscular differential action. In the arm of the horse (fig. 6) we have two principal muscles, the biceps in front of the bone and the triceps behind. The biceps flexor radialis surrounds the tendon which I have drawn in heavy black line, and takes a long leverage above, at the shoulder joint, and a very short one below, on the radius. The long head of the triceps arises from the axillary border of the scapula, and is inserted into the



FIG. 6.

olecranon. The olecranon is set far back and above the elbow joint, to afford to the triceps a greater leverage below than above, reversing the condition of the biceps. These two muscles, during the act of progression, form a complete circuit of strain. The action of the

biceps is to extend the scapula on the humerus. This extension of the scapula pulls through the triceps on the olecranon, and thus gives the biceps a longer leverage on the radius than its own tendon gives it in front of the elbow joint. Consequently the biceps extending the scapula also extends, not flexes, the radius.

The long head of the triceps, with its long leverage on the olecranon, extends the forearm, but in so doing it pulls on the tendon of the biceps which, with its short leverage below and long leverage above, extends the shoulder joint, notwithstanding the direct insertion of the triceps into the scapula. The simultaneous contraction of the two muscles will raise the shoulder-blade above the tendinous trajectory, in replacing the tendons and aponeuroses by shorter lines. This causes, especially towards the end of the stride, the great difference between the trajectories of the dead and the living horse. Other circuits of strains connect this part of the limb with the lower part and others with the trunk, so that the least action anywhere is carried through the whole animal. The differential action of the muscles secures to the scapula from which the horse's body hangs, a much longer and swifter throw, a concurrent and auxiliary movement of great muscles, generally supposed to be antagonistic, a grace and harmony that any less perfect system of co-ordination would surely miss. This differential scheme is, perhaps, more apparent in the limbs of the horse than anywhere else, but it extends to other parts of its muscular system and to that of other animals including man.

I think these differential muscles have been a great obstacle to study. One is never sure that he understands the least movement of an animal, unless he can connect it with the whole muscular system, making, in fact, a complete circuit of all the strains. The differential muscles once understood, it is less difficult to connect nearly all the other great muscles with the principal movement of the animal, that of progression in the horse; and to understand, roughly, the combinations necessary for other movements.

On the lines of the mighty and simple strains dominating the movement, and felt intuitively and studied out by him, the master artist groups, with full intention, his muscular forms. No detail contradicts. His men and animals live. Such is the work of three or four modern artists. Such was the work of many an old Greek sculptor.

JUNE 5.

MR. CHARLES MORRIS in the chair.

Twenty-three persons present.

JUNE 12.

REV. HENRY C. MCCOOK, D. D., Vice-President, in the chair.

Thirty-one persons present.

The following were presented for publication:—

Certain Sand Mounds of the St. Johns River, Florida. Part II.

By Clarence B. Moore.

Crania from the Mounds of the St. Johns River, Florida. By Harrison Allen, M. D.

On a New Species of the Isopod Genus *Bathynomus*. By Dr. A. Ortmann.

The Changes which Take Place in the Skull, Coincident with Shortening of the Face-Axis.—Dr. Harrison Allen remarked that the anatomist, while interested in establishing co-ordinates, is well aware of the difficulties which are continually encountered. Still it must be acknowledged that co-ordinations exist between the component parts of every organism and as knowledge extends they will be gradually formulated.

The ensuing observations may be of value in denoting the kinds of changes which take place in the skull upon the shortening of the face-axis.

It has been assumed by authors that the shapes and positions of the teeth are the chief agents in modifying the shape and the size of the region of the face. In Chiroptera this is not the case. In comparing the cranium of the long-faced *Choeronycteris* and the short-faced *Ametrida*, it is remarked that not only are the face-proportions contrasted, but those of the zygomatic arches are changed (namely, in being slender or absent in the one and high in the other), while the face is broad at its base and the mesopterygoid fossa widened. The greyhound and the English pug-dog exhibit similar contrasts. In these varieties, in addition, the tympanic bulla is relatively larger in the pug-dog than in the greyhound. In Proboscidea the contrast between the length of the face-axis in *Mastodon* and *Elephas* can be expressed in the development of the pneumatic spaces in the skull; not, indeed, by the inflation of the tympanic

bullæ, or other parts of the base of the skull, but by the inflation of the diploic structure of the frontal and parietal bones.

In Edentata the difference between the long-faced *Tatusia*, *Myrmecophaga* and the short-faced *Megatherium*, *Bradypus* and *Cholopus*, is about what has been already noted in the foregoing examples. The zygomatic arch in the group last named, although incomplete, is high. The tympanic bulla, it is true, is inconstantly inflated, but that of the sinus in the frontal bone, compared with what is noted in the long-faced types, is like that which is seen in *Elephas* as compared with *Mastodon*.

Similar points can be established in the Quadrumana. *Macacus* can be separated from *Cynopithecus*, not only by the length of the face, but by *Macacus* having a more inflated tympanic bone. The same remark is true of *Propithecus* and *Nycticebus* as compared with *Lemur*.

The genera of Carnivora, as illustrated in *Melursus* and *Helarctos*, are in evidence of the same.

Even in birds, as was suggested by Mr. Fred. Lucas to Dr. Allen, the difference between the owl and the pelican and stork can be denoted by the amount of diploic structure in the head, as well as by the length of the face.

In Artiodactyla the evidence is obscure. In the remarkable fossil genus *Cyclopidius*, described by Prof. Cope, all the co-ordinates appear to be well established, namely, an extreme short face-axis is accompanied with great increase of width of the zygomatic arches and large tympanic bones. But these bones are generally large in the long-faced artiodactyles. The influence of many factors of necessity must be borne in mind before all the terms of the equation can be determined.

Care must be taken not to confound an isolated inflation of the tympanic bulla with the probable co-ordination above named. In *Corymorhinus*, *Euderma* and *Dipus*, as in some species of *Vulpes*, the inflation is correlative with the size of the auricle, at least is independent of the problem of face-shortening.

Many suggestive features present themselves in the skull of man. The inflations here, while basic, are not seen in the tympanic bones, but in the tissue at the median aspect of the petrosal bones, and at the sides of the exoccipitals. Prognathic and orthognathic forms can be distinguished, as a rule, readily by these parts of the base of the skull; but, as in all things pertaining to the study of the human skull co-ordinations are exceptionally difficult to establish. We are here dealing not with characterizations of a generic kind, but with those which are mutatory in tribal or racial groups of sub-species, and it is not reasonable to look for features so sharply defined as are those of genera of quadrupeds.

Hyperostosis on the Inner Side of the Human Lower Jaw. Dr.

Harrison Allen also stated that in 1889 (Toner Lecture, Smithsonian Institution) he announced the presence of a nodular hyperostosis on the inner side of the horizontal ramus of the lower jaw of the Esquimaux. Virchow, 1890 (*Zeitsch. für Anthropologie*), briefly refers to a sclerosed alveolar nodule in both the upper and lower jaw of a Santa Barbara Indian. Dr. Allen thought it probable that Virchow's claim (*Crania Ethnica Americana*, 1893) that his mass and the one in the Esquimaux lower jaw were the same would not be sustained. Virchow states that the Santa Barbara Indian exhibited the nodules best developed in the upper jaw, which gave his observation a distinct significance. Dr. Allen had lately noted the peculiarity, previously observed by him in the Esquimaux, well-developed in the lower jaw of the so-called Mound Builders. No claim is made that the hyperostosis is of ethnic significance, though the presence of a sclerosed hyperostosed surface constantly present in the Esquimaux and occasionally present in the people of the Mounds, while it has never been noted in the lower jaw of any other tribes, is an interesting fact.

JUNE 19.

REV. HENRY C. MCCOOK, D. D., Vice-President, in the chair.

Twenty-two persons present.

A paper entitled "Some Notes from a Study of the Provancher Collection of *Ichneumonidæ*," by G. C. Davis, was presented for publication.

JUNE 26.

REV. HENRY C. MCCOOK, D. D., Vice-President, in the chair.

Sixteen persons present.

The following were elected members :—

Elisha C. Hussey, Thomas S. Parvin and Dr. Harris A. Sloeum.

Mr. Anstruther Davidson, of San Francisco, was elected a correspondent.

The following were ordered to be printed :—

SOME NOTES FROM A STUDY OF THE PROVANCHER COLLECTION OF
ICHNEUMONIDÆ.

BY G. C. DAVIS.

It was with much satisfaction and high anticipations that I at last found myself on the train, en route to Quebec, Canada, for the purpose of studying the types of Ichneumonidæ in the Provancher collection. Ever since a short while after the death of the Abbé, I had been trying to ascertain what had become of the collection and its condition, but my efforts proved futile until recently, through the kindness of the Rev. Thos. W. Fyles, I learned of its location and the means of access to it.

I found the collection, as a whole, in three rooms of the Parliament Building at Quebec. It was recently purchased by the province and is a nucleus for a museum. The Abbé's collection consisted largely of insects and shells, and the whole is now under the charge of Mr. Saint Cyr, to whom great credit is due for the present good condition of the collection. As curator he devotes his whole time to the museum work, and throughout my stay very kindly assisted me in every way possible. The relatives of the Abbé did not realize the value of the collection of insects accumulated by him, and it was only by the earnest effort of Mr. Saint Cyr, who was a co-worker with the Abbé, that the collection was saved from entire destruction.

Although the collection had been in their charge but a short time the Lepidoptera were largely spoiled and many injured, and the other orders suffered considerably. As the collection now stands, it is neatly labeled and in fairly good cabinets. My time with the collection was quite limited, and farther than this I can only speak for the Ichneumonidæ. In that family I found quite a number of types missing and some broken with only a part remaining. Another feature, somewhat unsatisfactory, is, that, the collection is composed primarily of two individual collections, which still remain separate, and frequently specimens, labelled the same, were found to belong to different genera and often to different subfamilies. This at once showed a very superficial knowledge of the classification, and had I not soon obtained the cue to it and had access to the Abbé's

descriptions, which are fairly accurate as far as they go, the arrangement would have been still more annoying.

It had been my fear for some time that probably there were a number of errors in the Abbé's classification of species which he described as new. The synonyms which Mr. Cresson found in making his check list, the reports of other careful workers who had seen some of the Abbé's work, and some examples of his determinations sent me for verification, all went to prove this suspicion was not without foundation. Feeling that good scientific work could not be continued on the Ichneumonidæ as long as many uncertain species were of doubtful classification, it seemed wisest to rectify these errors before any further descriptive work was done in the family. This and a chance to study the types was the object of my visit. To say that I found errors is needless, as the list following this introduction will speak for itself. This list of corrections which I shall give is complete only in one respect, viz.: classification of species in the right genus. There are certainly many synonyms yet to be worked out, but it will take more time to determine these, and the few given herein are what I incidentally happened to recognize at a glance. Quite a number of corrections and additions to the descriptions will also be needed to make them clear and replete, but I shall not at this time even touch upon this matter. The list is from notes taken at the time the specimens were examined. The species not mentioned are correct as to classification.

Ichneumon adjunctus is the ♀ of *Ichn. similis*.

They are both identical in sculpture, form, and color markings, except face and posterior tibiae and tarsi, which differ slightly in shade. They belong to the genus *Amblyteles*.

Ichneumon aterrimus. Type not seen.

“ *citrinus*. Type not seen.

“ *paradoxus*. Type not seen.

“ *quadripunctatus*. Type not seen.

“ *vancouverensis*. Type not seen.

“ *saguenayensis*. Type not seen.

Hoplismenus impar is a *Cryptus*, with the ovipositor broken off.

“ *stygius*. Type not seen.

Amblyteles superbis. Type not seen.

Platylabus mitralis is a *Phygadeuon*.

Platylabus crassicornis. A *Phygadeuon* and very close to *mitralis*.

“ *cincticornis* = *Cryptus*.

“ *aciculatus*. Appears to be a ♂ *Phygadeuon*, though it comes very close to *Cryptus* in several features.

Phaogenes annulatipes. Type not seen.

“ *aterrimus* = *Phygadeuon*.

“ *crassitelus* = *Hemiteles*.

“ *huarti*. Type not seen.

“ *indistinctus* = *Cryptus*. The description of the type is faulty.

Phaogenes nigricornis is either a *Cryptus* or *Phygadeuon*.

“ *orbis* = *Herpestomus*.

“ *pinguis*. Type not seen.

“ *reticornis* = *Cryptus*.

“ *tuberculifer* = *Phygadeuon*.

Exolytus politus. Type not seen.

Stilpnus appendiculatus. Type not seen.

“ *canadensis* has the abdomen missing.

“ *lavis* has the abdomen and hind legs missing. These both belong to *Cryptinæ*.

Stilpnus deficiens belongs to *Thersilochus*.

Phygadeuon acaudus = *Dicaelotus*.

“ *alternans* = *Ichneumon*.

“ *attenuatus* = *Herpestomus*?

“ *brevicaudus* = *Ichneumon*.

“ *capitalis*. Type not seen.

“ *constrictus*. Type has lost the hind legs and abdomen, but from the oblique petiolated arcole and the general appearance of what remains, the type evidently belongs to a genus in *Tryphoninæ*.

Phygadeuon cornutus = *Hemiteles*.

“ *curtius* = *Amblyteles*.

“ *excavatus*. Type not seen.

“ *fratereulus*. Type not seen.

“ *fusiformis*. Type not seen.

“ *fasciatus* = *Colpognathus*?

“ *geddlessii*. Type not seen.

“ *gracilicornis*. Type not seen.

“ *guignardi* = *Ichneumon*.

Phygadeuon jocosus = *Ichneumon*.

“ *lavoiei* = *Cryptus*.

“ *longicornis*. Type not seen.

“ *marginatus*. Type not seen.

“ *niger*. Type not seen.

“ *pallicoxus*. Type nearly destroyed, but seems to be a good species.

Phygadeuon rectus. Antennæ wanting, but apparently a ♂ *Cryptus*.

“ *rubricus* = *Ichneumon*.

“ *similaris*. Type not seen.

“ *terminatus* = *Ichneumon*.

“ *3-annulatus*. Abdomen gone; antennæ indicate a *Cryptus*.

Phygadeuon truncatus. Type not seen. A specimen labelled *Phygadeuon poteus* is an *Ichneumon*. I know of no description of this species.

Cryptus albonotatus. Type not seen.

“ *dubius*. Type not seen.

“ *erythropygus*. Type not seen.

“ *flavipectus* = *Ichneumon scitulus* (Prov.). Type not seen.

“ *gracilis*. Type not seen.

“ *ignotus*. Type not seen.

“ *longicaudus*. Type not seen.

“ *mellipes*. Type not seen.

“ *ornatus*. Type not seen.

“ *perditus*. Type not seen.

“ *pubescens*. Type not seen.

“ *ruficornis* = *Phygadeuon nitidulus* (Prov.). Type not seen.

“ *segregatus*. Type not seen.

“ *sordidus*. Type not seen.

“ *spissicornis* = *Phygadeuon*.

“ *3-annulatus*. Type not seen.

Mesostenus albicoxus. Type not seen.

“ *albifacies* = *Mesoleptus*.

“ *armatus*. Type not seen.

“ *collinus* = *Cryptus eburneifrons* (Prov.). Type not seen.

“ *flavipes* = *Phygadeuon*.

“ *latigaster*. Type not seen.

“ *nobilis* = *Phylodietus*.

Mesostenus pluricinctus. Type not seen.

“ *ruficoxus*. Type not seen.

“ *rufotinctus*. Type not seen.

“ *sericeus*. Type not seen.

Hemiteles debilis. Type not seen.

“ *gigas*. Type not seen.

“ *orbicularis* = *Stilpnus americanus* (Prov.). Type not seen.

“ *ovalis* = *Orthopelma ovalis*.

“ *semirufus* = *Ischnocerus*.

Heteropelma longipes is apparently an *Anomalon*, though not typical.

Campoplex niger = *Exetastes*?

Limneria compacta. Type not seen.

“ *crassicornis* = *Campoplex*.

“ *radiolata* certainly belongs to some other genus than *Limneria*. It has many characteristics of *Pimplinæ* as well as of the *Ophioninæ*.

Limneria rufipes. Type not seen.

“ *sericea*. Type not seen.

“ *sessilis*?

“ *sulcatus* = *Anomalon*.

Pyraclon annulatum is evidently a species of the *Tryphoninæ*, and from appearance of venation and areoleted thorax belongs to *Tryphon*. Abdomen and most of legs gone.

Pyraclon incompletum is in most respects a typical *Atractodes*.

“ *rufum* = *Mesoleius*.

Cremastus longicaudus = *Atractodes*?

“ *mellipes* = *Limneria*.

“ *rectus*. Abdomen gone, but apparently well marked.

“ *royi* = *Atractodes* or new genus.

Mesochorus humeralis = *Atractodes*?

“ *pleuralis* seems to be a *Plectiscus* as Provancher had it at first.

Mesochorus truncatus = *Mesoleius*.

Cyrtocentrus quebecensis to all appearance belongs to the genus *Tryphon*.

In *Porizon* the species *angularis*, *borealis*, *elongatus*, *albipes*, and *californicus* are referred doubtfully to the genus.

Thersilochus errabundus = *Porizon borealis*.

“ *micans* is probably a *Porizon*.

Exetastes brevipennis = *Mesotenus promptus* (Prov.).

“ *clavatus*. Type not seen.

Banchus caudatus = *Exetastes*.

Mesoleptus albopleuralis will probably prove to be a ♂ *Atractodes* from the venation and other characters.

Mesoleptus angustus. Type not seen.

“ *annulatifpes*. Type not seen.

“ *barbatus* = *Limmeria*.

“ *fasciatus*. Type not seen.

“ *filiformis* = *Cryptus* ♂.

“ *flavicornis* to all appearance belongs to Ophioninae. The abdomen is compressed at the tip, and the petiole is long, straight, and slender.

Mesoleptus largus = *Tryphon*.

“ *nigricornis* = *Ctenopelma* (Prov.) Type not seen.

“ *rhopalocerus* = *Tryphon*.

“ *rufipes* = *Echthrus pediculatus*.

“ *rufulus* = *Phygadeuon*.

“ *sericeus* = *Cryptus*?

“ *uniformis*. Type not seen.

“ *variabilis* = *muliebris* (Prov.).

Eclytus robustus. This certainly is not *Eclytus*. The abdomen is wanting, but the head and thorax, with wings, indicate *Mesoleius* or *Mesoleptus*. The areolet is petiolate and somewhat obscure, but present.

Mesoleius annulatus = *Phytodictus vulgaris* Cr.

“ *chicoutimiensis* = *Tryphon*.

“ *fissus* = *Lampronota*?

“ *inflatifrons* = *Exochus semirufus* Cr.

“ *junctus* = *Basus frontalis* Cr.

“ *telarius* = *Phytodietus zonatus*.

Tryphon dufresnei ♀ is a large species of *Mesoleius*; the small ♂ belongs to the genus *Tryphon*.

“ *excavatus* = ♀ *Mesoleius*.

“ *fractus* = *Lampronota*.

“ *fumipennis*. Type not seen.

“ *gaspianus* = *Polyblastus* (Prov.).

Polyblastus annulicornis = ♂ *Tryphon*.

“ *decoratus* = *Lampronota*? Areolet wanting.

Polyblastus inornatus = *Lampronota*.

“ *gaspesianus* = *Tryphon*.

Erromenus bedardi = *Tryphon*.

Cteniscus canadensis. Type not seen.

“ *crassipes*. Type not seen.

“ *hullensis*. Type not seen.

“ *rufus* = *Aerotomus*.

Eryston marginatum. Type not seen.

Orthocentrus albofasciatus = *Megastylus* or possibly *Mesoleptus*.

“ *lucens*. Type not seen.

Orthocentrus pilifrons is badly injured, with antennæ and abdomen entirely gone. Femora slender, and areolet as in the *Cryptinæ*, where it undoubtedly belongs.

Orthocentrus nigricoxus. Type not seen.

Bassus cylindricus = *Pimpla inquisitor* Say.

“ *dorsalis* = *Plectiscus*.

“ *fuscitarsis* = *bicapillaris* Walsh.

“ *longicornis* = ♂ of *elongatus*.

Coleocentrus mellipes. Type not seen.

Rhyssa erevieri = *albomaculata* ♂.

Thalassa quebecensis. Type not seen.

Meniscus ashmeadii = *Pimpla annulipes*.

“ *marginatus* = *Pimpla annulipes*.

Aplomerus tibialis. Type not seen.

Echthrus nigricornis = *Cryptus* or *Phygadeuon*?

“ *pediculatus* = *Euxroides*?

“ *provancheri* = *Cryptus extrematus* (?)

A NEW SPECIES OF THE ISOPOD-GENUS BATHYNOMUS.

BY DR. A. ORTMANN.

In the year 1877, A. Agassiz dredged at 955 fathoms, in the Gulf of Mexico, a gigantic Isopod, described by A. Milne-Edwards (Compt. Rend. Acad. Sc., t. 88, 1879, p. 21, and Annal. Magaz. Nat. Hist. (5) III., 1879, p. 241) as *Bathynomus giganteus*. Delineations of this form were subsequently published by Filhol (L'Avie au fond des Mers, Paris, 1885, p. 147),¹ and by A. Agassiz (Three Cruises of the "Blake." Bull. Mus. Compar. Zool., Vol. XV., 1888, fig. 252.) Wood-Mason and Alcock made mention of the same species (Annal. Magaz. Nat. Hist. (6) VII., 1891, p. 270) taken by the "Investigator" in the Bay of Bengal at 740 fathoms. Lastly, Hansen (Det K. Dansk. Vidensk. Selsk. Skr. Nat. Math. Afd. (6), V. 3, 1890, pp. 252, 318, 378) pointed out the close resemblance to the family Cirolanidæ, while Milne-Edwards proposed to place this genus in a new group or family, "*Cymothoadiens branchifères*." This latter opinion was adopted by Wood-Mason and Alcock in creating the family Bathynomidæ.

After a careful examination of both opinions I believe Hansen's classification to be correct.

Bathynomus giganteus, which is remarkable, not only for its enormous size, but also for other morphological characters, was hitherto the only species of the genus. I describe herein a second species collected by L. Döderlein, during his sojourn in Tokio, Japan (1880-81), which, although smaller than the other, always attains dimensions unusual among the Isopoda. I propose to name the new species in honor of the discoverer, *Bathynomus döderleini*.

Diagnosis.—Body more slender than in *B. giganteus*, three times as long as broad (*B. giganteus* is not two-and-a-half times as long as broad). The last segment of the body (telson) is but little broader than long, its posterior margin is provided with seven spines, the middle one of which is the greatest. In the median line of the upper surface is a distinct longitudinal ridge. Both branches of the uropoda are pointed at the ends.

¹ I have only seen the copy in Marshall, Die Tiefsee und ihr Leben, 1888, p. 261, fig. 86.

Description.—Total length of the greater specimen 123 mm., breadth 42 mm., of the smaller 103 mm. and 36 mm. The whole upper surface finely granulated and punctured.

Frontal margin, in the middle, feebly sinuated, with a short process bent downwards. Eyes placed in the lower surface of the head, beneath the frontal margin, which is distinctly raised. Lamina frontalis equilaterally triangular, the angles rounded, the anterior meeting with the frontal process. Clypeus produced forward as a blunt, triangular projection, extending over the frontal margin so as to be visible from above, its longitudinal diameter greater than that of the labrum. The stalk of the antennulæ has three joints, the flagellum is about as long as the stalk, with nearly thirty joints. Stalk of the antennæ five-jointed, the first joint short and concealed. Flagellum in both specimens mutilated, the longest fragment has twenty-five joints, and reaches to the posterior margin of the first segment of the trunk.

Segments of the body finely punctured, the first as long as the head, the others considerably shorter, decreasing a little from before to behind. The first and second epimera nearly alike, not produced posteriorly, the four following posteriorly acutely produced, especially those of the fifth, sixth and seventh segments. The three anterior pairs of feet stout, second joint (see Hansen) not thickened, third longer than broad, fourth with the inner margin thorny, the process of its outer margin reaching to the middle of the sixth joint (but in the first pair of feet very short), sixth joint elongated and curved. The four following pairs of legs similar to each other, increasing in length. Second joint not remarkably thickened or enlarged. Third joint distally enlarged, the anterior margin with prickles, similar prickles at the anterior margin of the fourth and fifth joints. Sixth joint but little longer than the fifth, narrow.

Segments of the pleon evenly arched, the lateral angles of the second to fifth produced posteriorly and provided with a longitudinal ridge, those of the third segment longest. Pleopoda with roundish, almost equal branches, carrying at the hinder part of their bases the tufts of branchiæ characteristic of the genus, but since both are dried specimens the pleopoda and the branchiæ have become crumpled, and therefore it is impossible to give the details.

Last segment (telson) punctured and finely granulated, at the base but little larger than long, the lateral margins somewhat cou-

verging posteriorly. Posterior margin truncated and provided with seven spines. The median line of this segment is occupied by a longitudinal keel, produced to the end of the middle spine of the posterior margin. This spine is somewhat longer than the others which are likewise somewhat unequal, on either side the second (from the middle outwards) being a little longer than the other laterals. Stem of the uropoda produced at the inner posterior angle, outer branch elongated, the margins nearly parallel, acuminate at the end. The inner branch almost triangular, acuminate posteriorly, longer than the outer, not looking over the telson. Both branches with several prickles at the margins.

The legs were originally covered with hair, but now are nearly worn bare because of the dry conservation. The hairs on the margins of the uropods and the telson are also preserved only here and there.

This species occurs on the Japanese coast, near Enoshima, Sagami Bay. The depth is not recorded; probably it lives associated with the famous Japanese Hexactinellidae and Lithistidae. The types belong to the Döderlein collections and are deposited in the museum of Strassburg, Germany.

THIRD ADDITION TO A KNOWLEDGE OF THE BATRACHIA AND
REPTILIA OF COSTA RICA.

BY E. D. COPE.

The present paper is a continuation of the subject which has been treated in several contributions, and is preliminary to a second illustrated memoir, which, it is hoped, will present the subject in some completeness. The last "Addition" appeared in the Proceedings of the American Philosophical Society for 1893, p. 333; and the illustrated memoir was published in the Journal of this Academy for 1875.

I am indebted to the Museo Nacional of San José for the opportunity of examining the material here described.

BATRACHIA.

URODELA.

Ædipus robustus sp. nov.

Size large; proportions robust. Twelve costal folds. One phalange of digits free, as in *Æ. morio*, except in the inner (first) digits, which are entirely enclosed. Extended limbs separated by two intercostal spaces. Head flat, wide; muzzle short, its truncation little conspicuous; no canthus rostralis. Width of head entering length to groin five times. Eye small, its fissure equaling one-fourth the width of the head, and less than the interorbital space. Vomerine series straight in the transverse direction; extending beyond the nares externally, and abruptly recurved at the internal extremity toward the parasphenoid patch, which they do not reach. Parasphenoid patch not divided anteriorly. Tail rounded, the extremity moderately compressed. A gular fold.

Color, uniform plumbeous; soles paler.

Dimensions 206 mm.; length of head and body, 98 mm.; to gular fold, 22 mm.; width of head at rictus oris, 16.5 mm.; length of anterior limb, 20 mm.; do. of fore foot, 6.5 mm.; length of posterior limb, 21.5 mm.; do. of hind foot, 6 mm.; width of do. at base of fifth digit, 7 mm.

This is the largest salamander of tropical America, equaling in

length the *Spelerpes bellii* Gray. It resembles in appearance the unicolor form of that species, but differs in its proportions, as well as in the generic character displayed by the feet. The muzzle is longer, and more broadly truncate, and the head is narrower, than in the *S. bellii*. In the latter the eye is larger, equaling the width of the interorbital space plus that of an eyelid, and is little less than half the width of the head posteriorly.

One specimen, No. 226, from the Faldas of the volcano of Irazu, from J. P. Cooper.

SALIENTIA.

Hyla cherrei sp. nov.

Vomerine teeth few, opposite the middle of the very large choanæ, at the apex of a ridge which proceeds from the anterior margin of the latter. Ostia pharyngea round, large, but smaller than choanæ. Tongue longer than wide, but little free, and openly notched posteriorly. Tympanic drum distinct, one-half the area of eye, and equal in vertical diameter. Iris dark. Manus almost without web; pes fully palmate. Thumb not opposed. Heel of extended hind limb reaching end of muzzle. Canthus rostralis straight angular, lores vertical. Width of interorbital space 1.5 times the width of an eyelid. External nostrils terminal, a little nearer the eye than the diameter of the latter. Muzzle not prominent, vertical in profile. Skin smooth above.

Head and body above pigmented probably with yellow, in abrupt contrast to the color of the rest of the integument, from which it is separated from the orbit to the sacrum by a narrow white stripe. Colors otherwise uniform straw-color, the limbs pigmented on the exposed surfaces; the humerus and femur not pigmented.

Length of head and body, 26 mm.; do. of head to canthus oris, 5 mm.; width of head at do., 8 mm.; length of fore limb, 17 mm.; of fore foot, 6 mm.; length of hind limb, 45 mm.; do. of hind foot, 20 mm.; do. of astragalo-calcaneum, 8.5 mm.

No. 253, Alajuela, R. Alfaro.

This small and brightly colored species differs from all others known to me in the combination of characters it presents. The sharp canthus rostralis, anterior vomerine teeth, elongate tongue, large choanæ, and webless fingers, are not found together in any other species. It is dedicated to Mr. Geo. K. Cherrie, of San José,

to whom I am indebted for the opportunity of studying the present collection.

Hylella chrysops sp. nov.

Head short, wide, canthus rostralis wanting. Tongue a little longer than wide, faintly emarginate; ostea pharyngea each a transverse slit. Tympanum not visible. Pupil a dumb-bell shaped horizontal slit in the golden iris. Heel of extended hind limb reaching to end of muzzle. The muzzle is as long as the diameter of the eye, and does not project beyond the lips; nostrils terminal. The fingers are one-third webbed, the thumb free, and at least as long as the short third (second) digit. Hallucal tubercle minute; pallets well developed.

Color above and below yellow; pigment more conspicuous on edges of eyelids. No markings of any kind, except that one specimen is covered above with rather distinct, minute, black specks.

Total length, 22 mm.; length of head to canthus oris, 6 mm.; width at do., 8 mm. Length of anterior limb, 13.5 mm.; do. of anterior foot, 6 mm.; do. of posterior limb, 36 mm.; do. of hind foot, 15 mm.; do. of astragalo-calcaneum, 7 mm.

No. 252, Alajuela, R. Alfaro; 492, San José, P. Biolley.

This small and brilliant species is related distantly to the *H. platycephala* Cope, from the West Coast of Mexico. In that species the canthus rostralis and the tympanum are well marked, and the size is larger.

Lithodytes euryglossus sp. nov.

A large species with small pallets, in which the heel does not reach the end of the muzzle, although it extends to a point anterior to the eye. General appearance that of a *Leptodactylus*. No distinct canthus rostralis; end of muzzle sloping backwards from lip-border. Tympanic disc a vertical oval, of which the long diameter is two-thirds that of the eye. Nostril nearer the end of the muzzle than its distance from the orbit. Tongue wider than long, openly notched posteriorly. Choanæ moderate. Vomerine teeth in two transverse series, on transverse ridges whose anterior borders are in line with the posterior borders of the choanæ, and whose external borders are a little within the internal borders of the choanæ. Ostia pharyngea larger than choanæ. Pallets distinct but small, smallest on the manus. Digits without dermal margins. First and second fingers

equal. Integument everywhere smooth. A discoidal abdominal fold. A fold on the distal half of the external border of the tarsus, extending to a rather prominent prehallucal tubercle.

Color above, brownish lead-color; below whitish. Groin reticulate, and sides punctate with the dorsal on the ventral color. Four brown spots on the upper lip anterior to the line of the tympanum, and a black streak above and behind the tympanum. A blackish cross-band between the posterior parts of the orbits, and some black longitudinal spots on the dorso-lateral region, bounding upwards the paler color of the sides. Limbs with obscure blackish cross-bands. Thighs behind, whitish at base, and obscurely reticulate on the superior and distal portions. Limbs below, and gular region, clouded.

Total length of head and body, 75 mm.; do. of head to line of canthus oris, 19 mm.; width of head at do., 28 mm. Length of anterior limb, 40 mm.; do. of head, 18 mm.; do. of posterior limb, 115 mm.; do. of hind foot, 50 mm.; do. of astragalo-calcaneum, 20 mm.

This is the largest species of *Lithodytes*, but it is less robust than the *L. gulosus* Cope. In general appearance it resembles one of the large species of *Leptodactylus*, but it is a true Hyloine, with T-shaped terminal phalanges. It has some resemblance to *L. melanostictus*, but that species has much longer hind limbs, larger pallets, an oval tongue, etc. A single specimen of the *L. euryglossus* is in the collection, which was taken at San José, by Sen. P. Biolley (No. 448).

Levirana vibicaria gen. et sp. nov.

Char. gen.—Identical with *Ranula*, but without vomerine teeth.

Char. specif.—Form robust, muzzle short, wide; hind limbs rather short, the heel reaching to the front of the eye. Canthus rostralis strongly marked, angulated at the nostril, anterior to which it is deflected to the apex, which does not project beyond the lip-border. Loral region slightly concave; nostril nearly on canthus, $\frac{1}{6}$ the length of the muzzle anterior to the orbit. Tympanic drum sub-round, about $\frac{1}{7}$ the diameter of the eye-slit. Choanae rather small, about equal to ostia pharyngea. Tongue large obovate, deeply emarginate posteriorly. Digits with slight terminal enlargements; those of the fingers scarcely distinct, those of the toes supported by elongate T-shaped phalanges. Second (first) finger a little shorter

than third (second); inferior tubercles inconspicuous. Toes half-webbed, fourth digit with three, the others with two free phalanges. Sole with one tubercle, the flat oval præhallux. Integument smooth everywhere. A wide glandular body connecting rictus oris and humerus; a glandular thickening extending from orbit to end of urostyle, which is unusually wide between the orbit and the sacrum. No dermal folds.

Color above a dark olivaceous gray; side of head and a stripe from orbit to urostyle, black. Two rows of small black spots on each side of the vertebral column. Superior side of limbs colored like the back. Inferior surfaces of the body yellowish, more distinctly yellow on inferior surfaces of hind limbs. Concealed surface of femur with a reddish tinge, unspotted. Superior face of femur with a black stripe on the distal half. Lips unspotted, with a dark shaded border.

Length of head and body 65 mm.; do. of head to rictus oris 21 mm.; width of head at rictus oris, 25 mm.; length of fore limb, 40 mm.; of hand, 15 mm.; length of hind limb, 101 mm.; of hind foot, 49 mm.; of astragalo-calcaneum, 16 mm.

No. 3912, Rancho Redondo on the divide of the Irazu Range; 3915-6, Isla Nueva near the head of the Rio Sucio, on the Atlantic side; all taken by G. K. Cherrie.

This distinct species is probably an inhabitant of the elevated mountain region, and it has so far escaped the observation of collectors, who have mostly explored lower elevations. It is not nearly related to any species hitherto known.

REPTILIA.

LACERTILIA.

Cnemidophorus amivoides sp. nov.

Eight abdominal rows of subequal plates; a row of plates at the gular fold, which, with a few granules form its border. A group of about 18 enlarged posterior gular scales, which does not have a transverse posterior border separating it from smaller scales. Nostrils in nasal suture. Three supraorbitals, a small plate occupying an angular space between the second and third, at the external edge on both sides. Two interparietals and one parietal, followed by three rows of smaller plates. Five infralabials in the second (large) row. Sixteen femoral pores. Four preanal plates larger than those sur-

rounding them, two of them transverse and posterior, and two longitudinal and anterior. Three rows of brachial plates, the anterior continuous with the posterior of two rows of antebrachials. No postantebrachials. Four rows of plates on inferior side of femur at middle, and two rows on inferior side of tibia.

Color above dark brown, with three narrow yellowish stripes on each side, which proceed respectively from the temple, and from the superior and inferior borders of the tympanum. The inferior stripe is more or less broken into elongate spots. The space between the superior and median stripes is marked by black cross-bars, and a row of black spots extends along the inner side of each of the superior stripes. A light stripe on the posterior face of the femur, which is continued on the tail. Below this stripe on the femur, another less perfect stripe, and above it a longitudinal row of spots. Tibia with small light spots. Upper surface of femur and tibia brown, blackish varied. Inferior surfaces pale greenish-blue; top of head light brown.

Length of head and body, 64 mm.; length to edge of gular fold, 21 mm.; do. to auricular meatus, 15 mm.; width of head at rictus oris, 11 mm. Length of fore limb from axilla, 21 mm.; length of fore foot, 10 mm.; length of hind leg from canthus ani, 45 mm.; do. of hind foot, 24 mm.

This species resembles very much the younger specimens of the *Amiva undulata*, but is a true *Cnemidophorus* with sagittiform tongue. It differs in specific characters from both that species and the *A. quadrilineata*, in the possession of three rows of brachial scuta, instead of one. In coloration it differs from the young striped stages of those species in having three light stripes on each side instead of two. The longitudinal division of the interparietal plate is a marked peculiarity, but may be abnormal. The two plates together, however, are larger in dimensions than a single interparietal. Among *Cnemidophori* it is nearest to the *C. lemniscatus* in appearance, but it differs in almost all points of squamation of the head and throat.

No. 236, La Carpintera; A. Alfaro.

Cnemidophorus alfaronis sp. nov.

Allied to *C. deppei*. Nostril entirely in nasal plate; first loreal bordering first three labials; second loreal higher than long. Supra-orbital plates four on one side, and five on the other, the first quite

small, the third and fourth broader than long. Interparietals and the single parietals, longer than the frontoparietals. Infralabials eight; median gulars enlarged all the way across, graded; scales of mesoptychium large, in two or three rows, no granules on the border. Abdominal plates in eight rows; large brachials in six rows, continuous with brachials; no postantebrachials. Six rows of femorals at middle. Femoral pores nineteen. Preanal plates about a dozen in a triangular patch continuous with the ventrals. Extended hind foot reaches to orbit.

Four white lines on each side, and a vertebral line. Spaces between first and second, and dorsally between fourths of opposite side, greenish-gray; space between second and fourth, black. Head paler; below greenish-white. Posterior limbs with four irregular longitudinal lines; one anterior, two superior, and one posterior.

Total length, 170 mm.; length to vent, 55 mm.; do. to collar, 19 mm.; length of fore limb, 20 mm.; do. of hind limb, 41 mm.; do. of hind foot, 23 mm.

This species resembles in general appearance the *C. deppei deppei*,¹ but the scutellation is materially different. An important character is the presence of four supraorbital plates, from the last of which a fifth may be cut off. The parietals and interparietals are also relatively longer than in that species.

No. 216, San Mateo; found by Sen. Anastasio Alfaro, Director of the Museo Nacional, to whom the species is dedicated.

Celestus cyanochloris sp. nov.

Scales in thirty-three longitudinal series all with about a dozen longitudinal keels, and no prominent median keel, except on the tail, beyond the base. The scales of the tail are roof-shaped, so that the lateral edges run in open furrows, while the middle line is prominent. The striations extend not only to the head, but the parietal and interparietal plates are grooved and ridged. The rostral and symphyseal plates are of equal width. Two postnasals, two prelores and two postlores, one above the other in each pair. A large preocular; two suboculars, the posterior elongate, and four postoculars. Four external, and four internal supraorbitals. Parietals wider than the triangular interparietal, each three times as large

¹ For definition of the subspecies of *C. deppei*, see Transac. Amer. Philos. Soc., 1892, p. 30.

as the well-separated frontoparietals, and bounded by five scales between the frontoparietal and the single transverse postparietal. Frontal twice as wide as long. Eight superior labials to end of long subocular, the second reaching to the middle of the postnasal only. Auricular meatus horizontal, shorter than eye fissure. Extended limbs separated by the length of the anterior foot only.

Color above light golden-green, with several indistinct longitudinal rows of paler spots as large as a scale, mingled with as many brown spots as large as a scale. Sides paler than back. Lower surfaces blue, paler on chin and tail.

Total length (end of tail lost), 151 mm.; do. to vent, 70 mm.; do. to line of axilla, 16 mm.; do. of fore limb, 16.5 mm.; do. of hind limb, 22 mm.; of hind foot, 11 mm.

This species is allied to the *C. steindachnerii* Cope. The latter has seven superior labials instead of eight, of which the second reaches the loreal, as it does not in *C. cyanochloris*; the postnasals are much shorter. The scales of the anterior regions and parietal plates, are smooth, and the color is totally different. The limbs are shorter.

This handsome species, whose coloration is unique in the genus, was found by Sen. Juan Cooper, on the volcano of Irazu, No. 217.

OPHIDIA.

ASINEA.

Trimetopon pliolepis sp. nov.

In the genus *Trimetopon* Cope, I find that the hemipenis has a simple sulcus spermaticus, and that the apex for a space on each side of the sulcus is feebly calyculate. The rest of the surface is occupied by spines which are in longitudinal series, and are largest opposite the sulcus at the lower part of the hemipenis. The genus is then to be regarded as one of the Colubrinæ allied to *Contia*. A single species, the *T. gracile* Gthr., has been described hitherto, which is also from Costa Rica. I only know it from the description and figures of Günther in the Annals and Magazine of Natural History for 1872, p. 16.

Char. specif.—Scales in seventeen rows, like the plates of the head with iridescent refulgence and without fossæ. Rostral plate not visible from above; internasals much wider than long; anterior border of frontal slightly convex forwards. Lateral border of frontal

shorter than the parietal border, which forms less than a right angle with that of the opposite side. Loreal longer than high; oculars 1-1, the anterior well separated from frontal by superciliary. Temporals 1-1; superior labials eight, fourth and fifth entering orbit, all longer than high except the eighth. Inferior labials eight, fifth largest, and in contact with postgenial. Postgenials half as long as pregenials. Total length, 287 mm.; of tail, 76 mm. Gastrosteges, 154; anal 1-1; urosteges 69.

Dark brown above, the scales with a paler, minutely speckled center, except those of the third row. This, together with the more restricted pale centers of the scales of the first and second rows, gives the appearance of a dark lateral band, which tips the gastrosteges. Below uniform yellow. A narrow yellow collar borders, and does not cross the extremities of the parietal plates. Each upper labial with a large yellow spot next the border; that at the top of the sixth and front of the seventh has the effect of a postocular band.

This species differs from the type in the scale formula. In the *T. gracile*, the scales are in fifteen rows; the oculars are 1-2, and there are but seven superior labials. The coloration is more obscure.

No. 451, San José, P. Biolley.

***Drymobius paucicarinatus* sp. nov.**

Scales in seventeen rows, the five median only keeled, and that faintly. Oculars 1-2; preocular not reaching frontal; loreal subquadrate, longer than high. Temporals 1-2; four and a half scales bordering each parietal. Superior labials nine, fourth, fifth, and sixth in orbit; eighth and ninth longer than high. Eye large, its diameter equaling length of muzzle from its border to the nostril, and equaling a little over half of the interocular width; equal also length from rostral to frontal plate; equal length of frontal plate, and exceeding a little the length of the common parietal suture. Frontal plate wide in front, contracting rapidly posteriorly, lateral borders very little concave. Ten inferior labials. Postgenials longer than pregenials. The scales are not much narrowed, and those of the sides are rather wide. Total length, 1,230 mm.; tail, 415 mm.; length to canthus oris (axial) 26.5 mm. Gastrosteges 183; anal 1-1; urosteges, 127.

Color above brown, without markings; below yellow; ends and a

narrow transverse line near base of gastrosteges, lead colored. Upper lip, except upper parts of Nos. 2-3-4, 8 and 9, yellow.

No. 116; *La Candelaria*, Bruno Carranza.

This species is allied to the *D. percarinatus* Cope (Proceeds. Amer. Philos. Soc., 1894, p. 344), but differs in the much smaller number of more feebly keeled scales; in the shorter and wider head, and in the coloration.

Dr. Günther has united under the head of the *Dendrophidium dendrophis* (*Drymobius dendrophis* Schl., Fauna Centrali-Americana, 1894), the species *Drymobius chloroticus* and *Crossanthera melanotropis* Cope. Bocourt has pointed out that the genus *Dendrophidium* differs from *Drymobius* in the entire anal plate and I have not found any variability in this respect in the specimens at my disposal. In the *D. dendrophis* the eye is larger, its long diameter exceeding the width of the superciliary and frontal plates together; while in the species mentioned above, and the *D. percarinatus* and *D. rhombifer* Pet., the diameter of the eye either equals the width of those plates, or, more frequently is considerably less. The *Crossanthera melanotropis* further differs in the short occipital plates, whose middle suture is considerably less than the diameter of the orbit, while it is the same in the *D. dendrophis*.

***Leptophis ultramarinus* sp. nov.**

The relation of this species to those already known may be shown in the following table. I mention here that a study of the species shows that it is impossible to keep apart as a separate genus (*Philothamnus*) the species with smooth scales.

I. Scales all smooth.

Nine superior labials. Scales above blue tipped with golden; scuta and two inferior rows of scales golden with green bases; no stripes, *L. ortonii* Cope.

II. Three median rows smooth, two or three on each side keeled.

Eight supralabials; green, with black median lines on two or three dorsal rows of scales; pale oblique cross-lines on the anterior half of the body, *L. surgii* Fisch.

III. Five median dorsal rows keeled.

Eight supralabials; above uniform ultramarine blue; below and one and a half rows of scales, with upper lip, silvery,

L. ultramarinus Cope.

IV. Eleven to thirteen rows of scales keeled.

Supralabials eight or nine; silvery with a wide blue dorsal band; sometimes obscure in alcohol; smaller, *L. ahætulla* L.

Supralabials nine; robust; uniform green; smaller,

L. occidentalis Gthr.

Supralabials nine; green, head plates and scales all black bordered,

L. marginatus Cope.

Supralabials nine; uniform green, the keels of the scales, except those of the median row, black; size large, *L. præstans* Cope.

The *L. ultramarinus* is further characterized by the large size of its eye, whose diameter equals the length of the muzzle to the rostral plate, exclusive. The preocular reaches the frontal. Temporals 1-2, the anterior in contact with the inferior postocular only. Each parietal is bounded by only three plates, with half of a median plate. Seventh and eighth superior labials longer than deep. Nine inferior labials, in contact with the genials up to the seventh. Postgenials a little longer than pregenials. General form slender, tail long, about one-third the total length, gastrosteges feebly angulated, 168; anal, 1-1; urosteges, 176. Total length, 1050 mm.; tail, 425 mm.

Besides the colors above described there may be added, that the preorbital labials are bordered with blue above, and the last two labials are entirely blue. There are no stripes or lines of any kind.

No. 108, Pazo Azul; J. C. Zeledon.

Pogonaspis ruficeps gen. et sp. nov.

Char. gen.—Posterior maxillary tooth elongate, grooved; other teeth numerous, small, present on the usual bones of the mouth. Pupil round. Cephalic plates normal; two nasals, no loreal. One pair of genials; anal plate and urosteges double. Scales smooth, without apical fossa, extensively imbricate. In the hemipenis the sulcus spermaticus is single, and the apex is calyculate. On the side opposite the sulcus is a wide welt which is bordered by spines, whose bases are connected by transverse flounees. Surface on each side of welt coarsely spinous.

This genus is probably more nearly allied to *Tantilla* than to any other. The head of the only known species is rather more distinct than is usual in that genus. The tail is probably elongate. It differs from *Tantilla* in the large single genial plate.

Char. specif.—Rostral plate rounded obtuse, visible from above; internasals small; prefrontals large, descending laterally and touching second superior labial. Frontal elongate, slightly angulate in front, acute posteriorly; parietals elongate. Nostril in posterior part of prenasal; postnasal elongate, separated from preocular by suture between prefrontal and second labial. Oculars 1-2, preocular well removed from frontal; temporals 1-1, superior labials seven; the first bounds the postnasal below; the second the prefrontal and the preocular; third and fourth enter orbit; fifth and sixth lower than the large seventh. Inferior labials only six; those of the first pair in contact behind the symphyseal; the fourth elongate, terminating opposite the end of the long genial. Gastrosteges, 146; anal, 1-1; urosteges, 20 + (a considerable part of the tail lost). Length to vent, 223 mm.; do. to rictus oris, 9 mm.

Color in alcohol, above light brown, below yellow. Median dorsal row of scales deep brown; a narrow yellow line on the adjacent borders of the third and fourth rows of scales which is bounded above by a single dark brown row, and below by several rows with dark brown centers, growing paler towards the gastrosteges. All the colors are less conspicuous posteriorly. Upper surface of head light reddish-brown, with a pale spot at the extremity of each parietal plate. Upper lip yellow, with a black spot below eye; lower labial plates with brown borders; gular region unspotted.

No. 141, Jimenez; A. Alfaro.

Enulius torquatus Günther. *Leptocalamus torquatus* Günther. Ann. Mag. Nat. Hist., 1872, p. 16.

This specimen gives me the opportunity of examining the hemipenis of this genus. I find that it is undivided, but that the sulcus is bifurcate near the extremity. The surface of the organ is marked with longitudinal laminae only, and these are set with numerous small spines to the apex. The laminae are separated by deep grooves.

As already described by me, there are very few teeth in the mouth. These consist of a few small ones at the posterior part of the maxillary bone, with one or two near the junction of the palatine and pterygoid, and a few on the anterior half of the dentary. The large posterior tooth is incurved and flattened, and has a thin blade with a cutting edge posteriorly. The groove is fine if present. This arrangement reminds of the characters of the genus *Elachistodon*² Reinhd., of

² American Naturalist, 1893, p. 477.

which the sole species is found in the Paletropical Realm. The few teeth of *Enulius* are, however, better developed than in *Elachistodon*, whose real affinities are as yet uncertain. *Enulius* is probably allied to *Seytale*, since it not only enters the Seytalinæ, as defined in my paper on the characters of the hemipenis, but in the prominent rostral plate it resembles the *S. neovidii* D. & B.

JULY 3.

MR. CHARLES MORRIS in the chair.

Twelve persons present.

JULY 10.

MR. CHARLES MORRIS in the chair.

Eighteen persons present.

A paper entitled "Third Addition to a Knowledge of the Batrachia and Reptilia of Costa Rica," by E. D. Cope, was presented for publication.

JULY 17.

MR. CHARLES MORRIS in the chair.

Ten persons present.

JULY 24.

MR. CHARLES MORRIS in the chair.

Sixteen persons present.

The death of Samuel L. Smedley, July 21, 1894, was announced.

Papers under the following titles were presented for publication:—

"Patella Kermadecensis," by H. A. Pilsbry.

"A Contribution to the Life History of the Allegheny Cave Rat, *Neotoma magister* Baird," by Samuel N. Rhoads.

JULY 31.

MR. CHARLES MORRIS in the chair.

Eleven persons present.

The following were ordered to be printed:—

PATELLA KERMADECENSIS.

BY HENRY A. PILSBRY.

In October, 1893, the writer received from E. W. Roper, Esq., of Revere, Mass., two specimens of a very large and ponderous species of *Patella*, which Mr. Roper had obtained from a New Zealand collector, to whom they had been brought from the Kermadec Islands.

Upon comparing these shells with the collection of Patellidæ in the Museum of the Academy, and with the recent monograph of the group in the Manual of Conchology, it became evident that they represented an undescribed species. At Mr. Roper's request, a brief description was prepared for publication, which some months later appeared in the "Nautilus," under the name *Patella kermadecensis*. After this description was printed, but before the number containing it was generally distributed, the writer (in his capacity as Editor of the "Nautilus"), received a description of the same species, *under the same name*, from Dr. Wm. H. Dall, the distinguished malacologist of the National Museum. As Dall's specimens are more depressed than those described by myself, and his series includes young shells preserving the sculpture, I have therefore, quoted his description in full below, and have reproduced drawings of his type, kindly supplied by him, on plate VII.

Some time previous to the publication of the original description, Mr. Geo. W. Taylor of Victoria, B. C., a gentleman who has devoted special attention to the Patellidæ, received specimens of the same species, apparently from the same original source. He prepared a description of them, but not being thoroughly satisfied of the novelty of the form, delayed publication.¹

The species has also been noticed by Mr. John Brazier, well-known for his life-long labors on the Australian mollusca. Mr. Brazier formed a theory that these limpets were not from the Kermadec Islands, but from South Africa; and as the specific name *kermadecen-*

¹ Mr. Taylor submitted one of his young shells of this species to the junior editor of the "Nautilus," who showed it to me. I did not recognize in it the *P. kermadecensis*, so different are the young from the ponderous, corroded adult shells which alone I had seen.

sis would in that case be a misnomer, he proposed to re-name the form *Patella Pilsbryi* Brazier.² Since Mr. Brazier has given no proof whatever in support of his hypothesis, and as we have every reason to believe it without foundation in fact, the necessity for this proposed change of name is not apparent.

In support of the original statement that *P. kermadecensis* inhabits the Kermadec Islands, I am now able to quote the following passages from a letter³ received from my friend Charles Hedley, of the Australian Museum:—

“There can be no doubt that it [*P. kermadecensis*] really inhabits the Kermadecs.

“Mr. Charles Spencer, of Auckland, a leading New Zealand collector, has just given me a most circumstantial account of it. He says a great number were collected at the orders and by the crew of Capt. Fairchild, of the government steamer “*Hinemoa*,” while on an official visit to Raoul, or Sunday Island, the principal island of the group. Most of these passed into the hands of Mr. Eric Craig, a natural history dealer of Auckland, who distributed them to various correspondents throughout the world.”

The literary history of this species is thus seen to have been much more extensively exploited than its natural history. The references to the books are as follows:—

Patella (Scutellastra) kermadecensis Pilsbry, *The Nautilus*, vii, p. 106 (Feb. 1894).

Patella kermadecensis Taylor, *tom. cit.*, p. 142.

Patella kermadecensis Dall, *MS.*, Jan. 1894.

Patella pilsbryi Brazier, *Abstract of Proc. Linn. Soc., N. S. Wales*, meeting of April 25, 1894, p. iii.

P. kermadecensis may be compared with two previously described species, *P. gigantea* Lesson, and *P. pica* Reeve. The former is, I do not doubt, quite distinct. The original description, by which alone it is known, is as follows:—

“*Patelle Gigantesque. Patella gigantea* Less.—Cette coquille très-fruste en dessus n'avait pas moins de 7 pouces de longueur sur 5 de largeur. Sa forme est massive, très-épaisse, ovulaire, convexe, à sommet submédian, à limbe ovale allongé, plus dilaté en arrière. L'animal doit être énorme, car il laisse à la voûte de la face interne

² *Abstract of Proc. Linn. Soc., N. S. Wales*, April 25, 1894, p. iii.

³ Written under date of June 18, 1894.

une impression très marquée, que borde une profonde dépression en fer à cheval. Le limbe est simple, épais. L'intérieur est lisse, blanchâtre, avec le fond rougeâtre. Sa face supérieure était rougée et couverte de tubes de serpules.

“ Nous trouvâmes cette grande coquille jetée sur les rochers de corail de l'île de Borabora, dans l'archipel de la Société.”⁴

The dimensions given by Lesson, 5×7 inches, indicate a much more oblong shell than any known specimens of *kermadecensis*, and the coloring of the interior differs also. The difference in outline may be most readily appreciated by plotting an ovate contour with the axes 5×7 inches, and comparing with a contour of *kermadecensis*.

P. pica Reeve, if it is the same as *P. kermadecensis*, is a very young specimen. The description and illustrations may be found in Reeve's *Conchologia Iconica*, vol. viii, pl. xix, figs. 45 *a-c*. The type, if still preserved, is in the British Museum, and should be compared with young specimens of *kermadecensis* of the same size.

The types of *P. kermadecensis* may be described as follows:—

Shell large, thick and heavy; round-ovate, slightly narrowed in front, broadly rounded behind, conical, the apex central. Altitude of cone nearly equal to half the breadth of the base, but decidedly less than half the length; slopes straight. Surface dull and much corroded by various parasitic growths, calcareous algae, and young *Patellas*, apparently of the same species, leaving but little of the original sculpture, which seems to have consisted of numerous rather low, radiating ribs, the interspaces and ribs covered with a secondary sculpture of radial riblets.

Interior whitish, more or less tinted with gray or dull reddish; the muscle impression and the edge of the shell either white or deep salmon colored. Border of shell slightly crenulated by the external sculpture. Muscle-impression strongly marked, roughened, and either impressed, or thickened and like a shelf or terrace.

Dimensions of two specimens:—

Length 136,	breadth 116,	altitude 55 mm.
“ 119.5,	“ 104,	“ 50 “

These shells are decidedly more elevated than the examples in the collection of Mr. Taylor, who writes as follows:—

“ My suite of *kermadecensis* consists of two full-grown shells and a

⁴ Voy. de la Coquille, Zool., II, p. 423, 1830. See, also, *P. crassa* Lesson, *ibid.*, p. 413, said to be from New South Wales.

series of twelve others ranging from 75 mm. down to 6 mm. in length. The large ones are respectively 130 x 109 x 41 mm. and 130 x 109 x 34 mm., being both considerably flatter than the specimens described by Mr. Pilsbry.

“All my specimens are distinctly narrowed in front, and in this particular the species differs essentially from *P. patriarcha*, which is very round in outline. I have a specimen of *patriarcha* exactly the same *width* as the two shells above mentioned, namely, 109 mm., but its *length* is only 119 mm. Our species is further distinguished by its sculpture from both *patriarcha* and *mexicana*—the ribs being narrower and much more numerous than in *patriarcha* and decidedly heavier than in *mexicana*. Every 5th or 6th rib in the adult shell seems to be more prominent.”⁵

Dr. Wm. H. Dall's description of younger and less eroded examples than the types, here follows:—

“*Patella (Helcioniscus?) kermadecensis*. *Soft parts* unknown, but the aspect of the shell is that of a *Helcioniscus*.”

“*Shell* large, depressed or only moderately elevated, porcellanous, radiately sculptured, with the apex of the shell slightly anterior to the center, erect, blunt (or eroded); color outside orange-yellow, sometimes more or less scorched with purplish-black, obscurely concentric or radiating in its disposition, frequently asymmetrical; inside polished opaque-white, cream color, or even orange color, with a very narrow colored margin of orange, white, or black, following the tint of the exterior; the muscular impressions not polished, sometimes darker orange than the rest, the enclosed area usually much the same color as that outside the scars, but sometimes lighter or with faint brown or flesh colored stains irregularly distributed; muscular scars catenate, not symmetrical, with about seven segments on each side; an obscure line, probably indicating the scope of the mantle is visible within the colored margin and this is emphasized to the left of and in front of the head, where a strongly marked sinus extends toward the apex close to and in front of the left arm of the pedal scar and ceasing at the junction of the latter with the scar of the mantle over the head; this is distinctly indicated in all the specimens but is less prominent in the younger specimens, and recalls the sinus of *Gadinia* though on a much larger scale; the margin of the shell is rendered slightly irregular by the sculpture, and is, as usual, some-

⁵ Nautilus, April, 1891, p. 112.

what more so in the young than in the adult; external sculpture of small, somewhat irregular rounded riblets, with equal or wider interspaces, each third (fourth, fifth or sixth) riblet being somewhat larger and more elevated than the others and often duplex; of these larger ribs there are twenty or less on each side; all the ribs are normally rounded, and except where obviously broken by accidents due to exigencies of growth, do not appear scaly or nodulous, though sometimes more or less keeled; basal outline, apart from sculptural crenulations, approximately oval, the anterior always narrower than the posterior end. Lon. of shell 135; Lat. 112; Alt. 33 mm. The distance from the apex to the anterior margin, horizontally, 63 mm.

“Some specimens are over six inches in length and proportionately solid. The species seems to be one of the largest limpets known. Although the nearest land is New Zealand, the shell has none of the aspect so characteristic of the limpets of that region, but recalls rather those of East Africa and the China seas. *Patella patriarcha* Pilsbry, has much the same general aspect, though the sculpture is wholly different. *Patella barbara* L. has the discrepancy between the primary and secondary radii much greater, and the margin consequently stellate. The sinus near the anterior left hand margin is not confined to this species but may be found in many Patellidæ; still, few species have it so strongly emphasized as in *P. kermadecensis*. Its origin is doubtful, and can be cleared up best by a study of the living animal. The larger specimens are usually badly eroded, only the younger ones show the surface well, and the islands (we understand from Mr. Fulton, from whom the specimens were received) are visited but once a year. These circumstances may account for the overlooking of so large a shell by untrained collectors.”

EXPLANATION OF PLATES.

PLATE VII.

(Illustrating Dr. W. H. Dall's description of examples in National Museum Collection).

Fig. 1. *P. kermadecensis*, dorsal aspect.

Fig. 2. *P. kermadecensis*, ventral aspect.

PLATE VIII.

Dorsal and lateral views of type specimen of *P. kermadecensis*, nearly natural size.

A CONTRIBUTION TO THE LIFE HISTORY OF THE ALLEGHENY CAVE
RAT, *NEOTOMA MAGISTER* Baird.

BY SAMUEL N. RHODES.

In 1857, Prof. S. F. Baird described a fossil *Neotoma* from the bone caves of Pennsylvania in a final paragraph under caption of *Neotoma occidentalis*, on page 498 of his work on the Mammals of North America. It reads: "The bone caves of Pennsylvania have furnished me with several lower jaws of a fossil *Neotoma* considerably larger than the largest specimen even of any recent species which I have seen. The body could not have been less than twelve inches in length; it differs from the others in the wider and more massive molars, the lobes of which are all more nearly equal than in the rest, and all rounded, not angular. The inner and outer sides of the molars are very nearly symmetrical, and the indentations or folds of nearly equal depth. The axis of the condyloid process is quite oblique, and the condyle below the level of the coronoid. The species may be called *N. magister*."

In 1893 Mr. Witmer Stone received two specimens of a cave rat in the flesh from South Mountain, Cumberland County, Pennsylvania, taken at an elevation of 2,000 feet, at a point known as Lewis's Rocks, about six miles from the village of Pine Grove in the same county. These he described¹ under the name *Neotoma pennsylvanica*, making no comparisons in the description between his new species and *N. magister*, the type specimens of which came from a valley cave about 20 miles distant from Lewis's Cave. Since then a large series of "fossil" specimens of *N. magister*, included among the complete collections from Hartman's and Durham Caves, and on which Prof. Joseph Leidy based his paper on "Fossils in Caves and Crevices of the Limestone Rocks of Pennsylvania,"² have been found stowed away in the Museum of the Academy of Natural Sciences. Among them is a mandible of *N. magister*, labeled from "Harrisburg Cave," presented by the Smithsonian Institution, and no doubt from the type lot on which Baird based his original notice of *magister*. Besides

¹ Proc. Acad. Nat. Sci., Phila., 1893, p. 16.

² Rep. Penna. Geol. Surv., 1857, pp. 1-20.

these the Academy possesses another collection from Hartman's Cave, made last year by Mr. H. C. Mercer during his re-exploration of that cave,³ and containing among others the only extant cranium of *magister* in which the nasal bones are intact. There are also two alcoholic specimens of a cave rat from Wythe Co., Virginia, collected in 1868 by Prof. E. D. Cope. These, together with Mr. Stone's types of *N. pennsylvanica*, two stuffed skins of the same from the Pennsylvania Alleghenies, and an alcoholic specimen shown me from Mammoth Cave, Kentucky, by Mr. G. S. Miller, form the basis of my examinations respecting the relationships, distribution, and probable identity of *magister* and *pennsylvanica*. Prof. Leidy has enumerated the entire collections from these caves, among which he records "92 mandibular rami, 13 pairs of upper maxillæ, numerous limb-bones," etc., of "*Neotoma floridana*," which, he states, appear to accord with similar remains referred by Prof. Baird to a supposed extinct⁴ species with the name of *Neotoma magister*." Most of these still exist in the Academy. The Durham Cave material is more scanty, but includes a more complete cranium (No. 3,542) than any from the Stroudsburg Cave. This cranium lacks nasals, pterygoids, right squamosal, malar, and occipital bones, and is from a rat hardly one year old.

The subjoined table of measurements, in millimeters, of the best of this material, together with those of *N. floridana*, kindly furnished me by Messrs. H. H. & C. S. Brimley, may be considered ample enough for a critical comparison between the forms in question:—

³ Proc. Acad. Nat. Sci., Phila., 1894, p. 96.

⁴ Italics mine.

COMPARATIVE BODY AND SKULL MEASUREMENTS OF *Neotoma magister*, *N. pennsylvanica*, AND *N. floridana*.

Female Catalogue No.	Age	Total length.	Tail.	H. foot.	Ear (from crown).	Occipito-nasal length.	Zygomatic width.	Nasal length.	Interorb. Constr'n.	Mandib. length.	Mandib. width.	Alveolar length (lower molars).
3542	Yg. Ad.	<i>N. magister</i> , Durham Cave, Bucks Co., Pa. (Cranium; meas. approximate; sup. cit.)				50.5	26.5	20.2	6.8			
3543	Ad.	<i>N. magister</i> , Hartman's Cave, Monroe Co., Pa. (Perfect right mandible.)								34	16.5	10
3544	Ad.	<i>N. magister</i> , Hartman's Cave, Monroe Co., Pa. (Perfect left mandible.)								33.2	16.5	9.7
3545	Ad.	<i>N. magister</i> , Hartman's Cave, Monroe Co., Pa. (Perfect right mandible.)								33.9	16.3	9.6
3546	Ad.	<i>N. magister</i> , Hartman's Cave, Monroe Co., Pa. (Perfect left mandible.)										9.9
3546	Ad.	<i>N. magister</i> , Harrisburg Cave (Cumberland Co., Va.) (L. Mand.; cold and ang. broken.)				54	28.5	21.5	7	30.9	15.3	9
3547	Ad.	<i>N. magister</i> , (Cave) Austinville, Wythe Co., Va. (In alcohol)	400	181	41.5	54	28.5	21.5	7	30.5	14.6	9.5
3548	Ad.	<i>N. magister</i> , (Cave) Austinville, Wythe Co., Va. (In alcohol, not fully ad.)	375	167	40	51.2	25	20	7			
1001	Ad.	<i>N. magister</i> , Allegheny Mts., Pa. (Stuffed skin, tail docked; no skull.)	392	158	41							
156	Ad.	<i>N. pennsylvanica</i> , Lewis's Cave, Cumberland Co., Pa. (Type.)	403	185	41	54	27	21	6.6	30.5	14.5	9.4
157	Ad.	<i>N. pennsylvanica</i> , Lewis's Cave, Cumberland Co., Pa. (Dup. type.)	406	190	42	53	27	20	7	31	15.3	9.5
2533	Ad.	<i>N. floridana</i> , Southern States. (Skull.)				48.2	24.5	18.2	6	27.6	14	9
1127	?	<i>N. floridana</i> , Gainesville, Florida. (Skull; Amer. Mus., N. H. Coll., fide Stone.)				49.8	25.2	18.5	6.1	28.5	13.8	
1129	?	<i>N. floridana</i> , Gainesville, Florida. (Skull; Amer. Mus., N. H. Coll., fide Stone.)				50	25	18.9	7.3	27.5	12.2	
1542	Ad.	<i>N. floridana</i> , Hancock Co., Miss. (Very old specimen.)	400	183	38	50	25.2	20	6.2	28.7	13.8	9.2
1677	Ad.	<i>N. floridana</i> , Hancock Co., Miss. (Fide Brimley Bros.)	389	175	38							
1540	Ad.	<i>N. floridana</i> , Hancock Co., Miss. (Fide Brimley Bros.)	411	196	38							
1412	Ad.	<i>N. floridana</i> , Hancock Co., Miss. (Fide Brimley Bros.)	374	180	38							
1682	Ad.	<i>N. floridana</i> , Hancock Co., Miss. (Fide Brimley Bros.)	404	195	41(?)							

Prof. Baird's description of *magister* aims to distinguish it from all forms of the genus known to him by its large size and massive, rounded molars. So far as I have examined the species of *Neotoma* now known, and which number five times as many as were recognized in Baird's day, I find *magister* to be somewhat larger than any other. It has a comparatively short tail, but the length and girth of body considerably exceeds that of other species whose total length may average more than in a series of *magister*. It is a satisfaction to thus confirm the appropriateness of Baird's specific name. As to its cranial characters, *magister* presents us with the largest skulls I have examined in this genus, but the comparative size and shape of the molars as given by Baird cannot be said to be diagnostic. It is probable when Prof. Baird made these comparisons he only possessed specimens of old individuals, in which this peculiarity of the molars is always apparent, and does not vary to any great extent among specimens of *N. fuscipes*, *floridana*, or *cinerea* of same age, and is of the same general character in all. The same may be said of the folding and indentations of the enamel in very old specimens. Younger specimens of *magister*, both fossilized and recent, show a very close resemblance in their molar dentition to *floridana* and *cinerea* of same age. The incisors and rostral portion of the skull in *magister*, however, are much wider and heavier than in any other *Neotoma* I have seen. Compared with *N. floridana* (to which *magister* both physically and geographically shows the closest alliance) it may be noted from the table of measurements that the recent and fossil crania of the cave rat are much larger than in the wood rat. In superficial proportions the difference is less apparent, but in the following particulars their divergence is constant and specific:—

1. The post-palatal notch of *magister* is acuminate, often sharply so, at other times bearing in its apex a minute, blunt point, directed posteriorly; in *floridana* the post-palatal margin is broadly and evenly rounded or nearly square cut between the opposing last molars, the pterygoids being more divergent and relatively shorter.
2. In *magister* the slits separating the palatal from the sphenoid bones are often nearly ankylosed; in *floridana* they are more widely separated.
3. The interorbital depression and supraorbital ridges of the frontals in younger specimens of *magister* are very decided; in *floridana* nearly obsolete.
4. As above stated, the greater relative breadth of incisors, maxillaries, and nasals in *magister*.

Externally, *magister* is most conspicuously known from *floridana* by its densely hairy and sharply bicolored tail. This member is relatively shorter than in *floridana*, and the lateral divergence of the longer hairs gives it a depressed appearance, which is almost exactly reproduced in half-grown examples of the bushy tailed ash-colored rat of the northern Rocky Mountains. The correlation of development in this character and in the shorter ears, between animals of such widely separated but similar environments, both of which trace their ancestry to progenitors inhabiting a semi-tropical climate, is a significant fact. In body colors, *magister* is readily distinguished from *floridana* by its plumbeous grayness and lack of brown above, by the fulvous areas of opposing sides of lower hind neck reaching nearly across the throat, and by the blackish areas around the eyes and at base of whiskers.

It therefore appears that we have in *N. magister* a large cave rat, quite distinct from the wood rat of the Gulf States, and which, so far as existing remains are known to us at this date, is the same animal as *N. pennsylvanica* Stone.

As it now stands, however, the case is a peculiar one. The evidence in favor of making *pennsylvanica* a synonym is conclusive so far as it is based on known facts, but the impossibility of ascertaining the perishable external characters of those individuals whose fossilized remains formed the types of Prof. Baird's description, establishes a possibility that they represent an animal we would now consider separable from the living form. Were the specific peculiarities of the different members of the genus *Neotoma* based on cranial characters of constant value, the identity of *magister* and *pennsylvanica* would be clearly established by my examinations, but as yet they have not been so distinguished by anatomists. That it is probable good cranial characters can be formulated for the species of this genus deserving recognition, I feel confident. On this basis, as recently applied by Dr. Merriam,⁵ it is apparent to me that *pennsylvanica* will not stand as a specific name, nor can it, from the very nature of the case, be a candidate for sub-specific honors.

The points confirmatory of the identity of fossilized and living specimens of *N. magister*, already demonstrated by cranial characters, may be stated:—

⁵ Proc. Biol. Soc., Wash., 1891, pp. 117-128.

1. *Recent date of fossil remains taken in contact or direct association with Neotoma magister in Pennsylvania caves.*—While no data have been preserved as to the relative position in Hartman's Cave of the extinct *Dicotyles pennsylvanicus* and *Castoroides ohioensis* with respect to more recent remains, it is interesting to note that the following mammals, yet existing in America, were found in association and in precisely the same stages of recent or ancient preservation in the shallow upper layer of the cave floor:—

<i>Lynx canadensis.</i>	<i>Arvicola pinetorum.</i>
<i>Lynx rufus.</i>	<i>Sitomys americanus.</i>
<i>Urocyon cinereo-argenteus.</i>	<i>Neotoma magister.</i>
<i>Vulpes pennsylvanicus.</i>	<i>Areomys monax.</i>
<i>Canis lupus nubilus.</i>	<i>Sciurus niger cinereus.</i>
<i>Mephitis mephitis.</i>	<i>Sciurus carolinensis pennsylvanicus</i>
<i>Putorius ermineus.</i>	<i>Sciurus hudsonicus.</i>
<i>Procyon lotor.</i>	<i>Tamias striatus.</i>
<i>Ursus americanus.</i>	<i>Lepus sylvaticus.</i>
<i>Scalops aquaticus.</i>	<i>Lepus americanus.</i>
<i>Blarina talpoides.</i>	<i>Bison bison.</i>
<i>Adelonycteris fuscus.</i>	<i>Alces americanus.</i>
<i>Vespertilio gryphus.</i>	<i>Rangifer caribou.</i>
<i>Castor fiber canadensis.</i>	<i>Cariacus virginianus.</i>
<i>Fiber zibethicus.</i>	<i>Cervus canadensis.</i>
<i>Erethizon dorsatus.</i>	<i>Equus caballus.</i>
<i>Mus decumanus.</i>	<i>Homo sapiens.</i>
<i>Arvicola pennsylvanica.</i>	

2. *The Sonoran derivation of the Genus Neotoma indicates its comparatively recent post-glacial advent into North Temperate latitudes.*—Dr. Coues has attempted to trace, by the scant evidence then known to him, the probable derivation from *magister* of the four existing species of *Neotoma* recognized in the Monograph of North American Rodentia.⁶ The evidence now had, exactly reverses his hypothesis.

3. *The presence of living N. magister in the caves where fossilized remains of same occur in various stages of preservation and antiquity.*—*Magister* does not now exist in the Carlisle valley cave. It may have existed there in the early colonial days of Pennsylvania, or its life there may date back to a time when the crests of South Mountain,

⁶ Mon. N. Amer. Rod., 1877, 29, 30.

now infested by it, were yet in the loosening grip of the ice age. Mr. Paret writes me that he has no knowledge of the recent existence of a cave rat in Hartman's Cave. I have been told that such an animal is found among the cliffs and rocky crests of the Kittatinny range, on the opposite side of the Delaware River, in Warren Co., New Jersey.

4. *The lack of any trace of gnawing upon the bones of mammals, from Hartman's Cave, not now existing in America, as contrasted with the uniformly rat-eaten condition of the bones of those known to have inhabited Pennsylvania in the history of man.*—The specimens of *Dicotyles pennsylvanicus* and *Castoroides ohioensis* from Hartman's Cave are ungnawed, as is likewise the ramus of caribou there taken, while those of the beaver, elk, and bison, animals recently exterminated in Pennsylvania, show the unmistakable marks of a rat's teeth.

It, therefore, appears that the evidence, so far as we know it, tends only to establish the identity of the fossil *Neotoma* of Baird with the species now living in the same localities. On the other side the argument is purely presumptive, and if we admit a distinction (no differences being proven) between *magister* and *pennsylvanica*, the fossilized remains of foxes, wolves, beavers and other animals found in association with the rat bones in the Carlisle and Stroudsburg caves are as fully entitled to specific separation from their living Pennsylvania representatives as are the rats. No one, who would be unwilling to thus follow such a precedent to its logical conclusion, can consistently endorse the precedent. Had Prof. Baird been aware of the facts as we now know them, the question would never have arisen, or if it had, would have been decided in the case of the rat as it was decided in that of the fox and wolf and beaver.

Habits and distribution of Neotoma magister.—I paid a visit to Lewis's Rocks, the type locality of Mr. Stone's specimens of *pennsylvanica*, in the spring of 1893, for the purpose of obtaining some knowledge of the animal's habits. The rocks lie at the top of the mountain and form the culminating point of a rocky outcrop, topping the ridge for a mile or more in this locality, and which at intervals assumes a very rugged and castellated outline. The cave rats live in the more inaccessible fissures and clefts of these rocks, selecting for their dormitories those which are most secure from the approach or entrance of the predaceous animals which abound in such situa-

tions. The entrances and passageways to these abodes are loosely barricaded with sticks, stones, leaves, feathers, bones, horse and cow droppings, buttons, glass, tin, egg-shells, cartridge-cases, and other cast-away evidences of the sojourn of men and animals in this spot. Many of the sticks are three to four feet long and an inch in diameter, and must have required the concerted strength of several rats to move, and not a little ingenuity to convey up and over the precipitous clefts to their resting-place. The bones were those of deer, smaller carnivora, birds, and other animals brought thither by man and beast, or which had sought refuge among the clefts to die. I was unable, from the nature of their fastnesses, and lack of time and proper implements, to penetrate their dormitories, and owing to the pilfering foxes, lost the only specimens that got into my traps. One half-grown rat was seen running among the rocks. It was lighter gray than adult specimens. Quantities of gnawed acorn hulls strewed their hiding places, and were the chief evidences of the diet of this species. These acorns grow abundantly on the scrub oaks, *Quercus banisteri*, characteristic of these mountain tops. While its main food supply is vegetable, no doubt these rats are omnivorous, and take every opportunity to satisfy their carnivorous appetite. The gnawed condition of the bones of recent mammalia found in Pennsylvania cave deposits, is, to my mind, almost solely due to the work of this quadruped, a critical examination of these marks showing not only their rodent origin, but that their size and character fit no tooth so well as that of *magister*.

I am informed by Mr. H. C. Mercer (whose recent explorations of Virginia caves has been ably outlined in a Bulletin of the University of Pennsylvania, dated July 4, 1894) that the Virginia cave rats build a sub-globular nest of grass, etc., on the cave floor, and that these are so well made internally as to resist considerable kicking about. Prof. E. D. Cope, who secured the two specimens of *magister* tabulated above, from a cave in Wythe Co., Virginia, tells me that these nests are placed at or near the sides of the cave, and are often large enough to fill a bushel basket.

The habitat of living *Neotoma magister* cannot be verified by a representative series of specimens from connected localities, but from those now in possession, and the testimony of several of my correspondents in Pennsylvania and New Jersey, it is co-ordinate with the

Alleghenian Fauna, as restricted by Dr. J. A. Allen,⁷ and extends northward toward the Canadian Fauna as far as Potter County, Pennsylvania, in the west, and probably along the Blue Ridge to the Delaware River. It is possible that it may be found in northern New Jersey.

The specimens of *Neotoma* taken on the Hudson River, by John G. Bell, and mentioned by Baird in his work on mammals, are, apparently, from the table of measurements, large *N. floridana*.

It is doubtful if *N. magister* ever inhabited the State of New York, and the specimens taken by Mr. Bell were probably imported in a cargo of southern lumber.

Probably the earliest reference to the Allegheny cave rat in literature is made by the Swedish naturalist, Peter Kalm, in 1759, in his book of Travels, where he quotes John Bartram, of Philadelphia, as authority for the existence of such an animal in the "Blue Mountains." This reference is quoted by Pennant in his History of Quadrupeds, page 441, under caption of "American-Rat," as follows: "Mr. Bartram (in Kalm's Trav., ii, 48) mentions the rat, but does not determine the species, which lives among the stones and caverns in the Blue Mountains, far from mankind: comes out at night, and makes a terrible noise, but in very severe weather keeps silent within its holes." William Turton in his Systema Naturæ (1802, p. 80) enumerates an American rat to which he gives the name *Mus americanus*. His description is mainly a quotation of Pennant's account, above cited, of the same animal. Were not Turton's binomial antedated by the *Mus agrarius* var. *americanus* of Kerr (Syst. Nat., 1792, 231), now accepted as the first tenable name for the eastern white-footed mouse, *Sitomys americanus* (Kerr), it would have a strong claim, in the light of our present knowledge, to precedence over Baird's specific name, *magister*.

⁷ Bull. Amer. Mus. N. Hist., 1892, pl. viii.

AUGUST 7.

MR. JOHN G. ROTHERMEL in the chair.

Eleven persons present.

A paper entitled "Further Notes on the Embryonic Whorls of the Muricidæ," by Frank C. Baker, was presented for publication.

AUGUST 14.

MR. CHARLES MORRIS in the chair.

Thirteen persons present.

The death of George A. Binder, August 13, 1894, was announced.

AUGUST 21.

MR. LOUIS WOOLMAN in the chair.

Fourteen persons present.

Papers under the following titles were presented for publication:—

"A New Subfamily of Murine Rodents—the Neotominae—with description of a New Genus and Species, and a Synopsis of the Known Forms" by C. Hart Merriam.

"Descriptions of Four New Species and Two Subspecies of White-footed Mice from the United States and British Columbia," by Samuel N. Rhoads.

AUGUST 28.

DR. C. NEWLIN PEIRCE in the chair.

Seventeen persons present.

A paper entitled "Descriptions of Eight New Species of Pocket Mice (Genus *Perognathus*)," by C. Hart Merriam, was presented for publication.

The following were ordered to be printed:—

FURTHER NOTES ON THE EMBRYONIC WHORLS OF THE
MURICIDÆ.

BY FRANK C. BAKER.

In 1890 I described in these Proceedings (pp. 66-72) the embryonic whorls of a number of species of this most interesting family; and in the Proceedings of the Rochester Academy of Science (Vol. 1, 1891, pp. 129-133) I added several species to those already described. From that time until a few months ago, I was unable to find perfect material in any collection under my charge. Some months since, however, I discovered perfect specimens of *Murex troscheli* and *Eupleura caudata*, with the nuclei intact. Descriptions of these are given below:—

Murex troscheli, Lischke. (Fig. 1.)

The nucleus consists of two and a half smooth, glossy, hyaline whorls, gradually increasing in size; a carina begins at the apex and encircles the base of the whorls near the suture below; it terminates in the fourth spiral line of the after growth. There is a considerable varix at the junction of the nucleus with the after growth. The whorls succeeding the nucleus are crossed by four spiral, beaded lines; spinose varices begin on the fourth whorl.

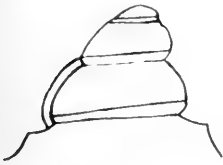

Fig. 1.

The only species whose nucleus approaches that of the present species is *Murex pliciferus* (Sowb.), but that is higher in proportion to its width and somewhat differently shaped. The number of whorls are the same in both species.

It may not be out of place to indicate here the species of which the nuclei have been described and figured. Descriptions of these may be found in the Proceedings spoken of above. The species described are as follows:—

Murex scolopax, Dillw.

“ *occa*, Sowb.

“ *tribulus*, Linn.

“ *rectirostris*, Sowb.

Murex recurvirostris, Sowb.

“ *similis*, Sowb.

“ *tryoni*, Hidalgo.

“ *cailleti*, Petit.

<i>Murex brevispina</i> , Lam.	<i>Murex aduncospinosus</i> , Beck.
“ <i>nigrispinosus</i> , Reeve.	“ <i>brandaris</i> , Linn.
“ <i>ternispina</i> , Lam.	“ <i>rufus</i> , Lam.
“ <i>tenispina</i> , Lam.	“ <i>pliciferus</i> , Sowb.
“ <i>tribulus</i> , Linn.	“ <i>brevifrons</i> , Lam.

Eupleura caudata, Say. (Fig. 2.)

The nucleus of this species consists of one and a half semitransparent, glossy whorls; there is no indication of a carina upon them; the tip of the first whorl is immersed in the succeeding whorl and is



Fig. 2.

bent down to one side; the first half of the whorl, looking at the lateral outline, is about half the size of the portion succeeding it; the whorls are well-rounded and full; the sculpture, consisting of spiral and longitudinal lines, begins very faintly on the latter part of the second whorl and gradually grows stronger as the shell increases in size; there

are about fourteen longitudinal lines to each whorl, after leaving the nucleus, which are crossed by two heavy spiral lines.

I have seen four specimens of this species, and the characters expressed above appear to be tolerably constant. The present species is the only one of this genus, which I have been able to examine. It will be interesting to know just how variable or constant the nuclei are in the different species. This is a field which needs a great amount of original investigation.

A NEW SUBFAMILY OF MURINE RODENTS—THE NEOTOMINÆ—WITH
DESCRIPTION OF A NEW GENUS AND SPECIES AND A SYNOPSIS
OF THE KNOWN FORMS.

BY DR. C. HART MERRIAM.

A study of the rich collections of American Murine Rodents brought together by the U. S. Department of Agriculture, shows that the genus *Neotoma* is one of a group of closely allied forms which differ so radically from the tuberculate crowned Murines, with which they have been commonly associated, that the propriety of separating them as an independent subfamily seems evident.

The unparalleled series of Mexican Rodents collected by Mr. E. W. Nelson in connection with his work for the Division of Ornithology and Mammalogy of the U. S. Department of Agriculture, contains a large number of wood rats, several of which are not properly referable to the genus *Neotoma*. Two of these were described by me sometime ago, under the names *Xenomys nelsoni* and *Neotoma alleni*,¹ the former being made the type of a new genus. In the original account of *Neotoma alleni* attention was called to the circumstance that the crown of the last lower molar is shaped like the letter S, instead of exhibiting two transverse loops as usual in the genus *Neotoma*, and it was remarked that this peculiarity might prove worthy of subgeneric recognition (p. 167). In the course of a subsequent study of the American wood rats, it was discovered that the character in question, which is one of great value, is correlated with a number of important cranial characters, making it obviously undesirable to retain the animal longer in the genus *Neotoma*. Ameghino has described and figured two related rodents from the Pampean Pliocene deposits near Villa de Lujan, in the province of Buenos Ayres, which he has named *Plyssophorus elegans*² and *Trotomys atavus*.³ His description of the former is based on the broken ramus of the mandible of an apparently immature indi-

¹ Proc. Biological Soc. of Washington, VII, Sept. 1892, 159-163; 167-169.

² Mammíferos Fósiles de la República Argentina, por Florentino Ameghino 1889, 111, 112, and pl. iv, figs. 1, 1c.

³ *Ibid.*, 119, 120, and pl. iv, fig. 16.

vidual; that of the latter is based on a fragment of the maxillary containing the upper molar series. At first, I was inclined to regard Ameghino's specimens of *Ptyssophorus* (fig. 1c) and *Tretomys* (fig. 2) as the lower and upper jaws of the same animal, and to look upon my '*Neotoma*' *alleni* (fig. 1e) as congeneric therewith.⁴ But subsequent study has convinced me that *Ptyssophorus* and *Tretomys* are probably distinct, though closely related genera, and that the living species formerly described as *N. alleni*, together with the new species here named *retulus*, represent a third genus of the same group. For this genus I propose the name *Hodomys*. *Hodomys* is a more recent type than *Ptyssophorus*, less specialized than *Xenomys*, and more ancient than *Neotoma*.

So far as dental characters go, the group of genera under consideration (*Ptyssophorus*, *Tretomys*, *Hodomys*, *Xenomys*, and *Neotoma*) presents nearly every important step in the evolution of the modern genus *Neotoma* from the *Cricetine* series. *Sigmodon* seems to be the connecting link that bridges the gap between the tuberculate toothed Murine subfamily *Cricetinae* and the flat topped prismatic crowned Neotominae, by which name it seems proper to designate the new subfamily, comprising the 5 genera above enumerated.⁵ *Sigmodon* should be looked upon as an ancestral rather than a contemporary type. It is almost on the dividing line between the tuberculate and flat crowned groups, and is probably on or near the trunk line along which the Neotominae branched off from the tuberculate series. It is evidently an ancient type, dating back to the Pliocene at least,⁶ since which period it has not undergone very marked changes. In early life *Sigmodon* has the outer ends of the loops elevated, forming half tuberculate grinders, much as in the American *Cricetines*, but the projecting loops are soon worn down, leaving flat grinding surfaces (fig. 1d). The loops, however, remain closely appressed or even soldered together, never standing out freely as in *Neotoma* and *Arvicola*.

⁴ While of this mind I stated, in a recent paper on the genus *Neotoma*, that the species of Wood Rats having the crown of the last lower molar shaped like the letter S, were transferred to the genus *Ptyssophorus* of Ameghino (Proc. Biol. Soc. Wash., IX, July 2, 1894, 117).

⁵ It is probable that several other animals described by Ameghino belong to the *Neotominae*—such as *Bothriomys* and some of the species referred to the genera *Oxymycterus*, *Holochilus*, and '*Habrotrix*' (= *Abrothrix*).

⁶ Ameghino has figured an undoubted *Sigmodon* from the Pampean Pliocene (Mammif. Fos. Argentinos, pl. 4, fig. 11a), and has referred the same to *Holochilus zulpinus* Licht.

Whatever the future may show the exact genetic interrelations of these animals to be, it is evident that *Ptyssophorus* is the more primitive type; *Tretomys* and *Hodomys* seem to represent more advanced stages in the evolution of the group, while *Xenomys* and *Neotoma* are more specialized. *Xenomys* retains more primitive characters than *Neotoma*, and consequently must be looked upon as nearer *Tretomys*, with which it agrees closely in dental characters; on the other hand, it is a far more specialized type than *Neotoma* and can in nowise be regarded as holding a place in the direct line of descent between *Ptyssophorus* and *Neotoma*.

The discovery of complete skulls of *Ptyssophorus* and *Tretomys* may show that the line of generic separation should be drawn between *Ptyssophorus*, on the one hand, and *Tretomys* and *Xenomys* on the other; and believers in comprehensive genera may unite the two latter as subgenera of a single genus, the relation of which to *Neotoma* would be that of a specialized ancestral type to a modernized type.

The fact that of the living genera only a single species of *Xenomys* and two of *Hodomys* have been discovered, while nearly thirty species of *Neotoma* are known, is strong evidence that *Hodomys* and *Xenomys* are survivors of the past, bridging over the gap between *Ptyssophorus* and *Neotoma*, and that the latter genus is now at or near the height of its development.

Irrespective of the interrelations of these animals, it is evident that, collectively, they form an important though not highly specialized subdivision of the Murine series, standing somewhat apart from the others. While they resemble the Arvicolinae in some respects, they differ in numerous important characters and cannot be regarded as intermediate between the Arvicolinae and Cricetinae. On the contrary, the Neotominae and Arvicolinae seem to be independent offshoots from the half-tuberculate crowned Cricetines. Among the many excellent characters that serve to distinguish these two groups, the following are sufficient for present purposes:—

Subfamily ARVICOLINÆ.

Cranium abruptly and strongly constricted immediately in front of brain case, which is quadrangular, projecting squarely into orbit; orbital and temporal fossae well differentiated; jugal forming half, or more than half, of outer side of zygoma and always reach-

ing forward more than half way from squamosal root to maxillary plate; sagittal area subquadrate, usually broader than long; angular process of mandible narrow, everted, hamular, and thickened at end; infracondylar notch low and deep.

Subfamily NEOTOMINÆ.

Cranium not abruptly constricted in front of brain case, which is oval, gradually narrowing into orbit; orbital and temporal fossæ indistinguishable, without trace of separation; jugal wholly posterior, forming insignificant part of zygoma and never reaching forward half-way from squamosal root to maxillary plate; sagittal area elongated, at least twice as long as broad; angular process of mandible broadly expanded vertically, inflected, not hamular, and never thickened at end; infra-condylar notch high and shallow.

The dental characters of the Neotominæ may be defined as follows: Molars $\frac{3}{3}$, prismatic, rooted or semi-rooted; the crowns flat, their sides continuously invested with enamel which is folded on itself in such manner as to present on each side of the tooth a series of salient loops, alternating with re-entrant angles or interspaces (figs. 1-5). M 1 , 2 , and 3 , each with three salient loops and two re-entrant angles on outer side; m 1 with three salient loops and two re-entrant angles on inner side;⁷ m 2 and 3 each with two salient loops and one re-entrant angle on inner side; m 1 with three salient loops and two re-entrant angles on outer side and four salient loops and three re-entrant angles on inner side, with or without an anterior lobe; m 2 (normally) with three salient and two re-entrant angles on each side [*Ptyssophorus* resembles *Sigmodon* in having the antero-external re-entrant angle small]; m 3 variable, but normally with two salient and one re-entrant angles on each side.

The subfamily Neotominæ comprises the genera *Neotoma*, *Xenomys*, *Hodomys*, *Tretomys*, and *Ptyssophorus* (and probably one or two others).

The Neotominæ may be distinguished from the Sigmodont Crice-tines by the following characters:—

Molar crowns prismatic; loops distant; enamel folds of equal thickness; crowns flat; antorbital vacuities without spine; palate excavated between posterior molars. . . . Subfamily Neotominæ.

⁷ In *Neotoma desertorum* and *arizonæ* the antero-internal loop is short and shallow and becomes obsolete with wear (fig. 5a).

Molar crowns not prismatic; loops closely appressed; enamel folds of unequal thickness, and rising at the free ends to form half tubereles; antorbital vacuities with a blunt spine projecting forward from top of outer side; palate not excavated between posterior molars. . . . *Sigmodon* (fig. 1*d*), *Scapteromys*, *Holochilus*(?), and other genera.

In order to render the present account of these highly interesting rodents as complete and useful as possible, the genera *Ptyssophorus* and *Tretomys* are redefined, the new and closely allied genus *Hodomys* is characterized (with reference to the more specialized genera *Xenomys* and *Neotoma*), and descriptions of all the known species are added.

Genus **PTYSSOPHORUS** Ameghino [Fossil].

(Fig. 1, *a*, *b*, and *c*.)

Ptyssophorus Ameghino, Mamíferos Fósiles República Argentina, 1889, 111, 112, and pl. iv, figs. 1-1c. Type *Ptyssophorus elegans* Amegh., from the Argentine Republic.

Crown of m_3 shaped like the letter S placed lengthwise of jaw; projecting part of lower incisor nearly straight, slender, and forming



Fig. 1. *a*, *b*, *c*. *Ptyssophorus elegans* (from Ameghino).
a. Right ramus of mandible, outer side.
b. Same, inner side (enlarged).
c. Crowns of right lower molars (enlarged).
d. *Sigmodon hispidus*, crowns of right lower molars.
e. *Hodomys alleni*, crowns of right lower molars.

with its fellow a single sharp, almost spear-shaped, point for piercing; symphysis of mandible long, straight or nearly straight, and usually bent up at a sharp angle with ramus; the two posterior enamel folds of m_1 and m_2 simple, reaching completely across the tooth from side to side as in m_3 ; each re-entrant angle corresponding to a salient loop on opposite side; investing enamel walls parallel, the included dentine forming a continuous narrow band of equal breadth throughout.

Ptyssophorus and *Hodomys* agree in the following characters:—

Crown of m_3 shaped like the letter S placed lengthwise of jaw; projecting part of lower incisor nearly straight, slender, and forming with its fellow a single sharp almost spear-shaped point for piercing; symphysis of mandible long, straight or nearly straight, and usually bent up at sharp angle with ramus.

Ptyssophorus and *Hodomys* differ in the following characters:—

Genus **PTYSSOPHORUS** Ameghino.

Genus **HODOMYS** nob.

(Fig. 1c.)

(Fig. 1c.)

The two posterior enamel folds of m_1 and m_2 simple, reaching completely across the tooth from side to side as in m_3 ; each re-entrant angle corresponding to a salient loop on opposite side; investing enamel walls parallel, the included dentine forming a continuous narrow band of equal breadth throughout.

All enamel folds of m_1 and m_2 reaching only about half-way across tooth; each re-entrant angle corresponding (at least in young) to re-entrant angle of opposite side; investing enamel walls alternately divaricating and approximating, the included dentine broken into disconnected parts.

The principal differences between the lower molars of *Ptyssophorus* and those of *Hodomys* are, that in *Ptyssophorus* most of the enamel folds reach all the way across the tooth; the enclosed dentine is of nearly equal width throughout; the anterior loop of the first molar has an additional lobe, and the first and second external loops of the middle molar are more crowded and less distinctly separated (much as in *Sigmodon*). The only one of these differences of more than

The enamel pattern of the crowns of m_2 and m_3 of *Ptyssophorus elegans* (fig. 1c) is almost identical with that of young specimens of some living species of *Sigmodon* (fig. 1d), but the character of the teeth is different: In *Sigmodon* the crowns have hardly left the tuberculate condition; the enamel is of unequal thickness, the loops are closely appressed, and the re-entrant angles are of superficial depth vertically; in *Ptyssophorus* the crowns are truly prismatic, perfectly flat on top, the loops well spaced, and the re-entrant angles reach from crown to alveolus.

specific weight is the length of the enamel folds, a character apparently due to antiquity, representing an earlier and more primitive stage in the evolution of the enamel pattern. In Ameghino's single specimen the re-entrant angles or grooves between the folds extend vertically from crown to alveolus, as in the young of *Neotoma* and allied types. Whether they continue below the alveolus to the very root of the tooth as in the Arvicolines, we are not informed; but the characters of the jaw and molar crowns indicate that they do not. The specimen is apparently immature and the teeth are probably rooted or semi-rooted.

Ptyssophorus elegans Ameghino. (Fig. 1, *a*, *b*, and *c*.)

Ptyssophorus elegans Ameghino, Mamíferos Fósiles Repub. Argentina, 1889, 111, 112, and pl. 4, figs. 1, 1c.

Based on a fossil ramus of the mandible (right side) from the Pampean Pliocene deposits near Villa de Lujan, Province of Buenos Ayres.

Specific characters.—Most of the characters have been given above in the generic diagnosis and need not be repeated. The anterior loop of m_1 has a lobe directed forward (see fig. 1c). Ameghino states that the alveolar border is higher on the outer than inner side of the jaw, and that m_1 is nearly as large as m_2 and m_3 together. He gives the following measurements: length of molar series on crowns, 5 mm.; on alveolus, 6; distance from incisor to m_1 , 5; height of ramus at m_3 , 5; distance from front of incisor to back of last molar, 12. The incisor is short, but this may be an individual peculiarity. The hinder part of the mandible is broken off, so that the form of the angle and condylar ramus can only be inferred from allied forms.

Ameghino's figures are here reproduced (fig. 1, *a*, *b*, and *c*).

Genus TRETOMYS Ameghino [Fossil].

(Fig. 2.)

Tretomys Ameghino, Mam. Fos. Repub. Argent., 1889, 119, pl. 4, figs. 16 and 16a. Type *Tretomys ataxus* Ameghino, from Pampean Pliocene, Argentine Republic.

Generic characters (based on Ameghino's figures and description of part of maxillary bone including upper molar series, maxillary root of zygoma, and upper incisor).—Number of enamel folds as



Fig. 2. *Tretomys atavus* (from Ameghino). Left upper molars.

in other members of the subfamily (m^1 with three salient and two re-entrant loops on each side; m^2 and 3 each with three salient and two re-entrant loops on outer side and two salient and one re-entrant loop on inner side); the re-entrant enamel folds from both sides stopping on or very near median line of teeth, and directed inward at nearly right angles to long axis of teeth, instead of obliquely backward as in the other genera; m^2 and 3 subequal in size; m^1 slightly larger; anterior loop of m^1 projecting on inner side as far as middle and posterior loops, and falling short of plane of other two on outer side (reversing the usual condition); zygomatic root of maxillary reaching back to posterior part of m^1 (anterior part in other genera).

Tretomys atavus Ameghino. (Fig. 2.)

Tretomys atavus Ameghino, Mamíferos Fósiles Repub. Argentina, 1889, 119, 120, pl. 4, figs. 16 and 16a.

Based on fossil fragment of maxillary bone containing molar series, and upper incisor, from near city of Cordoba, Argentine Republic.

Specific characters.—Most of the characters have been given above, in the generic diagnosis. The molars are implanted squarely one in front of the other, the longitudinal axis of each tooth being the same as that of the series collectively. In the other genera the upper molars are implanted obliquely, the axis of m^2 and 3 sloping outward as well as backward from the axis of the series as a whole. In *Tretomys* the posterior loop on the inner side and the anterior loop on the outer side of m^2 and 3 are more largely developed than in the other genera, the result being that on each side all of the salient loops of the series end nearly on the same plane. Ameghino's measurements of the molar series are: Series, 5 mm.; m^1 , 2 mm.; m^2 , 1.6 mm.; m^3 , 1.4 mm. The upper incisor is 1 mm. broad and its face is very convex.

Genus *HODOMYS*ⁿ nob.

(Pl. IX, Figs. 1-4, 7, 8, and Fig. 3, *a*, *b*, *c*, *d*, in text.)

Type *Neotoma alleni* Merriam, Proc. Biol. Soc. Wash., VII, Sept. 1892, 167-169 (Type from Manzanillo, Mexico).

ⁿ *Hodomys*, from *hodo*, road, and *mys*, mouse, in allusion to the road-making habit of both species.

Generic characters.—Upper molars much as in *Neotoma*,¹⁰ but crowns of m^1 and m^2 with middle transverse loop divided by deepening of enamel fold on inner side; m^1 and m^2 with four roots each; m^3 with three roots; lower molars with enamel folds reaching about half-way across tooth; m_3 shaped like letter S.

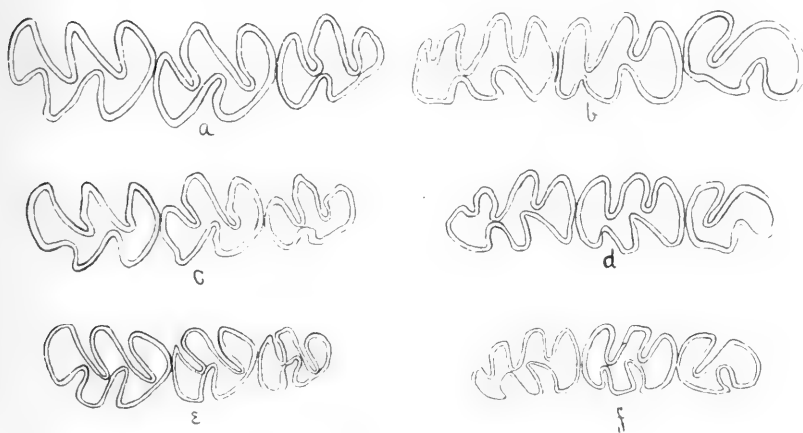

Fig. 3. (x 5.) a and b, *Hodomys alleni*. c and d, *H. vetulus*. e and f, *Xenomys nelsoni*.

a, c, e. Crowns of upper molars. b, d, f. Crowns of lower molars.

with two salient and one re-entrant angle on each side, with a tendency toward the subdivision of the antero-external loop by the development of a notch (or vertical sulcus) on its convexity; upper incisors peculiarly excavated, apparently by the sharp point of the lower ones, leaving a deep cavity behind the enamel face, which is bordered laterally by the outer sides of the teeth. Cranium long and narrow, much as in *Neotoma pennsylvanica*, only narrower; audital bullae small, abruptly narrowed anteriorly, the narrow part produced obliquely inward, much as in *Neotomys*; inner side conspicuously excavated by the carotid canal and foramen, which is considerably anterior to middle of bulla; brain case narrow and long; spheno-palatine vacuities closed; mandible with coronoid notch more nearly vertical than horizontal; condylar ramus high,

¹⁰ Most of the accompanying description is drawn with reference to antithesis with *Neotoma*. Probably many of the characters apply to *Thysophorus* also, of which animal, unfortunately, the cranium and posterior part of the mandible are unknown.

curved strongly upward and inward; angle produced backward behind plane of condyle, and strongly inflected; ramus of mandible thickened opposite molar teeth and abruptly narrowed and beveled to incisors.

The principal characters that separate *Hodomys* from *Xenomys* are arranged antithetically in the following table:—

XENOMYS.

Posterior part of mandible only moderately expanded, short and cut away by deepening of coronoid and infracondylar notches (particularly the latter).

Angular process decidedly anterior to plane of condyle.

Condyle overtopping coronoid.

Anterior root of coronoid cutting plane of posterior loop of m_2 .

Horizontal ramus nearly straight below molar series.

Cranium short.

Squamosal *not reaching supraoccipital*.

Audital bullæ enormously inflated, wheel-shaped, parallel, broadest anteriorly.

Audital bullæ much longer than molar series and covering more than two-thirds distance from foramen magnum to postpalatal notch.

Carotid canal inconspicuous, far behind middle of bulla.

Orbital borders of frontals produced laterally, forming a shelf-like head over orbits.

HODOMYS.

Posterior part of mandible long, large, and broadly expanded posteriorly; coronoid and infracondylar notches relatively shallow.

Angular process produced backward behind plane of condyle.

Coronoid overtopping condyle.

Anterior root of coronoid cutting plane of anterior loop of m_3 .

Horizontal ramus decidedly convex downward below molar series.

Cranium long and narrow.

Squamosal *articulating with supraoccipital*.

Audital bullæ very small, subfusiform, abruptly narrowed anteriorly and produced obliquely forward toward median line.

Audital bullæ much shorter than molar series and covering only about one-third distance from foramen magnum to postpalatal notch.

Carotid canal conspicuous, anterior to middle of bulla.

Orbital borders of frontals upturned, not projecting over orbits.

XENOMYS (*Cont.*).

Premaxillæ produced anteriorly in wing-like extensions reaching beyond nasals.

Pterygoid fossæ short— as broad as long.

Postpalatal notch shorter than basisphenoid.

Basioccipital very narrow.

Lower molar series curved strongly outward anteriorly.

HODOMYS (*Cont.*).

Premaxillæ without wing-like extensions.

Pterygoid fosse long—twice as long as broad.

Postpalatal notch longer than basisphenoid.

Basioccipital broad.

Lower molar series straight or nearly straight.

Only two species of *Hodomys* are known. Both make extensive inosculating runways among the Agaves and other plants on the brushy side hills where they live. This habit is unknown in the allied genera *Neotoma* and *Xenomys*. *Neotoma* builds houses or amasses large piles of sticks, cactus spines, or other rubbish; *Xenomys* lives in hollow trees; *Hodomys* is not known to do either.

Hodomys alleni (Merriam). (Pl. IX, figs. 1-4; and text fig. 3, *a* and *b*.)

Neotoma alleni Merriam, Proc. Biol. Soc. Washington, VII, Sept. 1892, 167-169. (Type from Manzanillo, Mexico.)

General characters.—Size large (larger than any known species of *Neotoma*); ears rather large; tail shorter than head and body, blackish, sparsely haired, the annulations and scales distinctly visible on both sides.

Color.—Upper parts from forehead to base of tail deep fulvous or tawny-ferruginous; nose and sides of face mouse-gray, tinged with bluish in some specimens; under surface whitish, the tips of the hair only being white, the plumbeous basal part showing through; upper surfaces of feet whitish, more or less clouded with dusky; tail blackish all round.

Cranial characters.—Skull very long and narrow; angular; orbital margins of frontals nearly parallel and strongly upturned, with tendency to develop an upturned point opposite middle of orbital fossa; interparietal shield quadrate; nasals produced and pointed anteriorly, truncate or emarginate posteriorly. (Principal characters given under generic diagnosis and not repeated here.)

Measurements of type (taken in flesh).—Total length, 472 mm; tail vertebrae, 225; hind foot, 46; ear, 29 (in dry skin).

Cranial measurements of type.—Total length, 54 mm; basal length, 46.5; basilar length of Hensel, 44; zygomatic breadth, 27; upper molar series on crowns, 10.

Hodomys vetulus sp. nov. (Text fig. 3, *c* and *d*.)

Type from Tehuacan, Puebla, Mexico. No. 53,656 ♂ ad., U. S. Nat. Museum, Department of Agriculture Collection. Collected May 8, 1893, by E. W. Nelson. (Original number 4,784.)

General characters.—This animal bears no close resemblance to any known species except *Hodomys alleni* from Mazanillo (on the opposite side of Mexico), with which it shares the remarkable S-shaped last lower molar, peculiar audital bullæ, closed sphenopalatine vacuities, and many other characters. It is much smaller than *alleni*, has a bicolor instead of concolor tail, white instead of dusky hind feet, and differs also in cranial characters.

Color.—Upper parts dull fulvous from point between eyes to rump, plentifully mixed with black hairs; face gray; fore and hind feet white; tail bicolor, blackish above, soiled white beneath; under parts whitish, clouded from plumbeous under fur and washed with dull fulvous on sides of belly (and in one specimen on breast also).

Cranial characters.—Skull similar to that of *Hodomys alleni*, but smaller, shorter, less angular, and differing further in the following characters: rostrum and nasals shorter; nasals narrower posteriorly; interparietal shield less quadrate and more elongated transversely; incisive foramina shorter (falling considerably short of plane of m^1); palate proportionally longer; audital bullæ smaller; frontals broader posteriorly and less upturned along orbital margins; mandible less expanded posteriorly.

Dental characters.—Similar to *H. alleni*, but m^1 broader and shorter; the antero-external loop larger; postero-internal loop less completely divided; m_3 broader and shorter; more perfectly S-shaped, and without trace of antero-external sulcus.

Measurements (taken in flesh).—Type: Total length, 380 mm; tail vertebrae, 166; hind foot, 38. Ear from anterior base, 29 (in dry skin). Average measurements of 4 specimens from type locality: Total length, 365; tail vertebrae, 163; hind foot, 38.

Cranial measurements of type.—Total length, 47; basal length, 41; basilar length of Hensel, 39; zygomatic breadth, 25; upper molar series on crowns, 9.

Mr. Nelson states that this species is rather common about the foot of the low cliffs and rocky ledges on the hillsides east of Tehuacan, and that it lives in dense patches of *Agave*. He says: "It has the habit of making roads about its haunts, very much after the manner of *N. alleni*. Well-defined trails were found leading along the hillside from rock to rock or to the cover of *Agave* patches, and between neighboring groups of these plants. Under the shelter of a maguey patch a network of trails could be frequently found by forcing ones way among the spiny leaves. Like *N. alleni*, these animals did not take grain bait, and were caught by placing traps in their trails. No signs of the nest building habit, so common in the genus *Neotoma*, were observed."

Genus **XENOMYS** Merriam.

(Pl. IX, figs. 10-13; and text fig. 3, *c* and *f*, and fig. 4.)

Xenomys Merriam, Proc. Biol. Soc. Washington, VII, Sept. 1892, 159-163 (Type from Hacienda Magdalena, Colima, Mexico).

Generic characters.—Skull murine; short; audital bullæ greatly enlarged and inflated, broader anteriorly than posteriorly, wheel-shaped, parallel, carotid foramen posterior to middle of bulla and inconspicuous; squamosal not reaching supraoccipital but ending anterior to plane of auditory meatus, except the slender posterior spicule which reaches over meatus to mastoid; orbital margins of frontals produced laterally forming projecting supraorbital beads; lacrymals large; interparietal large and transversely elongated; premaxillæ produced anteriorly forming a wing-like extension on each side of anterior nares; angle of mandible short, moderately expanded vertically, inflected; condylar ramus long and high, overtopping coronoid process; molars large and heavy; truly rooted (upper with three roots each; lower with two roots each); crowns prismatic, made up of broadly rounded alternating salient loops and open re-entrant angles or interspaces; crown of m_3 , shaped in general like letter S but somewhat angular (fig. 4).

Externally, *Xenomys* resembles a small, highly colored wood rat, with rather soft pelage and a large whitish spot over each eye. The tail is nearly as long as the head and body. Nothing is known of the habits of these animals, except that they are nocturnal and live in hollow trees.

Xenomys agrees with *Hodomys* in having the mandibular symphysis rather long, straight and upturned; the condylar ramus very long,

and curving strongly upward and inward; the coronoid notch nearly vertical; the angle inflected (but not produced backward so far as in *Hodomys*); the incisors slender, meeting in a single sharp point; the molars very large; and m_3 , shaped like the letter S. *Xenomys* differs from *Hodomys* in having the mandible greatly reduced posteriorly; the condylar ramus longer and more slender, overtopping the coronoid, and both coronoid and infracondylar notches larger at the expense of the posterior part of the ramus, which is greatly reduced thereby. In *Xenomys* the anterior base of the coronoid process arises more anteriorly from the horizontal ramus, hiding the whole of the last molar and posterior loop of the middle molar, while in *Hodomys* it arises further back, exposing the anterior loop of the last molar. (In *Neotoma* the line commonly falls between m_2 and m_3 ; in *Ptyssophorus*, according to Ameghino's figure, it apparently is further back, exposing most of m_3 .)

Xenomys nelsoni Merriam. (Pl. IX, figs. 10-13; and text figs. 3. *e* and *f*, and fig. 4.)

Xenomys nelsoni Merriam, Proc. Biol. Soc. Washington, VII, Sept. 1892, 161-163. Type from Hacienda Magdalena, Colima, Mexico.

General characters.—Size about that of a half or two-thirds grown rat, or nearly equaling *Neotoma mexicana*; tail a little shorter than head and body, well haired, particularly above; face ornamented by a distinct whitish spot over each eye and a less distinct one under each ear; color of upper parts rich fulvous; under parts white; ears about half as long as the head and nearly naked (sparsely clothed with fine, inconspicuous hairs); whiskers reaching back to shoulders; fur soft.

Color.—Upper parts fulvous or tawny-rufous, palest on the head and brightest over the rump, flanks, and hips; back sparsely mixed with black-tipped hairs; an ill-defined dusky ring around each eye, above which is a whitish spot about as large as the eye itself; a less distinct whitish spot just below the inferior root of the ear; upper lips white, the white color extending up on the cheeks more than half-way to the eyes; sides of face below eyes and ears washed with fulvous; whiskers blackish; tail concolor, dark umber-brown all round; upper surfaces of feet whitish, more or less clouded with dusky (varying considerably in the three specimens); under parts creamy white to the very roots of the hairs except along the sides of the belly, where the basal part of the fur is plumbeous; line of

demarkation between colors of upper and lower parts everywhere sharp and distinct.

Cranial and dental characters.—Most of the cranial and dental characters have been already given under the head of the genus and need not be here repeated. The rostrum is short and the ascending branches of the premaxillæ hardly reach as far back as the nasals. Molars large and broad; m_1 more than half as broad as long and

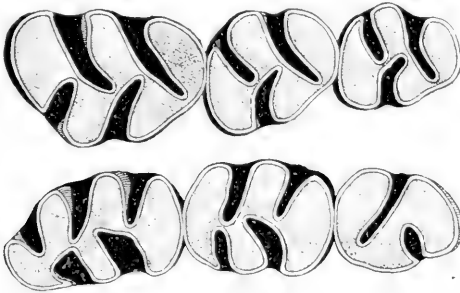

Fig. 4. *Xenomys nelsoni* Type. Upper and lower molar crowns. (x 7.)

curving outward anteriorly; m_1 with anterior half bent strongly outward, the anterior loop looking outward instead of forward; m_3 , S-shaped, with a small and nearly closed triangle on outer side of convexity, thus having an anterior loop projecting inward, a posterior loop projecting outward, and a re-entrant angle or loop on each side, the outer of which is the shallower and more posterior in position; both of the re-entrant angles are directed obliquely forward as well as toward the opposite side of the tooth (for further details see fig. 4).

Measurements of type (taken in flesh).—Total length, 300 mm; tail vertebrae, 143; hind foot, 30; ear 22 (in dry skin).

Cranial measurements of type.—Total length, 40.5; basal length, 35; basilar length of Hensel, 33; zygomatic breadth, 21; upper molar series on crowns, 8.

Genus NEOTOMA Say and Ord.

Neotoma Say and Ord, Journ. Acad. Nat. Sci. Phila., IV, pt. 2, 1825, 345, 346, pls. XXI and XXII. Type *Mus floridana* Ord, from eastern Florida.

*Generic characters.*¹¹—Crown of m_3 composed of two transverse

¹¹ The characters here given are selected with reference to antithesis with *Ptyssophorus*, *Hodomys*, and *Xenomys*.

loops (with the addition in rare cases of a narrow antero-external loop), never S-shaped (fig. 5); m^1 and 2 with middle loop undivided (reaching completely across tooth); molar series relatively short; condylar ramus low and directed obliquely backward; coronoid notch horizontal or nearly so [nearly vertical in *Xenomys* and *Hodomys*]; angle of mandible only moderately inflected; symphysis relatively short and sloping strongly forward.

The accompanying illustration (fig. 5) shows the two extremes in pattern of m^1 , and differences in the crowns of the other molars also. The dominant type of m^1 throughout the genus is similar to that of *N. tenuicauda* (fig. 5, *c*), a member of the *mexicana* series.

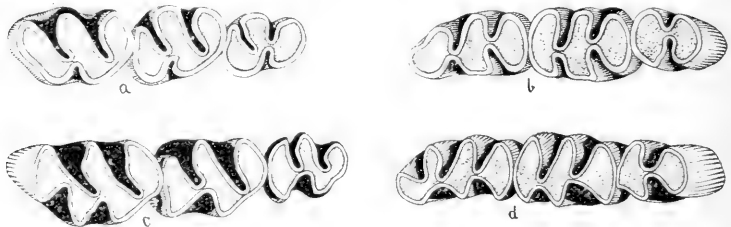

Fig. 5. *a* and *c*. Upper molar crowns. *b* and *d*. Lower molar crowns.

a, b. *Neotoma desertorum* Merriam. Death Valley, Calif., No. 34138. ♂. (x 5.) *c, d.* *Neotoma tenuicauda* Merriam. Sierra Nevada, Jalisco, Mexico. 15629 ♀. Type. (x 5.)

Neotoma is not in any sense a highly specialized type, but it is a very compact genus, its most divergent branches hardly meriting subgeneric recognition. Some of its members point strongly toward derivation from *Hodomys*, as may be seen in the *Nectomys*-like auditory bullae and other cranial characters of *Neotoma pennsylvanica*, and in the high, upturned condyle of the *mexicana* group, but the immediate antecedent forms leading up to *Neotoma* from *Hodomys*, or some similar type, are not known. The oldest forms of which we have any knowledge, those from the cave deposits of Missouri, Kentucky, Virginia, and Pennsylvania, are fully modernized species of *Neotoma* proper.

Of the living species, *N. pennsylvanica* may be regarded as the most primitive, since it possesses several characters, not shared by the others, that point back to *Hodomys*. Moreover, *pennsylvanica* is more nearly intermediate between the two subgenera—*Neotoma* proper and *Teonoma*—than any other known species, indicating that

the differentiation of the trunk line into these two groups proceeded from a form at least very similar to *pennsylvanica*. *N. pennsylvanica* resembles *Hodomys* in the peculiar shape of the audital bullae (which are abruptly narrowed anteriorly), in the nearly closed sphenopalatine vacuities, in the posterior production of the angle of the mandible, and in the strong inward and upward curvature of the condylar ramus. It resembles *Teonoma* in the form of the sagittal area, which is kite-shaped, narrow, sharply angular, broadest far back (on or near plane of interparietal), whence its sides curve abruptly inward and backward to the sides of the interparietal shield. It resembles *Teonoma* further in the tendency to closure of the sphenopalatine vacuities,¹² the great length of the rostrum, and the presence of a long trough-like depression which occupies the entire length of the frontal and hinder part of the nasals.

That the absence of the sphenopalatine vacuity is a primitive character—or perhaps it would be better to say, that the presence of a vacuity is a modern character—is indicated by the following facts: (1) The ancestral genus *Hodomys* has no vacuity; (2) *Xenomys*, an early offshoot from the primitive *Neotomine* stem, has very small vacuities; (3) *Teonoma*, an older type than *Neotoma* proper, has the vacuities closed or partly open; (4) *Neotoma pennsylvanica*, the least differentiated known member of the modern genus, has the vacuities partly closed; and finally (5) some of the modernized species have the vacuities closed in early life though fully open in the adult.¹³

In its geographic distribution the genus is restricted, so far as known, to North America north of Dueñas, Guatemala.¹⁴ The species are most numerous in Mexico and the southern United States. The total number of species here recognized, including the subfossil *N. magister*, is 22, in addition to which 10 subspecies are admitted. It is probable that a few additional species will be added, and that some of the members of the *mexicana* group will be reduced to subspecific rank.

¹² But there is this difference: The thin wing or lamella of bone which closes or partly closes the vacuity in *Teonoma* is derived wholly from the palatine, while in *N. pennsylvanica* it is made up almost equally of palatine and pterygoid. In the latter species the suture between the palatine and pterygoid moieties is on the plane of the suture between the basisphenoid and presphenoid.

¹³ Allen has recently shown this to be the case in *N. micropus* (Bull. Am. Mus. Nat. Hist., N. Y., VI, 1894, 239).

¹⁴ The Guatemala species (*N. ferruginea* Tomes) has not been seen by me and may not be a true *Neotoma*.

In 1843, J. E. Gray separated the bushy tailed from the round tailed species, proposing the name *Teonoma* for the former. In a recent communication I adopted the name for a subgenus, and defined the resulting two subgenera as follows:—

Subgenus **NEOTOMA** Say and Ord, 1825.

Neotoma Say and Ord, Journ. Acad. Nat. Sci. Phila., IV, pt. 2, 1825, 345, 346, pl. XXI, XXII. Type *Mus floridana* Ord, from eastern Florida.

Tail commonly round, scant-haired and tapering, but in one species moderately bushy; hind feet small or moderate.

Rostrum of moderate length, not more than one-third the length of cranium; sagittal area usually rounded, the broadest part always considerably anterior to plane of interparietal, whence the sides curve gradually backward to interparietal shield; sphenopalatine vacuities always open.

Subgenus **TEONOMA** Gray, 1843.

Teonoma Gray, List Spec. Mamm. British Museum, 1843, 117. Type *Neotoma cinerea drummondii* (Richardson), from the Rocky Mts. in lat. 57° N.

Tail very large, bushy, and somewhat distichous, like a squirrel's; hind feet very large.

Rostrum much elongated, measuring more than one-third the total length of cranium; posterior roots of zygomata widely spreading; sagittal area long, narrow, and sharply angular, its broadest part far back, on or nearly on plane of anterior border of interparietal, whence the sides bend abruptly back to interparietal shield; sphenopalatine vacuities closed or open.

In the same communication I proposed, for convenience in arranging the species, to subdivide *Neotoma* proper into four minor groups, "none of which is worthy of the distinction of subgeneric rank. These groups may be designated, from a typical species in each, as follows: (1) the *leucodon* group; (2) the *mexicana* group; (3) the *desertorum* group, and (4) the *arizonae* group."

In a recent paper on *Cranial Variations in Neotoma micropus*,¹⁵ Dr. J. A. Allen criticises my use of the color of the teeth as a subordinate character, and goes on to state that the range of individual variation in color in his series of *N. micropus* "covers the whole range of variation for the genus." His subsequent remarks show

¹⁵ Bull. Am. Mus. Nat. Hist., N. Y., VI, Aug. 3, 1894, 243, 244.

a total misapprehension of my meaning, for instead of speaking of the color of the teeth themselves he refers to the dirty coating on the outside of the teeth. He says: "The black coloring consists to a large extent of a superficial incrustation which tends to scale off in flakes in the prepared skull, and its absence apparently may be due sometimes to removal in the process of cleaning the skull for the cabinet. In other words, the blackness is to some extent an accidental or pathological condition, due probably more or less to the particular character of the food or to the health of the animal." But for this perverse interpretation of my very plain statement it would not be necessary to explain that when I said "color of teeth white or nearly white" I meant the teeth—the osteodentine and enamel—not the dirty deposit that sometimes collects on the outside of the teeth. But after all, the peculiarity is one of little consequence and was only mentioned by me after enumerating the characters by which members of the *leucodon*¹⁶ group may be distinguished from others.

The following list of the 22 species and 10 subspecies recognized by me contains under each name: (1) reference to the original description; (2) the principal synonymy; (3) the type locality; (4) the known geographic distribution.

Descriptions of the species are not added because they are included in a more formal and fully illustrated revision of the genus which will be published later.

***Neotoma leucodon* Merriam.**

Neotoma leucodon Merriam, Proc. Biol. Soc. Wash., IX, July 2, 1894, 120, 121.

Type locality: San Luis Potosi, Mexico.

Geographic distribution.—Upper part of Lower Sonoran Zone in Central Mexico, from Berriozabal, Zacatecas, easterly to southern San Luis Potosi, and thence southeast to Perote, Vera Cruz.

***Neotoma latifrons* Merriam.**

Neotoma latifrons Merriam, Proc. Biol. Soc. Wash., IX, July 2, 1894, 121.

Type locality: Querendaro, Michoacan, Mexico.

Geographic distribution.—Valley of Querendaro, south side of Lake Cuitzeo, Michoacan, Mexico (range unknown.)

¹⁶ Named, as stated, after *N. leucodon*, a central member of the group, not because all the species have white teeth.

Neotoma micropus Baird.

Neotoma micropus Baird, Proc. Acad. Nat. Sci. Phila., April, 1855, 333 (from Charco Escondido, Tamaulipas.¹⁷) Mammals of N. Am., 1857, 492-495. Allen, Bull. Am. Mus. Nat. Hist., N. Y., III, No. 2, June, 1891, 282-285.

Neotoma micropus canescens Allen, Bull. Am. Mus. Nat. Hist., III, No. 2, June, 1891, 285-287 (from N. Beaver Creek, Pan Handle of Oklahoma).

Type locality: Charco Escondido,¹⁷ Tamaulipas, Mexico (100 kilometers or 62 miles west of Matamoros, and 44 kilometers or 27 miles south of Reynosa.)

Geographic distribution.—Eastern subdivision of Lower Sonoran Zone from San Fernando, Tamaulipas, northward to the Pan Handle of Oklahoma, and westward to the Staked Plains; in the Rio Grande Valley west to El Paso; and in the Pecos Valley to Eddy, New Mexico.

Neotoma baileyi Merriam.

Neotoma baileyi Merriam, Proc. Biol. Soc. Wash., IX, July 2, 1894, 123.

Type locality: Valentine, Nebraska.

Geographic distribution.—Probably Great Plains subdivision of Upper Sonoran Zone in southern South Dakota, Nebraska, and Kansas.

Neotoma floridana (Ord).

Mus floridana Ord, Bull. Soc. Philomath, Dec. 1818, 181-182

Type locality: Florida.

Geographic distribution.—Austro-riparian Fauna of South Atlantic and Gulf Coasts and lower Mississippi Valley.

Neotoma pennsylvanica Stone.

Neotoma pennsylvanica Stone, Proc. Acad. Nat. Sci. Phila., Feb. 1893, 16-18.

Type locality: South Mountain, Cumberland Co., Pennsylvania.

Geographic distribution.—Allegheny Mountain region of Pennsylvania, and probably the whole of the southern Alleghenies; north to southern New York.

Neotoma magister Baird.

Neotoma magister Baird, Mam. N. Am., 1857, 498.

Type locality: Bone Caves near Carlisle (between North and South Mountains), Pennsylvania.

¹⁷ Two specimens were mentioned in the original description, an adult male from Charco Escondido, and a very young specimen in poor condition from Santa Rosalia, Chihuahua. The original description is based wholly on the Charco Escondido specimen, which, therefore, must be taken as the type of the species. The Santa Rosalia animal is somewhat aberrant, as shown by additional specimens.

Geographic distribution.—Pleistocene cave deposits of Pennsylvania and Virginia. Remains assumed to belong to the same species have been found in caves in Kentucky and in the Ozark Hills of Missouri.

Neotoma mexicana Baird.

Neotoma mexicana Baird, Proc. Acad. Nat. Sci. Phila., VII, 1855, 333.

Type locality: [Mountains] near Chihuahua, Mexico.

Geographic distribution.—Hills and lower mountain slopes (usually pine covered) of Transition Zone in eastern New Mexico, southwestern Texas (Davis Mountains to Paisano), and Chihuahua, Mexico.

Neotoma mexicana bullata Merriam.

Neotoma mexicana bullata Merriam, Proc. Biol. Soc. Wash., IX, July 2, 1894, 122-123.

Type locality: Santa Catalina Mountains, Arizona.

Geographic distribution.—Known only from the Santa Catalina Mountains in southern Arizona.

Neotoma pinetorum Merriam.

Neotoma pinetorum Merriam, Proc. Biol. Soc. Wash., VIII, July 31, 1893, 111, 112.

Type locality: San Francisco Mountain, Arizona.

Geographic distribution.—The pine covered plateau of Arizona (Transition Zone).

Neotoma tenuicauda Merriam.

Neotoma tenuicauda Merriam, Proc. Biol. Soc. Wash., VII, Sept. 29, 1892, 169, 170.

Type locality: North Slope of Sierra Nevada de Colima.

Geographic distribution.—Sierra Nevada de Colima, Jalisco, Mexico (probably in Transition Zone).

Neotoma orizabæ Merriam.

Neotoma orizabæ Merriam, Proc. Biol. Soc. Wash., IX, July 2, 1894, 122.

Type locality: Mt. Orizaba, Puebla, Mexico.

Geographic distribution.—Mt. Orizaba, Mt. Malinche, and Cofre de Perote, Mexico (probably in Transition Zone.)

Neotoma fulviventer Merriam.

Neotoma fulviventer Merriam, Proc. Biol. Soc. Wash., IX, July 2, 1894, 121, 122.

Type locality: Toluca Valley, Mexico.

Geographic distribution.—Toluca Valley, Mexico.

Neotoma torquata Ward.

Neotoma torquata Ward, Am. Naturalist, XXV, Feb. 1891, 160, 161.

Type locality: [An abandoned tunnel] between Tetela del Volcan and Zacualpan Amilpas, Morelos, Mexico.

Geographic distribution.—Mountains of the states of Mexico and Morelos (south of the valleys of Mexico and Toluca).

Neotoma ferruginea Tomes.

Neotoma ferruginea Tomes, Proc. Zool. Soc. London, 1861, 282-284.

Type locality: Dueñas, Guatemala.

Geographic distribution.—Region about Dueñas, Guatemala.

Range unknown.

NOTE.—I have not seen *N. ferruginea*; it may not belong here at all.

Neotoma fallax Merriam.

Neotoma fallax Merriam, Proc. Biol. Soc. Wash., IX, July 2, 1894, 123, 124.

Type locality: Gold Hill, Boulder Co., Colorado.

Geographic distribution.—Eastern base of Rocky Mountains in Colorado (up to about 7,000 feet altitude, where it is replaced by *N. orolestes*).

Neotoma bryanti Merriam.

Neotoma bryanti Merriam, Am. Nat. XXI, No. 2, Feb. 1887, 191-193.

Type locality: Cerros Island, Lower California.

Geographic distribution.—Cerros Island, Mexico (off Lower California).

Neotoma fuscipes Baird.

Neotoma fuscipes (Cooper MS.) Baird, Mam. N. Am., 1857, 495, 496 (from Petaluma, Calif.).

Neotoma monochroura Rhoads, Am. Naturalist, XXVIII, Jan. 1894, 67, 68 (from Grants Pass, Josephine Co., Oregon).

Neotoma splendens True, Proc. U. S. Nat. Museum, XVII, No. 1006, 1, 2 [Author's separates issued June 27, 1894], (from Marin Co., Calif.).

Type locality: Petaluma, Sonoma Co., California.

Geographic distribution.—Coast region of California and Oregon, from a little south of Monterey Bay northward to the Columbia River (Transition Zone).

Neotoma fuscipes macrotis (Thomas).

Neotoma macrotis Thomas, Ann. and Mag. Nat. Hist., 6th ser., XII, Sept. 1893, 234, 235 (from San Diego, California).

Neotoma macrotis simplex True, Proc. U. S. Nat. Museum, XVII, No. 1006, 2 [Author's separates issued June 27, 1894], (from Old Ft. Tejon, California).

Type locality: San Diego, California.

Geographic distribution.—Coast region (including coast ranges) of California, south of Monterey Bay (in upper Sonoran and Transition Zones).

***Neotoma fuscipes streatori* Merriam.**

Neotoma fuscipes streatori Merriam, Proc. Biol. Soc. Wash., IX, July 2, 1894, 124.

Type locality: Carbondale, Amador Co., California.

Geographic distribution.—West slope of Sierra Nevada in California (including mountain region generally of northeast California except higher elevations.) Upper Sonoran and Transition Zones.

***Neotoma fuscipes dispar* Merriam.**

Neotoma fuscipes dispar Merriam, Proc. Biol. Soc. Wash., IX, July 2, 1894, 124, 125.

Type locality: Lone Pine, Owens Valley, California.

Geographic distribution.—East base of Sierra Nevada in Owens Valley, California (and probably along western edge of Mohave Desert also). Upper Sonoran Zone.

***Neotoma desertorum* Merriam.**

Neotoma desertorum Merriam, Proc. Biol. Soc. Wash., IX, July 2, 1894, 125, 126.

Type locality: Furnace Creek, Death Valley, California.

Geographic distribution.—Mohave and Colorado Deserts and Sonoran deserts generally of eastern California, Nevada, and western Utah (north to East Humboldt Valley, Nevada, and Kelton, Utah.) Upper and lower Sonoran Zones.

***Neotoma desertorum sola* Merriam.**

Neotoma desertorum sola Merriam, Proc. Biol. Soc. Wash., IX, July 2, 1894, 126.

Type locality: San Emigdio, Kern Co., California.

Geographic distribution.—Head of San Joaquin Valley, California.

***Neotoma intermedia* Rhoads.**

Neotoma intermedia Rhoads, Am. Naturalist, XXVIII, Jan. 1, 1894, 69, 70. (from Dulzura, San Diego Co., California).

Neotoma californica Price, Proc. Calif. Acad. Sci., 2d ser., III, May 9, 1894, 151-156, pl. XI (from Bear Valley, San Benito Co., California).

Neotoma intermedia gilva Rhoads, Am. Naturalist, XXVIII, Jan. 1, 1894, 69 (from Banning, California).

Neotoma venusta True, Proc. U. S. Nat. Museum, XVII, No. 1006, 2 [Author's separates issued June 27th, 1894]. (from Carrizo Creek, San Diego Co., California).

Type locality: Dulzura, San Diego Co., California.

Geographic distribution.—The typical form inhabits the valleys and lower slopes of the coast ranges of California south of Monterey Bay (specimens examined from Bear Valley, San Benito Co.; Priest Valley, Monterey Co.; San Luis Obispo; San Fernando; San Bernardino Mt. and Valley; San Jacinto Valley, and Dulzura). A slightly paler form (subspecies *gilva* Rhoads = *venusta* True) inhabits San Geronio Pass and the western edge of the Colorado Desert (specimens examined from Whitewater Ranch, Palm Springs, Cabazon, Carrizo Creek, Baregas Spring, and Vallecitas). Upper Sonoran.

***Neotoma intermedia melanura* Merriam.**

Neotoma intermedia melanura Merriam, Proc. Biol. Soc. Wash., IX, July 2, 1894, 126, 127.

Type locality: Ortiz, Sonora, Mexico.

Geographic distribution.—Sonora, Mexico, near west base of Sierra Madre. Upper Sonoran.

***Neotoma intermedia albigula* Hartley.**

Neotoma albigula Hartley, Proc. Cal. Acad. Sci., 2d ser., III, May 9, 1894, 157-159, pl. XII.

Type locality: Vicinity of Fort Lowell, Arizona.

Geographic distribution.—Lower Sonoran Zone in southern and western Arizona.

***Neotoma intermedia angusticeps* Merriam.**

Neotoma intermedia angusticeps Merriam, Proc. Biol. Soc. Wash., IX, July 2, 1894, 127.

Type locality: S. W. corner Grant Co., New Mexico (only 4 miles from Mexican boundary).

Geographic distribution.—Southwestern New Mexico, and doubtless also adjacent valleys of N. W. Chihuahua, Mexico (in Lower Sonoran Zone).

***Neotoma arizonæ* Merriam.**

Neotoma arizonæ Merriam, Proc. Biol. Soc. Wash., VIII, July 31, 1893, 110, 111.

? *Neotoma lepida* Thomas, Ann. and Mag. Nat. Hist., 6th ser., XII, Sept. 1893, 235 (from Utah).

Type locality: Keams Cañon, Apache Co., Arizona.

Geographic distribution.—Tusayan or Moki region in northeastern Arizona, northwestern New Mexico, southeastern Utah, and probably southwestern Colorado. Sonoran.

Neotoma cinerea (Ord.)

"*Mus cinereus* Ord, Guthrie's Geography, 2d Am. Ed., II, 1815, 292"
(based on description of Lewis and Clark, Paul Allen Ed., 1814, Vol. I, pp. 289,
290.)

Type locality: Near Great Falls, Montana.

Geographic distribution.—Northern Rocky Mt. region in Transition and Boreal Zones, from Utah and Wyoming northward; east to Black Hills and plains of North Dakota west of Missouri River; west in southern British Columbia to Cascade Range, and south throughout the Sierra Nevada to Mt. Whitney in southern California.

Neotoma cinerea occidentalis (Baird).

Neotoma occidentalis (Cooper MS.) Baird, Proc. Acad. Nat. Sci. Phila., VII, 1855, 335.

Neotoma cinerea occidentalis Merriam, Mammals of Idaho, N. Am. Fauna, No. 5, Aug. 1891, 58.

Type locality: Shoalwater Bay, Washington.

Geographic distribution.—Pacific coast region of Oregon and Washington and thence easterly over the lava beds to the Snake Plains of east-central Idaho (Transition and Upper Sonoran Zones).

Neotoma cinerea drummondii (Richardson).

Myoxus drummondii Richardson, Zool. Journ., III, 1828, 517, 518.

Neotoma drummondii Richardson, Fauna Boreali-Am., 1829, 137-140.

Type locality: Rocky Mts., British Columbia (lat. 57°).

Geographic distribution.—Eastern British Columbia and adjacent parts of western Canada north of the range of *cinerea*. Exact distribution unknown. Boreal (probably Hudsonian).

Neotoma orolestes Merriam.

Neotoma orolestes Merriam, Proc. Biol. Soc. Wash., IX, July 2, 1894, 128.

Type locality: Saguache Valley (20 miles west of Saguache, Colorado).

Geographic distribution.—Rocky Mts. of Colorado and New Mexico (southeast of range of *N. cinerea*). Boreal.

SPECIES AND SUBSPECIES OF NEOTOMA.

	Subgenus NEOTOMA	} leucodon group	{	leucodon
				latifrons
				micropus
				baileyi
				floridana
				pennsylvanica
				magister
	Subgenus NEOTOMA	} mexicana group	{	mexicana
				" bullata
				pinetorum
				tenuicauda
				orizabæ
				fulviventer
				fallax
				fuscipes
				" macrotis
				" streatori
	" dispar			
		bryanti		
		? ferruginea ¹⁵		
		? torquata ¹⁵		
	Subgenus NEOTOMA	} desertorum group	{	desertorum
				" sola
				intermedia
				" melanura
				" albigula
		" angusticeps		
	Subgenus NEOTOMA	} arizonæ group	{	arizonæ
	Subgenus TEONOMA	} cinerea group	{	cinerea
				" occidentalis
				" drummondi
				orelestes

¹⁵ *N. torquata* and *ferruginea* I have not seen, hence their relations may not be as here indicated.

ILLUSTRATIONS.

PLATE IX.

(Figures natural size.)

- Figs. 1-4, 7, 8. *Hodomys alleni*, ♀, 44,631, Manzanillo, Mexico.
 1, skull from above; 2, same from left side; 3, same from below; 4, mandible from left side; 7, same from below; 8, same from above.
- Figs. 5, 6, 9. *Neotoma*.
 5, mandible from left side; 6, same from below; 9, same from above.
- Figs. 10-13. *Xenomys nelsoni*, ♂, 45,287, Hacienda Magdalena, Colima, Mexico.
 10, skull from above; 11, same from left side; 12, same from below; 13, mandible from left side.

TEXT FIGURES.

- Fig. 1, *a, b, c*. *Pyssophorus elegans* (from Ameghino).
a, right ramus of mandible, outer side. Nat size.
b, “ “ “ “ inner side. Enlarged.
c, crowns of right lower molars.
d, *Signadon hispidus*, crowns of right lower molars. Enlarged.
e, *Hodomys alleni*, “ “ “ “ “ “
- Fig. 2. *Tretomys atavus*, left upper molars enlarged (from Ameghino).
- Fig. 3, *a* and *b*, *Hodomys alleni*.
a, crowns of left upper molars. (x 5.)
b, “ “ “ lower molars.
c and *d*. *Hodomys retulus*.
c, crowns of left upper molars. (x 5.)
d, “ “ “ lower molars.
e and *f*. *Xenomys nelsoni*.
e, crowns of left upper molars. (x 5.)
f, “ “ “ lower molars.
- Fig. 4. *Xenomys nelsoni*. Type No. $\frac{45286}{39281}$, ♂, ad.
 Hacienda Magdalena, Colima, Mexico.
a, upper molar series. (x 7.)
b, lower molar series.

Fig. 5, *a* and *b*. *Neotoma desertorum*. Death Valley, California,
No. 34,138, ♂, ad. (x 5.)

a, upper molar series.

b, lower molar series.

c and *d*. *Neotoma tenuicauda*. Type No. 45,629, ♀.

Sierra Nevada de Colima, Jalisco, Mexico.

(x 5.)

c, upper molar series.

d, lower molar series.

[NOTE.—The accompanying illustrations belong to the U. S. Department of Agriculture. They are here used by courtesy of Dr. Chas. W. Dabney, Jr., Asst. Secretary of Agriculture.]

DESCRIPTIONS OF FOUR NEW SPECIES AND TWO SUBSPECIES OF
WHITE-FOOTED MICE FROM THE UNITED STATES AND
BRITISH COLUMBIA.

BY SAMUEL N. RHOADS.

The North American genus *Sitomys*, comprising the white-footed or deer mice, has received accessions in the last ten years which bring the combined number of species and subspecies from twelve, in 1885, to thirty-seven in 1884. It may appear presumptive to offer for consideration six additional names to this already rather appalling list of rodents belonging to a single genus. It is somewhat assuring, however, to read the statement of Dr. J. A. Allen,¹ in his paper on Recent Progress in the Study of North American Mammals, that most of these forms are not only "well founded," but that he is "cognizant of still undescribed forms entitled to recognition in nomenclature."

It may be stated, that in every case the following diagnoses are based on a critical comparison of both external and cranial characters with a large series of allied forms from the same region, and in the case of full species the separation has been mainly founded on the characters of the skull.

Sitomys megalcephalus is represented by a single adult and two young specimens in alcohol from northern Alabama. While it is desirable that more specimens should be examined, its characters diverge so widely from its nearest geographic allies, I can offer no apology for presenting it now.

Sitomys insolatus is based on a single individual from the Mohave Desert, California, while a second specimen from the Mohave River in transitional pelage is provisionally referred to it. The collections of the Academy of Natural Sciences contain a large series of *Sitomys* from the neighboring regions of Southern California, and the same is undoubtedly the case with the collections of the Department of Agriculture; yet I find in *insolatus* no close correspondence to any other mouse I have yet seen or read description of.

¹ Proc. Linn. Soc., N. Y., 1894.

Sitomys herroni nigellus is an easily recognized mountain race of the long-and-naked tailed species, which I described a year ago from the San Bernardino Valley.

Sitomys macrochinus and *Sitomys keeni* were severally taken on the mainland coast and outlying islands of northern British Columbia, by the Rev. Mr. Keen, a missionary stationed on Graham Island of the Queen Charlotte Group. Their separation from each other, and from northwestern forms previously known, is based on an examination of more than one hundred skins and crania of *Sitomys* taken by me in 1892 at numerous localities in British Columbia and Washington, including a large series from Puget Sound at the type locality of *S. a. austerus*; also from Vancouver Island, Lulu Island, and the Cascade Mountains of Washington and British Columbia.

Sitomys americanus artemisiae is founded on a series similarly taken by the writer in the arid region east of the Cascade Mountains in southern British Columbia, comparisons being further made with series of *Sitomys* from Lac La Hache in the boreal realms, 100 miles farther north, and with those captured in the Selkirk and Rocky Mountain Ranges, eastward. *Artemisiae* is to the northern Great Basin fauna what *S. a. nebrascensis* is to that of the northwestern Great Plains.

The color characters given for these northwestern species are of greater diagnostic value, because nearly all the specimens were taken in May, June, and July, a period when seasonal changes of pelage are less pronounced than in a later or earlier period of the same duration.

Incidental to these studies, it is of interest to note the occurrence of a form, apparently inseparable from the Hudson Bay type of *Sitomys americanus arcticus*, upon the higher mountain ranges of southern British Columbia, thus adding a fifth member of the genus to the varied fauna of this great Province.

1. *Sitomys megacephalus* sp. nov. Type, ad. ♀, No. 3,535, Coll. Acad. Nat. Sci., Phila. Woodville, Alabama; Spring, 1894. Col. by H. E. Sargent.

Description.—Size large; feet small; ears large; tail about length of body without the head. Color above, dark blackish-cinnamon, lined with gray, darkest on back, brownest on sides. Lower surfaces dirty white, the hairs plumbeous basally. The tail is sparsely haired, and colored above and beneath to match the body. Inside of hams plumbeous. Hind feet white from heel; forefeet and fore-

arm white. The cinnamon of neck forms a point, downwards, invading the throat. Ears dusky and very sparsely haired. Whiskers long and coarse, reaching far behind the recumbent ears. Skull very large; its relative dimensions as in *S. americanus* with two notable exceptions, viz: 1, the alveolar length of molars is less than that of average *americanus*, though the skull of *megacephalus* is more than a third larger; 2, the coronoid process, always developed in *americanus* (and in all other *Sitomys* I have seen), as a reflexed, claw-like process, whose posterior face is *never* perpendicular, is reduced in *megacephalus* to a thickened knob rounded posteriorly and rising but slightly above the plane of the condylar shaft, and presenting a strong resemblance to the articular terminus of the condyle; in other words, having not only the appearance but the character of a miniature condyle set upon the base of the true one.

Measurements.—Total length, 184 mm; tail vertebrae, 81; hind foot, 21.5; ear from crown, 14. Skull—Total length, 30.2; basilar length, 23; zygomatic width, 15.5; length of nasals, 12; incisors to post-palatal notch, 12; length of mandible, 16.3; greatest width of mandible, 7.6.

I have selected from a series of forty Florida *S. a. gossypinus* and a series of nearly two hundred typical *S. americanus*, eight of the largest fully adult crania of each form. Average measurements of these, in the order just given above for the skull of *megacephalus*, are as follows:—

Sitomys americanus: 25.9—19.9—13.4—10—10.5—13.7—6.1.

S. a. gossypinus: 27.3—20.5—13.9—10.6—10.5—14.1—6.4.

It will be seen that the Alabama species has a skull nearly five millimeters longer than average adult *americanus*. It is furthermore about four millimeters longer than the longest skull of a series of three hundred of the *americanus* group which I have examined. Compared with *gossypinus*, whose average, it will be seen, somewhat exceeds typical *americanus*, the differences are still very great. The type is a very old female, which was sent, in company with two young (apparently her own), among a miscellaneous collection of alcoholic animals from Jackson County, northern Alabama. They were the only specimens of *Sitomys* sent by Mr. Sargent, and owing to his subsequent absence from the State, I have been unable to secure any more specimens, to determine if this be the prevailing form in that region. I have since received a large white-footed mouse from Pasco

County, Florida, whose characters so nearly duplicate those of the Alabama specimen, I am inclined, in spite of its different faunal position, to consider it the same. The colors given for *megacephalus* may be relied upon, though taken from a spirit specimen after drying. The good condition of the alcohol and the whiteness of the belly hairs show them not to have been affected in the least by their recent immersion. In the two half-grown young, accompanying the type, the same increased relative size of the cranium, compared with *americanus* of same age, is noticeable.

2. *Sitomys insolatus* sp. nov. Type, No. 3,495, ad. ♂, Coll. Acad. Nat. Sci., Phila. Oro Grande, Mohave Desert, Kern Co., California, Nov. 9th, 1893. Col. by R. B. Herron.

Description.—Size smallest of the genus west of the Mississippi River, with exception of *S. taylora*. Tail and feet very short, the former shorter than the body minus the head, much attenuated along distal half, the dark upper stripe very narrow and not reaching tip. Pelage very soft, long, and dense. Upper half of head and body of a uniform grayish-ochre or fawn color, not darker dorsally nor more ochraceous on sides. Under parts pure white, the hairs of chops white to their base, those of remaining under parts plumbeous basally. A lanuginous tuft at superior base of ear colored like the head, remainder of outer ear dusky gray, the hairs longest on anterior border, very short and sparse posteriorly. Narrow, upper tail-stripe dusky, like ears its color at base in decided contrast with the fawn of rump. Hind feet and ankles white, the soles fully haired to proximal tubercle. Forelegs and feet white. Whiskers reaching tip of recumbent ears. Skull smaller than in *americanus*, more nearly approaching *eremicus*, but relatively wider. Nasals wide, anterior to, and bluntly wedged between, the nasal premaxillary processes, as in *eremicus*.

The width of the mandible of *insolatus* equals nearly half its length, and the coronoid process is relatively nearly as large and hooked as in *Oryzomys ramona*, in the first character resembling *eremicus*, and in both departing radically from *americanus*. The anterior loop of the first upper molar is a strongly indented trefoil, the inner foil being twice as large as the middle one, which, in turn, is twice as large as the outer foil.

Measurements.—Total length, 158 mm; tail vertebrae, 76; hind foot, 19.5; ear from crown, 12. Skull—Total length, 24.8; basilar

length, 18·8; zygomatic width, 13; length of nasals, 9·8; incisors to post-palatal notch, 9·8; length of mandible, 12·8; greatest width of mandible, 6.

This mouse, of which I have received but one specimen among a considerable series of mammals from the same region, is strikingly different from any *Sitomys* that I have seen or can find description of. It is not merely a desert form of some group already known, but if more specimens prove its characters, as given above, to be constant, it represents a section intermediate in character between *Onychomys* and *Sitomys*. Its relationships, however, are much closer to *Sitomys*. In its six tuberculate hind feet, the elongate lower molar, the prominent coronoid process, and proportionate length of tail to body, *insolatus* is a *Baiomys*,² but the trefoil character of its first upper molar is in another direction. The subgenus *Baiomys*, separated from *Sitomys* almost solely on its well-developed coronoid and short tail, is of very questionable value, as many *Sitomys* show a tendency to the first character which have very long tails while other short-tailed species show the reverse. In fact a large series of *Sitomys americanus* from Pennsylvania and New Jersey, which I have studied, show individual variations in these characters among themselves, which suffice to very closely connect *Baiomys* with the typical form. In case further material should show the dental peculiarity of *insolatus* to be constant, I would propose that it be placed in the subgenus *Trinodontomys* (Subgen. nov.) with characters as already given.

3. *Sitomys herroni nigellus* subsp. nov. Type, No. 3,496, ad. ♂, Coll. Acad. Nat. Sci., Phila. West Cajon Pass, San Bernardino Mts., California, Jan. 11th, 1894. Col. by R. B. Herron.

Description.—General characters as in *Sitomys herroni*,³ the buffy-gray of that species being deeply lined and shaded in the subspecies by a predominance of long black hairs, the blackish shade being most pronounced across the posterior half of body. The pelage is longer, denser, and more harsh than in *herroni*, the tail and ears much darker, the buff of sides and cheeks of *herroni* becoming in *nigellus* deep fawn and the buffy cast of belly purer white. Skull as in *herroni*.

² True, Proc. Nat. Mus., XVI, 757.

³ Rhoads, Amer. Nat., 1893, 832.

Measurements.—Total length, 197mm.; tail vertebrae, 114; hind foot, 22. Skull—Total length, 26·2; basilar length, 19; zygomatic width, 12·7; length of nasals, 9·2; incisors to post-palatal notch, 10; length of mandible 13·1; greatest width of mandible, 6·1.

Four specimens of this race were taken on the foothills of the San Bernardino Range at the entrance to Cajon Pass connecting the San Bernardino Valley with the Mohave Desert. They represent the dark mountain form of *herroni*, the latter being typical of the lowlands. The four specimens are remarkably uniform in all the characters given.

4. *Sitomys keeni* sp. nov. Type, No. 768, ad. ♀, Coll. S. N. Rhoads. Maset, Queen Charlotte Is., B. C., 1892. Col. by Rev. J. H. Keen.

Description.—Size larger than *S. americanus austerus*, ears smaller, feet much larger, tail more than the length of head and body. Colors above, uniform grizzled blackish-brown lacking the darker dorsal area so prominent in *austerus*. Feet and lower parts ashy-white, abruptly defined against dark upper colors. Ears, upper half of tail, and ring around eyes, sooty black. Fur dense and short, this character and the colors of upper parts giving it an Arvicoline cast. Skull large for size of body. Brain case relatively very large, deep, and rounded, inflated behind above plane of the orbits as the skull rests on a horizontal surface, so there is a decided descent from a point just anterior to the parietals toward the nasal bones and a depression at the interorbital constriction. In all other forms examined this horizontal elevation of the parietals is not greater than that of the frontals between the orbits, and is often less. The nasals are short, double-pointed, and broadly wedged posteriorly and not reaching behind the naso-premaxillary processes. The anterior zygomatic width is much narrower than the squamosal, and the antorbital foramina are thereby much contracted, giving the skull a more tapering, triangular contour than in allied forms. The ratio of squamosal-zygomatic breadth to total length in *keeni*, expressed in millimeters, is 14·3 to 26·3, in *austerus* 12·5 to 25. In *keeni* the greatest parietal breadth is 12·5, in *austerus* 11.

Measurements. (From spirit specimen.)—Total length, 170 mm; tail vertebrae, 88; hind foot, 24; ear, from crown, 10·5. Skull—Total length, 26·3; basilar length, 20·5; zygomatic width, 14·3; length of nasals 10·2; incisors to post-palatal notch, 11·3; length of mandible, 14; greatest width of mandible, 6·3.

Five specimens of this mouse, two adult and three somewhat immature, were received by me through courtesy of Mr. James Fletcher, of the Canadian Experimental Farm, at Ottawa. Mr. Fletcher received them from Mr. Keen, who resides on the Queen Charlotte Islands. I take pleasure in naming the animal after its discoverer, and trust it may be some incentive to more extended researches in this interesting and imperfectly known department of northwest zoology.

The specimens were sent in carbolized spirits. The purity of the white after drying them out, shows their colors not to have altered, and indicates that a series of well-preserved skins would show *keeni* to be the darkest colored *Sitomys* yet brought to notice, a condition of affairs which our knowledge of their humid, insular environment would lead us to expect.

5. *Sitomys macrorhinus* sp. nov. Type, No. 1,381, ad. ♀, Coll. S. N. Rhoads. Skeena River, British Columbia, July 20th, 1893. Col. by Rev. J. H. Keen

Description.—Size much larger than *S. americanus*. Tail considerably longer than head and body, feet large, ears medium. Colors much as in *keeni* (l. c.), but grayer and lighter hued above, without the sooty cast of *keeni*. The tail is more coarsely hairy and the hairs longer than in *keeni*, forming a distinct pencil not seen in that species. Skull, viewed above, of the same triangular type as *keeni*, due to its antorbital constriction, but departing widely from any other *Sitomys* I have examined, in the great relative length of the rostrum (or that portion of the skull anterior to the interorbital constriction) to the total length of the skull. In all others examined this dimension is less than that of the post interorbital region, taking for the central point of measurement the narrowest constriction point of the frontals. In *macrorhinus* this condition is reversed. The relative length of the nasal bones in this species is not great, but the slenderness of the rostrum and the anterior compression of the jugal arch increases their apparent length and the relative prominence of this portion of the cranium. These differences, coupled with the large size of the skull, strongly define *macrorhinus* from any of its geographic allies.

Measurements.—Total length, 210 mm; tail vertebrae, 112; hind foot, 25; ear from crown, 15; tail pencil, 6. Skull—Total length, 29; basilar length, 22.4; zygomatic width, 14.5; length of nasals,

11.9; incisor to post-palatal notch, 12.4; length of mandible, 14.5; greatest width of mandible, 6.8.

Two adult, nursing females of this species, were sent to Mr. Fletcher, of the Ottawa Experimental Farm, by Mr. Keen, and were forwarded to me in spirits. Their grayness, large size, and long tails serve to distinguish them externally from any other boreal or northwestern form I know of. Eight specimens of *Sitomys*, trapped at an elevation of 6,000 feet, on the Cascade Mountains of northern Washington, are, perhaps, referable to this species. They depart therefrom in somewhat smaller size, but in all other respects are much nearer to it than to *austerus*, of Puget Sound. The climatic conditions of the Cascades where these were taken, are, with the exception of a more rigorous winter, quite the same as those prevailing at Skeena Harbor, the type locality of *macrorhinus*.

6. *Sitomys americanus artemisiæ* sp. nov. Type, No. 368, ad. ♂, Coll. S. N. Rhoads. Ashcroft, British Columbia, June 5th, 1892. Col. by S. N. R.

Description.—Size large, exceeding typical *americanus*. Tail short, hardly equalling body without the head. Ears medium and sparsely haired. The hind feet are small and densely haired to the distal half. Colors above, tawny ash, inclining to fulvous on sides and rump and darkening with an increase of blackish hairs along the back. Upper third of tail sooty, the lower two-thirds white and tipped with a pronounced pencil. Lower parts a soft, clear white, with basal half of belly hairs plumbeous.

Measurements.—Total length, 170 mm; tail vertebrae, 70; hind foot, 20 (average of 8 adults—Total, 164; tail, 68; foot, 20). Skull—Total length, 26; basilar length, 20; zygomatic width, 102; length of nasals, 11.1; incisor to post-palatal notch, 11; length of mandible, 14; greatest width of mandible, 6.8.

The nearest ally of this subspecies is probably *S. a. nebrascensis*, as defined by Dr. Mearns,¹ from specimens taken at Calf Creek, Montana, from which it differs in not having dark well-haired ears and in the absence of white patches in front of ears. With *nebrascensis* it coincides in short tail, larger body, long full pelage, hairy sole, and light colors as contrasted with *americanus* of the east and *austerus* of the west. The Ashcroft specimens represent the northern limit of a Great Basin form of *americanus*, whose habitat probably extends far

¹ Bull. Amer. Mus. N. H., Vol. II, Art. xx, 285.

into the United States, at least to southern Idaho, western Washington, and Oregon. *Nebrascensis* represents that of the western Plains. It is probable that *artemisia* is included in the list of "*Hesperomys leucopus*," given by Dr. Merriam in N. American Fauna, No. 5, from Idaho, which he states may "eventually merit separation into two or three subspecies."

Artemisia was taken in the open, semi-arid foothills and lower mountain slopes around Ashcroft, their burrows often being situated on a bare hillside, a mile or more from other shelter than that afforded by the scant growth of dwarf sage, which here nearly reaches its northernmost limit of existence.

NOTE ON *SITOMYS AMERICANUS ARCTICUS*.

The series of White-footed Mice taken at Nelson, in the Selkirk Mountains, B. C., and at Field, in the Rocky Mountains, B. C., at elevations of from 3,000 to 5,000 feet, fit so well Dr. Mearns' diagnosis (vid. sup. cit.) of *S. a. arcticus* from the Hudson Bay Territory, I feel almost assured, without the type before me, that they are the same.

Those from Vernon, a locality intermediate in its faunal characters between those of Ashcroft and Field, are intergrades between *artemisia*, with its short tail and light fulvous colors, and *arcticus*, with longer tail and dark mouse-gray shades. It is reasonable to expect that the vast boreal regions of interior N. America, bounded on the east by Hudson Bay, on the west by the Cascade Mountains, and south by the higher mountain ridges which invade the northern border of the United States, is tenanted by no other race or species of the *S. americanus* type than *arcticus*.

DESCRIPTIONS OF EIGHT NEW POCKET MICE (GENUS PEROGNATHUS).

BY DR. C. HART MERRIAM.

Among the Pocket Mice belonging to the collection of the U. S. Department of Agriculture, now numbering upwards of 1,400 specimens, are several that have not been named. Through the courtesy of the Assistant Secretary of Agriculture, Dr. Chas. W. Dabney, Jr., I am enabled to publish the accompanying descriptions and illustrations in advance of their publication by the Department.

Respecting the eight forms here proposed, it may be stated that *P. baileyi* is a type very different from any heretofore described. It is a large animal with a peculiar skull, which suggests affinities with *P. paradoxus* on one hand, and with *P. formosus* on the other, though much nearer the latter than the former. *P. columbianus* is a peculiar local form of the *olivaceus* group. *P. nevadensis*, *panamintinus*, and *mexicanus* are small forms with much swollen mastoids, belonging to the *flavus-longimembris* group. *P. nelsoni*, *stephensi*, and *caucescens* belong to the *penicillatus* group of the subgenus *Chatodipus*.

The large series of specimens from Mexico, in the Department collection, carry the range of the genus southward over Sonora in the west, and in the east over the states of Chihuahua, Coahuila, Tamaulipas, Durango, San Luis Potosi, Zacatecas, and the Valley of Mexico.

Perognathus baileyi sp. nov. (Fig. 1).

Type from Magdalena, Sonora, Mexico. No. $\frac{17,838}{24,775}$ ♀, ad., U. S. Nat. Museum, Department of Agriculture Collection. Collected November 3, 1889, by Vernon Bailey. (Original number 633.)

Measurements (taken in flesh).—*Type*: Total length, 210 mm; tail vertebrae, 122; hind foot, 27. Ear from anterior base, 11 (in dry skin). Average measurements of 8 specimens from type locality: Total length, 215; tail vertebrae, 120; hind foot, 27.

General characters.—Size large; tail long and moderately crested

on distal half; pelage moderately coarse, but no spines on rump or elsewhere; ears large; tragus higher than broad; hind foot very large; skull unlike any known species. *P. baileyi* is a wide departure from the previously known members of the group. Externally it resembles *P. formosus*, but its skull is of a different type, resembling that of *paradoxus* in size, height, solidity, and general form, but having the large audital and mastoid bulke of *formosus*.

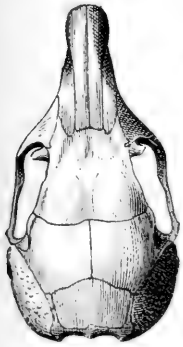

Fig. 1. *P. baileyi*.

Color.—Upper parts drab-brown, abundantly lined with black hairs; under parts white; a pale lateral stripe; tail bicolor, pale dusky above, white beneath.

Cranial characters.—Skull large, heavy, and high, resembling *paradoxus* in general form and solidity, but with much larger mastoid and audital bullae, the latter nearly meeting anteriorly below basisphenoid; interparietal squarely pentagonal, broadest anteriorly, ratio of length to breadth about 64. Total length of skull of type specimen, 29.5; mastoid breadth, 15.5; basal length, 24; basilar length of hensel, 20.5; greatest zygomatic breadth (posteriorly), 15.5; length of nasals, 11.5.

NOTE.—Specimens have been examined from Magdalena, Sonora, and from New River, Mammoth, and a point 75 miles S. W. of Tucson, in Arizona.

***Perognathus columbianus* sp. nov. (Fig. 2).**

Type from Pasco, Plains of Columbia, Washington (on east side of Columbia river, near mouth of Snake river). No. ^{57,351}/_{39,450}, ♂, yg. ad., U. S. Nat. Museum, Department of Agriculture Collection. Collected May 9, 1891, by Clark P. Streater. (Original number 768.)

Measurements (taken in flesh).—*Type*: Total length, 187 mm; tail vertebrae, 96; hind foot, 23. Ear from anterior base, 9 (in dry skin). Average measurements of 11 specimens from type locality: Total length, 170; tail vertebrae, 89.4; hind foot, 22.

General characters.—Size large; coloration pale; tail long, tapering, rather scant haired; mastoid bulke much swollen; pelage soft.

Color.—Upper parts smoke gray, darkened on the back by admix-

ture of dark tipped hairs and sometimes showing an olivaceous tinge; under parts and feet white; lateral stripe faint; tail bicolor, white below, dark above, but pale on proximal half. Some specimens have a pale fulvous band along the side of the tail between the dark upper side and the white under side.

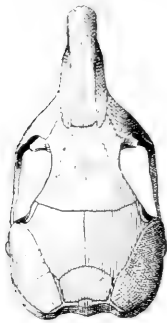

Fig. 2. *P. columbianus*, ♂.

Cranial characters.—Skull large, and agreeing in the main with other members of the *olivaceus* group, but differing in the large size of the mastoid bullæ, which are much more swollen than in any of the others. The audital bullæ meet or nearly meet anteriorly below the basisphenoid. The interparietal is strongly pentagonal and short transversely.

Perognathus nevadensis sp. nov. (Fig. 3).

Type from Halleck, East Humboldt Valley, Nevada. No. 54,828, ♂, ad., U. S. Nat. Museum, Department of Agriculture Collection. Collected July 4, 1893, by Vernon Bailey. (Original number 4,070.)

Measurements (taken in flesh).—*Type*: Total length, 127 mm; tail vertebrae, 72; hind foot, 19. Ear from anterior base 7 (in dry skin). Average measurements of 24 specimens from type locality: Total length, 133; tail vertebrae, 72.4; hind foot, 18.7.



Fig. 3. *P. nevadensis*.

General characters.—Size small; tail long; pelage silky; color grayish. Similar to *P. longimembris* but with shorter tail, and color grayish instead of buffy ochraceous.

Color.—Upper parts buffy gray, everywhere darkened by an abundant admixture of fine black-tipped hairs; a dull buffy-ochraceous lateral stripe which spreads out over the belly, leaving only the throat and pectoral region white; tail indistinctly bicolor, dark above (darkest near tip), buffy ochraceous below.

Cranial and dental characters.—Skull small, mastoid bullæ large; interparietal pentagonal. Skull similar to that of *P. longimembris*, but lower premolar decidedly larger than last molar, and m_1 larger than m_2 .

Perognathus longimembris panamintinus subsp. nov. (Fig. 4).

Type from Perognathus Flat, Panamint Mts., California. No. 27,767, δ , yg. ad., U. S. Nat. Museum, Department of Agriculture Collection. Collected April 16, 1891, by Vernon Bailey. (Original number 2,675.)

Measurements (taken in flesh).—*Type*: Total length, 152 mm; tail vertebræ, 83; hind foot, 20. Ear from anterior base 7 (in dry skin). Average measurements of 29 specimens from type locality: Total length, 143; tail vertebræ, 78; hind foot, 19.8.

General characters.—Size small; pelage silky; tail long, decidedly longer than head and body; skull long and slender, particularly the rostrum. Compared with *longimembris* the ground color of the upper parts is paler (pale buffy ochraceous instead of pale fulvous), but the upper parts as a whole are darker from the more liberal admixture of black-tipped hairs; the ears are smaller, the hind feet longer, the tail much longer and better haired; the pelage longer and more silky.

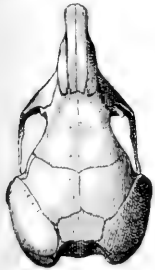

Fig. 4. *P. panamintinus*.

Color.—Ground color of upper parts pale ochraceous-buff, everywhere (except on lower sides) obscured by black tipped hairs; under parts and feet white; tail incompletely bicolor: dull ochraceous below, dark above. Sometimes the proximal half is concolored all around, the distal half only being dark above.

Cranial characters.—Skull similar to that of *longimembris* in general characters, but much longer and more slender, particularly the rostral part. The pentagonal interparietal is broader transversely than in *longimembris*, and the audital bullæ meet anteriorly in a symphysis.

Perognathus flavus mexicanus subsp. nov. (Fig 5).

Type from Tlalpam, Valley of Mexico (Federal District.) No. 50,714, yg. ad., U. S. Nat. Museum, Department of Agriculture Collection. Collected December 4, 1892, by E. W. Nelson. (Original number 3,978.)

Measurements (taken in flesh).—*Type*: Total length, 118 mm; tail vertebræ, 55; hind foot, 17.5. Ear from anterior base 6 (in dry skin). Average measurements of 12 specimens from type locality: Total length, 116; tail vertebræ, 53.7, hind foot, 17.4.

General characters.—Size small; mastoid bullæ large; color fuliginous in winter pelage.



Fig. 5. *P. mexicanus*.

Color.—Winter pelage: Upper parts fuliginous or dusky; under parts and feet white; a rather large patch behind each ear, and a broad lateral stripe (reaching from side of face to hind legs) ochraceous; tail indistinctly bicolor, pale dusky above, whitish beneath. Summer pelage: Upper parts ochraceous, obscured by the profuse admixture of black-tipped hairs.

Cranial characters.—Skull as in *P. flavus*, but auditory bullæ separated anteriorly by breadth of basisphenoid.

Perognathus (Chætodipus) nelsoni sp. nov. (Fig. 6).

Type from Hacienda La Parada, San Luis Potosi, Mexico. No. 50,214, ♀, old, U. S. Nat. Museum, Department of Agriculture Collection. Collected August 19, 1892, by E. W. Nelson. (Original number 3,207.)

Measurements (taken in flesh).—*Type*: Total length, 190 mm; tail vertebrae, 105; hind foot, 24. Ear from anterior base, 8 (in dry skin). Average measurements of 14 specimens from type locality: Total length, 178; tail vertebrae, 101; hind foot, 23.

General characters.—Size rather small; ears rather long; tail of medium length and moderately crested on distal half; pelage rather coarse, with a few slender spines on the rump (the spines are absent in the young and in certain conditions of the molt). Apparently *C. nelsoni* is an offshoot from the *intermedius-obscurus* type, from which it differs widely in external appearance and less markedly in cranial characters.



Fig. 6. *P. nelsoni*.

Color.—Summer pelage coarse: Upper parts grizzled yellowish-brown from admixture of coarse buffy and black hairs. Winter pelage finer, and grayish black in color. Under parts and feet white; tail bicolor, white below, brownish-dusky above, becoming blackish distally.

Cranial characters.—Skull similar to that of *intermedius*, but somewhat larger; maxillary arms of zygomata more squarely spreading; nasals decidedly larger and longer.

Perognathus (*Chætodipus*) *stephensi* sp. nov. (Fig. 7).

Type from N. W. Arm of Death Valley (Mesquite Valley), California. No. $\frac{27,774}{38,873}$, ♂, ad., U. S. Nat. Museum, Department of Agriculture Collection. Collected April 6, 1891, by Frank Stephens. (Original number 258.)

Measurements (taken in flesh).—*Type*: Total length, 177 mm; tail vertebrae, 96; hind foot, 21. Ear from anterior base, 7.5 (in dry skin). Average measurements of 2 specimens from type locality: Total length, 177; tail vertebrae, 95; hind foot, 21.

General characters.—Size small; tail vertebrae slightly longer than head and body; tail scantily crested; ears medium; tragus higher than broad; pelage rather soft; no spines on rump or elsewhere.

This species is evidently a dwarf of the *penicillatus* group, though the area it inhabits is completely isolated from the range of the *penicillatus* type.

Color.—Upper parts buffy-drab varying to pale drab-brown; a rather large pale ring around eye; under parts, feet, and fore legs white; no lateral line; tail bicolor, slightly darker than back above and terminally, white beneath.



Fig. 7. *P. stephensi*.

Cranial characters.—Skull similar to that of *intermedius*, but much smaller and flatter, with interparietal broadly and flatly pentagonal instead of strap shaped, and audital bullae more slender. In size and general form the skull agrees most closely with *arenarius* from the middle region of the Peninsula of Lower California. It differs from *arenarius* in having the rostrum and nasals much broader and the audital bullae much less swollen.

Perognathus (*Chætodipus*) *intermedius canescens* subsp. nov.

Type from Jaral, Coahuila, Mexico. No. 51,016, ♂, yg. ad., U. S. Nat. Museum, Department of Agriculture Collection. Collected January 14, 1893, by Clark P. Streater. (Original number 2,557.)

Measurements (taken in flesh).—*Type*: Total length, 193 mm; tail vertebrae, 117; hind foot, 22. Ear from anterior base, 8 (in dry skin). Average measurements of 2 specimens from type locality: Total length, 189; tail vertebrae, 111; hind foot, 22.

General characters.—Similar to *intermedius*, but slightly larger and much grayer.

Color.—Upper parts drab-gray, plentifully lined with dusky on median part of back and over rump; under parts and feet white; lateral line obsolete; tail bicolor, brownish above, becoming dusky distally; white beneath.

Cranial characters.—Skull similar to *C. intermedius obscurus*, but narrower anteriorly (across maxillary arms of zygomata); interparietal broader antero-posteriorly; ascending branches of premaxillæ reaching posteriorly behind nasals; frontals considerably narrower between orbits.

ILLUSTRATIONS.

(Skulls all enlarged $1\frac{1}{2}$.)

- Fig. 1. *Pecognathus baileyi*, ♀, No. 24,775. Type. Magdalena, Sonora, Mexico.
- Fig. 2. *P. columbianus*, ♂, No. 39,450. Type. Pasco, Washington.
- Fig. 3. *P. nevadensis*, ♂, No. 54,565. Halleck, Nevada (type locality).
- Fig. 4. *P. longimembris panamintinus*, ♂, No. 39,866. Type. Panamint Mts., Calif.
- Fig. 5. *P. flavus mexicanus*, ♀, No. 50,713. Tlalpam, Valley of Mexico (type locality).
- Fig. 6. *P. (Chatodipus) nelsoni*, ♀, No. 50,214. Type. Hacienda La Parada, San Luis Potosi, Mexico.
- Fig. 7. *P. (Chatodipus) stephensi*, ♀, No. 39,874. N. W. Arm Death Valley, Calif. (type locality).

SEPTEMBER 4.

MR. CHARLES MORRIS in the chair.

Twenty-three persons present.

SEPTEMBER 11.

MR. CHARLES P. PEROT in the chair.

Nineteen persons present.

The death of H. T. Cresson, September 6, 1894, was announced.

SEPTEMBER 18.

MR. CHARLES MORRIS in the chair.

Twenty-five persons present.

SEPTEMBER 25.

MR. CHARLES P. PEROT in the chair.

Twenty-nine persons present.

Papers under the following titles were presented for publication:—

“Descriptions of a New Subgenus and New Species of Arvicoline Rodents from British Columbia and Washington,” by Samuel N. Rhoads.

“Recent Mound Exploration in Ohio,” by Clarence B. Moore.

“List of the Diptera of Jamaica, with Descriptions of New Species,” by Charles W. Johnson.

Observations on Blarina brevicauda.—DR. HARRISON ALLEN drew attention to several structural features in this animal. The lower jaw articulates with the skull, not only by the temporo-mandibular joint, but by a sphenoido-mandibular. The one last named was described as being much the larger and apparently more important of the two. The mandibular surface is placed on the inner side of the ascending ramus, and the sphenoidal surface is situated at

the base of the pterygoid process. It forms a deep recess, the mouth of which is directed outward, the bases of the pterygoid processes are convex and opposed to one another on either side of the mesopterygoid fossa. The occipital condyles are without division: the appearance is quite the same as in the Cetacea, and suggests a similar mechanism of the atlanto-occipital joint, namely, a cranium which is deviated scarcely at all from a horizontal plane. The anterior annular ligament of the ankle-joint is ossified, and constitutes part of the tibia. The astragalus is nearly flat on proximal surface, and the patellar trochlea is low and wide. These two characters probably co-ordinate, and establish *Blarina* as an animal whose posterior extremity is of low specialization, and one which supports the trunk imperfectly. The absence of the pubic symphysis probably is associated with the above conditions. The biceps femoris and gracilis constitute one muscle, and the two enclose the slender semitendinosus in a manner suggestive of the tenuissimus of *Lepus*.

The following were ordered to be printed:—

LIST OF THE DIPTERA OF JAMAICA WITH DESCRIPTIONS
OF NEW SPECIES.

BY CHARLES W. JOHNSON.

This list is based on a collection made by Mr. Wm. J. Fox and myself, during April and the early part of May, 1891. In addition to those collected and identified, I have added all the species previously recorded from the Island. The latter are designated by an asterisk (*). To Mr. D. W. Coquillett, Mr. C. H. Tyler Townsend, and Mr. Samuel Henshaw I wish to express my sincere thanks for kind assistance.

CECIDOMYIDÆ.

One specimen resembling the genus *Catocha*. Port Antonio.

BIBIONIDÆ.

**Plecia rufithorax* Walker, List, etc., I, 116.

CULICIDÆ.

Culex fasciatus Fabricius, Syst. Antl., 36, 13.

Culex mosquito R. Desv., Culicidæ, etc., 390.

Troublesome in the woods near Hope Bay.

Culex sp.

Port Antonio.

TIPULIDÆ.

**Geranomyia intermedia* Walker.

Limnobia intermedia Walker, List, etc., I, 47.

Four imperfect specimens of a species belonging to this family were collected at Kingston.

STRATIOMYIDÆ.

Hermetia illucens Linné. For synonymy, see Osten-Sacken, Catl. 46.

Four specimens, Port Antonio.

**Oxycera Liburna* Walker, List, etc., III, 528.

Macrosargus alchidas Walker.

Sargus alchidas Walker, List, etc., III, 517.

Five ♂ and four ♀. Port Antonio. The male agrees with

Walker's description. As both sexes were taken the same day and at the same spot, along a path in the hills back of the town, I have no doubt but that they are the same species, though the female differs considerably from the male. The following is a description of the female, which has not been described:—

Length 8 mm. Face and front yellowish; vertex green; oral margins brownish; antennæ reddish; aristæ black. Thorax and scutellum green; a slender line of yellow extends from the humeri to the base of the wings (also present in the male). Abdomen much wider than in the male, bluish-green, second segment concave at the sides, with a central yellow spot at the base; pubescence on the posterior borders of the segments more prominent than in the male. Venter bluish, the second segment, and the posterior margin of the third and fourth narrowly margined with yellow. Front and middle legs yellow; posterior femora with outer half of the tibiæ and tarsi brownish-black, base of the femora and basal half of the tibiæ and tarsi yellow. In the color of the posterior legs occurs the greatest difference, though the outer portions of the femora, tibiæ, and tarsi of the male are noticeably darker.

**Sargus Bagosa* Walker, List, etc., III, 518.

†*Clitellaria anchialus* Walker, List, etc., III, 522.

Var.? *Clitellaria chalybeæ* Wied., according to Walker, List, etc., IV, 1157.

Nemotelus flavicornis n. sp.

Length (♂) 2½ mm. Face and vertical triangle black, shining. Facial protuberance prominent, conical; antennæ yellow. Facets of the upper half of the eye double the size of those of the lower. Thorax and scutellum greenish-black, shining; humeri, and a narrow line from there to the base of the wings, yellow. Abdomen yellow, with a small black subtriangular spot in the center of the fourth and fifth segments; venter yellow. Legs yellow, posterior femora and tibiæ with a wide medial band of dark brown. Wings hyaline, whitish, discal cell emits four veins.

One specimen, Kingston.

TABANIDÆ.

Chrysops costatus Fabricius.

Tabanus costatus Fabr., Ent. Syst., IV, 373, 45.

Tabanus variegatus DeGeer, VI, Tab. XXX, f. 7. "Synon. very probable" (Osten-Sacken).

Two specimens, Port Antonio.

**Tabanus lucidulus* Walker, List, etc., I, 188.

**Tabanus rufiventris* Macquart, Dipt. Exot., I, I, 141, 39. Walker, List, etc., I, 180.

LEPTIDÆ.

**Pheneus tibialis* Walker, Dipt. Saund., 156, Tab. IV, f. 3.

“Mr. Walker refers this genus to the Asilidæ; I place it here on the authority of Mr. Loew (*in litt.*)”—Osten-Sacken.

Chrysopila jamaicensis n. sp.

Length, ♂ ♀, 4 mm. Face and front brownish-black. Antennæ, and proboscis reddish; terminal style nearly three times the length of the antennæ. Thorax dull black; male with golden pubescence; humeri and scutellum brownish, pleuræ grayish, abdomen blackish; male with golden pubescence; a denuded specimen shows the basal half of the second segment to be yellow; female with a yellowish lateral line, slightly interrupted at the base of the segments; ovipositor yellow, tip brown. Legs yellow, with minute blackish hairs on the tibiæ and tarsi, yellowish on the femora; a preapical spot on the posterior femora and terminal joints of the tarsi blackish. Wings hyaline, veins and stigma brown.

Seven specimens, Port Antonio.

ASILIDÆ.

Leptogaster longipes n. sp.

Length, ♀, 9 mm. Face and front grayish; a few long yellow hairs above the oval margin; ocelli and proboscis black; antennæ dark brown. Dorsum of the thorax brownish, with three longitudinal black lines; the dorsal one gradually tapering towards the posterior; lateral lines irregular, widest on the anterior side of the suture. Pleuræ and scutellum grayish. Abdomen black, with thin, short, yellowish pubescence, longest on the sides of the last segments; anterior and posterior margins of the segments grayish, thus forming somewhat obscure bands. Legs brownish, coxæ yellowish, basal joint of the front and middle tarsi (except the tip) light yellow; posterior legs double the length of the middle ones, the outer third of the femora greatly enlarged, and the enlarged portion encircled by two yellow bands; tip of the tibiæ, and of all the tarsal joints blackish. Wings hyaline, veins blackish.

One specimen, Port Antonio.

Plesiomma indecora Loew, Centur., VII, 13.

Two specimens, Kingston, April; Morant Bay, May 7.

Cerotainia macrocera Say.

Laphria macrocera Say, Journ. Acad. Nat. Sci., Phila., III, 73.

Eight specimens, Port Antonio. The specimens collected differ from those found in the vicinity of Philadelphia, in being of a more bluish-black color, and on an average somewhat smaller.

Erax Halæsus Walker.

Asilus Halæsus Walker, List, etc., III, 405.

One specimen, Bath (Mrs. Swainson).

***Erax invariatus** Walker, Dipt. Saund., 131.

Ommatius saccas Walker, List, etc., II, 474.

Eight specimens, Port Antonio.

BOMBYLIDÆ.

Hyperalonia proserpina Wiedemann.

Anthrax proserpina Wied., Auss. Zw. Ins., I, 257.

Exoprosopa proserpina Schiner, Reise d. Novara Zool., III, Abth. I, 117.

Anthrax Klugii Wied., Auss. Zw. Ins., II, 632.

Anthrax rufescens Walker, List, etc., III, 238.

Two specimens, Kingston; Bath.

Hyperalonia cerberus Fabricius.

Anthrax cerberus Fabr., Ent. System, IV, 256.

Velocia cerberus Coquillett, Can. Entom., XVIII, 157; *ibid.*, XIX, 12.

One specimen, Morant Bay.

Exoprosopa parva Loew, Centur., VIII, 26.

One specimen, Kingston.

***Exoprosopa ignifer** (Walker) Osten-Sacken, Catl., 86.

Anthrax ignifer Walker, List, etc., II, 243.

“Walker contradicts himself about this species; in the Dipt. Saund., page 166, he places it among the species with two sub-marginal cells: later, he puts it in Wiedemann’s Division I, the species of which have three such cells.”—Osten-Sacken. As this remark also applied to *Anthrax trimacula*, this species may also be a true *Anthrax*.

***Exoprosopa subfascia** Walker.

Anthrax subfascia Walker, List, etc., II, 249.

Argyramœba Œdipus Fabricius.

Anthrax Œdipus Fabr., System. Antl., 123, 22.

Anthrax irrorata Say, Journ. Acad. Nat. Sci. Phila., III, 46.

Anthrax irrorata Macquart, Dipt. Exot., II, 1, 60, Tab. XX, f. 6.

Two specimens, Kingston.

**Argyramœba Gideon* Fabricius Walker; List, etc., II, 257. ("Var.? abdomen all black.")

Anthrax lateralis Say.

Anthrax Bastardi Macquart, Dipt. Exot., II, 1, 60, 13.

Anthrax alternata Say, var. *lateralis* Say, Coquillett, Trans. Am. Ent. Soc., XIV, 166.

Four specimens, Kingston.

Anthrax lucifer Fabricius.

Anthrax flumiflamma Walker, Dipt. Saund., 184.

Common at Rock Fort, near Kingston.

Anthrax trimacula Walker, List, etc., II, 250.

Exoprosopa trimacula (Walker), Osten-Sacken, Catl. 87.

Thirteen specimens, Kingston, Port Antonio, and Annotto Bay.

Anthrax bigradata Loew, Centur., VIII, 37.

?*Anthrax albovittata* Macq., Dipt. Exot., 4, Suppl., 113, 90.

One specimen, Kingston.

**Anthrax delicatula* Walker, List, etc., II, 266.

**Bombylius plumipes* Drury, Illustr., etc., II, Tab. xxxix, fig. 3; Wiedemann, Auss. Zw. I, 351, 50.

Geron senilis Fabricius.

Bombylius senilis Fabr., Ent. System., IV, 411, 17; System. Antl., 135, 31.

Geron albidipennis, Loew, Centur., IX, 78 [Coquillett].

Geron vitripennis Loew, Centur., IX, 77 [Coquillett].

Two specimens, Kingston.

THEREVIDÆ.

Psiilocephala obscura Coquillett, Can. Entom., XXV, 229.

One specimen, Kingston; April.

EMPIDÆ.

**Tachydromi Bacis* Walker.

Platypalpus Bacis Walker, List, etc., III, 510.

DOLICHOPODIDÆ.

Psilopus chrysoprasius Loew, Neue Beitr., VIII, 87; Monogr. II, 258.

Psilopus chrysoprasia Walker, List, etc., III, 646 [Loew].

Three specimens, Kingston; common, Port Antonio.

Psilopus jucundus Loew, Neue Beitr., VIII, 87; Monogr. II, 258.

Psilopus slypho Macquart, Dipt. Exot., II, 2, 149, Tab. 21, f. 1 [Loew].

Four specimens, Kingston; Port Antonio.

**Psilopus suavium* Walker, List, etc., III, 648.

SYRPHIDÆ.

**Chrysotoxum nigrita* Fabricius.

Syrphus nigritus Fabr., Ent. System., IV, 292, 49.

Multo nigrita Fabr., System. Antl., 183; Wiedemann, Auss. Zw., II, 88.

**Syrphus antipathes* Walker, List, etc., III, 589.*Mesograpta arcifera* Loew.

Mesogramma arcifera Loew, Centur., VI, 52.

Common, Kingston; Port Antonio.

Mesograpta subannulata Loew.

Mesogramma arcifera Loew, Centur., VI, 48.

Eleven specimens, Kingston; Port Antonio.

Mesograpta pœcilogaster Loew.

Mesogramma pœcilogaster Loew, Centur., VI, 51.

Four specimens, Port Antonio.

Mesograpta laciniosa Loew?

Mesogramma laciniosa Loew, Centur., VI, 50.

One specimen, Port Antonio.

Baccha clavata Fabricius.

Syrphus clavata Fabr., Ent. System., IV, 289.

Baccha Babista Walker, List, etc., III, 549.

Baccha fascialis Thomson, Eugen. Resa, Ins., 504.

Spazigaster bacchoides Bigot, Ann. Soc. Ent. Fr., 1883, 326.

Six specimens, Rock Fort, near Kingston.

Baccha latiuscula Loew.

Ocyptamus latiuscula Loew, Centur., VII, 68.

One specimen, Kingston.

Volucella pallens Wiedemann, Auss. Zw. Ins., II, 264.

Volucella sexpunctata Loew, Wien. Ent. Monatschr., V, 39.

One specimen, Port Antonio.

Volucella obesa Fabricius.

Syrphus obesus Fabr., Syst. Ent., 763, 5.

Ornidia obesa St. Fargeau and Serville, Encycl. Meth., X, 786.

Volucella azurea Phyllipi, Verh. zool.-bot. Gesell., 1865, 734, pl. xxvi, f. 35.

Common, Port Antonio.

Volucella (Temnocera) purpurascens Loew.

Temnocera purpurascens Loew, Centur., VIII, 52.

Two specimens, Kingston.

Eristalis vinetorum Fabricius.

Syrphus vinetorum Fabr., Ent. Syst., Suppl., 562.

Eristalis trifasciatus Say, Journ. Acad. Nat. Sci., Phila., VI, 165.

Eristalis uvarum Walker, List, etc., III, 623.

Common, Port Antonio.

Eristalis albifrons Wiedemann, Auss. Zw. Ins., II, 189.

Eristalis albiceps Macquart, Dipt. Exot., II, 56.

Eristalis seniculus Loew, Centur., VI, 63.

Common, Port Antonio.

Eristalis atrimanus Loew, Centur., VI, 62.

Two specimens, Port Antonio.

***Eristalis lateralis** Walker, Linn. Trans., XVII, 347, 42. Walker, List, etc., III, 622.

Pteroptila cincta Drury.

Musca cincta Drury, Ins., I, 109, Tab. XLV, f. 6.

Syrphus pinguis Fabricius, Syst. Ent., 763, 6; Ent. Syst., IV, 282, 16.

Eristalis pinguis Fabricius, Syst. Antl., 233, 6; Wiedemann, Auss. Zw. Ins., II, 193, 61.

Milesia ania Walker, List, etc., III, 564.

Common, Port Antonio.

Ceria Daphnæus Walker, List, etc., III, 537.

Three specimens, Kingston; Port Antonio.

CESTRIDÆ.

***Gastrophilus pecorum** Fabricius.

“Europe, and according to Walker, Jamaica” (Osten-Sacken).

PHASIDÆ.

***Trichopoda pennipes** Fabricius. Townsend, Entom. News, IV, 70.

Musca pennipes Fabr., Ent. Syst., IV, 348, 149.

Dictya pennipes Wied., Auss. Zw., II, 274, 9.

OCYPTERIDÆ.

Ocyptera Dotadas Walker, List, etc., IV, 694.

Two specimens, Port Antonio.

TACHINIDÆ.

Pseudohystricia exilis Townsend, Entom. News, III, 146.

Cinchona (Cockerell), Bath (Mrs. Swainson).

Jurinia amethystina Macquart, Dipt. Exot., II, 3, 42, 9; Tab. III, f. 7.

Common, Port Antonio.

***Jurinia basilis** Walker, List, etc., IV, 713.

***Jurinia epileuca** Walker, List, etc., IV, 716.

Blepharipeza nigrisquamis Townsend, Entom. News, III, 80.

Three specimens, Port Antonio (Portland). Bath. (Mrs. Swainson.)

- ***Blepharipeza breviventris** Wiedemann.
Tachina breviventris Wied., Auss. Zw., II, 297; Walker, List, etc., IV, 712.
- ***Blepharipeza** sp. Townsend, Journ. Inst. Jamaica, I, 314.
- ***Belvosia bicincta** Rob. Desv., Myod., 103.
Senometopia bicincta Macquart, Hist. Nat. Dipt., II, 112.
Belvosia bifasciata Fabr., Osten-Sacken, Catl., 153.
Willistonina bicincta Brauer and Bergenstamm, Musc. Schiz., II, 99.
Kingston (T. D. A. Cockerell).
- ***Echinomyia basifulva** Walker, List, etc., IV, 725.
- Elachipalpus macrocera** Wiedemann.
Tachina macrocera Wied., Auss. Zw., II, 290.
Cuphocera macrocera Schiner, Novara, 330.
Port Antonio (Portland).
- Gonia pallens** Wiedemann, Auss. Zw., II, 346.
Gonia angusta Macq., Dipt. Exot., II, 3, 56, pl. 5, f. 5.
Gonia lineata Macq., Dipt. Exot., Suppl., IV, 178.
Gonia chilensis Macq., (variety), Dipt. Exot., II, 3, 50, pl. 5, f. 4.
Common, Port Antonio.
- ***Tachina hirta** Drury.
Musca hirta Drury, Ins., 109, Tab. XLV, f. 4.
- ***Exorista lagoæ** Townsend, Ent. News, II, 159; Journ. Inst. Jamaica, I, 314.
"Mandeville. Bred from a red *Halesidota*" (E. S. Panton).
- ***Exorista (Masicera?) sp.?** Townsend, Journ. Inst. Jamaica, I, 315.
- ***Nutopia Xychus** Walker.
Ophilia Xychus Walker, List, etc., IV, 770.
- Anisia Vanderwulpi** Townsend, Entom. News, III, 81.
One specimen, Port Antonio (Portland), April.
- ***Masicera protopareis** Townsend, Journ. Inst. Jamaica, I, 70.
Bred from larva of *Protoparce jamaicensis*. Kingston (Cockerell).
- ***Masicera sp.?** Townsend, Journ. Inst. Jamaica, I, 315.
Kingston, July 19.

DEXIDÆ.

- ***Dexia Thomæ** Wiedemann, Auss. Zw., II, 379; Jamaica (Walker, List, IV, 840).
- ***Sarcodexia sternodontis** Townsend.
Journ. Inst. Jamaica, I, 105. Bred from a longicorn beetle.
Journ. Inst. Jamaica, I, 221. Bred from a scorpion (Cockerell).

SARCOPHAGIDÆ.

- Sarcophaga incerta** Walker, Dipt. Saund., 324.
Common, Port Antonio.
- Sarcophaga plinthopyga** Wiedemann, Auss. Zw., II, 366.
Common, Port Antonio.

Sarcophaga sp., Townsend, Journ. Inst. Jamaica, I, 315.

Kingston.

Sarcophagula sp., Townsend, Journ. Inst. Jamaica, I, 316.

Kingston, July 10.

Sarcophilodes sp., Townsend, Journ. Inst. Jamaica, I, 316; Moneague.

Phrissopoda sp., Townsend, Journ. Inst. Jamaica, I, 315; Bath.

Bath; bred from a snail.

MUSCIDÆ.

Musca basilaris Macquart, Dipt. Exot., II, 3, 153, 8; Walker, List, etc., IV, 901.

Common, Kingston.

Lucilia sp.

Common, Port Antonio.

Comptosyia macellaria Fabricius.

Musca macellaria Fabr., Syst. Ent., 776; Ent. Syst., IV, 319.

Lucilia macellaria Macquart, Dipt. Exot., II, 3, 147, pl. 17, f. 9.

Lucilia hominivora Coquerel, Ann. Soc. Ent., 1858, 173, Tab. IV, f. 2.

For synonymy see Williston, Albatross Explor., Proc. U. S. Nat. Mus., XII, 203.

Common, Kingston. According to Lynch-Arribalzaga and Dr. Williston, twenty-seven specific names have been applied to this species.

***Ormia punctata** R. Desv., Myod., 428.

Ochromyia punctata Macq., Hist. Nat. Dipt., II, 250, 3.

SCIOMYZIDÆ.

Tetanocera spinicornis Loew, Centur., VI, 86.

Three specimens, Port Antonio.

***Sepedon macropus** Walker, List, etc., IV, 1078; Lw, Monogr. I, 125.

MICROPEZIDÆ.

Calobata lasciva Fabricius.

Musca lasciva Fabr., Ent. Syst., Suppl., 574, 111.

Calobata albimana Macquart, Dipt. Exot., II, 3, 245; Fab., 33, f. 3.

Calobata valida Walker, Dipt. Saund., 390.

Calobata ruficeps Guérin, Iconogr., etc., 111, 553, Tab. 103, fig. 7.

Tænioptera Irivittata Macq., Hist. Nat. Dipt., II, 491, Tab. XX, f. 9.

♂ *Calobata aloa* Walker, List, etc., IV, 1053.

Six specimens, Port Antonio.

Calobata fasciata Fabricius.

Musca fasciata Fabr., System. Ent., 781, 43.

Three specimens, Port Antonio; Kingston.

Calobata pleuritica n. sp.

Length, 7 mm., ♂ ♀. Face, front, vertex, and occiput red;

about seven prominent setæ along the vertical angle; antennæ yellow, aristæ black; ocelli and tip of the proboscis black. Thorax and scutellum shining blue-black; pleuræ and a dorsal line, or spot on the front of the thorax, red; scutellum bearing two prominent setæ. Abdomen black; terminal segment and ovipositor shining blue-black. Venter yellow. Legs yellow, with minute black hairs; outer third of the femora, and the entire tibiæ of the front legs, black; front tarsi white, terminal joints brown. Wings with a uniform brownish tinge.

Upwards of thirty specimens, Port Antonio, April. Many of the specimens collected are immature.

Micropeza producta Walker? List, etc., IV, 1056.

One specimen, Port Antonio. Agrees fairly well with Walker's description, but the specimen is immature.

ORTALIDÆ.

Euxesta annonæ Fabricius.

Musca annonæ Fabr., Ent. System., IV, 358, 189.

Tephritis annonæ Fabr., System. Antl., 320, 19.

Ortalis annonæ Wied., Auss. Zw., II, 463.

Amethysa annonæ Schiner, Novara, 283.

Crophora quadricittata Macq., Hist. Nat. Dipt., II, 456 [Lw.].

Common, Port Antonio. This and the two following species were usually found in the crooked corolla of a large *Aristolochia* (?).

Euxesta costalis Fabricius.

Musca costalis Fabr., Ent. System., IV, 360, 196.

Dacus costalis Fabr., Syst. Antl., 278.

Ortalis costalis Wied., Auss. Zw., II, 464.

Dacus aculeatus Fabr., Syst. Antl., 275 [Loew].

One specimen, Port Antonio.

Euxesta sp.

Port Antonio.

TRYPETIDÆ.

Trypeta (Aciura) insecta Loew, Monogr., I, 72, Tab. ii, f. 8.

Common, Port Antonio.

Trypeta (Eusina) humilis Loew, Monogr., I, 81, Tab. ii, f. 17.

Acinia picciola Bigot, R. de la Sagr., etc., 824, Tab. xx, f. 10 [Loew].

Common, Port Antonio.

Trypeta (Tephritis) fucata Fabricius.

Musca fucata Fabr., Ent. System., IV, 359, 194.

Tephritis fucata Wied., Auss. Zw., II, 505.

Common, Kingston.

**Trypeta* (*Urophora*) *avala* Walker, List, etc., IV, 1020.

[Doubtful whether it belongs to Trypetidae or Ortalidae, Loew.]

“It is a small Ortalid.”—Osten-Sacken.

**Trypeta* *Dinia* Walker, List, etc., IV, 1040.

[Perhaps allied to *Trypeta* (*Hexacheta*) *eximia* Wied., or, perhaps, a bad description of a variety of this species, Loew].

**Trypeta* *Ocresia* Walker, List, etc., IV, 1016.

[*Acrotova* — Loew].—Osten-Sacken.

SAPROMYZIDÆ.

Lauxania *albovittata* Loew, Centur., II, 79.

Three specimens, Port Antonio.

Physegenna *variegata* Loew.

Lauxania *variegata* Loew, Centur., I, 83.

Common, Port Antonio.

EPHYDRIDÆ.

Oohthera *exculpta* Loew, Monogr., I, 160.

Four specimens, Kingston; Port Antonio.

HIPPOBOSCIDÆ.

**Olfersia* *propinqua* Walker, List, etc., IV, 1141.

**Ornithomyia* *erythrocephala* Leach, Eprob. Ins., 13, 3, Tab. xxvii, f. 4-6.
Walker, List, etc., IV, 1143.

**Ornithomyia* *fulvifrons* Walker, List, etc., IV, 1145.

**Ornithomyia* *unicolor* Walker, l. c., 1144.

**Ornithomyia* *vicina* Walker, l. c., 1144.

NYCTERIBIDÆ.

**Strebla* *vespertilionis* Fabricius. Walker, List, IV, 1146.

Hippobosca *vespertilionis* Fabr., Syst. Antl., 339, 6.

Strebla *axium* Macq., Dipt. Exot., 5c. Suppl., 127, 2 (on pigeons and parrots).

Strebla *Wiedemanni* Kolenati, Horae Soc. Ent. Ross. II, 96, Tab. xv, f. 36.

DESCRIPTIONS OF A NEW SUBGENUS AND NEW SPECIES OF ARVICOLINE RODENTS FROM BRITISH COLUMBIA AND WASHINGTON.

BY SAMUEL N. RHOADS.

*Tetramerodon*¹ subgen. nov.

Type *Arvicola* (*Tetramerodon*) *tetramerus* Rhoads, sp. nov., Victoria, B. C.

Subgeneric characters.—Dentition as in the subgenus *Mynomes* Rafinesque² as restricted by Dr. Coues (Mon. N. Amer. Rodentia, 1877, p. 153), but differing therefrom in the middle upper molar lacking a postero-internal triangular loop. This tooth is composed of an anterior loop, a closed antero-exterior triangle, a closed median inner triangle, and a postero-exterior triangle. Other characters as in *Mynomes*. See, below, dentition of *A. borealis*, Fig. 1.

This section of the genus *Arvicola* includes a larger number of species than any other, whereas typical *Mynomes* is restricted to very few. Among those which class under *Tetramerodon* may be mentioned *A. xanthognathus*, *chrotorrhinus*, *borealis*, *longicaudus*, *alticola*, *mogollonensis*, *mordax*, *nanus*, *macropus*, *pauperrimus*, *townsendi*, *tetramerus* (l. c.), *edax*, *pharus*, and *operarius*.

Of *Mynomes* we have *A. pennsylvanicus*, *terrænovæ*, *aztecus*, and *drummondii*?

Prof. Baird characterized the subgenus *Hemiotomys* (= *Mynomes* of Coues) as having the middle "upper molar with five closed triangles, the last two sometimes subconfluent," taking no notice of the species then known, as *edax*, *townsendi*, *xanthognathus*, and *borealis*, in which, to a greater or less degree, the posterior triangle shows no indication of the subdivision seen in *A. pennsylvanicus*. The four-triangled species greatly outnumber those which possess five, and it is fully in accord with the system that they should be either separated subgenerically from *Mynomes* or that this subgenus be re-characterized.

¹ From *Tetrameres*—four-parted, and *Odous*—tooth.

² Dr. Coues' reasons for changing Rafinesque's original spelling to *Myonomes* are insufficient. If retained at all, it must remain *Mynomes*.

If the latter course be adopted, we still have an inexact diagnosis to accommodate the three or four exceptional species which develop the fifth triangle, and the name *Mynomes*, based by Rafinesque on a five-triangled species, becomes inapplicable. On this account, it seems to me quite consistent with the exact subdivision of the other members of the genus *Arvicola*, as well as necessary, that the subgenus *Tetramerodon* be adopted.

Arvicola (Tetramerodon) tetramerus sp. nov. Type No. 327, ad., ♂, Coll. of S. N. Rhoads, Beacon Hill Park, Victoria, British Columbia, May 19, 1892. Coll. by S. N. R.

Description.—Size medium, about the same as *A. pennsylvanicus*. Tail rather long. Color above, grizzled blackish-brown, beneath clear ash. Feet grayish-brown. Tail bicolor, matching corresponding surfaces of body, well-haired and penicillate.

Dentition as in *Mynomes*, but lacking the posterior fifth section of middle upper molar, typical of that subgenus.

Measurements (of type).—Total length, 170 mm; tail vertebrae, 50; hind foot, 23. Average of five adults—Total, 175; tail, 48; foot, 22. Skull—Total length, 26.5; basilar length, 24; zygomatic breadth, 15; length of nasals, 7.5; incisors to post-palatal notch, 14.2; interorbital constriction, 3.4; length of mandible, 16; width of mandible, 8.5.

Ten specimens of this species were taken in the suburbs of Victoria, in the dry, grassy woods of Beacon Hill Park, overlooking the Strait of Fuca.

They most nearly resemble *townsendi* from Puget Sound in essential characters. Compared with *townsendi* the Victoria voles may be readily distinguished by their much smaller size, blacker coloration above, the greater relative width of the interorbital region, the supraorbital ridges never meeting medially as in old *townsendi*, and the posterior margins of the frontals being rounded and but slightly encroaching upon the parietals. This species differs essentially from *A. occidentalis* and *A. californicus* as defined by Baird in its lack of red or yellow tints. From *A. montanus* Peale (vide Baird) *tetramerus* differs in the greater relative length between the upper molars and incisors, also in the posterior upper molar having four outer, salient angles instead of three. Prof. Baird states there is a great similarity between the colors of *montanus* and *clax* and that the former is grayer than *townsendi*. In *tetramerus* the colors are much darker.

Evotomys pygmæus sp. nov. Type No. 247, ad. ♀. Coll. of S. N. Rhoads, mouth of Nisqually River, Pierce Co., Washington. Col. by S. N. R.

Description.—Size smallest of any described species of the genus. Color above a rusty gray, lighter than *gapperi*, darkest along the top of head and back; sides and belly muddy ash-gray. Margins of ears and upper third of tail sooty. Feet light gray. Skull short and wide, with relatively wide and flaring zygoma and brain case and broad interorbital region. The auditory bullæ are very much inflated, spheroidal, separated medially by less than 1 mm., their greatest transverse diameter being only 1 mm. less than the longitudinal. The dentition is intermediate between that of *E. occidentalis* and *E. californicus*, with the anterior lower molar of *californicus* and the posterior upper molar of *occidentalis*. In the latter case, however, the two anterior lateral triangles are completely closed in *pygmæus*, the second not connecting with the third as figured by Dr. Merriam³ for *occidentalis*. The nasals do not reach the posterior points of the premaxillaries by $1\frac{1}{2}$ mm.

Measurements.—Total length, 120 mm; tail vertebræ, 34; hind foot, 16. Skull—Total length, 21; basilar length, 18.4; zygomatic width, 12; length of nasals, 6; incisors to post-palatal notch, 9; interorbital constriction, 4.1; length of mandible, 12.

The single specimen on which I have based the above diagnosis is the only one of the genus secured by me in the Pacific coast district of the northwest. It was captured under a log in the dense spruce forest which covers the bluff overlooking Puget Sound, at the mouth of the Nisqually River. It is fully adult, with well-worn teeth. This species may be known externally from its nearest geographic congeners by its small size. In color it is much lighter than *occidentalis*, and (from the description) even paler than *californicus*.

Evotomys gapperi saturatus subsp. nov. Type No. 483, ad. ♀, Coll. of S. N. Rhoads, Nelson, British Columbia, Aug. 17, 1892. Col. by S. N. R.

Description.—Size and proportions of *E. gapperi*, but much darker, the "red" of back being dark chestnut, the sides and belly dark grayish-plumbeous without ochraceous tints of *gapperi*. The upper half of tail sooty black, strongly defined against gray of lower half. Compared with that of *gapperi*, the skull is relatively narrower, the nasals longer, the nasal premaxillary processes reach-

³ N. Amer. Fau., No. 4, Plate II, Figs. 1 and 2.

ing considerably behind base of nasals; the audital bullæ are also narrower, elongate, and depressed.

The dentition does not differ from that of *gapperi*, but the other characters of the skull of type, as above defined, show such considerable differences from *gapperi* of eastern Canada that the question of its specific value is yet an open one.

Measurements.—Total length, 141 mm; tail vertebrae, 41; hind foot, 19. Skull—Total length, 23.3; zygomatic width, 12.1; length of nasals, 6.5; incisors to post-palatal notch, 10; interorbital constriction, 4.2; length of mandible, 13.2; width of mandible, 6.2.

One female (the type) was trapped on the banks of a small stream flowing into Kootenai Lake, in the town limits of Nelson, in the Selkirk Mountains. Two others were taken in the Rocky Mountains, at Field, on the banks of the Kicking Horse River.

Ecotomys [gapperi] dawsoni Merriam, the west Arctic representative, differs from *saturatus* in the opposite light phase of coloration, a parallel case to that exhibited by the Hudsonian Chickadees, *Parus hudsonicus*, *P. h. stoneyi*, and *P. h. columbianus*.

NOTES ON BOREAL ARVICOLAS OF UNCERTAIN STATUS.

Arvicola borealis Richardson. Rich., Zool. Jour., No. 12, 1828, 517; Faun. Bor. Amer., I, 1829, 127. Aud. and Bach., Quad. N. Amer., 1851, 134.

Since the publication of the Monograph of North American Rodentia, this species has been classed, on the authority of Dr. Coues, as a subspecies of *Arvicola pennsylvanicus*. Several specimens from the material examined by Dr. Coues in the preparation of his monograph of the Arvicolinae were subsequently presented to the Academy of Natural Sciences. Among them I find two skins with skulls and one specimen in alcohol enumerated in Dr. Coues' tabulated lists of Arctic Arvicolas, which, after a careful study of Richardson's two descriptions of *A. borealis*, I am convinced should be referred to that species. The characters exhibited by these specimens are those of an animal quite distinct from *pennsylvanicus* and justify restoring *borealis* to the full specific rank originally given it.

Audubon and Bachman (sup. cit.) have clearly restated the external characters of this vole from a personal examination of Richardson's types.

Its cranial characters remain undefined, and may be described as follow:—

Arvicola borealis. Topotype, No. 1,908, ad. ♀, Coll. of Acad. Nat. Sci., Phila. (No. 8,403, Sm. Inst.: vid. Coues, N. A. Rod., p. 206, t. li). Fort Anderson, North of Great Bear Lake (no date), R. McFarlane, Collector.

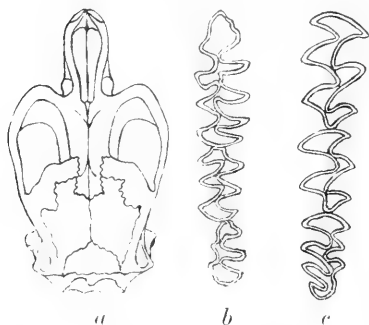

Fig. 1. Skull and molar teeth of *Arvicola borealis* Rich.

a. Upper profile of cranium.¹ b. Left mandibular series. c. Left maxillary series.

Skull.—Remarkably angular, shallow and flattened, its anterior jugal breadth exceeding the squamosal, much as in *Synaptomys*. Posterior ends of frontals produced in a long, slender, strap-shaped process, beginning just behind the interorbital constriction, between the projecting anterior corners of the squamosal bones and terminating in a dove-tailed process between the acutely pointed and extended anterior corners of the parietals. Interorbital constriction narrow, acutely compressed, its single median ridge depressed below the frontal plane. Audital bulke subtriangular, depressed, long and narrow. Dentition as given (l. c.) for the subgenus *Tetramerodon*, of which, with *A. xanthognathus* and *A. chrotorrhinus*, it forms a typical representative in the lack of any attempt at a posterior inner fold, or angle, in the middle upper molar. The anterior trefoil of the first lower molar is less deeply indented than in any *Arvicola* I have examined. The mandibles present no peculiar characters. An incipient groove can be detected, almost evenly dividing the face of each upper incisor.

Arvicola drummondi Aud. and Bach.

Five specimens of meadow mice, three taken on the shores of Lac La Hache, B. C., and two from the valley of the Kicking Horse River, at Field, B. C., I had previously described in manuscript as new, under the name *Arvicola (Mynomes) microcephalus*.

The description of *A. drummondi* (Aud. and Bach., Quad. N. Amer., 1854, 166) I have since found to correspond so closely in every particular with the characters of these specimens, it seems far preferable to make them the basis of a full restoration of *drum-*

¹ About one and one-half times natural size.

mondi to a place in nomenclature. It may be stated that Richardson's *A. noveboracensis* (Raf.), the name under which that author described the type of *drummondi* was said by him to have come from the dry uplands of the Rocky Mountains inhabited by *A. canthognathus*. This would indicate a locality far north of that from which my specimens came, also a less aquatic environment, and a somewhat different faunal region. Audubon and Bachman give, "Valleys of the Rocky Mountains," as the habitat of *drummondi*. More complete collections from the whole length of the intermediate country may show that the Lac La Hache animal is separable from the northern one; in such an event the name *microcephalus* may still be applicable to it.

Arvicola (Mynomes) drummondi. Topotype No. 418, ad. ♂, Coll. of S. N. Rhoads; Lac La Hache, B. Columbia, June 30th, 1892. Col. by S. N. R.

Description.—Size considerably less than that of *A. pennsylvanicus*; ears moderate; tail short and scantily haired; skull small, highly arched, compressed and elongate, the orbits much narrowed by the compression of the zygoma; eyes very small, as in *Pitymys*; feet as originally described by Richardson. Teeth of typical *Mynomes*, the postero-internal section of middle upper molars as large as its opposing outer triangle. Color above grizzled black-brown, beneath a clear hoary plumbeous, lacking the muddy wash mentioned by Aud. and Bach. Tail sooty above, grayer beneath.

Measurements.—Total length, 155 mm; tail vertebrae, 40; hind foot, 20 (average of four adults—Total, 153; tail, 39; foot, 19). Skull—Total length, 24.2; basilar length, 22; zygomatic width, 13.5; length of nasals, 6.6; incisor to post-palatal notch, 12.2; inter-orbital constriction, 4; length of mandible, 14.8; width of mandible, 8.2.

This species resembles *A. nanus*,³ but its possession of a five triangled middle upper molar distinguishes it from that species, which, as Dr. Merriam expressly states, has but four triangles. The two specimens from Field show no differences from the one above described.

Incidental to this rather cursory study of the principal group of North American *Arvicolina* it is worthy of mention that the large vole captured by Mr. Drummond "at the foot of the Rocky Moun-

³ Merriam, N. Amer. Fau., No. 5, 1891, 63.

tains," and described minutely by Richardson (Fau. Bor. Amer., 1829, 120), under caption of "*Arvicola riparius* (Ord?)," is almost certainly a member of the genus *Aulacomys*.⁶ A comparison of the description of this animal given by Richardson and that given by Audubon and Bachman,⁷ when they renamed it *A. richardsoni*, with my type of *Aulacomys arvicoloides*, leaves very little room for doubt that the two are generically the same. Their specific differences consist in the much longer tail of *arvicoloides*, its tail also being black above and nearly unicolor, its feet black, and the mouth and chops grayish-brown, like the surrounding parts.

An examination of Richardson's introductory notice of Mr. Drummond's travels, coupled with the statement that the specimen was taken in summer, fix the type locality of *A. richardsoni* within, say, fifty miles of Athabasca Pass in the Rocky Mountains, among the foothills traversed by the Columbia Portage trail connecting the head waters of the Athabasca, Saskatchewan, and Columbia Rivers, in latitude 53°. *A. arvicoloides* was taken somewhat east of the dividing ridge of the Cascade Mountains in latitude 47°. Should the correctness of this interpretation be proved, Drummond's specimen should stand as *Aulacomys richardsoni* (Dekay).⁸

⁶ Rhoads, Amer. Nat., Feb. 1894, 182.

⁷ Quad. N. Amer., III, 1853, 163.

⁸ N. Y. Zool., I, 1842, 91.

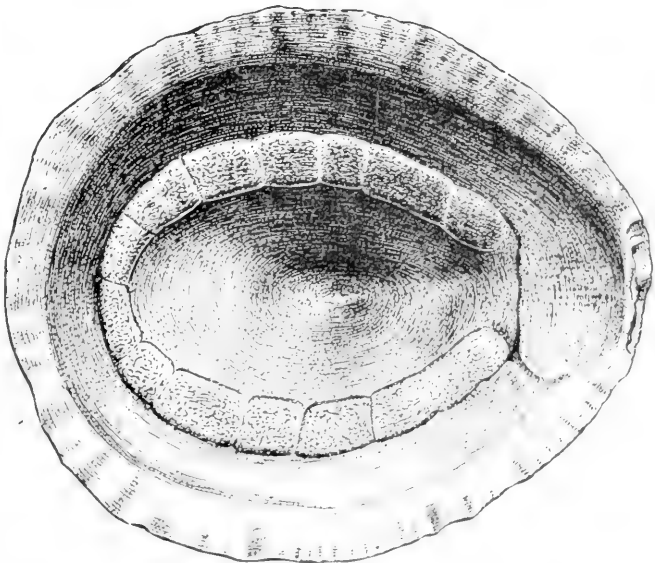
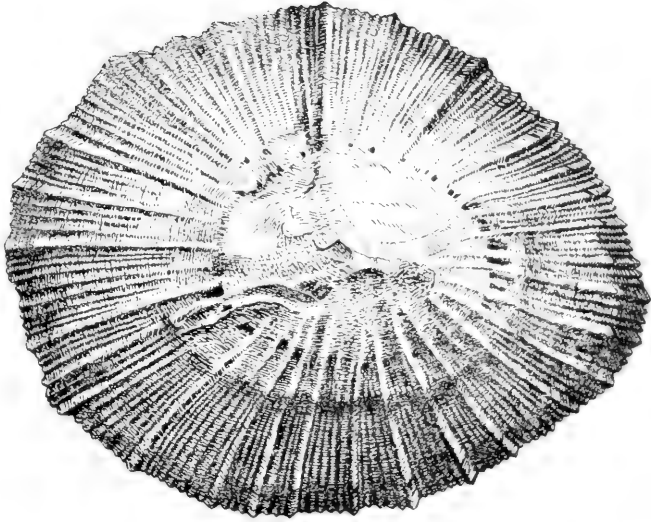

LEVYTYPE CO., ENGRAVERS

PILSBRY, *PATELLA KERMADECENSIS*.



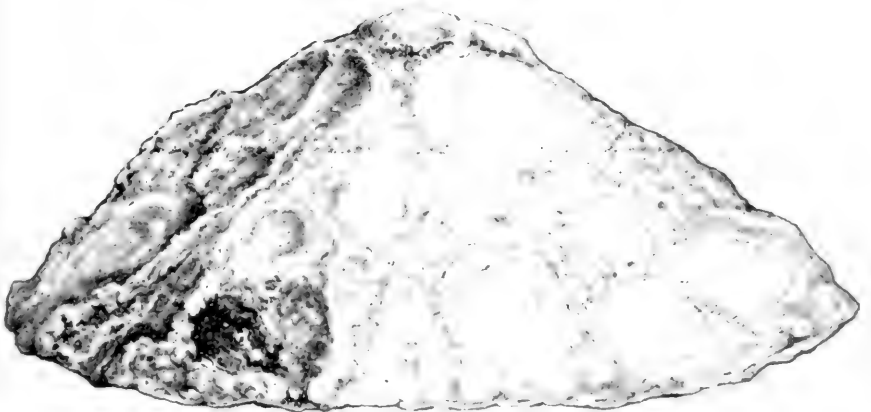

J. Bridgham, Del.

PILSBRY, PATELLA KERMADECENSIS.



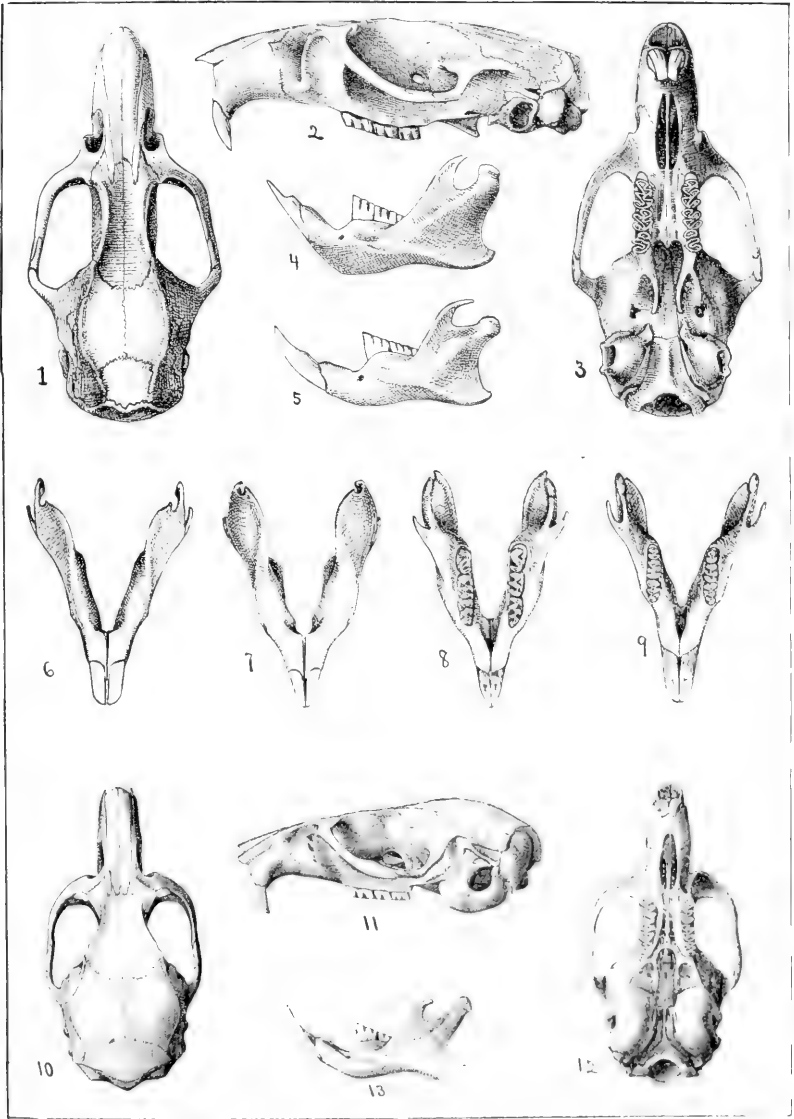

MERRIAM, THE NEOTOMINÆ.



OCTOBER 2.

MR. CHARLES MORRIS in the Chair.

Fifty-four persons present.

A paper entitled "A proposed Classification of the Fossorial Hymenoptera of North America," by William J. Fox, was presented for publication.

OCTOBER 9.

MR. USELMA C. SMITH in the Chair.

Thirty-two persons present.

The deaths of Joseph Hyrtl and Oliver Wendell Holmes, M.D., correspondents, were announced.

A paper entitled "A Study of the Systematic and Geographical Distribution of the Decapod Family Atyidae Kingsley," by Dr. A. Ortmann, was presented for publication.

OCTOBER 16.

MR. CHARLES P. PEROT in the Chair.

Sixty-six persons present.

A paper entitled "New Species of Fungi from various Localities," by J. B. Ellis and B. M. Everhart, was presented for publication.

Diachæa Thomasii REX.—DR. GEO. A. REX presented specimens of *Diachæa Thomasii*, a species of Myxomycetes recently described by him, and commented upon the variations of the species and its relations to the adjoining genera.

The specimens differed in some respects from the original specimens from which the diagnostic description had been drawn, making it advisable to supplement that description.

The new specimens were a part of some recent gatherings made by Mr. Lancaster Thomas at the original locality for the species at Cranberry, N. C., in July and August of this year.

The sporangia of the type specimens were frequently grouped in clusters, but with rare exceptions they grew upon separate stipes.

In the recent gatherings, however, the sporangia show a remarkable tendency to aggregation into clumps of from twelve to twenty, the stipes growing together to form a thick compound stipe surmounted by the densely clustered sporangia. In some cases these are distorted by crowding, having their adjoining walls grown together, constituting stipitate æthalia.

The clustered sporangia have usually a purplish metallic lustre rather than the silver or bronze lustre of the single forms.

The capillitium differs from the type only in the presence of an extraordinary number of small dark-violet colored bulbous thickenings occurring upon the threads in their course, similar to those found in the capillitium of certain species of *Didymium* and *Chondrioderma*. These thickenings are ellipsoidal, turbinate or conical in shape and occur more frequently near the ends of the threads.

The speaker thought that these peculiar thickenings were of special interest on account of their bearing upon the relative position of the genus *Diachea* in the systematic classification of the Myxomycetes. As they are almost exclusively found in certain species of the Didymiaceæ and the single species of the genus *Spumaria*, this species at least, of the genus *Diachea* would seem to be connected with the Calcareæ by good structural characters other than the mere existence of granules of lime in the stipes and columellas of the sporangia.

The bulbous thickenings were also found in the capillitium of the type specimens but not conspicuously, or to a greater extent than they are sometimes found in the other species of *Diachea*.

The speaker concluded that the genus *Diachea* was properly associated with the Order Didymiaceæ (including the genus *Spumaria*) notwithstanding its points of resemblance to the genus *Lamproderma* suggesting its possibly closer relationship to the Order Stemonitaceæ.

The differences between the present gatherings and the former ones were probably due to climatic causes, the excessive rainfall and great atmospheric humidity prevailing in the North Carolina mountains during July and the early part of August of the present year, causing an exuberant development of plasmodium which resulted in a growth of unusually aggregated and æthalioid forms

OCTOBER 23.

DR. C. N. PEIRCE in the Chair.

Twenty-five persons present.

A paper entitled "Notes on the Mammals of Monroe and Pike Counties, Pennsylvania," by Samuel N. Rhoads, was presented for publication.

The death of F. Oden Horstmann, a member, was announced.

OCTOBER 30.

MR. CHARLES P. PEROT in the Chair.

Thirty-three persons present.

The death of William R. Lejee, a member, was announced.

A paper entitled "On a Collection of Batrachia and Reptilia from the Island of Hawaii," by Edw. D. Cope, was presented for publication.

Mr. Horace Binder was elected a member.

The following were ordered to be printed:—

A PROPOSED CLASSIFICATION OF THE FOSSORIAL HYMENOPTERA OF
NORTH AMERICA.

BY WILLIAM J. FOX.

The arrangement of our Fossores contained in the following pages, I trust will be of some service to students of these insects. It has been evident for some time that the existing arrangement, that contained in Cresson's Synopsis,¹ is of little value, as it is too superficial. Entirely too many families, without characters to substantiate them, were recognized: the Sphegidae, for instance, which were divided into no less than nine families. Accepting these nine families would, it seems to me, necessitate the erection of families for such genera as *Neolarra*, *Bothynostethus*, *Trypoxylon* and others, which stand more or less isolated and yet possess characters which connect them in one way or another with the formerly existing families and would form more distinct families, were they so recognized, than, say, the Melilindidae, Ampulicidae, Nyssonidae or Bembicidae. How these nine supposed families have been disposed of, the following pages will show.

Saussure's recent classification² is not satisfactory, inasmuch as it is incomplete, and, moreover, his conclusions, particularly regarding the Pompilidae, are not well founded. He makes two tribes of this family, the Pompiliens and Pepsiens, separating them on a very trivial character—the position of insertion of the first recurrent nervure in the second submarginal cell, a character which, in my experience, has always proved variable. Under the first mentioned tribe he includes *Ceropales*, which he seems to consider as not worthy of more than generic rank, while he forms a tribe for the reception of *Pepsis*, which should be placed with the Pompiliens, if anywhere. The Mutillidae and Sapygidae are considered as subfamilies of the Scoliidæ; these are ranked as families in this paper. The old families Pemphredonidae and Crabronidae and *Oxybelus*, he considers as tribes of equal value to the Nyssonidae, Bembicidae and Larridae,

¹ Mr. Cresson states that this was simply compiled from the works of other authors.

² Grandidier's Hist. Madagascar, XX.

all of which are ranked as tribes of the Sphegidae. The two families mentioned and *Oxybelus* are treated as subfamilies in this paper as they are more distinct than are the numerous tribes of the Bembicinae and Spheginae.

It is hoped that the paper may at least call forth improvements on the classification suggested.

MUTILLIDÆ.

I regard this as a well-defined family, disagreeing with some authors who place it as a subfamily of the Scoliidæ. The wingless females are, in my opinion, sufficient to separate these insects from the Scoliidæ. In the latter family the intermediate coxæ are widely separated, while in the Mutillidæ they are not separated by a distance equalling their width. In the generic table below, *Photopsis* Blake is considered as synonymous with *Sphaerophthalma* Blake, as a comparison of the two genera fails to show any differential characters. The family can be separated into two tribes as follows:—

- Females (as far as known) without ocelli; marginal cell of (♂) wings more or less short, not reaching by any means the apex of wing; some of the nervures generally obsolete, particularly those forming the third discoidal cell. MUTILLINI.
- Females with ocelli; marginal cell of (♂) wings long and pointed, reaching almost the apex of wings; all the nervures distinct, never obsolete. MYRMOSINI.

Tribe I.—MUTILLINI.

Contains the genera *Psammotherma*,³ *Matilla*, *Sphaerophthalma* (= *Photopsis* in pt.), *Brachycistis* and *Chyphotes*, and is defined as above. The genera may be tabulated as follows:—

- 1—Antennæ simple in both sexes 2
 - Antennæ of male flabellate. PSAMMOTHERMA Latr.
- 2—Eyes ovate, emarginate within the ♂, entire in ♀; thorax of ♀ generally oblong in shape, truncate behind. MUTILLA Linné.
 - Eyes round, entire; thorax generally ovate, rounded posteriorly 3
- 3—Intermediate tibiæ with two apical spurs. 4
 - Intermediate tibiæ with but one apical spur; wing stigma very large; body smooth, glabrous; marginal cell usually shorter than stigma; antennæ longer than head and thorax BRACHYCISTIS Fox.

³ Probably does not occur in America, the species described being very likely erroneously reported from Florida.

- 4—Abdomen at most subpetiolate; thorax of ♀ divided into more than two parts (body, at least the thorax, coarsely sculptured).
 2 SPHEROPHTHALMA⁴ Bl.
 Abdomen connected by a long, slender petiole; thorax (♀) divided into two distinct parts only; ♂ unknown.
 4. CHYPHOTES Bl.

Tribe II.—MYRMOSINI.

Proposed for the genera *Myrmosa* and *Methoca*, and is characterized chiefly by the females possessing distinct ocelli. But few species have been described from America.

- Apex of abdomen (♂), unarmed; wings with three submarginal cells;⁵ cubital nervure of hind wings received by the submedian cell at apex; thorax (♀) composed apparently of two parts; body rugose (♀). MYRMOSA Latr.
 Apex of abdomen (♂) armed with a curved spine; two submarginal cells; cubital nervure of hind wings received considerably before the apex of submedian cell; thorax (♀) divided into three parts; body smooth, shining and very ant-like.
 METHOCA Latr.

If the genus *Thymus* occurs in America as reported by Patton (Ent. News, III, 104) another tribe will have to be added to this family. I doubt, however, the existence of American representatives.

SCOLIIDÆ.

This family is sufficiently characterized by both sexes being winged to separate it from the Mutillidæ. The North American representatives comprise three tribes,⁶ as follows:—

- Eyes emarginate; spur of fore tibiæ large, strongly curved, dilated, and truncate at end; intermediate tibiæ with one spur; abdomen of ♂ armed with three spines at apex SCOLIINI.
 Eyes entire; spur of fore tarsi not much curved or dilated, either pointed or bifurcate at end; intermediate tibiæ with one or two spurs; abdomen of ♂ with but one spine at apex.
 Sexes similar in form; marginal cell broadened toward the base (in our genera, the ♀'s have the marginal cell open at apex); antennæ short in both sexes TYPHIINI.

⁴ This may ultimately prove but a division or subgenus of *Mutilla*.

⁵ There are really four submarginals, as the cubital nervure extends out to the apex of wing.

⁶ After Saussure.

Sexes dissimilar in form; ♀ robust, ♂ long and slender; marginal cell (♀) narrowed toward base (in our genera the marginal cell is always closed); antennæ in ♀ short, in ♂ long and slender, as long or longer than head and thorax MYZININI (*Plesiites* Sauss.)

Tribe I.—SCOLIINI.

Two genera occur in our fauna, as follows:—

Anterior wings with only one recurrent nervure SCOLIA Fabr.
Anterior wings with two recurrent nervures ELIS Fabr.

Each of these genera may be divided into subgenera by the number of submarginal cells. In the subgenus *Triscolia* there are three cells, while in *Discolia* there are two. In *Trielis* three, in *Dielis* two.

Tribe II.—TIPHINI.

The first and second submarginal cells merged into one through the disappearance of the first transverso-cubital nervure; base of first abdominal segment produced angularly or dentate on each side; intermediate tibiæ with one spur TIPHIA Fabr.
Three submarginal cells, the first transverso-cubital nervure present, but abbreviated, not reaching the cubital nervure; base of first abdominal segment not produced or dentate at base; intermediate tibiæ with two spurs EPOMIDIOPTERON Sichel (= *Paratiphia*).

Tribe III.—MYZININI.

This tribe is identical with Saussure's "Section des Plesiites." *Plesia* seems to be synonymous with *Myzine* Latr. The latter has priority, being described two years in advance of *Plesia*. But one genus, *Myzine*, is found in America, which may be distinguished by the tribal characters given above.

SAPYGIDÆ.

Intermediate coxæ contiguous; legs, except tibial spurs, unarmed; no pygidial area; apex of (♂) abdomen without spines. These characters seem sufficient to keep these insects distinct from the preceding family, to which they have been assigned by some authors, and, moreover, the first and second ventral segments are contiguous, while in the Scoliidae they are widely separated. *Sapyga*, our only genus, has the eyes emarginate within, the intermediate tibiæ with two spurs. For several species having the vertex tuberculate, the

name *Eusapyga* has been proposed by Cresson, but these form only a subgenus at the most.

POMPILIDÆ.

This is a distinct family characterized by the very long posterior legs, long antennæ, and by the first and second ventral segments being not widely separated. The species possess no pygidium. I would separate the family into three tribes, placing the Ceropalini first, as I consider the genus *Ceropales* as being closest to the Sapygidæ.

Sting sheath of ♀ projecting, prominent; eyes slightly emarginate within, near the top; labrum large, projecting; antennæ never curled after death, situated well above the clypeus

CEROPALINI.

Sting sheath of ♀ not projecting; eyes entire.

First discoidal cell not longer than first submarginal; submedian cell of anterior wings longer than the median on the externo-median nervure; second discoidal cell not half the size of the third; labrum exserted, longer than the clypeus; abdomen compressed apically NOTOCYPHINI.

First discoidal cell longer than first submarginal; labrum not exserted; length of median cell of anterior wings variable; second discoidal cell at least half the size of the third; abdomen rarely compressed. POMPILINI.

Tribe I.—CEROPALINI.

This tribe contains but a single genus, *Ceropales*, having the characters given above. The species are always more or less ornamented with yellow, some being extremely handsome.

Tribe II.—NOTOCYPHINI.

The genus *Notocyphus* constitutes this tribe, which differs chiefly from the Ceropalini by the non-exserted sting sheath.

Tribe III.—POMPILINI.

The Pompilini contains the typical forms of the family and is, by far, the largest tribe. *Pepsis*, which Saussure considers as a tribe, should, in my opinion, be placed in the tribe Pompilini, as its characters will not warrant a tribal distinction. *Parapompilus* Cress. (non Sm.), *Planiceps* Latr., and *Aporus* Spin., seem to be merely groups of the genus *Pompilus*, as has been pointed out by Kohl. *Epipom-*

† Verh. zool.-bot. Gesell. Wien, XXXIV, pp. 33-58.

pilus Kohl is scarcely worthy of generic distinction, and should be treated as of equal value as *Parapompilus* Cress.

- 1—Anterior wings with three submarginal cells 2
 Anterior wings with two submarginal cells 9
- 2—Third ventral segment with a transverse furrow (indistinct in the ♂ of some species) 3
 Third ventral segment without a transverse furrow 6
- 3—First recurrent nervure received by the second submarginal cell in or about the middle. Hind tarsi (♂) not flattened 4
 First recurrent nervure received by the second submarginal cell not far from its base, and considerably before its middle. Hind tarsi (♂) flattened. Fifth, or fifth and sixth ventral segments (♂) nearly always with long, stiff hair, often forming two tufts. Metathorax with a more or less developed tubercle before each stigma. PEPISIS Fabr.
- 4—Hind tibiae not spinose, or scarcely so; submedian cell of fore wings generally but slightly longer than the median on the externo-medial nervure. 6
 Hind tibiae more or less spinose, generally serrato spinose, most strongly so in the ♀ 5
- 5—Submedian cell of fore wings longer than the median on the externo-medial nervure. SALIUS Fabr. (= *Priocnemis* Sch.).
 Submedian cell of fore wings of the same length as the median on the externo-medial nervure (eyes converging somewhat towards the vertex) CALICURGUS Lep.⁹
- 6—Maxillæ of ♀ with a bunch of long hair at the base.
 AGENTIA¹⁰ Schiodte
 Maxillæ of ♀ naked. PSEUDAGENTIA¹⁰ Kohl.
- 7—Prothorax shorter than the metathorax. 8
 Prothorax longer than the metathorax; head very flat and transverse, the clypeus planate PARAPOMPILUS (Cress, non Smith).
- 8—Legs strongly spinose; prothorax on the sides not strongly depressed; fore femora not swollen POMPILUS Fabr.
 Legs, except tibial spurs, not spinose; prothorax strongly depressed on the sides; fore femora somewhat swollen
 EPIPOMPILUS Kohl.

⁸ Second ventral of some authors.

⁹ I have not seen this genus.

¹⁰ I can find no characters to separate the ♂'s of *Agentia* and *Pseudagentia*, as the characters given by Kohl are not constant. The size of the second and third submarginal cells varies, and while some species of *Agentia* have the wings banded, in others they are clear. Of our species of *Agentia* Cress., *cupidus*, *congruus*, and *acceptus* are *Pseudagentia*. A new genus may have to be erected for *A. Belfragei* Cress. Cameron is mistaken in referring *A. nubifer*, *mexicanus*, *chloris*, *floridus*, *auripilis*, and *subvirescens* to *Pseudagentia*, as they all have the bunch of hair at base of maxillæ.

- 9—Metathorax posteriorly not emarginate, not produced; anterior femora swollen, their tarsi also rather thick; abdomen subcompressed. PLANICEPS Latr.
 Metathorax posteriorly strongly emarginate, produced on each side into a strong tooth; fore femora and tarsi not thickened; abdomen not at all compressed APORUS Spin.

SPHEGIDÆ.

I would divide this vast family into five subfamilies as follows: Spheginae, Pemphredoninae, Bembicinae, Oxybelinae, and Crabroninae. I have thought it best to unite under one head the Larridae, Bembicidae, Nyssonidae, Mellinidae, and Philanthidae, as it is impossible to find characters by which these families (so-called) can be limited, even as subfamilies. The reader is referred to Handlirsch's paper on *Nysson* and *Bembex*.¹¹ It may seem out of place to put the Pemphredoninae close to the Spheginae; yet I feel justified in doing so on account of the abdominal petiole which is peculiar to both subfamilies.

Abdomen connected with the thorax by a slender pedicel of variable length, and never sessile with the following segment.

Intermediate tibiae with two apical spurs; claws nearly always more or less dentate within SPHEGINÆ.

Intermediate tibiae with but one apical spur; claws never dentate within PEMPHREDONINÆ.

Abdomen never connected with the thorax by a slender pedicel, at the most subpetiolate as in *Mellinus*.

More than one submarginal cell, if not, then the eyes are emarginate within; neuration of posterior wings complete.

. BEMBICINÆ.

Only one submarginal and two discoidal cells (eyes entire).

Metathorax with a long projection¹² at base; postscutellum with a squama on each side; submarginal cell confluent with first discoidal cell; eyes elongate-ovate, fully three times longer than they are broad medially and converging towards the vertex OXYBELINÆ.

Metathorax and postscutellum without spines or squamæ; submarginal cell not confluent with the first discoidal cell; eyes very broad, not more than twice as long as the width of their broadest part and strongly diverging towards the vertex.

. CRABRONINÆ.

¹¹ Sitzungsber. K. K. Akad. der Wissen., Wien, XCV, Abth. 1.

¹² This is variously shaped, being sometimes bifurcate and again spinose.

Subfamily SPHEGINÆ.

Represented by two tribes as follows:—

- Metathorax unarmed, never dentate SPHEGINI.
 Metathorax armed with two strong teeth AMPULICINI.

Tribe I.—SPHEGINI.

Three genera belong to this tribe. They have numerous subgenera or groups of species which at one time were regarded as genera. Kohl's admirable paper, Die Hymenopterengruppe der Spheciden,¹³ will be of much value to the student of this group.

Our genera may be separated in the following manner:—

- Second submarginal cell receiving but one recurrent nervure; ♀
 with or without tarsal comb SPHEX Linné.
 Second submarginal cell receiving both nervures.
 ♀ without tarsal comb SCELIPHRON Klug.
 ♀ with tarsal comb AMMOPHILA Klug.

As Kohl's work is probably inaccessible to most workers, I give here a table of groups of the three genera:—

Genus SPHEX Linné.

- Second submarginal cell small, much higher than broad.
 Claws with a single tooth in middle of inner margin; species
 more or less metallic Gr. CHLORION.
 Claws with 2-5 teeth on inner margin; species not metallic.
 Last ventral plate (♀) compressed, almost keeled medially; claws
 bidentate; clypeus produced medially, with a deep sinus on
 each side Gr. PALMODES.
 Last ventral plate (♀) convex, not compressed; claws 2-5 dentate;
 clypeus entire or emarginate medially . . . Gr. HARPACTOPUS.
 Second submarginal cell as broad as high, rhomboidal, or rectangular.
 Metathorax without stigmal furrow; tarsal comb (♀) wanting;
 petiole long and generally bowed Gr. ISODONTIA.
 Metathorax, with exception of *S. Luca*, with a stigmal furrow;
 tarsal comb (♀) present, petiole straight Gr. SPHEX.

Genus SCELIPHRON Klug.

- Prothorax longer than the dorsulum.
 Head from above not triangular, not much produced behind the
 eyes (the prothorax is but little longer than the dorsulum).
 Gr. PODIUM.

¹³ Annalen d. K. K. Naturhistor. Hofmuseum, Wien, V. No. 2, 3.

- Head from above triangular, greatly produced behind the eyes (the prothorax is longer than the dorsulum, scutellum and post-scutellum combined) Gr. TRIGONOPSIS.
 Prothorax not as long, at any rate not longer than the dorsulum.
 Gr. SCELIPHIRON (= *Pelopocus*).

Genus **AMMOPHILA** Kirby.

- Wings with two submarginal cells Gr. COLOPTERA.
 Wings with three submarginal cells.
 Second abdominal segment elongate, forming with the first segment a long petiole Gr. AMMOPHILA.
 Second abdominal segment more or less campanulate, the petiole composed of but one joint Gr. PSAMMOPHILA.

Tribe II.—AMPULICINI.

The genus *Ampulca* is represented in North America by the subgenus *Rhinopsis* Westw. It is distinguished by the rostrate clypeus and by having two submarginal cells. The prothorax is long as in *Trigonopsis*; the metathorax is many ridged and has very strong transverse striæ above and possesses two strong teeth. The first submarginal cell is twice the length of the second. Marginal cell with an appendiculation at apex.

Subfamily **PEMPHREDONINÆ**.

The Mimesidæ are here considered as representing a tribe of this subfamily, and *Mimesa* Shuck. as a synonym of *Psen* Latr. It is impossible to separate these two genera as their characters vary, particularly the neuration. It is true that the inner spur of hind tibiæ of *Mimesa* is peculiarly shaped, but this development will be found in *Psen*, although in a lesser degree.

- Anterior wings with three submarginal cells; antennæ situated far above the clypeus PSENINI.
 Anterior wings with two submarginal cells; antennæ close to base of clypeus PEMPHREDONINI.

Tribe I.—PSENINI.

Psen (= *Mimesa*), the only genus of this tribe, is easily distinguished by the characters given in the above table. The Psenini further differ from the Pemphredonini by the peculiar inner spur of hind tibiæ.

Tribe II.—PEMPHREDONINI.

The tribe Pemphredonini comprises the greater number of the

genera of this subfamily. The following table is based chiefly on that in Cresson's "Synopsis":—

Anterior wings with three discoidal cells, therefore with two recurrent nervures.	
Abdomen with a tolerably long petiole . . .	PEMPHEREDON Latr.
Abdomen with the petiole not longer than the hind coxæ.	
Posterior tibiæ spinose or subserrate; labrum emarginate at tip. ¹⁴	
.	DIDONTUS Curt.
Posterior tibiæ (excepting the calcaria) unarmed; labrum pointed at tip.	PASSALÆCUS Shuck.
Anterior wings with two discoidal cells, therefore only one recurrent nervure	
Anterior wings with one submarginal cell .	AMMOPLAXUS Giraud.
Anterior wings with two submarginal cells.	
Petiole short; recurrent nervure joining the first transverso-cubital nervure	SPILOMENA Shuck.
Petiole long; recurrent nervure received in the middle of the first submarginal cell	STIGMUS Jur.

Subfamily BEMBICINÆ.

Under this head I unite the Larridæ, Bembicidæ, Nyssonidæ, Philanthidæ, and Mellinidæ. The characters of these supposed families are not sufficient or constant enough to sustain them in such a rank, and are valueless in some cases, even as characters of minor importance. As in the case of the Bembicidæ, it is easy to take such types, as *Bembex*, *Monedula*, forms with rostrate clypeus, and separate them into a family, apparently distinct from the Nyssonidæ and Larridæ, if these genera are compared, say, with *Larra* and *Nysson*; but certain genera will be encountered, *Neolarra* and *Bothynostethus* for instance, whose proper position will remain undetermined. *Neolarra* combines both Larrid, Bembicid and Nyssonid characters, yet it will fit in neither of the families defined. *Bothynostethus* inclines to both the Larridæ and Nyssonidæ, and seems to be a connecting link between them. *Stizus* and *Sphæcius*, although placed in the Bembicidæ, possesses the neuration and non-rostrate labrum, characters which bind them to the Nyssonidæ. It must not be forgotten that the labrum of the Nyssonidæ is prominent, indeed in *Gorytes* very prominent. Thirteen tribes of this subfamily seem to be indicated, which number will undoubtedly have to be reduced in the future.

¹⁴ I have not seen *Polemistus* Sauss., described as occurring in Madagascar and Mexico. It is related to *Passalæcus* and *Didontus*.

- 1—Labrum projecting in such a manner as to cover the mandibles when closed, sometimes rostriform 4
 Labrum projecting more or less,¹⁵ but not covering the mandibles, never rostriform; antennæ situated close to or not far from base of clypeus; if the latter is divided into three lobes the middle lobe is not greatly enlarged 2
 Labrum not at all projecting, hidden from view by mandibles; antennæ situated far above the clypeus; middle lobe of latter greatly enlarged. PHILANTHINI.
- 2—Mandibles emarginate on outer margin (except in *Trypoxylon*) . . . 5
 Mandibles not emarginate 3
- 3—Three submarginal cells; intermediate tibiæ with two spurs.
 Second submarginal cell not petiolate; apical joint of antennæ (δ) normal. MELLININI.
 Second submarginal cell petiolate; apical joint of antennæ (δ) peculiarly shaped. NYSSONINI.
 Two submarginal cells; intermediate tibiæ with one spur. NEOLARRINI.
- 4—Intermediate tibiæ armed with two spurs at apex; submedian cell of posterior wings extending far beyond the median on the externo-medial nervure; labrum shorter than the clypeus, generally rounded anteriorly; ocelli distinct STIZINI.
 Intermediate tibiæ with but one spur at apex; submedian cell of posterior wings not extending beyond the median on the externo-medial nervure; labrum longer than the clypeus, rostriform; ocelli more or less imperfect BEMBICINI.
- 5—Hind ocelli normal. 6
 Hind ocelli more or less distorted LARRINI.
- 6—Eyes entire. 7
 Eyes emarginate within. TRYPOXYLONINI.
- 7—Second submarginal cell not petiolate. 8
 Second submarginal cell petiolate. 10
- 8—Middle tibiæ armed with two spurs at apex. 9
 Middle tibiæ with one spur at apex LYRODINI.
- 9—Eyes (δ) touching above; second submarginal cell receiving both recurrent nervures ASTATINI.
 Eyes (δ) not touching on the vertex, widely separated; first and second submarginal cells each receiving a recurrent nervure DIPLOPECTRINI.
- 10—No pygidial area (two submarginal cells) MISCOPHINI.
 A pygidial area (three submarginal cells) BOTHYNOSTETHINI.

Tribe I.—PHILANTHINI.

Hind femora more or less thickened at apex, truncate, and produced beneath CERCERIS Latr. (= *Eucerceris* Cr.).

¹⁵ Astatini and Dioplopectrini seem to be exceptions to this definition, or else the labrum projects so little as to be indiscernible.

Hind femora more or less narrowed at apex, not truncate, and not produced beneath.

Abdomen with first segment not at all petiolate.

Eyes entire within; submedian cell of posterior wings much shorter than the median on the externo-medial nervure; ♀ with a distinct pygidial area APHILANTHOPS Patt.

Eyes more or less emarginate within; submedian cell of posterior wings as long or slightly longer than the median on the externo-medial nervure; ♀ without a pygidial area.

. PHILANTHUS Fabr.

Abdomen with first segment subpetiolate, as in *Mellinus*.

. TRACHYPUS Kl.

Tribe II.—MELLININI.

In this tribe I include *Mellinus* and *Gorytes*, separating them from the Nyssonini chiefly because the apical joint of the ♂ antennæ is normal and is not crescent or otherwise shaped as in the Nyssonini; also because the second submarginal cell is not petiolate as in that tribe.

Antennæ well separated, situated close to base of clypeus, anterior margin of clypeus denticulate; a recurrent nervure received by the third submarginal cell; abdomen always with first segment always petioliform MELLINUS Fabr.

Antennæ approximate, generally well separated from base of clypeus; anterior margin of clypeus rarely or never dentate; third submarginal cell never receiving a recurrent nervure, abdomen rarely with the first segment petioliform GORYTES Latr.

The genera *Hoplisus*, *Dienoplus* and *Euspongius* are identical with *Gorytes*

Tribe III.—NYSSONINI.

Prothorax above subquadrate, longer than dorsulum; metathorax not strongly spinose; (posterior femora beneath at apex, produced into a stout tooth), form slender.

Submedian cell of anterior wings much longer than the median on the externo-medial nervure; abdomen without a pale spot on each side of the second dorsal segment DIDINEIS Wesm.

Submedian cell of anterior wings a little shorter than the median on the externo-medial nervure; abdomen with a pale spot on each side of second dorsal segment ALYSON Jur.

Prothorax above very narrowly transverse; metathorax with two long spines (tooth of posterior femora not so strong as in the preceding two genera); form robust NYSSON Latr.

In the foregoing table *Paranysson* and *Hyponysson* are considered synonymous with *Nysson*. The lack of the third submarginal cell in *N. (Hyponysson) bicolor* is simply an anomaly.¹⁶ I have recently received another anomalous species (which is new) from New Mexico, which lacks the second (petiolated) submarginal cell.

Tribe IV.—STIZINI.

- Marginal cell about twice as long as the first submarginal; spurs of hind tibiae enlarged in the ♀, and the pygidium well developed; abdomen (♂) with a single spine at apex . . . *SPHECTUS* Dhlb.
 Marginal cell much shorter than the first submarginal; spurs of hind tibiae short in both sexes, not enlarged; no pygidium, at the most with two short ridges on each side of apical portion of last dorsal abdominal segment; abdomen (♂) with three spines at apex . . . *STIZUS* Latr.

Bembecinus and *Megastizus* are considered synonymous with *Stizus* in the foregoing table.¹⁷

Tribe V.—BEMBICINI.

- Anterior ocellus linear, transversely arcuate.
 Maxillary palpi six-jointed, labial palpi four-jointed. Metathorax excavated posteriorly, compressed laterally; last ventral segment (♂) with three spines. . . *BEMBIDULA* Burn.
 Maxillary palpi four-jointed, labial palpi two-jointed; metathorax flat or convex behind, not compressed laterally; last ventral segment (♂) with a single spine. . . *BEMBEX* Fabr. (= *Microbembex* Patt.).
 Anterior ocellus elliptic, round or reniform.
 Maxillary palpi three-jointed, labial palpi one-jointed; anterior ocellus longitudinally elliptic; maxillae very long, reaching the hind coxæ . . . *STENIOLIA* Say.
 Maxillary palpi six-jointed, labial palpi four-jointed; anterior ocellus round or reniform; maxillae short . . . *MONEDULA* Latr.

Tribe VI.—NEOLARRINI.

This tribe is based on a single genus *Neolarra* Ashm. which may be distinguished by its tribal characters. I have not examined this genus during the preparation of this classification, but if my memory serves me right it should be placed here, between the *Bembicini* and *Bothnostethini*.

¹⁶ See Handlirsch, Sitzb. K. Akad. Wissensch., Wien. Math.-naturw. Classe. XCV, Abth. 1, p. 293.

¹⁷ See Handlirsch, l. c. CI, p. 26-34.

Tribe VII.—BOTHYNOSTETHINI.

Marginal cell truncate, with an appendiculation; eyes converging towards vertex; hind femora not thickened at apex

PLENOCULUS FOX.

Marginal cell pointed at tip, without appendiculation; eyes diverging towards vertex; hind femora, especially in ♀, thickened at apex.

BOTHYNOSTETHUS KOHL.

Tribe VIII.—ASTATINI.

This tribe is formed of the genus *Astatus*, and is based chiefly on the strange disposition of the eyes of the male sex; they meet on the vertex, a characteristic not found in any other genus of the fossorial Hymenoptera, and not, as far as I know, in any genus of the Order.

Tribe IX.—DIPLOPLECTRINI.

The genus *Diploplectron* forms this tribe. The chief characters are that both sexes have the middle tibiæ two spurred, the very short submarginal cell and the prominent and very long prothorax. It is evidently allied to the European genus *Dinetus*, which probably belongs to this tribe. As the latter is the older genus, the name proposed for this tribe will have to give way to *Dinetini*, but as *Dinetus* does not occur in North America, and as this is simply a classification of the forms inhabiting that region, I prefer to use the name proposed above.

Tribe X.—MISCOPHINI.

Wings with two submarginal cells, the first receiving a recurrent nervure; marginal cell acuminate, not appendiculate; eyes converging but little or not at all towards vertex

MISCOPHUS JUR.

Wings with three submarginal cells, both recurrent nervures being received by the second submarginal cell; marginal cell elongate, truncate at apex and appendiculate; eyes strongly converging towards vertex

NITELIOPSIS SAUND.

Tribe XI.—LYRODINI.

Lyroda, upon which this tribe is based, might be placed in the Larrini, were it not for the regularly formed and distinct ocelli. The only other character worth mentioning in which it differs from the following tribe, is the peculiar shape of the prothorax above, which is being apparently twice emarginate, with the intervening space strongly developed.

Tribe XII.—LARRINI.

Under this head are placed all those genera of the old family Larridæ, which have the hind ocelli distorted and more or less obsolete.

Just within the inner eye margins there is a more or less developed longitudinal fold or swelling.

Mandibles not dentate within; outer side of anterior tibiæ armed with strong spines; pygidium (♀) not pubescent . . . LARRA Fabr.
Mandibles armed with one or two teeth within.

Pronotum drawn under the dorsulum, especially at the sides; metanotum longer than the dorsulum; anterior femora (♂) not emarginate near the base; pygidial area covered with a hoar-frost-like pile NOROGONIA Costa.

Pronotum not drawn under the dorsulum; metanotum shorter than the dorsulum; anterior femora (♂) emarginate near the base as in *Tachysphex* and some species of *Tachytes*; pygidial area on apical portion with short, stiff hairs.

. ANCISTROMMA Fox.

Within the inner eye margins there are no signs of a swelling or fold.

Comb on anterior tarsi (♀) composed of stiff, tolerably short thorns; pygidial area entirely covered with pubescence; hind ocelli linear, hooked at upper end; fore femora of ♂ either emarginate or not emarginate near the base beneath . TACHYTES Pz.

Comb on anterior tarsi (♀) composed of very long flexible spines or bristles; pygidial area naked; hind ocelli oval; fore femora (♂) always emarginate near the base beneath . TACHYSPHEX Kohl.

Tribe XIII.—TRYPOXYLONINI.

Anterior wings with three submarginal cells; abdomen short, sessile.

Female with a well-developed pygidium; marginal cell shorter than the first submarginal; antennæ of ♂ more or less dentate PISONOPSIS Fox.

Female without a pygidium; marginal cell nearly as long as the three submarginal cells united; antennæ of ♂ not dentate. . .

. PISON Spin.

Anterior wings with two submarginal cells; abdomen long, clavate

. TRYPOXYLON Latr.

Subfamily OXYBELINÆ.

In my opinion the peculiar armature of the metathorax and postscutellum, together with the form of the eyes and neuration, justifies the retention of the genus *Oxybelus* in a subfamily. Saussure forms a tribe of it.

Subfamily CRABRONINÆ.

Eyes hairy; mandibles emarginate exteriorly.

..... ENTOMOGNATHUS Dhlb.

Eyes not hairy; mandible not emarginate externally.

Second discoidal cell long, narrow, obtusely pointed at apex,
longer than the first discoidal cell; form short, robust; abdomen
beneath flat, or subconcave ANACRABRO Pack.

Second discoidal cell broadest at apex, shorter than the first
discoidal; form elongate; abdomen convex beneath.

..... S. CRABRO Fabr. (= *Rhopalum*).

RECENT MOUND EXPLORATION IN OHIO.

BY GERARD FOWKE AND W. K. MOOREHEAD.

During the past summer (1894) a number of mounds have been explored in Ohio in behalf of the Academy of Natural Sciences of Philadelphia. The reports of Mr. Gerard Fowke relating to the Van Meter mound and of Mr. Warren K. Moorehead as to the Metzger mound are appended.

CLARENCE B. MOORE.

“MOUNDS IN PIKE COUNTY, OHIO.—Three miles south of Piketon, half a mile from the point where Beaver Creek discharges into the Scioto river, on the farm of J. M. Van Meter,¹ is a ‘double mound’ on the highest terrace. The larger part, measuring, after being plowed over for a number of years, 75 feet in diameter and 10 feet high, has its west base just at the brink of the terrace at a point where the bluff is 50 feet high, quite steep, with the creek at its foot. The smaller, south of east from the first, is six and one-half feet above the surrounding level and 56 feet in diameter. At the junction of the two, the top is three and one-half feet above the general level.

“A trench 10 feet wide was started in the east side of the smaller mound, gradually widening until it was 25 feet at the center, and then drawing in until it was 20 feet wide at 15 feet west of the center. Beneath the middle part was a core 20 feet across and 3 feet high of soil placed and packed, or much tramped, while wet; it was somewhat darker than the loam composing the remainder of the mound, quite hard, and broke off in clods.

“On the original surface of the ground, beginning about five feet east of the center, was a burned place a little over 20 feet across at the widest part, and reaching 20 feet west of the center, or nearly to the lowest point between the mounds. A fire had been burned over this area for a short time only and with a small amount of wood, as the burned earth was nowhere more than an inch thick, most of it much less, while the charcoal and ashes varied from a mere streak

¹ See Catalogue of Prehistoric Works East of the Rocky Mountains, by Cyrus Thomas, page 182. C. B. M.

to a little more than an inch except in one place where a short log six inches in diameter was converted into charcoal.

“Except an arrow and a spear, found loose in the dirt, there was not a relic of any description, nor the smallest fragment of a human bone. A few pieces of much burned bones of small animals or large birds were in the charcoal at the center, and many small pieces of burned stone were scattered all through the mound. The eastern

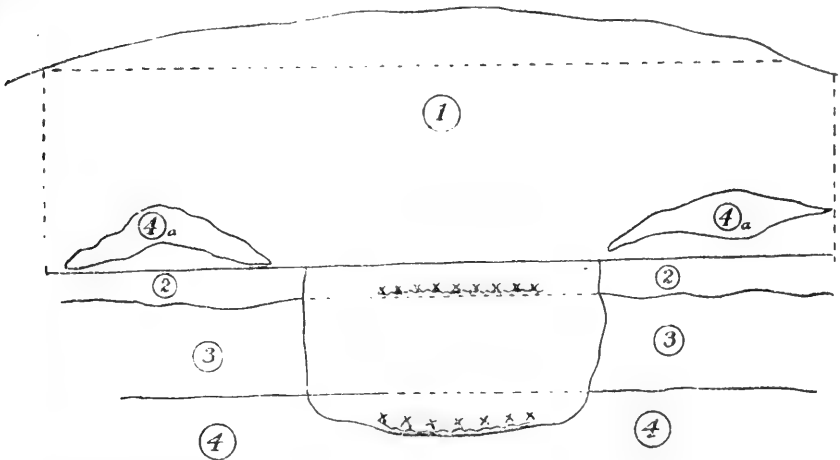

Section of deep grave, 20 feet south from center of larger mound on Van Meter farm.

1. Body of mound, 6 feet.

2. Soil, 1 foot.

3. Subsoil, 3 feet.

4. Gravel, (to bed of river).

4a. Gravel thrown from excavation.

XXXXX. Position of human bones.

Scale. .18 of an inch equals 1 foot.

half contained a large amount of ashes and much charcoal, thrown in with the dirt to help fill up.

“In the larger mound a circle forty feet in diameter was laid off with the apex as the center. This brought the circumference about four feet below the top.

“In the cap, 12 feet east of center were decayed human bones with a few rough beads and fragments of pottery; at the same distance southwest of center were others with a spear or knife by one femur and a flint chisel, polished at the sharp end, near the skull. None of the bones were entire, and being so close to the surface were

as soft as ashes. Six feet southeast of center a flint knife lay near fragments of a skull; and at the place where the chest bones would have been were fragments of a pot that seemed to have been entire when deposited. Less than a foot from the apex were fragmentary human bones.

“A knife and a boat-shaped slate ornament with a crease around the middle were loose in the dirt. Nothing further was found in the upper portion. A well wrought flint spear, $8\frac{1}{2}$ inches long, and a hematite hemisphere were found on the top of this mound some years ago—perhaps plowed out. All the loose earth was now scraped away and concentric circles, five feet apart, laid off on the level surface of the top. In the outer ring, on the northern and western sides, within a foot or less of the top were traces of six skeletons, intrusive burials; nothing was found with any of them.

“A little west of south from center, with its inner margin 17 feet from that point, was an elliptical grave, dug before the mound was begun. It measured a little more than nine feet long and a little more than five feet wide, with the longer axis very nearly east and west. At about 18 inches below the original surface, along the center line of the grave, a body had been placed. Only fragments of the teeth and skull remained, except that a few small pieces of the pelvis and finger bones were preserved by the action of five small rectangular copper plates² that had evidently been fastened around the wrist. These plates were in a little mass of very loose, dark earth, probably remains of some sort of fur or fabric, stained in a few places with red ochre. Nothing else was found in the grave until at the bottom, more than a foot below the upper level of the gray sand, which here lies four feet under the proper surface. At this level lay a few decayed pieces of bones of a medium sized person extended on the back, head east, exactly under the upper skeleton. The body had been covered with bark or wood which extended to the margin of the grave on every side and gave a reddish-brown tinge to the lower two inches of filled-in earth. This earth was from a swamp or low bottom, being black and sticky and evidently packed in wet, causing the entire decay of the skeleton which would otherwise have been well preserved by the dry sand in which it lay. The grave wall was cut down straight for

² See note. C. B. M.

two feet; below this the ends drew in somewhat, while the sides were slightly overhanging, probably from caving in of the gravel while it was being dug. The work was done from the south side, as most of the earth was thrown to that side, the remainder being piled at the two ends.

“At 15 feet north of the center began a streak of burned earth, charcoal, and ashes, which gradually thickened toward the center. It proved to be nearly circular in outline and 20 feet across. For three or four feet around the margin the ashes seem to have been swept toward the center, as the natural earth of the mound had been deposited directly on that burned, without any ashes or charcoal intervening. At eight feet north of center the mass thickened to a foot and held this thickness for six feet farther, and for nearly eight feet east and west. The material forming the charcoal varied from sedge grass to small trees, the largest piece being a pine log a foot in diameter and six feet long. The inner portion of this was in its natural condition, the charred outside having preserved the part to which the fire had not reached. Much of the charcoal was from wood burned while green and was bright as polished metal where it had been kept tolerably dry. There were a few fragments of animal bone here and there, and enough small pieces of human bone to show that a body or skeleton had been cremated, some of them being like cinder, others scarcely charred. The thinness of the ashes and the amount of the charcoal showed that the fire had been smothered while much of the fuel remained on it. Lying on the top of the charcoal where it was thickest was a considerable quantity of charred cloth, showing at least four distinct methods of weaving; there was also much of what seemed to be fur or some such material; the latter was soft as soot, while some of the cloth was fairly well preserved, a very little of it showing scarcely any mark of burning.

“Except as noted above, no relics of any description were found anywhere in the lower part of the mound.

GERARD FOWKE.”

The five rectangular sheets of copper found with human remains by Mr. Gerard Fowke, beneath the base of the larger Van Meter mound, near Piketon, Pike Co., Ohio, consisted of sheet copper oxidized and carbonated to a certain extent, though a large percentage of metal was unaffected. These sheets, though not exactly similar as to

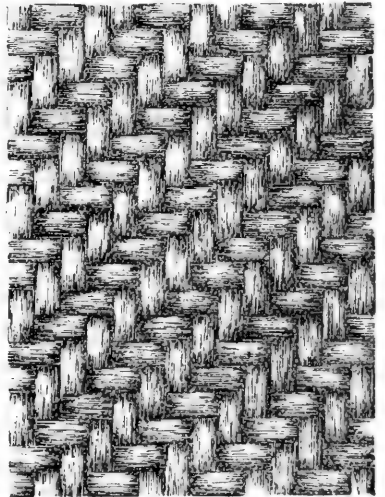
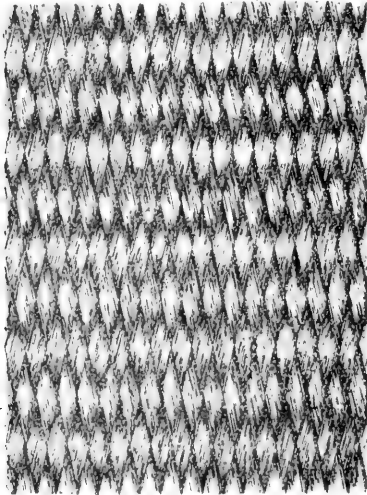
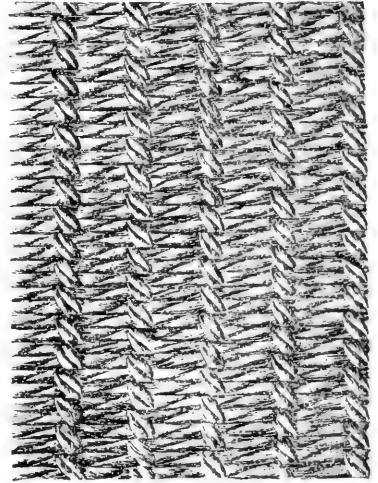
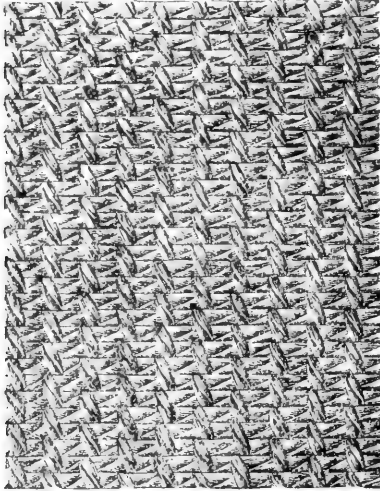

Vegetable fabric, with sections. Larger Van Meter Mound. (Double size.)

length and breadth, do not vary materially, so that the measurement of one, namely 2.5 inches by 3.2 inches, may be considered to apply approximately to all. That they had been portions of a sheet or sheets of larger size was evidenced by at least one closely ground edge on each specimen, contrasting markedly with the rough line of separation of the other margins. No ornamentation like the beaded margin and the *repoussé* work of Florida and Tennessee was apparent, though the marks of numerous blows from a convex blunt cutting-edge were visible on all the specimens. Exfoliation was noticeable near the edges. The sheets were of irregular thickness averaging about 1 mm.

Notwithstanding these indices of aboriginal origin, so solid was the appearance of the copper that, though no believer in a post-Columbian origin for mounds as a rule, I admit having experienced a feeling of doubt as to the origin of this copper, a doubt which a thorough and careful analysis, made by Ledoux and Company, of New York, speedily dispelled. The result is given in detail:—

Copper	99.9130
Silver	0.0198
Arsenic	0.0026
Antimony.	Trace
Iron	0.0233
Nickel and cobalt	0.0080

“NOTE:—The above analysis was made after removing the superimposed film of oxides and carbonate from the sample. Special examination for lead, bismuth, and zinc shows that none of these is present.”

It is quite evident that here we have to do with native copper of a purity greater than is ordinarily produced at the present time by any smelting process³ and consequently of a still higher degree of purity than would be the product of early processes of smelting the arsenical sulphide ores of Europe⁴. Moreover, the introduction of lead in refining, though not an invariable custom, was extensively practised in Europe, especially in copper intended for sheet or wire, and its

³ All smelted copper contains from three to ten hundredths of one per cent. of combined oxygen.

⁴ For full details as to aboriginal copper the reader is referred to "Certain Sand Mounds of the St. John's River, Florida, Part II," Journ. Acad. Nat. Sci., Vol. X.

absence, in connection with freedom from considerable quantities of arsenic, or antimony, or both, may always be regarded as good evidence against an early European origin.

CLARENCE B. MOORE.

“THE METZGER MOUND.—This structure, the property of Mr. Charles Metzger, is located on Deer Creek, about two miles from Yellow Bud (southwest). Situated upon a hill one hundred and fifty or one hundred and sixty feet in altitude, the mound commands a fine view of the surrounding country. The plains stretch away towards the Scioto three miles distant and continue two miles east of the river, where they terminate in high hills. The mound is very-nearly round, and is thirty-four feet in height by two hundred feet in diameter at the base. Alongside of it is a horse-shoe or crescent-shaped embankment and two small mounds.

“On August 20, 1894, work was begun upon the structure. The mound had been originally opened by some farmers. When they began work the structure stood forty feet in height. They sank a circular shaft eight feet in diameter from the apex downwards.

“Our men first reduced the height of the mound about ten feet. This gave a platform fifty feet in diameter and twenty-four feet above the surrounding surface. The ground in the center of the structure (where the previous excavation had been sunk), we found to be very damp and heavy, and as we proceeded downward, we became convinced that the log pen found by the original excavators in the center of the structure would be in a bad condition, and that we must depend on other pens were we to take out any logs entire.

“The structure was composed of ordinary hill clay. At the top it was not stratified, and as it varied but slightly in color, it was extremely difficult to distinguish any of the ‘dumps.’⁵ On August 22nd a very fragmentary skeleton was found about twelve feet below the top and four feet southwest of the central excavation. The body had been originally buried in bark which percolation of water from above had utterly decomposed. With the bones was a spool-shaped button of copper, about an inch in diameter, heavily coated with copper oxide.

“The 25th two teams were put upon the mound, and they, together with the shovels, reduced it rapidly. When within four feet of the

. ⁵ A “dump” represents the load deposited by one man.—C. B. M.

top of the log pens we dispensed with the teams and used the shovellers for the remainder of the work. One or two arrow-heads were found during the course of the excavations.

“At eighteen feet from the top and eight feet north of the center was a fairly well preserved skeleton surrounded by pieces of saplings and logs, two to four feet in length. These were originally laid, one above the other, to the height of about a foot. These logs, being of small size, when decayed, had broken beneath the weight of earth. The bones of the skeleton were unusually yellow. No relics were found with the remains. We saved some samples of the wood, which experienced timber men pronounced oak and walnut.

“On the 27th and 28th numerous bunches of fine roots and underground moss were encountered. Samples of the moss were preserved. There were also several deposits of boulders, made without apparent reason. The mound, at this point (twenty-three feet from the top, nine feet from the bottom), appeared to be stratified, and the earth was very soft in places.

“The log pen in the center of the mound, and the one northwest of it, remained for many years before they caved in. That is, the



Metzger Mound, diagram showing banded structure of portion of east wall of trench when partially excavated.

wood did not decay for a long period of time. In the case of the first or largest pen (central one) the earth was kept out of a space $12 \times 15 \times 4$ feet. The second pen occupied a space about 8×10 and about 6 feet high, and was constructed differently from the first, being very small at the top. These pens existed long enough for the earth above them to be packed into large clods, which did not fall into the cavity when the wood decayed but gradually settled, forming an arch. The second arch was about 8 feet in diameter at the bottom and 7 feet high. The cavity was filled with underground moss. There was no evidence that moisture had ever entered the

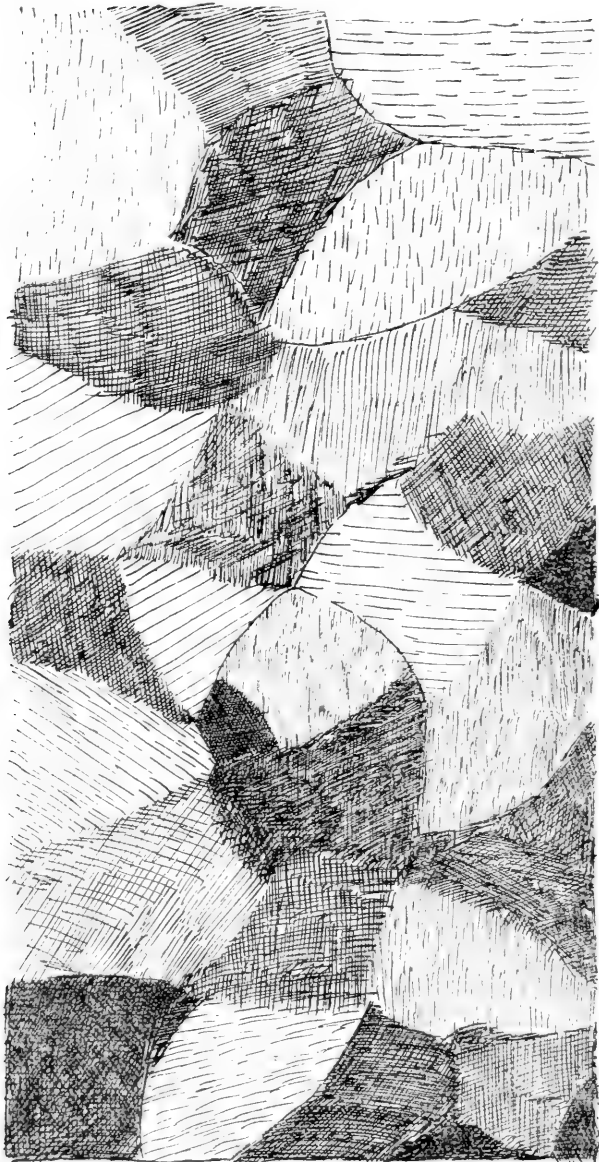

Stephenson.

B. Metzger Mound.—Diagram of horizontal section showing size and shape of basket dumps. Size of section 3 x 6 feet. Colors of the earth found within limits of this diagram were black, light and dark brown, yellow and bluish gray.

little cave. It was perfectly dry with fine dust in the bottom. The moss would blaze when touched with a match. In the central pen the conditions were entirely different. The excavation sunk by the farmers permitted water to penetrate entirely over 15 x 20 feet of the base of the mound.

“As the main trench was continued we noticed several small ash pits and patches of dark and also burnt earth. In these were ashes, pottery fragments, animal bones, mussel shells and flint chips. This village site refuse was not considerable.

“Below the upper portion different colors in the mound showed plainly the ‘dumps’ which contained from a peck to a third of a bushel each. They clearly showed the mound to have been constructed entirely by manual labor, and that about as much earth as could be conveniently carried by one person was deposited in each load. The drawing *B* shows the section, three by six feet, which has been carefully ‘scalped’ and smoothed to bring out the shades.

“The trench at this point was about forty-five or fifty feet in width and was level throughout. The last three or four feet taken out by the teams were removed from the center, and when the shovellers began, the trench dipped from either end to the center. In working to the original base line a large bed of ashes was uncovered. The log pen itself extended 12 feet east and west to 15 feet north and south. The statement of the original excavators we can hardly verify. It appears that the pen was composed of smaller logs than they state. Two large logs have left a broad, thick strip of decayed wood on the narrowest side of the pen. One corner of the pen ran over into the ash pit. The logs at the southeast corner seem to have been somewhat larger than the others, and were badly decayed, but we managed to dig around them and bring them into relief. Drawing *C* shows the pen as far as we were able to trace it.

“There were here and there fragments of red pottery. About one foot below the remains of the logs were original yellow clay and shale clay the natural hill soil. The decayed logs and the reddish earth resulting from their decay would fill four or five barrels. This will give an idea of the bulk which they originally represented. It was our opinion from the excavation that most of the logs were saplings, and that the pen was not as large as claimed by the original explorers. While as large north and east it certainly was not more than four feet high.

“The sides of the trench were undermined as much as was consistent with safety. It was found that there was nothing in the first

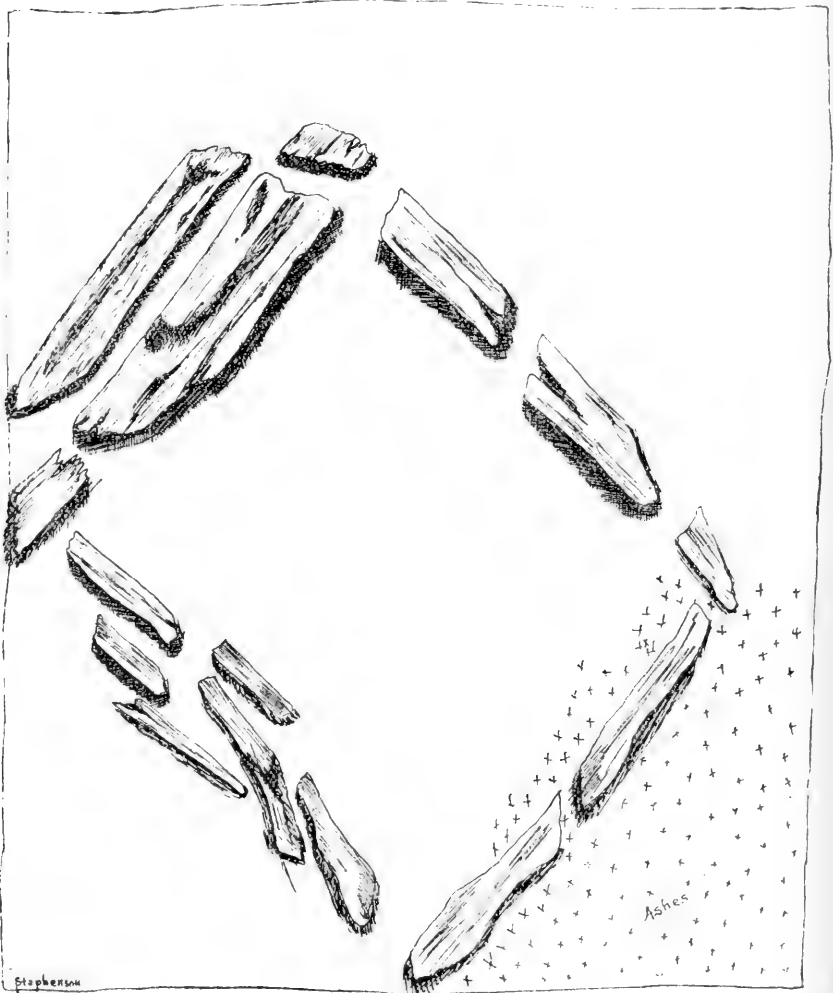

C. Metzger Mound.—Diagram of surface of excavation showing pen two feet above base of mound.

or main trench save the pen described, the refuse, the two fragmentary skeletons, the copper ear button and a few arrow-heads.

The trench was cleaned to the original surface and experimental holes were sunk even to the shale. There were no burials below the original surface.

“The ground had been levelled and burnt, thus giving the mound an even floor or base. In nearly all mounds of the lower Scioto this peculiarity of construction is observed. It is, therefore, very easy to keep upon the base line.

“A bed of ashes was discovered about four feet from the bottom on the northwest side of the trench. In it were bits of charcoal of exceedingly bright lustre and as hard as bituminous coal. The ash bed was everywhere covered with a thin layer of reddish bark. It was impossible to preserve the bark in sections larger than two by three inches. The earth below the ashes was burnt a bright brick red. The ashes varied from three inches in thickness to a feather edge, but a quarter of an inch thick. The earth covered by them extended over ten by six feet.

“It was near the northwestern edge of the ash bed that we found the end of a large log. Numerous small logs were found above and around this large one, but it did not appear that they were laid with any regularity. They did not seem to be as large as those reported by the men who dug the first hole in the mound. Most of them were six or eight inches in diameter, and six feet in length. They were badly rotted and only a few fragments were saved. Possibly by the use of plaster of Paris sections might have been secured several feet in length, but the ends were so decayed that they would not have shown whether or not they were cut by stone axes. As soon as the end of the log was uncovered the men were set to work upon the ash bed with hand trowels, and they dug over the ground very carefully for more than a day but found nothing of importance. The ashes were very white, and resulted from the burning of large quantities of wood.

“When the end of the log was uncovered it appeared to be fifteen or sixteen inches in diameter, and being accidentally struck by a pick, we were rejoiced to hear it ring as though of sound fresh wood. We were compelled to spend three days more and to cut down the bank between the log and the edge of the mound outside so that the teams could pass in and out. By these two excavations (both were widened) we moved two-thirds of the earth in the mound. Near the log the earth on all sides was very loose, and in the form of clods

and large chunks rather than fine soil. It appeared that a circle of saplings had been placed about the log.

“The log must have been cut at a distance and carried to the mound. There is no cedar within ten miles of the structure at the present day, and none was seen by the early settlers. However, it may be that cedar grew upon this hill in pre-Columbian times. The trench extending to the northwest and uncovering the log was 35 feet in width and something over 100 feet in length.

“On Tuesday, September 4th, the excavation reached the bottom of the log, and measurements gave its length as 18·5 feet with a circumference of 5·4 feet. Immediately below the log was a skeleton. The saplings or small logs constructing the pen had been planted in the earth around this skeleton, somewhat after the form of a tepee. The skeleton itself lay upon the original shale in an excavation two feet below the surface of the ground. It was 20 feet from the slope of the mound directly above or 36 feet below the level of the summit. The skeleton lay with head to the north, arms at the sides, and legs extended. Around each wrist were two copper bracelets. At the neck and upon the chest were several hundred shell beads. There were also the tusks of some large animal. The dry ashes with which the remains were covered, and the great depth from the surface aided in the preservation of such substances as usually decay. Traces of hair were about the skull, the brain,⁶ dried and shrivelled, was found within it, and cloth, buckskin and rude matting and bark covered the remains. All of these were carefully removed and boxed.

“A rough count made on the spot gave the number of beads as 480.

“After removing the skeleton the log was sawed into two sections and carried out and shipped. The outline of the pen was photographed and drawn, and the whole base of the trench down to the original shale carefully dug over. The loose and partly arched earth on either side of the trench was carefully taken out. The possible presence of other pens in the mound was settled in the negative. The sides were undermined at considerable risk and the walls were allowed to fall. Another inspection showed the absence of other burials in the structure.

⁶ This remarkable preservation of the brain is as yet unexplained, though a number of authorities have been consulted. A paper will be devoted to it.—C. B. M.

“Subsequently work of filling up began, and when completed the mound stood about 15 feet in height, flat on top and about 250 feet base.

“The crescent and the small mounds near it were carefully opened but nothing of importance was discovered. Three holes were dug in the crescent, one at each end and one in the center. The crescent averaged three feet in height, was 118 feet across from end to end, 10 feet in width and 250 feet around. There is no evidence of a considerable village site near either of the mounds or the crescent.

WARREN K. MOOREHEAD.”

NEW SPECIES OF FUNGI FROM VARIOUS LOCALITIES.

BY J. B. ELLIS AND B. M. EVERHART.

* HYMENOMYCETES.

Crepidotus albidus E. & E.

On bark of (*Tilia*)? Ann Arbor, Mich., May, 1894 (A. J. Pieters).

Pileus resupinate-sessile, nearly white, glabrous, $\frac{1}{2}$ – $\frac{3}{4}$ cm. across, margin incurved when dry. Lamellæ not crowded, thin, broad for the size of the plant, pallid, becoming yellowish-brown, radiating from a lateral point, spores yellowish-brown, subinequilaterally elliptical, about $5 \times 3\frac{1}{2}\mu$.

Polyporus pachycheiles E. & E.

On the side of a rotten maple (*Acer rubrum*) stump, Newfield, N. J., Nov. 1893.

Imbricated, small, $1\frac{1}{2}$ –2 cm. wide, 1 cm. long, milk-white at first, margin soon turning yellow, mostly narrowed behind, the pilei connected by a resupinate layer, surface apparently velutinous but not tomentose, hardly depressed behind. Pores minute, 2–3 mm. long, 120 – 150μ wide, round or by the splitting of the walls, here and there subsinuate, margins even, not lacerate-toothed. Flesh of pileus thin, not over 1 mm. thick and like the pores and the whole plant tough-cartilaginous. Surface of pileus faintly zonate toward the margin, more distinctly so in drying. The pores are nearly as long in front as behind, thus thickening the margin of the pileus, hence the specific name.

Poria inermis E. & E.

On dead shrubs and limbs of various deciduous trees, Newfield, N. J. Received also from Michigan, Canada, Nebraska and Louisiana. Issued in N. A. F., No. 313, as *Polyporus obliquus*, from which it is quite distinct.

Resupinate, adnate, seriate, extending along the limb for six inches or more and about one inch wide, yellowish-brown, 2–4 mm. thick in the middle, margin thin, narrow, light-yellow (when fresh) and closely adnate. Pores small, round, extending down to the underlying wood. Spores ferruginous, sub-globose, 4– 5μ diam.

Mucronoporus fulvidus E. & E.

On dead limbs of *Abnus*, Berkeley, Cala., Jan., 1894 (W. C. Blasdale, No. 181).

Resupinate, adnate, tawny-yellow, extending along the limb for 6-8 or more centimeters and 3-4 cm. wide, margin velvety tomentose, narrow, sterile, adnate. Pores short (1 mm. or less), round, extending down to the matrix without any distinct subiculum. Spores hyaline, sub-globose, about 2μ diam. Spines tolerably abundant, $25-35 \times 3-4\mu$, rather pale.

Has the aspect of *Poria inermis* E. & E., but surface of pores more uneven, and spiny within.

Hydnum Washingtonianum E. & E.

On the ground in deep coniferous woods, Tracyton, Kitsap Co., Wash., Dec., 1893 (Adella M. Parker, No. 214).

About 4 cm. high, pale orange, carnose, subviscose. Stipe central, 3 mm. thick, subattenuated below. Pileus about 4 cm. across, slightly depressed in the center, thin, glabrous, wrinkled when dry. Aculei subulate, cylindrical, 3-5 mm. long, pale yellow, nearly white when fresh, decurrent half way down the stem. Spores angular-globose, (white)?, $6-7\mu$ diam., borne on clavate-cylindrical basidia $20-22 \times 6\mu$, with 4 erect, slender sporophores about 6μ long.

From *H. repandum*, to which it is closely allied, it differs in its decurrent aculei and tougher substance.

Tremellodon pusillum E. & E.

On rotten wood, among coniferous trees, Tracyton, Wash., Dec., 1893 (Adella M. Parker, No. 212).

Small, stipitate, gelatinous, white and nearly transparent. Pileus subreniform, membranaceous, $1-1\frac{1}{2}$ cm. across, smoky-brown above and sparingly clothed with weak, pale hairs. Teeth not crowded, white, subcompressed, about $\frac{1}{2}$ mm. long, narrowed gradually from the base, with a few obtuse, short, lateral, tuberculiform branches or processes. Spores ovate-globose, $5-6 \times 3\frac{1}{2}-4\mu$, consisting of a thin, transparent sack containing a single, large globose nucleus. Stipe lateral, cylindrical, slender, equal, hirtio-pubescent, 1 cm. long, 2 mm. thick, smoky-brown.

T. hirneoloides B. & C. is a much coarser, stouter plant, with stipe 18 mm. long, 8 mm. thick at the base.

Coniophora capnoides E. & E.

On bark of dead maple, London, Canada, Sept., 1892 (Dearness, No. 2,004).

Very thin, purplish, margin of the same color, much resembling outwardly, *Corticium fumigatum*, Thum., only not at all cracked and of a darker color. Spores brownish, smooth, globose, $3-3\frac{1}{2}\mu$ diam., or short elliptical, $3\frac{1}{2}-5 \times 3-3\frac{1}{2}\mu$, borne singly on the apices of short, brown basidia or rather emitted successively from these basidia, in which several spores already formed may be distinctly seen. The subhymenial hyphæ are very scanty, and the bark has the appearance of having been for some time exposed to smoke.

Peniophora Atkinsoni E. & E.

On bark of some deciduous tree, Syracuse, N. Y. (Prof. Geo. F. Atkinson).

Closely adnate, thin, smoky-lilac, or smoky-drab color, surface uneven, 1-3 cm. across. Cystidia subulate-cylindrical, slightly roughened above, $30-40 \times 5-7\mu$, projecting above the hymenium $12-20\mu$. Spores hyaline, compressed, elliptical when viewed in front, $4-5 \times 2-3\mu$, subballantoid when seen edgewise, $4-5 \times 1\frac{1}{2}-1\frac{1}{2}\mu$.

Corticium alboflavescens E. & E.

On dead, standing trunk of *Kalmia latifolia*, Nuttallburg, W. Va., Feb. 1894 (L. W. Nuttall, No. 365).

At first orbicular, subpezizoid, 1-2 mm. diam., becoming more irregular in shape and 1 cm. or more diam., lower stratum milk-white, consisting of loosely interwoven, branching threads, and extending out beyond the pale-olivaceous or yellowish, membranaceous hymenium so as to form a thin subfimbriate, white margin. Spores abundant, globose, with a single large nucleus, $4-6\mu$ diam., slightly colored.

The hymenium has only a slight tinge of olive and is perhaps better described as light-drab color.

Dacryomyces flabella E. & E.

On a decaying stump, Mercer Island, near Seattle, Wash., Nov., 1893 (Adella M. Parker).

Fan-shaped, deep orange color, gelatinous, $1\frac{1}{2}-2$ cm. broad and high, with a short, lateral stipe, suberect with the opposite margins incurved so as to bear some resemblance to *Peziza onotica* Pers., subtuberculiform, or otherwise irregular in shape when young.

Spores oblong-cylindrical, with an oblique apiculus below, obtuse and rounded above, yellowish, about 7-septate, $15-18 \times 6\mu$, about the same as in *D. stillatus*, from which its fan-shaped form and lateral stipe will readily distinguish it.

* * PYRENOMYCETES.

Capnodium caespitosum E. & E.

On living leaves of *Photinia Japonica*, Pasadena, Cala., July, 1894 (Prof. A. J. McClatchie, No. 748).

Perithecia subulate-cylindrical, simple or branched, 300-400 x 60-70 μ , collected into compact, convex-hemispherical clusters 1-3 mm. diam., scattered over the upper surface of the leaf and bristling with the projecting points of the perithecia. There is no mycelium spreading over the surface of the leaf, only a few erect, moniliform threads mingled with the perithecia. Sporidia (spores)? ovate, 3-septate and sub-hyaline at first, finally submuriform and dark-brown, $12-20 \times 7-10\mu$. We have not been able to make out the asci with any certainty.

Nectria pallida E. & E.

On dead bark of *Carya alba*, Missouri, Oct., 1891 (C. H. Demetrio, No. 276 partly).

Stroma mucedinous, white, forming small ($\frac{1}{2}$ -1 mm.) white tufts, or subeffused. Perithecia 6-20 on a stroma, globose or slightly ovate-globose, minutely pulverulent, about 150 μ diam., pale-yellow, with the ostiolum obscure. Asci clavate-cylindrical, sub-sessile, $40 \times 6-7\mu$, paraphysate?. Sporidia biseriate or obliquely uniseriate, oblong-fusoid, 3-4-nucleate, hyaline, apparently becoming uniseptate but not constricted, $6-8 \times 2-2\frac{1}{2}\mu$.

Sometimes the perithecia stand singly or 2-3 together on scattered shreds of the white, mucedinous stroma.

Venturia vaccinii E. & E.

On dead leaves of *Vaccinium ovatum*, Seattle, Wash., Dec., 1893 (C. V. Piper, No. 225).

Perithecia hypophyllous, scattered, astomous, globose, 80-100 μ diam., rather sparingly clothed with stout, straight, black spines 30-60 μ long. Asci lanceolate, $25-35 \times 6-7\mu$, 8-spored. Sporidia biseriate, fusoid, hyaline, subinequilateral, faintly uniseptate, $10-12 \times 2-2\frac{1}{2}\mu$.

Chaetomium pallidum E. & E.

On an old yeast-culture, made on a piece of carrot, London, Canada, March, 1893 (J. Dearness, No. 2,245).

Perithecia superficial, thin membranaceous, pale, ovate, 150–200 μ diam., with a conic-papilliform ostiolum. Asci not distinctly made out, but judging from the arrangement of the sporidia, oblong-clavate 30–35 x 10–12 μ . Sporidia biconical, brown, becoming nearly opaque, 14–18 x 10–12 μ , narrowed and obtusely apiculate at the ends.

Differs from the usual type of *Chaetomium* in its pallid perithecia sparingly clothed with spreading white hairs, but by exposure and age the color of the perithecia becomes darker.

Lasiosphæria hystrix E. & E.

On decaying limb of *Salix*, Ohio (Morgan, No. 1,021).

Perithecia gregarious, depressed-hemispherical, $\frac{1}{3}$ – $\frac{1}{2}$ mm. diam., clothed all over except the broad, tuberculo-papilliform ostiolum, with straight, spreading, stout, snuff-brown hairs 100–250 μ long and 6–7 μ thick at the base. The matrix is also overrun with a subiculum of finer, interwoven, branching hairs. Asci clavate-cylindrical, short-stipitate, paraphysate, 8-spored, 120–160 x 20 μ . Sporidia lying parallel in the asci, fusoid-cylindrical, hyaline, multinucleate, becoming 7–15-septate, nearly straight, ends obtuse, 45–65 x 8–10 μ .

Comes nearest *L. caesariata* C. & P., but that is black and shining and beset with scattered, black hairs; it also has smaller 5–7-septate sporidia.

Rosellinia limoniispora E. & E.

On dead leaves of *Fraxinus*, Rockport, Kansas, Aug., 1894 (E. Bartholomew, No. 1,545).

Perithecia gregarious, superficial, ovate, about $\frac{3}{4}$ mm. diam., often flattened or depressed above, clothed except the black, mammiform ostiolum, with a thin, pruinose-tomentose coat which soon disappears, leaving the surface minutely granular-roughened. Asci (p. sp.) 70–75 x 9 μ , with a short stipe, 8-spored, paraphysate. Sporidia obliquely uniseriate, limoniform, (i. e., acutely elliptical), the ends submucronate, 12–15 x 7–8 μ , dark-brown.

The absence of any subiculum, and the smaller differently shaped sporidia separate this from *R. medullaris* and *R. mastoidea*.

Rosellinia cæspitosa E. & E.

On dead limbs of *Celtis occidentalis*, Rockport, Ks., Nov., 1893 (Bartholomew, No. 1,252).

Perithecia densely gregarious or cespitose, minute (175–200 μ diam.) ovate-globose, rough, with conical or conic-papilliform ostium. Asci cylindrical, 60–79 x 8 μ when the sporidia lie obliquely, 75–90 μ long when they lie end to end, paraphysate, 8-spored. Sporidia uniseriate, rather acutely elliptical, brown, continuous, 9–13 x 6–7 μ .

Distinguished by its small, rough, clustered perithecia.

Rosellinia bicolor E. & E.

On rotten wood, Louisiana (Langlois).

Perithecia gregarious, hemispherical, black-brown, $\frac{1}{2}$ mm. diam., thin and fragile, seated on a white subiculum of interwoven, branching hyphae. Asci cylindrical, 125–140 x 8 μ , 8-spored, paraphysate. Sporidia uniseriate, broad-fusoid, subinequilateral, 3–4 nucleate, hyaline becoming brown, 20–23 x 6–7 μ .

Perithecia only about half as large as in *R. morthieri* Fekl., and not flattened at the apex. Ostium minute, papilliform.

Rosellinia ostiolata E. & E.

On bark of *Ulmus Americana*, Rockport, Kansas, Apr., 1894 (Bartholomew, No. 1,429).

Perithecia scattered or subgregarious, superficial, ovate-globose, $\frac{3}{4}$ mm. diam., black, minutely granular-roughened, slightly narrowed at the base, with a stout, obtuse, short-cylindrical, or conic-cylindrical ostium. Asci clavate-cylindrical, 150 x 25 μ , paraphysate, 8-spored. Sporidia rhomboid-elliptical, longitudinally rugose, brown, continuous, 25–38 x 20–22 μ . Some of them smaller and subglobose, but this may be a deformity.

Rosellinia pinicola E. & E.

On a weather-beaten pine board, Rockport, Ks., Feb., 1894 (Bartholomew, No. 1,379).

Perithecia loosely gregarious, erumpent-superficial, ovate-globose, grayish-black, $\frac{1}{2}$ mm. diam. Ostium minute, papilliform, sometimes slightly compressed. Asci cylindrical, 60–65 x 4 $\frac{1}{2}$ μ , p. sp. 40–45 μ long, paraphysate, 8-spored. Sporidia uniseriate, elliptical, 5–8 x 3–4 μ , the shorter ones sub-globose, brown, 2–3-nucleate.

Differs from *R. ovalis*, Ell. in its smaller perithecia and sporidia.

Melanomma asterostomum E. & E.

On bark of beech roots, Granton, Ontario, Canada, Jan., 1894 (J. Dearness, No. 2,238).

Perithecia gregarious, ovate-conical, rough, black, $\frac{1}{2}$ – $\frac{1}{3}$ mm. diam., with a conic-papilliform, often distinctly radiate-sulcate 4–5 cleft ostiolum. Asci clavate-cylindrical, 8-spored, paraphysate, p. sp. 45–50 x 8–10 μ . Sporidia crowded-biseriate, oblong-fusoid, 3-septate, often constricted at the septa and one of the inner cells smaller, pale olivaceous-brown (nearly hyaline at first), 12–15 x 3–4 μ .

Differs from *M. fuscidulum* Sacc., in the shape of the perithecia and very different ostiolum.

Melanomma moricolum E. & E.

Perithecia gregarious, scattered, semi-erumpent, sub-globose, $\frac{1}{2}$ mm. diam., with a minute papilliform ostiolum. Asci clavate-cylindrical, short stipitate, paraphysate, 8-spored, p. sp. 40–45 x 7 μ . Sporidia biseriate, oblong-fusoid, slightly curved, sub-obtuse, yellowish-brown, 12–15 x 3–4 μ , mostly not constricted, but when mature, some of them distinctly so.

Differs from *M. Mori* H. Fabre, in its much shorter asci and rather smaller biseriate sporidia.

On dead small limbs of *Morus*, Rockport, Kansas (Bartholomew, No. 1,447 partly).

Melanomma alpestre E. & E.

On dead twigs of *Arctostaphylos Nevadensis*, Mt. Paddo, Wash., July, 1886, Alt. 6,000–7,000 ft. (W. N. Suksdorf, No. 268).

Perithecia scattered, hemispherical, 1–1 $\frac{1}{2}$ mm. diam., carbonaceous, black, glabrous, superficial, flattened, with a minute papilliform ostiolum. Asci cylindrical, short-stipitate, paraphysate, 110–150 x 10–12 μ . Sporidia overlapping-uniseriate, or (in the longer asci) lying end to end, oblong-cylindrical, obtuse, slightly curved, 3-septate, brown, 18–22 x 5–6 μ .

One perithecium contained two distinct ascigerous nuclei, seeming to indicate that the outer, black shell described above as a perithecium, is in reality a stroma, but the material was too scanty to enable us to settle this point definitely and we have, therefore, referred the spec. to *Melanomma*.

Melanomma dealbatum E. & E.

On old decorticated, bleached and weather-beaten cottonwood logs, Rockport, Kansas, Feb., 1894 (Bartholomew, No. 1,369).

Perithecia scattered, erumpent-superficial, black, glabrous, ovate-globose, 200–225 μ diam., at length more or less collapsing above. Ostiolum papilliform, minute. Asci oblong-cylindrical, short-stipitate, paraphysate, 75–110 x 10–12 μ . Sporidia overlapping uniseriate, or more or less perfectly biseriate, obovate, hyaline, becoming pale-brown, 3-septate, 12–15 x 6–7 μ .

Some of the perithecia are sub-elliptical.

Differs from *M. obliterans* B. & Br. in its habitat (on wood of deciduous tree), and its constricted sporidia; from *M. Catillus* Sacc. in the character of the sporidia and smaller perithecia, nor does it seem referable to any other species with 3-septate sporidia.

Trematosphæria vitigena E. & E.

On old, decaying wood of *Vitis rupestris*, Nuttallburg, West Va., Apr., 1894 (L. W. Nuttall, No. 454).

Perithecia gregarious, sunk in the wood all except the obtuse, convex apex, $\frac{1}{2}$ – $\frac{3}{4}$ mm. diam., depressed-globose, the buried part rather thin-walled, the erumpent, convex apex thick, solid, like the stromatic shield of *Clypeosphæria*. Ostiolum papilliform, soon perforated. Asci clavate-cylindrical, paraphysate, 8-spored, 86–100 x 10–12 μ . Sporidia sub-biseriate, fusoid-oblong, 3-septate, and constricted, sub-acute, pale-brown, 20–25 x 6–7 μ .

Trematosphæria Frazini E. & E.

On dead limbs of *Fraxinus viridis* that had lain for some time in water, Rockport, Kansas, Feb., 1894 (Bartholomew, No. 1,373),

Perithecia scattered, semi-erumpent, small, elliptical (on a horizontal section), 300–500 x 250–300 μ , the base sunk nearly to the wood, the erumpent apex closely embraced by the epidermis. Ostiolum papilliform, soon deciduous and then, perithecium perforated. Asci clavate, short-stipitate, paraphysate, 70–80 x 12–15 μ , 8-spored. Sporidia overlapping below, biseriate above, fusoid-oblong, brown, 3-septate and constricted at all the septa, often with one cell swollen, slightly curved, 20–27 x 6–8 μ .

The spec. of *Sphæria melina* B. & Br. in Rab. F. E., 1835, have perithecia ovate-conical, $\frac{1}{2}$ –1 mm. diam. and sporidia uniseriate, 4–6-nucleate, not constricted, straight, 22–30 x 12–15 μ and are certainly different from this.

Teichospora (*Teichosporella*) *Ohiensis* E. & E.

On hard wood, Ohio (Morgan, No. 1,012).

Perithecia densely gregarious, superficial, grayish-black, rough, ovate-globose, 300–400 μ diam, with a broad papilliform, soon perforated ostiolum. Asci cylindrical, short-stipitate, 55–62 x 7–8 μ , 8-spored (paraphysate)? Sporidia uniseriate, short-elliptical, yellowish-hyaline, obscurely 1–3-septate and muriform, 10–12 x 6–8 μ .

Has the general aspect of *Rosellinia pulveracea* (Ehr.).

Teichospora tuberculata E. & E.

On wood of *Liriodendron*, Ohio (Morgan, No. 1,004).

Perithecia gregarious, superficial, minute, about 300 μ high and 200 μ broad, ovate-conical, sessile on the flattened base, coarsely tubercular-roughened, black. Ostiolum obtuse, perforated and often 4-sulcate-cleft. Asci clavate-cylindrical, short-stipitate, 110 x 20 μ , paraphysate, 8-spored. Sporidia irregularly biseriate, oblong-elliptical, multiseptate and muriform, hyaline at first, tardily becoming brown, slightly constricted in the middle, 19–22 x 11–13 μ , ends obtuse.

Distinguished from the other species by the ovate-conical, tubercular-roughened perithecia.

Teichospora amygdaloides E. & E.

On bark of *Salix amygdaloides*, Rockport, Ks., July, 1894 (Bartholomew, No. 1,507).

Perithecia scattered or sub-gregarious, erumpent-superficial, sub-globose, 250–350 μ diam., soon flattened above and at length more or less collapsed. Ostiolum papilliform. Asci subventricose, subsessile, paraphysate, 8-spored, 75–85 x 18–21 μ . Sporidia mostly crowded-biseriate, obovate, about 5-septate and constricted in the middle, with a longitudinal septum running through 2 or more cells, hyaline and uniseptate at first, finally yellow-brown, 20–22 x 10–13 μ .

Differs from *T. obduces* (Pers.) in its scattered growth, sub-collapsing and mostly rather smaller perithecia, and shorter asci with crowded sporidia.

Teichospora clavispora E. & E.

On bark of *Negundo aceroides*, Rockport, Kansas, July, 1894 (Bartholomew, No. 1,509).

Perithecia scattered, erumpent-superficial, ovate-globose, rough, 250–300 μ diam., with a papilliform ostiolum. Asci clavate-cylindrical, 100–120 x 14–15 μ , paraphysate, 8-spored. Sporidia obliquely

uniseriate, clavate or narrow obovate, 8-10-septate and muriform, brown, 30-35 x 10-12 μ , narrowed almost to a point below.

Teichospora rhyodes E. & E.

On decorticated *Rhus*, Ann Arbor, Mich., Apr., 1893 (L. N. Johnson, No. 1,545).

Perithecia gregarious, erumpent-superficial, conic-hemispherical, $\frac{1}{2}$ mm. diam., with a papilliform or conic-papilliform ostiolum. Asci cylindrical, 100-110 x 12 μ , paraphysate, 8-spored. Sporidia uniseriate, oblong-elliptical, yellow-brown, 6-7-septate, with a more or less perfect longitudinal septum running through several of the cells, 15-18 x 7-8 μ , slightly constricted in the middle, ends obtusely pointed. Accompanied by pycnidial perithecia (*Macrophoma rhoïna* E. & E.), smaller and depressed, with fusoid-oblong, hyaline sporules 18-22 x 6-7 μ .

The ascigerous perithecia are more or less covered below with the remains of the decomposing fibers of the wood and have a dirty look.

Teichospora crossota E. & E.

On the weathered inner surface of elm bark, Rockport, Kansas, Apr., 1894 (Bartholomew, No. 1,437).

Perithecia gregarious, erumpent-superficial, ovate-globose, rough, black, 150-200 μ , diam., fringed around the base with short, creeping, brown hyphæ, not collapsing. Ostiolum papilliform. Asci cylindrical or clavate-cylindrical, about 75 x 10-12 μ , abruptly contracted below into a short, crooked stipe, paraphysate, 8-spored. Sporidia sub-biseriate, obovate-elliptical, yellow-brown, 3-septate and more or less constricted in the middle, 12-15 x 8-9 μ , ends obtuse.

Allied to *T. pygmaea* E. & E., but perithecia gregarious and fringed, and sporidia longer and acute below.

Teichospora piriopora E. & E.

On outer bark of living *Fraxinus viridis*, Rockport, Ks., March, 1894 (Bartholomew, No. 1,233).

Perithecia erumpent-superficial, subglobose, $\frac{3}{4}$ mm. diam., with a papilliform ostiolum. Asci cylindrical, 100-110 x 15-18 μ , sub-sessile, paraphysate, 8-spored. Sporidia overlapping-uniseriate, piriform, 6-11-septate and muriform, yellow-brown, 35-45 x 12-15 μ , the terminal cells a little paler.

Teichospora nubilosa E. & E.

On outer bark of *Celtis occidentalis*, Rockport, Kansas, Nov. 1893 (E. Bartholomew, No. 1,249).

Perithecia scattered, superficial, ovate, minute, $250 \times 220\mu$, rough, black, with a papilliform ostiolum, at length collapsing above. Asci clavate-cylindrical, $70-75 \times 10-12\mu$, 8-spored, with filiform paraphyses. Sporidia uniseriate, elliptical or ovate, 3-septate and submuriform, constricted at the middle septum, hyaline at first, but soon becoming brown.

The perithecia are mostly seated on a thin, black crust which over-spreads the surface of the bark, giving it a clouded appearance.

Pleosphæria corticola E. & E.

On outer bark of *Pinus rigida*, Nuttallburg, West Va., June, 1894 (L. W. Nuttall).

Perithecia scattered, superficial, ovate, $300-400\mu$ diam., carbonaceo-membranaceous, pilose-strigose, hairs $100-200 \times 5-6\mu$, soon opaque, very faintly and sparingly septate, here and there collected into closely compacted fascicles resembling stout bristles. Ostiolum papilliform, obtuse. Asci oblong-cylindrical, abruptly short-stipitate, $80-100 \times 20-25\mu$. Paraphysate? Sporidia crowded, acutely elliptical, nearly hyaline at first, becoming olive-brown and 5-7-septate and muriform, but not constricted.

Comes near *P. strigosa* Sacc., but perithecia rather smaller, not depressed, and hairs fasciculate.

Lophiostoma (*Lophiosphæra*)? *asperum* E. & E.

On outer bark of *Ulmus Americana*, Rockport, Kansas, June, 1894 (Bartholomew, No. 1,487).

Perithecia scattered, superficial, ovate, tubercular-roughened, except around the prominent, narrow, compressed ostiolum, $400-450\mu$ high, $300-350\mu$ broad, slightly narrowed around the base. Asci clavate-cylindrical, short-stipitate, $90-100 \times 12\mu$, paraphysate, 8-spored. Sporidia uniseriate, mostly overlapping or oblique, yellowish-hyaline, uniseptate and constricted, $18-21 \times 7-8\mu$, ends subacute, or when free obtuse and rounded.

Lophiostoma speciosum E. & E.

On bark of *Fraxinus viridis*, Rockport, Kansas, March, 1894 (Bartholomew, 1,406).

Perithecia scattered, erumpent-superficial, globose, grayish-black,

$\frac{3}{4}$ mm. diam., with a narrow, compressed, deciduous ostiolum. Asci clavate-cylindrical, 150–200 x 22–25 μ , p. sp. 112–130 μ long, paraphysate, 8-spored. Sporidia biseriata, oblong-elliptical, with the ends subacute, olive-brown. 10–11-septate, not constricted, 40–55 x 13–16 μ .

Lophidium pachystomum E. & E.

On outer bark of *Populus monilifera*, Kansas (Bartholomew).

Perithecia gregarious, erumpent-superficial, depressed-globose, $\frac{3}{4}$ –1 mm. diam., base slightly sunk in the bark, rounded above at first and without any visible ostiolum, but finally with a stout, short-cylindrical, obtuse, scarcely compressed ostiolum $\frac{1}{4}$ – $\frac{1}{2}$ mm. long. Sometimes two or three perithecia are confluent. Asci clavate-cylindrical, 110–120 x 18–22 μ (p. sp. 100–110 μ), paraphysate, 8-spored. Sporidia biseriata, clavate-oblong or obovate-clavate, 27–50 x 12–15 μ , 6–12-septate and muriform, becoming dark-brown, sometimes shriveled and deformed.

Distinguished by its turret-like ostiolum.

Lophidium nitidum E. & E.

On dead shoots of cultivated grapevines, Nuttallburg, West Va., Jan. 1894 (L. W. Nuttall, No. 295).

Perithecia scattered, semierumpent, small (200–250 μ diam.), black and shining, subhemispherical, the flattened base immersed in the bark. Ostiolum compressed, thin, narrow, sometimes obsolete. Asci cylindrical, short-(8–10 μ) stipitate, about 100 x 10–12 μ , paraphysate, 8-spored. Sporidia uniseriate, oblong-elliptical, yellow-brown, 5–7-septate with a longitudinal septum running through two or more cells, 19–22 x 8–10 μ , ends mostly rounded and obtuse, not at all or only slightly constricted in the middle.

Lophidium purpurascens E. & E.

On old paper lying by the roadside, Ann Arbor, Mich., March, 1894 (L. N. Johnson, No. 1,564, partly).

Perithecia gregarious, on purplish spots, ovate, 400–450 μ diam., the apex emergent and crowned with the obtuse, compressed ostiolum. Asci clavate-cylindrical, 100–150 x 15–20 μ , p. sp. 80–100 μ long, paraphysate, 8-spored. Sporidia biseriata above, oblong or fusoid-oblong, attenuated towards each end, 7–10-septate, slightly curved, not at all or only slightly constricted, 2 or more of the cells divided by a longitudinal septum, olive-brown, 22–25 x 8–10 μ .

Often in some of the asci the sporidia appear shriveled and are nearly opaque.

Lophidium confertum E. & E.

On decorticated, decaying limbs of *Fraxinus viridis*, Trego Co., Kansas, Apr. 1894 (Bartholomew, No. 1,457).

Perithecia crowded, superficial, with the base broadly adnate, conical, somewhat shining above, 300–400 μ diam. Ostiolum obtusely conical, mostly more or less compressed, with the opening elongated subhysteriform. Asci clavate-cylindrical, 100–110 x 12–15 μ , with a short, crooked stipe and abundant paraphyses. Sporidia uniseriate, short-elliptical, pale yellow-brown, 3-septate, obtuse, more or less constricted at the middle septum, coarsely muriform, 12–15 x 10–12 μ . Sometimes the sporidia are smaller and darker with a shriveled look. On account of the slightly compressed ostiola this approaches *Teichospora*.

Cucurbitaria borealis E. & E.

On bark of dead limbs of *Salix* sp., Alcove, N. York (C. L. Shear, No. 216).

Perithecia cespitose, 6–12 together in compact groups, 2–3 mm. diam., seated on the surface of the inner bark and loosely surrounded by the ruptured and upturned epidermis, $\frac{1}{3}$ – $\frac{1}{2}$ mm. diam., black, rough, subglobose, with a prominent ostiolum soon perforated. Asci cylindrical, short-stipitate, paraphysate, 8-spored, 90–110 x 15–16 μ . Sporidia uniseriate or subbiseriate above, elongated ovate-elliptical, about 7-septate and muriform, somewhat constricted in the middle, yellow-brown, obtuse, 20–27 x 12–14 μ .

Differs from *C. salicina* Fekl. in its cespitose perithecia and larger, 7-septate sporidia.

Sphærella hypsicola E. & E.

Perithecia scattered or subgregarious, ovate-globose, 80–90 μ diam., subcuticular or superficial by the falling away of the epidermis, pierced above with a small round opening. Asci oblong, sessile, fasciculate, 25–35 x 7–8 μ , 8-spored. Sporidia crowded-biseriate, oblong or clavate-oblong, scarcely constricted, hyaline, 9–11 x 2 $\frac{1}{2}$ –3 μ .

On dead stems of *Trollius laxus*, Cameron Pass, N. W. Colo., July, 1894, alt. 10,200 ft. (Prof. C. S. Crandall, No. 4).

Sphærella coerulea E. & E.

On dead stems of *Aquilegia coerulea*, Junction of Big South and

Cache la Poudre Rivers, Colo., July, 1894 (Prof. C. S. Crandall, No. 11), alt. 9,000 ft.

Perithecia evenly scattered, subcuticular but prominent, depressed-hemispherical, 100–120 μ diam., pierced above. Asci fasciculate, aparaphysate, oblong, mostly broader near the base, sessile, 8-spored. Sporidia 2–3-seriate, crowded, clavate-oblong, obtuse, uniseptate and slightly constricted at the septum, 15–20 x 3½–4½ μ .

Differs from *S. Aquilegiae* E. & G. in its depressed perithecia and narrower sporidia.

Didymella Myricæ E. & E.

On dead twigs of *Myrica cerifera*, Kiamensie, Del., July, 1894 (Commons, No. 2,503).

Perithecia scattered, adnate-superficial, depressed-hemispherical, 100–120 μ diam., with a papilliform ostiolum. Asci obovate, subinequilateral, sessile, aparaphysate, 40 x 20 μ . Sporidia biseriata, oblong, hyaline, uniseptate and strongly constricted at the septum, ends obtuse, each cell 2-nucleate, 20 x 6–8 μ . The cells easily separate.

Didymella Physocarpi E. & E.

On dead limbs of *Physocarpus opulifolius*, Nuttallburg, West Va., May, 1894 (L. W. Nuttall, No. 488).

Perithecia gregarious, covered by the pustuliform epidermis, about ¼ mm. diam., white inside, depressed-globose, the papilliform ostiolum barely penetrating the epidermis. Asci clavate-cylindrical, short-stipitate, 85–90 x 10–12 μ , paraphysate, 8-spored. Sporidia biseriata, fusoid, 4-nucleate, uniseptate, constricted at the septum, hyaline, 19–22 x 4–5 μ , mostly a little curved.

Didymosphæria populifolia E. & E.

On fallen leaves of *Populus angulata*, Shore of Lake Huron, Ontario, Canada, May, 1894 (Dearness, No. 2,263).

Perithecia gregarious, in suborbicular, hypophyllous groups, about 1 cm. across, not on any definite spots, 80–100 μ diam., innate, only the subconoid, minute ostiolum projecting. Asci cylindrical, short-stipitate, 65–75 x 8–10 μ , 8-spored (paraphysate)? Sporidia uniseriate, oblong, pale brown, uniseptate, slightly constricted, upper cell a little broader, 12–14 x 3½–4½ μ .

Pleospora Richtiphensis E. & E.

Perithecia thickly scattered, subcuticular, globose or elliptical,

300–400 μ diam., finally more or less collapsing, the papilliform ostiolum barely piercing the epidermis. Asci clavate-oblong, short-stipitate, paraphysate, 8-spored, 85–110 x 20–22 μ . Sporidia biseriate, oblong-elliptical, 5-septate and muriform, mostly constricted in the middle, yellow-brown, end cells paler and subacute, 25–35 x 12–14 μ .

On dead stems of *Helianthus*, Mt. Richtophen, N. W. Colo., July, 1894 (C. F. Baker, No. 238).

Pleospora alpestris E. & E.

On decaying stems of *Trollius latus*, Cameron Pass, N. W. Colo., July, 1894 (Prof. C. S. Crandall, No. 4, partly).

Perithecia scattered, innate-erumpent, ovate-globose, 250 μ diam., with a papilliform ostiolum. Asci thin, evanescent, 150 x 25–30, 2-spored (in the specc. examined). Sporidia oblong-elliptical, or ovate-oblong, 50–65 x 16–24 μ , mostly a little constricted in the middle, multi-(9–12-) septate and muriform, deep yellow-brown.

The perithecia have a scanty fringe of coarse, brown, mycelial threads around the base.

This differs from *Pl. polyphragmia* Sacc. in its smaller glabrous perithecia not collapsing, and its larger sporidia with fewer septa.

Pyrenophora Canadensis E. & E.

On sheaths of *Phleum pratense*, London, Canada, July, 1894 (J. Dearness).

Perithecia scattered, buried with the apex erumpent, ovate, 250–300 μ diam., the apex around the scarcely prominent ostiolum loosely clothed with spreading, brown, continuous hairs 50–80 x 5–6 μ . Asci cylindrical, 150–190 x 28–32 μ (p. sp. 110–120 μ). Paraphyses not seen. Sporidia 4–8, oblong-elliptical or ovate-elliptical, nearly hyaline, obtuse, 3-septate, scarcely constricted, when mature one or two of the cells divided by a longitudinal septum, 40–55 x 15–20 μ .

Leptosphaeria sambucina E. & E.

On dead *Sambucus melanocarpa*, Cameron Pass, Colo., alt. 10,000 ft., July, 1894 (C. F. Baker).

Perithecia buried, ovate-globose, 350–400 μ diam., raising the epidermis into pustules which are whitish at first with the minute, black, papilliform ostiolum visible in the center. Asci clavate-cylindrical, 100–120 x 12 μ , paraphysate, 8-spored. Sporidia fusoid-cylindrical, slightly curved, uniseptate and constricted at first, finally

6-septate and constricted at the septa, generally with one cell near the middle, swollen, 22-27 x 6-7 μ , golden-yellow.

Differs from *L. agnita* Desm. in its broader, golden-yellow sporidia. *L. Sambuci* in Roum. F. Gall. 5960, has 3-septate sporidia.

Leptosphaeria papyricola E. & E.

On old pasteboard lying by the roadside, Newfield, N. J., Aug. 1894.

Perithecia gregarious, buried, with the acutely conical ostiolum erumpent, 110-130 μ diam., ovate-globose. Asci (p. sp.) 60-70 x 5 μ , with a slender stipe 30-40 μ long, paraphyses obscure. Sporidia biseriate, fusoid, dull yellow, slightly curved, 3-septate, often constricted at the middle septum with the next cell above swollen, 14-20 (mostly about 15) x 2 $\frac{1}{2}$ -3 μ .

Differs from any form of *L. eustoma* (Fr.) in its conical ostiolum and constantly narrower sporidia.

An *Ophiobolus* with asci 110-120 x 5 μ , sporidia filiform 80-110 x 1 $\frac{1}{2}$ μ , also occurs on the same matrix.

Ophiobolus fragilisporus E. & E.

Perithecia scattered, erumpent-superficial, ovate-conical, brownish-black, 350-450 μ high, 300-350 μ thick, narrowed above into the prominent-papilliform or short-cylindrical, black ostiolum. Asci linear, gradually narrowed below, 150-200 x 5-5 $\frac{1}{2}$ μ . Paraphyses filiform, evanescent. Sporidia nearly as long as the asci, yellowish-brown, 1-1 $\frac{1}{2}$ μ thick, readily separating into joints 8-12 μ long.

Allied to *O. rudis* (Riess.), but sporidia only half as thick and perithecia ovate-conical.

On dead herbaceous stems, on overflowed land, Walton Creek, Colorado, July, 1894, alt. 6,500 ft. (Prof. C. S. Crandall, No. 40).

Linospora Brunellæ E. & E.

On living leaves of *Brunella vulgaris*, Columbia River, W. Klikitat Co., Wash., Apr. 1886 (W. N. Suksdorf, No. 267).

Perithecia thickly scattered, amphigenous, buried in the substance of the leaf, but raising the epidermis into little black tubercles about $\frac{1}{2}$ mm. diam., and pierced above by the papilliform or short-cylindrical ostiolum. Asci clavate-cylindrical, 80-90 x 12-15 μ , 8-spored, (paraphysate)? Sporidia fasciculate, lying parallel, clavate-cylindrical, yellowish-hyaline, 3-septate, not constricted, 55-65 x 3 μ .

Hypospila Brunellæ E. & E.

On leaves of *Brunella vulgaris*, Seattle, Wash., Sept. 1892 (C. V. Piper).

Perithecia buried in the substance of the leaf, $\frac{1}{2}$ mm. diam., the base hemispherical-prominent below, the conic-papilliform ostiolum erumpent through the slightly tubercular-elevated epidermis above. Asci clavate-cylindrical, 90–110 x 12 μ , 8-spored, with filiform paraphyses. Sporidia cylindrical, crowded, nearly straight, faintly 1–3-septate, obtuse, 55–62 x 3 $\frac{1}{2}$ –4 μ .

Anthostomella hypsophila E. & E.

Perithecia gregarious, buried in the bark, globose, black, $\frac{1}{3}$ – $\frac{1}{2}$ mm. diam., raising the surface of the bark into distinct pustules which are barely pierced by the papilliform ostiolum. Asci cylindrical, 90–110 x 12 μ , paraphysate, 8-spored, stipitate. Sporidia uniseriate, narrow-elliptical, deep brown and finally opaque, 15–18 x 8–10 μ .

On dead stems of *Lonicera involucrata*, Cameron Pass, N. W. Colo., alt. 10,000 ft. (C. F. Baker).

Anthostomella suberumpens E. & E.

On inner surface of loosened elm bark, Rockport, Kansas, Nov. 1893 (Bartholomew, No. 1,244).

Perithecia gregarious, sunk in the bark, with the stout, conical ostiolum and often the apex of the perithecium erumpent, 250–320 μ diam., with tolerably thick walls. Asci cylindrical, short-stipitate, 90–110 x 7–8 μ , 8-spored, with filiform paraphyses. Sporidia uniseriate, elliptical, brown, becoming nearly opaque, 12 x 6–8 μ .

Distinguished from other species by its stout, conical ostiolum and suberumpent perithecia, approaching *Rosellinia*.

Diaporthe (Chorost.) stereostoma E. & E.

On dead branches of *Symphoricarpos occidentalis*, Rockport, Kansas, June, 1894 (Bartholomew, No. 1,482).

Stromata scattered or subconfluent, enclosed in a thin, black, sub-carbonaceous crust, conical or subpulvinate, 1–3 mm. diam., seated on the wood and covered by the thin bark which is raised into pustules and pierced by the fascicle of stout, black, conic-cylindrical ostiola which are $\frac{1}{2}$ –1 mm. long. Perithecia 3–12 in a stroma, sub-globose, about $\frac{1}{3}$ mm. diam., slightly sunk in the surface of the wood which is marked by a cluster of shallow cup-shaped cavities

when the perithecia are removed. Asci (p. sp.) 45-50 x 7-8 μ , clavate-cylindrical, paraphysate, 8-spored. Sporidia biseriata, oblong, 3-4-nucleate, slightly constricted in the middle, obtuse, hyaline, 10-12 x 3 $\frac{1}{2}$ -4 μ .

Very distinct from *D. Ryckholtii*, which is also found on *Symphoricarpos*.

Diaporthe (Chorostate) *tetraptera* E. & E.

On dead limbs of *Halesia tetraptera*, Nuttallburg, West Va., May, 1894 (L. W. Nuttall).

Stroma cortical, 1 $\frac{1}{2}$ -2 mm. diam., surrounded by a black line which does not penetrate the wood. Perithecia 4-12, circinate, $\frac{1}{2}$ mm. diam., sunk to the wood and leaving their impress on its surface but not penetrating it. Ostiola obtusely rounded and perforated, erumpent in a compact fascicle and closely surrounded by the ruptured epidermis. Asci clavate-cylindrical, 75-80 x 12 μ . Sporidia biseriata, oblong-fusoid, slightly curved, subobtuse, hyaline, uniseptate and constricted at the septum, each cell with a large nucleus, 19-22 x 5-7 μ .

Differs from *D. Halesiæ* E. & E. in its smaller perithecia, not sunk in the wood and its much larger sporidia.

Diaporthe (Chorostate) *Halesiæ* E. & E.

On dead limbs of *Halesia tetraptera*, Nuttallburg, West Va., May, 1894 (L. W. Nuttall).

Perithecia 4-8, loosely circinate, $\frac{3}{4}$ mm. horn-color inside, becoming nearly black, sunk in the wood, necks converging with their obtuse, smooth, hemispherical ostiola erumpent in a close fascicle, closely surrounded by the ruptured epidermis. Asci slender, 55-60 x 6-7 μ , short-stipitate. Sporidia subbiseriata, fusoid-oblong, hyaline, 2-4-nucleate, becoming uniseptate and slightly constricted, straight, 12-15 x 2 $\frac{1}{2}$ -3 μ .

There is no distinct circumscribing line around the stroma, but the inner surface of the bark is uniformly blackened.

Diaporthe *Araliæ* E. & E.

On dead limbs of *Aralia spinosa*, Nuttallburg, West Va., Feb. 1894 (L. W. Nuttall, No. 312).

Stroma buried in the wood and circumscribed by a penetrating, black line, elliptical, about 5 x 4 mm. Perithecia buried in the stroma, few (6-10) globose, $\frac{1}{2}$ - $\frac{3}{4}$ mm. diam., their short-cylindrical,

ostiola projecting from a black, tubercular disk seated on the surface of the wood and perforating the pustuliform-elevated epidermis, but scarcely rising above it. Asci clavate-cylindrical, 40–45 x 5–6 μ , paraphysate, 8-spored. Sporidia biseriata, oblong, 4-nucleate, becoming uniseptate and slightly constricted, hyaline, obtuse, 12–13 x 2½–3 μ .

Allied to and resembling *D. ocularia* C. & E.

Valsa ribicola E. & E.

On dead *Ribes aureum*, Rockport, Kansas, Aug. 1894 (E. Bartholomew, No. 1,530).

Perithecia circinate, 10–12 buried in the unchanged substance of the inner bark, not penetrating to the wood or circumscribed by any black line, 230–250 μ diam., ovate-globose, with slender necks converging, with their rounded, black, finally subumbilicate ostiola erumpent around the margin of a dirty white disk. Asci clavate-cylindrical, about 60 x 8 μ . Sporidia biseriata above, allantoid, hyaline, obtuse, moderately curved, 12–15 x 3–4 μ . The white disk is only the top of a grayish-white central column around the base of which lie the perithecia, in a circle 1½–2 mm. diam.

This cannot easily be mistaken for *V. ribesia* Karst., which has sporidia only about half as large and differs also in other respects.

Valsa Chionanthi E. & E.

On dead limbs of *Chionanthus Virginica*, Nuttallburg, West Va., March, 1894 (L. W. Nuttall, No. 228).

Perithecia 4–10, globose, ¼–½ mm. diam., buried in the unchanged substance of the bark, with convergent necks, terminating in short-cylindrical, obtuse, perforated ostiola erumpent in a close fascicle perforating and slightly raising the bark. Asci clavate, p. sp. 40–45 x 8–10 μ , 8-spored, paraphysate? Sporidia allantoid, hyaline, 12–15 x 3½–4½ μ , biseriata above.

Spermogonia (*Cytispora Chionanthi* E. & E.) buried in the bark, flask-shaped, ½–¾ μ diam., multilocular, the cells soon confluent, the apex erumpent and perforated by a single pore. Sporules allantoid, 4–6 x 1–1¼ μ , borne on basidia branched above, the branches erect, straight, nucleate, 7–10 μ long.

Valsa Diospyri E. & E.

On dead limbs of *Diospyros Virginiana*, Nuttallburg, West Va., Dec. 1894 (L. W. Nuttall, No. 253).

Stroma consisting of the slightly blackened substance of the bark, convex, about 2 mm. diam., not circumscribed. Perithecia 4-10 in a stroma, subglobose, $\frac{1}{4}$ - $\frac{1}{3}$ mm. diam., necks converging and united above in a small, black disk which perforates the pustuliform-elevated epidermis, but does not rise above it. Ostiola short, conic-cylindrical, with a smooth, round opening, crowded and finally obliterating the disk. Asci clavate-lanceolate, p. sp. $25 \times 5\mu$, 8-spored, paraphysate. Sporidia allantoid, hyaline, $8-10 \times 1\frac{1}{2}-2\mu$. Spermogonia (*Cytispora*) in the young stroma, multilocular gray inside, opening by a single, central pore. Spermatia allantoid, hyaline, moderately curved, $4-5 \times 1\frac{1}{4}\mu$.

Valsa etherialis E. & E.

On dead limbs of *Acer rubrum*, Nuttallburg, West Va., Feb. 1894 (L. W. Nuttall, No. 373).

Stromata cortical, thickly scattered, convex, $1-1\frac{1}{2}$ mm. diam. Perithecia 6-12 together, circinate, buried in the unaltered substance of the bark, small, $150-250\mu$ diam., their short necks terminating in an erumpent, compact fascicle of obtuse, black, slightly unilobate ostiola closely embraced by the epidermis and scarcely rising above it. Asci (p. sp.) fusoid, $15-22 \times 4-4\frac{1}{2}\mu$, stipitate, 8-spored. Sporidia biseriate, allantoid, hyaline, curved, slender, $5-6 \times$ about 1μ . When well developed, the epidermis is raised into subdiscoid pustules in which the slight protuberances indicate the position of the subjacent perithecia.

V. delicatula C. & E. has fewer, larger perithecia and broader sporidia. *V. microspora* Cke. & Plowr. has also larger perithecia and yellowish sporidia, and the ostiola are more or less distinctly sulcate, indicating its close relationship to *Eutypella*. In *V. etherialis* the sporidia both in and out of the asci are perfectly hyaline.

Eutypella densissima E. & E.

On dead limbs of *Aralia spinosa*, Nuttallburg, W. Va., Feb. 1894 (L. W. Nuttall, No. 363).

Stromata scattered, cortical, depressed-conical, 2-3 mm. diam., not circumscribed, but staining the bark olive-gray. Perithecia numerous, often 50-70 in a stroma, $100-120\mu$ diam., closely packed, their slender necks terminating in obtusely conical, 4-cleft, black, densely crowded ostiola erumpent in a brown disk surrounded by the ruptured epidermis. The disk is soon obliterated, so that only the crowded, black, subshining ostiola are seen. Asci clavate-fusoid, p.

sp. 25–30 x 4 μ . Sporidia biseriata, allantoid, hyaline, moderately curved, 8–10 x 1 $\frac{1}{2}$ –2 μ .

Eutypella carpinicola E. & E.

On dead limbs of *Carpinus Americana*, Alcove, N. Y., Oct. 1893 (C. L. Shear, No. 190).

Stromata cortical, flat, subconfluent, 1 $\frac{1}{2}$ –2 mm. diam., formed from the scarcely altered, superficial layer of the inner bark, below which the substance of the bark and surface of the wood is uniformly blackened. Perithecia subcircinate, 3–6 together, $\frac{1}{2}$ – $\frac{3}{4}$ mm. diam., with thick, coriaceous walls, their short necks erumpent in a small, flattened, tubercular, black disk, which pierces the papilliform-elevated epidermis, and appears like a small black speck on its surface. Ostiola erumpent through the disk, broad, flat, soon stellately cleft. Asci slender-clavate, p. sp. 40–50 x 5 μ , or including the slender stipe, 80–100 μ long, paraphysate, 8-spored. Sporidia biseriata, allantoid, yellowish, slightly curved, obtuse, 8–10 x 2 μ .

The perithecia lie in the superficial layer of the inner bark, and when the epidermis is pulled off, this layer and the imbedded perithecia adhere to and come off with it. The perithecia are then seen to be surrounded by a thin white layer apparently formed from the substance of the bark.

Calosphæria cornicola E. & E.

On dead limbs of *Cornus asperifolia*, Rockport, Kansas, May, 1894 (Bartholomew, No. 1,470).

Perithecia scattered or loosely collected in subvalsiform groups of 3–5, minute, 200–250 μ diam., buried in the unchanged substance of the inner bark, covered by the epidermis which is raised into little pustules and pierced by the papilliform ostiola. Asci clavate, 27–32 x 6–6 $\frac{1}{2}$ μ , rounded above and gradually narrowed to the base. Paraphyses linear, nucleate, much longer than the asci. Sporidia biseriata, cylindrical, hyaline, curved, obtuse, 10–12 x 2 μ .

Differs from *C. minima* Tul. (also on *Cornus*) in its sporidia twice as long and rather broader. The scattered mode of growth is like that of *C. microtheca* C. & E.

Endoxyla acericola E. & E.

On rotten maple wood, Granton, Ontario, Canada, Jan. 1894 (Dearnass, No. 2,235).

Perithecia scattered or subvalsiform-aggregated, globose, black,

300–350 μ diam., entirely buried in the unchanged substance of the wood, their short-cylindrical or conic-cylindrical ostiola exerted either singly or in loose fascicles. Asci cylindrical, 130–140 x 12 μ (p. sp. 90–110 μ), paraphysate, 8-spored. Sporidia uniseriate, oblong-cylindrical, 3-septate and constricted at the septa, obtuse, not curved, brown, apparently roughish, 18–22 x 8–10 μ .

Pseudovalsa viticola E. & E.

On dead shoots of *Vitis riparia*, Rockport, Kansas, April, 1894 (Bartholomew, No. 1,454).

Perithecia buried in the unchanged substance of the inner bark, either singly or 2–4 together, globose, soft, $\frac{1}{2}$ – $\frac{3}{4}$ mm. diam., raising the epidermis into distinct pustules, which are pierced by the papilliform or tubercular-papilliform ostiolum. Asci cylindrical, short-stipitate. 8-spored, paraphysate, 100–120 x 10–12 μ . Sporidia uniseriate, oblong-cylindrical, straight or very slightly curved, obtuse, 3-septate and slightly constricted, 15–20 x 8–9 μ , light yellow-brown.

Valsaria allantospora E. & E.

On dead *Negundo aceroides*, Rockport, Kansas, April, 1894 (Bartholomew, No. 1,450).

Stroma cortical, elliptical (in a horizontal section), 4–7 x 3 mm., or subserrate-elongated for 1–2 cm., formed from the substance of the bark which becomes of a lighter color than the surrounding parts, and is limited by a black line which penetrates the wood to the depth of about 1 mm. Perithecia 6–12 in a stroma, globose, black, thick walled, not sunk in the wood, $\frac{3}{4}$ –1 mm. diam. Ostiola erumpent, slightly projecting, conical, black, not sulcate, not crowded, connected by a thin, black crust. Asci clavate, short-stipitate, p. sp. 55–62 x 8–10 μ (paraphysate)? Sporidia biseriate, cylindrical, slightly curved, yellowish and 2-nucleate at first, becoming brown and uniseptate, but not constricted, 12–15 x 3–3 $\frac{1}{2}$ μ .

Diatrype celastrina E. & E.

On dead stems of *Celastrus scandens*, Rockport, Kansas, May, 1894 (Bartholomew, No. 1,472).

Stromata scattered, cortical, light wood-color within, depressed-conical, 2–3 mm. diam., raising the epidermis into distinct pustules, ruptured above with a small, elliptical opening by the dark-gray disk. Perithecia 4–12 in a stroma, subcircinate, ovate, about $\frac{1}{2}$ x $\frac{3}{4}$ mm. diam. Ostiola scattered or erumpent around the margin of the disk,

flat, with an irregularly shaped opening. Asci clavate-cylindrical, 60–70 x 7–8 μ (p. sp. 30–35 μ long), paraphysate, 8-spored. Sporidia biseriate, cylindrical, smoky yellow-brown, slightly curved, obtuse, 10–12 x 2–3 μ . Stroma circumscribed by a black line, which does not penetrate the wood. This can hardly be the *Sphaeria dolosa* Fr., said by Schw. to occur on *Celastrus*. It is certainly different from the spec. so labeled in Sydow's *Mycotheca Marchica*.

Anthostoma formosum E. & E.

On bark of dead *Celtis occidentalis*, Rockport, Kansas, June, 1894 (Bartholomew, No. 1,492).

Stromata scattered, cortical, thick-convex, 2–4 mm. diam., orbicular or elliptical, formed from the scarcely altered substance of the bark. Perithecia 12–20 buried in the stroma but not penetrating to the wood, ovate-globose, with thick, cartilagino-membranaceous walls, black and shining inside, about 1 mm. diam., their slender necks converging, their stout, conic-cylindrical ostiola with smooth rounded tips, erumpent in a close fascicle and projecting, when fully developed for 1 mm. or more, or quite as often, merely raising and rupturing the epidermis, but scarcely rising above it. Asci cylindrical, stipitate, paraphysate, p. sp. 60–70 x 4–5 μ . Sporidia uniseriate, oblong, dark brown (subhyaline and nucleate at first), straight, obtuse, 7–10 x 3–4 μ .

Anthostoma micrœcium E. & E.

On dead limbs of *Asimina triloba*, Nuttallburg, West Va., Feb. 1894 (L. W. Nuttall).

Stroma cortical, faintly circumscribed, 1–1½ mm. diam., orbicular, convex. Perithecia 4–8 in a stroma, globose, minute (200–250 μ), circinate, necks slender, short, converging, with the minute, papilliform ostiola erumpent in a small, black, hemispherical disk, which barely pierces the pustuliform-elevated epidermis, and is closely embraced by it. Asci cylindrical, 80–110 x 8–10 μ , paraphysate 8-spored. Sporidia uniseriate, elliptical, brown, continuous, 2-nucleate, 12–14 x 6–7 μ .

Distinguished by its very small stroma and perithecia.

Diatrypella prunicola E & E.

On dead limbs of *Prunus Pennsylvanica*, Alcove, N. Y., Feb. 1894 (C. L. Shear, No. 298, partly).

Stroma seated on the inner bark, convex-hemispherical, 3–4 mm.

diam., tobacco-color inside, not circumscribed, crowded above with the dense, flat-topped orbicular or elliptical fascicle of hemispherical, smooth, soon broadly and irregularly perforated ostiola, which raise and pierce the epidermis with an orbicular opening or oftener protrude through transverse cracks. Perithecia irregularly polystichous, small (110–150 μ), black and shining inside, numerous, subglobose. Asci clavate-cylindrical, short-stipitate, 65–70 x 8–10 μ , polysporous, paraphysate. Sporidia irregular crowded, yellowish in the mass, allantoid, 5–6 x 1 μ .

Phyllachora asterigena E & E.

On living leaves of *Aster oblongifolius*, Rockport, Kansas, Aug. 1893 (Bartholomew, No. 1,040). (Stylospores.)

Forming orbicular or elongated, black patches, 2–6 mm. in extent, on the under side of the leaves. Stroma thin, gray inside, surface roughened by the prominent, conic-hemispherical, perforated ostiola. Ascigerous cells numerous, subglobose, about 100 μ diam. Sporules oblong or cylindrical, hyaline, uniseptate, slightly constricted at the septum, obtuse, 15–25 x 4–4½ μ .

This does not seem to be *Dothidea Haydeni*, B. & C., which is represented as growing on the stems and having "sporidia linear, attenuated at each end."

Dothidea Solidaginis Schw. has a different habit, stromata numerous, scattered, tuberculiform and mostly less than 1 mm. diam.

Hypoxyton occidentale E. & E.

On dead limbs and trunks. Pasadena, Cal. (Prof. A. J. McClatchie).

Stroma hemispheric-tuberculiform, superficial, sessile, 2–10 cm. diam., surface roughened by the large, hemispherical ostiola, and clothed with a thin coat of short, olivaceous hyphae, bearing globose, ovate, or oblong-cylindrical conidia, nearly hyaline and continuous at first, finally pale brown and 1–3 septate, 4–15 x 4–5 μ . Perithecia peripheral, 1–1½ x ½–1 mm. Asci cylindrical, 120–150 (μ . sp. about 100) x 6–7 μ , paraphysate, 8-spored. Sporidia uniseriate, oblong-elliptical, subinequilateral, olive-brown, 14–16 x 6–7 μ .

Has the aspect of *Daldinia concentrica*, but not zonate within, the inner substance consisting of a compact mass of radiating, sooty black fibers with a silky luster. The species is allied to *H. malleolus* B. & R., from which it is distinguished by its more prominent ostiola

not surrounded by any distinct annular depression, and by its broader sporidia and the presence of a conidial layer.

Hypoxyylon Nuttallii E. & E.

On bark of dead *Magnolia Fraseri*, Nuttallburg, West Va., May, 1894 (L. W. Nuttall, No. 477).

Stromata gregarious, subconfluent, depressed-hemispherical or strongly convex, 3-6 mm. diam., purplish-black, mammillose. Perithecia small (about $\frac{1}{2}$ mm.), scattered irregularly through the stroma, which is rather soft and brownish within. Ostiola crowning the mammillose projections on the surface of the stroma, papilliform, soon deciduous, leaving a round perforation. The asci in the specc. examined had disappeared. Sporidia brown, oblong-elliptical, subinequilateral, $7-8 \times 3-4\mu$ (exceptionally $9 \times 5\mu$).

Hypoxyylon atroviride E. & E.

On bark of dead tree (*Betula* or *Quercus*), Nuttallburg, West Va., Dec. 1893 (L. W. Nuttall, No. 275).

Stroma pulvinate, $1-1\frac{1}{2}$ cm. across, and about 4 mm. thick, orbicular, covered above with a thin ($\frac{1}{2}$ mm.) carbonaceous crust, which is soon covered by a dark green layer of the ejected spores, laterally and internally dirty umber color. Perithecia (which constitute the entire inner substance of the stroma) ovate compressed, and including the long, stout neck, about 3 mm. long and 1 mm. broad below. Ostiola papilliform, soon covered and obscured by the ejected sporidia. Asci cylindrical $100 \times 3\frac{1}{2}-4\mu$ (p. sp. 40-45 long), paraphysate, 8-spored. Sporidia uniseriate, oblong-elliptical, pale brown, under the microscope 2-nucleate, $4\frac{1}{2}-5\frac{1}{2} \times 2\mu$.

This is a well-marked species. The substance of the stroma, except the superficial, carbonaceous layer, is friable, and in this respect as well as the color resembles *H. Petersii* B. & C., from which, however, in other respects it is very distinct.

Hysterium cedrinum E. & E.

On weather-beaten wood of a white cedar post, Rockport, Ks., March, 1894 (Bartholomew, No. 1,422).

Scattered, erumpent, narrow-elliptical, minute ($\frac{1}{4}-\frac{1}{2}$ mm.), black, subrugulose, not polished, lips thin, loosely closed, when fresh open exposing the dark-colored disk. Asci oblong, obtuse above, abruptly contracted below into a short stipe, $45-55 \times 16-17\mu$, paraphysate, 8-spored. Sporidia biseriata, ovate-elliptical, 3-septate, scarcely

or only very slightly constricted, obtuse at the ends, subinequilateral, $18-21 \times 7-8\mu$, the cells uniformly brown, and each with a large nucleus.

Comes near *H. vulgare* De Not. and *H. ellipticum* Fr., but both of these have oblong sporidia, and the former has shining perithecia, besides their different habitat.

Hypoderma tunicatum E. & E.

On dead branches of *Arctostaphylos Nevadensis* Gray, Mt. Paddo, Wash., July, 1886 (W. N. Suksdorf, No. 268).

Perithecia oblong or lanceolate, prominent, $1-3 \times \frac{3}{4}-1$ mm., brownish-black, ends subacute, entirely closed at first, finally opening by an irregularly torn, longitudinal fissure along the top, exposing the pale disk. Asci clavate, $150-200 \times 18-20\mu$, 8-spored, with filiform, branching paraphyses. Sporidia biseriate, hyaline, oblong-elliptical, slightly curved, 3-septate, and including the broad, hyaline envelope, $22 \times 8-10\mu$, the septate body of the spore being about $20 \times 3\frac{1}{2}-4\mu$.

On the tips of the branches was found *Melanomma alpestre* E. & E.

Hypoderma Cassandræ E. & E.

On dead stems and branches of *Cassandra calyculata*, Ann Arbor, Mich., April, 1893 (L. N. Johnson).

Perithecia scattered or gregarious, erumpent, elliptical or oblong, $1-1\frac{1}{2} \times \frac{1}{2}-\frac{3}{4}$ mm., membranaceo-coriaceous, black, bordered by the ruptured and upturned epidermis, lips thin, incurved and closed when dry so as to hide the grayish-black disk, finally deciduous. Asci clavate, narrowed gradually below into a stipe-like base, $45-60 \times 10-12\mu$ above, rounded at the apex, paraphysate. Sporidia biseriate, oblong or oblong-elliptical, hyaline, mostly a little curved, obtuse, continuous, $10-16 \times 4-6\mu$.

Not to be confounded with *Lophodermium (Cenangium) Cassandræ* (Pk.), which has much longer, linear or filiform sporidia.

* * * **DISCOMYCETES.**

Barlæa lacunosa E. & E.

On bark, Notre Dame Bay, Newfoundland, May, 1894 (Rev. A. C. Waghorne).

Sessile $\frac{1}{2}-1\frac{1}{2}$ cm. broad, orange-color, hymenium deeply lacunose, yellowish-white outside and minutely tomentose, margin undulate and narrowly incurved. Asci cylindrical, p. sp. $70-90\mu$, 8-spored.

Paraphyses gradually thickened upwards, hyaline, $3-3\frac{1}{2}\mu$ thick at the apex. Sporidia uniseriate, perfectly globose, hyaline, $8-10\mu$ diam.

Comes near *B. epichrysea* Beck, but asci and sporidia smaller and hymenium lacunose.

Ciboria juncigena E. & E.

On dead stems of *Juncus*, Falcon Valley, Wash., May, 1883 (W. N. Suksdorf, No. 371).

Stipitate, shallow cup-shaped, thin, 4-5 mm. diam., glaucous-pruinose outside, disk wine-colored, subumbilicate. Stipe about 1 cm. long, 1 mm. diam. below, black and longitudinally wrinkled for about $\frac{2}{3}$ the way up, flesh-color above, base flattened and attached to the culm but not penetrating it. Asci clavate-cylindrical, about $60 \times 4-5\mu$, paraphysate, 8-spored. Sporidia subbiseriate, allantoid, slightly curved, hyaline, continuous, $7-8 \times 1\frac{1}{4}\mu$.

Ciboria Johnsoni E. & E.

N. A. F. No. 3,131.

Growing from decaying "thorn apples" (fruits of *Crataegus*), more or less buried in the ground, Ann Arbor, Mich., May, 1893 (L. N. Johnson, No. 626).

Stipe slender, 10-25 mm. long, subundulate, slightly enlarged above into the strongly concave, 3-8 mm. diam., light dirty brown ascoma. Asci cylindrical, short-stipitate, paraphysate, 8-spored. Sporidia uniseriate, mostly overlapping and oblique, sometimes subbiseriate, ovate-elliptical, subacute, hyaline, continuous, $8-10 \times 4-5\mu$.

The disk in drying becomes grayish-white.

Lachnella rhizophila E. & E.

On decaying roots of *Rhus diversiloba*, Columbia River, W. Klikitat Co., Wash., Jan. 1894 (W. N. Suksdorf, No. 306).

Gregarious, sessile, dirty white, cup-shaped and $\frac{1}{2}-1$ mm. diam. when fresh, contracted and closed when dry, at first subglobose and nearly closed, outside clothed and margin fringed with straight, rough, pale brown (under the microscope), sparingly septate hairs $100-150 \times 4\mu$. Asci cylindrical, short-stipitate, 8-spored. Paraphyses filiform, scarcely thickened above, about as long as the asci. Sporidia overlapping-uniseriate, or biseriate, fusoid, hyaline, 2-3-nucleate, $10-12 \times 3\mu$.

The ascomata remain cup-shaped, with the margin erect. Disk pale, without any distinct shade of yellow.

Lachnella Virginica E. & E.

On decaying wood of *Magnolia Fraseri*, Nuttallburg, West Va., Feb. 1894 (L. W. Nuttall, No. 380).

Gregarious, sessile, $\frac{3}{4}$ – $1\frac{1}{5}$ mm. diam. Disk pallid, concave, nearly closed when dry, margin fringed with brown, septate hairs, 100–125 x 3μ , outside clothed with shorter, reddish-brown hairs. Asci about 50 x 5μ , clavate-cylindrical, short-stipitate, paraphysate, 8-spored. Sporidia subbiseriate, oblong, 6–8 x $1\frac{1}{2}$ – $2\frac{1}{2}\mu$.

Pseudohelotium laricinum E. & E.

On decaying needles of *Larix*, in a "Tamarack Swamp," Northfield, Mich., June, 1893 (L. N. Johnson, No. 657).

Ascomata sessile, thin, almost membranaceous, carnose, orange colored, flat-discoid, 3–5 mm. diam., darker outside and minutely pubescent, margin incurved when dry, beset with short, compound, conical processes formed by the prolongation of the cellular structure of the ascoma. Asci cylindrical, about 75–8 μ , with filiform paraphyses, not thickened above, 8-spored. Sporidia uniseriate, oblong-elliptical, obtuse, hyaline, continuous, 8–10 x 4–5 μ (mostly about 4 μ).

In old, partly weathered specc. the color becomes a lighter orange.

Cyathicula alpina E. & E.

On dead stems of *Pedicularis*, and culms of *Elymus condensatus*, N. W. Colo., July, 1894, alt. 9,500 ft.

Minute, about $\frac{3}{4}$ mm. high, stipitate, ascomata, shallow cup-shaped when fresh, closed when dry, about $\frac{1}{2}$ mm. diam., disk and margin pallid, structure fibrous, the extremities of the fibers prolonged and subfasciculate so as to make the margin of the ascoma obscurely dentate. Stipe about $\frac{1}{2}$ mm. high, whitish. Asci clavate-cylindrical, short-stipitate, with filiform paraphyses scarcely thickened at the apex. Sporidia oblong-cylindrical, hyaline, continuous, 8–10 x $1\frac{1}{2}$ –2 μ . The outside of the cups is more or less farinose and becomes quite dark.

This is very near *Helotium nigrescens* Cke., which lacks the dentate margin, and has larger asci and sporidia, besides being much darker.

Mollisia Gaultheriæ E. & E.

On living leaves of *Gaultheria Shallon*, Seattle, Wash., Dec. 1893 (Adella M. Parker, No. 185, in part).

Spots large (1-2 cm.), orbicular, dirty brown, paler and purple margined above, sometimes irregular in shape and occupying the greater part of the leaf. Ascumata amphigenous, but more numerous below, superficial on paler parts of the spots, small ($\frac{1}{2}$ mm. diam.), dark liver-color (nearly black when dry), margin nodulose-dentate or subentire, glabrous, concave. Asci clavate-oblong, 45-55 x 10-12 μ , with a short, nodular stipe and filiform, branched paraphyses. Sporidia biseriata, oblong, hyaline, continuous, 10-12 x 3-3 $\frac{1}{2}$ μ , ends obtuse.

Allied to *M. prinicola* E. & E., but differs in several respects.

Tapesia Coloradensis E. & E.

On bark of *Sambucus melanocarpa*, Cameron Pass, Colorado, July, 1894, alt. 10,000 ft. (C. F. Baker, 236, partly).

Ascumata scattered or subgregarious, sessile, seated on the epidermis or on the surface of the inner bark, 1-2 mm. diam., glabrous, nearly black outside, disk glaucous-white, or livid-white at first, becoming nearly black when dry, margin paler, thin and subundulate. Asci clavate-cylindrical, 45-55 x 8-10 μ , narrowed below into a short, thick stipe, 8-spored, with stout but evanescent paraphyses. Sporidia biseriata, oblong-cylindrical, smoky-hyaline, often slightly curved, continuous, obtuse, 8-11 x 2 $\frac{1}{2}$ -3 $\frac{1}{2}$ μ .

The ascumata are surrounded by a thin, brown subiculum (more or less distinct), composed of slender pale brown, sparingly septate, interwoven hyphæ.

Allied to *T. fusca* (Pers.).

When dry the opposite sides of the ascumata roll together in a hysteroform manner.

Helotiella pygmæa E. & E.

On old cornstalks, Ohio (Morgan, No. 993).

Gregarious, minute, pallid, yellowish outside, sparingly clothed and margin fringed with pale slender hairs. When moist convex-discoid, $\frac{1}{4}$ - $\frac{1}{2}$ mm. diam., pallid; when dry urceolate and yellowish, attached to the matrix by a central point and by light colored hairs. Asci (p. sp.) about 30 x 6 μ (paraphysate?), 8-spored. Sporidia biseriata, fusoid-oblong, hyaline, 4-nucleate, becoming uniseptate, and sometimes slightly constricted, 10-14 x 3-3 $\frac{1}{2}$ μ .

Differs from *H. carnosula* Rehm in its smaller size and absence of any clavate paraphyses.

Helotiella papyricola E. & E.

On old paper lying by the roadside, Ann Arbor, Mich., March, 1893 (L. N. Johnson, No. 1,564, partly). Found also at Newfield, N. J.

Ascomata gregarious, sessile or contracted below into a very short stipe, pale orange, of a soft waxy consistency, discoid when fresh, and 200–300 μ diam., subspherical and nearly closed when dry, outside, sparingly furfuraceous, margin fringed with short, spreading hairs. Asci oblong, very short-stipitate, obscurely paraphysate, 8-spored, 25–30 x 12 μ , or elongated, 50–60 x 8 μ . Sporidia biseriate, cylindric-fusoid, hyaline, slightly curved, subobtuse, 2–4-nucleate, becoming uniseptate, but not constricted, 12–15 x 3 μ .

The paper is stained orange-red around the groups of ascomata.

Helotiella major E. & E.

On rotten wood, Ann Arbor, Mich., June, 1893 (F. E. Langdon, Comm. L. N. Johnson, No. 12).

Ascomata gregarious, often subconfluent, sessile, 1–2 mm. diam., dirty orange inside, dirty white outside and sparingly clothed (the whitish margin more densely so) with short, pale, glandular hairs, expanded when mature and fresh, margin incurved when dry, attached to the matrix by spreading, white filaments, which also form a thin subiculum when the ascomata are crowded. Asci oblong-cylindrical, sessile, paraphysate, 8-spored, 65–70 x 7–8 μ . Sporidia mostly biseriate, oblong-cylindrical, slightly curved, hyaline, uniseptate, not constricted, 12–16 x 2½–3 μ .

H. cornuta (Ell.) is much smaller and has the sporidia apiculate. *H. Nuttallii* E. & E., to which this is closely allied, is also smaller, with the ascomata of fibrous structure, and clothed with longer and much more abundant hairs. Occasionally a spore is 3-septate, but the texture of the ascomata is carnose, not waxy or coriaceous as in *Dermatella*.

Helotiella Nuttallii E. & E.

On rotten wood, Nuttallburg, West Va., March, 1894 (L. W. Nuttall, 397).

Ascomata gregarious, sessile, flat-hemispherical, ½–1 mm. diam., cup-shaped when fresh, contracted and subspherical when dry with only a small round apical opening, orange color throughout, disk watery orange, outside and fringed margin paler. Substance fibrous,

the fibres prolonged above so as to make a marginal fringe of pale yellow, roughish, straight hairs. Asci clavate-cylindrical, sessile, curved $50-60 \times 5-6\mu$. Paraphyses filiform, hardly thickened above, with a series of orange-colored, globose nuclei. Sporidia biseriate, oblong, hyaline, obtuse, uniseptate but not constricted, $8-10 \times 2\frac{1}{2}-3\mu$.

The outside of the ascomata is slightly hairy so that the specc. might be referred to *Solenopeziza*, if that is really worthy of generic distinction.

Dermatella viticola E. & E.

On dead shoots of *Vitis* (cult.), Nuttallburg, West Va., Jan. 1894, (L. W. Nuttall, No. 295, partly).

Sessile, convex-discoid and pale when moist, concave and flesh-color when dry, and then scarcely projecting above the surface of the bark, $\frac{1}{2}-\frac{3}{4}$ mm. diam. Asci clavate-cylindrical, about $70 \times 12\mu$, with filiform paraphyses, 8-spored, subsessile. Sporidia subbiserial, oblong-elliptical, hyaline, 1-3-septate (3-4-nucleate at first), $15-18 \times 6-6\frac{1}{2}\mu$.

Belonium arabicolum E. & E.

On dead stems of *Arabis furcata*, Mt. Paddo, Wash., alt. 6-7,000 ft., July, 1886 (W. N. Suksdorf, No. 347).

Ascomata erumpent-superficial, sessile, orbicular, black, $300-400\mu$ diam., subdiscoid, marginate. Asci clavate, $80-100 \times 9-10\mu$, with filiform paraphyses broadly curved at the tips. Sporidia filiform, nucleate (becoming septate)? $40-60 \times 1\frac{1}{4}\mu$.

Resembles outwardly *Pyrenopeziza atrata* (Pers.).

Tympanis Oxydendri E. & E.

On dead limbs of *Oxydendrum arboreum*, Nuttallburg, West Va., Dec. 1893 (L. W. Nuttall, No. 258).

Cespitose, 3-5 together, erumpent, at length deciduous, black, $\frac{1}{2}-\frac{3}{4}$ mm. diam., contracted below into a short, thick stipe, margin subundulate. Asci cylindrical, $110-130 \times 15-18\mu$, including the short stipe. Paraphyses slender, abundant. Sporidia numerous, minute, oblong, hyaline or yellowish, $2\frac{1}{2}-3 \times 1\mu$.

Allied to *T. fasciculata* Schw., but asci larger and sporidia smaller.

Stictis Vaccinii E. & E.

On dead leaves of *Vaccinium ovatum*, Tracyton, Kitsap Co., Wash., Dec. 1893 (Adella M. Parker, No. 217).

Hypophyllous, gregarious, erumpent, generally on an indefinite,

pale spot which is often visible also on the upper side of the leaf, but often without any spot, orbicular or somewhat irregular in outline $\frac{3}{4}$ -1 mm. diam., with a prominent, light colored, 3-4-cleft margin. Hymenium glaucous white, plane. Asci clavate-cylindrical, sessile, 70-75 x 6 μ . Paraphyses filiform, branched at the tips and bearing minute, subglobose, hyaline conidia. Sporidia filiform, multinucleate, hyaline, 50-55 x 1 $\frac{1}{2}$ -2 μ .

This is a more robust species than *S. quercifolia* Cke., which also has longer asci and narrower sporidia, but the two are closely allied.

Stictis chrysopsis E. & E.

On dead stems of *Ceanothus integerrimus*, Columbia River, W. Klitkat Co., Wash., Jan. 1894 (W. N. Suksdorf, No. 309).

Ascomata scattered, immersed, exposed above and at first covered with a thin, white membrane, soon open, urceolate, exposing the deep orange-colored disk, 1-1 $\frac{1}{2}$ mm. diam. Asci cylindrical, 200-225 x 8-10 μ . Paraphyses filiform, about as long as the asci, simple, scarcely thickened above, about 1 μ thick. Sporidia filiform, multinucleate, nearly as long as the asci, 1 $\frac{1}{2}$ -2 μ thick, hyaline, interwoven.

Schizoxylon compositum E. & E.

On dead twigs of *Quercus coccinea*, Newfield, N. J., and on dead twigs of *Symphoricarpos occidentalis*, Rockport, Kansas (Bartholomew).

Ascomata erumpent-superficial, discoid, white pruinose, $\frac{3}{4}$ -1 $\frac{1}{2}$ mm. diam. Disk, when the white pruinose layer disappears, distinctly olivaceous. Asci fusoid-cylindrical or lanceolate, 150-200 x 8-10 μ , 8-spored, short-stipitate. Sporidia linear, 100-150 x 3-4 μ . Separating into elliptical or oblong joints 5-8 x 3-4 μ .

This differs from all the other species in the excipulum, containing often 2-6 distinct ascigerous nuclei, resembling on a horizontal section, so many imbedded perithecia. The paraphyses are filiform and more or less recurved and branched above.

Sphaeropeziza Coloradensis E. & E.

On decorticated stems of *Potentilla fruticosa*, North Park, Colo., July, 1894 (Prof. C. S. Crandall, No. 30).

Ascomata scattered, erumpent-superficial, about $\frac{3}{4}$ mm. diam., subglobose and closed at first, then depressed and deliscent above, with the fimbriate-lacerate margin incurved. Asci clavate, 45-50 x 5-6 μ , sessile and closely surrounded and overtopped by the con-

glutinate paraphyses. Sporidia biseriata, oblong-cylindrical, hyaline, 2-5- (mostly 3-) septate, not constricted, ends rounded, $10-14 \times 3-3\frac{1}{2}\mu$.

Patinella macrospora E. & E.

On dead stems of *Geum Rossi*, mountains above Cameron Pass, N. W. Colo., alt. 12,000 ft., July, 1894 (Prof. C. S. Crandall, No. 24).

Ascomata gregarious, discoid, superficial, attached by a central point, olive-black, glabrous, about $\frac{3}{4}$ mm. diam., disk flat, with a thin, narrow, entire, erect margin. Asci clavate-cylindrical, $100-110 \times 15-20\mu$. 8-spored. Paraphyses stout, simple, olivaceous above, and enlarged into an obovate, olivaceous head, $6-7 \times 5-6\mu$. Sporidia uniseriate below, subbiseriata above, elliptical, hyaline, smooth, 2-nucleate, about $20 \times 10\mu$, apparently not fully matured.

Differs from *P. hyalophæa* Sacc. principally in its much larger sporidia.

Scleroderris orientalis E. & E.

On dead limbs of *Cedrus Libani* (cult.), Newfield, N. J., April, 1894.

Ascomata erumpent, cespitose, obconical, dirty white, small, $300-400\mu$ diam., pulverulent, closely crowded together, or more rarely single, with much the same habit as *S. pallidula* Cke., and *Dermatea carnea* C. & E. Disk plane or convex, immarginate. Asci clavate-oblong, stipitate, p. sp. $55-60 \times 12-14\mu$, paraphysate. Sporidia biseriata, oblong, obtuse, straight or slightly curved, 3-septate, not constricted, hyaline, $18-23 \times 8-10\mu$.

* * * * **SPHÆROPSIDÆÆ.**

Phyllosticta lindericola E. & E.

On leaves of *Lindera Benzoin*, Nuttallburg, West Va., Sept. 1894 (L. W. Nuttall, No. 593).

Spots various, punctiform and minute without any definite border or irregular in shape, 1 mm.-1 or $1\frac{1}{2}$ cm. diam., or marginal, forming a narrow strip along the edge of the leaf for half its length, pale brown, nearly the color of weather-beaten wood, with a dark (almost black) border. Perithecia epiphyllous, hemispherical, $100-120\mu$ diam., covered by the blackened epidermis which is raised into pustules barely pierced at the apex. Sporules oblong-elliptical, hyaline, $4-7 \times 2-3\mu$.

This differs in almost every respect from *Ph. Linderae* E. & E.

Phyllosticta Brunellæ E. & E.

On leaves of *Brunella vulgaris*, Seattle, Wash., Sept. 1892 (Prof. C. V. Piper).

Spots rusty brown, of irregular shape, subangular, 3-4 mm. diam., or often much larger, occupying half or more of the leaf, definitely limited but without any distinct border. Perithecia buried in the substance of the leaf, minute, dark colored, scarcely visible. Sporules cylindrical, $3-3\frac{1}{2} \times \frac{1}{2}-\frac{3}{4}\mu$, straight, obtuse, slightly swollen at each end, much like those of *Ph. osteospora* Sacc., which, however, has sporules $6-7 \times 1\mu$.

Phyllosticta ferax E. & E.

On fading leaves of *Lupinus albifrons*, Pasadena, Cal., Apr. 1894 (Prof. A. J. McClatchie, 682).

Spots subindefinite, epiphyllous, dark, dirty brown, more or less confluent, blackening and killing the leaves. Perithecia epiphyllous, abundant, scattered over the spots and over the green parts of the leaf, semiemergent, globose, of rather coarse cellular structure, 110-150 μ diam., perforated above. Sporules abundant, hyaline, continuous, $3-4 \times 1-1\frac{1}{4}\mu$.

Phyllosticta macrospora E. & E.

On leaves of *Liriodendron Tulipifera*, Nuttallburg, West Va., Aug. 1894 (L. W. Nuttall).

Spots few, suborbicular, ferruginous-gray, 3-5 mm. diam., with a narrow, raised, darker border. Sporules oblong-elliptical, hyaline, nucleate, 15-30 (mostly 20-25 \times 6-7 μ).

Phyllosticta allantospora E. & E.

On leaves of *Cakile Americana*, Sandy Hook, N. J., June, 1892 (F. L. Stevens).

Spots suborbicular, wood-color brown, 3-4 mm. diam., margin broad, greenish, subindefinite. Perithecia epiphyllous, subdiscoid, perforated, 100-110 μ diam. Sporules oblong or short-cylindrical, hyaline, obtuse, mostly a little curved, $3-5 \times 1\frac{1}{4}\mu$.

Phyllosticta Araliæ E. & E.

On leaves of *Aralia spinosa*, Nuttallburg, West Va., Sept. 1894 (L. W. Nuttall, No. 588).

Spots suborbicular, light brown, with the margin a little darker, $\frac{1}{2}$ -1 cm. diam. Perithecia epiphyllous, somewhat flattened, 100-150 μ diam. Sporules oblong-elliptical, hyaline, 2-nucleate, 10-15 \times 5-6 μ .

Phyllosticta Aplectri E. & E.

On leaves of *Aplectrum hyemale*, Naaman's Creek, Del., Apr. 1894 (Commons, No. 2,408).

Spots of irregular shape, whitish, with a shaded purple border, 1 cm. diam. Perithecia crowded in the spots, erumpent, depressed-globose, 75–90 μ , with a distinct papilliform ostiolum, of a coarse cellular, dark olivaceous texture. Sporules elliptical, hyaline, 6–9 x 5 μ , filled with small nuclei. Accompanied by *Fusicladium Aplectri* E. & E. on the same spots.

Phyllosticta rhoicola E. & E.

On leaves of *Rhus Toxicodendron*, Nuttallburg, West Va., Aug. 1894 (L. W. Nuttall, No. 567, partly).

Spots 4–6 mm. diam., deciduous, grayish-white, with a narrow black border. Perithecia epiphyllous, scattered, 100–110 μ diam., convex-prominent above, visible also below. Sporules narrow-elliptical, hyaline, 2-nucleate, 5–6 x 2–3 μ .

Differs from *P. toxica* E. & M. in its larger deciduous spots with a narrow border, and its narrow-elliptical sporules.

Phyllosticta Anemonis E. & E.

On leaves of *Anemone Pennsylvanica*, Ann Arbor, Mich., Oct. 1893 (Harriet L. Merrow).

Perithecia gregarious, hypophyllous, depressed-globose, erumpent-superficial, 90–110 μ diam., subastomous, on light brown, dead looking areas of the leaf, more or less distinctly bounded by the veinlets. Sporules short-cylindrical, slightly curved, obtuse, 5–7 x 1 $\frac{1}{4}$ μ .

This is different from *Phyllachora Anemonis* (Fr.), which is found both on the petioles and leaves, and has the characteristic stromata of the Dothideaceæ, the single stromata being about twice as large as the perithecia of our *Phyllosticta* and each containing (sec. spec. in F. G. 192) 3–6 ascigerous cells.

Phyllosticta Quercus-Prini E. & E.

On leaves of *Quercus Prinus*, Nuttallburg, West Va., July, 1894 (L. W. Nuttall, No. 542).

Spots orbicular, rusty brown, definite, with a very narrow border, 2–3 mm. diam. Perithecia epiphyllous, scattered, erumpent, 90–110 μ diam. Sporules ovate or oblong, hyaline, mostly a little curved, 5–6 $\frac{1}{2}$ x 2–2 $\frac{1}{2}$ μ .

This comes very near *Ph. Ludoviciana* E. & E. (J. M. II, p.

130), but in that species the spots are larger, perithecia more prominent below, and sporules rather larger. *Ph. marginalis* E. & E. also has similar sporules but the perithecia are hypophyllous.

Phyllosticta Castaneæ E. & E.

On leaves of *Castanea vesca*, near Nuttallburg, West Va., July, 1894 (L. W. Nuttall, No. 570).

Spots orbicular, rust color, with narrow, dark-shaded margin. Perithecia epiphyllous, scattered on the spots, dark, semierumpent, 100 μ diam., often collapsing. Sporules oblong, hyaline, 5-7 x 2-2 $\frac{1}{2}$ μ .

Phoma negundinicola Thum., var. *ramicola* E. & E.

On dead limbs of *Negundo aceroides*, Nuttallburg, West Va., Apr. 1894 (L. W. Nuttall, No. 466), Delaware (Commons).

Perithecia evenly, but not thickly scattered, globose, small, $\frac{1}{4}$ - $\frac{1}{3}$ mm. diam., covered by the slightly ruptured epidermis, but distinctly prominent. Sporules oblong-elliptical, or ovate, hyaline, with a single large nucleus, 10-13 x 4-5 $\frac{1}{2}$ μ .

Differs from the typical form on the dead peduncles, in its broader (2 $\frac{1}{2}$ -3 μ) sporules.

Phoma Pennsylvanica E. & E.

On dead limbs of *Acer Pennsylvanicum*, Nuttallburg, West Va., Feb. 1894 (Nuttall, No. 318).

Perithecia numerous, evenly scattered, subepidermal, $\frac{1}{3}$ - $\frac{1}{2}$ mm. diam., whitish inside, raising the epidermis into minute pustules, but scarcely rupturing it. Sporules subglobose, 6-7 $\frac{1}{2}$ μ diam., nearly hyaline.

Phoma pedunculi E. & E.

On old peduncles of *Magnolia Fraseri*, Nuttallburg, West Va., Jan. 1894 (L. W. Nuttall, No. 297).

Perithecia scattered, flattish pustuliform, $\frac{1}{2}$ - $\frac{3}{4}$ mm. diam., with a prominent, papilliform ostiolum. Sporules fusoid-oblong, hyaline, 2-3-nucleate, 7-11 x 2-2 $\frac{1}{2}$ μ , ends acute.

Differs from *Stagonospora pedunculi* E. & E. in its larger, flatter perithecia and fusoid-oblong (not cylindrical), rather shorter sporules.

Phoma obscurans E. & E.

On leaves of *Fragaria* (cult.), Nuttallburg, West Va., and Newfield, N. J.

Spots 5-8 mm. diam., with a ferruginous center and broad purple

border, paler below. Perithecia few, scattered, convex-prominent. Sporules oblong-elliptical, hyaline, 2-nucleate, $4\frac{1}{2}$ - $5\frac{1}{2}$ x $1\frac{1}{2}$ - 2μ . Basidia simple, lanceolate-fusoid, 8-12 x $1\frac{1}{2}\mu$.

Phyllosticta fragaricola Desm. has similar sporules, but (sec. specc. in the various exsiccati), the spots are much smaller, with a white center. The basidia also indicate *Phoma* and not *Phyllosticta*.

Aposphæria alpigena E. & E.

On dead stems of *Sambucus melanocarpa*, Cameron Pass, Colo., July, 1894 (C. F. Baker).

Perithecia scattered, superficial, globose or elliptical, 150-250 μ diam., mostly depressed, obscurely papillate. Sporules elliptical, hyaline, enucleate, 3-3 $\frac{1}{2}$ x $1\frac{1}{2}\mu$.

Differs from *A. fuscidula* Sacc. in growing on the bark (not on decorticated limbs), and in its smaller sporules.

Aposphæria pezizoides E. & E.

On decorticated wood of *Platanus*, *Liquidambar*, *Fraxinus*, *Acer*, *Salix nigra*, and *S. falcata*, Nuttallburg, West Va., April, 1894 (L. W. Nuttall).

Perithecia erumpent-superficial, seriate-aggregate, hemispherical, about $\frac{3}{4}$ mm. diam., with a distinct papilliform ostiolum, at length collapsing and pezizoid or discoid. Sporules elliptical or ovoid, 4-6 x $2\frac{1}{2}\mu$, ends obtuse.

This seems to grow exclusively on abrasions, below high-water mark, made by driftwood on small trees.

Sphæronema Physocarpi E. & E.

On dead stems of *Physocarpus opulifolius*, Nuttallburg, West Va., May, 1894 (L. W. Nuttall, No. 484).

Perithecia gregarious, erumpent-superficial, hemispherical, 150 μ diam., with a straight, stout beak 90-115 μ long. Sporules narrow-elliptical, hyaline, 2-3-nucleate, 7-9 x $2\frac{1}{2}\mu$.

Sirococcus Halesiæ E. & E.

On dead limbs of *Halesia tetraptera*, Nuttallburg, West Va., Feb. 1894 (L. W. Nuttall, No. 376).

Perithecia scattered or 2-3-connate, erumpent, subglobose, about $\frac{1}{2}$ mm. diam., black, with a minute papilliform ostiolum. Sporules subglobose, about 3 μ diam., greenish-hyaline, 3-6-concatenate, the terminal sporule oblong and paler. Chains simple, or sparingly branched, arising directly from the prolikerous layer without any distinct basidia, collected in stellate clusters.

Pyrenochaete papyricola E. & E.

On old pasteboard lying by the roadside, Newfield, N. J., July, 1894.

Perithecia scattered, subglobose, 100–110 μ diam., clothed with black, bristle-like hairs. Sporules subglobose or subelliptical, hyaline, 3–3½ μ in the longer diameter.

Placosphæria Arctostaphyli E. & E.

On dead twigs of *Arctostaphylos Nevadensis*, Mt. Paddo, Wash., alt. 6,000–7,000 ft., July, 1886 (Suksdorf).

Stromata erumpent-superficial, pulvinate, ½–¾ mm. diam., flattened and mostly depressed in the center, dotted with punctiform ostiola, closely embraced by the epidermis, multilocular. Sporules oblong-cylindrical, hyaline, continuous, 5–6 x 2–2½ μ .

Has the stroma of *Dothidea* producing only stylospores.

Fusicoccum Tiliæ E. & E.

On dead limbs of *Tilia Americana*, Naaman's Creek, Del., Aug. 1894 (A. Commons, No. 2,517).

Stromata scattered, buried, conic-ovate, 250–350 μ diam., one-celled, gray inside, raising the epidermis into acute pustules perforated with a round opening. Sporules oblong-fusoid, hyaline, 2-nucleate, 7–10–2½ x 3 μ .

Fusicoccum ilicinum E. & E.

On dead limbs of *Ilex opaca*, Nuttallburg, West Va., May, 1894 (L. W. Nuttall, No. 496).

Stromata cortical, convex, about 1 or 1½ mm. diam., multilocular, whitish inside, the tuberculiform apex pierced with a single pore, rupturing the epidermis and slightly raising it. Sporules fusoid, hyaline, nucleate, 15–22 x 2½–3 μ .

Cytispora pinicola E. & E.

On bark of limbs of *Abies Engelmanni*, N. W. Colo., July, 1894 (Prof. C. S. Crandall, No. 6).

Stromata erumpent-superficial, verruciform, 1–1½ mm. diam., easily deciduous. Perithecia peripheral. Sporules minute, elliptical, hyaline, 3 x 1½ μ , borne on much branched basidia 15–20 x 2 μ . The habit is that of *Dothiorella*, but the minute sporules are those of *Cytispora*.

Cytispora caryigena E. & E.

On dead limbs of *Carya alba*, Nuttallburg, West Va., May, 1894 (L. W. Nuttall, No. 513).

Stroma cortical, convex, $1\frac{1}{2}$ –2 mm. diam., slaty black, 4–6-celled, cells yellowish-white, subglobose, small. Sporules allantoid, hyaline $3\frac{1}{2}$ – $4\frac{1}{2}$ x $\frac{3}{4}$ – 1μ .

(Spermogonia of *Valsa caryigena*, B. & C.)?

Cytispora exasperans E & E.

On dead limbs of *Acer rubrum*, Newfield, N. J., and on *Acer Pennsylvanicum*, Nuttallburg, West Va. (Nuttall).

Stroma buried in the bark, orbicular, about 1 mm. diam., 4–6-celled (at length one-celled), prolonged above into a stout, conical beak opening by a single round pore at the apex. Sporules oblong or allantoid, hyaline, 5 – 7 x $1\frac{1}{4}\mu$.

Cytispora Celtidis E. & E.

On dead limbs of *Celtis*, Nuttallburg, West Va., Feb. 1894 (L. W. Nuttall, No. 314).

Stroma valsoid, flat, thin, $1\frac{1}{2}$ –2 mm. diam., only penetrating the surface of the bark, multilocular, gray inside, raising the bark into small pustules and finally rupturing it, cells resembling perithecia. Sporules allantoid, 6 – 7 x 1 – $1\frac{1}{2}\mu$.

Cytispora phlyctænoïdes E. & E.

On dead limbs of *Corylus Avellana*, Newfield, N. J., June, 1894.

Stromata cortical, conic-convex, 1 – $1\frac{1}{4}$ mm. diam., indistinctly multilocular, pale inside, with the enclosing layer darker, raising the epidermis into numerous small pustules which are soon ruptured, opening mostly through a single pore. Sporules fusoid, hyaline, 2-nucleate, 6 – 9 x 2 – $2\frac{1}{2}\mu$, straight. Basidia simple, attenuated and curved above, about 20 x $1\frac{1}{2}\mu$, resembling the sporules of *Phlyctena*.

Cytispora Negundinis E. & E.

On dead limbs of *Negundo aceroides*, Rockport, Kansas, April, 1894 (Bartholomew, No. 1,449).

Stroma cortical, conic-convex, 1 – $1\frac{1}{4}$ mm. diam., slaty black, multilocular, the cells ovate-globose, numerous (15–20 or more), all opening through a single pore in a central column which pierces the epidermis and raises it into little pustules. Sporules allantoid, hyaline, slightly curved, $5\frac{1}{2}$ – 7 x $1\frac{1}{4}$ – $1\frac{1}{2}\mu$. On branched basidia 20μ long.

This is different from *C. macilenta* Rob. and Desm., as shown by a comparison of the spec. From *C. Pseudoplatani* Sacc., it differs in its longer sporules and branching basidia.

Cytispora Halesiæ E. & E.

On dead limbs of *Halesia tetraptera*, Nuttallburg, West Va., May, 1894 (L. W. Nuttall).

Stromata convex-conical, sunk in the bark, orbicular, about 1 mm. diam., white inside, unilocular, the inner surface of the cavity lined with simple, straight basidia about 15μ long, bearing the oblong-fusoid, hyaline, 2-nucleate, straight, $5-7 \times 1-1\frac{1}{2}\mu$ sporules, which are expelled through a single orifice perforating the raised epidermis.

This probably is the spermogonial stage of *Diaporthe Halesiæ* or *D. tetraptera*, both of which are found in company with it.

Sphæroopsis Coryli E. & E.

On dead limbs of *Corylus Avellana*, Newfield, N. J., June, 1894.

Perithecia thickly scattered, globose, subcuticular, about $\frac{1}{2}$ mm. diam., raising the epidermis into small pustules which are finally ruptured at the apex with a round or elongated opening. Sporules oblong-elliptical, or the longer ones slightly curved and subcylindrical, $15-20 \times 8-10\mu$.

Sphæroopsis Asiminae E. & E.

On dead limbs of *Asimina triloba*, Nuttallburg, W. Va., Feb. 1894 (L. W. Nuttall, No. 370).

Perithecia scattered or subseriate, buried in the bark which is raised into little pustules over them and soon ruptured. Perithecia small ($\frac{1}{3}$ mm.), thick-walled, with an obscurely papilliform ostiolum. Sporules oblong-elliptical, brown, obtuse, $18-22 \times 8-10\mu$.

Sphæroopsis Neilliae E. & E.

On *Physocarpus opulifolius*, London, Canada, May, 1893 (J. Dearness).

Perithecia scattered or sometimes 2-3 confluent, small (200μ), covered by the blackened epidermis, semierumpent, with a black, shining papilliform ostiolum. Sporules small, acutely elliptical, or ovate-elliptical, pale brown, $12-16 \times 4-5\mu$.

Sphæroopsis Physocarpi E. & E.

On dead *Physocarpus opulifolius*, Nuttallburg, West Va., May, 1894 (L. W. Nuttall, Nos. 482 and 486).

Perithecia scattered, $\frac{1}{2}$ mm. diam., buried in the inner bark, with their apices and papilliform ostiola erumpent, white inside (at first), sometimes, as in the preceding species 2-3 confluent. Sporules varying from short-elliptical $12-15 \times 10\mu$, to oblong- or obovate-elliptical $15-20 \times 10\mu$.

Differs from the preceding in its buried perithecia and much larger sporules.

Sphaeropsis Ipomœa E. & E.

On dead peduncles of *Ipomœa pandurata*, Nuttallburg, West Va., Dec. 1893 (L. W. Nuttall, No. 249).

Perithecia scattered, ovate-globose, 250–300 μ diam., the upper part prominent and closely covered by the shining black epidermis. Sporules elliptical, brown, 18–23 x 10–13 μ , on pedicels of about the same length as the sporules.

Coniothyrium infuscans E. & E.

On dead stems of *Valeriana edulis*, Eastern slope of Rabbit Ear Range, Colorado, July, 1894 (Prof. C. S. Crandall, No. 10).

Perithecia densely gregarious, blackening the stems, ovate-globose, membranaceous, black, erumpent-superficial, 170–200 μ diam. Sporules globose-elliptical, brown, 6–8 μ in the longer diam.

Haplosporella alpina E. & E.

Cameron Pass, Colorado, July, 1894, 10,000 ft. alt. (C. F. Baker, No. 236).

On dead stems of *Sambucus melanocarpa*. Stroma convex-hemispherical, erumpent-superficial, black, 300–400 μ diam. Perithecia (cells) buried in the stroma, 100–150 μ diam., their papilliform ostiola visible on the surface of the stroma. Sporules globose, 5 μ , or elliptical, 6–7 x 5 μ , brown.

Apparently the pycnidial stage of some dothideaceous fungus (*Auerswaldia*)?

Haplosporella Araliæ E. & E.

On dead limbs of *Aralia spinosa*, Nuttallburg, West Va., Feb. 1894 (Nuttall, No. 375).

Stromata seriate-commate, erumpent through longitudinal cracks in the bark, and extending from 4–5 mm. to 2 or more centimetres. Perithecia ovate-globose, buried in the black, subcarbonaceous stroma, 3–6 in each single stroma, about $\frac{1}{3}$ mm. diam. Sporules elliptical, brown, 20–25 x 10–12 μ .

This may be the pycnidia of *Botryosphaeria fuliginosa* (M. & N.).

Haplosporella Celtidis E. & E.

On dead limbs of *Celtis*, West Va., Feb. 1894 (L. W. Nuttall, No. 315).

Perithecia mostly in valsoid clusters of 3-10, small (200 μ), white inside, slightly sunk in the inner bark, their papilliform ostiola rupturing the epidermis. Sporules elliptical, brown, continuous, 18-22 x 10-12 μ , on basidia of about the same length as the sporules.

Diplodia Kansensis E. & E.

On weather-beaten, bleached bark of *Juniperus Virginiana*, Rockport, Ks., Dec. 1893 (E. Bartholomew, No. 1,292).

Perithecia scattered, subglobose, erumpent-superficial, $\frac{1}{2}$ - $\frac{1}{2}$ mm. diam. Sporules ovate-elliptical, uniseptate, constricted, the septum below the middle, brown, becoming nearly opaque, 20-27 x 12-15 μ .

Differs from *D. Juniperi* West, and *D. Virginiana* Cke., in its larger ovate sporules.

Diplodia caryigena E. & E.

On dead limbs of *Carya alba*, Canada (Dearness) and West Va. (Nuttall).

Perithecia subseriate, sunk in the inner bark, covered by the epidermis which is raised into pustules and ruptured, about $\frac{1}{2}$ mm. diam., black. Sporules elliptical, brown, uniseptate, scarcely constricted, 15-20 x 8-10 μ . (Pycnidia of *Valsa caryigena* B. & C.)?

Diplodia infuscans E. & E.

On bark of dead limbs of *Fraxinus Americana*, Nuttallburg, West Va., May, 1894 (L. W. Nuttall, No. 459).

Perithecia ovate-globose, small, 110-150 μ diam., thickly scattered, blackening both the outer and inner surface of the bark. Ostiolum not conspicuous, obscurely papilliform. Sporules oblong-elliptical, 12-15 x 8-10 μ , scarcely constricted.

In *D. inquinans* West, the sporules and perithecia are larger, and the bark is not blackened within.

Diplodia Cercidis E. & E.

On dead limbs of *Cercis Canadensis*, Nuttallburg, West Va., Apr. 1894 (L. W. Nuttall, No. 449).

Perithecia subseriate, globose, $\frac{1}{2}$ - $\frac{1}{2}$ mm. diam., slightly sunk in the inner bark and splitting the epidermis with short, longitudinal clefts. Sporules elliptical, 20-23 x 10-15 μ , on stout basidia, uniseptate.

Botryodiplodia acerina E. & E.

On dead limbs of *Acer Pennsylvanicum*, Nuttallburg, West Va., Feb. 1894 (Nuttall, No. 319).

Perithecia erumpent in botryoidal clusters often seriatly confluent for 1 or more cm., about $\frac{1}{2}$ mm. diam., white inside, flattish above, with a broad papilliform ostiolum. Sporules elliptical, brown, uniseptate, 20–25 x 12–15 μ , on basidia of about the same length.

Ascochyta veratrina E. & E.

On dead leaves and petioles of *Veratrum Californicum*, Pullman, Wash., Nov. 1893 (Prof. C. V. Piper, No. 145).

Perithecia scattered, sunk in the substance of the leaf with the apex and conic-papilliform ostiolum erumpent, about $\frac{1}{3}$ mm. diam. Sporules cylindrical, obtuse, 3–4-nucleate, becoming uniseptate, hyaline, about 12 x 2 $\frac{1}{2}$ –3 μ .

Differs from *A. Veratri* Cavarra (Fungi Langobardiæ, No. 98) in its larger, ostiolate perithecia, not on any spots and in its smaller, straight sporules.

Ascochyta achlyicola E. & E.

On leaves of *Achlys triphylla*, Seattle, Wash., Aug. 1892 (Prof. C. V. Piper, No. 114).

Spots suborbicular or irregular, 3–15 mm. diam., with a dirty white center and a broad, shaded purple margin. The white center is more or less deciduous. Perithecia epiphyllous, innate-prominent, small (75 μ), few on a spot. Sporules elliptical, 2-nucleate, hyaline, 5–8 x 2 $\frac{1}{2}$ –3 μ , soon becoming uniseptate.

Ascochyta Asclepiadis E. & E.

On leaves of *Asclepias Cornuti*, Pleasant Hill, Del., May, 1894 (Commons, No. 2,420).

Spots amphigenous, suborbicular, $\frac{1}{2}$ –1 mm. diam., grayish, with darker zones and a shaded, dark-brown border. Sporules oblong- (or ovate-) elliptical, hyaline, 6–8 x 3 μ , becoming faintly uniseptate. Perithecia epiphyllous, innate, black, pierced above, 100–110 μ diam.

Hendersonia stygia E. & E.

On decorticated, bleached wood of a cottonwood log, Rockport, Ks., Dec. 1893 (E. Bartholomew).

Perithecia erumpent-superficial, scattered, ovate-globose, $\frac{1}{2}$ mm. diam., or hysteriiform, 1 mm. or more long, at first with a prominent papilliform ostiolum, but soon broadly open above, the upper part finally disappearing, leaving the cup-shaped base filled with abundant sporules and then more resembling acervuli than perithecia. Sporules

ovate-elliptical, subinequilateral, abruptly narrowed at the ends, 3-5-septate, but not constricted, the inner cells nearly opaque, the small, terminal cells subhyaline, 12-15 x 6-8 μ .

The species is anomalous in the imperfectly developed perithecia, the upper part soon falling away and leaving the cup-shaped base.

Hendersonia falcata E. & E.

On bark of fir trees, Exploits, Newfoundland, Dec. 1893 (Rev. A. C. Waghorne, No. 10).

Perithecia cespitose-erumpent, 6-10 together, united below in a thin stroma, broadly perforated and subcollapsed above. Stromata small (1 mm.), subconfluent and subseriately arranged. Sporules falcate, more abruptly curved or bent above, yellowish-hyaline, granular, becoming 1-3-septate, subattenuated below, on pedicels shorter than the sporules, 20-22 x 5-7 μ .

Differs from *Hendersonia rostrata* S. & E. in its stromatic growth and broader, shorter sporules.

Stagonospora petiolorum E. & E.

On dead petioles of *Aralia spinosa*, Nuttallburg, West Va., Feb. 1894 (L. W. Nuttall, No. 357).

Perithecia scattered, innate, small, slightly prominent and covered by the shining, blackened epidermis, 150-250 μ diam., mostly-sub-elliptical. Sporules oblong, hyaline, nucleate, becoming 1- or more-septate, 12-20 x 3-5 μ .

Stagonospora Physocarpi E. & E.

On dead stems and limbs of *Physocarpus opulifolius*, Nuttallburg, West Va., May, 1894 (L. W. Nuttall, No. 485).

Perithecia scattered, depressed-hemispherical, 200-250 μ diam., sunk in the bark, with the upper part prominent but covered by the epidermis which is pierced by the papilliform ostiolum, white inside. Sporules linear, multiseptate, hyaline, 25-35 x 3-4 μ .

Stagonospora Liriodendri E. & E.

On decorticated wood of *Liriodendron Tulipifera*, Alcove, N. Y., June, 1893 (C. L. Spear, No. 304).

Perithecia superficial, evenly scattered or 2-4 subconfluent, obtusely conic-globose, about $\frac{1}{2}$ mm. diam. Sporules cylindrical, hyaline, 8-10 x 2-2 $\frac{1}{2}$ μ , nucleate but not visibly septate, though a central nucleus causes them to appear uniseptate. Basidia slender 25-35 μ long, profusely and subverticillately branched.

Camarosporium Celtidis E. & E.

On dead limbs of *Celtis occidentalis*, Rockport, Ks., March, 1894 (Bartholomew, No. 1,400).

Perithecia scattered or cespitose, ovate, $\frac{1}{3}$ mm. diam., often seriate, covered by the epidermis at first, with the short-cylindrical, obtuse ostiola erumpent. Sporules oblong, or oblong-elliptical or even cylindrical, brown, mostly 3-septate, 12-15 x 4-5 μ , but some of them 5-6-septate, with one or two cells divided by a longitudinal septum, 15-20 x 5-7 μ .

There is also a *Teichospora* accompanying, but too scanty to admit of accurate description.

Septoria Echinocystis E. & E.

On leaves of *Echinocystis marah*, Ukiah, Mendocino Co., Cala., May, 1894 (W. C. Blasdale, No. 220).

Spots subangular, limited at first by the veinlets and greenish, becoming light brown with the margin darker, 3-5 mm. diam. Perithecia innate, globose, about 80 μ diam., thin, imperfectly developed, brown. Sporules linear, hyaline, nearly straight or subundulate, becoming faintly 1-2-septate, 25-50 x 2 $\frac{1}{2}$ -3 μ .

Septoria solanicola E. & E.

On leaves of *Solanum umbelliferum*, Ukiah, Mendocino Co., Cala., May, 1894 (W. C. Blasdale, No. 241).

Spots scattered or confluent, orbicular, 2-3 mm. diam., pale brown with darker border. Perithecia epiphyllous, numerous, pale brown, collapsing, 100-110 μ diam. Sporules bacillary, hyaline, faintly nucleate, 20-30 x 1 $\frac{3}{4}$ -2 $\frac{1}{4}$ μ .

Differs from the other species on *Solanaceæ* in its shorter, continuous sporules. Roumeguere in F. Gallici 722 has a *Septoria* labeled *S. Solani*, Roum., on *Solanum nigrum*, but the spec. is entirely sterile.

Septoria ainifolia E. & E.

On leaves of *Alnus rubra*, Seattle, Wash., Aug. 1893 (Prof. C. V. Piper, No. 82).

Spots red-rusty brown, orbicular or irregular, mostly with a narrow, dark, raised bordering line, 2-5 mm. diam., more obscure below. Perithecia epiphyllous, innate-prominent, black, minute (80-100 μ), not abundant. Sporules linear, hyaline, with a row of nuclei, mostly curved to a semicircle, 35-55 x 3 μ .

Of the three described species on *Alnus*, *S. Alni* Sacc. has bacil-

lary sporules, *S. albicola* Cke. has oblong sporules, and *S. albigena* Sacc. has no spots.

Septoria solitaria E. & E.

On leaves of *Rhododendron occidentale*, Mill Valley, Cal., July, 1893 (W. C. Blasdale, 172).

Spots amphigenous, round, white with a purple border, numerous, about 2 mm. diam. Perithecia mostly one in the center of each spot, globose, 120–150 μ diam., visible on both sides of the leaf. Sporules abundant, bacillary, hyaline, continuous, straight or subundulate or bent, obtuse, about 20 x 2 μ .

Septoria Rhododendri Cke. has the perithecia aggregated or circinate and sporules 40 μ long.

Septoria Ceanthis E. & E.

On leaves of *Ceanthe sarmentosa*, Seattle, Wash., Aug. 1892 (Prof. C. V. Piper, No. 50).

Spots scattered, small (1–3 mm.), white, subangular, definite. Perithecia few on a spot (3–6), small (75 μ), black (yellow-brown under the microscope), subastomous. Sporules fusoid-cylindrical, hyaline, nucleate, 20–35 x 1½–2 μ , ends subacute, slightly curved.

Septoria saccharina E. & E., var. *occidentalis*.

On dead leaves of *Acer glabrum*, Fairhaven, Wash., Aug. 1892 (Prof. C. V. Piper, No. 57).

Differs from the type in having the small, white spots, on which the perithecia are seated, not so evenly distributed over the leaf, but collected on rusty brown, yellow-margined, subindefinite spots 3–4 mm. diam.

Septoria circinata E. & E.

On leaves of *Acer circinatum*, Everson, Wash., Aug. 1892 (C. V. Piper).

Spots orbicular, scattered, 2–3 mm. diam., pale yellowish-white, definite but without any distinct border. Perithecia amphigenous, few (4–10), subcircinately arranged around the whitish center of the spots, small, 75 μ diam. Sporules abundant, filiform, variously curved and bent, 30–60 x 1½ μ , nucleate, but not septate. Seems quite distinct from the other species on maple.

Septoria Tecomæ E. & E.

On leaves of *Tecoma radicans*, Nuttallburg, West Va., Aug. 1894 (L. W. Nuttall, No. 580).

Spots light brown (wood color), irregular in shape, small, $1\frac{1}{2}$ -2 mm., inconspicuous and indistinctly margined. Perithecia immersed, small (65-70 μ), barely visible with a lens. Sporules 40-50 x 2-2 $\frac{1}{2}$ μ , not strongly curved, nucleate, hyaline.

Septoria Ludoviciana E. & E.

On leaves of *Lactuca Ludoviciana*, Fort Collins, Colo., June, 1894 (C. F. Baker, No. 257).

Spots angular, limited by the veinlets, wood-brown, 2-5 mm. diam., often confluent. Perithecia punctiform, minute, black, epiphyllous, 75-80 μ diam., apex erumpent. Sporules cylindrical, more or less curved, obtuse, not septate, 15-25 x 2 μ .

Differs from *S. unicolor* Winter, in its lighter colored, angular spots, rather larger perithecia and thicker sporules; differs also in several respects from *S. Lactucae* Pass. and *S. lactuicola* E. & M.

Septoria Trautvetteriæ E. & E.

On *Trautvetteria palmata*, Nuttallburg, West Va., July, 1894 (L. W. Nuttall, No. 564).

Spots irregular, subangular, partly limited by the veinlets of the leaf, often elongated and acute at one end, brownish-black, with an irregularly shaped white center which is well defined, angular, 3-5 mm. in the longer diam. Perithecia epiphyllous but also visible below, small (65-75 μ), scattered, dark. Sporules abundant, nearly straight or slightly curved, continuous, 22-30 x 2 μ .

Differs from *S. Anemonis* Desm. in its broad, dark margined, white centered spots and rather longer and thicker sporules.

Septoria Polymniæ E. & E.

On leaves of *Polymnia Uvedalia*, Nuttallburg, West Va., July, 1894 (L. W. Nuttall, No. 543).

Spots scattered, angular, limited by the veinlets, 2-4 mm. diam., dirty green. Perithecia epiphyllous, minute, 75 μ diam., scattered, innate, inconspicuous. Sporules filiform, continuous, 35-50 x 1-1 $\frac{1}{4}$ μ .

Septoria hyalina E. & E.

On *Viola lanceolata*, Massachusetts (Miss Clarke); on *V. primulifolia*, West Va. (Nuttall), and on *V. blanda*, Michigan (Hicks).

Spots minute ($\frac{1}{2}$ -1 mm.), white, with a dark purple-shaded border. Perithecia punctiform, black, epiphyllous, subglobose, 65-75 μ diam., not abundant. Sporules filiform, nearly straight, or slightly curved,

hyaline, nucleate, not visibly septate, 20–40 (mostly 25–35) x 1–1½ μ .

S. Viola West, has yellowish-brown perithecia on pale zonate spots with a reddish-brown border.

Septoria micropuncta E. & E.

On leaves of *Osmorrhiza*, Washington, D. C. (1891)? (E. A. Southworth).

Spots small (1–1½ mm.), subangular, white, with a broad, dark colored border. Sporules cylindrical, slightly curved, not septate or visibly nucleate, 18–27 x 1½–1½ μ .

This is very different from *S. Osmorrhizæ* Pk. which has the spots larger, perithecia also larger, subdiscoid and amber colored, and sporules 35–55 x 2–2½ μ , uniseptate.

Septoria Megarrhizæ E. & E.

On leaves of *Megarrhiza Oregana* Benton, Wash., July 14, 1892 (C. V. Piper, No. 112, partly).

Spots orbicular, dirty white, with a broad, dark colored border, 3–5 mm. diam. Perithecia epiphyllous, light colored, innate-subprominent, subastomous, thin, 80–110 μ diam. Sporules filiform, nearly straight, hyaline, faintly nucleolate, 40–60 x 2½–3 μ .

Phleospora Megarrhizæ E. & E.

Same host and collector as *Septoria Megarrhizæ*.

Spots greenish at first, the central portion (1–3 mm. diam.) becoming dirty white with a faint, dark purple margin. Perithecia epiphyllous, subdiscoid, thin, perforated above, light colored, becoming darker, 150 μ diam. Sporules oblong, obtuse, 1–3-septate, hyaline, sometimes narrowed in the middle, 13–27 x 6–8 μ .

Distinguished from *Septoria Megarrhizæ*, even without microscopic examination by its much smaller subangular white spots.

Phlyotæna Ipomœa E. & E.

On calyx lobes of *Ipomœa pandurata*, Nuttallburg, West Va., Dec. 1893 (L. W. Nuttall, No. 250).

Perithecia scattered, subcuticular, 75–80 μ diam., covered by the blackened, slightly raised epidermis. Sporules linear, hyaline, curved above, 15–20 x 1½ μ .

Hysteromyxa corticola E. & E.

On inner surface of old cottonwood bark, Rockport, Ks., Dec. 1893 (E. Bartholomew, No. 1,306).

Perithecia erumpent - superficial, gregarious, membranaceous, yellowish-brown and pustuliform when fresh, collapsing to concave, nearly flat when dry, and then darker colored, the disk or center with a faint, flesh-colored tint, $\frac{1}{4}$ - $\frac{1}{2}$ mm. diam. Sporules globose, 6-8 μ diam., yellowish, with a tinge of rose color.

Differs from *H. effugiens* S. & E. in its different habitat and the darker color of the perithecia.

Dothichiza Cassandræ E. & E.

On dead limbs of *Cassandra calyculata*, Ann Arbor, Mich., May, 1894 (L. N. Johnson, No. 1,591).

Perithecia erumpent, surrounded by the ruptured epidermis, ovate-globose and closed at first, $\frac{1}{2}$ mm. diam., then irregularly ruptured and subcupulate, $\frac{1}{2}$ mm. diam. Sporules fusoid, hyaline, continuous, straight, acute, 10-14 x 2-2 $\frac{1}{2}$ μ .

Apparently the spermogonia stage of *Cenangium Cassandræ* Pk.

Glæosporium tremuloides E. & E.

On leaves of *Populus tremuloides*, Racine, Wis., Sept. 1893 (Dr. J. J. Davis).

Spots amphigenous, suborbicular, scattered or subconfluent, definite, dark brown, 2-4 mm. diam. Acervuli innate, globose or oblong, 75-85 μ diam., dark, erumpent on both sides of the leaf, often covered above by the loosened, silvery epidermis. Conidia elliptical, 10-13 x 5 $\frac{1}{2}$ -6 $\frac{1}{2}$ μ , continuous. *G. Tremulæ*, *G. Sibiricum*, and *G. Populi-albæ*, have fusoid or cylindrical conidia; *G. navoioides* Romell & Sacc. Grev. 21, p. 68, has ovate-oblong conidia, 30-35 x 10-12 μ , so that this seems sufficiently distinct from all the other species on poplar leaves.

Glæosporium officinale E. & E.

On leaves of *Sassafras officinale*, Smyrna, Del., June, 1894 (Commons, No. 2,438).

Spots irregular in shape, $\frac{1}{2}$ -1 cm. diam., dirty whitish in the center, with the border nearly black. Acervuli minute, numerous, innate, erumpent on both sides of the leaf, but more abundant below, the expelled spores forming little subglobose, pale orange colored subconfluent heaps. Spores oblong or clavate-oblong or ovate, 8-15 x 4-5 μ .

This is quite distinct from *Gl. Sassafras* (Cke), (*Gl. affine* E. & K.), in its much larger spores and the different character of the spots.

If, as seems probable, *Phyllosticta affinis* E. & K. in Am. Nat., Nov. 1883, is the same as *Ph. Sassafras* Cke. in Grev., Sept. 1883, the specific name "Sassafras" will have precedence, and "affine," already preoccupied by Saccardo, will be dropped, and *Gl. affine* E. & K. will become *Gl. Sassafras* (Cke.), the fungus being a *Glæosporium* and not a *Phyllosticta*.

Glæosporium Sanguinariæ E. & E.

On leaves of *Sanguinaria Canadensis*, Nuttallburg, West Va., July, 1894 (L. W. Nuttall, No. 555).

Spots yellow, oblong or irregular, 3-5 mm. diam., situated near the apex of the leaf which is more or less uniformly blackened. Acervuli epiphyllous, numerous, innate, yellow and inconspicuous. Conidia oblong, hyaline, continuous, mostly a little curved, 8-15 x $3\frac{1}{2}$ -5 $\frac{1}{2}\mu$.

Glæosporium alboferrugineum E. & E.

On leaves of *Acer saccharinum*, Peoria, Ills., July, 1894 (F. E. McDonald).

Spots numerous, small, subangular, partly limited by the veinlets. 1-2 mm. diam., deep reddish-brown, whitening out. Acervuli 100-150 μ diam., hypophyllous, becoming dark. Conidia oblong, hyaline, continuous, 12-14 x 3-3 $\frac{1}{2}\mu$.

Differs from *G. saccharinum* E. & E. in habit and in its conidia twice as long as in that species.

Glæosporium Trillii E. & E.

On leaves of *Trillium sessile*, Berkeley, Cala., April 2, 1894 (W. C. Blasdale, No. 212).

Spots amphigenous, scattered, small (1-2 mm.), dirty white, leaf becoming yellowish around them, finally subconfluent causing the leaf to wither and die.

Acervuli epiphyllous, rather large, yellowish, erumpent, often only one in the center of the spot. Conidia oblong-cylindrical, slightly curved, 10-15 (mostly 10-12) x 2 $\frac{1}{2}$ -3 $\frac{1}{2}\mu$.

Glæosporium serotinum E. & E.

On leaves of *Prunus serotina*, Smyrna, Del., June, 1894 (A. Commons, No. 2,439).

Spots suborbicular, 3-10 mm. diam., deep brick-red, definite, soon confluent covering the entire leaf which is then of a deep red-brick color. Acervuli amphigenous, numerous, flesh color. Conidia oblong, straight, obtuse, 12-15 x 4-5 μ .

Differs from *G. prunicolum* E. & E. (J. M. III., p. 129) principally in the much larger conidia.

Myxosporium seriatum E. & E.

On maple bark, Nuttallburg, West Va., June, 1894 (L. W. Nuttall, No. 523).

Nuclei pallid, orbicular, about 1 mm. diam., seated on the surface of the inner bark; surrounded by a thin layer of smoky colored radiating hyphæ from the inner extremities of which the botuliform or oblong, $6-8 \times 2-2\frac{1}{2}\mu$, hyaline conidia are produced. The nuclei are seriatly arranged, and the pale flesh-colored, flattish cirrhi are erumpent through narrow, longitudinal cracks in the bark.

Myxosporium platanicolum E. & E.

On dead limbs of *Platanus*, Nuttallburg, West Va., April, 1894 (L. W. Nuttall, 467).

Acervuli subcutaneous, vesiculoid, pale, 1 mm. diam., raising the ruptured epidermis into pustules but not erumpent. Sporules oval or oblong-ovate, hyaline, nucleate at first, $10-12 \times 5-6\mu$, on stout basidia.

Colletotrichum Rhexiæ E. & E.

On leaves of *Rhexia Virginica*, Kimensi, Del., Aug. 25, 1894 (Commons, No. 2,534).

Spots orbicular, small (1-2 mm.), dirty white with a reddish-purple border. Acervuli mostly epiphyllous, spheriæform, erumpent, 250-350 μ diam., surrounded or clothed with black bristle-like hairs, $60-70 \times 3-3\frac{1}{2}\mu$. Sporules oblong, obtuse, binucleate, about $12 \times 4\mu$, and very short basidia.

Cylindrosporium Cratægi E. & E.

On leaves of *Cratægus*, Nuttallburg, West Va., July, 1894 (L. W. Nuttall, No. 571).

Leaves more or less mottled with rusty red, at length uniformly of this same color. Acervuli innate, erumpent on both sides, and whitening the surface of the leaf with abundantly discharged conidia, which are $75-100 \times 3-3\frac{1}{2}\mu$, nearly straight, or more or less undulate and curved, nucleate, and faintly 3-5-septate.

Cylindrosporium ulmicolum E. & E.

On leaves of *Ulmus alata* Starkville, Miss., Nov. 1893 (Prof. S. M. Tracy).

Acervuli numerous, small, pale, buried in yellowish, faded areas of the leaf, visible from above, but erumpent below. Conidia cylindrical, moderately curved, slightly narrowed toward the ends, hyaline, multinucleate, 45-65 x 4 μ , expelled in small white tufts, on the lower side of the leaf.

Melanconium stenosporum E. & E.

On bark of *Carya*, Ohio (Morgan, No. 1,002).

Stroma subcuticular, sunk in the surface of the inner bark, orbicular, 1½-2 mm. diam., convex, white inside, but covered by a layer of the narrow, brown, oblong, slightly curved, 13-15 x 3-4 μ . Conidia, which are erumpent in black, hemispherical, finally flattened heaps or masses 1-2 mm. diam.

Melanconium acerinum E. & E.

On dead limbs of *Acer mucrophyllum*, Pasadena, Cal. (Prof. A. J. McClatchie).

Acervuli buried in the bark, convex, orbicular, 1-1½ mm. diam., raising and rupturing the epidermis. Conidia ovate, nearly opaque, 20 x 15 μ .

Marsonia Wyethiæ E. & E.

On leaves of *Wyethia glabra*, Santa Rosa, Cal., May, 1894 (W. C. Blasdale).

Acervuli amphigenous, but mostly hypophyllous, small (65-75 μ), orbicular, erumpent, nearly white at first, becoming flesh color, crowded in small, angular patches, mostly limited by the veinlets of the leaf, which in these places soon becomes brown, the brown color finally spreading over a great part of, or over the entire leaf. Conidia oblong-ovate, hyaline, uniseptate, scarcely constricted, 18-27 x 10-13 μ .

Marsonia Fraseræ E. & E.

On leaves of *Fraseria thyrsiflora* Latah Co., Idaho, July, 1892 (C. V. Piper, No. 133).

Spots orbicular, yellowish-brown, ½-1 cm. or more diam., with a broad, dark colored border. Acervuli scattered irregularly on the spots, erumpent above, 150-200 μ diam., pale. Conidia oblong-cylindrical, hyaline, uniseptate and more or less constricted at the septum, 12-20 x 5-6 μ , ends obtuse.

Marsonia Veratri E. & E.

On leaves of *Veratrum Californicum*, Pullman, Washington, Aug. 1893 (C. V. Piper, No. 158).

Spots amphigenous, small (2-3 mm.), whitish, with a broad, dull-purple border, which is often elongated in the direction of the veins of the leaf for 2-3 cm., with the ends acute, finally more or less confluent, the entire leaf becoming brown and dead. Acervuli small, occupying the centre of the spots, or irregularly scattered over them. Conidia clavate-cylindrical, curved, upper end subtruncate, lower end attenuated and subacute, uniseptate, hyaline, $18-22 \times 3-3\frac{1}{2}\mu$.

This is not to be confounded with *Cylindrosporium veratrinum* Sacc. & Winter, or with *Asochyta veratrina* E. & E.

Pestalozzia zonata E. & E.

On decaying fruit of *Cydonia*, Newfield, N. J., Sept. 1890.

Acervuli subepidermal, punctiform, black, raising the cuticle into small pustules, scattered on concentrically zoned, decaying spots on the fruit. Conidia fusoid, 4-septate, slightly constricted at the septa, the two end cells conical and hyaline, the apical one crowned with a spreading crest of three hyaline bristles $15-25\mu$ long, the two cells next below quite dark, so as to obscure the septum between them, the cell next below these nearly hyaline. Pedicels very short.

Pestalozzia Polygoni E. & E.

On living leaves of *Polygonum Virginianum* Stanton, Del., Aug. 1894 (Commons, No. 2,560).

Spots dull brick-red, very irregular in shape and size, mostly elongated $2-10 \times 1-4$ mm., definite, but without any colored border. Acervuli punctiform, black, suberumpent, epiphyllous, scattered. Conidia cylindrical or fusoid-cylindrical, pale, 3-4-septate and more or less constricted at the septa (which are often indistinct, $18-22 \times 4\mu$, end cells rounded, lower one with a short, slender pedicel, upper one bearing a crest of three, spreading bristles $10-15\mu$ long.

Pestalozzia toxica E. & E.

On leaves of *Rhus Toxicodendron*, Nuttallburg, West Va., Aug. 1894 (L. W. Nuttall, No. 567, partly).

Spots and perithecia as in *Phyllosticta rhoicola* E. & E. Sporules clavate-oblong, 4-septate, $12-15 \times 4-5\mu$, 3 intermediate cells pale brown, end cells short, conical, hyaline, the upper cell with a crest of 3, short, spreading hyaline bristles $6-7\mu$ long. Distance between the two extreme cells 12μ . Pedicels shorter than the spores.

Coryneum cupulatum E. & E.

On dead limbs of *Tsuga Canadensis*, Nuttallburg, West Va., Dec. 1893 (L. W. Nuttall, No. 272).

Erumpent superficial. Acervuli tuberculiform, black, 1-1½ mm. diam., hollowed out so as to be cup-shaped above. Conidia clavate, sessile, 6-9-septate, brown, 60-80 x 12-15 μ .

Coryneum abietinum E. & E.

On bark of fir trees, Exploits, Newfoundland, May, 1894 (Rev. A. C. Waghorn, No. 35).

Acervuli erumpent, flat, brownish-black, 1½-3 mm. across, surrounded by the upturned epidermis. Conidia pale brown, fusoid-oblong, 3-4-septate, about 20 x 10 μ , on pedicels of about the same length.

* * * * * **HYPHOMYCETES.**

Botrytis torta E. & E.

On dead leaves of *Carex Fraseri*, Nuttallburg, West Va., Dec. 1894 (L. W. Nuttall, No. 257).

Hyphæ simple, sparingly branched, twisted above as in *B. streptothrix* or in *Streptothrix atra* B. & C., brown, 80-100 x 3-4 μ , forming numerous small brownish-black tufts, effused or gregarious, on both sides of the leaf. Conidia elliptical, brown, 5-6½ x 3-3½ μ .

Differs from *B. streptothrix* (C. & E.) in its much smaller conidia and more dwarfish growth.

Ovularia Vancouveriæ E. & E.

On leaves of *Vancouveria hexandra*, Cazadero, Cala., May, 1894 (W. C. Blasdale, No. 213).

Spots amphigenous, angular, limited by the veinlets, 1-2 mm. diam., dark brown above, paler below. Hyphæ hypophyllous, fasciculate, simple, 30-35 x 3 μ , appearing like a white, pruinose coating. Conidia varying from acutely elliptical, to oblong, and from 10-20 x 4-6 μ .

Not to be confounded with *O. Berberidis*, Cke.

Ramularia Castilleiæ E. & E.

On leaves of *Castilleia miniata*, Mts. of Skamania Co., Wash., Aug. 10, 1886 (W. N. Suksdorf, No. 288).

On subferruginous, indefinite spots, 2-3 mm. diam. Hyphæ hyaline, simple, mostly thickened above, 15-25 x 3-4 μ , arising from a tubercular base from which they project on all sides, forming light flesh colored, sphaeriaform tufts and bearing at their tips the narrow-elliptical, oblong, or cylindrical, hyaline, continuous or uniseptate, 15-25 x 3-4 μ conidia.

The *Ramularia* occupies the central part of the spots and is surrounded by subprominent, black, small, immature perithecia with which it appears to be generically connected.

***Ramularia Psoraleæ* E. & E.**

On leaves of *Psoralea macrostachya*, Ukiah, Mendocino Co., Cal., May, 1894 (W. C. Blasdale, No. 221).

Spots small, round, pale rusty brown, 1–2 mm. diam. Hyphæ fasciculate, simple or sparingly branched above, hyaline, becoming brownish, continuous or faintly 1–3-septate, subgeniculate above. Conidia fusoid, hyaline, uniseptate and often slightly constricted, rather abruptly narrowed at the ends, $12-30 \times 3-3\frac{1}{2}\mu$.

***Ramularia contexta* E. & E.**

On living leaves of *Menispermum Canadense*, Ann Arbor, Mich., Aug. 1885 (Prof. V. M. Spalding).

Hyphæ slender, hyaline, interwoven, so as to form a thin subseparable, web-like, layer, subangular in outline, 1–2 mm. across, dirty white at first, becoming whiter and thicker. Fertile hyphæ erect, $15-25 \times 2-2\frac{1}{2}\mu$, continuous, mostly simple. Conidia clavate-fusoid, hyaline, continuous at first, becoming 1-septate, $8-15 \times 2-3\mu$.

Has something the aspect of *Erineum*.

***Helicoma monilipes* Ell. & Johnson.**

On oak bark, Ann Arbor, Mich., Oct. 1893 (L. N. Johnson, No. 666).

Cespitose, in minute, punctiform, brown tufts, about $\frac{1}{2}$ mm. diam., appearing under the lens like minute flattened perithecia of about the same color as the bark. Creeping hyphæ nearly obsolete; fertile hyphæ cespitose, erect, nearly hyaline, irregularly or subdichotomously branched above, closely septate and constricted at the septa so as to appear submoniliform, $40-50 \times 3-4\mu$. Conidia terminal, or becoming lateral by the prolongation of the hyphæ, pale brown, closely and permanently involute, forming a coil $12-15\mu$ diam., the cylinder or thread which forms the coil being $3-4\mu$ thick and coiled about $1\frac{1}{2}$ times.

***Chætopsis roseola* E. & E.**

On oak bark, Ann Arbor, Mich., March, 1894 (L. N. Johnson, No. 156).

Mycelium inconspicuous or none. Fertile hyphæ simple, erect, straight, septate, subulate, paler and attenuated above, $200-250\mu$.

long, brown. Branches issuing from the middle portion of the hyphæ, spreading, simple or 2-3-parted, hyaline at first, becoming brown, $15-30 \times 2\frac{1}{2}\mu$, faintly septate, bearing at their tips the cylindrical, hyaline, straight; obtuse, 3-4-nucleate, $8-10 \times 1\frac{1}{2}-2\mu$ conidia.

The effused hyphæ appear like a thin, pale rose-colored pubescence on the bark.

Closely allied to *C. stachyobola* Sacc., but the color is different, the branches often divided and the hyphæ not perceptibly swollen at the base.

Stachyliidium caricinum E. & E.

On dead leaves of *Carex Fraseri*, Nuttallburg, West Va., Feb. 1894 (L. W. Nuttall, No. 335).

Hyphæ fasciculate, brown, septate, $600-700 \times 3\frac{1}{2}\mu$, simple or occasionally forked above, towards the top, with short-cylindrical, hyaline branches opposite or in whorls of three, bearing at their tips the elliptical, hyaline, $4-5 \times 1\frac{1}{2}-2\mu$ conidia, collected into a globose head $10-12\mu$ diam.

Coniosporium microsorum E. & E., n. sp.

On dead herbaceous stems (*Senecio triangularis*), Medicine Bow Range, Colo., July, 1894 (Prof. C. S. Crandall, No. 23).

Acervuli at first covered by the thin epidermis, soon erumpent, 1-3 mm. diam., black, consisting of a mass of minute (3μ), globose, olive-brown, conidia.

Torula (*Trachytora*) *sporodesmoides* E. & E.

On bark of dead limbs, Pasadena, Cal., Jan. 1894 (Prof. A. J. McClatchie, No. 622).

Pulvinate or subeffused, pulvinuli, hemispherical, sooty black, $\frac{1}{2}-\frac{3}{4}$ mm. diam. Creeping mycelium scanty, hyaline at first, sending up short, fertile branches, from which the concatenate conidia are formed by constriction. Conidia elliptical, $8-10 \times 5-6\mu$, uniseptate but not constricted, yellowish-brown at first, becoming nearly opaque and distinctly roughened. Often where 2 or more threads lie in contact, the cells of the different threads become laterally connate, forming irregularly shaped aggregations of conidia resembling *Sporodesmium*.

This differs from *T. dimidiata* Penz. in the uniseptate, rough conidia.

Fusicladium Staticis E. & E.

On living leaves of *Statice Limonium*, Cape May, N. J., Sept. 1894 (Commons, No. 2,565).

Spots orbicular, 2-5 mm. diam., purplish at first, then rubiginous with a purplish border, becoming paler in the center and finally subdeciduous. Hyphæ epiphyllous, fasciculate. 40-60 x 4 μ , brown, septate, subgeniculate above. Conidia oblong with the ends obtusely pointed, subolivaceous, 1- (exceptionally 2-) septate, 10-16 x 3-4 μ .

The tufts of hyphæ are crowded in the central part of the spots.

Fusicladium Aplectri E. & E.

On leaves of *Aplectrum hyemale*, Naaman's Creek, Del., Apr. 1894 (Commons, No. 2,408).

Spots irregular, whitish, with a shaded, purple border, 1 cm. diam. Hyphæ fasciculate, olivaceous, simple, 2-3-septate, 65-75 x 5-6 μ , mostly twisted or abruptly bent at the tips, olive-brown. Conidia terminal, elliptical, greenish, granular, continuous at first, becoming 1-septate, 12-15 x 6-7 μ .

Cladosporium aterrimum E. & E.

On rotten wood, Rockport, Ks., Nov. 1893 (Bartholomew, No. 1,256).

At first deusely tufted, tufts soon effused, forming an olive-black, velvety stratum 1 or more cm. in extent. Fertile hyphæ slender, sparingly septate, 100-150 x 2½ μ , nearly straight, simple. Conidia terminal, at first elliptical, 3-5 μ long and continuous, then oblong-cylindrical, uniseptate, 5-7 x 2½ μ , ends obtuse. Probably the subiculum of some *Pyrenomycete*.

C. lignatile Schw. is said to have the hyphæ very short ("brevis-simis").

Cercospora (Cercospora) albomaculans E. & E.

On leaves of *Brassica campestris*, Berkeley, Cal., Feb. 1894 (W. C. Blasdale, No. 201).

Spots suborbicular, white with a narrow, darker margin, ½-1 cm. diam. Hyphæ amphigenous, tufted, short, 8-12 x 2 μ , hyaline, continuous. Conidia cylindrical, hyaline, straight or slightly curved, of about equal thickness throughout, 40-65 x 2-2½ μ , becoming faintly 3-septate. The tufts are very minute.

Distinguished from the other species on *Cruciferae* by its large white spots and cylindrical conidia which resemble the sporules of *Septoria*.

Cercospora (Cercosporella) Fraseræ E. & E.

On leaves of *Fraseria speciosa*, mountains west of Bear Valley, Colo., July, 1894 (Prof. C. S. Crandall, No. 65).

Spots large ($\frac{1}{2}$ –1 cm.), pale brown with a narrow, black border. Hyphæ in scattered tufts, appearing under the lens like minute, pale white granules, continuous, hyaline, 15–20 x 3 μ . Conidia gradually attenuated above, hyaline, faintly 1–4-septate, 80–110 x 3–3 $\frac{1}{2}$ μ .

The general appearance is about the same as that of *Marsonia Fraseræ* E. & E., but this is quite a different thing.

Cercospora Borreria E. & E.

On leaves of *Borreria micrantha*, Biloxi, Miss., July, 1893 (Prof. S. M. Tracy).

Hypophyllous. Tufts effused, forming a thin, olivaceous coating. Hyphæ slender, undulate or crisped and geniculate, 100–120 x 3–3 $\frac{1}{2}$ μ , brown, nucleate and indistinctly and sparingly septate. Conidia slender lanceolate, hyaline, 3–5-septate, 35–45 x 3–3 $\frac{1}{2}$ μ .

Cercospora ribicola E. & E.

On leaves of *Ribes sanguineum*, Seattle, Wash., Aug. 1893 (C. V. Piper, No. 81).

Spots numerous, subangular and partly limited by the veinlets, definite but without any distinct border, red-rusty brown, 2–4 mm. diam. Tufts mostly epiphyllous, sphaeriæform, not effused, appearing like small, clustered, superficial perithecia. Hyphæ densely fasciculate, pale brown, continuous, simple 25–35 x 3 $\frac{1}{2}$ –4 μ . Conidia lanceolate, hyaline, nucleate and 1–3-septate, 35–80 x 3–4 μ .

Quite different from *C. marginalis* Thum. Well characterized by its red-brown spots and sphaeriæform tufts of hyphæ.

Cercospora Cirsii E. & E.

On *Cnicus remotifolius*, Skamania Co., Wash., Aug. 1886 (W. N. Suksdorf, No. 291).

Spots dark brown, paler below, suborbicular, 3–5 mm. diam. or by confluence irregular and larger, often marginal, definite. Hyphæ epiphyllous, tufted, the small black tufts thickly covering the spots, short, simple, pale brown, nearly entire, 15–30 x 3 $\frac{1}{2}$ –4 μ . Conidia slender, hyaline, 4–6-septate, 50–80 x 3 $\frac{1}{2}$ μ .

Cercospora Baccharidis E. & E.

On *Baccharis Douglasii*, Berkeley, Cal., June, 1894 (W. C. Blasdale, No. 254).

Tufts effused, at first on irregular areas of the green leaf, partly bounded by the veinlets, the part of the leaf occupied soon becoming brown and dead. Hyphæ densely cespitose, simple, hyaline, mostly continuous, $25-40 \times 5\mu$. Conidia cylindrical, hyaline, obtuse at the ends, 1-3-septate, often constricted at the septa. The tufts of hyphæ are of a pale rose color, nearly white and are found on both sides of the leaf.

Cercospora melanochæta E. & E.

On leaves of *Celastrus scandens*, Louisville, Kansas, Oct. 1893 (E. Bartholomew, No. 1, 210).

Spots amphigenous, slaty black, with the center whitish and the margin shading off into rusty brown, suborbicular, $\frac{1}{2}-1$ cm. diam. Hyphæ dark brown, septate, subundulate above, $40-60 \times 3\frac{1}{2}-4\mu$, forming dense sphaeriæform, tobacco-brown tufts on the whitish center of the spots on both sides of the leaf. Conidia clavate-cylindrical, brown, 3-5-septate, $40-70 \times 4-5\mu$. The dark part of the spots, especially below is covered with numerous, black, sterile perithecia.

Cercospora columnare E. & E.

On dried up leaves of *Phaseolus* (cult.), Newfield, N. J., Sept. 1894.

Amphigenous but mostly hypophyllous. Hyphæ erect, fasciculate, forming a compact bundle or tuft like *Isariopsis*, $150-230 \times 4\mu$, brown, sparingly septate. Conidia oblong-cylindrical, 1-5-septate, not constricted, brownish, mostly a little curved, $40-60 \times 5-6\mu$.

C. Phaseolorum Cke. is said to have the hyphæ short ("abbreviatis") which can hardly apply to this.

Cercospora Enotheræ E. & E.

On leaves of *Enothera biennis*, Nuttallburg, West Va., Oct. 1894 (L. W. Nuttall, No. 599).

Spots irregular, mostly elongated, grayish-brown, subangular, $3-5 \times 2-3$ mm., subconfluent. Hyphæ amphigenous, subhyaline, continuous or faintly 1-2-septate, $15-20 \times 3\mu$, in minute scattered tufts, few in a tuft, spreading, subundulate. Conidia linear or only slightly attenuated above, smoky-hyaline, nucleate and faintly 3-5- or more-septate, $25-80 \times 2-2\frac{1}{2}\mu$, straight or only slightly curved.

Cercospora Merrowi E. & E.

On *Isopyrum bitermum*, Ann Arbor, Mich., Oct. 1893 (Harriet L. Merrow).

Hypophyllous, on dead blackened parts of the leaves. Hyphæ loosely tufted, subeffused, simple, clavate, continuous, 15-30 x 4 μ , yellowish to the naked eye, nearly hyaline under the microscope. Conidia, 1-3-septate, hyaline, 15-60 x 4-6 μ .

The shorter ones are cylindrical and mostly 1-septate, and resemble the conidia of *Ramularia Actææ*, but the longer ones are narrowed above and 3-(or more-)? septate.

Cercospora Briareus E. & E.

On leaves of *Acerates viridiflora*, near Elkton, Md., Aug. 1894 (Commons, No. 2,537).

Spots amphigenous, dull livid-purple, small, subelongated, 1-3 x 1 mm., subindefinite or partly limited by the veinlets. Hyphæ amphigenous, loosely tufted, spreading, subundulate, simple, equal, olive-brown, continuous or 1-3-septate, obtuse, 35-45 x 5-6 μ . Conidia slender, 40-80 x 3 $\frac{1}{2}$ -4 $\frac{1}{2}$ μ , 6-8-septate, nearly straight, slightly brownish.

The spots, especially on the under side of the leaf are not perceptible; the hyphæ spreading over green areas of the leaf enclosed by the veinlets.

Heterosporium caulicolum E. & E.

On dead stems of *Rumex occidentalis*, North Park, Colo., July, 1894 (Prof. C. S. Crandall, No. 72).

Tufts effused. Hyphæ cespitose, stout, olive-brown (under the microscope), septate, torulose, subgeniculate above, 80-110 x 4-5 μ . Conidia elliptical or oblong, pale yellowish-brown, 1-3-septate, 12-26 (mostly about 15) x 7-10 μ , minutely echinulate-roughened. Appears like a coarse, black pubescence on the stems.

Heterosporium sphæriæforme E. & E.

On dead stems of *Eriogonum*, Fort Collins, Colo. (C. F. Baker, No. 270).

Hyphæ as in *H. caulicolum* E. & E. but not as rigid and collected in dense, scattered, olivaceous, sphæriæform, tufts $\frac{1}{2}$ - $\frac{1}{2}$ mm. diam., resembling a *Puccinia* or *Sphæria*. Conidia elliptical or oblong, 1-4- (mostly 1-2-) septate, 12-30 x 8-12 μ , minutely echinulate-roughened, pale yellow-brown.

Heterosporium Eucalypti E. & E.

On dead leaves of *Eucalyptus*, California, Nov. 1893 (A. J. McClatchie, No. 542).

Hypophyllous, forming small (1-2 mm.), olive-black, orbicular patches scattered over the lower side of the leaf. Hyphæ subfasciculate-effused, pale yellowish-brown, continuous or sparingly septate, 70-80 x 4-5 μ , geniculate-subundulate, slightly swollen at the tips. Conidia oblong-elliptical, 1-2-septate, pale yellowish, echinulate, 15-27 x 10-12 μ .

Heterosporium eladosporioides E. & E.

On brown paper exposed by the roadside, Ann Arbor, Mich., May, 1894 (L. N. Johnson, No. 1,599).

Maculiform. Hyphæ erect, subfasciculate, brown, 90-110 x 4-5 μ , septate, subundulate or subnodulose above. Conidia terminal, hyaline and continuous at first, then pale brown and minutely echinulate, 1-2-septate, 10-16 x 5-7 μ not constricted.

The hyphæ form small black scattered patches about 2 mm. diam.

Heterosporium Trillii E. & E.

On leaves (partly dead) of *Trillium ovatum*, Latah Co., Idaho, July, 1893 (C. V. Piper, No. 128).

Spots at first suborbicular, gray with a whitish margin, soon confluent, overrunning and killing the leaves, which then become rusty brown. Hyphæ fasciculate, short, 30-50 x 5-6 μ , variously toothed and shouldered above and more or less crooked, sparingly septate. Conidia oblong-cylindrical, 12-30 x 5-8 μ , 1-3-septate, minutely echinulate, yellow-brown.

Macrosporium hybridum E. & E.

On bark of decaying *Sambucus glauca*, Pullman, Wash., Oct. 1893 (C. V. Piper, No. 151).

Forming black, subelongated patches or irregularly scattered. Hyphæ cepitose, olive-brown, coarse, 100-110 x 6-7 μ , geniculate and subtorulose above, finally closely septate. Conidia variable; at first oblong-elliptical and mostly uniseptate, 8-15 x 5-7 μ , pale yellowish-brown, then oblong, 2-3-septate and constricted, granular, 12-25 x 8-12 μ . Other conidia are globose, 12-15 μ , sarcinuliform, with two septa crossing each other at right angles, others again broad-clavate, 5-9-septate and muriform, 50-70 x 12-15 μ .

The members of this genus are so variable that we have ventured to describe only forms with marked and recognizable characters.

Macrosporium iridicolum E. & E.

On leaves of *Iris Missouriensis*, Moscow, Idaho, May, 1894 (Prof. L. F. Henderson, No. 2,640).

Hyphæ short, tufted, obovate-oblong, continuous, 12-15 x 5-6 μ , pale yellowish. Conidia clavate, 5-10-septate and muriform, 40-120 x 20-25 μ , including the stout, cylindrical, persistent stipe. It is possible that what we have taken for hyphæ are tufts of young conidia; if so, the conidia are sessile. This is quite distinct from *Macrosporium Iridis* C. & E.

The tufts are at first scattered and distinct but finally confluent, forming pulverulent black patches consisting entirely of the free conidia.

Macrosporium Pelargonii E. & E.

On leaves of *Pelargonium* (cult.), Pasadena, Cal., Feb. 1894 (Prof. A. J. McClatchie).

Spots orbicular, 1-3 mm. diam., greenish at first, then rusty brown, with a narrow, raised margin causing them to appear discoid. Hyphæ amphigenous but more abundant above, effused or sparingly fasciculate, yellow-brown, erect, 2-3-septate, swollen at the tips, 25-30 x 5-6 μ , bearing the terminal, obovate, or subquadrate, 3-septate, and muriform, 20-30 x 18-22 μ conidia, which are mostly constricted at the middle septum and have no pedicel.

Macrosporium tabacinum E. & E.

On leaves of tobacco, North Carolina, Oct. 1891 (Prof. Gerald McCarthy), Missouri (Miss Clendinin).

Spots amphigenous, numerous, small, irregular or suborbicular, definite, thin, white, with a narrow, raised margin, 1-3 mm. diam. Hyphæ amphigenous, fasciculate, tufts effused, septate, geniculate above, ferruginous-brown, 30-50 x 3-4 μ , crooked and spreading. Conidia obovate-clavate, stipitate, 3-9-septate and muriformly divided, 50-90 x 10-15 μ . The smaller conidia are often without any stipe, while the larger ones have a persistent stipe from 8-25 μ long.

This is closely allied to *M. condatum* C. & E. It is called by the planters "white speck," and with *Phyllosticta tabaci* Pass. is very injurious to the plants.

Macrosporium olivaceum E. & E.

Parasitic on *Sphaeropsis Asimina* E. & E., on dead limbs of *Asimina triloba*, Nuttallburg, West Va., March, 1894 (L. W. Nuttall, No. 388).

Forms a light olive, velutinous coat over the pustules of the

Sphaeropsis. Hyphæ tufted, yellowish-brown (under the microscope), septate, erect, nearly straight or subundulate, 80–100 x 4–5 μ . Conidia obovate or obpiriform, 3–5-septate and muriform, brown, 24–38 x 15–20 μ , terminal, sessile. Conidia also occur subcubical or subglobose, 15–20 μ diam. with 2-septa crossing each other at right angles.

Sporodesmium fructigenum E. & E.

On decaying apples, Las Cruces, New Mexico, Oct. 1893 (E. W. Wooton).

Appears like a thin, dark colored, velvety coating, appearing first around the stem end but finally spreading over the greater part of the apple. Conidia subglobose or elliptical, stipitate, yellowish and uniseptate at first, finally nearly opaque and muriform, 12–26 μ in the longer diameter.

The conidia have a berry-like structure like that of *S. Ravii* E. & H. or *S. moriforme* Pk. The pedicels, which are 12–15 x 3 μ are deciduous.

Sporodesmium subcupulatum E. & E.

On dead *Sambucus melanocarpa*, Cameron Pass, Colorado, July, 1894 (C. F. Baker, No. 236, partly).

At first tuberculiform, minute, $\frac{1}{3}$ – $\frac{1}{2}$ mm. diam., erumpent and surrounded by the ruptured epidermis, becoming concave and often oblong 1–2 mm. long, $\frac{1}{2}$ – $\frac{3}{4}$ mm. wide, slaty black; conidia olivaceous, muriform, subglobose, 10–15 μ diam., or subelliptical or clavate-oblong, 20–30 x 10–12 μ , sessile or with a short, thick pedicel. In the concave stage the acervuli and conidia are paler.

Sporodesmium tuberculiforme E. & E., n. sp.

On dead stems of *Sambucus racemosa*, near Rabbit Ear Pass, N. W. Colo., alt. 10,000 ft., July, 1894 (Prof. C. S. Crandall, No. 15).

Sporodochia tuberculiform, black, inside and out, about 1 mm. diam., flattened above. Conidia irregular in shape and variable in size, subcubical, subglobose, subelliptical, consisting of 2–20 subglobose cells variously conglomerated so as to form the conidia 8–20 μ diam.

The tubercular mass consists almost entirely of the compacted conidia which are more perfectly developed in the superficial layer.

Podosporiella E. & E., n. gen. of *Phæostilbeæ Phragmosporæ*.

Stroma cellular, soft, not carbonaceous, short-cylindrical. Hyphæ short, simple, arising from all parts of the stroma. Conidia terminal, oblong or cylindrical, brown, 2- or more-septate.

Differs from *Podosporium* in its simple, cellular stroma (stipe).

Podosporiella humilis E. & E.

On leaves of *Garrya Veitchii*, Echo Mt., Cala., July, 1894 (Prof. A. J. McClatchie, No. 736).

Spots orbicular, brown, with a definite, dark margin 2-4 mm. diam. Stromata hypophyllous, scattered on the spots, black, short-cylindrical, or conic-cylindrical, about 1 mm. high and $\frac{1}{2}$ mm. thick, of membranaceo-cellular structure. Hyphæ spreading on all sides from the stroma, pale brown, simple, continuous, $15-20 \times 4-5\mu$, bearing the terminal, solitary, oblong-cylindrical, pale-brown, uni-septate at first, then 2-4-septate, $15-27 \times 6-7\mu$ conidia.

Illosporium cæspitosum E. & E.

On rotten wood, Nuttallburg, West Va., Dec. 1893 (L. W. Nuttall, No. 231).

Sporodochia globose, $100-110\mu$ diam., cespitose, forming tufts about 1 mm. diam. Hyphæ $6-8\mu$ thick, branched, the branches curved or tortuous. Conidia globose or ovate $6-12\mu$ diam.

Differs from *I. coccinellum* Cke. in its color, and larger, cespitose sporodochia.

Illosporium album E. & E.

On cypress bark, Louisiana (Langlois, No. 284).

Sporodochia gregarious, milk-white, ovate, $140-160 \times 100-110\mu$. Hyphæ imperfectly defined, free and mostly curved above, united below into a coarsely cellular, mass. Conidia peripheral, sub-globose, $8-10\mu$ diam.

Differs from *I. pallidum* Cooke, in its smaller sporodochia, imperfectly defined hyphæ, and milk-white color.

Trichægum nodulosum E. & E.

On dead leaves of *Carex Fraseri*, Nuttallburg, West Va., Feb. 1894 (L. W. Nuttall, No. 333).

Erumpent, tufted, becoming subeffused, black, tufts gregarious forming subvelutinous patches 2-4 mm. across, or when standing singly, the hyphæ and conidia forming a compact mass, $\frac{1}{2}-1$ mm. diam., and resembling somewhat the sorus of a *Puccinia*. Hyphæ simple, sparingly fasciculate, brown, septate, often swollen at the

septa, about 4μ thick and 200–300 μ long. Conidia near the base of the hyphæ, at first elliptical, yellowish-hyaline, uniseptate $8-10 \times 6-7\mu$, soon becoming 4–6-septate, muriform and opaque, $10-25\mu$ diam., subglobose, obovate, or elliptical.

Pilacre gracilipes E. & E.

On rotten wood, Nuttallburg, West Va., Dec. 1893 (L. W. Nuttall, No. 274).

Scattered, stem slender, white-pruinose, 3 mm. long, $\frac{1}{4}-\frac{1}{3}$ mm. thick. Head subhemispherical, olivaceous, about 1 mm. diam. Fertile hyphæ hyaline, dichotomously branched, $2-2\frac{1}{2}\mu$ thick, bearing the conidia laterally. Conidia globose or subglobose, yellow-brown under the microscope, $4-5\frac{1}{2}\mu$ diam.

Smaller and of a more slender growth than *P. Petersii* B. & C.

Tubercularia hamata E. & E.

On dead limbs of *Celtis occidentalis*, Nuttallburg, West Va., Feb. 1894 (L. W. Nuttall, No. 313).

Depressed-hemispherical, umbonate, soon becoming black, $\frac{1}{2}-1\frac{1}{2}$ mm. diam. Conidia oblong, slightly curved, hyaline, $5-8 \times 1\frac{1}{2}-2\mu$, on slender, simple sporophores 30–40 μ long, incurved or involute at the tips.

Hymenula cerealis E. & E.

On wheat straw, Nuttallburg, West Va., May, 1894 (L. W. Nuttall, No. 495).

Sporodochia gelatinous, orbicular, yellowish-amber color, becoming darker, at first subpulvinate, becoming depressed or flattened, $\frac{1}{2}-\frac{3}{4}$ mm. diam. Basidia slender, $25-30 \times 1\frac{1}{4}\mu$, simple or oftener branched, the branches erect. Conidia hyaline, oblong, minute, $3-4 \times 1-1\frac{1}{4}\mu$.

Microcera erumpens E. & E.

On dead limbs of *Tsuga Canadensis*, Nuttallburg, West Va., Feb. 1894 (L. W. Nuttall, No. 371).

Sporodochia depressed-globose, $\frac{1}{2}$ mm. diam., at first covered by the epidermis, soon exposed and bare, orange-red, at length disappearing and leaving cup-shaped cavities in the bark. Conidia falcate, nucleate and finally 3- or more-septate, $75-83 \times 3-4\mu$, hyaline, borne on short (20–35 μ) sporophores which are more or less branched above.

Differs from *M. coccophila* Desm. in the shape of the sporodochia and their subcuticular origin.

NOTES ON THE MAMMALS OF MONROE AND PIKE COUNTIES,
PENNSYLVANIA.

BY SAMUEL N. RHOADS.

We have much to learn respecting the mammal fauna of the most densely populated and longest settled districts of the United States. To no region is this remark more applicable than the States of Pennsylvania and New Jersey. In the *American Naturalist* for January, 1893, Mr. Witmer Stone and myself recorded the capture of two new species belonging to genera hitherto unknown to the fauna of New Jersey, and later Mr. Stone described a Cave Rat, belonging to the genus *Neotoma*, from South Mountain, Pennsylvania, which is the first notice we have of the present existence of that genus in the State.

A recent visit to the wilder portions of northeastern Pennsylvania in the interests of natural history enables me to contribute the following notes to our knowledge of the mammals of the region. One week in September was spent at the farm of Mr. Chas. Yaggie, (1,000 ft. alt.), on the west bank of Big Bushkill Creek, in Monroe County, at a point seven miles east of Cresco, where the creek enters the southwestern corner of Pike County. Another week in October was occupied in the vicinity of Dingman's Ferry, Pike County, and for three days I was located at Porter's Lake (1,200 feet alt.), in the same county. Systematic trapping of the smaller mammalia was kept up during my stay at all these localities. On the results of this work and of my inquiries among the woodsmen and older residents of the places visited, the following notes are based. To Dr. Philip Fulmer, of Dingman's Ferry, and Mr. Harvey Eilenberger, of East Stroudsburg, the latter a veteran deer-hunter, whom I had the pleasure of meeting at Porter's Lake, I am chiefly indebted for outside information. The reliability of the statements of these gentlemen on such subjects is unquestionable.

The area covered by my investigations is mainly included in the eastern extension of the Pocono plateau, the average elevation of which, at the points visited, is from 1,000 to 1,500 feet. The greatest

elevation attained was the summit of High Knob, 2,010 feet above the sea; the lowest was at Dingman's Ferry (350 feet), on the Delaware River. The greater part of Porter and Delaware townships have not only been long denuded of their original forests of oak, pine, and hemlock, but have of late years been frequently swept with fire. This fact, combined with the stony character of the soil, gives the country a desolate appearance, and has, undoubtedly, brought about marked changes in the character of its fauna and flora since the advent of the white man. At the present time it is difficult to find, for hundreds of square miles so much as an acre of mature evergreen timber that does not show the ravages of fire and axe. In some places the presence of a watercourse or swamp has retarded these influences and we find a strip of oaks, chestnuts, and pines of comparatively recent growth to relieve the monotony of vast stretches of scrub oak and bushes. Both fauna and flora combine in an interesting manner the features of the Alleghanian, Canadian, and Carolinian life-regions.

The following is a list, with annotations, of those species observed by the writer or reported on by the gentlemen above mentioned:—

1. *Didelphys marsupialis virginiana* (Kerr). Virginian Opossum.

The rare occurrence of this Carolinian species in the fauna of the Pocono plateau of Pike and Monroe counties, even up to an elevation of 1,500 feet is a fact of interest. Specimens have been taken at Porter's Lake. At Dingman's Ferry they are less rare.

2. *Cariacus virginianus* (Bodd.). Virginia Deer.

A buck was killed at Schauff's Pond the first week in October. In spite of the immense range and the sparsely populated condition of the country, the deer are becoming very scarce. Mr. Eilenberger attributes this to the continual destruction of deer by the natives throughout the year, and to the forest fires, which often overtake the newly-born fawns, and in many ways so worry the older deer that they leave the county.

Last year the county newspaper at Milford published its annual authenticated list of deer killed in Pike County during the game season of 1893. They numbered 140.

Mr. Eilenberger thinks a close season of three years and a law to prevent the export of deer for sale would quickly and permanently restock the Pocono wilderness with this noble animal.

3. *Cervus americanus* (Erxl.). Wapiti.

The "Elk" was probably never as numerous in this region as in the central Alleghany Mountains, those individuals taken in former days being considered by the natives as stragglers from the main body. The last capture in Pike County was probably not later than 1840 or 1845.

Remains of the Bison and Caribou found in Hartman's Cave near Stroudsburg, have been described and figured by Dr. Jos. Leidy in the Penna. Geological Report for 1887.

It is very improbable that either species co-existed in this part of Pennsylvania, with Man.

4. *Sciurus carolinensis pennsylvanicus* (Ord). Northern Gray Squirrel.

Very few were seen. They are said to be abundant in certain localities of exceptional food supply. The hunters frequently shoot the melanistic form, which is the original variety on which George Ord based his specific name for the "Small Black Squirrel" of Guthrie's Geography, in 1815.

5. *Sciurus hudsonicus* (Erxleben). Red Squirrel, Chickaree.

Abundant as the sparsely wooded character of the country will permit.

6. *Sciuropterus volans* (L.) Jordan¹. Flying Squirrel.

No specimens of this animal were seen. They are reported as numerous, and more frequently found in nests built among the branches of a pine than in hollow trees. It is very probable that this species on the Pocono mountain is nearer to the typical Virginian form than to *sabrinus* of the Canadian fauna, as in the case of *Tamias striatus* and its subspecies *T. s. lysteri*.

7. *Tamias striatus* (L.). Chipmunk.

In the more mountainous districts the chipmunk is by far the most ubiquitous mammal of its class, the more favorable situations being so thickly tenanted by them as to suggest the Spermophile colonies of the West. They showed no disposition to hibernate up to the last day of my stay (October 14th), though the nights were often frosty.

Pocono chipmunks are referable to typical *striatus* rather than to the Canadian variety, *T. s. lysteri*, which is found in the northwestern parts of Pennsylvania.

¹ See "Manual of the Vertebrates," 1888, p. 324 (foot-note).

8. *Castor fiber canadensis* (Kuhl). American Beaver.

The older residents concur in the opinion that the beaver was exterminated nearly fifty years ago in northwestern Pennsylvania. Their dams and meadows are still pointed out in numerous places along the Bushkill and Dingman's creeks.

9. *Mus rattus* L. Black Rat.

This least offensive member of the Old World Muridæ remains in undisputed possession of the barns and outhouses of the more remote districts, but along the Delaware valley it has given place to the following:—

10. *Mus decumanus* Pallas. Norway Rat.

As in other places where this pest has foothold, the supply far exceeds the demand.

11. *Mus musculus* L. House Mouse.

Well represented.

12. *Neotoma magister* Baird. Alleghany Cave Rat.

Remains of this animal, both fossilized and those apparently quite recent, were taken, in 1880, from Hartman's Cave in Monroe County, by Mr. T. D. Paret, of Stroudsburg.

I have as yet been unable to determine whether this interesting animal is still living in that county or in Pike county. The evidence from every source is negative, and this after the most diligent inquiry.

I personally explored several ledges, notably those of High Knob and the cliffs along the Delaware south of Milford, without finding a trace of their existence. It is not impossible, however, that the recent habitat of this species may be traced, by isolated localities along the Blue Ridge from South Mountain to the Hudson River Highlands. Dr. C. H. Merriam, in a recent communication, states that he believes the specimens of *Neotoma*, taken many years ago on the Hudson near Rockland, New York, to be of this species.

13. *Peromyscus americanus* (Kerr) Thomas.² White-footed Mouse.

Numerous specimens of all ages, taken in three distinctly separated localities, strongly indicate a local variety of this susceptible species, which apparently forms a connecting link between typical Pennsyl-

² See Ann. & Mag. N. H., Nov. 1894, p. 364.

vania americanus and New England examples of *S. a. canadensis*. Their longer tails and lack of a distinct dorsal stripe indicate this.

The Pocono mice are of a more uniform and much duller brown on the upper parts than south Pennsylvania specimens, and in old individuals there is no trace of the dusky dorsal stripe which is so pronounced in specimens from New Jersey and New England. Specimens from Pike County match one in the collection from Lorne Park, Ontario, and three from Clinton County, Pennsylvania.

14. *Fiber zibethicus* L. Muskrat.

Not abundant.

15. *Arvicola pennsylvanicus* (Ord). Common Meadow Mouse.

Abundant, and constant to its typical characters in all situations.

16. *Arvicola pinetorum* (LeConte). Pine Mouse.

A specimen taken at Yaggie's farm, and another at Porter's Lake attest the semiboreal range of this southern species.

17. *Evotomys gapperi* (Vigors). Red-backed Mouse.

A rather rare species. Four captures were made at Yaggie's in the more heavily timbered swamps. This animal does not appear to confine its operations to runways or underground as does the true *Arvicola*, but forages about like *Sitomys* in more open situations at the surface.

I took none at Dingman's Ferry, and am of the opinion they are not found much below an altitude of 1,000 feet in Pike County.

18. *Synaptomys cooperi* Baird. Cooper's Lemming Mouse.

One of these highly interesting rodents was captured in a meadow bordering the Bushkill, on Yaggie's farm. It was taken in a "cyclone trap," set in the runways of *Arvicola pennsylvanicus*, near the edge of a dry swamp. A specimen of the latter species was subsequently taken in the same spot. This is the first authenticated record for Pennsylvania of Cooper's mouse, though it is not improbable that the type was taken within fifty miles of this place, either on that or the New Jersey side of the Delaware.

This, together with recent captures in New England and eastern Canada, may now be considered sufficient to fix the type habitat of Cooper's mouse east of the Alleghany Mountains, rather than west of them as was once considered possible, owing to the total lack of recorded eastern specimens.

In a recent paper, Mr. Outram Bangs³ has endeavored to show that *Synaptomys stonei* described by me from southern New Jersey is a synonym of *S. cooperi*.

A comparison of the three specimens of *stonei*, taken at May's Landing, with individuals taken in New England by Mr. Bangs at the same season of year, show no cranial differences of value. In *stonei*, however, there is a decided difference in the darker colors of the pelage as contrasted with the New England skins and with the skin from Pike County. This is manifested in the blackish-brown of the back and upper head, the sooty feet and tail, and the lead-colored lower parts of *stonei*, contrasted with the gray-brown upper parts, light-brown feet and tail, and hoary under parts of the more northern specimens which, as I had previously inferred, were in all probability taken nearest the type locality of *cooperi*. In these particulars there is a striking correlation with the color differences pointed out by Mr. Stone for his subspecies of *Evotomys gapperi*,⁴ taken in the same bog which furnished the types of *S. stonei*. On these grounds, taking for granted that *S. cooperi* is typified by the form found east of the Alleghany Mountains, I would now refer to the southern New Jersey lemming mouse as *Synaptomys cooperi stonei*.

My original description of *stonei* was drawn up from a comparison with two specimens from Ohio, and, so far as it went, was apparently a sufficient reason for specific separation. It is not impossible that a full series of western specimens will yet indicate the propriety of further division.

19. *Zapus hudsonius* (Zimm.). Meadow Jumping Mouse.

20. *Zapus insignis* Miller. Woodland Jumping Mouse.

I was surprised to neither see nor capture any of these mice during my stay. They had evidently just gone into their winter trance, and the loveliest Indian summer weather failed to rouse them. This is an interesting fact, as only a few days before my stay they had been seen by "mine host," and one of the woodland species (which I was surprised to find he recognized as different from the meadow jumping mouse) was killed by him as it swam across the Bushkill. Mr. Shryock took a specimen of *insignis* on Pocono Mountain in 1893.

³ Proc. Biol. Soc., Washn., 1894.

⁴ Amer. Naturalist, Jan. 1893.

21. *Erethizon dorsatus* (L.). Canada Porcupine.

This is another boreal species whose presence on the Pocono plateau has always been rather precarious, and, with the vanishing forest areas, it has become so rare that it is believed by many hunters to be exterminated. The most active of these gentlemen have not seen any "for several years."

22. *Lepus americanus* Erxl. Varying Hare.

Not uncommon in the higher mountain swamps.

23. *Lepus sylvaticus* Bachm. Rabbit.

Normally abundant in all situations.

24. *Felis concolor* L. Puma, Panther.

A panther, I am assured by Mr. Eilenberger, has not been killed in Pike County for thirty years, all reports to the contrary notwithstanding. From conversation with several hunters it appears that the name "catamount" in this region is applied to any animal, not distinctly seen, which is larger than a wild-cat and has a longer tail, but is smaller than a panther! When a very large or abnormally colored wild-cat is trapped, it also may receive this higher sounding title. The yell of a wild-cat is a fruitful source of "catamount" stories, the horror of such an experience making the use of the commoner name a totally inadequate expression.

25. *Lynx canadensis* (Desm.). Canada Lynx.

Many residents near Porter's Lake assured me that this species is occasionally trapped in that vicinity. The occurrence of the lynx in these parts is not attested by any reliable records known to me.

26. *Lynx rufus* (Guld.). Wild-cat.

Many pelts of this destructive animal are annually taken in both counties.

27. *Canis lupus nubilus* (Say). American Gray Wolf.

I can get no information as to the date of the disappearance of the timber wolf from this part of the State. Conservative residents set it as nearly forty years ago, but it is probable they existed to a much later date.

28. *Vulpes vulpes pensylvanicus* (Bodd.). American Red Fox.

An abundant resident.

29. *Urocyon cinereo-argenteus* (Müll.). Gray Fox.

Occasionally taken by hunters.

30. *Ursus americanus* Pallas. American Black Bear.

Rarely killed, but evidences of their existence are frequently seen in the mountains. They hibernate in severe winters.

31. *Putorius erminea* (L.). Weasel, Ermine.

Specimens of this weasel were examined in the collection of Mr. Justin Nilis, of Edgemere, Pike Co. Two of them were in the white pelage.

32. *Lutreola vison* Schreber. Mink.

Abundant.

33. *Mustela americana* Turton. Pine Marten.

I could hear of no specimens of this former resident having been captured for many years. Of the Pekon, *M. pennanti*, none of the inhabitants had any knowledge.

34. *Lutra hudsonica* Lacép. American Otter.

This fisherman is sufficiently numerous to be a nuisance to the owners of game preserves along the Bushkill. I found one in a trap on the banks of that stream near Yaggie's farm. They are frequently seen in Porter's Lake, and Mr. Van Vliet of that place states that they sometimes devour mussels in the same manner as the muskrat.

35. *Mephitis mephitica* (Shaw). Common Skunk.

Normally abundant. A visit was paid to the farm near Shawnee, in Monroe County, where these animals are being bred for their furs. Unfortunately no one was at home at the time, and I was unable to secure any data respecting the success of this experiment. A neighbor stated that the venture was not profitable and on the decline.

36. *Procyon lotor* (L.). Raccoon.

Stated to be very abundant.

37. ?*Sorex forsteri* Rich. Forster's Shrew.

I refer a small, brown shrew, taken in *Arvicola* runways, in a meadow near woodland, to this species, with some doubt. In its small size and the character of its coloration it agrees well with

Richardson's description. It was taken on the banks of the Bushkill where it crosses the southwestern corner of Pike County. It is similar to several specimens taken in Maine and central Quebec.⁵

38. ?*Sorex* ———.

Four specimens of a rather large, bluish-gray shrew answering Baird's description of *S. forsteri*, one taken at Yaggie's and three on Dingman's Creek, are very distinct from the preceding species in size, color, and habits. The *S. forsteri* of Baird I am convinced is not the same as the *S. forsteri* of Richardson. It is very probable that the four specimens in question are identical with the animal described by Baird as *forsteri*. What name, among the numerous existing ones, should be given this bluish-gray shrew with light colored feet and chin and brownish neck, forearm, chest, and vent, and bicolored tail, I am at a loss to know.

39. *Sorex* (*Neosorex*) *albibarbis* (Cope). Eastern marsh Shrew.

It is with no small satisfaction that I announce the discovery of a member of this subgenus in Pennsylvania. One specimen was taken along the banks of a rocky stream flowing into the Big Bushkill, in Monroe County. It is the most southerly record for the subgenus, the previous record being from Warwick, Massachusetts. After going over the ground somewhat, it appears proper to endorse the verification of Mr. G. S. Miller, Jr., in the Proceedings of the Boston Society of Natural History, in giving this shrew the name applied to New England examples by Prof. Cope in 1863. Specimens from Lac Aux Sables, Quebec, and from Lincoln, Maine, agree better, in the brownish cast of lower parts, with Prof. Cope's diagnosis of *albibarbis*, as contrasted with the "ash-colored" belly of *S. palustris* given by Richardson in the *Fauna Boreali Americana*.

In the Pike County specimen, though identical in dentition and proportionate measurements with my Canadian specimens, the colors are much as in Richardson's diagnosis of *palustris*, showing that the brown belly character is inconstant in eastern specimens. It is probable, however, that the exceptions are in immature pelage. For a full discussion of these questions, see paper by Mr. G. S. Miller, Jr., in the Proceedings of the Boston Society of Natural History, Vol. XXVI.

⁵ Mr. G. S. Miller, Jr., has since identified these shrews to be *S. personatus* G. St. Hilaire.

40. *Blarina talpoides* (Gapper). Mole Shrew.

Excessively abundant in all sorts of situations, from wettest lowlands to barren mountain tops.

Owing to its numbers and carnivorous appetite this shrew is a great nuisance to the mouse trapper.

41. *Scalops aquaticus* (L.). Common Mole.

Rare among the mountains.

42. *Condylura cristata* (L.). Star-Nosed Mole.

Mr. Chas. Yaggie caught a specimen on his farm.

43. *Adelonycteris fuscus* (Beauv.). Carolina Bat.

44. *Atalapha borealis* (Müll.). Red Bat.

45. *Vespertilio gryphus* Fr. Cuvier. Little Brown Bat.

Several bats were observed, most, if not all, of which, are probably referable to these species.

I could find no one acquainted with a large bat which would be referable to the Hoary Bat, *Atalapha cinerea*.

A STUDY OF THE SYSTEMATIC AND GEOGRAPHICAL DISTRIBUTION
OF THE DECAPOD FAMILY ATYIDÆ Kingsley.

BY ARNOLD E. ORTMANN.

In the following paper I propose to give a revision of the family *Atyidae* with especial reference to its geographical distribution. For a true representation of the geographical range of a group of animals it is necessary to examine the details of the distribution of all the known species, as well as to define the systematic limits of each. Every error in determining a species may be followed by great confusion difficult to solve by subsequent investigation. In revising the known genera and species it is necessary to state the relations and affinities to each other in order to get an idea of the peculiarities of the geographical distribution and to find out their cause.

The family *Atyidae*, although a small one, comprises a considerable number of ill-defined species and genera, since most authors in creating such did not investigate their relations to those already known. In the typical genus *Atya* there are farther difficulties due to the change of characters undergone by one species in the different stages of life, which were wholly neglected by the majority of authors. I have, notwithstanding, succeeded in revising the family, pointing out the identity of certain species and genera, defining some more correctly, and stating the affinities so as to leave but a few species doubtful. I have determined a peculiar geographical distribution of the family agreeing well with its habits and morphological characters.

The family *Atyidae* is a very characteristic one among the Decapod group of *Eucyphidea*. It shows on the one hand a number of primitive characters, on the other a very peculiar shape of the fingers of the cheke. As I have stated in a former paper,¹ the *Atyidae* are closely connected with the family *Acanthephyridae*, which live at great depths in the sea and contain, without doubt, the most primitive *Eucyphidea*. The morphological differences between the two families are the following: 1. The mandible in the *Acanthephyridae* is furnished with a palpus (synhipod), in the *Atyidae* it is wanting.

¹ Decapoden u. Schizopoden der Plankton-Expedition, 1893, p. 42.

2. The fingers of the chelæ in the *Acanthephyridæ* are normal in shape, in the *Atyidæ* they are provided with a peculiar pencil of hairs. I may add that the habits of the two families are wholly different, the *Acanthephyridæ* being true marine animals, especially abyssal, the *Atyidæ* being true fresh-water forms.

Among the *Atyidæ* Kingsley distinguished two subfamilies, *Atyinae* and *Ephyrinae*. Since, however, there are but a few genera in this family, a subdivision is needless. The genera form a continuous series, the transition being so gradual that it is difficult to define the limits of the two subfamilies. In the following synopsis of the genera the first three named, *Xiphocaris*, *Troglocaris*, and *Atyaephyra* may be regarded as belonging to the subfamily *Ephyrinae* as created by Kingsley, the others as belonging to the *Atyinae*. Because the genus *Ephyra*, from which is derived the name *Ephyrinae*, is a synonym, this subfamily must be renamed, and I propose to name it, if at all, *Xiphocarinae*.

The presence of exopodites on the pereopoda of the *Xiphocarinae*, the shape of the carpal and propodal joints of the first two pairs of pereopoda, and the shape of the rostrum constitute a very close resemblance to the *Acanthephyridæ*. *Atyaephyra* makes a transition to the *Atyinae*, bearing exopodites only on the first two pairs of pereopoda, and having the carpal joints of these legs excavated at the distal extremity. This excavation is very characteristic in the true *Atyinae*, but in *Caridina* the carpal joint only of the first pair of legs shows this peculiarity, that of the second pair being normal. *Atyoida* is intermediate between *Caridina* and *Atya* in the shape of the propodal joints of these legs. Within the limits of *Caridina* occurs a reduction of the form of the rostrum (being in the *Xiphocarinae* long and serrated), which in most species of *Caridina* is longer or shorter and serrated, in a few very short and not serrated. In *Atyoida* and *Atya* the rostrum is usually short, but now and then it bears a few teeth on the inferior margin. Thus the series formed by *Xiphocaris*, *Atyaephyra*, *Caridina*, *Atyoida*, and *Atya* is a continuous one, whilst the genus *Troglocaris* is closely allied to *Xiphocaris* differing only by the rudimentary condition of the eyes, due to its subterranean habits in cave-waters.

The genus *Atya* is the most extreme of the family. The adult males of the species of this genus attain a considerable size, and the third pereopoda undergo with increase of age a change in shape,

the surface of the body and legs bearing a peculiar sculpture. The most extreme species, *Atya crassa*, may be separated from the others according to the sculpture of the body and placed in a separate subgenus, *Evatya*.

Fossil *Atyidae* are not known, although A. Milne-Edwards² describes a *Caridina nitida* from the "marnes d'Aix-en-Provence" (upper eocene or lower oligocene). None of the arguments given by him prove that this fossil is a *Caridina*. The presence in a fresh-water deposit makes it probable that it belongs to *Atyidae*, but for the same reason *Homelys minor* of Meyer,³ from the fresh-water deposits of the upper miocene of Eningen, would belong to the same family.

ATYIDÆ Kingsley, 1879.

Kingsley, Proceed. Acad. Nat. Sci., Philadelphia, 1879, p. 414. Bate, Challenger Maerur., 1888, p. 691. Ortmann, Zoolog. Jahrb., V, 1890, p. 455.

Mandibles stout, crown broad, dilated, slightly divided, without a synphipod. First four pairs of pereiopoda with epipodites. First two pairs of pereiopoda chelate, nearly equal, carpus of the second not annulated. Tips of fingers with pencils of hairs. Rostrum longer or shorter, serrated or not serrated.

*a*₁. Pereiopoda with exopodites [*Xiphocarinae*].

*b*₁. All the pereiopoda with exopodites. Carpal joints of the first two pairs of pereiopoda not excavated or but indistinctly so.

*c*₁. Eyes well developed XIPHOCARIS.

*c*₂. Eyes rudimentary TROGLOCARIS.

*b*₂. Only the first two pairs of pereiopoda with exopodites. Carpal joints of the first and second pair of pereiopoda distally excavated ATYAËPHYRA.

*a*₂. Pereiopoda without exopodites [*Atyinae*].

*b*₁. Carpal joint of the second pereiopoda normal, not excavated. Rostrum mostly compressed and serrated . . . CARIDINA.

*b*₂. Carpal joint of the second pereiopoda like that of the first distally excavated.

*c*₁. Movable finger shorter than the immovable part of hand, the latter distinctly divided in a palmar portion and an immovable finger ATYIDA.

*c*₂. Both fingers alike in size, no palma developed . . . ATYA.

² Bull. Soc. Philomat., Paris (7), II, 1879, p. 77.

³ Palæontographica, X, 3, 1862, p. 172, pl. 19, figs. 3-8.

XIPHOCARIS v. Martens, 1872.

Ephyra de Haan, Faun. Japon., Crust., Dec. 6, 1849, p. 185.⁴ (Nomen præoccupatum.)

Xiphocaris v. Martens, Archiv f. Naturg., 38, 1, 1872, p. 139.

Miersia Kingsley, Proceed. Acad. Nat. Sci., Philadelphia, 1879, p. 416.

Xiphocaris Kingsley, Bull. Essex Instit., vol. 14, 1882, p. 127.

Paratya Miers, Annal. Mag. Nat. Hist. (5), IX, 1882, p. 194.

Xiphocaris Pocock, Annal. Mag. Nat. Hist. (6), III, 1889, p. 17.

Miersia Ortmann, Jenaische Denkschr., VIII, 1894, p. 8.

α_1 . No supraocular spines. Rostrum longer or shorter, with an interrupted series of teeth on the upper margin, the basal series containing 9-18, the apical 3-6 teeth. Lower margin of rostrum with numerous (16-40) teeth. *X. elongata*.

SUBSPECIES (or varieties).

b_1 . Rostrum longer than carapace. *X. elongata typica* (1).⁵

b_2 . Rostrum shorter than carapace.

c_1 . Rostrum longer than the scaphocerite.

. *X. elongata intermedia* (1).

c_2 . Rostrum longer than the stalk of antennulæ.

. *X. elongata gladiator*.

c_3 . Rostrum shorter than the stalk of antennulæ.

. *X. elongata brevisrostris*.

α_2 . Supraocular spines present. Rostrum about as long as the scaphocerites or somewhat longer. An uninterrupted series of 20-24 teeth on the upper, 2-4 teeth on the lower margin.

. *X. compressa* (3).

1. *Xiphocaris elongata* (Guérin), 1857.

Hippolyte elongata Guérin, Anim. Artic. in: Ramon de la Sagra, Hist. de l'île de Cuba, 1857, p. 54, pl. 2, fig. 16.

Oplophorus americanus Saussure, Mem. Soc. Phys. Hist. Nat. Genève, t. 14, 2, 1858, p. 472, pl. 4, fig. 31.

Xiphocaris elongata (Guér.) v. Martens, Arch. f. Naturg., 38, 1, 1872, p. 140.

Oplophorus elongata (Guér.) Kingsley, Bull. Essex Instit., X, 1878, p. 68.

Xiphocaris elongata (Guér.) Pocock, Ann. Mag. Nat. Hist. (6), III, 1889, p. 17 ff, pl. 2, figs. 5-8.

Xiphocaris gladiator, var. *intermedia*, *brevisrostris* Pocock, ibid.

Oplophorus elongatus (Guér.) Sharp, Proceed. Acad. Nat. Sci., Philadelphia, 1893, p. 121.

Geographical distribution: Fresh-waters of the Antilles.—Cuba (Guérin, v. Martens); Hayti (Saussure); Dominica (Pocock); St. Domingo (Sharp).

2. *Xiphocaris compressa* (de Haan), 1849.

Ephyra compressa de Haan, Faun. Japon. Crust., Dec. 6, 1849, p. 186, pl. 46, fig. 7.

Atephyra compressa (d. H.) v. Martens, Arch. f. Naturg., 34, 1, 1868, p. 51 ff, pl. 1, fig. 4.

Atephyra compressa (d. H.) Miers, Ann. Mag. Nat. Hist. (5), IX, 1882, p. 193.

⁴ Non *Ephyra* Roux, Memoir. Salicoques, 1831, p. 24, which is identical with *Acanthephyra* A. Milne-Edwards, and belongs to the *Acanthephyridæ*.

⁵ I put in parentheses following each species, the number of specimens I have examined myself.

Miersia compressa (d. H.) Ortmann, Zoolog. Jahrb., V, 1890, p. 463.

Miersia compressa (d. H.) Ortmann, Jenaisch. Denkschr., VIII, 1894, p. 8.

Geographical distribution: Fresh-water of Australasia.—Japan (de Haan); Yokohama (v. Martens), Tokio (Miers, Ortmann); Island of Adenare, near Flores (v. Martens); Queensland: Burnett (Ortmann).

TROGLOCARIS Dormitzer, 1853. Dormitzer, Lotos, III, 1853, p. 85.

Only one species known, distinguished from *Xiphocaris* by the rudimentary condition of the eyes. Supraocular spines present.

1. *Troglocaris schmidti* Dormitzer, 1853.⁶

Dormitzer, *ibid.*, p. 85 ff, pl. 3.

Geographical distribution: In the waters of the caves of Carniola. Caves of Kumpole and Gurk (Dormitzer).

ATYAËPHYRA Brito-Capello, 1866.

Atyaëphyra Brito-Capello, Deser. Esp. nov. Crust. Arachn., Portugal, Lisboa, 1866, p. 5.

Hemicaridina Ortmann, Zoolog. Jahrb., V, 1890, p. 464.

Only one species known.

1. *Atyaëphyra desmarestii* (Millet) 1832 (16).

Hippolyte desmarestii Millet, Annal. Sci. Nat., t. 25, 1832, p. 461, pl. 10 B.

Hippolyte desmarestii Millet, Milne-Edwards, Hist. Nat. Crust., II, 1837, p. 376.

Caridina desmarestii (Mill.) Joly, Annal. Sci. Nat. (2), Zool., t. 19, 1843, p. 34 ff, pl. 3.

Caridina desmarestii (Mill.) Heller, Crust. südl. Europ., 1863, p. 238, pl. 8, fig. 3.

Atyaëphyra rosiana Brito-Capello, Deser. esp. nov. Crust. Arachn., Portugal, Lisboa, 1866, p. 6, pl. 1, fig. 1.

Hemicaridina desmarestii (Mill.) Ortmann, Zoolog. Jahrb., V, 1890, p. 464.

Geographical distribution: Fresh-water of southern Europe.—Portugal: Coimbra (Brito-Capello); southern and western France (Millet, Joly); Corsica, Sicily, Dalmatia (Heller).

CARIDINA Milne-Edwards, 1837.

Caridina Milne-Edwards, Hist. Nat. Crust., II, 1837, p. 362.

Caradina Kingsley, Proceed. Acad. Nat. Sci., Philadelphia, 1879, p. 415.

a₁. Rostrum longer or shorter, serrated. Anterior margin of carapace with an antennal-spine.

b₁. Upper margin of rostrum not serrated. Carpal joint of the first pereopoda but slightly longer than broad. . . . *C. typus* (2).

. *C. americana*.⁷

⁶ There is no doubt that the *Palaeon anophthalmus* Kollar, Sitz. Ber. Akad. Wiss., Wien, I, 1848, p. 137, from the caves of Kompolska and Portiskavez in Carniola is the same species as *Troglocaris schmidti*. As there is no published description by Kollar, the name *anophthalmus* cannot be employed.

⁷ *C. americana* is a somewhat doubtful species, but certainly it is closely allied to *C. typus*.

- b*₂. Upper margin of rostrum serrated.
- c*₁. Carpal joint of the second pereopoda shorter than the hand, carpal joint of the first pereopoda short. Rostrum about as long as the antennal scale. *C. brevicarpatis* (1).
- c*₂. Carpal joint of the second pereopoda longer than the hand.
- d*₁. Rostrum horizontally projecting or slightly deflexed, shorter than the antennal scale.
- e*₁. Carpal joint of the first pereopoda short, not more than $1\frac{1}{2}$ as long as broad.
- f*₁. Lower margin of rostrum serrated.
- g*₁. Upper margin of rostrum with about 13-20 teeth, rostrum mostly longer than the first joint of the antennulæ.
- h*₁. Eggs small and numerous. Fingers of the second pereopoda twice as long as the palm.
- i*₁. Carpal joint of the first pereopoda distinctly longer than broad *C. weberi*.
- i*₂. Carpal joint of the first pereopoda nearly as broad as it is long *C. japonica*.
- h*₂. Eggs greater and not numerous. Fingers of the second pereopoda but slightly longer than the palm. *C. pareparentis*.
- g*₂. Upper margin of rostrum with 3-5 teeth; rostrum as long or a little longer than the first joint of the antennulæ. *C. timorensis*.
- g*₃. Upper margin of rostrum with 7-12 teeth; rostrum shorter than the first joint of the antennulæ. *C. parvirostris*.
- f*₂. Lower margin of rostrum not serrated. *C. richtersi*.
- e*₂. Carpal joint of the first pereopoda longer, at least twice as long as broad.
- f*₁. Spine at the base of the antennulæ shorter than the first joint.
- g*₁. Dactylus of the fifth pereopoda nearly half as long as the propodus. *C. lævis*.
- g*₂. Dactylus of the fifth pereopoda very short, $\frac{2}{5}$ - $\frac{1}{7}$ of the propodus.
- h*₁. Rostrum shorter than the stalk of the antennulæ, upper margin with 20-30 teeth, lower with 5-14. *C. multidentata*.
- h*₂. Rostrum about as long as the stalk of the antennulæ.
- i*₁. Teeth of the upper margin of rostrum 10-15, not continued to the tip of rostrum, on the tip 1-2 teeth, on the lower margin 7-12. *C. africana* (many).
- i*₂. Teeth of the upper margin of rostrum 20-25, in a continuous series to the tip. *C. fossarum*.

- f_2 . Spine at the base of the antennulæ longer than the first joint *C. serratirostris*.
- d_2 . Rostrum slightly bent upward, longer than the antennal scale. Upper margin partially destitute of teeth.
- c_1 . The proximal teeth on the upper margin of rostrum crowded, numerous.
- f_1 . Carpal joint of the first pereiopoda a little shorter than the hand.
- g_1 . Carpal joint of the first pereiopoda $2-2\frac{1}{2}$ as long as broad *C. wyeki* (many).
- g_2 . Carpal joint of the first pereiopoda only $1\frac{1}{2}$ as long as broad *C. nilotica* (1).
- f_2 . Carpal joint of the first pereiopoda very much shorter than the hand *C. grandirostris*.
- c_2 . The proximal teeth on the upper margin of rostrum remote, not numerous. *C. gracilirostris*.
- a_2 . Rostrum very short, not serrated. Anterior margin of the carapace without an antennal spine.
- b_1 . Fingers of the first pereiopoda about as long as the palm. *C. singhalensis* (many).
- b_2 . Fingers of the first pereiopoda much shorter than the palm. *C. brevirostris*.

1. *Caridina typus* Milne-Edwards, 1837.⁸

Caridina typus Milne-Edwards, Hist. Nat. Crust., II, 1837, p. 363, pl. 25 bis, figs. 4, 5.

C. exilirostris Stimpson, Proceed. Acad. Nat. Sci., Philadelphia, 1860, p. 29.

C. siamensis Giebel, Zeitschr. f. d. ges. Naturw., 21, 1863, p. 329.

C. typus M. E., Miers, Philosoph. Trans. London, 168, 1879, p. 492. Richters, Beitr. Meeresfaun. Maurit. Seychell. Decap., 1880, p. 162, pl. 17, fig. 23.

C. typus M. E., de Man, in Weber, Zoolog. Ergebn. Reis. Niederl. Ost-Indien, II, 1892, p. 367, pl. 21, fig. 22.

C. typus M. E., de Man, Not. Leyd. Mus., 15, 1893, p. 300.

C. typus M. E., Sharp, Proceed. Acad. Nat. Sci., Philadelphia, 1893, p. 111.

C. typus M. E., Ortmann, Jenaische Denkschr., VIII, 1894, p. 8.

Geographical distribution: Fresh-water of the Islands of the Indian Ocean and of Indo-Malaysia.—Mauritius (Richters, Sharp); Rodriguez (Miers); Seychelles (Richters); Siam (Giebel); Flores, Timor, Saleyer, Celebes (de Man); Amboina (Ortmann); Loo-Choo (Stimpson).

2. *Caridina americana* Guérin, 1857.

Guérin, Anim. Artic. in Ramon de la Sagra, Hist. de l'île de Cuba, 1857, p. 52, pl. 2, fig. 13.

v. Martens, Arch. f. Naturg., 38, 1, 1872, p. 135.

Pocock, Ann. Mag. Nat. Hist. (6), III, 1889, p. 16, pl. 2, fig. 4.

Geographical distribution: Cuba (Guérin, v. Martens); Dominica (Pocock).

⁸ *Caridina typus* Bate, Challenger Maer. 1888, p. 704, pl. 119, fig. 3, from San Jago, Cape Verde Isl. is probably a different species.

3. *Caridina brevicarpalis* de Man, 1892.
De Man, in Weber, Zool. Erg., etc., II, 1892, p. 397, pl. 24, fig. 30.
Ortmann, Jenaische Denkschr., VIII, 1894, p. 9.
Geographical distribution: Celebes (de Man); Amboina (Ortmann).
4. *Caridina weberi* de Man, 1892.
De Man, in: Weber, Zool. Erg., etc., II, 1892, p. 371, pl. 22, fig. 23.
De Man, Not. Leyden Mus., 14, 1892, pl. 9, fig. 8.
Geographical distribution: Sumatra; Java; Saleyer; Celebes; Flores (De Man).
5. *Caridina japonica* de Man, 1892.
De Man, Not. Leyd. Mus., 14, 1892, p. 261, pl. 9, fig. 7.
Geographical distribution: Japan: Kagar, Hayagana (De Man).
6. *Caridina pareparensis* de Man, 1892.
De Man, in: Weber, Zool. Erg., etc., II, 1892, p. 379, pl. 22, fig. 25.
Geographical distribution: Celebes (De Man).
7. *Caridina timorensis* de Man, 1893.
De Man, Not. Leyd. Mus., 15, 1893, p. 300, pl. 8, fig. 6.
Geographical distribution: Timor (De Man).
8. *Caridina parvirostris* de Man, 1892.
De Man, in: Weber, Zool. Ergebn., etc., II, 1892, p. 375, pl. 22, fig. 24.
Geographical distribution: Flores (De Man).
9. *Caridina richtersi* Thallwitz, 1891.
C. serrata Richters, Beitr. Meerestf. Maur. Seych. Decap., 1880, p. 163, pl. 17, figs. 24-27 (nomen preoccupatum).
C. richtersi Thallwitz, Abhandl. Mus. Dresden, 3, 1891, p. 27, foot-note.
Geographical distribution: Mauritius (Richters).
10. *Caridina lævis* Heller, 1862.
Heller, Sitz. Ber. Acad. Wiss., Wien, 45, 1, 1862, p. 411.
De Man, in: Weber, Zool. Ergebn., etc., II, 1892, p. 376, pl. 23, fig. 27.
Geographical distribution: Java (Heller, De Man).
11. *Caridina multidentata* Stimpson, 1860.
Stimpson, Proceed. Acad. Nat. Sci., Philadelphia, 1860, p. 29.
De Man, in: Weber, Zool. Ergebn., etc., II, 1892, p. 380, pl. 22, fig. 26.
Geographical distribution: Bonin Isl. (Stimpson); Celebes (De Man).
12. *Caridina africana* Kingsley, 1882.⁹
Kingsley, Bull. Essex Instit., vol. 14, 1882, p. 127, pl. 1, fig. 3.
Geographical distribution: S. Africa: Zulu Land (Kingsley).

⁹ Having examined the types of this species in the Museum of the Academy of Nat. Sci., Philadelphia, I can give the following details:—

Carpal joint of the first pereopoda twice as long as broad on the distal extremity, a little shorter than the hand. Fingers about equal to the palm. Carpal joint of the second pereopoda four times as long as broad on the distal extremity, a little longer than the hand. Fingers about $1\frac{1}{2}$ as long as the palm. Dactylus of the fourth pereopoda about 1.5 of the propodus, the fifth pereopoda are in none of the type specimens preserved.

13. *Caridina fossarum* Heller, 1862.

Heller, Sitzb. Acad. Wiss., Wien, 45, 1, 1862, p. 411.
De Man, in: Weber, Zool. Ergebn., etc., II, 1892, p. 397.

Geographical distribution: Persia: Schiraz (Heller).

14. *Caridina serratiostris* de Man, 1892.

De Man, in: Weber, Zool. Ergebn., etc., II, 1892, p. 382, pl. 23, fig. 28.

Geographical distribution: Flores; Saleyer; Celebes (De Man).

15. *Caridina wycki* (Hickson), 1888.

Alya wycki Hickson, Annal. Mag. Nat. Hist. (6), II, 1888, p. 357, pl. 13, 14.
Caridina wycki (Hicks.) Thallwitz, Abhandl. Mus. Dresden, 3, 1891, p. 27.
Caridina wycki (Hicks.) de Man, in: Weber, Zool. Ergebn., etc., II, 1892, p. 386, pl. 24, fig. 29-29k.
Caridina wycki (Hicks.) de Man, Not. Leyden Mus., 15, 1893, p. 302, pl. 8, fig. 7.
Caridina wycki (Hicks.) Ortman, Jenaische Denkschr., VIII, 1894, p. 9.

Geographical distribution: From East-Africa to eastern Australia.

—East-Africa: Dar-es-Salaam (Ortman); Ceylon (Ortman);
Celebes (Hickson, Thallwitz, de Man); Saleyer (de Man); Flores
(de Man); Timor (de Man); Queensland: Burnett (Ortman).

16. *Caridina nilotica* (Roux), 1833.¹⁰

Pelias niloticus Roux, Annal. Sci. Nat., t. 28, 1833, p. 73, pl. 7, fig. 1.
Caridina longirostris Milne-Edwards, Hist. Nat. Crust., II, 1837, p. 363.
Caridina longirostris Lucas, Explor. Alger. Anim. Art., 1849, p. 40, pl. 4,
fig. 1.
Caridina longirostris Heller, Sitzb. Acad. Wiss., Wien, 45, 1, 1862, p. 412.
Caridina longirostris de Man, in: Weber, Zool. Ergebn., etc., II, 1892, p. 396,
pl. 24, fig. 29l, 29m, 29mm.
Caridina longirostris Sharp, Proceed. Acad. Nat. Sci., Philadelphia, 1893, p.
111.

Geographical distribution: Northern Africa.—Nile (Roux); Algiers
(Lucas, Sharp); River Macta, near Oran (Milne-Edwards).

17. *Caridina grandirostris* Stimpson, 1860.

Stimpson, Proceed. Acad. Nat. Sci., Philadelphia, 1860, p. 28.

Geographical distribution: Loo-Choo (Stimpson).

18. *Caridina gracilirostris* de Man, 1892.

De Man, in Weber, Zoolog. Ergebn., etc., II, 1892, p. 399, pl. 25, fig. 31.

Geographical distribution: Sumatra, Celebes, Saleyer, Flores (De Man).

19. *Caridina singhalensis* Ortman, 1894.

Ortman, Jenaische Denkschr., VIII, 1894, p. 9, pi. 1, fig. 2.

Geographical distribution: Ceylon (Ortman).

¹⁰ It is doubtful, whether the following quotations belong to this species or to *Car. wycki*:

C. nilotica Hilgendorf, Mon. Ber. Akad. Wiss., Berlin, 1878, p. 828.—Mozambique, Tette.

C. longirostris Richters, Beitr. Meeresf. Maur. Seych. Decap., 1880, p. 162.—Seychelles.

C. nilotica Pfeffer, Jahrb. Hamburg Wiss. Anstalt., VI, 1880, p. 35.—Zanzibar.

20. *Caridina brevirostris* Stimpson, 1860.

Stimpson, Proceed. Acad. Nat. Sci., Philadelphia, 1860, p. 29.

Geographical distribution: Loo-Choo (Stimpson).DOUBTFUL SPECIES.¹¹*Caridina denticulata* de Haan, Faun. Japon. Crust., Dec. 6, 1849, p. 186, pl. 45, fig. 8.—Japan.*Caridina leucosticta* Stimpson, Proceed. Acad. Nat. Sci., Philadelphia, 1860, p. 28.—Japan, Simoda.*Caridina serrata* Stimpson, *ibid.*, p. 29.—Hongkong.*Caridina acuminata* Stimpson, *ibid.*, p. 29.—Bonin Isl.*Caridina spathulirostris* Richters, Beitr. Meeresf. Maur. Seych., 1880, p. 163, pl. 17, fig. 28.—Mauritius.*Caridina curvirostris* Heller, 1862.

Heller, Verhandl. Zool. Bot. Gesellsch., Wien, 12, 1862, p. 525.

Heller, Crust. Novara, 1868, p. 105.

Miers, Catal. Crust. New Zealand, 1876, p. 78.

Geographical distribution: Auckland (Heller).

This species is provided with an supraorbital and an antennal spine, the spine at the base of the antennulæ is longer than the first joint.

It may belong to the genus *Xiphocaris* and may be identical with a species of *Xiphocaris* from the River Avon, near Christ Church, present in the Museum of Strassburg. Unfortunately I cannot give a description of these specimens and a comparison with Heller's species.

ATYOIDA Randall, 1839.

Randall, Journ. Acad. Nat. Sci., Philadelphia, VIII, 1839, p. 140.

This genus¹² has, up to the present time, been very doubtful. Examining specimens of *Atyoida bisulcata* from Oahu, Sandwich, in the Museum of the Academy of Natural Sciences of Philadelphia (No. 162), I find that the hands of the two anterior pairs of legs are wholly different from the typical *Atya*, in the same manner as figured by F. Müller in *Atyoida potimirim* (l. c., figs. 3 and 4). In

¹¹ The following three species described by Bate do not belong to *Caridina*; but to the family *Hippolytidae*:—

Caridina truncifrons Bate, Proceed. Zool. Soc. London, 1863, p. 499, pl. 40, fig. 2, belonging to *Latreutes*.

Caridina cincinnuli Bate, *ibid.*, p. 500, pl. 40, fig. 3, and *Caridina tenuirostris* Bate, *ibid.*, p. 501, pl. 40, fig. 4, both belonging to *Virbius*. (All three from Australia, St. Vincents Gulf.)

¹² *Atya serrata* Bate, Challenger Macrur., 1888, p. 699, pl. 119, fig. 2, from San Jago, Cape Verd Isl., and some other species described from the West Indies (see below), may belong to this genus. In *A. serrata* the rostrum is shorter and dentate below.

Atyoida the hands are formed like those of *Caridina*: the dactylus (movable finger) is inserted on the upper margin of the propodus, being shorter than the latter and forming a chela, as usual in the Decapoda, consisting of a palmar portion and two fingers. In *Atya*, on the contrary, the dactylus articulates with the propodus on the posterior end of the latter, both joints being exactly alike and forming a hand of a very peculiar shape among the Decapoda, the palmar portion being wholly reduced, and the hand consisting only of two fingers about alike in size, and connected with each other at the posterior ends. The carpal joint of the chelipeds in *Atyoida* is longer than in *Atya*, especially on the second pair of legs.

- α_1 . Rostrum dentate below. Carpal joint of the first pair of pereopoda longer than broad *A. potimirim*.
 α_2 . Rostrum not dentate below. Carpal joint of the first pair of pereopoda not longer than broad *A. bisulcata* (many).

1. *Atyoida potimirim* F. Müller, 1881.

F. Müller, Kosmos (Krause), IX, 1881, p. 117 ff, figs. 1-20.

Geographical distribution: Brazil: Itajahy (F. Müller).

2. *Atyoida bisulcata* Randall, 1839.

Atyoida bisulcata Randall, Journ. Acad. Nat. Sci., Philadelphia, VIII, 1839, p. 140, pl. 5, fig. 5.

Atyoida bisulcata Dana, U. S. Expl. Exp. Crust., 1852, p. 540, pl. 34, fig. 1.

Atyoida bisulcata Stimpson, Proceed. Acad. Nat. Sci., Philadelphia, 1860, p. 28.

Atyoida tahitensis Stimpson, *ibid.*

Atyoida bisulcata and *tahitensis* A. Milne-Edwards, Annal. Soc. Entomol., France (4), IV, 1864, pp. 151 and 152.

Atya bisulcata (Rand.). Bate, Challenger Macrur., 1888, p. 700, pl. 120.

Atya bisulcata (Rand.), Sharp, Proceed. Acad. Nat. Sci., Philadelphia, 1893, p. 111.

Geographical distribution: Hawaiian Isl. (Randall, Stimpson): Oahu (Dana, Sharp); Tahiti (Stimpson).

ATYA Leach, 1817.

Atya Leach, Trans. Linn. Soc. London, XI, 1815, p. 345 (nomen præoccupatum).

Atya Leach, Zoolog. Miscell., III, 1817, p. 29.

- α_1 . Rostrum shorter than the antennular peduncle, without teeth on the upper margin [Subgenus *Atya*].
 b_1 . Rostrum without lateral keels and without lateral teeth near the base.
 c_1 . Rostrum longer than the first joint of the antennule, horizontally projecting or sometimes bent upward. *A. moluccensis* (6).
 c_2 . Rostrum as long as or shorter than the first joint of the antennule, bent downward. *A. spinipes*¹³ (12).

¹³ *A. spinipes* might be regarded as a variety of *A. moluccensis*.

- b*₂. Rostrum with lateral keels ending by angles or short spines on each side of the base of rostrum.
- c*₁. Carapace not sculptured with keels, but often punctate.
Third pair of legs (in the adult) without a spine on the inferior margin.
- d*₁. Rostrum very short. Lateral keels ending in front in angles, not in spines.
. *A. brevirostris* (3).
- d*₂. Rostrum longer. Lateral keels ending in front in spiniform angles.
- e*₁. Merus of the first two pairs of pereopoda hairy.¹⁴
- f*₁. Rostrum straight.
. ?*A. margaritacea* (3).
- f*₂. Rostrum bent downward.
. ?*A. robusta*.
- e*₂. Merus of the first two pairs of pereopoda not hairy (?) *A. scabra* (3).
- c*₂. Carapace strongly sculptured in front with keels.
Third pair of legs on the inferior margin with a spine in adult specimens.¹⁵ . . . *A. gabonensis* (1).
- a*₂. Rostrum as long as the antennal scale, upper margin with six to eight spines. Anterior part of carapace with numerous spines and spiny carinations [Subgenus: *Evatya* Smith]
. *A. (Evatya) crassa*.

1. *Atya moluccensis* de Haan, 1849.

- A. moluccensis* de Haan, Faun. Japon. Crust., Dec. 6, 1849, p. 186.
A. armata A. Milne-Edwards, Annal. Soc. Entomol., France (4), IV, 1864, p. 149, pl. 3, fig. 3.
A. armata v. Martens, Arch. f. Naturg., 34, 1, 1868, p. 47, pl. 1, fig. 6.
A. moluccensis d. H., Miers, Annal. Magaz. Nat. Hist. (5), V, 1880, p. 382, pl. 15, fig. 3, 4.
A. gustavi Ortmann, Zoolog. Jahrb., V, 1890, p. 467, pl. 36, fig. 9.
A. dentirostris Thallwitz, Abhandl. Mus., Dresden, 3, 1891, p. 26, fig. 7.
A. moluccensis d. H., de Man, in Weber, Zoolog. Ergebn. Reis. Niederl. Ost-Indien, II, 1892, p. 357, pl. 21, fig. 20.
A. moluccensis d. H., Ortmann, Jenaische Denkschr., VIII, 1894, p. 10.

Geographical distribution: Fresh-water of the Indian Archipelago.—Sumatra (de Man, Ortmann); Java (A. Milne-Edwards,¹⁶ Miers, de Man); Batjan (Miers); Bali (Miers); Celebes (Miers, de Man,

¹⁴ The differences between the New Caledonian species *A. margaritacea* and *robusta* and the West Indian *A. scabra* are very doubtful, since the anterior pereopoda of the latter have the merus furnished with a few hairs. I suppose that the locality given by Milne-Edwards for *margaritacea* and *robusta* is not correct, and that there is no difference from *A. scabra*. (See below.)

¹⁵ I think the differences of *A. gabonensis* and perhaps also of *A. crassa* are not of specific value, but that they are differences of age: *A. gabonensis* would be a very old state of *A. scabra*, but it may be that *A. crassa* is a distinct species.

¹⁶ A. Milne-Edwards records his specimens, l. c., erroneously from the Philippine Islands (see de Man, l. c., p. 357, foot-note).

Thallwitz); Saleyer (de Man); Ceram (v. Martens); Timor (de Man); Flores (de Man); Amboina (Ortmann); Philippine Islands: Samar (v. Martens).

2. *Atya spinipes* Newport, 1847.

A. spinipes Newport, Annal. Magaz. Nat. Hist., XIX, 1847, p. 159.

A. pilipes Newport, *ibid.*, p. 160.

A. spinipes and *pilipes* Newp., A. Milne-Edwards, Annal. Soc. Entomol., France (4), IV, 1864, pp. 149, 150.

A. pilipes Newp., Miers, Catal. Crust., New Zealand, 1876, p. 79.

A. spinipes and *pilipes* Newp., Miers, Annal. Magaz. Nat. Hist. (5), V, 1880, p. 282, pl. 15, figs. 5, 6.

A. pilipes Newp., Ortmann, Zoolog. Jahrb., V, 1890, p. 466, pl. 36, fig. 8.

Geographical distribution: This species represents the *A. moluccensis* in the fresh-water of the Pacific Islands.—Philippine Islands (Newport); Caroline Isl. (Ortmann); Fiji Isl. (Ortmann); Samoa Islands (Newport, Miers, Ortmann).¹⁷

3. *Atya brevis* de Man, 1892.

De Man, in: Weber, Zoolog. Ergebn., etc., II, 1892, p. 360, pl. 21, fig. 21.

Ortmann, Jenaische Denkschr., VIII, 1894, p. 10.

Geographical distribution: Flores (De Man); Timor (De Man); Amboina (Ortmann).

4. *Atya margaritacea* A. Milne-Edwards, 1864.

A. Milne-Edwards, Annal. Soc. Entomol., France (4), IV, 1864, p. 148, pl. 3, fig. 2.

Ortmann, Zoolog. Jahrb., V, 1890, p. 465, pl. 36, fig. 7.

Geographical distribution: New Caledonia (A. Milne-Edwards).

5. *Atya robusta* A. Milne-Edwards, 1864.

A. Milne-Edwards, *ibid.*, 1864, p. 148, pl. 3, fig. 1.

Geographical distribution: New Caledonia (A. Milne-Edwards).

6. *Atya scabra* Leach, 1815.

Alys scaber Leach, Trans. Linn. Soc. London, XI, 1815, p. 345.

Atya scabra Leach, Zoolog. Miscell., III, 1817, p. 29, pl. 131.

Atya scabra Desmarest, Consider. Génér. Crust., 1825, p. 217.

A. mexicana Wiegmann, Arch. f. Naturg., II, 1, 1836, p. 145.

A. scabra Lch., Milne-Edwards, Hist. Natur. Crust., II, 1837, p. 942, pl. 24, figs. 15-19, and Atlas, Cuvier's Regn. anim., pl. 51, fig. 4.

A. sulcatipes Newport, Annal. Magaz. Nat. Hist., XIX, 1847, p. 159, pl. 8, fig. 1.

A. occidentalis Newport, *ibid.*

A. scabra Lch., Stimpson, Boston Journ. Nat. Hist., VI, 1857, p. 498.

A. scabra, sulcatipes, and occidentalis A. Milne-Edwards, Annal. Soc., Entomol., France (4), IV, 1864, pp. 146, 147.

A. rivalis and *tenella* Smith, 2 and 3 Rep. Peabody Acad. Sci., 1871, p. 94.

A. scabra and *occidentalis* v. Martens, Arch. f. Naturg., 38, 1, 1872, p. 135.

A. punctata Kingsley, Proceed. Acad. Nat. Sci., Philadelphia, 1878, p. 91.

A. occidentalis Newp., Kingsley, *ibid.*, p. 92.

A. sulcatipes Newp., Bate, Challenger Macrur., 1888, p. 694, pl. 118, 119, fig. 1.

A. occidentalis Newp., Pocock, Annal. Mag. N. H. (6), III, 1889, p. 11, pl. 2, fig. 3.

A. scabra Lch., Sharp, Proceed. Acad. Nat. Sci., Philadelphia, 1893, p. 111.

¹⁷ The locality, "New Zealand," given by Newport is an error.

Geographical distribution: Fresh-water of the West Indies and the Cape Verde Islands.—Mexico (Wiegmann, Milne-Edwards, v. Martens, Stimpson, Sharp); Nicaragua (Smith); Cuba (v. Martens); Hayti (Kingsley); Jamaica (Newport); Dominica (Pocock); Martinique (Sharp); Tobago (Mus. Strassburg¹⁸).—Cape Verde Islands: San Nicolao (Newport); San Jago (Bate).

7. *Atya gabonensis* Giebel, 1875.

Atya gabonensis Giebel, Zeitschr. f. d. gesammt. Naturwiss. (2), XI, 1875, p. 52.

Evatya sculptilis Kölbel, Sitz. Ber. Acad. Wiss. Wien, vol. 90, 1, 1884, p. 317, pl. 2, fig. 8, pl. 3.

Alya sculptata Ortmann, Zoolog. Jahrb., V, 1890, p. 465.

Geographical distribution: Gaboon (Giebel); Orinoco (Kölbel).

8. *Atya* (*Evatya*) *crassa* Smith, 1871.

Smith, 2 and 3 Rep. Peabody Acad. Sci., 1871, p. 95.

Kölbel, Sitzb. Acad. Wiss., Wien, vol. 90, 1, 1884, p. 318, foot-note.

Geographical distribution: Nicaragua (Smith); Mexico: Presidio (Kölbel).

DOUBTFUL SPECIES.

Atya poeyi Guérin, Crust. in Ramon de la Sagra, Hist. de l'île de Cuba, 1857, p. 46, pl. 2, fig. 7.—Cuba.

Caridina mexicana Saussure, Mem. Soc. Phys. Hist. Nat. Genève, 14, 2, 1858, p. 463, pl. 4, fig. 26.—Mexico.

Atyoida glabra Kingsley, Proceed. Acad. Nat. Sci., Philadelphia, 1878, p. 93.—Nicaragua.

Atya serrata Bate, Challenger Macrur., 1888, p. 699, pl. 119, fig. 2.—Cape Verde Isl.: San Jago.

These species may be the young of *A. scabra* or may belong to *Atyoida*.

Considerations concerning the geographical distribution of the Atyida.

Some species of *Atyida* were formerly considered to be marine animals; there is now no doubt that this family contains only fresh-water forms. This family is probably one of the most primitive groups of Decapoda living in fresh-water, having immigrated at an early geological period.

Only two species, *Caridina wyeki* and *gracilirostris*, are recorded by Weber¹⁹ as found in a few cases in brackish waters of Sumatra

¹⁸ This locality is not yet published: there is one adult male from Tobago in the museum at Strassburg.

¹⁹ Die Süswassererustaceen der Indischen Archipels.—Zoolog. Ergebn. Reise Nederl. Ost.-Indien., II, 1892, p. 542.

and Celebes.²⁰ I believe, that this occurrence may be considered as a re-adaptation of these two species, as they are found also in fresh-water. Since the genus *Caridina* is not a primitive one, while the genera of the *Xiphocarinae* are so, and live exclusively in fresh-water, it is very probable, that the fresh-water habit of the family must be regarded as the original manner of living. I believe, therefore, that the *Atyidae*, even of the Indian Archipelago, are not immigrants from the sea, as stated by Weber (l. c., p. 543), but "true localized fresh-water animals, forming an old element of the fresh-water fauna."²¹

The main differences of the *Atyidae* and their supposed ancestors, the *Acanthephyridae*, are morphological as well as biological, the *Acanthephyridae* being true marine, and essentially abyssal animals. To all appearance the morphological differences are causally connected with the change of habits. The peculiar pencil of hairs at the distal extremities of the fingers is adapted for securing the special food required, as described by F. Müller in *Atyoida potimirim*.²² No doubt the other species of *Atyidae* feed in the same manner. I cannot say whether the absence of the synnhipod of the mandible is due to the same cause, since the function of the synnhipod is unknown, but it may be in connection with it. On the other hand the habits of the *Acanthephyridae* are wholly unknown, so that we cannot compare this family with the *Atyidae*, but it is very probable that the morphological differences of the *Acanthephyridae* correspond to differences in the habits, especially in securing food.

We can state, briefly, that the *Atyidae* are closely allied to the most primitive *Eucyphidea*, forming a peculiar branch of development very early separated from the main stem, now represented by the *Acanthephyridae*. Their several characters are connected with a change of habit, and with the immigration to fresh-waters.

The geographical range of the *Atyidae* embraces the whole of the circumtropical parts of the world, members of the family being recorded from all the localities explored within these limits. Only in two localities does the range exceed the true tropics: in Japan, where it extends as far north as Tokio, and in the Mediterranean province,

²⁰ See de Man, *ibid.*, pp. 387, 390, 400.

²¹ Weber, l. c., p. 533: "echte regionale und locale Süßwassertiere, die einen alten Bestand der Süßwasser Fauna bilden."

²² Kosmos, IX, 1881, p. 117 ff.

where it extends northward to southern France and southern Austria. This nearly exclusive distribution within the tropics, at least in the warmer climates, shows that the family was probably also in former times an inhabitant of the warmer parts of the world, and the possibility is granted that the immigration into fresh-water took place at a time when climatic zones were not at all differentiated, a tropical climate prevailing everywhere. If this immigration took place in a later time, the poles having undergone a cooling, one could not understand the presence of the family in all parts of the tropics, as well as the occurrence of some genera (*Xiphocaris*, *Caridina*, *Atya*) on both of the present great continents, the eastern and western.

After the cooling of the northern and southern circumpolar regions²³ the range of the family was divided into two parts: an eastern comprising the tropical Africa, Asia, Australia, and the Pacific islands, and a western comprising tropical America.²⁴ The most primitive genera of the family were restricted in range by the concurrence of the more extremely developed ones, and the latter preserved a more circumtropical distribution.

It is very interesting to examine the geographical range of the genera and species from the point of view here given.

The most primitive genus, *Xiphocaris*, shows a distribution the peculiarity of which can only be understood by supposing that the range of this genus was formerly a more extended one, but that in most parts of the world the representatives were exterminated. Only three species survived, one of which lives now in the fresh-waters of the West Indies, the other in Indo-Malaysia, from Japan to Australia, and the third in New Zealand. From the intermediate countries species of this genus are not recorded. The Indo-Malaysian species, *Xiphocaris compressa*, repeats, as we know at present, this peculiarity in a reduced manner, being only recorded from Japan, the island of

²³ See Ortmann Jenaische Denkschr., VIII, 1894, p. 74, and Pfeffer, Versuch über die erdgeschichtliche Entwicklung der jetzigen Verbreitungsverhältnisse unseres Thierwelt. Hamburg, 1891.

²⁴ In case the *Alyidae* immigrated from the sea into the fresh-water after this separation, it is very probable that the geographical distribution would not be a circumtropical one, but that different groups immigrated into the western and eastern continents. We know another group of Decapoda, in which the latter is the case: the family *Telphusidae*, one subfamily of which the *Telphusinae*, being restricted to the tropical and subtropical parts of the eastern continents (Mediterranean, African, Indian, Indo-Malaysian, etc.), two other subfamilies, *Trichodactylinae* and *Pseudotelphusinae*, being restricted to the tropical parts of America.

Adenare, and from Queensland.²⁵ The closely allied genus *Troglocaris*, the only species of which might be regarded as a fourth form of *Xiphocaris*, lives in the subterranean waters of Carniola, a perfectly isolated locality in no way connected with the others named. The third primitive genus, *Atyaephyra*, is found near the locality of *Troglocaris* on the northern borders of the Mediterranean Sea. It is somewhat less primitive. The scattered localities at which are found the species of these three genera forming the subfamily *Xiphocarinae* are no doubt the remains of a more universal distribution in former times: the species now living show the character of true survivals.

In the subfamily *Atyinae*, the genus *Atyoida* shows a survival character similar to that of the *Xiphocarinae*; being recorded from the Sandwich Islands, Tahiti, and southern Brazil. But this genus must be the subject of farther study.

The genus *Caridina* appears to be nearly a circumtropical one. Its range is divided into two very unequal parts: the one comprising the West Indies and containing only one species, the other comprising a continuous area of the old world and containing at least nineteen other species. This area extends from South Africa along the east coast to the southern borders of the Mediterranean Sea and to Persia, crossing the islands of the Indian Ocean and Indo-Malaysia to Japan and Australia.²⁶ Species of this genus have not yet been found in West Africa, in southern Asia (except Ceylon and Siam), and in the Pacific islands, but it may be that some species will be discovered later in these countries.

This distribution of the genus can only be understood by supposing that it was present before a separation of the eastern and western parts of the tropics took place, and that the extended range of former times is now restricted to the tropical parts of the continents bordering the Indian Ocean and to its islands, and to the islands of eastern Asia from Japan to Australia. The occurrence of one species in the Nile and in the rivers of Algiers is due, I believe, to a more recent immigration from the central and eastern parts of Africa, not unlike the occurrence of *Palaeon nitolicus*.²⁷

²⁵ It may be that this species will be found on other islands between Asia and Australia, but it is very remarkable that the large collections of freshwater Crustacea made by M. Weber in the Indian Archipelago, and described by de Man, do not contain this species.

²⁶ A poorly described species is recorded from the Cape Verde Islands.

²⁷ See Ortman, *Zoolog. Jahrb.*, V, 1891, p. 745.

It is very probable that farther investigations will prove that the range of *Caridina* is a somewhat different one, since fresh-water crustacea of smaller size are mostly neglected by collectors, and the fauna of the fresh-waters of most tropical countries are very little known. Accordingly, the view given above on the geographical distribution of *Caridina* may, perhaps, have to be changed later.

The distribution of the most extreme genus of the family, *Atya*, is somewhat similar to that of *Caridina*. It is found, like the latter, in the West Indies and Indo-Malaysia, but there are some modifications. One species is known from West Africa, which is identical with another described from the Orinoco, and there is recorded one species from the Cape Verde Island, identical with the common West Indian form. The presence of identical fresh-water species, both in the West Indies and in West Africa, is a very remarkable fact, but not an isolated one among the Decapoda. We know another group of fresh-water Crustacea which shows the same peculiarity. Of the genus *Palaemon* there are three species described from West Africa, two of which, *Pal. jamaicensis* (= *vollenhoveni*) and *Pal. olfersi*, are likewise present in the West Indies, and one, *Pal. macrobrachion*, is closely allied to a West Indian species, *Pal. acanthurus*.²⁸ In *Atya* the identity of species of both continents bordering the Atlantic is due, no doubt, to other reasons than in *Palaemon*, the latter being a very recent genus, having immigrated to the fresh-waters quite recently, while some species are now immigrating from the sea to brackish and fresh-water. On the contrary, the immigration to fresh-water of the ancestors of *Atya* took place a long time ago, and, I think, this fact indicates a former connection of Africa and America.

The other range of the genus *Atya* extends over the islands of the Pacific from Sumatra to the Samoan islands. None is recorded from southern Asia, from the islands of the Indian Ocean, or from East Africa.²⁹

The two species described by A. Milne-Edwards from New Caledonia, *A. margaritacea* and *robusta*, are very doubtful, as I have stated above. I do not know another example of a fresh-water

²⁸ See Ortmann, *ibid.*, p. 747.—*Palaemon vollenhoveni* is certainly the same as *Pal. jamaicensis*; in the paper quoted I supposed them to be nearly allied, but distinct species.

²⁹ Only Hilgendorf (*v. d. Decken's Reisen*, III, 1, 1869, p. 101) records a very doubtful species from the Seychelles, belonging, perhaps, to *Atyoida*.

Decapod restricted to New Caledonia. Our present knowledge of the fresh-water fauna of the Pacific islands leaves it very improbable that New Caledonia has an isolated fauna, differing from that of the other islands. It is probable, on the contrary, that species found in New Caledonia will be found also in other islands, but since A. Milne-Edwards, in 1864, described these two species, they have never been recorded from any place in the Pacific. It may be added that the differences of these species from the West Indian, *A. scabra*, given by A. Milne-Edwards, are scarcely at all present. I am, therefore, induced to suppose that both are erroneously recorded from New Caledonia, the true locality being the West Indies, and that they are identical with *A. scabra*.

If these considerations are correct, the genus *Atya* can be divided into two groups: the one containing the species bearing on each side of the rostrum at the base a spiniform angle, the other containing the species without a spiniform angle. To the first belong the species *A. scabra*, *gabonensis*, and *crassa*, their range extending over tropical America and West Africa; to the second belong *A. moluccensis*, *spinipes*, and *brevirostris*, the range of which comprises the Indo-Malaysian and Pacific islands. The last named species, *brevirostris*, forms a transition from the second group to the first. Then the range of the genus *Atya* would be divided into two parts, each containing a separate group of the genus, and this peculiarity could be explained by supposing that these two groups may be developed separately from each other after the separation of the former connecting range of the genus. This conjecture agrees with the fact, that *Atya* is the most extreme genus of *Atyidae*, and with its supposed recent age.

We know that some fresh-water animals are rapidly distributed over great distances, either in the adult or in the larval state, but in the *Atyidae* we know nothing of the means of distribution.

Comparing the other Crustacean Decapoda we may say, that the *Atyidae* have not been transported to great distances. Nor is it probable that the eggs can endure a long time without water, or that the larvæ or the adult animals can leave the water for any length of time. Transportation of the species of *Atyidae*, in either the active or passive state, from one fresh-water system to another over the land or through the air, cannot be supposed, at least over great distances. Neither can the *Atyidae* live in the sea, so that the

most important *topographical barriers* to distribution would be widely extending oceans and large tracts of land without fresh-water. The Pacific Ocean forms a barrier of the first kind, while the second may be partly connected with the *climatic conditions* of the warmer parts of the world. Smaller areas of sea and land, however, may be crossed by some forms, as is shown especially in the distribution of some species of *Caridina* and *Atya*³⁰. The means of distribution are certainly very limited, and therefore a great number of species are confined to very narrow districts.

Lastly, the ancient character of the family induces me to suppose that there are also *bionomic barriers*, the *Atyidæ* not being able to immigrate to localities occupied by other fresh-water animals better equipped for the struggle for existence.

I regret very much that exact observations on the habits of the species of *Atyidæ*, on the biology and bionomy, are wholly absent. It is very probable that the different genera and species on farther examination will show some differences, especially that the best developed are more resistant to external influences.

The conditions of geographical distribution of the *Atyidæ* are as follows:—

1. The *Atyidæ* cannot endure cooler climates. (*Climatic barriers*.)
2. They are true fresh-water animals. (Oceans and tracts of land without water form *topographic barriers*.)
3. Being animals of an ancient type, they are probably restricted by the occurrence of other fresh-water animals. (*Bionomic barriers*.)
4. The faculties of distribution are very limited.

The *Atyidæ* are, therefore, confined to the fresh-waters of the tropics and subtropics; the distribution of the genera and species, especially of the more primitive ones, shows a remarkable character of survival. Only *Caridina* and *Atya* are of a more recent character, extending over continuous areas within the tropics. Because of the antiquity of the family it has no relations among the recent forms of the litoral regions of the tropical seas.³¹

³⁰ *Caridina tyfus, wycki, nilotica; Atya scabra, moluccensis, spinipes.*

³¹ Such relations to the *Atlantic, Indo-Pacific, and Western-American* regions (see Ortmann, *Jenaische Denkschr.*, VIII, 1894, p. 76) are not at all evident, none of the well-known genera or species being limited by the borders of one of these regions.

NOVEMBER 6.

The President, GENERAL ISAAC J. WISTAR, in the Chair.

Forty-one persons present.

A paper entitled "The Batrachia and Reptilia of the University of Pennsylvania West Indian Exploration of 1891," by Edw. D. Cope, was presented for publication.

NOVEMBER 13.

The President, GENERAL ISAAC J. WISTAR, in the Chair.

Thirty-nine persons present.

Papers under the following titles were presented for publication:—

"The Structure and Relationships of *Ancodus*," by W. B. Scott.

"A Supplementary Note to Mr. Johnson's List of Jamaica Diptera," by T. D. A. Cockerell.

NOVEMBER 20.

The President, GENERAL ISAAC J. WISTAR, in the Chair.

Ninety-five persons present.

The deaths of the following members were announced:—

Robert E. Peterson, Archibald McIntyre, Samuel Jeanes and Joseph Jeanes.

A paper entitled "A New Jumping Mouse from the Pacific Slope," by Samuel N. Rhoads, was presented for publication.

DR. JOHN MACFARLANE read a communication on the Movements of Plants under Plates of Colored Glass. (No abstract.)

NOVEMBER 27.

The President, GENERAL ISAAC J. WISTAR, in the Chair.

Fifty-eight persons present.

Papers under the following titles were presented for publication:—

"The Osteology of *Hyænodon*," by William B. Scott.

"A New Insectivore from the White River Beds," by William B. Scott.

“Some New Bees of the Genus *Perdita*,” by T. D. A. Cockerell.

“*Pterodrilus*, a Remarkable *Discodrilid*,” by J. Percy Moore.

The Publication Committee reported in favor of publishing a paper entitled “The Structure and Relationships of *Ancodus*,” by William B. Scott, in the *Journal of the Academy*.

William L. Whitaker and J. Carroll McCaffrey were elected members.

The following were ordered to be printed:—

A SUPPLEMENTARY NOTE TO MR. JOHNSON'S LIST OF JAMAICAN
DIPTERA.

BY T. D. A. COCKERELL.

I was very much pleased to receive from Mr. Johnson his list of Jamaican Diptera, which will form a good foundation for a better knowledge of the subject. The purpose of this supplementary note is to point out a few omissions; and also to add a few species which were determined for me at the U. S. National Museum.

CECIDOMYIDÆ.

Diplosis coccidarum Ckll., Entom., 1892, p. 181. Kingston.

CHIRONOMIDÆ.

Ceacta furens Poey, Twms., Jn. Inst. Jamaica, I, p. 381.

PSYCHODIDÆ.

Psychoda sp.

Will be elsewhere discussed by Dr. Williston.

TIPULIDÆ.

Limnobia sp. incert., Balaclava (Ckll.), in U. S. N. M.

STRATIOMYIDÆ.

Cyphomyia n. sp. (not named). Williston, Canad. Ent., 1885, p. 125.

Pachygaster pulcher Lw. Mandeville (Ckll.), in U. S. N. M.

SYRPHIDÆ.

Pteroptila sp. (not *cincta*). Ckll., Jn. Inst. Jamaica, I, p. 74.

See also a forthcoming paper on Syrphidæ by Prof. Townsend.

MUSCIDÆ.

Musca doméstica L., Ckll., Jn. Inst. Jamaica, I, p. 56. Kingston.

MICROPEZIDÆ.

Calobata fasciata Fb. New locality, Mandeville (Ckll.), in U. S. N. M.

TRYPETIDÆ.

Trypeta (Acrotoxa) suspensa Lw., var. Mandeville (Ckll.), in U. S. N. M.

PHORIDÆ.

Phora scalaris Lw. Mandeville (Ckll.), in U. S. N. M.

HIPPOBOSCIDÆ.

Trichobius dugesii Twms. Ckll., *Jn. Inst. Jamaica*, I, p. 98.

With these, the known Jamaican Diptera amount to 125 species.

A NEW JUMPING MOUSE FROM THE PACIFIC SLOPE.

BY SAMUEL N. RHOADS.

Zapus trinotatus sp. nov. Type, ad ♂, No. 360, Coll. of S. N. Rhoads. Lulu Island (mouth of Frazer River), British Columbia, May 31st, 1892. Col. by S. N. R.

Description.—Size large, equalling *Zapus princeps* from Colorado, but with a shorter foot. Colors above as in *princeps*, but darker, the yellowish-gray suffusion on back and sides of that species being replaced in *trinotatus* by brownish-fulvous; the cheeks, ears, upper head, circumocular region, and upper surface of tail much blacker. The upper surface of wrist is black with fulvous anterior edging reaching to foot. Lateral stripe separating upper and lower body colors, dark fulvous, narrow, and reaching from hams to and around front of fore legs, and nearly meeting across throat. The throat, chin, belly, vent, and lower (inner) surfaces of legs are a clear soft white. In the center of lower throat and on each side of the sternum is a well-defined spot of fulvous about 8 mm. long and 3 mm. wide, the pectoral spots being the larger and more strongly colored. The fulvous of these spots does not reach base of hairs, their roots being white, as in the hairs of the fulvous lateral stripe.

Skull differing from any described form in its great relative width and depth, to length, the zygomæ being more flaring, the parietals more convex, the incisive foramina larger and broader posteriorly, the postpalatal notch more acuminate and indenting the palatal bones as far as m. 2. The upper premolar is larger than in *princeps* or *hudsonius*, its crown rising to the grinding plane of the true molars and becoming functional, bearing on its inner and posterior rim a crescentine loop partially enclosing a central cusp whose base lies on the outer anterior angle of the crown. In *princeps*, its nearest ally, this tooth is not functional, or rarely so, its apex falling below the grinding plane, and, as in *hudsonius*, consisting of a simple peg-like process with the folding being more or less obsolete. The lower molars of *trinotatus* are relatively larger than in *princeps* or *hudsonius*, the posterior loop of m. 1 and the second and last loops

of m.2 projecting exteriorly beyond the outer edges of their intervening loops, forming a very irregular outline not seen in the latter species. In *trinotatus* the inferior m.3 is relatively large, one-and-a-half times as long as wide and made up of a more complicated series of loops than in the same tooth of its allies. The coronoid process is much lengthened, wide across base, blunt and distinctly notched at tip. The angular process of mandible is perforated by a single minute foramen; in the other forms it is multiperforate or incised by two, conspicuous, oblique slits.

Measurements of Type (in millimeters).—Total length, 234; tail vertebrae, 139; hind foot, 32. (Topotype, length, 235; tail, 142; foot, 32.) Skull—Total length, 24; basilar length, 17.5; zygomatic width, 13; nasal length, 9.8; interorbital constriction, 4.8; height of cranium, 9.8; length of mandible, 12.5; width of mandible, 6.8.

Two males of this species were taken at Lulu Island. Another from Mason Co., Washington, is referable to it.

Zapus trinotatus is the West Cascade representative of *Z. princeps*. Several specimens of jumping mice taken at Lac La Hache, B. C., and at Vernon, in the same province, are referable to *princeps*, whose range will probably be found to be limited to the East Cascade and Rocky Mountain regions of the United States and of southern British America. It is probable that the range of *hudsonius* will be found to reach far to the west in northern British America.

I am indebted to Mr. G. S. Miller, Jr., for the loan of specimens of *Z. princeps* for this study.

ON A COLLECTION OF BATRACHIA AND REPTILIA FROM THE
ISLAND OF HAINAN.

BY E. D. COPE.

The collection on which the following notes are based was made by the Rev. Francis Gilman, who sent them to Prof. Chas. S. Dolley. Prof. Dolley placed them in my hands for identification and description.

Hyla arborea var.

This form agrees in structural features with the true *Hyla arborea* of Europe, but differs in coloration, not only from this but from the two subspecies which are known from Eastern Asia (*H. a. chinensis*, and *H. a. japonica*).

The extended hind limb marks a point between the eye and the nostril with the heel. The vomerine teeth are between the internal nostrils, but the posterior borders of the fasciculi are behind a line which connects their posterior borders. The diameter of the tympanum is about half that of the eye; and the interorbital width is greater than that of an eyelid. The length of the head to a line connecting the posterior borders of the tympana, enters the total length 3.2 times. The fingers are slightly webbed, and the toes are about two-thirds webbed. There is a heavy glandular fold from the orbit to the shoulder.

The color is uniform green above, and uniform pale (perhaps yellowish) below. There are no spots of any kind anywhere. A light brown band extends from the eye through the tympanum and disappears about the shoulder. It has neither dark nor pale borders, and is hence very indistinct. A similar band extends from the eye to the nostril. Upper lip not pale bordered nor spotted. Total length, 40 mm.; do. of hind leg from groin, 59 mm.; of hind foot, 27 mm.

Holarchus dolleyanus sp. nov. Plate X, fig. 1.

Scales in seventeen rows. Superior labials eight, all higher than long, the fourth and fifth entering the orbit, the sixth in contact with the inferior postocular only, the seventh in contact with the lower postocular, and more extensively with the parietal. Loreal trape-

zoid; oculars 1-2; temporals 0-2. Internasal mutual contact short; parietals short, wide, truncate posteriorly, bounding both postoculars posteriorly. Pregenials bounded by four labials, a little longer than postgenials. Gastroteges, 164, obtusely angulated; anal entire; urosteges, 36.

Color above yellowish-brown; below brownish-yellow. No marks on the head; on the superior surface of the body there are indistinct cross bars, which consist of the dark edges of scales, at intervals of two and three scales; they are not continued on the tail. Total length, 400 mm.; of tail, 58 mm.

This species probably resembles the *H. swinhonis* Gthr. (Rept. Brit. India, p. 215, Pl. XX, fig. E.); but it differs materially in having but one preocular; in the absence of an anterior temporal; in the contact of the anterior genial with four labials, and in the longer postgenial. The color above is pale brown, not olive.

The hemipenis of this species is smooth, and without spines, flounces, or ruches; agreeing with that of the *H. ancorus*, as figured by me in the "American Naturalist," 1894, Plate XXVII, fig. 4. These characters refer the genus to the Calamariinæ, with *Oligodon*, etc. (See "American Naturalist," 1893, p. 480.) A character of subordinate value seen in the hemipenis of *H. ancorus*, which is not present in *H. dolleyanus*, is a shallow pocket on each side of the sulcus spermaticus.

There is a rudimental right lung 5 mm. in length, communicating with the trachea by foramen. No tracheal lung.

This species is dedicated to my friend, the distinguished zoologist, Dr. Chas. S. Dolley.

Pareas mœllendorffii Bœttger.

A single male specimen gives me an opportunity of determining the position of this curious genus. With some external resemblance to the American *Leptognathus*, it combines not dissimilar dentition and squamation; it is to be presumed that the habits are not dissimilar. Examination of the hemipenis shows, however, that it is really related to the Calamariinæ, and to *Simotes*. This organ is without spines or ruches, and has only flat obtuse papillæ on the middle third of its length, the distal portion being smooth, with a few feeble papillæ at the apex. It is deeply bifurcate, the basal portion being quite short. At the summit of the middle papillose

section is an oblique membranous flounce with a lobate margin. No tracheal lung; and I could find no right lung.

Amphiesma stolatum L.

In this species the hemipenis displays the usual natricine characters of a basal hook, and small spines reaching to the apex, without ruches or flounces. The spines are, however, coarser than in most other species. The organ, moreover, is undivided, and with undivided sulcus, and as *A. stolatum* is the type of the genus, the latter must be defined accordingly, and not as divided, as I inferred from an examination of allied species which have been referred to it by authors.¹ These supposed species of *Amphiesma* which I have examined, which have divided hemipenis and diacranterian dentition, are also characterized by the presence of fossæ of the hemipenis from the center of each of which a spinule issues. These are the *Amph. tigrinum* and *A. ceylonense*, and they belong to my genus *Bothrodytes*, which name should take the place of *Amphiesma* in my original Prodrômus, l. c. The genera of Natricinæ with basal hooks will then be as follows:—

I. Fusiform types; hemipenis and sulcus undivided.

Hemipenis simple; anal divided;

One internasal, scales keeled; *Haldea* B. & G.

Two internasals, scales keeled; *Amphiardis* Cope.

Two internasals, scales smooth; *Virginia* B. & G.

Hemipenis with two apical papillæ; anal entire.

Two internasals; scales keeled; *Tropidoclonium* Cope.

II. Colubriform types.

a. Hemipenis undivided.

b. Dentition syncranterian or isodont.

Anal plate entire; a loreal; *Eutania* B. & G.

Anal plate divided; no loreal; *Storeria* B. & G.

Anal plate divided; a loreal; *Natrix* Laur.

Anal plate divided; a loreal; one prefrontal; *Trimedytes* Cope

bb. Dentition diacranterian.

Scales keeled; two internasals; *Amphiesma* D. & B.

Scales smooth; one internasal; *Liodytes* Cope.

aa. Hemipenis divided.

b. Dentition syncranterian.

¹ American Naturalist, 1893, p. 483.

Hemipenis with two apical papillæ;	<i>Ceratophallus</i> Cope.
Hemipenis without papilla;	<i>Diplophallus</i> Cope.
<i>bb.</i> Dentition diacranterian.	
Hemipenis without papilla;	<i>Bothrodytes</i> Cope.

Trimerodytes balteatus gen. et sp. nov. Plate X, fig. 2.

Char. gen.—Characters of *Natrix*, but the prefrontals fused. The dentition is syncranterian or coryphodont. Hemipenis undivided, sulcus simple.

The single species on which this genus is proposed is represented by an individual which, while apparently not very young, is at the same time not fully grown. As a consequence the spinules of the hemipenis are not ossified, appearing as fine flexible papillæ. This is the condition normal to immature snakes, as I have observed in the genera *Drymobius*, *Bascanium*, etc.

Char. specif.—Scales in nineteen rows, smooth, except on the tail, where all except the lateral rows are feebly keeled, and for a short distance in front of the vent, where about three dorsal rows are also weakly keeled. Each internasal longer than wide. Frontal rather wide, with straight borders, the anterior a little longer than the lateral. Parietal moderately elongate, angulate posteriorly, and embracing only the superior postocular. Loreal higher than long; oculars 1-2 or 3; temporals 1-2. Superior labials nine. These are differently distributed on opposite sides, so that the numbers may be in other specimens, eight or ten. One labial forming most of inferior border of orbit, which may be the fourth or fifth; the angle of the succeeding labial enters the orbit. On one side two plates represent the single last upper labial on the other. Inferior labials nine; pregenials shorter than postgenials, and bounded by six labials. Gastrosteges, 202; anal, 1-1; urosteges, 84.

Color black, crossed by white or pale yellow rings. These have a width of half of a scale on the middle dorsal region, and widen downward, covering two or three gastrosteges. They are frequently broken on the middle line, the halves alternating, both on the back and belly. The labials and oculars have yellow centers, and there is a yellow line from near the angle of the mouth to near the middle line above. A pair of yellow spots are on each side of the common suture of the parietal plates.

Total length, 377 mm.; tail, 80 mm.

Bothrops erythrurus Cantor.

Before leaving the Ophidia I add some remarks on the penial characters of some species which do not enter the present collection, and which I have recently examined.

The genus *Anomalodon* Jan (*Lioheterodon* Boulenger, from a nom. nud. of Dum. & Bibr.) has the hemipenis deeply divided and covered with minute spines, without large hooks at the base. It is to be referred to the Pseudaspidineæ of my Prodrômus, approaching the genus *Pseudaspis* m. of S. Africa. Boulenger has shown that it has the natricine hypapophyses.

The Australian *Dipsas fusca* Gray, differs from the genus *Dipsas* in the absence of spines from the hemipenis; the characters are otherwise as in *Dipsas*. I propose to name this new genus *Liophal-lus*, with *L. fusca* as type.

I propose to separate *Drymobius percarinatus* Cope from *Drymobius* as the type of a distinct genus under the name of *Cacocalyx*. It differs from that genus in the structure of the terminal half of the hemipenis. Instead of the usual papillose calyces, there are rows of spines on longitudinal folds, and the apex is covered with a few large, shallow, smooth-edged calyces, which are separated from the spinous portion by a continuous transverse fold, *i. e.*, the apex is capitate. I have compared this organ with the corresponding ones of *Drymobius margaritiferus* (type); *D. pantherinus*; *D. reticulatus*; *D. boddaertii*, and *D. pulcherrimus*, where they are essentially alike. The genus *Cacocalyx* is quite different from any other form of Colubrineæ.

The *Cyclophis major* Gunth., presents the penial characters of the Colubrineæ, but has an especial peculiarity not shared by any other species with which I am acquainted. In the proximal internal wall of each calyx is a transverse comb of a few spines. These do not graduate into the spines of the middle of the hemipenis, which are well developed. The borders of the calyces are serrate to papillose. As this type is clearly not referable to any known genus, I propose to distinguish it by the name of *Enterchinus*. It is evidently not very nearly related to *Liopeltis* and *Cyclophis* of N. America.

The genus *Macroprotodon* (Guich.) has the apical region of the hemipenis calyculate, and the papille at the angles of the calyces are spinous (*i. e.*, ossified) to near the tip. There are numerous

spines below the calyces. Hemipenis simple. The genus belongs to the Dipsadinæ.

Psammodynastes has a divided penis which is spinous to the tip and not calyculate. The spines are arranged in the branches in oblique series, pinnate to the sulcus. Not knowing the structure in *Psammophis* I cannot determine the affinity of the genus.

In *Osceola (elapsoidea)* the penial characters are like those of *Ophibolus doliatus*; i. e., the calyces are numerous and fringed. In *Ophibolus* they are very few and have entire borders. I therefore place *O. doliatus* in *Osceola*. All the species of *Ophibolus* agree in the character assigned.

The *Dromicus flavilatus* Cope, of the S. E. coast regions of the United States, has the penial structure of *Rhadinaea* Cope, and does not belong to *Dromicus*. The organ is undivided, and the calyculate region is capitate. We have here a case parallel to the genus *Liodytes*, of which the type species was supposed to be a *Helicops*. Both these Floridan forms turn out to be allies of types found on the North American continent.

Causus Licht. has the character of other *Solenoglyphæ*, i. e., coarsely spinous at the middle, and calyculate above, and deeply bifurcate. In *C. rhombeatus*, the only species examined, there is at the middle of each branch a longitudinal fissure-like interruption of the calyculate structure which contains feeble laminae on its sides and fundus. The calyces are papillose.

As regards the structure of the lungs, I have to add observations on two species not previously examined. In *Anomalodon madagascariensis* there is no tracheal lung nor auricle of the large left lung. The rudimental right lung measures about 6 mm. In *Psammophis irregularis* the structure is similar in the points mentioned, except that I could not discover a rudimental right lung.

Calotes versicolor Daud.

THE BATRACHIA AND REPTILIA OF THE UNIVERSITY OF PENNSYLVANIA WEST INDIAN EXPEDITION OF 1890 AND 1891.

BY E. D. COPE.

The species enumerated or described in the following pages were collected in the course of a yachting expedition conducted by Professor J. T. Rothrock, at that time Professor of Botany in the University of Pennsylvania, among the northern islands of the West Indies. Collections were made at the following islands of the Bahama group: New Providence, Eleuthera, Watlings Island, Crooked Island, and Great Inagua. They next touched at the eastern point of Jamaica, at Port Morant, and later at Port Luce at the western extremity. The last collections were made at Grand Cayman Island. The zoologist of the expedition was Mr. J. Percy Moore, now Instructor in Comparative Anatomy and Zoology in the University of Pennsylvania. To his care we are indebted for an excellent series of the vertebrata of the islands visited. The collection of Batrachia and Reptilia enumerated in the following pages is one of the best ever made in the region. Collections from Crooked Island and Inagua are especially welcome as but little was previously known of their vertebrate fauna. Mr. Moore has furnished me with notes of his observations, which are added in their places, in quotation marks.

NEW PROVIDENCE.

Trachyocephalus septentrionalis Tsch.

"This large tree toad was met with abundantly everywhere in the Bahamas and on Grand Cayman. About the sisal plantations on New Providence great numbers could be taken, one or more being concealed beneath the bases of the thick, fleshy leaves of almost every plant. Their cry, when taken in the hand, is very startling, having much of the force, quality, and pitch of the cry of a young infant. They are said to spawn in the wells."

Anolis principalis Linn.

Anolis sagrae D. & B.

"This is one of the most widely distributed and abundant of

Bahaman Anoles. The species is most characteristic of the more northerly islands; of those visited by us they are very abundant on New Providence, fairly swarming on Eleuthera, and less common on the islands south and east. We failed to find this species on Fortune Isl. and Great Inagua. They are equally at home on the ground and in trees, preferring to seek their food on the former. They are very pretty, when raised high on the fore-legs, with head elevated, and body in a quiver of excitement, they pause to detect the movement of an insect, upon which they spring with much agility, and devour in an instant. Their principal food is ants, which they seek along fences, by the roadside, among the trees, and in and about houses. Like the other Anoles they are fond of sunning themselves and lie on stones or fences with the legs stretched lazily along the sides of the body. On the island of Eleuthera, where they are known to the natives by the name of Iquana, they are fond of lying on the branches of bushes overhanging the fresh-water ponds. Outside of the Bahamas *A. sagre* was met with in Jamaica, where they are particularly abundant on the north shore about Port Lucea."

Anolis distichus Cope.

"Common on New Providence, and less so on Eleuthera. Their habits in general resemble those of *A. sagre*, but the species is especially common on the ground in banana and sisal plantations."

Anolis oligaspis sp. nov. Plate XI, fig. 5.

Tail little compressed at the base (mostly lost), and with a larger median dorsal row of scales. Scales minute, a few dorsal rows scarcely larger; ventrals much larger, smooth. Tibia about as long as head to posterior border of orbit. Occipital plate oval, larger than ear opening (transversely divided in the single specimen), separated from supraorbitals by one row of scales. The supraorbitals are in contact, and they are continued as a row of two large scales only between the anterior one which borders the orbit, and the scales of the canthus rostralis. The first pair of these two large scales is separated by a single row of small scales; the second is separated by three rows, of which the median is the largest, and continues to between the nares. Thus at the second large scales there are five rows of scales across the muzzle between the canthal scales, of which the lateral and median are larger than the other two. All scales of muzzle without keels; a shallow basin between large rows. Canthal

scales three. Supraoculars forming a disc of seven smooth scales, which is in contact throughout its inner border with the supraorbital series. Loreals in five rows.

The muzzle is rather short, and the extended hind limb reaches to the orbit. There are thirteen laminae beneath the second and third phalanges of the third and fourth toes.

The only specimen is a female, and it is greenish-gray with a brown band on each side of the vertebral line, which is similar in color to the sides. Throat with longitudinal series of blackish spots.

Length to vent, 44 mm.; do. to line of meatus auditorius, 14 mm. Length of fore limb, 19 mm.; do. of hind limb, 34 mm.; of hind foot, 14 mm.

This species is remarkable for the reduction in the number of its head scales. It resembles no other species nearly, unless it be the *Anolis krugii* Peters, of Porto Rico, which I have not seen. There are numerous discrepancies in the description of the latter. For instance, in *A. krugii*, the ventral scales are keeled, the superciliaries are separated by a row of scales; the supraorbitals are keeled; there are four enlarged dorsal rows, and the color is quite different.

Amiva thoracica Cope.

“A common and conspicuous species, especially in the northernmost of the Bahama Islands. Like its allies this is essentially a ground inhabiting species, living among the loose coral boulders, in the crevices of which secure shelter and concealment may be found. They love to lie on stones basking in the warm sunshine, but are ever alert and dart away like a flash, their course being indicated by a blue streak. They are extremely difficult to catch, and although very abundant on Cat Isl., and almost equally so on Eleuthera, only a very few specimens were taken.”

Ungualia maculata D. & B.

Alsophis vudii Cope.

CAT ISLAND.

Alsophis vudii Cope. Port Howe.

ELEUTHERA.

Anolis principalis L. Tarpum Bay.

“A most beautiful species of essentially arboreal habits. Widely distributed, but apparently not very common anywhere. They are found among the smaller trees and bushes, leaping actively about

and performing many interesting acrobatic feats in pursuit of insects. New Providence, Governors Harbour, and Tarpum Bay, Eleuthera, Port Howe, Cat Isl., French Wells, Crooked Isl., and Fortune Isl."

Anolis sagræ D. & B. Tarpum Bay.

Ungualia maculata D. & B. Tarpum Bay.

"This species is common throughout the Bahamas visited by our party, but the *U. cana* was found only on Great Inagua. The species have similar habits. They are found during the day coiled up under stones in the dryest, hottest places with such incompatible company as centipedes, scorpions, and tarantulas, for they are very mild tempered little snakes."

CROOKED ISLAND.

Anolis principalis brunneus subsp. nov. Plate X, fig. 3.

This form is allied to *A. principalis*. It has the same shaped head, and the same squamation of the body, with similar proportions of limbs. It falls outside the usual range of variation of *A. principalis* in some points of squamation of the head, and in the color. Thus the supraorbital rows of scales are continued forward, to between the nostrils, not reaching the canthus rostralis, and are in contact throughout, except an occasional separation by a single scale. Thus there are but 4-5 rows across the front instead of 7-8 in *principalis*. There are but three loreal rows, the middle one consisting of but one or two scales, while there are 5-7 in the *A. principalis*. The six or seven supraocular plates are of subequal size and are obscurely keeled, and are in immediate contact with the supraorbitals; in *A. principalis* they are of unequal size and are separated from the supraorbitals by a series of small scales. On the inferior side of the second and third phalanges of the fourth digit of the posterior foot there are 18, 20 lamellæ, in the *A. principalis* there are 24.

The color is different from that of any stage or variety of the *A. principalis*. Above and on the sides leather-brown. On each side two dark brown stripes, the superior the wider, and sending cross processes towards the middle line of the back. Posteriorly it is broken up into a series of dark brown spots which become wider, and finally unite in crossbars on the tail. Below light yellowish, the throat indistinctly lined with darker.

Total length, 123 mm.; do. to vent, 43 mm.; to line of auricular meati, 14 mm.; of fore limb, 15 mm.; of hind limb, 27 mm.; of hind foot, 12 mm.

Liocephalus carinatus Gray.

Scales in 46 rows; 5-6 supraoculars; 3 introfron-tonasal scales.

"Generally distributed throughout the Bahamas; this species is especially abundant on Crooked Isl., where Anoles are comparatively uncommon. The larger vegetation is very sparse here and loose piles of coral rock near the shores are overgrown by a comparatively open bush or scrub. It is here that the species abounds, scurrying about on the ground and only rarely climbing into bushes. They are very inquisitive creatures and come close up to look at one, then running back a yard or two, pause again, and raising themselves on the fore-legs, look about with elevated heads, a strange admixture of curiosity and timidity, ready to run again at the slightest alarm. While in running the Anoles only slightly raise the tail from the ground, and the Ameivæ drag it straight out behind, this species elevates the tail high over the back, where it forms, pig-like, a spiral coil, which peculiarity has gained for them the name of curl-tail lizards. This species hides among the rock crevices, and large numbers take advantage of the burrows of the land crab (*Gecarcinus*) as places of concealment. Though active, they are easily caught in the hand, or by means of a grass noose. Their tails part very readily and one is frequently rewarded for his pains with only that squirming member. Highly carnivorous and very voracious they apparently do not pause even at cannibalism, as was illustrated once when a detached tail fell from my hand to the ground, where its movements attracted the attention of an individual of the same species, which ran down from the rocks fully twenty-five feet away, picked up the tail and bore it off. A few minutes later it was seen with the tip of the still squirming tail of its neighbor hanging from between its teeth. On another occasion a warbler which was shot and had fallen to the ground, was found guarded by a large curl-tail which seemed about to attack it."

GREAT INAGUA.

Anolis moorei sp. nov. Plate XI, fig. 4.

Characters those of a prevalent West Indian type, *i. e.*, tail compressed and with a larger median superior row of scales, and ab-

dominal scales smooth. The affinities are with the *A. cybotes* Cope, of San Domingo, but the scales of the sides and most of the back are twice as large, and the median dorsal rows are not abruptly larger than those adjoining. Frontal ridges low, and median basin shallow. Tibia shorter than length from muzzle to ear. Scales of muzzle moderate, smooth. Superciliary rows separated by one row of scales except for a short distance, where they are in contact. Supraoculars 13-15, smooth, those of internal and adjacent rows subequal, the whole separated from the supraorbitals by small scales of different sizes. Occipital plate equal auricular meatus, separated from supraorbitals by three rows. Five loreal rows; four canthal scales, the latter connected with anterior supraorbital by two rather large scales, which are separated by four rows of scales. In front of the basin there are nine rows of scales counting across the muzzle, of which the median row is much enlarged. In *A. cybotes* there are but two or three rows in the frontal basin, and the middle row on the muzzle is not enlarged. Twenty-four lamellæ under the second and third phalanges of posterior fourth toe. Fan of male reaching to between humeri. Male with postanal plates rudimental.

Color ashen, thickly mottled with small, black spots on the sides and back, and upper surfaces of limbs. Spots smaller on nape. A black band from nostril through lower eyelid to ear. Fan greenish-black in alcohol. In a smaller specimen, perhaps a female, as the fan is small, there is a dark band across the supraoculars, and the occiput is reticulated with black. The median dorsal region is covered by a dark brown band.

Total length of male, 195 mm.; do. of head to ear, 10 mm.; do. to vent, 72 mm.; do. of fore limb, 31 mm.; do. of hind limb, 55 mm.; of hind foot, 23 mm.

This species differs from its nearest ally, the *A. cybotes*, in the larger scales, the different arrangement of the muzzle plates, the more numerous supraorbitals, and mostly widely in the coloration. In size it exceeds that species. It is dedicated to my friend Mr. J. Percy Moore, Instructor in Zoology and Comparative Anatomy in the University of Pennsylvania, who captured the type specimens.

“This handsome species was found only on Great Inagua where it is quite common. They are distinguishable at sight, during life, from any species met with elsewhere by their comparatively large size and pale gray-brown spotted color, which on occasion changes to

a more or less intense brown. Though very active in their movements they are readily approached and captured, but have an uncomfortable habit of seeking shelter among the thick clumps of a very spiny *Agave*."

Anolis cinnamomeus sp. nov. Plate XII, fig. 6.

Tail compressed, with enlarged median dorsal row; ventral scales keeled. A few keeled median dorsal rows nearly equal to ventrals, but soon graduating into the smaller laterals. Caudal scales keeled. Tibia shorter than head to ear; extended hind leg reaching to eye. Fifteen laminae on second and third joints of posterior fourth toe. Occipital plate equal to auricular meatus, and separated from supraorbitals by three rows of scales. Supraorbitals in contact with each other, the anterior separated from the canthal row by two large scales. Between the latter is a shallow basin containing two series of scales. Three canthal scales. Between them on the front part of the muzzle may be counted seven scales, of which the median is large, being one of a median longitudinal row. Scales of muzzle smooth. Supraocular few, only six large ones and a few small ones at their external border; not, or faintly keeled, and separated from the supraorbitals by a single row of small scales. Five and four rows of loreal scales. The muzzle is of intermediate length.

Color above brown; sides pale brown; inferior surfaces pale. Back, sides and throat speckled with rather coarse black dots, which are on the back rather frequently fused into short lines both longitudinal and transverse. A black spot on the loreal region; the lower eyelid dark. Top of muzzle in front of orbits pale.

Length from muzzle to vent, 45 mm.; to posterior line of ears, 13 mm.; of fore limb, 19 mm.; of hind limb, 24 mm.; of hind foot, 15 mm.

This rather small species is allied to the *A. cybotes* and the *A. moorei*. It agrees with the latter in the character of its scales, but differs from both in the small number of both the supraocular plates, and the subdigital lamellae, and in the contact of the supraorbital plates, and the reduced number of the scales on the muzzle. It is darker colored than the *A. moorei*, but is similarly speckled with black.

Two specimens were collected by Mr. Moore, which from the small size of their fans I suspect to be females.

Liocephalus sp.

“A distinct *Liocephalus*, probably *L. schreibersii* Gray, was plentiful on Great Inagua, but the specimens have been mislaid. It is a rather smaller, more active species which carries the tail elevated but not curled.”

Ungualia cana Cope.

On comparison of this species with others of the genus I have occasion to reassert the distinctness of the *U. haitiana* Cope from the *U. maculata* with which it is united by Boulenger in the Catalogue of Snakes in the British Museum, Vol. I. In the original description (Proceed. Amer. Philos. Soc., 1879, p. 273), the statement is made that the scales are in twenty-seven longitudinal rows, which they are at some points; but at the stoutest part of the body they are in twenty-nine rows. In *U. maculata* they never exceed 25 rows, and are usually 23. There are no interparietal plates; these are always present in the *U. maculata*.

In the genus *Ungualia* the anal claws are of irregular occurrence. In seven specimens before me they are present in only three. The same is true of the genus *Charina*, also usually regarded as peropodous. In two specimens before me they are wanting.

Amiva leucomelas sp. nov. Plate XII, fig. 8.

Ten rows of abdominal scales. Caudal scales oblique, diverging backward and outward on each side of the median series, keeled, the keels parallel to the middle line. Nostril within the border of the internasal plate. Nasal triangular, small; one very large loreal plate; one preocular plate descending to the fourth superior labial; four suborbitals in contact with the labials except the fourth. Six narrow superciliaries; four supraorbitals; frontal not transversely divided. Two parietals on each side of the interparietal, which they do not quite equal in length, while each is about equal in size to the rather elongate interparietal. Two rows of small, smooth postparietals. Gular scales nearly uniform; some larger ones at the middle of the mesopterygium. Dorsal scales coarsely granular, round.

Three rows of plates on the forearm, the external much the widest; one row on the humerus with a much smaller row on each side of it; the former not continuous with the large row of the forearm. Three large and a few small preanal plates, which are continuous with the

abdominals. Femoral pores thirteen. Thirty-four transverse rows on the abdomen.

Median dorsal region brown, becoming blackish and then black anteriorly, the lateral border pale brown posteriorly, but becoming white anteriorly. A broad, black lateral band from orbit to above femur, bounded below by a narrow white stripe. Head brown on sides and above; limbs lead colored above. Inferior surfaces bluish-white; tail with the scales darker at the base than elsewhere. Near the base of the tail the darker color is leaden, but at the middle and beyond it passes to bluish and blue; and the pale portion varies in a corresponding way to pale blue. No black lines on posterior face of femur.

Length to vent, 57 mm.; do. of fore limb from axilla, 16 mm.; do. of hind limb, 35 mm.; of hind foot, 21 mm.

This very handsome species is allied to the *A. polops* Cope of St. Croix, but differs in several respects. The median dorsal scales are not enlarged, as in that species, and there are five fewer femoral pores, and the lateral caudal scales are keeled, not smooth. The coloring is quite different. In the *A. polops* the dorsal region is olive-gray, and there are three white longitudinal lines on each side and a pair of black lines on the posterior face of the femur.

"This handsome species was found only on Great Inagua where they occur very commonly. The colors are very bright during life and this fact, as well as their activity, makes them very pretty objects to watch. Much smaller than *Ameiva thoraicea*, which was not found on Inagua, and perhaps even more active, they are extremely difficult to catch, and specimens were only secured by recourse to the shot-gun. They frequent the paths and roadsides and the rocks about the shores."

JAMAICA.

Bufo agua Daud.

"This great toad is very common in the meadows along the streams about Lucea, Jamaica, where they are called frogs. Quite nocturnal in habit they spend the day in burrows beneath stones and rubbish, and at night come forth to splash through the water and rank grass along the shores of streams. When the light from a bull's-eye lantern is flashed on them they crouch and attempt to conceal themselves. In the water they are quite at home and swim easily, but on land progress in a very lumbering way, the legs seeming too weak

to propel the heavy body. Young ones were found concealed under rubbish.”

Hylodes martinicensis D. & B.

Port Lucea and Blue Peak.

Lithodytes lentus Cope.

A single example of this handsome black and orange tree-toad was taken at Port Lucea clinging to a shrub overhanging a stream.

Xiphocercus valenciennesi D. & B.

Port Morant.

“This fine species was rarely met with and was collected only at Port Morant and Port Antonio, Jamaica. At the former place lizards of all kinds are uncommon owing to the abundance of the mongoose, which animal has exerted a marked influence on the reptilian fauna of Jamaica. Snakes of all kinds have been exterminated so completely that we failed to find a single specimen. The same is true of the larger ground-inhabiting lizards.

The present species lives on and about the trunks of cocoanut trees.”

Anolis grahamii Gray.

Port Morant; Port Antonio; Port Lucea.

“Notwithstanding the mongoose, this species is generally abundant about the coast of Jamaica, and on Grand Cayman, though noticeably more so in thickly settled districts, where they are familiarly known as the clucking lizards, and welcomed into houses, over the walls and ceilings of which they run with apparent ease. Their habits were studied about Kingston and elsewhere. At midday in the hot sunshine along fences they are seen at their best. They extend and retract the brilliant scarlet goitre in a regular rhythmical way as a flattened fold, the body meantime passing through a remarkable series of color transitions from rich brown or almost a chocolate color, through pale browns, grays, dull greens to bright blue-greens, some individuals retaining more of one color, some more of another, sometimes plain, sometimes spotted, until one almost wearies in counting the variations and changes. The colors are more or less related at any moment to the colors of surrounding objects. This is a very active lizard which runs with great swiftness along the fences and branches of trees, often taking flying sidelong leaps of surprising length, but clinging surely by means of the adhesive disks, by which they are enabled to cling

even to such smooth surfaces as window panes. At Port Morant they were especially abundant in the cocoanut groves concealing themselves, when alarmed, beneath the matting which envelops the bases of the leaf petioles. Their food, in the vicinity of Kingston, is largely ants and wood ticks."

Anolis flabellatus sp. nov. Plate XII, fig. 7.

Allied to *A. grahamii* but with the abdominal scales smooth, the supraorbital scales continued as a distinct series of larger scales to the canthus rostralis; the scales of the muzzle not keeled. The occipital scale is about as large as the auditory meatus, and it is separated from the supraorbitals by one or two rows of scales instead of four or five as in the *A. grahamii*. Supraorbitals separated by one row of scales; supraorbitals, 13-14 keeled, and of various sizes, becoming smaller externally. The frontal ridges are not elevated as in the *A. lineatopus* Gray, but the front is flat, nearly as in *A. grahamii*. Three scales separate the anterior supraorbital from the canthus rostralis, which itself is marked by five scales. Seven rows on the muzzle between the canthus; ten rows in the *A. grahamii*. Twenty-one lamellæ under third and fourth phalanges of posterior fourth toe. The tibia is shorter than from the muzzle to the ear, and the extended hind foot reaches to the eye. The dorsal and lateral scales are of equal size. The fan is large, extending posterior to the axillæ in males.

Color above brown, lighter on the sides, and marbled on both regions with darker brown. Below pale with darker reticulations on the chin. Color of fan not dark.

Length to vent, 46 mm.; to ear, 13.5; do. of fore limb, 21 mm.; of hind limb, 36 mm.; of hind foot, 15 mm.

This species need only be compared with the *A. grahamii*, to which it is allied. Besides the characters mentioned, it is smaller, and is of a different color; the *A. grahamii* being more or less green, and not tending to brown. It resembles more strongly the *A. grahamii conspersus* of Garman, which is rather intermediate between the *A. flabellatus* and the *A. grahamii*. The *A. g. conspersus* is as large as the latter, and is peculiar in coloration.

From Port Morant and Port Lucea; abundant.

"A slender, pretty species found on the north shore of Jamaica at Port Antonio and Port Lucea. It is not very common, and is found

chiefly among the dense masses of aerial roots which hang from the trunks and branches of the Indian fig (*Ficus indica*), where it drives the would-be collector almost to distraction by quietly slipping into an ever present crevice just as his hand descends on the spot where, in his mental image, it still rests. Its slender form and brown color admirably fit it to its habitat. This species was also found just within the entrance of a cave at Port Antonio.”

Anolis sagræ D. & B.

Port Lucea.

Aristelliger præsignis Hallow.

Port Morant.

A small gecko, perhaps the young of this species, was taken by Mr. Moore at Port Morant, about January 12, 1891. Its colors are much more elegant than those of any specimen either adult or young which I have seen, but the scale characters are the same. The color is light fawn, darker on the head; a dark band through the eye; lips whitish spotted. A black scapular spot with a small, yellow center on each side; behind it a delicate vertical yellow line. Narrow vertical yellow lines on the sides, and indistinct brownish dorsal cross-bars behind the middle of the length. Length of head and body 27 mm.

Sphærodactylus goniorynchus sp. nov.

Lateral and anterior surfaces of rostral plate separated from superior surface by a curved, solid right angle, which is not continued posteriorly. Dorsal scales about equal to ventrals, acute, imbricate, keeled. Scales of top of head similar but smaller. Ventral and pectoral scales similar to dorsal, keeled. Tail covered everywhere with similar scales, whose free apices give it a chaffy appearance. Eyelid covered from middle of front to superior posterior border with large, chaffy scales which are larger than those on the front. Upper part of rostral plate split. Labials $\frac{4}{4}$. Muzzle short, its length from orbit equaling from orbit to auricular meatus.

Color dark marone above, below light reddish-brown, the colors blending on the sides of the body, but separated by a sharp undulating line on each side of the tail. An indistinct, undulating pale line extends from the neck on each side of the back and dorsal surface of the tail, which sends short processes inward, especially on the tail. This line is only clearly seen in the dead animal when it

is in spirits. Gular region paler, uniform. Total length, 43 mm.; length of body and head, 23 mm.

This species is well distinguished by the form of the end of the muzzle, and by the keeled ventral scales. The superciliary scales are also entirely peculiar, as they present several free points upwards and backwards, in place of the spine-like process found in the other species. Port Antonio.

GRAND CAYMAN.

Trachycephalus septentrionalis Tsch.

Anolis grahamii conspersus Garman.

“Very common on Grand Cayman, where they occur in great numbers about the gardens and banana orchards.”

Liocephalus varius Garman.

“Found only on Grand Cayman, where it is common among stones by the roadside, and in stone walls. Habits similar to *L. carinatus*.”

Aristelliger præsignis Hallow.

“Only one specimen taken on Grand Cayman. It clung so firmly to the tree trunk on which it rested that much of the skin of the bark was torn away in removing it. The habits of this gecko are similar to those described for its allies; while its sluggishness and stupidity distinguish it sharply from the other lizards here described.”

Alsophis angulifer caymanus Garman.

“This snake is very common on Grand Cayman, and I recall one stone wall by the roadside that was fairly alive with them. On the top stones many were lying warming in the sunshine, while from crevices everywhere heads protruded. Their movements and general actions resemble what is most familiar in our garter snakes.”

EXPLANATION OF PLATES X, XI, AND XII.

PLATE X.

- Fig. 1. *Holarchus dolleyanus* Cope, about 1.5 natural size.
 Fig. 2. *Trimerodytes balteatus* Cope, about 2.5 nat. size.
 Fig. 3. *Anolis principalis brunneus* Cope, about 2.5 nat. size.

PLATE XI.

- Fig. 4. *Anolis moorei* Cope, about 2.5 nat. size.
 Fig. 5. *Anolis oligaspis* Cope, about 2.5 nat. size.

PLATE XII.

- Fig. 6. *Anolis cinnamomeus* Cope, about 2.5 natural size.
Fig. 7. *Anolis flabellatus* Cope, about 2.5 nat. size.
Fig. 8. *Amiva leucomelas* Cope, about 2.5 nat. size.

LETTERING.

- a*, Head, from above; *b*, do. side; *c*, do. below; *d*, scales, from the side; *e*, median dorsal scales; *f*, anal region; *g*, hind leg and anal region; *h*, posterior foot from below.

DECEMBER 4.

The President, GENERAL ISAAC J. WISTAR, in the Chair.

Thirty-three persons present.

A paper entitled "The Sadsbury Steatite," by Theodore D. Rand, was presented for publication.

DECEMBER 11.

The President, GENERAL ISAAC J. WISTAR, in the Chair.

Thirty persons present.

The death of J. Bernard Brinton, M.D., a member, was announced.

DECEMBER 18.

The President, GENERAL ISAAC J. WISTAR, in the Chair.

Thirty-five persons present.

DECEMBER 25.

The President, GENERAL ISAAC J. WISTAR, in the Chair.

Thirty-three persons present.

The Publication Committee reported in favor of publishing a paper entitled "The Osteology of Hyænodon," by Wm. B. Scott, in the Journal of the Academy.

The following was adopted:—

REPORT OF THE COMMITTEE ON THE HAYDEN MEMORIAL
GEOLOGICAL AWARD.

The Committee appointed to recommend to the Academy a suitable recipient of the Hayden medal for this year begs leave to report that in examining the claims of the many savants from those countries which have not yet been represented by an award, the attention of your Committee was naturally arrested by Gabriel

Auguste Daubrée, of France, whom it has selected by unanimous vote for the honor.

Your Committee takes great pleasure in recommending that the Hayden Medal of this year be awarded by the Academy of Natural Sciences to Professeur Gabriel Auguste Daubrée, Membre de l'Institut et Grand Officier de la Légion d'Honneur.

Very respectfully,

J. P. LESLEY,

BENJ. SMITH LYMAN,

ANGELO HEILPRIN,

THEO. D. RAND,

PERSIFOR FRAZER,

Chairman.

GABRIEL AUGUSTE DAUBRÉE was born in Metz, June 25, 1814, and is therefore now in his eighty-first year. He graduated from the École Polytechnique in 1834 and immediately received a commission to assist in the geological exploration of Algeria. He was called to the chair of geology in Strasbourg in 1839 and was Dean of its Scientific Faculty in 1852. He was appointed Engineer-in-Chief in 1855. In 1861, upon the death of the distinguished Cordier, he was selected to replace him in the Museum of Natural History, and as Professor of Mineralogy in the École des Mines as well as in the Académie des Sciences in Paris.

He was Director of the École nationale des Mines for a number of years, and while filling this responsible office was invariably courteous and generous in allowing foreigners the privilege of using its collections and library, and in assisting them in all ways to attain what they sought.

His writings have been numerous, original, and important, and it is to his genius and patience that we owe much of our insight into the intricate causes of crystalline structure, and the creation of the branch of experimental geology.

In 1841 he published his "Amas des minerais d'étain," in which a new theory was announced of the origin of the puzzling distribution of tin in its ores. In 1846 he published researches in Norway, and a theory of the occurrence of gold in the Rhine valley.

At intervals he published a long series of memoirs of exceptional originality and interest, among which may be mentioned "Arsenic

in combustible minerals," "Volcanic rocks," "Sea water," "Thermal springs and metallic lodes," "Chemical composition of planetary bodies," and finally, the crown of his labors, "La géologie expérimentale," "Recherches expérimentales sur les forces qui ont du produire le métamorphisme" (1857-1860), and the classic work of recent years "Les eaux souterraines."

He has also published a valuable work "Expériences synthétiques relative aux météorites," and "Classification adoptée par le Musée de l'Histoire Naturelle de Paris."

The following were ordered to be printed:—

A NEW INSECTIVORE FROM THE WHITE RIVER BEDS.

BY W. B. SCOTT.

The American Tertiary formations have yielded a surprisingly scanty insectivorous fauna. Many names have, it is true, been proposed, but for the most part, these names have been given to such fragmentary and uncharacteristic specimens, that they remain mere *nomina nuda*. Only one family, the *Leptictidae*, is at all well understood, and the ancestors of even the peculiarly American recent types are still quite unknown.

During the past summer Mr. M. S. Farr, of the Chicago University Expedition to the White River bad lands of South Dakota, had the good fortune to discover an insectivorous type new to the American Tertiary fauna, and representing an undescribed genus. For the opportunity of studying and describing this very interesting specimen, I am indebted to the kindness of Professor Baur, to whom I desire to express my very sincere thanks.

The specimen consists of the facial region and mandible, with nearly complete dentition, of a small animal, which upon examination, proves to be a member of the family *Soricidae*, or shrews, though not altogether agreeing with the definition of that family as usually given. This is the first of the family to be found in any Tertiary horizon of North America.

The genus may be called *Protosorex* and is defined as follows: Maxillary dentition much as in *Sorex*, but with less reduced third molar and smaller internal cusps on last premolar. Mandible with four minute teeth between the molars and the large, procumbent incisors. In all other known *Soricidae* the number of such teeth is two, except in one species of *Myosorex*, which sometimes has three.

The species, *P. crassus*, sp. nov., is characterized by the rather short and broad face, vaulted palate, straight alveolar border, and by the relatively large size.

The type specimen is of an individual rather advanced in life, and all the facial sutures have disappeared. The upper surface of the fronto-nasal region is straighter, broader, and more flattened than in the recent species of *Sorex*. The zygomatic arches have already

completely disappeared, the suborbital portion of the maxillary terminating in a rounded surface. The infraorbital foramen is very large and occupies the usual position above $\underline{p1}$ and $\underline{m1}$. In advance of $\underline{p1}$ the muzzle is quite sharply constricted and narrowed. The palate is quite deeply vaulted and concave transversely; between the molars of the two sides it is broad, but narrows rapidly in front of them. No foramina or failures of ossification are visible in the palate. The posterior nares have a similar shape and position to those of *Sorex*, but differ in the raised and thickened front border. The anterior portion of the muzzle is slender and tubular and the narial opening is small and terminal. The horizontal ramus of the mandible is proportionately stout and bears a single conspicuous mental foramen beneath the first molar. Condyle and angle are missing.

In the upper jaw the crowns of the anterior teeth are broken away, leaving only the fangs. The first incisor was large and compressed like that of *Sorex*, but it is impossible to determine whether it had the basal cusp found in that genus. This is followed by four minute, single-fanged teeth, the homologies of which are doubtful. The last premolar is as large as, though much less complicated than a molar; it resembles the corresponding tooth of *Sorex*, but the internal cusp (deuterocone) is relatively less expanded and basin-shaped. The molars have the same construction as in *Sorex*; the last molar is much the smallest of the series, though less reduced than in the modern genus.

The large lower incisor has lost most of its crown, but it would appear to be less entirely procumbent than in *Sorex*. Behind this tooth come four minute and closely crowded teeth, with compressed, chisel-like crowns, of which the first and the fourth are slightly larger and more prominent than the others. As in the upper jaw, the molars are like those of *Sorex*.

Measurements.

Length of upper dental series, exclusive of 1st incisor	M.	0.009
“ “ molar series004
“ lower dental series, exclusive of incisor007
“ “ molar series005
Length of palate010
Breadth of palate at $\underline{m2}$004

Measurements—(continued).

Breadth of face at orbits	M. .008
“ “ p ³005
Depth of mandible at <u>m²</u>0025

Protosorex represents the most primitive type of *Soricidae* which has yet been discovered, as is shown by the large number of teeth which it has retained. It is, however, not the most ancient form of shrew known, the phosphorites of Quercy, which are as old or older than the White River beds, having yielded species of *Sorex* (*Amphisorex* Filhol). This points to a very high antiquity of the family.

PTERODRILUS, A REMARKABLE DISCODRILID.

BY J. PERCY MOORE.

Among a number of additional new species of Discodrilidæ, which have come into the writer's possession, are two which differ so remarkably from the known type of structure of these interesting parasites that an immediate description of their peculiarities seems desirable. A new genus, *Pterodrilus*, is proposed for them, characterized by the presence on certain of the post-cephalic somites of paired dorsal appendages, chiefly developed from the muscular layers of the body walls. The genus resembles American Discodrilids hitherto described in the presence of a second pair of vasæ deferentiæ in the VIth post-cephalic somite, in addition to the pair in the Vth somite, which alone is present in the European Branchiobdella. Both pairs open to the exterior in the VIth somite by the usual form of efferent apparatus. The dorsal and ventral cuticular jaws are similar to one another, and each is normally bi-laterally symmetrical, though not infrequent variations affecting this symmetry are notable. The external openings of the anterior pair of nephridia are united in a common muscular vesicle having an outlet on the dorsum of somite III.

In the two species at present known the spermatheca is a simple sac with glandular and muscular walls, opening on the ventral middle line of the Vth somite. The atrium shows the usual division into bursa, penis sheath, and glandular atrium, the vasa deferentia opening into the latter, which is short and stout. The ovaries are attached to the posterior face of the septum VI-VII, and the ovipores are situated between the major and minor annuli of somite VII.

As usual in the Discodrilidæ the nervous system consists of a doubly bi-lobulate supra-œsophageal ganglion, united by partly ganglionic circum-œsophageal connectives with the ventral nerve cord, which develops three pairs of deeply bilobed cephalic ganglia, eight pairs of double post-cephalic ganglia, and a posterior nerve mass composed of three fused pairs of double ganglia, making a total of eleven post-cephalic ganglia, corresponding to the eleven bi-annulate body somites.

The vascular system presents the usual supra-intestinal vessel with its anterior portion modified to form a heart, a supra-neural vessel, a peri-enteric blood sinus, four pairs of vascular arches in the head, one pair each in the 1st and VIIIth post-cephalic somites, and one pair uniting the longitudinal trunks posteriorly in the IXth and Xth somites. Two pairs of cephalic, and eight or ten of caudal, adhesive glands are present, as well as circum-oral and hypodermal mucous glands. An inconspicuous clitellum is developed on somites VI and VII. No salivary gland, such as is found in *Bdellodrilus illuminatus*, is present.

Regarding the function of the dorsal organs there is little to say. A priori one would expect them to be respiratory, but the apparent entire absence of bloodvessels, which are unrevealed after a careful study of sections, would tend to throw strong doubt upon such an interpretation. Irregular spaces are evident here and there between the muscle fibres, but these appear to be continuous with the intermuscular spaces which are developed between the circular and longitudinal muscle fibres of the body walls, and have not been traced into any communication with the body cavity. Until an opportunity is afforded of studying living examples in their proper habitat, and observing the uses to which these organs are put, no opinion can be vouchsafed.

The two species are of relatively minute size, and were at first regarded as larval stages of another Discodrilid, until sections revealed the presence of perfectly mature spermatozoa and ova, some of which latter were in the course of extrusion through the ovipores.

Pterodrilus allicornus sp. nov.

Pl. XIII, fig. 1, profile of entire animal, from a mounted specimen about half extended, showing also the course of the alimentary canal, the spermatheca, atrium, and vasa deferentia, the position of the ovary and ovipores of the right side, and the dorsal gland in the VIIIth somite. X 145.

Fig. 1*a*, one of the jaws. X 640.

Fig. 1*b*, transverse section through the anterior part of the VIIIth, post-cephalic somite, passing obliquely into the ventral part of the VIIth; the ovary is cut on one side, and the muscular septum on the other; the intestine and nerve cord are shown; *a*, intermuscular space. X 200.

Fig. 1c, a longitudinal section near the median line of the dorsal organ of somite VIII; *a*, intermuscular spaces. X 500.

Fig. 1d, section of a terminal portion of a dorsal appendage. X 640.

In this species, which is described from sections and specimens mounted entire, the body is terete throughout, or owing to the increase in thickness of the dorsal walls of the major annuli, appears somewhat compressed at these points. The somites VI, VII, and VIII are of about equal diameter, those anterior and posterior to them tapering respectively toward the head and caudal disk. Bi-annulation of the body somites is very marked. The head is rather slender, and consists of a circum-oral annulus divided into thick entire dorsal and ventral lips, and two similar post-oral rings. The caudal sucker is a muscular disk of simple form, and about the diameter of the 1st post-cephalic somite; its axis coincides with that of the body somites.

Dorsal organs are highly developed in this species on post-cephalic somites III, IV, V, and VIII. Somites VI and VII, and in less degree, II also, exhibit slight dorsal thickenings of the body musculature. On the dorsum of the major annulus of somite III the body walls rise into a high compressed transverse ridge or plate, which fades out on the sides of the somite, and is produced laterally into a conspicuous, forwardly projecting trilobed wing, the anterior division of which flares outward and extends far forward over somite II, usually ending in a slightly bifid expansion. The remaining lobes are simple conical tines, which project upward and slightly outward. The two wings flare so strongly that the distance between their apices is about $1\frac{1}{2}$ times the diameter of the somite. Their shape is very strongly suggestive of the antlers of a young moose, hence the name given to this species. The generic name was also suggested by this species, in which the dorsal organs have a wing-like aspect not seen in the other species.

The dorsal appendage of the VIIIth somite is also highly developed, and similar to the one just described. Its lateral wings, however, are less conspicuous, and are directed posteriorly instead of anteriorly, and also flare outward more conspicuously. The whole organ is strongly concave behind, while that on the IIIrd somite is similarly concave before. A small gland, closely resembling a clitellar gland, is sometimes present (in two out of three series of sections)

embedded in the base of the organ on each side. On the IVth and Vth somites the appendages are less highly developed, but are similar, the low dorsal ridges bearing on each side a pair of slender and simple cylindrical processes.

An examination of figures 1*b*, 1*c*, and 1*d* will make the structure of the characteristic dorsal appendages clear. The transverse dorsal ridges are built up chiefly of short, thick, longitudinal muscle fibres, which extend between the anterior and the posterior covering of hypodermis. Spaces partly filled with a connective tissue network are observable among the fibres, and a similar more extensive space (*a*, figs. 1*b*, 1*c*), separates the muscles of the dorsal organ from the longitudinal muscles of the body walls. A few vertical muscle fibres are also developed in the lateral margins of the ridges. Over this firm muscular basis the hypodermis, with the circular muscle layer, extends, and this alone, with a core of loose, spongy tissue, probably derived from the subdermal connective tissue, forms the terminal processes and lobes, (fig. 1*d*.) In the formation of these dorsal appendages, from the body walls, it would seem that the loose fold of hypodermis and circular muscle fibres that rises freely from the longitudinal muscle fibres is pinched up, as it were, at several points, from which the skin and connective tissue underlying it proliferate to form the marginal processes, while the space remaining becomes filled, save for a few narrow clefts, with muscle fibres that proliferate from the ends of the longitudinal muscle fibres of the body walls at the points where these meet the hypodermis.

The alimentary canal is enlarged to form a saccular stomach in the four anterior body somites, while posteriorly it is narrow and tubular, and, with the exception of a slight transverse loop in the VIIth and VIIIth somites, proceeds directly to the anus on the dorsum of somite X.

The jaws are small, measuring .02 mm. in breadth. They are of similar form, being quadridentate, with a median pair of long, sharply-conical, widely-separated, and divergent teeth, bent at a nearly right angle from the plane of the somewhat quadrangular basal plate. In extreme lateral positions are a pair of inconspicuous blunt teeth. When in position the basal plates are fixed in the cuticle of the pharynx, and the points of the teeth of the two jaws cross in the pharyngeal lumen.

The spermatheca lies in the Vth somite to the left of the intestine.

Its lower half is narrow and cylindrical, its upper abruptly expanded.

The copulatory bursa is rather thin walled, and with the penis is capable of complete invagination. The penis sheath is relatively short, and exhibits no muscular atrial enlargement at the upper end. The glandular atrium is short, nearly spherical, and thick walled. It receives the vasæ deferentiæ, which are of the usual form. In the mounted specimen, from which figure 1 was drawn, the atrium was twisted so that in the figure the anterior end is directed posteriorly.

The common opening of the anterior pair of nephridia is located on the dorsum of the major annulus of somite III, immediately posterior to the dorsal appendage.

The largest examples found among about a dozen specimens measure about 1 mm. in length.

This species was found on *Cambarus acuminatus*, in the Johns River, Watauga Co., N. C., in the summer of 1893; but what part of the crayfish it inhabits was not determined, nor have cocoons been found.

Pterodrilus distichus sp. nov.

Pl. XIII, fig. 2, profile of entire animal, showing intestine, spermatheca, atrium, ovary and ovipore of one side, etc. X 145.

Fig. 2*a*, a jaw. X 640.

Fig. 2*b*, transverse section through the VIIIth somite, showing the dorsal appendages, and the thickening of the body wall, with the intestine, nerve cord, and portion of a nephridium. X 145.

Fig. 2*c*, the male efferent apparatus, figured from a dissection; *a*, glandular atrium; *b*, copulatory bursa; *c*, penis sheath; *d*, bursal glands. X about 200.

Fig. 2*d*, section across the glandular atrium. X 500.

In form this species is similar to *P. alcicornus*, but the head is rather more robust, and the VIIth somite is of greater diameter than VI or VIII.

Dorsal appendages are present on post-cephalic somites II to VIII inclusive, and are much simpler than in *P. alcicornus*. The dorsal ridges are not compressed and plate-like, and are similar on all the somites. On somites II to VII each bears a pair of bluntly pointed cylindrical lateral appendages, while somite VIII bears two pairs; they become somewhat larger anteriorly.

These appendages contain no longitudinal muscle fibres, and the

ridges on which they rest are largely formed, as shown in fig. 2*b*, of a muscular network derived from the circular fibres.

In somites VII and VIII a complete transverse loop is developed on the intestine, which is otherwise as in *P. alcicornus*. The jaws are also very similar, but differ in the shorter median pair of teeth, and the stouter form of the basal plate. These distinctions are exaggerated in the figures owing to the fact that they are represented in slightly different positions, fig. 2*a* being somewhat foreshortened.

The spermatheca is slender and clavate, and regularly tapers from blind end to mouth. It lies to the left of the intestine. The copulatory bursa is nearly spherical, with thin muscular walls, and larger bursal glands than *P. alcicornus*. Its inner surface is thrown into deep ridges, among which the penis lies. The whole structure, when evaginated is shaped not unlike a mushroom, and resembles the corresponding parts of *Bdellodrilus philadelphicus*. The glandular atrium is remarkable in being divided by a deep cleft into two similar lobes, the structure being flattened in a plane perpendicular to this cleft, giving the organ a shape much resembling the conventionalized heart. The penis sheath is short, and lacks a sacular dilation.

The anterior nephridial pore is on the crest of the ridge of the IIIrd somite. In other respects this species resembles *P. alcicornus*.

The largest example (from which the dissection fig. 1*a* was made) from among upwards of fifty specimens measured 1.5 mm. in length, the usual size being about 1 mm.

Some small cocoons which may belong to this species were found attached to the setæ at the bases of the thoracic appendages of the crayfishes from which the specimens were obtained. Unfortunately the animals were not discovered while yet alive.

P. distichus was found in great numbers with *Bdellodrilus philadelphicus*, *B. manus* n. s., and *Branchiobdella instabilia* upon specimens of *Cambarus bartonii*, from western New York, for which I am indebted to the kindness of Mr. Albert E. Lewis.

THE SADBURY STEATITE.

BY THEODORE D. RAND.

Under this name I purpose describing outcrops of steatitic rocks most conspicuously exposed in West Sadsbury Township, Chester County, Pa., in the adjoining township of Sadsbury, Lancaster Co., and less so in Valley, West Caln and West Brandywine Townships, Chester Co. These, though known to archæologists, seem to have escaped the notice of geologists, though known locally and made use of in the building of lime-kilns, and in the lining of iron furnaces. Long anterior to this use, they were evidently of value to the aborigines, whose tools are still to be found at the outcrops, together with fragments of vessels manufactured by the Indians from the steatite.

My attention was directed to these exposures by Mr. Harry Wilson, of Gum Tree, Chester Co., who had visited the localities in the study of archæology, and who kindly took me to the most prominent outcrops.

North of the Cambrian sandstone, which forms the mass of the prominent North (Chester) Valley Hill, is a peculiar rock, often resembling a pegmatite, often a very feldspathic gneiss or schist, occasionally a hornblende or a mica schist. North of this is a very heavy bedded, hard, highly crystalline gneiss, that recognized in this portion of Pennsylvania as the most ancient gneiss, probably of Laurentian age, identical with that of the Highlands of New Jersey and with that of the ridge which extending southwestward from near Trenton, N. J., to near Willow Grove, and there bifurcating, sends its southerly arm southwestward through Montgomery, Delaware and Chester counties to North Brook, five miles southwest of West Chester, and its northerly through northern Chester County, where it widens greatly. It is this northerly arm which is referred to above. In all its extent the rock is very compact and hard unless decomposed, highly crystalline, rarely, if ever, schistose, except from decomposition, and usually showing the characteristic blue quartz.

On the contrary, the rock next north of the Cambrian sandstone is sometimes schistose, and while often gneissic, is not nearly so densely crystalline. The quartz is usually colorless or white. The rock varies greatly, though the quartz—orthoclase variety, of coarse texture, is most abundant. While, as a whole, differing from any other gneiss of southeastern Pennsylvania, it is more unlike the ancient gneiss than it is unlike those southeast of the Trenton—North Brook ridge, that is the gneisses of Rogers' first belt, Mr. Hall's Philadelphia and Manayunk schists and gneisses. To the last, as a whole, the resemblance is not close, but the rock of some strata in each bear a resemblance. It is the rock referred to by Dr. Frazer as "a rock of doubtful signification called alternately conglomerate, feldspar porphyry, etc." (C¹, p. 221.) Although Dr. Frazer in his text differentiates this rock,¹ on the map, it as well as the schists between the Cambrian and the limestone are colored the same as the ancient gneiss, though Dr. Frazer questions whether it is not really lower Cambrian.²

At Valley Forge and eastward there is in the same relation to the Cambrian sandstone a coarse conglomerate of pebbles chiefly of bluish and pinkish quartz, which has been referred with little doubt to the lower Cambrian. Could we be sure that this quartz feldspar rock represents the conglomerate, a point would be gained, but inasmuch as they are extremely unlike, although exposed within five or six miles of each other, I think we need proof of their identity. The best exposure is along the west branch of the Brandywine, north of Coatesville, where they dip quite irregularly, but with a prevailing southeast dip of 70° and upwards.

As this rock resembles closely no other southeast of the red sandstone, and occurs, so far as I am aware, only in Chester County and the adjoining county of Lancaster, I propose for it provisionally the name of the Chester County gneiss.

It is in this gneiss that most, if not all, of the outcrops of the Sadsbury steatite occur, and apparently in two lines somewhat irregular.

The easternmost outcrop of the northerly line is on the farm of Mr. Thomas H. Windle,³ on the left bank of the West Branch of

¹ Second Geol. Surv. Penna., vol. C¹, pp. 221, 225, 228, 257, 263.

² C¹, pp. 257, 258.

³ I am under obligations to Mr. Windle for aid in this investigation.

the Brandywine, in West Brandywine Township, about half a mile N. 55° E. of Wagontown. There are large, loose masses, some of them of a schistose variety of the gneiss, containing apparently hornblende and mica, and not soft, and others of similar appearance, but soft enough to be cut readily with a knife, a steatite. No fast rock was visible. To the north of it a hard, heavy bedded hornblende gneiss occurs. I was informed by Mr. Windle that considerable quantities of steatite have been obtained from this point, and used in the furnaces at Coatesville.

The next locality is a half mile or less N. 75° W. of Wagontown, or a little over three-fourths of a mile due west from the Windle outcrop. These measurements and orientations are estimated from the township map published by Breou, 1883, but a sighting of the localities on the ground by compass (magnetic variation allowed for) gave the direction N. 65° E., an inexplicable difference of 25° . This emphasizes the need of an accurate topographical map like that of the New Jersey survey.

This locality, on the farm of Abraham Brubaker, is immediately north of the Lancaster road which passes through Wagontown (not the Lancaster Pike, an approximatively parallel road a mile and a half to the southward). An area of several acres of ploughed land is strewn with numerous masses of steatite, mostly of small size, while occasional fragments of basins and pots, and more rarely picks made from trap rock give evidence that the red man had a workshop here. No rock certainly in place was seen in this field, but a resident informed me that forty years ago a quarry of soapstone was wrought at this place, out of which large blocks were taken for use in furnaces. With the steatite are small masses of schistose gneiss, also quartz, some of it containing tourmaline. In the steatite octahedral crystals of magnetite occur rarely.

On the westerly edge of this field is a ridge of loose sandstone rock only fifteen or twenty feet wide, looking as if hauled and dumped along a fence line, but the size of the slabs, and their similar orientation, showed that they had not been moved far, or by other than natural forces. A few hundred feet to the westward there appeared a high, steep ridge of Cambrian sandstone, precipitous on its southern side. The rock at Brubaker's is evidently the eastern termination of this ridge of sandstone, as it does not appear on the Brandywine in the line of strike. It apparently extends westward

to Compassville, being known further west as Sandy Hill.⁴ On the north side of this ridge the highly crystalline, hard, older gneiss appears, and in it, as usual, considerable trap, an outcrop of which appears about three-eighths of a mile north of the ridge, and about a half mile north of West Caln Meeting-house.

The next outcrop of the northern series is on the farm of William Paxson on the Philadelphia and Lancaster turnpike in West Sadsbury Township, near the northwest branch of the Octorara Creek. It is very insignificant and poorly exposed. On the Breou map it is five miles S. 70 W. from the Brubaker outcrop.

The easternmost outcrop of the southerly line is also poorly exposed and insignificant. It is in Valley Township on the farm of E. S. Umstead, one mile N. 70 W. from Coatesville and about a mile and a half nearly south of the Windle outcrop.⁵

The next is also in Valley Township. It is on the farm of William Hoofman, about a mile N. 45 E. of Pomeroy and two miles S. 65 W. from the first. There is a large amount of the rock here strewn in fragments over the surface. One mass only was apparently in place, striking N. 65 E., the dip uncertain. Here cubic crystals of probably limonite pseudomorph after pyrite were found. The steatite is in smaller masses, softer, and apparently more nearly approaching pure talc than at the other localities.

The third is the most extensive of these outcrops. It is in West Sadsbury Township, five miles S. 85 W. from the second, and a mile and a half N. 7 W. from Atglen. Here, on the Strasburg road, is the Swan Tavern. North of it the Chester County gneiss is exposed⁶ and beyond this, the steatite, a short distance south of the Swan Public School. The steatite, here accompanied by chlorite and a very compact rock of a dull bluish color, soft but very tough, is in great quantity but wholly in loose masses. On the road to Atglen, south of the schoolhouse, a white fine-grained, highly feldspathic gneiss dips N. 30 E. 60°; an anomalous dip if the rock is in place, as it appears

⁴ This prominent sandstone hill is not shown on the map in C⁴, though mentioned in the text on page 262 (Wagonville being evidently a typographical error for Wagontown) and on p. 20, where it is referred to as an eastern extension of Copper Mine Ridge, though on p. 161 it is included in the gneiss area.

⁵ This is in the area colored yellow on the map in C⁴, where this color (representing the sandstone or quartzite) is widened suddenly and greatly after an equally great narrowing northwest and north of Coatesville. If the typical Cambrian sandstone is indicated my observations would not agree with this widening, while if the Chester County gneiss is intended to be included they would not agree with the narrowing.

⁶ C⁴, p. 270.

to be. Very close to this are two depressions out of which soapstone is reported to have been quarried. Mr. Wilson informed me that basins of Indian manufacture were found here in comparative abundance.

At the school a public road runs nearly east. Along this, on both sides for a quarter of a mile, and then on the north side the steatitic and serpentine rocks abound, but none were seen certainly in place. With these was much gneissoid rock and rusty quartz, also in loose masses. A mile east of this a large mass of steatite is visible in the road, and I am informed that it occurs a half mile farther east on the Limestone road, the dividing line between the townships of Sadsbury and West Sadsbury.⁷

Between a quarter and a half mile north of the steatite the older gneiss is visible in a road running north between two branches of the Octorara.

The fourth and westernmost of the southerly outcrops is the one which has furnished probably the greatest variety and number of specimens of Indian handiwork, their quarries being still partially visible. It is situated on the farm of George Williams, in Sadsbury Township, Lancaster County, about one mile west of Christiana, and three miles S. 70 W. from the Swan outcrop. The only adjacent rock visible is a feldspathic gneiss of the Chester County variety. This is shown in numerous loose masses in a line nearly northeast from the steatite outcrop. The steatite is strewn in fragments, some of them quite large, over an area of several acres, and there are two places where quarries evidently existed but which have been used as dumping grounds for the adjacent rock. In these, I am informed, the rock in place was exposed.

The steatite from all these localities is much alike, generally schistose, quite soft, though impure and containing a large number of small cavities as if from the weathering out of a contained mineral. No crystalline form was observed in the cavities, they often contain ferric oxide. The particles of talc are usually comparatively large and irregular, making the rock, on a casual inspection, resemble a mica schist more than the talc schists of the Lafayette steatite. The color is usually dull gray, more rarely greenish. Except at the Swan outcrop it is not visibly accompanied by serpentine. At

⁷ West Sadsbury was set off from Sadsbury in 1878. The dividing line is the Limestone road, an old Indian trail and an important highway, which is the west line of the borough of Parkesburg.

Christiana it contains garnets, at Brubaker's magnetite, and at Hoofman's altered pyrite. At Hoofman's, in small quantity, is a cryptocrystalline variety, very soft, very pale green, nearly white in color, and resembling the talc schist of Lafayette. At the Swan outcrop chlorite in large folia occurs, also a rock apparently one of the hornblende family changing into steatite or chlorite.

At the Windle outcrop the masses of steatite so closely resemble the adjacent masses of schistose gneiss that one is in doubt until he tests for hardness, and there appears to be a gradation from the very hard to the very soft rock.

I have stated that these outcrops are in the Chester County gneiss, but to this the William Paxson outcrop may be an exception. There is an outcrop of the ancient gneiss to the southwest of it. The exposures do not suffice to indicate much more than its certain existence.

There is one other outcrop of steatite to which my attention was called by Mr. Windle, further north than any of those already mentioned and apparently isolated. It is on the farm of Samuel Holmes, and on the south branch of Birch Run, an affluent of the west branch of the Brandywine, in West Caln Township, Chester Co., and is in the course of the ancient gneiss, which ranges north of the sandstone, north of the Chester County gneiss, in West Caln. As usual the exposure is poor, consisting of but a few loose masses of steatite, with masses of schistose gneiss resembling it in appearance.

Perhaps the most striking feature at all these outcrops, considered in relation to those on the southerly side of the valley is the rarity of serpentine. At all other steatite outcrops in S. E. Pennsylvania of which I have knowledge serpentine rocks abound, and the steatite rocks are subordinate, except perhaps in the Lafayette steatite belt, but in it serpentine is abundant though the steatite predominates. In these outcrops north of the valley, however, serpentine is quite rare, being found at the Swan outcrop only. The resemblance of the steatite to the gneiss found with it is very similar to the occurrence at Chestnut Hill, north of Easton, Pa.,⁸ and my observations lead me to the conclusion that the genesis is the same in both instances, the alteration of a gneiss containing probably a large proportion of a magnesian mica, and this perhaps derived from the hornblende, as is certainly the case on the Schuylkill, above Girard Avenue Bridge, Fairmount Park, Philadelphia.

⁸ Proc. A. N. S. Phila., Mar. 25, 1890, p. 95.

The following annual reports were read and referred to the Publication Committee:—

REPORT OF THE RECORDING SECRETARY.

The interest in the meetings of the Academy has been well sustained during the past year, and the work of the Publication Committee, the report of which it is customary to include in that of the Recording Secretary, has been of more than the usual importance. The attendance at the meetings has averaged thirty-six. Verbal communications have been made by Messrs. Sharp, Ryder, Dixon, Libbey, Chapman, Cope, Willcox, Wistar, Pilsbry, Holman, Goldsmith, Rand, Mercer, Brinton, Allen, Heilprin, Woolman, A. E. Brown, Ball, Sangree, Eakins, Morsell, McCook, Wilson, Rhoads, Morris, Johnson, Rex, and McFarlane. Such of these communications as have been reported by their authors have been published in the Proceedings.

During the year 192 pages of the Proceedings for 1893 and 376 for 1894, illustrated by 13 plates have been published. The first and second numbers of the tenth volume of the Journal, composed of two elaborate memoirs by Clarence B. Moore on the sand mounds of Florida, and consisting of 246 pages and 33 plates, have also been issued and distributed. Material is now in the hands of the Publication Committee for the completion of the ninth volume, which has been delayed in consequence of the character of Mr. Moore's papers, and it is hoped that the last number will be distributed to subscribers and correspondents early in the spring. There will then remain in the hands of the Committee for the continuation of the tenth volume a memoir on the development of the brain in the Anthropoids, by the late Dr. Andrew J. Parker, and one on the crania of the Sand Mounds of Florida, by Dr. Harrison Allen, the latter to be elaborately illustrated through the liberality of Mr. Clarence B. Moore, to whom the Academy is also indebted for the fine plates accompanying his own communications.

The Manual of Conchology has been continued by the Conchological Section, 482 pages and 79 plates having been published in the two series of which the work consists, while 340 pages and 10 plates of the Entomological News and 344 pages and 8 plates of the Transactions of the American Entomological Society have been issued by the Entomological Section.

Forty-three papers have been presented for publication as follows: Samuel N. Rhoads 7, Edw. D. Cope 4, Wm. B. Scott 3, Thomas Meehan 2, H. A. Pilsbry 2, Witmer Stone 2, Clarence B. Moore 2, A. Ortmann 2, C. H. Merriam 2, T. D. A. Cockerell 2, W. H. Holmes 1, Henry C. Chapman 1, David Starr Jordan 1, H. F. Moore 1, Henry C. Mercer 1, E. Goldsmith 1, Arthur E. Brown 1, Thos. Eakins 1, Harrison Allen 1, G. C. Davis 1, F. C. Baker 1, C. W. Johnson 1, Wm. J. Fox 1, J. B. Ellis and B. M. Everhardt 1, and J. Percy Moore 1. Thirty-eight of these have been reported on favorably for the Proceedings and five for the Journal.

Twenty-nine members and one correspondent have been elected. The deaths of thirteen members and five correspondents have been announced. Nine resignations of membership have been presented and accepted.

Mr. Gavin W. Hart having resigned his position in the Council of the Academy, Dr. C. N. Peirce was elected to fill the vacancy April 3d.

The By-Laws were amended February 27th, by the addition of the following words to Article XIII, of Chapter 5: "Should any Section be dissolved, become extinct, or cease to exist for any cause whatever, all the property and effects of such Section shall be held by the Academy for its own use in such of its departments as it may deem most appropriate, preferring those nearest related to the objects of such Section, except such property or parts thereof as may be subject to conditions or limitations by deed, devise, bequest, or special agreement, in which case such property shall be disposed of in accordance with such condition, limitation, or agreement."

On the report of the Committee on the Hayden Geological Memorial Award the medal and accumulated interest on the fund have this year been voted to Prof. Gabriel Auguste Daubr e of the Institut de France.

By permission of the Academy meetings have been held on the premises during the year by the Geographical Club, the Botanical Club, the Delaware Valley Ornithological Club, Pennsylvania Society for the Prevention of Tuberculosis, Pennsylvania Forestry Association, Woods Holl Biological Association, and the United States Veterinary Medical Association.

During the absence of the Recording Secretary in Europe the duties of the office were acceptably performed by Mr. Wm. J. Fox. All of which is respectfully submitted.

EDW. J. NOLAN,
Recording Secretary.

REPORT OF THE CORRESPONDING SECRETARY.

The Corresponding Secretary respectfully reports that during the year commencing December 1st, 1893, he has received from eighty-two societies, museums, etc., one hundred and forty-six acknowledgments of the receipt of the publications of the Academy, and from fifty-four societies, editors, etc., sixty-three notices of the forwarding of their own publications to the Academy, together with fifteen applications to exchange publications for reports, etc., asking for missing numbers of the Academy's publications, and one to discontinue the exchange with the Academy. Thirty-eight letters on various subjects have been received and thirteen written. Fifteen circulars and invitations to the Academy to participate in congresses or meetings, have been received and answered.

During the year one correspondent has been elected and notified. The deaths of five correspondents have been reported. Six certificates have been sent to correspondents.

Seven hundred and fifty-six acknowledgments for gifts to the library and one hundred and twenty-eight for gifts to the museum have been forwarded. Respectfully submitted,

BENJ. SHARP,
Corresponding Secretary.

REPORT OF THE LIBRARIAN.

The additions to the library received during the past twelve months have shown a gratifying increase over the accessions of the year before. They number 4,866, consisting of 4,335 pamphlets and parts of periodicals, 475 volumes, 46 maps, and 10 photographs.

They were derived from the following sources:—

Societies,	2,010	W. W. Jefferis,	6
Editors,	998	Geological Survey of Penn-	
I. V. Williamson Fund, . .	671	sylvania,	6
General Appropriation, . . .	420	California State Mining Bu-	
Authors,	180	reau,	6
United States Dep. of In-		Dr. Benj. Sharp,	5
terior,	78	Secretary of State, India, .	5
Smithsonian Institution, .	56	H. A. Pilsbry,	5
Hon. D. W. Voorhees, . . .	51	United States Department	
United States Department of		of Labor,	4
Agriculture,	45	Kew Botanical Garden, . .	4
Geological Survey of Sweden,	33	J. A. Lintner,	3
Rev. L. T. Chamberlain, . .	20	Pennsylvania State Board of	
Pennsylvania State Library,	19	Health,	3
Wilson Fund,	19	Geological Survey of New	
United States Department of		Jersey,	2
State,	18	Geological Commission of	
Dr. Samuel G. Dixon, . . .	17	France,	2
United States Treasury De-		United States Coast and Ge-	
partment,	16	odetic Survey,	2
Chas. P. Perot,	15	Department of Geology, In-	
Minister of Public Works,		diana,	2
France,	12	Norwegian Government, . .	2
Tennessee State Board of		Charles E. Smith,	2
Health,	12	Department of Works, Mex-	
Colorado Scientific Society,	9	ico,	2
Superintendent of the Cen-		Costa Rica National Museum,	2
sus, India,	9	Geological Survey of Minne-	
Geological Survey of Italy,	9	sota,	2
E. L. Gilliams,	9	Illinois State Bureau of Labor	
Thomas Meehan,	9	Statistics,	2
University of Kiel,	8	Dr. John Eckfeldt,	2
United States War Depart-		Massachusetts Commission-	
ment,	8	ers of Inland Fisheries, .	1
Department of Mines, New		Maryland State Weather	
South Wales,	8	Service,	1
Dr. H. C. Chapman,	8	Geological Survey of Geor-	
Geological Survey of India,	6	gia,	1

Geological Survey of Alabama,	1	Iowa Geological Survey,	1
United States Fish Commission,	1	Mrs. H. Carvill Lewis,	1
United States Civil Service Commission,	1	Angelo Heilprin,	1
Department of Mines, Nova Scotia,	1	East Indian Government,	1
Upsal Observatory,	1	Venezuelan Government,	1
S. R. Roberts,	1	Norwegian Meteorological Institute,	1
Dr. Henry Skinner,	1	Illinois State Board of Agriculture,	1
Dr. M. V. Ball,	1	Dr. H. C. Wood,	1
Directors of City Trusts, Philadelphia,	1	American Humanitarian League,	1
Australian Museum,	1	Comité Météorologique International,	1
		John L. Peyton,	1

They were distributed to the several departments of the library as follows:—

Journals,	3,910	Ornithology,	18
Geology,	234	Agriculture,	15
Botany,	133	Physical Science,	14
Conchology,	113	Encyclopedias,	11
General Natural History,	58	Herpetology,	10
Anthropology,	54	Ichthyology,	9
Entomology,	43	Chemistry,	8
Mammalogy,	28	Helminthology,	7
Anatomy and Physiology,	27	Bibliography,	5
Mineralogy,	22	Geography,	1
Voyages and Travels,	19		

In addition to these, 127 works having no relation to science have been received and catalogued for future disposition by the Library Committee.

The increase in the number of accessions is due to replies received to 258 applications for deficiencies and 62 propositions for exchange of publications. The latter included letters written to all the scientific societies and journals not yet on the Academy's exchange list, the names of which could be ascertained. The results of the correspondence have been encouraging.

The binding has been confined almost entirely to the department of journals and periodicals, 403 volumes having been bound during the year, while 86 volumes are now in the hands of the workmen. Much still remains to be accomplished, although the good results of the last two years' comparatively liberal appropriations for binding are

evident. The volumes are always carefully collated in the Academy before being sent out of the building. The work was interrupted during the summer in consequence of the Librarian's absence in Europe. He took occasion to visit such libraries of scientific societies as could be reached in the cities visited, and is glad to be able to state that no library devoted purely to natural history seen by him was superior either in extent or in convenience of arrangement to that of the Academy.

Perhaps the most important bibliographical aid to the scientific student is the Royal Society Catalogue of Scientific Papers. The ten volumes now issued embrace an alphabetical arrangement of authors with the titles of their contributions from 1800 to 1883. It has long been felt that a catalogue of these papers arranged according to subject was a most important desideratum, but one which must necessarily be the work of co-operation among the scientific societies and bibliographers of the world. Attention was called to the desirability of such a compilation in the report of the Librarian of the Academy for 1889, and it is, therefore, now a cause of congratulation that the subject is under consideration by the Royal Society of London.

A circular having been received from the Society asking for co-operation and suggestion, a committee was appointed consisting of Messrs. Philip P. Calvert, Henry Pilsbry, Stewardson Brown, Benjamin Sharp and Theodore D. Rand, with the Librarian as Chairman, to which the document was referred. A report was adopted by the Academy to the effect:—

1. That a catalogue of scientific papers as proposed by the Royal Society is desirable and that international co-operation should be engaged in its preparation.

2. That in order to secure uniformity in all parts of such a catalogue, a central bureau, as suggested by the Committee of the Royal Society, appears to be necessary, rather than that separate portions of the catalogue should be prepared by various institutions, such central bureau to be under the direction of the Royal Society, from which the proposition emanates; all publications of societies and monographs to be sent to such central bureau; the expenses to be met by returns from the sale of copies of the catalogue.

3. That such a catalogue should be classified and should be issued at least once a year, each volume to be provided with an alphabetical index.

4. That the scope of such a classified catalogue should embrace the various yearly bibliographies of special sciences now issued.

5. That whenever translations or summaries are believed to be desirable, English should be made the basis of the catalogue.

The Academy is indebted to George Vaux, Mary M. Vaux, George Vaux, Jr., and Wm. S. Vaux, Jr., for a fine portrait in oil of the late Wm. S. Vaux, whose long connection with the Academy as Curator, Vice-President, and member of various executive committees for over forty years, together with his permanent association with the mineralogical and archaeological departments of the Museum, of which the Wm. S. Vaux Collections form an important part, renders this memorial of unusual interest.

Special acknowledgment is due to Mr. Wm. J. Fox for his efficient and faithful discharge of the duties of the office during the Librarian's absence. Means were again provided by friends of the Academy for the employment during the summer months of Signor Emanuele Fronani, much of whose time was devoted to the correspondence regarding deficiencies and exchanges.

All of which is respectfully submitted.

EDWARD J. NOLAN,

Librarian.

REPORT OF THE CURATORS.

The Curators report that the museum, so far as regards the preservation of the specimens, is in the satisfactory condition described in their last annual report, while important progress has been made during the year in the rearrangement, marking, and cataloguing of the collections.

It is also a satisfaction to report the completion of the new museum building and the transference of some of the collections to the new galleries.

It was deemed most desirable to devote the first floor of the new museum to the departments of Archaeology and Mineralogy, and in accordance with this plan the entire Vaux collection, numbering 33 cases, has been transferred under the direction of the Curators and Mr. W. W. Jefferis, the special curator of this collection. Mr. Jefferis has given many valuable minerals to this great collection during the year; and thanks to his untiring energy the entire cabinet

is now in systematic order. The arrangement of the specimens in the Vaux archaeological collection will also soon be completed.

Mr. Clarence B. Moore generously presented six handsome exhibition cases made under the direction of the Curators for the Moore collection of Indian pottery and mound relics from Florida, which have been placed in the new building next to the Vaux collection. Mr. Moore has personally superintended the transference and arrangement of his specimens, which now constitute probably the most valuable archaeological series from this region in existence.

The Academy has also purchased four additional cases like those in which the Moore collection is placed, and in these have been arranged the celebrated Poinsett collection of Mexican antiquities deposited by the American Philosophical Society, and the Haldeman Indian collection. In addition to these the cases of Eskimo implements and clothing have been removed to the new building, and numerous spears, shields, kyaks, and canoes have been placed in position on the walls and pillars. In a short time the remainder of the archaeological material will be removed to the new building. This floor will then be ready for exhibition.

The archaeological department of the museum, as finally arranged, will form one of the finest exhibits in the country, being only surpassed in value by those at Cambridge and Washington. Containing as it does many unique specimens, this department, which for lack of space has been so long neglected, will now be placed in good condition. The Academy's cabinet of minerals will be transferred as soon as suitable cases can be secured. It will be arranged contiguous to the Vaux collection of minerals.

In addition to the transference of these collections to the new building an important rearrangement has been effected in the old museum. Nine cases have been removed to the room over the Lecture Hall, which has been set apart to illustrate the natural history of Pennsylvania and New Jersey. The mammals of these States have been selected from the general collection and many new specimens have been especially prepared for it, while the Delaware Valley Ornithological Club's collection of birds, with nests and eggs mounted to show their life history, has been removed from the ornithological gallery and arranged here to much better advantage. A local collection of reptiles and mollusks has been presented by Messrs. Brown and Stone, while a series of the local lepidoptera is

being prepared for presentation by Dr. Henry Skinner, so that there will soon be an exhibit of the natural history of Pennsylvania and New Jersey much more complete than has heretofore been displayed, and which will constitute a representative State Museum.

Among other work accomplished during the year may be mentioned the rearrangement of the mammalian osteological collection, many of the disarticulated skeletons being placed in drawers where they are more available for study.

The large amount of unclassified palæontological material stored in drawers on the main floor has also been re-examined, roughly classified and labeled, thus greatly facilitating the final disposition of the material.

In cataloguing the museum, important progress has been made, especially in the department of birds, where 5,907 specimens have been carefully examined, identified and catalogued, the types and duplicates unnecessary for display being removed from the stands and placed in cabinets, those desirable for exhibition being remounted. In this work the Curators have followed the practice adopted in all other large museums, and endorsed by letters from the leading ornithologists of the world. A more detailed account of the work of the ornithological department will be found in the report of the Section.

The collection of reptiles and batrachians, numbering 3,939 jars, has also been carefully examined during the year, the jars numbered and a rough catalogue prepared. The entries, however, have not yet been copied into the regular catalogue pending a revision of the identifications.

In the mineralogical department, through the valuable assistance of Mr. J. E. Richardson, the entire collection of over 8,000 specimens has been permanently numbered with painted figures and a considerable portion catalogued. The importance of this work cannot be overestimated, as it will, when completed, preclude all possibility of loss of data by the misplacing of specimens.

The department of invertebrate palæontology has profited by the liberality of the Rev. Dr. L. T. Chamberlain, who has provided a handsome mahogany case for the display of the Isaac Lea collection, and has sent an expedition to the fossil-bearing beds of the Southern States. A rich collection, numbering over 500 species, has been secured, and is now being unpacked and classified. Dr. Chamber-

lain has also generously provided cases for the valuable slabs of fossil foot prints presented by Isaac Lea. During the year Dr. Chamberlain was appointed special conservator of the eocene fossils.

The remainder of the Pennsylvania State Geological Survey collection is also being unpacked and arranged so that all the material will soon be available for study.

During the latter part of last year Dr. Benj. Sharp, in conjunction with Prof. Wm. Libby, Jr., conducted an important expedition to the Hawaiian Islands. As he returned too late to prepare his collections for presentation in time for the last annual report, no mention of them was made at that time. During the past year these collections have been arranged in the museum where they form a valuable addition, comprising many archæological specimens of interest, as well as a fine series of volcanic rocks and lavas, and a series of dried plants.

The Academy's taxidermist, Mr. D. N. McCadden, besides spending much time during the year in remounting the birds, has prepared a large number of new specimens, mainly received in the flesh from the Zoological Society of Philadelphia. These have been mounted for the museum or converted into skins or skeletons as the circumstances warranted.

The accessions during the year have been of great importance. Besides the gifts already mentioned, the Martindale collection of lepidoptera, comprising approximately 16,000 specimens, was purchased by the Academy with the assistance of a number of generous contributors, and this, together with the Peale and other collections already in its possession, places the Academy in the front rank in this department.

Mr. Clarence B. Moore has continually added to his collection of Indian mound relics, and has had collectors at work in Ohio and Florida during the year. The Zoological Society of Philadelphia presented numerous valuable specimens of mammals and birds, while the Delaware Valley Ornithological Club has added numerous groups to the special collection of local birds and nests.

An important collection of post pliocene fossils has been obtained by Dr. S. G. Dixon and Mr. H. C. Mercer from a fissure in the limestone rocks at Port Kennedy, Pa., where they have made excavations and collected a large amount of valuable data. So far specimens of *Megalonyx*, *Mastodon*, *Tapir*, *Peccary*, *Deer*, etc., have

been obtained, full accounts of which will be published in the near future.

The museum during the year has furnished aid to many specialists who have been offered every facility within the power of the Curators, while the interest of the general public in the exhibits would appear to be greatly stimulated. This is largely due to the custom inaugurated during the past year, of placing new and attractive specimens in a prominent place on the main floor of the museum for some days before putting them in their final positions, as well as to many popular articles which have appeared in our daily papers.

Specimens have been loaned during the year to Mr. T. Wayland Vaughan, Dr. Wm. H. Dall, Austin C. Apgar, B. W. Evermann, Prof. Jas. Hall, Messrs. F. W. True, F. M. Chapman, C. W. Richmond, and Dr. Geo. Bauer.

The departments of botany and entomology have been under the care of the special conservators, Mr. John H. Redfield and Dr. Henry Skinner respectively, to whom the Curators are indebted for their valuable aid. Acknowledgment is also due to Mr. W. W. Jefferis, Curator of the Vaux Collections, and Messrs. Shultz, Boyer, and Woolman who have done valuable work in classifying and labeling the collection of diatoms.

The unusual progress thus recorded is largely owing to the earnestness and fidelity manifested by the assistants, Messrs. Witmer Stone and Samuel N. Rhoads, Mr. D. N. McCadden, taxidermist, and the Jessup Fund students, Messrs. J. E. Richardson, Howard Y. Pennell and Henry W. Fowler.

SAMUEL G. DIXON,
Curator-in-charge.

REPORT OF BIOLOGICAL AND MICROSCOPICAL SECTION.

During the year nine regular meetings of the Section have been held, at which communications were made and microscopic slides exhibited.

Among the communications of special interest were those of Dr. B. Sharp, on his expedition to Hawaii and on the fertilization of

plants; those of Dr. Geo. A. Rex, on bacteria in the Myxomycetes; of Mr. Amos P. Brown, on hairs on *Mentzelia*, and Mr. Boyer's description of a new form of diatom, named by him *Rhabdonema Woolmanii*.

At the joint meetings with the Academy the Section has always been represented by its members, and important communications have been made as follows: John A. Ryder, preparation of nervous tissue, formation of brain convolutions; Geo. A. Rex, M. D., plasmodium of Myxomycetes, *Diachœa Thomasii*; Benjamin Sharp, Ph.D., curious growth on a tree-root from San Salvador, fertilization of plants in Hawaii; C. S. Boyer, on cyclosis; Lewis Woolman, remarks on diatoms; S. G. Dixon, M. D., protection from tuberculosis; D. S. Holman, remarks on Myxomycetes; S. Trenner, exhibition of centrifugal machine; M. V. Ball, M. D., remarks on tetanus and the antitoxin, crystals formed by bacteria, skulls of criminals.

The donations to the collection have been few: One slide of barking sand, by Dr. Rex, and ten slides of histologic subjects by Mr. Leedom Sharp.

Five new names have been added to the list of members and contributors. One death has been announced, and two members have resigned, leaving the number of members and contributors sixty-four.

The average attendance at the regular meetings was eight.

The Treasurer's report shows a balance of \$239.39 in the treasury.

Dr. Geo. A. Rex, the Conservator of the Section, reports as follows:—

The property of the Section is in good condition. The microscopes and accessory apparatus are in working order and have been freely and frequently used at the stated meeting of the Section.

No addition has been made to the apparatus during the year. The slide collection is also in good order, but it is to be regretted that but few additions have been made since the last report.

Some inconvenience results from the crowded condition of our cabinet, especially in the space devoted to the large binoculars and the Leidy stands, but it is hoped that this will be remedied when space in the new building is available.

The following gentlemen were elected to fill the various offices for the ensuing year:—

<i>Director,</i>	Benjamin Sharp, M. D.
<i>Vice-Director,</i>	John C. Wilson.
<i>Treasurer,</i>	Chas. P. Perot.
<i>Corresponding Secretary,</i>	John G. Rothermel.
<i>Conservator,</i>	Geo. A. Rex, M. D.
<i>Recorder,</i>	M. V. Ball, M. D.

Respectfully submitted.

M. V. BALL,

Recorder.

REPORT OF THE CONCHOLOGICAL SECTION.

During the year 1894 specimens of mollusca have been received from 45 persons, and a large number of species new to the collection have been added to the museum, as well as a few new to science. As usual, a great many specimens illustrating geographic distribution and variation have increased the study series; and as the growth of this series, which is arranged in drawers under the exhibition cases, exceeds the growth of the exhibition series, we are again in urgent need of space for its proper disposal.

The principal accessions during the year have been several sendings from Dr. J. C. Cox of shells from Australia and Tasmania, a large series of marine shells of Japan which we have been allowed to select from the collection of Mr. Frederick Stearns, a series of Japanese land mollusks in alcohol, and a very valuable collection of shells from the Liukiu Is., also due to the liberality of Mr. Stearns. A considerable number of South Australian land shells and chitons we owe to Mr. W. T. Bednall. Finally, the Conservator, with the co-operation of Mr. C. W. Johnson, was enabled to collect very extensive series of the mollusks of the middle St. Johns River, Florida. Many thousand specimens were collected from numerous localities and the material amassed will prove of great importance in the study of the variable and ill-defined species of Floridian Unionidæ. An especial object of the journey was to procure certain peculiar local races of *Vivipara*; and a number of varieties new to science were found, including one of the most divergent forms of the genus yet

discovered in any country, which adds an entirely new phase to the series of variations known in the family Viviparidæ. The success of these researches is attributable to the excellent facilities placed at our disposal by Mr. Clarence B. Moore.

Accessions to our series of American shells have been received from Messrs. A. G. Wetherby, E. G. Vanatta, Morris Schiek, H. F. Stupakoff, H. E. Sargent, C. W. Johnson, O. A. Nylander, S. N. Rhoads, W. J. Raymond, and numerous others, whose names appear in the list of accessions to the museum. A collection of New Jersey shells has been made and presented by Messrs. Witmer Stone, S. and F. H. Brown. It is now arranged in the Pennsylvania and New Jersey department of the museum.

From Prof. H. W. Gwatkin, of Cambridge, England, we have received a large number of mounted radulæ of mollusks, in exchange for material for mounting.

Mr. H. Suter and Prof. F. W. Hutton, of New Zealand, and Mr. C. Hedley, of Sydney, New South Wales, have continued during the year to send us new and rare forms of antipodal mollusks. A series of Sandwich Island forms, collected by Dr. B. Sharp, has added several rare or new species.

Except in the proper placing of new material in the cases, and the determination of new and old material, but little work has been done in the museum during the year; this has been owing partly to the pressure of other work, but mainly to the fact that little can be done advantageously until more space is allotted to the Conchological department. It is believed that this will be accomplished during the coming year.

Respectfully submitted,

H. A. PILSBRY,

Conservator.

REPORT OF THE ENTOMOLOGICAL SECTION.

The regular monthly meetings have been held during the year, except in July and August. The average attendance of members at meetings has been ten persons. Interesting verbal communications on entomological subjects have been made by nearly all the members and associates. The publication known as the Entomological News and Proceedings of the Entomological Section of the Academy of Natural Sciences of Philadelphia, has been continued, and

volume five completed, with three hundred and forty pages and ten plates. One new member has been elected and one associate. At a meeting held Dec. 10, 1894, the following were elected to serve as officers for the coming year:—

<i>Director,</i>	Geo. H. Horn, M. D.
<i>Vice-Director,</i>	Chas. S. Welles.
<i>Recorder,</i>	Henry Skinner, M. D.
<i>Treasurer,</i>	Ezra T. Cresson.
<i>Conservator,</i>	Henry Skinner, M. D.
<i>Publ. Committee,</i>	{ James H. Ridings, Chas. W. Johnson.

HENRY SKINNER,

Recorder.

REPORT OF THE BOTANICAL SECTION.

The Botanical Section respectfully reports that it is in a prosperous condition, has held regular monthly meetings at which valuable communications have been presented and discussed, and that it is wholly free from debt.

The herbarium, owing to the assiduous labors of the Conservator, Mr. John H. Redfield, is in a highly prosperous condition, containing about 33,000 species of flowering plants and ferns, of which 452 new to the herbarium were added last year.

The herbarium is hampered by want of room, all of which is set forth in detail in the Conservator's annual statement, which is appended as part of this report.

The officers elected for the ensuing year are:—

<i>Director,</i>	Thomas Meehan.
<i>Vice-Director,</i>	Charles E. Smith.
<i>Recorder,</i>	Charles Schäffler M. D.
<i>Cor. Sec'y and Treasurer,</i>	Stewardson Brown
<i>Conservator,</i>	J. H. Redfield.

Respectfully submitted,

THOMAS MEEHAN,

Vice-Director.

The Conservator of the Botanical Section reports as follows:—
This is the nineteenth year since a change of the By-Laws of the

Academy placed the care of its herbarium with the Conservator chosen by the newly formed Botanical Section, instead of with a committee chosen by the Academy as formerly. Certainly the continued and rapid growth of the collection and the improvement of its condition during that period have not been excelled in any portion of the Academy's earlier history. Those who remember the narrow, dark, and cramped accommodations afforded the botanical collections in the old Broad Street building, and the unwieldy portfolios in which they were arranged, under the old Linnæan system, can now congratulate the working botanists upon the improvement in the accessibility and usefulness of the herbarium which resulted from the change of quarters and from more modern methods of arrangement. At the time of that removal, the estimates of the extent of the collection were vague and exaggerated. The careful and conservative enumeration which has since been made of the flowering plants and ferns, places the number of species at the present time at over 33,000. If we add to these the cryptogamic collections, which have not been so carefully enumerated, the total would probably approach 40,000 species. Nearly one-half of these have been received since we have been in the present quarters. But the number of new species received gives a very inadequate idea of the growth, a large part of which consists of additions of species previously represented, but now in fuller suites from new and wider localities, and in better condition.

The collections removed from the old building were all in loose sheets or species-covers, and had consequently suffered much in handling, from the brittleness of age; and many of the subsequent additions were necessarily placed in the same way. But soon after the removal it was determined that it was all-important that the whole should be properly and permanently affixed to sheets with collector's tickets securely preserved. The task was a great one, with the little help at command, but it has been steadily pursued during the time not required for the care of new accessions. The separate North American collection is all thus mounted, and about one-fourth of the larger general herbarium.

The number of plants received during the past year reaches 2,119 species, of which 204 belong to the lower cryptogams and 1,915 are phanerogams and ferns. Of the latter 489 are N. American species, 311 Tropical American, 191 European, 684 Asiatic, 150 African,

and 90 Australian and Polynesian. 452 of these are new to our collection, and 30 of them represent new genera.

It is hoped that the additional space soon to be at command of the Academy will enable the Curators to provide some means for the expansion of the botanical collections. When we took possession of the present cases, large room was left for growth, but nineteen years have crowded the shelves to the point of injury to the contents. If the present shelf room were doubled there would still be very moderate space for that future increase of the herbarium which may be reasonably expected.

The present cases, though so much in advance of previous accommodation do not afford adequate protection from dust, and should be fitted with dust-tight doors, and all new cases should be of the best dust-proof construction.

Respectfully submitted,

JOHN H. REDFIELD,

Conservator.

REPORT OF THE MINERALOGICAL AND GEOLOGICAL SECTION.

Meetings of the Section have been held regularly during the year except during the summer months. The attendance has not been large, but this has been due, in great part, to illness and absence from the city of several active members. There has been no lack of interest. The additions to the museum have been satisfactory.

It is hoped that in the new building space and cases may be provided for a display of the minerals and rocks of the vicinity of our city, for it is believed that the present small and poor local collection could easily be increased so as to be a most valuable and interesting feature of the museum.

The following officers have been elected for the ensuing year:—

<i>Director,</i>	Theodore D. Rand.
<i>Vice-Director,</i>	W. W. Jeffëris.
<i>Conservator,</i>	W. W. Jeffëris.
<i>Treasurer,</i>	John Ford.
<i>Corresponding Secretary,</i>	Chas. Schäffler, M.D.
<i>Recorder,</i>	Chas. Schäffler, M.D.

Respectfully submitted,

THEO. D. RAND, *Director.*

REPORT OF THE ORNITHOLOGICAL SECTION.

The Section is pleased to report that the Ornithological Department of the Museum is in excellent condition as regards the preservation of the specimens, and to note important progress in the work of renovating the collection on the plans outlined in a previous report.

The question having arisen as to the policy of remounting the type specimens and duplicates unnecessary for display, as has been the custom during the past two years, the Conservator consulted several of the leading ornithologists of the world and obtained their unqualified endorsement of the plans for the renovation of the collection recommended by the Section and adopted by the Curators.

In view of the endorsement of R. Bowdler Sharpe, Robert Ridgway, and other high authorities we feel fully justified in the course we have pursued and are convinced that the proper preservation of our collection of birds is absolutely dependent upon the continuance of the treatment that we have already outlined.

Owing to the miscellaneous duties of the Conservator in his position as Assistant to the Board of Curators, his work on the ornithological collection was mainly restricted to the summer months. At this time, also, the Academy's taxidermist, Mr. David N. McCadden, was enabled to devote his entire time to this department, and with the further valuable assistance of Messrs. Howard Y. Pennell and Henry W. Fowler, it was possible to make greater progress with the work of renovation than in any previous year.

In all 5,907 mounted specimens were examined, catalogued, and labelled, and then remounted or reduced to skins as the circumstances warranted. These included the Ciconiidae, Gruidae, Limicolae, Gallinae, Columbae, Dendrocolaptidae, Formicariidae, Paridae, Bucerotidae, and part of the Fringillidae. In addition specimens of the Corvidae, Paradisaeidae, Icteridae, and Tanageridae which had previously been catalogued were remounted for exhibition. Several temporary lists were also copied into the regular catalogue during the year aggregating 7,029 entries, while all the accessions have been labelled and placed in the proper places. The entire study series of American birds has been carefully examined and found to be in excellent condition.

The principal accessions during the year have been small collections from Lower California, California, and Florida, received in

exchange or by purchase, and also numerous specimens from the Zoological Society of Philadelphia, among which may be mentioned specimens of *Struthio molybdophanes* and *Dromius irroratus*.

The Delaware Valley Ornithological Club has added many attractive groups to the collection of Pennsylvania and New Jersey birds which is rapidly approaching completion.

At the annual meeting of the Section held December 17, 1894, the following officers were elected:—

<i>Director,</i>	Dr. Spencer Trotter.
<i>Vice-Director,</i>	Geo. S. Morris.
<i>Recorder,</i>	Stewardson Brown.
<i>Secretary,</i>	Chas. E. Ridenour.
<i>Treasurer and Conservator,</i>	Witmer Stone.

Respectfully submitted,

WITMER STONE,

- *Conservator.*

REPORT OF THE PROFESSOR OF INVERTEBRATE PALEONTOLOGY.

The Professor of Invertebrate Paleontology respectfully reports that, as heretofore, he has delivered his regular spring courses of lectures, twenty-five in number, the attendance at which has been larger than in any previous year. These lectures, embracing in great part the physiographic features of the region about Philadelphia, were supplemented by weekly field parties, and by two special summer class excursions: one to the region of the Shawangunk and Delaware Mountains, the other to the Bermuda Islands. On the first of these excursions the methods of topographical surveying were practically demonstrated in addition to the regular work in geology and paleontology. Two new fossil-bearing localities in the Trias were discovered in the course of the spring excursions.

The collections in the department of Invertebrate Paleontology have not been materially augmented during the year, nor has their condition been very greatly changed. Much has been done toward determining and redetermining unidentified or doubtful forms, and from many specimens hitherto unofficially labelled—*i. e.*, not

named by the author of the species in question—the labels have been removed. In a few cases, too, the authors' labels were found to be incorrect, or at least so doubtful as to necessitate the affixing of an interrogation mark to the identification. The general changes that had been made on the floor of the museum broke into the continuity of the arrangement that formerly existed, and necessitated a considerable reversal in the disposition of the series. An almost full readjustment has been made for the time being, but it cannot be said to meet the actual requirements of the collection. Very nearly double the case-room that the collection now occupies is needed for a proper display of, and to meet additions to, the American fossils alone, and the European collection, which is very disadvantageously stored away in drawers, would occupy about as much space as the American collection occupies at the present time. It is hoped that with the occupation of the Academy's new building the proper relief will be afforded this department.

The additions to the collection during the year are included in the list of accessions to the museum.

Respectfully submitted,

ANGELO HEILPRIN,

Prof. of Invertebrate Paleontology.

REPORT OF THE PROFESSOR OF ETHNOLOGY AND ARCHÆOLOGY.

I have to report that in the early months of the year I delivered a course of lectures on general archæology. They were six in number and were free to the public. The attendance was unusually large, and a general interest was manifested in the subject.

The collections in this department have been increased by valuable accessions, which will be specified in the reports of the Curators. The whole collection is now in process of rearrangement in a favorable location in the new building.

D. G. BRINTON, M.D.,

Professor of Ethnology and Archeology.

REPORT OF THE PROFESSOR OF LOWER INVERTEBRATA.

The Professor of Lower Invertebrata, respectfully reports that during the past year he has delivered lectures on the results of the Hawaiian Expedition.

The additions to the museum during the year have been neither numerous nor important.

Work has been carried on in the carcinological department in re-labelling and rearranging specimens. With the help of Dr. A. Ortmann, the Porcellanidæ have been correctly determined and re-labelled.

A course of lectures, ten in number, is planned to be delivered sometime during the spring on general zoology.

Respectfully submitted,

BENJ. SHARP,

Professor of Lower Invertebrata.

REPORT OF THE PROFESSOR OF HISTOLOGY AND MICROSCOPIC TECHNOLOGY.

The Professor of Histology and Microscopic Technology respectfully reports that he has conducted less than the usual work in the bacteriological laboratory than in past years, owing to the fact that the greater part of his time has been devoted to his duties as Executive Curator. Some satisfactory work, however, has been accomplished in bacteriological examinations of drinking waters in the State of Pennsylvania, and in continued investigations upon the various lines heretofore suggested for the prevention and cure of tuberculosis and other germ diseases.

Original investigations made during the winter on the relationship between Tuberculosis and Nitrogenous Metabolism have been communicated to the Academy and published in the *Therapeutic Gazette* for December 15, 1894.

Microscopic examinations have been made of the viscera of animals which have died at the Philadelphia Zoological Gardens.

The bacteriological laboratory has been freely used by members of the Academy who desired the privilege, while the society has not

been called upon directly or indirectly to defray the expenses incurred for equipment or maintenance.

Instruction has been given in the use of the microscope, but no work has been done in histology.

SAMUEL G. DIXON,

Prof. of Histology and Microscopic Technology.

REPORT OF THE CURATOR OF THE WM. S. VAUX COLLECTIONS.

The Curator of the Wm. S. Vaux Collections respectfully reports that the cabinets have been in good condition during the past year. They have, however, been inspected by but few persons, owing to the unfavorable situation of the rooms in which they were arranged. No additions have been made in the archaeological section since the donor's death. At the present time it is being removed into the new building where it will attract attention in connection with the collection of Mr. Clarence B. Moore and others belonging to the Academy.

Since the last report 158 specimens have been added to the collection of minerals, several being new species. Their removal into the new building has been completed without loss or injury to any of the specimens. The cabinet has been placed in good order. It has been arranged on the first floor of the new building where, in consequence of the abundance of light, it can be exhibited to advantage.

Respectfully submitted,

WM. W. JEFFERIS,

Curator.

The election of Officers, Councillors, and Members of the Finance Committee to serve during 1895, was held with the following result:—

<i>President,</i>	. . .	General Isaac J. Wistar.
<i>Vice-Presidents,</i>	. . .	Thomas Meehan. Rev. Henry C. McCook, D.D.
<i>Recording Secretary,</i>	. . .	Edward J. Nolan, M.D.
<i>Corresponding Secretary,</i>	. . .	Benjamin Sharp, M.D.
<i>Treasurer,</i>	. . .	George Vaux, Jr.
<i>Librarian,</i>	. . .	Edward J. Nolan, M.D.
<i>Curators,</i>	. . .	W. S. W. Ruschenberger, M.D. Henry C. Chapman, M.D. Samuel G. Dixon, M.D. Arthur Erwin Brown.
<i>Councillors to serve three years,</i>		Charles P. Perot. Dr. C. Newlin Peirce. Theodore D. Rand. George H. Horn, M.D.
<i>Finance Committee,</i>	. . .	Charles Morris. Charles E. Smith. Uselma C. Smith. William Sellers. Charles P. Perot.

ELECTIONS DURING 1894.

MEMBERS.

January 30.—William S. Vaux, Jr., Edward K. Tryon, Jr., Dr. Gustavo Niederlein, Milton J. Greenman, M.D., Frank J. Keely, J. Lewis Crew.

February 27.—Ruth Clement, M.D., W. Graham Tyler.

March 27.—Theodore N. Ely.

April 24.—A. B. Van der Wielen, Rev. Leander Trowbridge Chamberlain, D.D., Charles G. Macey, J. W. Parker.

May 29.—Theodore Presser, William J. Fox, Andrew J. Downs, M.D., George E. Kirkpatrick, Henry P. Dixon.

June 26.—Harris A. Slocum, M.D., Thomas S. Parvin, John N. Hussey.

October 30.—Horace Binder.

November 27.—J. Carroll McCaffrey, William L. Whitaker.

CORRESPONDENT.

June 26.—Anstruther Davidson, of Los Angeles, Cal.

ADDITIONS TO THE MUSEUM.

1894.

ARCHÆOLOGY, ETHNOLOGY, ETC.

- Rev. L. T. Chamberlain. Stone idol, Mexico.
 Dr. S. G. Dixon. Casts of Mexican vase and idol.
 Mrs. M. N. Frederick. Mortar and pestle, Argentine Republic.
 Clarence B. Moore. Two aboriginal American crania, New York.
 Dr. Geo. A. Rex. Stone axe, Philadelphia.
 S. N. Rhoads. Aboriginal knee ornament, Colorado.
 Dr. Benj. Sharp. A collection of Hawaiian implements, fifty-five specimens and two trays.

MAMMALS.

- A. E. Brown. Skin of *Ursus cinnamomeus*.
 Mrs. G. W. Carpenter. Teeth and jaw of *Physeter macrocephalus*.
 Dr. H. C. Chapman. Disarticulated skeleton of *Sus scrofa* L. Cast of brain of *Cynocephalus* sp.
 Prof. E. D. Cope. *Perognathus copei* (type), Texas. Skull of *Bison bison*. *Adelonycteris fuscus*, Missouri.
 Dr. S. G. Dixon. Skeleton of Eskimo dog (*Canis familiaris*).
 F. L. Garrison. Mounted Caribou head.
 Wm. Justice. Three skins *Erotomys*, Adirondacks.
 D. N. McCadden. One disarticulated skeleton *Tatusia novemeincta*.
 Peary Relief Expedition. Twenty mammal skulls.
 Zoological Society of Philadelphia. Mounted specimens of *Felis tigris*, *Bison bison* (juv.), *Macacus ochreatus*, *Capreolus capreolus*, *Erethizon dorsatus*, *Tapirus* sp., *Dasyproca acouchy*, *Felis cyra*.
 Skins of *Sciurus* sp. (Java), *Nandinia binotata*, *Felis caracal*, *Cercopithecus albogularis*, *Felis cyra*, *F. yagouaroundi*, *Galago garnettii*, *Midas rufimanus*.
 Skeletons of *Ursus cinnamomeus*, *Canis familiaris*, *Felis leo*, *Camelus dromedarius*, *Cervus porcinus*, *Felis tigris*, *F. cyra*, *F. yagouaroundi*, *F. caracal*, *Erethizon dorsatus*, and two others.
 Skulls of *Sciurus* sp., *Nandinia binotata*, *Felis cyra*, and two others.
 Alcoholic specimens of *Lemur varius* (viscera), *Felis concolor* (juv.), *Macacus* sp. (fœtus), *Galago garnettii*.
 H. A. Pilsbry. Two skulls and three alcoholic specimens, Florida.
 S. N. Rhoads. Four specimens *Condylura cristata*, Me. Two specimens *Blarina talpoides*, Haddonfield, N. J. One jar *Adelonycteris*

- fuscus*, Tarpon Springs, Fla. Twelve skins and skulls and two alcoholic specimens, Waynesburg, Greene Co., Pa.
- Dr. W. S. W. Ruschenberger. One skull of *Canis familiaris*.
- H. E. Sargent. Ten jars mammals.
- J. Schulze. One skull *Lutra hudsonica*, Monroe Co., Pa. One skeleton of *Lutra hudsonica*, Monroe Co., Pa.
- Wagner Institute, in exchange. Skins of *Bassariscus*, *Neotoma*, and *Aplodontia*, Oregon.
- Dr. W. L. Zuill. Skeleton of *Equus burchelli*.
- Purchased. Mounted specimens *Putorius erminea*, Bergen Co., N. J. *Erithizon dorsatus* and *Lutra hudsonica*, Potter Co., Pa. One hundred and twenty-two skins, California (collected by R. B. Herron).

BIRDS.

- Geo. B. Benners. *Dendroica chrysoparia*, Comal Co., Texas. *Ceryle torquata*, Laredo Co., Tex.
- Mrs. G. W. Carpenter. Skull of *Struthio camelus*.
- C. S. Hebard. *Anas cyanoptera*, Florida.
- Mrs. A. D. Hockley. Egg of *Struthio camelus*.
- J. S. and W. H. Jenks, and Mrs. R. W. Randolph. *Haliaetus leuccephalus*, *Grus mexicanus*.
- Zoological Society of Philadelphia. Mounted specimens of *Gracula intermedia*, *Casuaris australis*, *Dromaius irroratus*, *Struthio molybdophanes*.
- Skins of *Lorius domicella*, *Cygnus nigricollis*, *Plectolophus nasica*, *Chrysolophus amherstiae*, *Ortalia albiventris* (3), *Colinus cristatus*, *Phasianus torquatus*, *Conurus acuticaudatus*, *Eulabeia indica*, *Amblyrhampus holosericeus*, *Tadorna tadorna*, *Clophaga magellanica*, and two others.
- Skulls and sterna of *Anhinga anhinga*, *Milvus iclinus*, and five others. One skeleton.
- Delaware Valley Ornithological Club. Fifteen mounted specimens.
- S. N. Rhoads. *Dryobates borealis* (juv.), Florida. *Polioptila caerulea*, Waynesburg, Pa. *Podilymbus podiceps*, Pike Co., Pa.
- B. H. Vandecker, Jr. Forty-five skins from Guatemala.
- Purchased. *Aythya americana*, Flamingo. Seventy-eight California skins collected by R. B. Herron.
- By purchase and exchange. Forty-five skins from California, Florida, and Connecticut.

REPTILES AND BATRACHIANS.

- A. P., S., and F. H. Brown and W. Stone. Thirty-three jars reptiles and batrachians from Pennsylvania and New Jersey.
- E. D. Cope. Thirty-seven jars from Oklahoma, Texas, and Indiana.
- H. C. Chapman, M.D. Three skulls.

- Dr. S. G. Dixon. *Eumeces pentalineatus*, Md. Seven jars reptiles, Maine.
- J. Fannin. *Gerrhonotus garnettii*, Victoria, B. C.
- Dr. W. E. Hughes. Three jars, Canada.
- Howard Y. Pennell. One jar, Pa.
- Zoological Society of Philadelphia. *Hyla maxima*, *Iguana tuberculata*, *Testudo tabulata*, skin of *Megalobatrachus maximus*, and thirty-six jars, including a number of types.
- S. N. Rhoads. *Chrysemys picta*, N. J. Fifty-four jars, Penna.
- H. E. Sargent. One jar.
- Harold Sharp. *Anolis principalis*.
- Graham Spencer. Skin of *Crotalus adamanteus*.
- F. Stearns. Three mounted turtles, Liu Kiu Isl.
- Purchased. *Daboia russellii*, *Naja haje*, casts of *Megalobatrachus maximus*, *Iguana tuberculata*.

FISHES.

- J. R. Moore. *Salmo blakistoni*, Yezzo, Japan.
- D. N. McCadden. *Cottus viscosus*, Port Kennedy, Pa.
- L. Woolman. One jar, *Mustelus canis*.
- C. D. Clark. *Remora*, Bay Head, N. J.

CRUSTACEA.

- Mrs. I. C. Martindale. Two *Limulus polyphemus*.
- S. N. Rhoads. One jar *Cambarus*, Greene Co., Pa.

ECHINI, WORMS, CORALS, ETC.

- F. Stearns. *Gorgonia*, Liu Kiu Isl.

RECENT MOLLUSCA.

- Edwin A. Barber. One tray *Littorina irrorata* from Longport, N. J.
- W. T. Bednall. Forty-one trays of South Australian mollusks, including types of several Chitons.
- F. C. Blanes. Four trays and five bottles of mollusks from Cuba.
- S. and F. H. Brown and Witmer Stone. Ninety-six trays mollusks from Cape May, Pt. Pleasant, Atlantic City, etc., etc., in N. J.
- F. Burns. One tray *Anodonta fluviatilis* from Washington, D. C.
- Mrs. G. W. Carpenter. One tray of *Unio nicklinianus* Lea from Candalaria Lake, Mexico.
- G. H. Clapp. One tray of *Polygyra hirsuta* from Edgeworth, Pa., and one of *Eutota fasciola* from China.
- W. B. Clark. One tray *Latirus subrostrata* from Columbia.
- M. Cossmann, in exch. One tray *Planorbis Rollandi* from Algeria.

- Conchological Section. *Columbarium pagoda*, *Ischnochiton tigrinus* and types of *I. Elizabethensis*. (Purchased.)
- Dr. J. C. Cox. Seventy-two trays and six bottles of mollusca from Australia.
- W. W. Dall. Eight trays of mollusks from Bahamas.
- W. H. DeCamp. One tray of *Polygyra plagioglossa* from Mexico.
- Mrs. H. E. Dwight. Eight trays of West Indian mollusks.
- Dr. L. F. Flick. Pearl from *Ostræa virginica*.
- John Ford. Fourteen trays of mollusks.
- Jas. Green. Eight trays of mollusks from Vicksburg, Miss.
- Chas. Hedley. One tray of *Gundlachia petterdi* from S. Australia.
- Heilprin Expedition. *Bulla occidentalis* from Mexico.
- J. B. Henderson. One tray and eighteen bottles of land mollusks from Jamaica.
- Mrs. A. Hockley. One *Tridacna gigas*.
- Geo. C. Hubbard. *Pupa holzingeri* from St. Cloud, Minn.
- Dr. W. E. Hughes. *Polygyra dentifera* from Lac aux Sables, Prov. Q., Canada.
- Prof. F. W. Hutton. *Helcioniscus flavus*, *Patella kermadecensis*, and *Chiton canaliculatus* from New Zealand.
- J. E. Ives. *Littorina litorea* and *Purpura lapillus* from Gloucester, Mass.
- W. W. Jeffers. One tray *Unio complanatus* from Hudson River, N. Y.
- C. W. Johnson. One tray *Actæon punctostriatus* from Micco, Indian River, Fla. *Bulla adansoni* from Corsico, W. Africa.
- H. Lemon. *Aplysia* cast up at Cape May, N. J.
- Geo. Lichtenthaler coll. Two trays of marine mollusks.
- W. L. Lockington. One tray *Trachydermon raymondi*.
- Geo. T. Marston. *Valvata sincera* from Madison, Wis.
- J. R. Mead. *Anodonta bealei* and *Unio parvus* from Panther Creek, Kingman Co., Kas.
- Miss K. Musson. One tray *Polygyra thyroides*, Ashbourne Heights, Pa.
- C. J. Newcombe. Eleven trays of mollusks from Victoria, B. C.
- H. A. Pilsbry. *Helix fultoni* from Khasi Hills, India. *Chiton discolor* from New Caledonia. *Ancylus parallelus* from Lebanon Springs, N. Y., and *Polygyra multilincata* from Iowa City, Iowa. *Unio trapezoides* from Ark.
- H. A. Pilsbry and J. E. Ives. Four trays of mollusca from Pa., Ind., and W. Va.
- Purchased. *Argonauta argo*, Palm Beach, south of Lake Worth, Florida.
- W. J. Raymond. Three trays *Trachydermon raymondi* from California. Types.
- S. N. Rhoads. Twenty-eight trays and nine bottles of mollusca from Greene Co., Pa. *Vitrea arborea* from Sea Girt N. J.

- John Ritchie, Jr. Specimens of *Gibbula richardi*, *Monodonta lugubris*, and *Philomyces carolinensis*.
- E. W. Roper. Types of *Bulla roperia* and tray of *B. striata* from the Balearic Isles. Type of *Patella kermadecensis* from Kermadec Isls.
- H. E. Sargent. Seventeen trays of mollusks from Alabama.
- M. Schiek. One tray and one bottle of *Helix alauda* from Cuba.
- Ida M. Shepard. Collection of Californian shells in exchange.
- Dr. H. Skinner. *Littorina irrorata*; one tray from Anglesea, N. J.
- Dr. H. A. Slocum. Collection of mollusks from raised beach in Sweden.
- Fr. Stearns. Thirty-five trays of mollusks from Japan; one bottle of *Bulla gouldiana* from Coronado, Cal.
- L. H. Strang. *Nassa exilis* from Panama; *Goniobasis alabamensis* from Ala.
- S. Stupakoff. Six trays mollusks from Pa. and Ill.
- H. Suter. One tray *Gundlachia woodsi* from River Avon, and one bottle of *Plaxiphora terminalis* from N. Zealand; nine trays land shells from N. Zealand.
- E. G. Vanatta. Twenty-two trays of mollusks.
- H. A. Van Nostrand. Five trays of mollusks from Japan, presented through S. R. Roberts.
- Geo. W. Webster. *Strobilops hubbardi* from Lake Helen, Fla.
- A. G. Wetherby. Numerous shells from North Carolina, Kentucky and Tennessee, including one of the original lot of *Polygyra wetherbyi* Bld.
- Louis Woolman. One tray *Unio complanatus* from Harrisonville, N. J.; *Chrysodomus stimpsoni* from Nantucket.
- G. W. Wright. *Odostomia lactea* from Auckland, New Zealand.

VERTEBRATE FOSSILS.

- E. D. Cope. Eleven species fossil vertebrata (7 types), Kansas, Oklahoma, and Dakota, Cope Expedition, 1893.
- H. C. Mercer. Earth and fossil bones from Hartman's Cave, Pa.

INVERTEBRATE FOSSILS.

- H. C. Borden. Fossils from Lenola, N. J.
- Dr. H. C. McCook. Three ammonites.
- Dr. H. A. Slocum. Three trays *Orthoceras*, Sweden.
- Lewis Woolman. Cretaceous fossils from Lenola, N. J.

PLANTS.

- Prof. Benjamin Sharp. Sixty-nine species of Hawaiian plants; also five photographic views of the same.

- Dr. J. Bernard Brinton. Sixty species of plants, collected on Merritt's Island, Florida, by A. A. Baldwin, in 1893.
- Alexander McElwee. *Zinnia grandiflora* and *Pinus edulis*, from New Mexico. *Cassia tora* and *Sesbania macrocarpa*, introduced near Lausdowne, Phila., and brought to notice by Prof. Macfarlane.
- Prof. José N. Rovirosa. Thirty-six species of ferns from Chiapas, Mexico.
- I. C. Hatch. *Cupressus macrocarpa*, from Monterey, Cal. (Monterey Cypress), *Araucaria excelsa*, and *Quercus suber* (Cork Oak), cultivated at Santa Cruz, Cal., also section of a young tree of the latter.
- Mrs. Ross Lewers. *Pyrola rotundifolia* var. *bracteata*, *Pyrola aphylla*, *Heuchera micrantha*, *Woodsia Oregana*, and *Pellaea Bridgesii*, from Reno Co., Nevada.
- Dr. Charles Schaeffer. Hough's Sections of N. American woods, Parts IV and V.
- William Trimble (through Dr. Schaeffer). Specimens of double walnuts, from Concordville, Pa.
- Joseph Walton. *Chimonanthus fragrans*, both in flower and in leaf: a native of Japan, cultivated near Philadelphia.
- Prof. F. L. Scribner. *Hieracium Scribneri* and *Carex Austro-Carolinensis*, from Tennessee.
- Prof. C. S. Sargent. Photographic copy of a likeness of Stephen Elliott, botanist.
- Baron Ferdinand von Müller (through Thos. Meehan). Twenty-two species of Australian plants.
- Herbarium of Harvard University. Six hundred and forty-nine species of plants collected by the Schlagelweit brothers in Thibet, and in the Himalayas, in 1856. Fifty-one species collected in Nyassaland, Africa, by J. Buchanan, in 1891. Fifteen species collected in Dominica, W. I., by Ramage, and thirty-six species collected by Beardslee and Koford, mostly in North Carolina.
- Mrs. Susanna M. Gaskell. Double flowers of *Anemone Hepatica*, from Swarthmore, Pa.
- J. B. Ellis. Thirty-first and thirty-second Centuries of North American Fungi, named and arranged by Ellis and Everhart.
- Frederick Stearns. *Polyporus* (species), from Loo Choo Islands.
- J. Dolores Salaverría (through Prof. Sharp). Curious abnormal growth of wood, from El Progres, San Salvador, Central America.
- Roberts Le Boutillier. *Alpinia nutans* and eight species of tropical orchids cultivated by him.
- F. V. Coville, of U. S. Department of Agriculture, Division of Botany. One hundred and thirty-seven species of plants collected by the Death Valley Expedition in 1891.
- J. A. Crabtree. *Viola rotundifolia*, from Wissahickon, Phila.
- Andrew Steinemann. Curious fastigiate and spiral stem of *Asparagus officinalis*.

- Mrs. Katharine Brandegee. Series of Californian *Ceanothi*, illustrative of her "Studies in Ceanothus," consisting of thirteen species and twenty-four varieties or forms, in all eighty-seven sheets.
- Mrs. Fanny E. Briggs. Seven species plants from State of Washington.
- Dr. Lawrence Turnbull. Branch of oak with remarkable glomerate clusters of galls.
- Benjamin H. Smith. Forty-seven species of plants collected by him in Colorado, New Mexico, and California.
- W. W. Jefferis. Fifteen species of plants collected by him near Fort Edward, N. Y., also seed vessel of *Nelumbium luteum*, cultivated at Saratoga Springs.
- W. Tell, Austin, Texas (through Thos. Meehan). *Ipomœa pandurata* and *Acalypha radicans*, from Austin, Texas.
- B. G. Onderdonk, Texas (through Thos. Meehan). *Antigonon cordatum*, native of Mexico, cultivated in Texas.
- Knut Bachlund. One hundred and ninety species of Scandinavian plants, collected by himself and others.
- Geo. E. Osterhout (through Thos. Meehan). Abnormal form (without spurs) of *Aquilegia cœrulea*, from Colorado.
- T. Chalkley Palmer. *Isoetes saccharata*, from Elk River, Maryland.
- Prof. Thos. C. Porter. Seventeen species of plants from eastern Pennsylvania.
- Thomas Meehan. Ninety-eight species of South African plants, collected by Schlechter. Thirty-three species of exotic plants, mostly from cultivation. Thirty-six species of North American plants.
- John H. Redfield. Two hundred and fifty species of plants collected by C. G. Pringle, in Jalisco, Mexico, in 1893. One hundred and nineteen species of North American plants from J. H. Sandberg's Botanical Exchange, Minneapolis.
- Edward L. Rand and John H. Redfield. Thirty-seven species of plants from Mount Desert, Maine, and neighboring islands, continuing a series representing the Flora of that region.

MINERALS AND ROCKS.

- C. C. Bartlett. Staurolite and Garnet, N. H.
- Mrs. G. W. Carpenter. Two hundred and ninety-four trays minerals.
- E. D. Cope. Calcite, Fort Supply, Oklahoma.
- Copper Queen Mining Co. Malachite, Azurite, Cuprite and Copper, Arizona.
- E. A. Groth. Dolomite, Pa. Orthoclase, Beryl, Phila.
- T. J. Lewis. Two specimens.
- Thos. Nelson. One specimen.
- Jas. W. Pearce. Orthoclase, Pa.

- Mrs. J. W. Queen. Basaltic column, Ireland.
T. D. Rand. Sixteen specimens.
J. E. Richardson. Enstatite, Bamle, Norway.
Dr. B. Sharp. Sixteen trays lava, one tray Chrysolite, Hawaii.
S. Tyson. Two trays.
Purchased for Vaux collection. Two hundred and eighteen trays.

MISCELLANEOUS.

- J. Beaumont. Nests and alcoholic specimens of termites.
Dr. Wm. Camac. Nests of termites.
Rev. H. C. McCook. Wood bored by carpenter ants.
W. W. Jefferis. Hornet's nest.
Miss M. E. Lyndall. Malformed egg of common fowl.
J. M. Whelen. Barometer.
Women's Silk Culture Association. Six jars silk and cocoons.

INDEX TO GENERA, ETC.

1894.

Abies	359	Anthrax	274, 275
Acanthephyridæ	397, 398, 411	Antirrhinum	58
Acanthochites	70, 74-84	Aphanolimnas	133, 149
Acanthochitidæ	74	Aphanthops	303
Acer 322, 341, 357, 358, 360, 363, 367, 371, 373		Aplectrum	356, 378
Acerates	381	Aplomerus	190
Achlys	364	Aplostoma	15
Acrotoxa	420	Aporus	298
Adelonycteris	157, 218, 396	Aposphæria	358
Æcaeta	419	Aquilegia	334
Ægopina	15	Arabis	352
Ægopsis	13	Aralia 339, 341, 355, 362, 365	
Ænolimnas	131	Aramidopsis	133, 134
Æsculus	166	Arctomys	218
Agenia	297	Arctostaphylos	328, 347, 359
Alces	218	Argyramœba	274
Alecthelia	132, 134	Aristelliger	440, 441
Alnus	323, 366	Arvicola 218, 226, 282, 283, 285-288, 391	
Alsophis	431, 441	Arvicolineæ	227
Alyson	303	Asclepias	364
Amaurornis	131	Ascochyta	364
Amblyteles	185	Asilidæ	273
Amethysa	280	Asimina	344, 361
Ametrida	181	Asinea	201
Amiva	199, 431, 436	Astatini	302, 305
Ammophila	299, 300	Astatus	305
Ammoplanus	301	Aster	345
Amnicola	12, 25	Atalapha	156, 396
Amnicolidæ	25	Atya 397, 399, 407-410, 414-416	
Ampbiardis	425	Atyaephyra 398, 399, 401, 413	
Amphiesma	425	Atyidæ 397, 399, 411, 414-416	
Ampulicini	299, 300	Atyinae	413
Anacrabro	307	Atyoida 398, 399, 406, 410, 411, 413	
Ancistromma	306	Auerswaldia	362
Anculosa	12, 26	Aulacomys	288
Ancylinæ	24	Baccha	276
Ancylus	24	Baccharis	379
Anemone	356	Baiomys	257
Anisia	278	Banchus	189
Anodonta	30	Barkea	347
Anolis 429, 431, 432, 433, 438-441		Bascanium	426
Anomalodon	427, 428	Bassus	190
Anomphala	15	Bathynomus	191
Anous	115-118	Bdello-drilus	450, 454
Anthostoma	344	Belonium	352
Anthostomella	338	Belvosia	278

Bembecinus	304	Causus	428
Bembex	301, 304	Ceanothus	353
Bembicine	298, 301	Cecidomyiidae	271, 419
Bembicini	302, 304	Cedrus	354
Bembidula	304	Celastrus	343, 380
Betula	165, 166, 346	Celestus	200
Bibionidae	271	Celtis	327, 332, 344, 360, 366, 386
Biensis	132, 134	Ceratophallus	426
Bifidaria	23	Cerceris	302
Bison	98, 218	Cercis	363
Blarina	218, 269, 396	Cercospora	378-381
Blepharipeza	277	Cercosporella	378, 379
Bombus	56	Ceria	277
Bombyliidae	274	Ceropales	292, 296
Bombylius	275	Ceropalini	296
Borreria	379	Cerotainia	274
Bos	68	Cervus	218, 389
Bothrodytes	426	Chaetodipus	266
Bothrops	427	Chaetomium	326
Botryodiplodia	363	Chaetopleura	70
Botryosphaeria	362	Chaetopsis	376
Botrytis	375	Chelonia	36
Bothynostethini	302, 305	Chironomidae	419
Bothynostethus	292, 301, 305	Chiton	69, 70, 75, 76, 85, 87
Brachycystis	293	Chitonidae	85
Bradypus	182	Chlorion	299
Branchiobdella	454	Chæronycteris	181
Brunella	337, 338, 355	Cholopus	182
Bryophyllum	164	Chondrioderma	290
Bufo	437	Choriplax	70
Bythinella	26	Chorostate	339
Cabalus	133, 139	Chrysopila	273
Cacocalyx	427	Chrysops	272
Cakile	59, 355	Chrysotoxum	276
Calicurgus	297	Chyphotes	293, 294
Callistochiton	70, 73	Ciboria	348
Callochiton	70, 71	Cladosporium	378
Calobata	279, 419	Clitellaria	272
Calosphaeria	342	Clypeosphaeria	329
Calotes	428	Cnemidophorus	198-200
Camarosporium	366	Cnicus	379
Cambarus	453	Coelodus	65
Campeloma	25	Coleocentrus	190
Campoplex	188	Colletotrichum	372
Canirallus	131, 132, 140	Coloptera	300
Canis	218, 393	Compsomyia	279
Capnodium	325	Condylura	396
Carex	375, 377	Coniophora	323
Cariaeus	218, 388	Coniosporium	377
Caridina 398, 399, 401-406, 410-416		Coniothyrium	362
Carpinus	342	Conus	98
Carya	325, 359, 363, 373	Corethrura	131, 132, 134
Cassandra	347, 370	Corethruropsis	133
Castanea	169, 357	Cornus	342
Castanolimnas	133, 142	Corticium	323
Castor	218, 390	Corylus	360, 361
Castoroides	218, 219	Coryneum	374
Catocha	271	Corynorhinus	182

Coturnicops	132, 133, 145	Diploplectron	305
Crabro	307	Diplosis	419
Crabroninæ	298, 307	Dipsas	427
Cratægus	348, 372	Dipus	182
Crecopsis	133, 145	Discodrilidæ	449
Cremastus	188	Discolia	295
Crepidotus	322	Discomycetes	347
Crex	131, 132, 142	Dolichopodidæ	275
Crossanthera	203	Dothichiza	370
Cryptoplacidæ	85	Dothidea	345, 359
Cryptoplax	70, 75, 85	Dothiella	359
Cryptus	187	Dracocephalum	58
Crystallus	15	Dromicus	428
Cteniscus	190	Drymobius	202, 426, 427
Cucullcea	65	Dryolimnas	131, 133, 140
Cucurbitaria	334	Dycotyles	98
Culex	271	Echinoecystis	366
Culicidæ	271	Echinomyia	278
Cuphocera	278	Echthrus	190
Cyathicula	349	Eclytus	189
Cyelophis	427	Edusa	13
Cyclopidius	182	Elachipalpus	278
Cydonia	374	Elachistodon	205
Cylindrosporium	372, 374	Elasmosaurus	64
Cynopithecus	182	Elephas	68, 181, 182
Cyphomyia	419	Elis	295
Cyrenidæ	29	Elymus	349
Cyrtocentrus	188	Embaphias	64
Cytispora	359, 360	Empidæ	275
Cytisoporella	359	Emys	36
Dacryomyces	324	Endodontidæ	17
Daldinia	345	Endoxyla	342
Dasypus	114	Entechinus	427
Dendrophidium	203	Entomognathus	307
Dermatea	354	Enullius	205, 206
Dermatella	352	Ephydridæ	281
Dexia	278	Ephyra	398, 400
Dexidæ	278	Ephyrinæ	398
Diachœa	289	Epipompilus	296, 297
Diaphanella	15	Epomidiopteron	295
Diaporthæ	338, 339	Equus	67, 218
Diatrype	343	Erax	274
Diatrypella	344	Erethizon	218, 393
Dicotyles	218, 219	Erigonum	381
Dietya	277	Erineum	376
Didelphys	388	Eristalis	276
Didineis	303	Erromenus	190
Didymella	335	Euatya	410
Didymium	290	Eucalyptus	381
Didymosphaeria	335	Eucyphidea	397, 411
Dielis	295	Eudermia	182
Dinetini	305	Euthyalina	15
Dinetus	305	Eulabeornis	131, 132, 135
Dinobastis	68	Eupleura	223, 224
Diodontus	301	Euryzona	131, 132, 140, 141
Diplodia	363	Eusapyga	296
Diplophallus	426	Eutænia	425
Diploplectrini	302, 305	Eutypella	341

Euxesta	280	Heterosporium	381, 382
Evatya	399	Heterozona	71
Evotomys	284, 391	Himantornis	131
Exetastes	189	Hippoboscidae	281, 420
Exogyra	64, 65	Hippobosca	281
Exolytus	186	Hippolyte	400
Exoprosopa	274	Hodomys	226-230, 232, 234
Exorista	278	Holarchus	423
Exyston	190	Homelys	399
Felis	393	Homo	218
Fiber	218, 391	Hoplismenus	185
Fragaria	357	Hyalina	15
Fraseria	373, 379	Hyalinia	15
Fraxinus. 326, 329, 331, 334, 358, 363		Hydatina	15
Fusicladium	378	Hydnum	323
Fusicocum	359	Hyla	195, 423
Gadidæ	47	Hylella	196
Galeocerdo	63	Hylodes	438
Gallinula	141	Hymenomyces	322
Garrya	385	Hymenula	386
Gastrodonta	16	Hyospila	338
Gastrophilus	277	Hyperalonia	274
Gaultheria	349	Hyphomyces	375
Geomys	159, 160	Hypoderma	347
Geranomyia	271	Hyponysson	304
Geron	275	Hypotenidia	131, 132, 136
Geum	354	Hypoxydon	345, 346
Gillia	25	Hysterium	346
Glesporium	370, 371	Hysteromyxa	369
Glyphyalinia	15	Ichneumon	185
Gonia	278	Ilex	167, 359
Goniobasis	27, 29	Illosporium	385
Gorytes	301, 303	Impatiens	54, 57
Gryphœa	64, 65	Ipomœa	362, 369
Gymnocrex	131, 133, 134	Iris	382
Habroptila	133, 134	Isariopsis	380
Haldea	425	Ischnoradsia	71
Halesia	339, 358, 361	Ischnochiton	70-73
Hanleya	75, 84	Ischnochitonidæ	71
Haploplax	71	Isodontia	299
Haplosporella	362	Isopyrum	380
Harpactopus	299	Juncus	348
Helaretos	182	Juniperus	363
Helianthus	336	Jurinia	277
Helicella	13, 15	Kalmia	323
Helicidæ	18	Kauaiite	105
Helicodes	13	Kittlizia	133
Helicoma	376	Labra	306
Helicops	428	Lacertilia	198
Helix	21, 98	Lachnella	348, 349
Helotiella	350, 351	Laetuca	368
Helotium	349	Lamium	57
Hemicaridina	401	Lamna	65
Hemiotomys	282	Lamproderma	290
Hemiteles	188	Laphria	274
Hendersonia	364, 365	Larra	301
Hermetia	271	Larrini	302, 305
Heteropelma	188	Larix	349

Lasiosphaeria	326	Macrosporium	382
Lathyrus	58	Magnolia	346, 349, 357
Lauxania	281	Margaritana	30, 98
Lemur	182	Marsonia	373
Lephritis	280	Masicera	278
Lepidopleurus	70	Mastodon	181, 182
Leptictidae	446	Mediterranea	15
Leptidae	273	Megacrex	133, 134
Leptocalamus	205	Megarrhiza	369
Leptocheila	93	Megastizus	304
Leptochiton	70	Megatherium	182
Leptodaetylus	196	Melanconium	373
Leptogaster	273	Melanomma	328
Leptognathus	424	Melliniini	302, 303
Leptophis	203	Mellinus	303
Leptosphaeria	336, 337	Melursus	182
Lepus	218, 270, 393	Meniscus	190
Leucochila	23	Menispermum	376
Levirana	197	Mephitis	218, 394
Lewinia	132, 134	Mesochorus	188
Limnæa	23	Mesogramma	276
Limnæinæ	23	Mesograpta	276
Limneria	188	Mesoleius	189
Limnobaenus	131, 133, 146	Mesoleptus	189
Limnobia	271, 419	Mesomphix	13, 14
Limnocorax	131, 132, 147	Mesostenus	187
Lindera	354	Methoca	294
Linospora	337	Metopia	278
Liocephalus	433, 436, 441	Meturolax	77
Liodytes	425, 428	Microbembex	304
Lioheterodon	427	Microcera	386
Liolophura	70, 87	Micropeza	280
Liopeltis	427	Micropezidae	279, 419
Liophallus	427	Microplax	69, 70
Liquidambar	358	Miersia	400
Liriodendron	330, 355, 365	Mimesa	300
Lithodytes	196, 438	Miscophini	302, 305
Loboplax	76	Miscophus	305
Lonicera	169, 171, 338	Mollisia	349
Lophidium	333	Monedula	301, 304
Lophiosphaeria	332	Mopaliidae	74
Lophiostoma	332	Moreletia	14
Lophyrus	70	Morus	328
Loricæa	70, 86	Mucronoporus	323
Loricella	86	Muletia	113
Lucilia	279	Mulio	276
Lucilla	15	Murex	223
Lupinus	355	Mus	159, 218, 221, 390
Lutra	155, 394	Musca	277, 279, 280, 419
Lutreola	394	Muscidae	279, 419
Lynx	218, 393	Mustela	394
Lyroda	305	Mutilla	293
Lyrodini	302, 305	Mutillidae	293
Macacus	182	Mutillini	293
Maclura	166	Mynomes	282
Macrepistius	65	Myosorex	446
Macrotodon	427	Myrica	335
Macrosargus	271	Myrmecophaga	182

Myrmosa	294	Oxybelinae	298, 306
Myrmosini	293, 294	Oxybelus	292, 306
Myzine	295	Oxycera	271
Myzini	295	Oxycheila	15
Myzinini	295	Oxychilus	15
Myxosporium	372	Oxydendrum	352
Natrix	425	Pachygaster	419
Nectomys	233	Palæmon	401, 413, 414
Nectria	325	Palmodes	299
Negundo	330, 343, 357, 360	Paranysson	304
Neithea	65	Parapompilus	296, 297
Nemotelus	272	Paratya	400
Neohelix	18	Pareas	424
Neolarra	292, 301	Passalæcus	301
Neolarrini	302, 304	Patella	203-212
Neotoma	213-221, 225, 233, 239, 242-250, 390	Patinella	354
Neotominae	228	Patulopsis	14
Neozonitinae	13	Pedicularis	349
Niteliopsis	305	Pelargonium	383
Notocyphini	296	Pemphredon	301
Notocyphus	296	Pemphredoninae	298, 300
Notogonia	306	Pemphredonini	300
Nycteribidae	281	Peniophora	323
Nycticebus	182	Pennula	131, 133, 147
Nycticejus	157	Pepsis	292, 296, 297
Nyctinomus	157	Perognathus	262-268
Nysson	301, 303	Peromyseus	390
Nyssonini	302, 303	Pestalozzia	374
Ochthera	281	Peziza	324
Ocydromus	131, 139	Phalaridion	132, 133
Ocyptera	277	Phaseolus	380
Ocypteridae	277	Phasiidae	277
Edipus	194	Pheneus	273
Eranthe	367	Philanthini	302
Enothera	380	Philanthus	303
Estridae	277	Philomycidae	22
Olfersia	281	Philomyces	22
Omphalina	13, 17	Philothamuus	203
Onithochiton	70, 88	Phleospora	369
Onychomys	256	Phleum	336
Ophibolus	428	Phlyctæna	369
Ophilia	278	Phœogenes	186
Ophiobolus	337	Phoma	357
Oplophorus	400	Phora	420
Ormia	279	Phoridae	420
Ornidia	276	Photinia	325
Ornithomyia	281	Photopsis	293
Ortalidae	280	Phrissopoda	279
Ortalis	280	Phygadeuon	186, 187
Orthocentrus	190	Phyllachora	345
Ortygometra	132, 133	Phyllosticta	354-358, 371
Oryzomys	160	Physa	24
Oseola	428	Physegenua	281
Osmorrhiza	369	Physidae	24
Ostrea	65	Physocarpus	335, 358, 361, 365
Otodus	63	Pilacre	386
Ovularia	375	Pinus	332
		Pison	306

Pisonopsis	306	Psilocephala	275
Placosphaeria	359	Psilopus	275
Planiceps	298	Psoralea	376
Planorbinae	24	Psychoda	419
Planorbis	12, 24	Psychodidae	419
Platanus	358, 372	Pterodrilus	449-454
Platylabus	185, 186	Pteroptila	277, 419
Platypalpus	275	Ptyssophorus	225-231
Plaxiphora	70, 74	Puccinia	385
Plecia	271	Pupa	23, 61
Plenoculus	305	Pupidae	23
Pleosphæria	332	Putorius	152, 218, 394
Pleospora	335	Pyrachmon	188
Plesia	295	Pyramidula	17
Plesiites	295	Pyrenochæte	359
Plesiomma	274	Pyrenomycetes	325
Plesiosaurus	65	Pyrenopeziza	352
Pleuroceridae	26	Pyrenophora	336
Plicatula	65	Pyrus	165
Podium	299	Quercus	220, 346, 353, 356
Podosporiella	385	Rallieula	131, 133, 148
Podosporium	385	Rallide	130
Pogonaspis	204	Rallina	131, 132, 134, 140
Polemistus	301	Rallinae	130
Polita	15	Rallites	132, 133
Polyblastus	189	Rallus	131, 132, 135-149
Polygonum	374	Ramularia	375, 376, 381
Polygyra	18-22	Rangifer	98, 218
Polymnia	368	Ranula	197
Polyporus	322	Raphanus	59
Pompididae	296	Reithrodontomys	161
Pompilini	296	Rhadinaea	428
Pompilus	296, 297	Rhexia	372
Populus	166, 333, 335, 370	Rhododendron	367
Poria	322, 323	Rhopalum	307
Porizon	188	Rhus	331, 348, 356, 374
Porzana	131, 132, 141, 143	Rhyssa	190
Porzanula	131, 133, 147	Ribes	340, 379
Potentilla	353	Robinia	58
Procyon	155, 218, 394	Rosellinia	326, 327, 338, 339
Propithecus	182	Rougetius	130, 131, 132, 139
Protohippus	66	Rumex	381
Protosorex	446, 448	Salientia	195
Prunus	344, 371	Salius	297
Psammocrex	133	Salix	326, 330, 334, 358
Psammodynastes	428	Salmo	60
Psammophila	300	Sambucus	336, 350, 358, 362, 382, 383
Psammophis	428	Sanguinaria	371
Psammotherma	293	Sapromyzidae	281
Psena	300	Sapyga	295
Psenini	300	Sapygide	295
Pseudagenia	297	Sarcodexia	278
Pseudaspis	427	Sarcophaga	278
Pseudohelotium	349	Sarcophagide	278
Pseudohyalina	16	Sarcophagula	279
Pseudohystricia	277	Sarcophilodes	279
Pseudotelphusinae	412	Sargus	271, 272
Pseudovalsa	343		

Sarothrura	131, 133, 134, 148	Stigmus	301
Sassafras	370	Stilpnus	186
Saxifraga	163, 164	Stizini	302, 304
Scalops	157, 218, 396	Stizus	301, 304
Sceliphron	299, 300	Storeria	425
Schizoptila	133, 134	Stratiomyidæ	271, 419
Schizoxylon	353	Strebla	281
Schloenbachia	65	Streptothrix	375
Seiomyzidæ	279	Strobilops	22
Sciuropterus	159, 389	Succinea	23
Sciurus	158, 218, 389	Succineidæ	23
Scleroderris	354	Symphoricarpos	338, 353
Scolia	295	Synaptomys	391
Scoliidæ	294	Syrphidæ	276, 419
Scoliini	294, 295	Syrphus	276
Scytale	206	Tabanidæ	272
Selenite	109	Tabanus	273
Selenites	12	Tachina	278
Selenitidæ	12	Tachinidæ	277
Senecio	377	Tachydromi	275
Senometopia	278	Tachysphex	306
Sepedon	279	Tachytes	306
Septoria	366-369	Tamias	218, 389
Sigmodon	160, 226	Tanais	90-93
Simotes	424	Tantilla	204
Sirococcus	358	Tapesia	350
Sitomys	159, 218, 221, 253-261	Tatusia	111-113, 182
Solanum	366	Tecoma	367
Solenopeziza	352	Teichospora	329-331, 334, 366
Sorex	394, 395, 447	Teichosporella	329
Soricidæ	446	Telphusidæ	412
Spazigaster	276	Telphusinæ	412
Spelerpes	195	Teonoma	242
Sphaerella	334	Tetanocera	279
Sphaeria	329, 344	Tetramerodon	282
Sphaerium	29	Thalessa	190
Sphaerodactylus	440	Thaliana	59
Sphaeronema	358	Therevidæ	275
Sphaeropeziza	353	Thersilochus	188
Sphaerophthalma	293, 294	Tilia	322, 359
Sphaeropsidæ	354	Tiphia	295
Sphaeropsis	361, 362, 383	Tiphiini	294, 295
Sphecius	301, 304	Tipulidæ	271, 419
Sphegidæ	298, 299	Tonicia	70
Spheginæ	298, 299	Torula	377
Sphegini	299	Trachycephalus	429, 441
Sphex	299	Trachypus	303
Spilomena	301	Trachyradsia	71
Sporodesmium	384	Trachytora	377
Spumaria	290	Tragomma	13
Stachylidium	377	Trautvetteria	368
Stagonospora	357, 365	Trematosphaeria	329
Statice	378	Tremellodon	323
Steatite	455	Tretomys	225, 231
Steniolia	304	Trichægum	385
Stenochiton	71	Trichobius	420
Sterna	115-118	Trichodaetylinæ	412
Stictis	352, 353	Tricholimnas	133, 135

Trichopoda	277	Valsaria	343
Trielis	295	Valvata	29
Trigonia	65	Valvatidæ	29
Trigonopsis	300	Vancouveria	375
Trillium	371, 382	Velocia	274
Trimerodytes	425, 426	Ventridens	16
Trimetopon	201	Venturia	325
Trinodontomys	257	Veratrum	364, 373
Triodopsis	20, 21	Verticillus	13
Triscolia	295	Vertigo	23
Troglocaris	398, 399, 401, 413	Vertigopsis	23
Trollius	334, 336	Vespa	56
Tropidoclonium	425	Vespertilio	157, 218, 396
Trypeta	280, 420	Vesperugo	157
Trypetidæ	280, 420	Viola	368
Tryphon	188, 189	Virginia	425
Trypoxylon	292, 306	Vitis	329, 343, 352
Trypoxylonini	302, 306	Vitrea	15
Tsuga	374, 386	Viviparidæ	25
Tubercularia	386	Volucella	276
Turritella	65	Vulpes	182, 218, 393
Tympanis	352	Willistonia	278
Ulmus	327, 332, 372	Wyethia	373
Ungualia	431, 432, 436	Xenomys	226, 234, 237
Unio	30, 98	Xiphocarinae	398, 411
Unionidæ	30	Xiphocaris	398-400, 413
Uranoplosus	65	Xiphocercus	438
Urocyon	218, 394	Xylocopa	56
Urodella	194	Zapornia	132, 133, 143
Urophora	280	Zapus	392, 421, 422
Ursus	119-128, 218, 394	Zonitidæ	12, 13
Vaccinium	325, 352	Zonites	13, 14
Valeriana	362	Zonitoides	16
Valsa	340, 341, 360, 363	Zonyalina	14

GENERAL INDEX.

1894.

- Additions to Museum, 485.
- Allen, Harrison, M.D. Crania from the mounds of the St. Johns River, Florida, 181. The changes which take place in the skull, coincident with shortening of the face-axis, 181. Hyperostosis on the inner side of the human lower jaw, 182. Observations on *Blarina brevicauda*, 269.
- Annual Election, 483.
- Annual Reports, 461.
- Baker, Frank C. Further notes on the embryonic whorls of the Muricidæ, 222, 223.
- Bail, M. V., M.D. Report of Microscopical and Biological Section, 471.
- Binder, George A., announcement of death of, 222.
- Biological and Microscopical Section, report of, 471.
- Botanical Section, report of, 475.
- Brinton, D. G., M.D. Report of Professor of Ethnology and Archaeology, 480.
- Brinton, J. Bernard, M.D., announcement of death of, 443.
- Brown, Arthur Erwin. On the true character and relationship of *Ursus cinnamomeus* Aud. & Bach., 110, 119.
- Chapman, Henry C., M.D. Homologies of the alisphenoid and petromastoid bones in vertebrates, 32.
- Cockerell, T. D. A. A supplementary note to Mr. Johnson's list of Jamaican diptera, 417, 419. Some new bees of the genus *Perdita*, 418.
- Committee on Hayden Memorial Geological Award, report of, 443.
- Committees, standing, for 1894, 9.
- Conchological Section, report of, 473.
- Cope, Edw. D. Observations on the geology of adjacent parts of Oklahoma and Northwest Texas, 61, 63. Third addition to a knowledge of the Batrachia and Reptilia of Costa Rica, 194, 207. On a collection of Batrachia and Reptilia from the Island of Hainan, 291, 423. The Batrachia and Reptilia of the University of Pennsylvania West Indian Expedition of 1890 and 1891 (Plates X, XI, XII), 417, 429.
- Correspondents elected, 484.
- Corresponding Secretary, report of, 463.
- Cresson, H. T., announcement of death of, 269.
- Curators, report of, 467.
- Davis, G. C. Some notes from a study of the Provancher Collection of Ichneumonidæ, 183, 184.
- Dixon, Samuel G., M.D. Report of Curators, 467. Report of Professor of Histology and Microscopic Technology, 481.
- Eakins, Thomas. The differential action in animal locomotion of certain muscles passing more than one joint, 150, 172.
- Elections of Members and Correspondents during 1894, 483.
- Ellis, J. B., and B. M. Everhart. New species of fungi from various localities, 289, 322.
- Entomological Section, report of, 474.
- Fischer, Paul, announcement of death of, 10.
- Fowke, Gerard, and W. K. Moore-

- head. Recent mound exploration in Ohio, 269, 308.
- Fox, William J. A proposed classification of the fossorial hymenoptera of North America, 289, 292.
- Gibson, J. Howard, announcement of death of, 110.
- Goldsmith, E. Some volcanic products from the Hawaiian Islands (Plate VI), 95, 105.
- Hayden Memorial Geological Award, report on, 443.
- Heilprin, Angelo. Report of Professor of Invertebrate Paleontology, 479.
- Holmes, Oliver Wendell, M.D., announcement of death of, 289.
- Hyrtl, Joseph, announcement of death of, 289.
- Index to Genera, 493.
- Jeanes, Joseph, announcement of death of, 417.
- Jeanes, Samuel, announcement of death of, 417.
- Jefferis, W. W. Report of Curator of the Wm. S. Vaux Collections, 482.
- Johnson, Charles W. List of the Diptera of Jamaica, with descriptions of new species, 269, 271.
- Jordan, David Starr. Description of a new subspecies of trout from McCloud River, California, 9, 60.
- Keating, Wm. V., M.D., announcement of death of, 110.
- Librarian, report of, 464.
- McIntyre, Archibald, announcement of death of, 417.
- McKean, Henry Pratt, announcement of death of, 10.
- Macfarlane, Dr. John. Movements of plants under plates of colored glass (no abstract), 417.
- Meehan, Thomas. Contributions to the life histories of plants, No. X: The origin of coreless apples; The relations between insects and the flowers of *Impatiens fulva*; Apetalism and seed propulsion in *Lamium purpureum*; Fruiting of *Robinia hispida*; Vitality of seeds; Apetalism in *Sisymbrium thaliana*, 10, 53. Contributions to the life histories of plants, No. XI: Morphology of bractless inflorescence; Purple-leaved plants; Origin of the apical cell; Fall of the leaf in the Holly; Bees and Honeysuckles, 150, 162. Report of Botanical Section, 475.
- Members elected, 483.
- Mercer, H. C. Re-exploration of Hartman's Cave in 1893, 62, 96.
- Merriam, C. Hart. A new Subfamily of Murine rodents—the Neotomine—with description of a new genus and species, and a synopsis of the known forms (Plate IX), 222, 225. Descriptions of eight new species of pocket mice (genus *Perognathus*), 222, 262.
- Mineralogical and Geological Section, report of, 477.
- Moore, Clarence B. Certain Sand Mounds of the St. Johns River, Florida, 181.
- Moore, H. F. *Tanais robustus*, a new species of Anisopoda (Plate V), 61, 90.
- Moore, J. Percy. *Pterodrillus*, a remarkable Discodrilid (Plate XIII), 418, 449.
- Museum, additions to, 485.
- Nolan, Edw. J. Report of Recording Secretary, 461. Report of Librarian, 464.
- Officers, Councilors, and Members of the Finance Committee for 1895, 483.
- Ornithological Section, report of, 478.
- Ortmann, Dr. A. On a new species of the Isopod genus *Bathynomus*, 181, 191. A study of the systematic and geographical distribution of the Decapod family *Atyidae* Kingsley, 289, 397.
- Peirce, C. Newlin, election to Council, 110.
- Peterson, Robert E., announcement of death of, 417.
- Pilsbry, H. A. Critical list of mollusks collected in the Potomac Valley (Plate I), 11. A new Central American Pupa, 61. List of Port Jackson Chitons collected by Dr. Cox, with a revision of Australian Acanthochoitidae (Plates II, III, IV),

- 61, 69. *Patella Kermadecensis* (Plates VII, VIII), 207, 208. Report of Conchological Section, 473.
- Potts, Joseph D., announcement of death of, 9.
- Professor of Ethnology and Archaeology, report of, 480.
- Professor of Histology and Microscopic Technology, 481.
- Professor of Invertebrate Paleontology, report of, 479.
- Professor of Lower Invertebrata, report of, 481.
- Rand, Theodore D. The Sadsbury Steatite, 443, 455. Report of Mineralogical and Geological Section, 477.
- Recording Secretary, report of, 461.
- Redfield, J. H. Report of Botanical Section, 475.
- Report of Botanical Section, 475.
- Report of Committee on Hayden Memorial Geological Award, 443.
- Report of Conchological Section, 473.
- Report of Corresponding Secretary, 463.
- Report of the Curator of the Wm. S. Vaux Collections, 482.
- Report of Curators, 467.
- Report of Entomological Section, 474.
- Report of Librarian, 464.
- Report of Biological and Microscopical Section, 471.
- Report of Mineralogical and Geological Section, 477.
- Report of Ornithological Section, 478.
- Report of Professor of Ethnology and Archaeology, 480.
- Report of Professor of Histology and Microscopic Technology, 481.
- Report of Professor of Invertebrate Paleontology, 479.
- Report of Professor of Lower Invertebrata, 481.
- Report of Recording Secretary, 461.
- Rex, Geo. A., M.D. *Diachœa Thomasii*, 289.
- Rhoads, Samuel N. Description of a new Armadillo with remarks on the genus *Muletia*, 95, 111. Contributions to the mammalogy of Florida, 150, 152. A contribution to the life history of the Allegheny Cave Rat, *Neotoma magister* Baird, 207, 213. Descriptions of four new species and two subspecies of white-footed mice from the United States and British Columbia, 222, 253. Descriptions of a new subgenus and new species of Arvicoline rodents from British Columbia and Washington, 269, 282. Notes on the mammals of Monroe and Pike Counties, Pennsylvania, 290, 387. A new jumping mouse from the Pacific Slope, 417, 421.
- Robb, Richard R., announcement of death of, 9.
- Scott, W. B. The structure and relationships of *Ancodus*, 417, 418. The osteology of *Hyænodon*, 417, 443. A new Insectivore from the White River Beds, 417, 446.
- Sharp, Benj., M.D. Report of Corresponding Secretary, 463. Report of Professor of Lower Invertebrata, 481.
- Skinner, Henry, M.D. Report of Entomological Section, 474.
- Smedley, Samuel L., announcement of death of, 207.
- Standing Committees for 1894, 9.
- Stone, Witmer. A revision of the genus *Anous*, 110, 115. A review of the Old World Rallinae, 110, 130. Report of Ornithological Section, 478.
- Szabo, Joseph, announcement of death of, 150.
- Van Beneden, P. J., announcement of death of, 10.
- Whelen, Edw. S., announcement of death of, 61.
- William S. Vaux Collections, report on, 482.

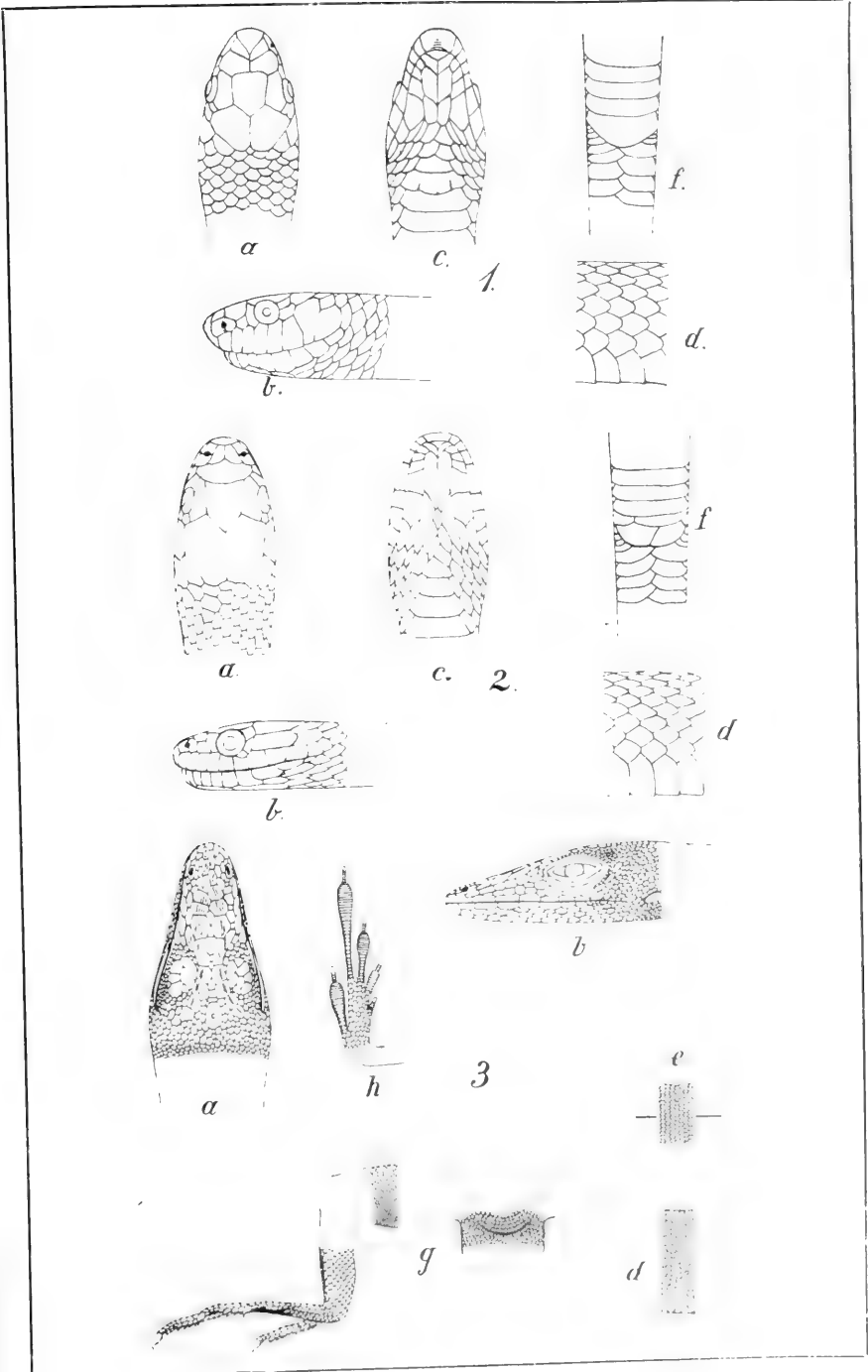

COPE, BATRACHIA AND REPTILIA.

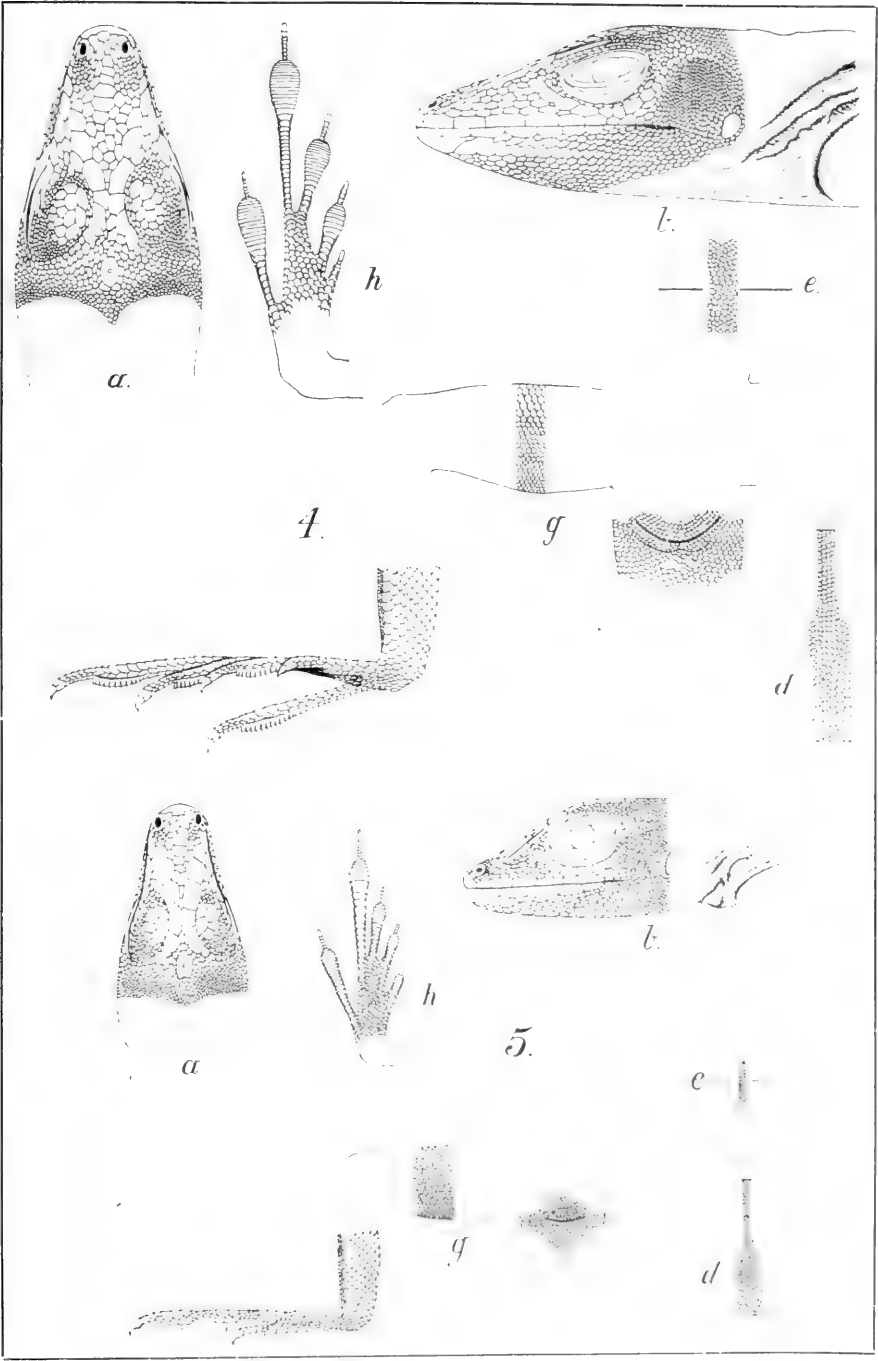

COPE, BATRACHIA AND REPTILIA.

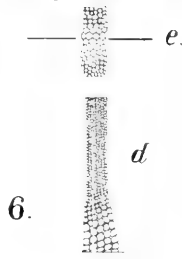
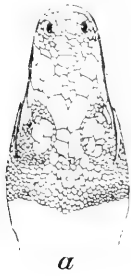

6.

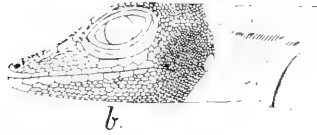
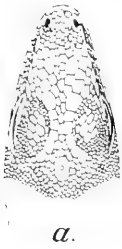

7.

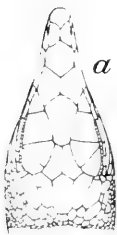

8.

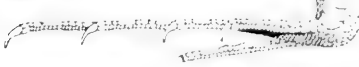

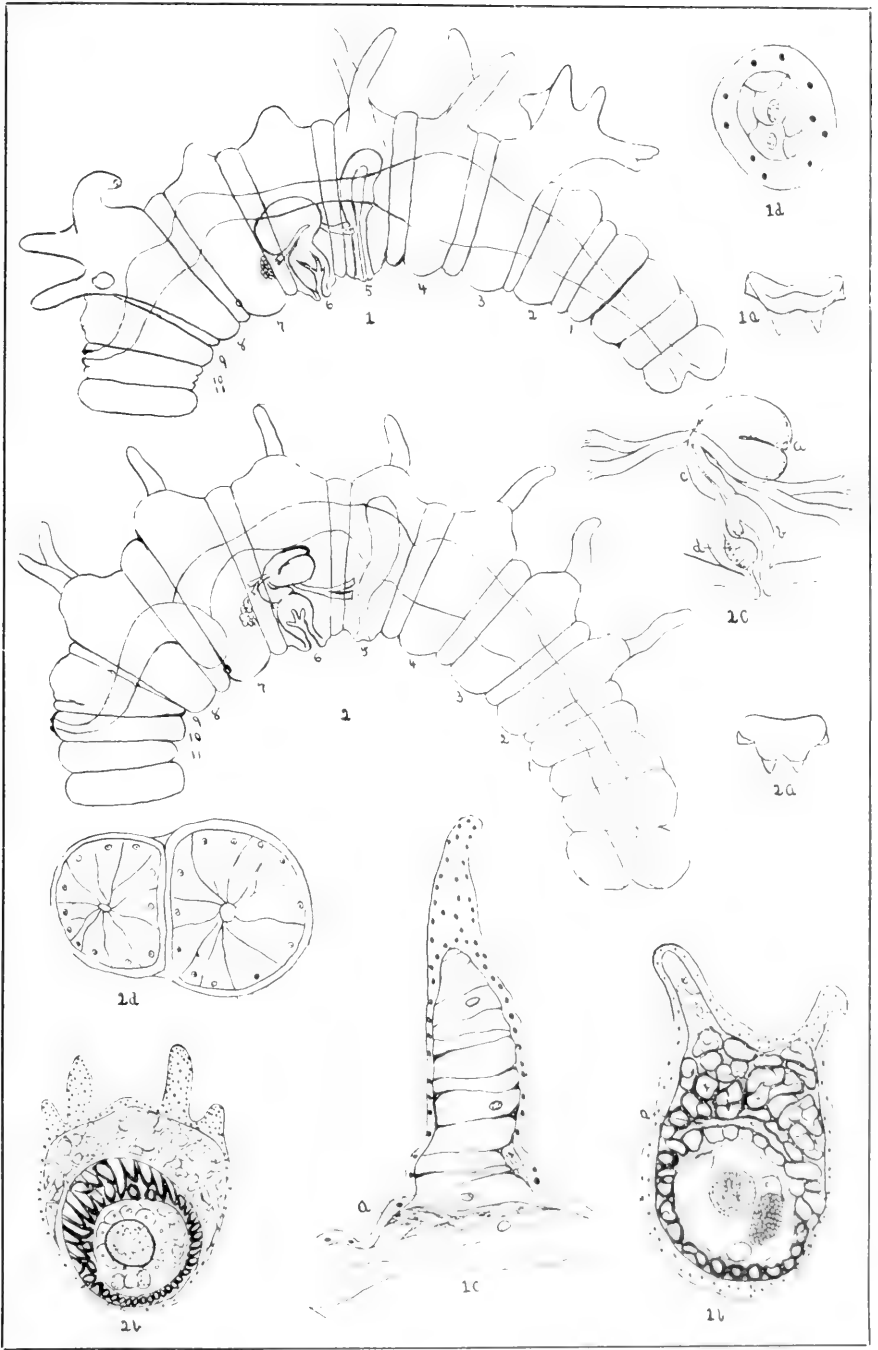

MOORE ON PTERODRILLUS.





QH
1
A2
v.46

Academy of Natural Sciences
of Philadelphia
Proceedings

Biological
& Medical
Serials

PLEASE DO NOT REMOVE
CARDS OR SLIPS FROM THIS POCKET

UNIVERSITY OF TORONTO LIBRARY

STORAGE

